

Behavior and Design of Flexibly-Connected Building Frames

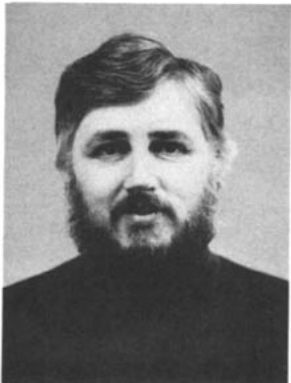

Kurt H. Gerstle



Michael H. Ackroyd

Author

Kurt H. Gerstle's first contact with steel construction was after high school graduation as template cutter and detailer for a San Francisco steel fabricator. Via the U.S. Army, the G. I. Bill, and the University of California at Berkeley (where he studied with Higgins award winner, Prof. Egor P. Popov) he became a structural engineer and eventually a faculty member at the University of Colorado in Boulder, teaching there for 36 years.

During the 1950's, Gerstle participated in early studies on plastic design, during which he worked with and learned from Ted Higgins, Chief Engineer of AISC. Since then, he has studied and taught in many areas of structural engineering. Earlier papers have won the Wason medal of the ACI in 1964, and the Moisseiff Medal of the ASCE in 1985 (with Michael H. Ackroyd). However, Gerstle regards the principal fruit of his labors as "the successful careers of many of my undergraduate and graduate students."

Author

Michael H. Ackroyd, Ph.D., P.E., has carried out extensive research in the behavior of flexibly-connected building frames while at the University of Colorado, Rensselaer Polytechnic Institute, and in consulting engineering practice. The focus of much of this work was on the use of interactive computer graphics for analysis and design of structural steel buildings.

He is currently president of First Principles Engineering, an engineering consulting firm that provides services for analysis and design of complex structural systems and for development of advanced software tools for engineering design.

Summary

The authors summarize what has been learned about the behavior of flexibly-connected building frames over fifteen years of research and development. The concepts and analysis/design procedures are explained in a simple fashion, demonstrating that the inclusion of realistic connection behavior is fully within reach of professional office practice. The designer is then able to achieve the improved safety and economy which is the justified reward of more realistic analysis.

BEHAVIOR AND DESIGN OF **FLEXIBLY-CONNECTED BUILDING FRAMES**

by

Kurt H. Gerstle

and

Michael H. Ackroyd

INTRODUCTION

Although the behavior of connections in steel construction extends over the full range from near-pinned to almost-rigid, traditional engineering practice has considered only the extreme limiting cases: either perfectly-pinned, as in ideal trusses, or fully-rigid, as in rigid-frame construction. The neglect of real connection behavior can lead to unrealistic predictions of the response and strength of steel structures, and less than optimal design in steel construction.

We wrote this paper in order to demonstrate that more realistic connection behavior can be included in analysis without undue pain, and that design of flexibly-connected steel frames is fully within reach of professional office practice. We have tried to explain the concepts and procedures in a simple fashion, and to demonstrate the benefits of a more realistic approach by means of several examples.

EFFECT OF CONNECTION FLEXIBILITY ON STRUCTURE BEHAVIOR

Connections which transmit moments M between adjacent members will undergo relative rotation, as shown in Fig. 1a. The relation between these two quantities is represented by the moment-rotation ($M - \theta$) curve, shown in Fig. 1b. The traditional extreme assumptions of ideal-pinned, or perfectly-rigid behavior are given by the straight lines along the θ -axis in the first, and along the M -axis in the latter case. In fact, any connection will have some intermediate stiffness between these extremes, as shown for several real connections in Fig. 1b. These $M - \theta$ relations are in general non-linear, with decreasing stiffness under increasing moment given by the slope k of the $M - \theta$ curve. We will consider this actual connection behavior later, but for the time being we will simplify the situation by assuming a linear $M - \theta$ curve, of representative constant rotational stiffness k . We will show later on that such an assumption can capture the structure behavior under service load with reasonable accuracy.

We will now consider the interplay between connection behavior and structure behavior by means of two examples:

1. Floor Framing under Gravity Loads;

Floor beams with double web angle connections or shear tabs to floor beams, shown in Fig. 2a, are usually analyzed and designed as simply supported. The design moment M_{max} , or the deflection Δ , will determine the beam size.

In fact, the web angle connections to the girders will have some rotational stiffness and therefore moment resistance which will serve both to diminish the design moment and the beam deflection, as shown in Fig. 2b. It will be worth exploring whether consideration of the actual connection stiffness will allow the use of lighter floor beams.

Lindsey and colleagues ⁽¹⁾ have followed just such an approach in the design of roof purlins, and realized a saving of 16 percent of material by relying on the available stiffness of the specified shear tab connections.

2. Multi-Story under Lateral Load: ⁽²⁾

Fig. 3a shows an unbraced four-story building frame under lateral loads. Analyses were carried out considering a range of beam- column connection stiffnesses ranging from near-pinned to near-rigid. The column moment diagrams of Figs. 3b to e indicate moment variations ranging from those of a cantilever beam to those which we generally associate with the shear-type deformations of rigid-jointed frames.

Similarly, the sways of the frames are also shown in these figures for different connection stiffnesses, and indicate the sensitivity of the deflections to the connection behavior. We observe in particular that the assumption of rigid joints may lead to gross underestimation of both column moments and story sways.

In fact, Figs. 2b to e show that the structure deflections seem to depend more on the connection than on the member behavior. In view of this observation it seems inconsistent to expend much loving care on member behavior, and treat the connections in rather cavalier fashion. No doubt we do this because we can express member behavior in terms of elegant and attractive theory, but connections are messy, uneducated, and do not lend themselves readily to analysis - as we will see shortly.

REQUIREMENTS FOR OFFICE PRACTICE

To implement flexibly-connected frame design in office practice, we need to consider these factors:

1. Code authorization,
2. Information about connection behavior,
3. Simple analysis procedures, and
4. Office-oriented design methods.

We will discuss these aspects in the following.

Code Authorization

Flexibly-connected frame design has been accepted by the AISC Allowable Stress (ASD) Specifications, Sec. 1.2, since many years under the label "Type 2" and "Type 3" Construction⁽³⁾. The former is an approximate method predating computer days. Based more on art than science, it has been widely used to design serviceable buildings, however, of unknown stiffness or strength. "Type 3" suggests, but does not explicitly require, a rational analysis which considers the effects of actual connection behavior. No specific guidelines are provided how this might be implemented, and we hope that our presentation might be useful toward this end.

In the 1986 LRFD Manual⁽⁴⁾, "Type PR", or "partially restrained", again authorizes flexibly-connected frame design, but without further instructions. Following either steel design procedures, it is clear that codes present no obstacle to a more realistic approach to steel frame design. Indeed, LRFD encourages the use of precise procedures, such as second-order inelastic analysis.

Connection Behavior

It is interesting to note that in spite of various attempts^(5,6,7) no reliable analytical method for the prediction of connection behavior has been accepted by the profession. It provides food for thought that in spite of all analytical progress of recent years, such a longstanding problem still escapes our understanding.

In the absence of analytical solutions, reliance must be placed on test results. Connection testing has been carried out only sporadically since the 1930s⁽⁸⁾. Complete, systematic test programs of specific connection types covering a full range of sizes and conditions are rare⁽⁶⁾. Two recent collections^(9,10) have attempted to gather all available test data on connections for use by engineers, however, in most cases this information is insufficient to cover the full range of connection types, sizes, kinds of fasteners, and member-connection interplay.

For the designer who needs connection data, Refs. 9 and 10, along with considerable imagination and daring, are probably the best resource. It was such imagination and daring which enabled Frye and Morris⁽⁵⁾ to develop empirical polynomial moment-rotation relations for a variety of connections in non-dimensional form, of the type shown in Fig. 1b, with a scaling factor to account for connection size. Although Ref. 10 shows that agreement between these curves and test results is not perfect, the Frye and Morris formulation has been widely used and can offer great help to the designer.

It has been observed that after loading of connections along the non-linear paths shown in Fig. 1b, subsequent unloading and moderate moment reversal will take place along a linear path of stiffness similar to that under initial loading. This may provide justification for the linearization which we will advocate for office use in our further discussion. Alternately, a secant modulus from the origin to the point representing the allowable connection moment under working loads might be used. Because of the variability of actual connection behavior due to fabricating and erection practice, extreme care in the choice of connection stiffness seems unjustified; a fair approximation is sufficient, as will be shown below.

ANALYSIS PROCEDURES FOR FLEXIBLY-CONNECTED FRAMES

Working Load Analysis

We suggest a linearly-elastic analysis to determine forces and deformations at service levels. Accordingly, the connections can be modeled as linearly-elastic rotational springs of stiffness k , attached to the prismatic beam as shown in Fig. 4a. For use in the displacement method frame analysis programs which are the mainstay of most offices, the standard (4 x 4) beam element stiffness matrix can be modified by classical methods of analysis to include the elastic springs. For springs of equal stiffness k at both ends, the stiffness matrix for the nodal numbering of Fig. 4a is shown in Fig. 4b.

Only the parameter EI/kL , defining the ratio of rotational beam to connection stiffness, is needed to include connection rotations. The only additional input data are the connection stiffnesses k . (For unequal connection stiffnesses, somewhat more complex matrices are derived in Ref. 11) Fixed-end moments for beams with elastic end connections can be derived similarly, and will also depend only on the modifying factor EI/kL ⁽¹¹⁾.

In any case, it is a simple matter to modify any rigid frame analysis computer program to analyze flexibly-connected frames as well, and we believe that such a program should be among the available tools of any well-equipped structural design office.

Strength Analysis

Linearly-elastic analysis cannot predict the strength of ductile structures. For this purpose, some form of non-linear analysis is needed. We consider that for office practice, the

simplest type of such an approach must serve; accordingly, we suggest the representation of connection behavior by a bi-linear, flat-topped, elastic-perfectly plastic $M-\theta$ curve, as shown in Fig. 7b. With this assumption, it follows that conditions under service loads can be predicted by elastic theory, as previously suggested, and structure strength can be computed by the plastic-hinge method, a well-established technique which has been often used for rigid-frame analysis⁽¹²⁾.

BEHAVIOR OF FLEXIBLY-CONNECTED FRAMES

To demonstrate the use and results of the suggested analysis procedures, we will offer several examples:

1. Range of Effective Connection Flexibility⁽¹³⁾

The flexibly-connected member stiffnesses in Fig. 4b show that they differ from those for a rigidly-connected member only by a factor EI/kL . A plot of the ratio of these stiffnesses as function of EI/kL (plotted logarithmically) is shown for the rotational beam stiffness k_{33} and k_{44} as well as for the fixed-end moment in Fig. 5. This ratio varies from unity for rigid connections to zero for very soft connections. For values of $EI/kL \leq .05$, this ratio will be within about 20 per cent of unity, and perfect rigidity can reasonably be assumed. For values of $EI/kL \geq 1.0$, the ratio will be within about 20 per cent of those for ideal pin-ends, so that this condition might well be assumed in analysis.

It follows that the effects of connection flexibility should be considered for cases in which $.05 \leq EI/kL \leq 1.0$. A review of typical building frames⁽¹³⁾ has indicated the ranges of EI/kL for fully-welded, and bolted, structures shown below the horizontal axis of Fig. 5. It seems that field-bolted, or lightly-welded frames should be analyzed as flexibly-connected, but frames with fully-welded joints might be assumed rigid with good accuracy.

2. Sway of Flexibly-Connected Frames

We carried out linearly-elastic analyses of a family of frames with various flexible connections ranging in height from five to 25 stories. The top-story sways from these analyses are plotted non-dimensionally in Fig. 6 versus the frame slenderness H/B . We considered three different connection types: floppy top-and seat angle connections, fairly stiff flange plates, and rigid joints representing fully-welded construction.

The curves of Fig. 6 indicate the importance of connection flexibility on frame sway: The contribution of the flexible connection types considered here varies from one third to two third of the total sway: elastic member deformations may be responsible for only a minor amount of the total deflections.

By drawing a horizontal line in Fig. 6 at the specified allowable sway ratio, the permissible frame slenderness can be estimated. It may well be that the widely-used sway ratio of 1/400 was adopted in full realization of the possible sway underestimation by rigid-frame analysis, and might be increased in recognition of the more realistic analysis.

3. Behavior and Strength according to Elastic-Plastic Analysis

In order to assess the effects of the elastic-plastic idealization suggested earlier, we considered a flexibly-connected girder under uniform load w , shown in Fig. 7a. Four different types of end connections, of moment-curvature relations shown in Fig. 7b, spanning a full range of possibilities, were considered. Two different analyses were carried out for each case: A fully non-linear analysis using the curves shown solid in Fig. 7b, and an elastic-perfectly plastic analysis using the bilinear moment-rotation curves shown dashed in Fig. 7b. Fig. 7c shows the resulting load-deflection curves, with the results of the nonlinear analysis solid, those of the bilinear analysis dashed. The limiting cases of perfectly simply supported, and perfectly fixed ends, are also shown dashed. We see that the bilinear analysis is capable of capturing the essence of the structure behavior. Other analyses⁽¹⁴⁾ confirm this conclusion.

OFFICE ORIENTED DESIGN METHODS

Over the course of the last fifteen years, we have looked into many approaches to designing building frames that use flexible beam-to-column connections. We were interested in evaluating existing design procedures with regard to safety, serviceability, and economy. We were also determined to come up with improved simpler approaches to frame design if possible. At this point in time, we recommend any of the following three different methods, depending upon the how "computer rich" your office is.

For the Computer Elite

If you use a minicomputer or super-microcomputer in your office, we heartily recommend that you consider using a matrix structural analysis program for providing a precise analysis of your frames. You can commit yourself to basically two levels of analysis/design sophistication: linear elastic analysis/allowable stress design or nonlinear analysis/limit state design.

1. Frame Design based on Nonlinear Analysis

In our many evaluation studies, we have developed programs that analyze flexibly-connected frames to minute details of behavior, right down to the yielding of individual fibers within cross sections if need be. This fundamental research enabled us to draw conclusions about the appropriateness of modelling assumptions of simpler analyses. For example, we have confidence in saying that, for building frames, overall frame strength

is relatively insensitive to variations in the values of connection stiffness: predictions of connection stiffness that are "off" by 50 % have little effect on the overall capacity of the frame. Accordingly, we can justify our approximation of nonlinear moment-rotation curves with the elastic-plastic models shown in Figure 7. Such a simplification makes it possible for design offices with reasonable "computer power" to development in-house analysis tools to predict the nonlinear frame response and proportion members using the LRFD Specification ⁽⁴⁾.

2. Frame Design based on Linear Analysis

Another conclusion that we have drawn from our many precise nonlinear analyses is that low- to mid-rise frames (below 10 stories) do exhibit stable "shakedown" behavior under alternating design wind loads. As a result, linear elastic analysis using the initial tangent stiffness of connections is justifiable for allowable stress design ⁽³⁾. To explore the ramifications of this conclusion, we developed an iterative analysis/design software package that automatically generates an initial design using familiar Type 2 assumptions, then computes the connection stiffness for the user-selected connection type, and analyzes the frame as flexibly-connected ⁽¹⁵⁾. We even added functions to automatically re-proportion those members that were underdesigned or understressed and to repeat the analysis until no changes in member sizes were needed. Figure 8 shows a sample set of results for a three bay, five story frame. As you see from this figure, with just a little more use of computer tools, you can reduce the weight of steel members by more than 8 percent as compared to a Type 2 design, or achieve essentially the same weight as a Type 1 design but gain the considerable savings of using "simple" (i.e., less costly) connections instead of moment-resisting connections.

For the Back of the Envelope

If your computer center consists of a pencil, a computation pad, and a calculator, don't despair. Our age-old friend, "Type 2" construction is not dead! Yes, for years it has been variously labeled as irrational, unsubstantiated, and paradoxical. While we all could envision the nonlinear loading/unloading of soft connections under various combinations of gravity loads and wind loads, we still needed reassurance that all this inelastic flexing is "self-limiting" and stable, that is, it does not lead to frame sway buckling or progressive collapse. (As a matter of record, it was just this question that originally motivated us to develop our nonlinear frame analysis programs.) Once we had our frame analysis tool in hand ⁽¹⁶⁾, we carried out extensive parametric studies of regular Type 2 building frames and came to the conclusion that Type 2 design assumptions lead to safe and stable building frames, so long as you restrict your building to less than 10 stories ⁽¹⁷⁾. As a side effect of our numerical testing, we accumulated a vast amount of sway data for wind loads on buildings using "standard" Type 2 wind connections, such as those shown in Fig. 6, and can recommend the following two drift prediction formulas for wind loads below 1 kip per foot of building height:

Top and Seat Angles:	$\Delta / H = W / (90 + 160 B / H)$
Flange Plates:	$\Delta / H = W / (130 + 160 B / H)$

where Δ is the lateral sway at the roof, H is the overall height of the building frame, B is the overall width of the building frame, and W is the lateral load intensity in kips per foot of vertical height. Designs based on these simple calculations will be conservative with regard to both strength and stiffness.

For Electronic Spreadsheets

After the first ten years or so of analyzing flexibly- connected building frames, we started to notice some trends in their response to gravity and wind loads. In particular, we were interested in determining what eventually would cause the collapse of a Type 2 frame. Computer graphic display of displaced shapes at ultimate load, such as that shown in Figure 9, eventually showed that their ultimate collapse was directly precipitated by the formation of a sequence of plastic hinges along the leeward column stack. Clearly, this column stack is the "weak link" in Type 2 frames, because we ignore any gravity moments at the exterior ends of exterior bay girders. As a consequence, when the wind moments are superposed on the hitherto-neglected gravity moments, that stack of columns reaches its limiting flexural resistance against frame sway and "pulls down" the rest of the building. More detailed study of the deformed shapes of Type 2 frames showed that a reasonable model for predicting the amount of moment that will be attracted to the exterior columns is that shown in Figure 10.

1. Approximating Moments in Flexibly-Connected Frames

By analyzing the substructure shown in Figure 10b, using the straightforward matrix techniques described earlier, we were able to develop closed form expressions for the moments generated at the ends of flexibly-connected girders, as shown in Figure 11⁽¹⁸⁾. Armed with these new computational tools, we replaced the normal Type 2 gravity analysis with our analysis for flexible end moments to arrive at a moment diagram for a frame wherein the gravity moments in the girders are reduced below those given by Type 2 assumptions, at the expense of increasing the moments in the exterior columns, as shown in Figure 12. Fortunately, though, re-proportioning the members for the re-distributed moments leads to an overall reduction in the weight of the frame, typically between 4 percent and 11 percent, as compared to the original Type 2 design. The design of the connections is identical to that used in Type 2 construction, so that these weight reductions represent true net savings.

2. Automating Frame Analysis in Spreadsheets

This modification of the Type 2 procedure can be carried out using hand calculations fairly easily. After designing a few frames using this procedure, however, you will quickly find that the process is more manageable if you organize the computations into tables.

After filling in a few tables with the computations, it will become obvious that the method is ideally suited for implementation in electronic spreadsheets⁽¹⁹⁾. The spreadsheet implementation that we have devised automates virtually all the analysis steps for obtaining the forces in all members of a flexibly-connected plane frame, so that rational design of Type 3 and Type PR frames is finally obtainable in any design office that has a personal computer.

3. Approximate Sway Computation via Spreadsheet

The last step that we have taken to bring flexibly-connected frame analysis to every engineer's personal computer has been to provide a spreadsheet-based tool for predicting the drift due to wind. We have modeled a building frame as an equivalent vertical cantilever beam, whose shear and bending rigidity can vary with height, that is, with variations in column, beam, and connection sizes. The conversion of the actual frame to the properties of the equivalent beam follow classical work-equivalent approaches as suggested in Figure 13. We automated the computations of the properties of the equivalent beam by extending our spreadsheet for the modified Type 2 design procedure described above. Then we cast Newmark's method of numerical integration into spreadsheet form to automatically compute the lateral deflections of the equivalent beam, that is, the sway of the frame. The results from this method have been compared to the drifts given by exact analyses for a wide range of frames and were found to agree within 5 percent when comparing the sway at the roof level.

Once we have implemented our analysis into a spreadsheet, we can take advantage of the graphing tools available in the spreadsheet software to obtain plots of the deflected shape of the frame, as well as a clear breakdown of the contributors to the sway of the building: column flexure, column axial, beam flexure, and connection flexibility. Such plots, as shown in Figure 14, are invaluable aids in helping a designer to decide where he can most effectively "beef up" a structure that he considers to suffer from excessive sway.

SUMMARY AND CONCLUSIONS

In this paper, we have tried to show that the behavior of flexibly connected building frames is well understood, that the task of including the effects of realistic connection behavior in office analysis tools is not difficult, and that rational design procedures are becoming available for safe and economical design of flexibly-connected frames.

REFERENCES

1. LINDSEY, S.D., IOANNIDES, S.A., and GOVERDHAN, A., "LRFD Analysis and Design of Beams with Partially Restrained Connections", AISC Engineering Jnl., Fourth Quarter 1985.

2. GERSTLE, K.H., "Flexibly-Connected Steel Frames", Chap. 7, "Steel-Framed Structures - Stability and Strength", R. Narayanan, Editor, Elsevier, London and New York, 1985.
3. "Manual of Steel Construction", AISC, Eighth Edition, 1980.
4. "Load and Resistance Factor Design, Manual of Steel Construction", AISC, First Edition, 1986.
5. FRYE, M.J. and MORRIS, G.A. (1975) "Analysis of Flexibly-Connected Steel Frames", Canadian Journal of Civil Engineering, 2, 280-91.
6. KRISHNAMURTHY, N., HUANG, H.-T., JEFFREY, P.K. and AVERY, L.K. (1979) "Analytical $M-\theta$ Curves for End-Plate Connections", Trans. ASCE, J. Struct. Div., 105, ST1, 133-45.
7. RICHARD, R.M., GILLETT, P.E., KRIEGH, J.D., "The Analysis and Design of Single-Plate Framing Connections", AISC Engineering Journal, No. 2, 1980.
8. MORRIS, G.A., "Connections Bibliography", Task Group 25, Ed., Structural Stability Research Council, March 1987.
9. GOVERDHAN, A.V., MS Thesis, "A Collection of Experimental Moment Rotation Curves and Evaluation of Prediction Equations for Semi-Rigid Connections", Vanderbilt University, Nashville, TN, 1984.
10. KISHI, N. and CHEN, W.F., "Data Base of Steel Beam-to-Column Connections", School of Civil Engineering, Purdue University, 1986.
11. MONCARZ, P.D. and GERSTLE, K.H. (1981) "Steel Frames with Nonlinear Connections", Trans. ASCE, J. Struct. Div., 107, ST8, 1427-41.
12. AMERICAN SOCIETY of CIVIL ENGINEERS, "Plastic Design in Steel," Manual No. 41, 2nd Ed., 1971.
13. ACKROYD, M.H. and GERSTLE, K.H. (1977) "Strength and Stiffness of Type 2 Steel Frames", Report to AISI, University of Colorado, USA.
14. GERSTLE, K.H., and COOK, N.E., "Simplicity in Flexibly-Connected Frame Analysis", in "Connections in Steel Structures", Bjorhovde, Brozzetti, and Colson, Eds., Elsevier, London, 1988.
15. ACKROYD, M.H. (1977) "Automatic Design of Steel Frames with Flexible Connections", Report to AISI, University of Colorado, USA.
16. ACKROYD, M.H. and GERSTLE, K.H., "Strength of Flexibly-Connected Steel Frames", Engineering Structures, Vol. 5, January 1983.

17. ACKROYD, M.H., "Design of Flexibly-Connected Unbraced Steel Frame Building Frames", Journal of Constructional Steel Research, August, 1987.
18. ACKROYD, M.H., "Simplified Frame Design of Type PR Construction", Engineering Journal, American Institute of Steel Construction, Vol. 24, No. 4, Fourth Quarter 1987.
19. ACKROYD, M.H., "Electronic Spreadsheet Tools for Semi-Rigid Frames", submitted for publication in AISC Engineering Journal.

List of Figures

1. Moment-Rotation Characteristics of Steel Frame Connections
 - (a) Connection
 - (b) Moment-Rotation Relations
2. Flexibly-Connected Floor Beam
 - (a) Floor Beam
 - (b) Design Moments
3. Moments and Sways of Flexibly-Connected Steel Frame
 - (a) Frame
 - (b) } Column Moments and Sways for Different Connection Stiffnesses
 - (c) }
 - (d) }
 - (e) }
4. Stiffness Matrix for Flexibly-Connected Member
 - (a) Nodal Numbering
 - (b) Stiffness Matrix
5. Effective Ranges for Flexibly-Connected Members
6. Sways of Flexibly-Connected Steel Frames
7. Elastic-Plastic Analysis of Flexibly-Connected Frames
 - (a) Flexibly-Connected Beam
 - (b) Exact and Elastic-Plastic Moment-Rotation Curves
 - (c) Exact and Elastic-Plastic Load-Deflection Curves
8. Iterative Allowable Stress Design Using Linear Analysis
9. Governing Limit State for Type 2 Frames
10. Multi-Story Frame under Gravity Loads
11. Modified Type 2 Design Steps
12. Moment Redistribution from Modified Type 2 Procedure
13. Equivalent Beam Cross Section Property Models
14. Components of Building Drift at Story Levels

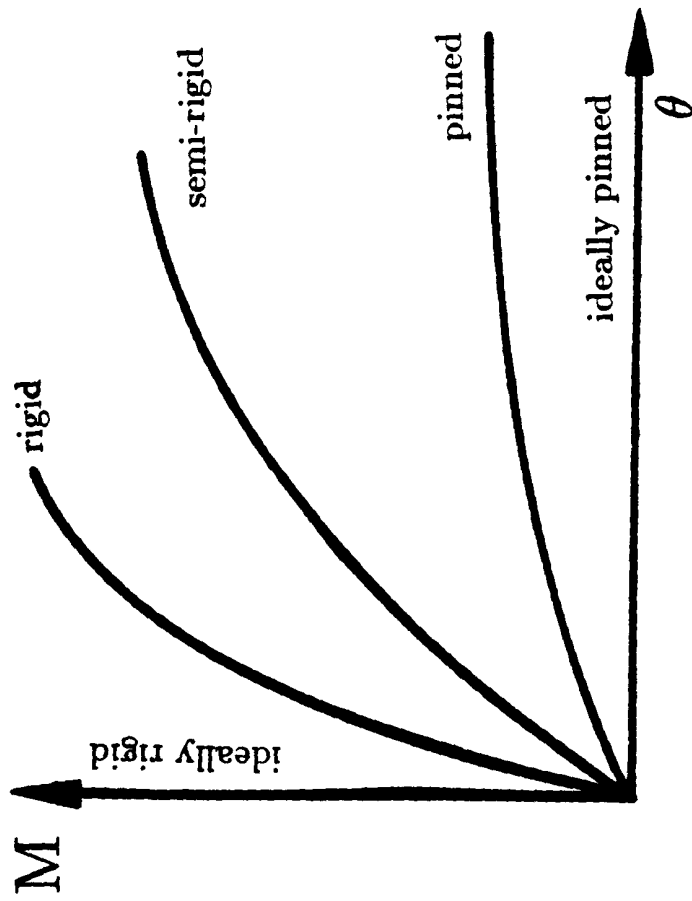
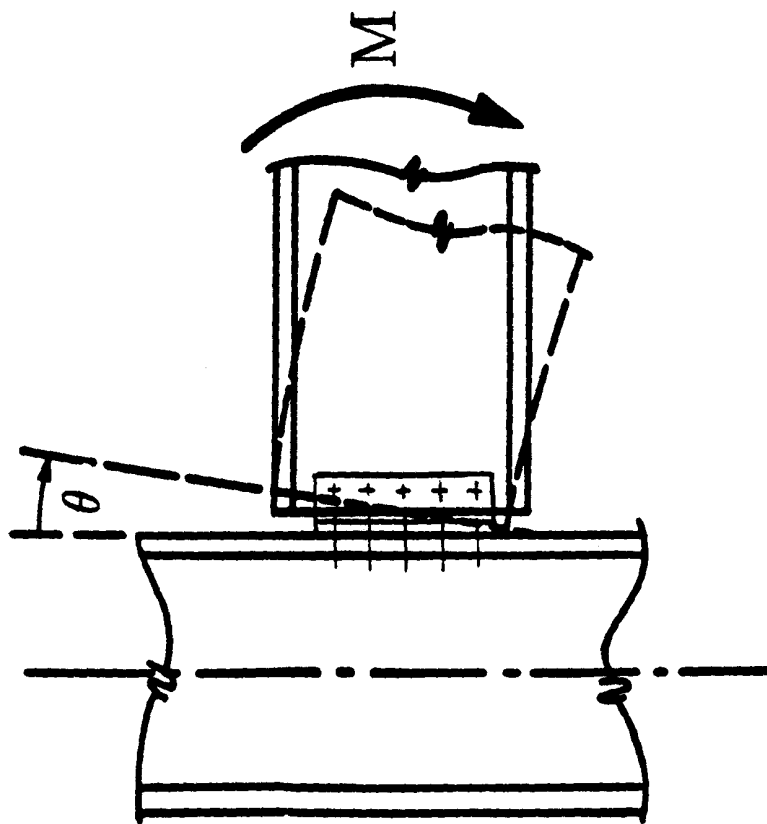

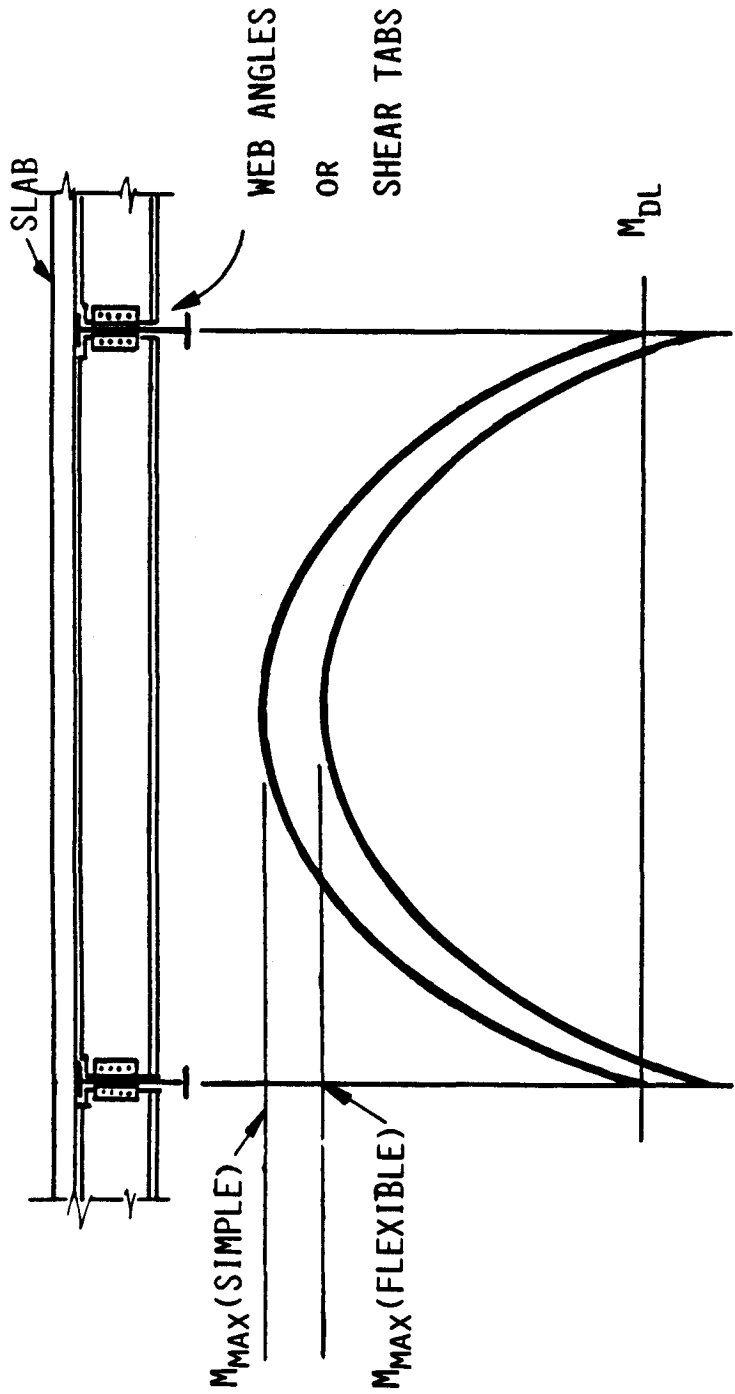

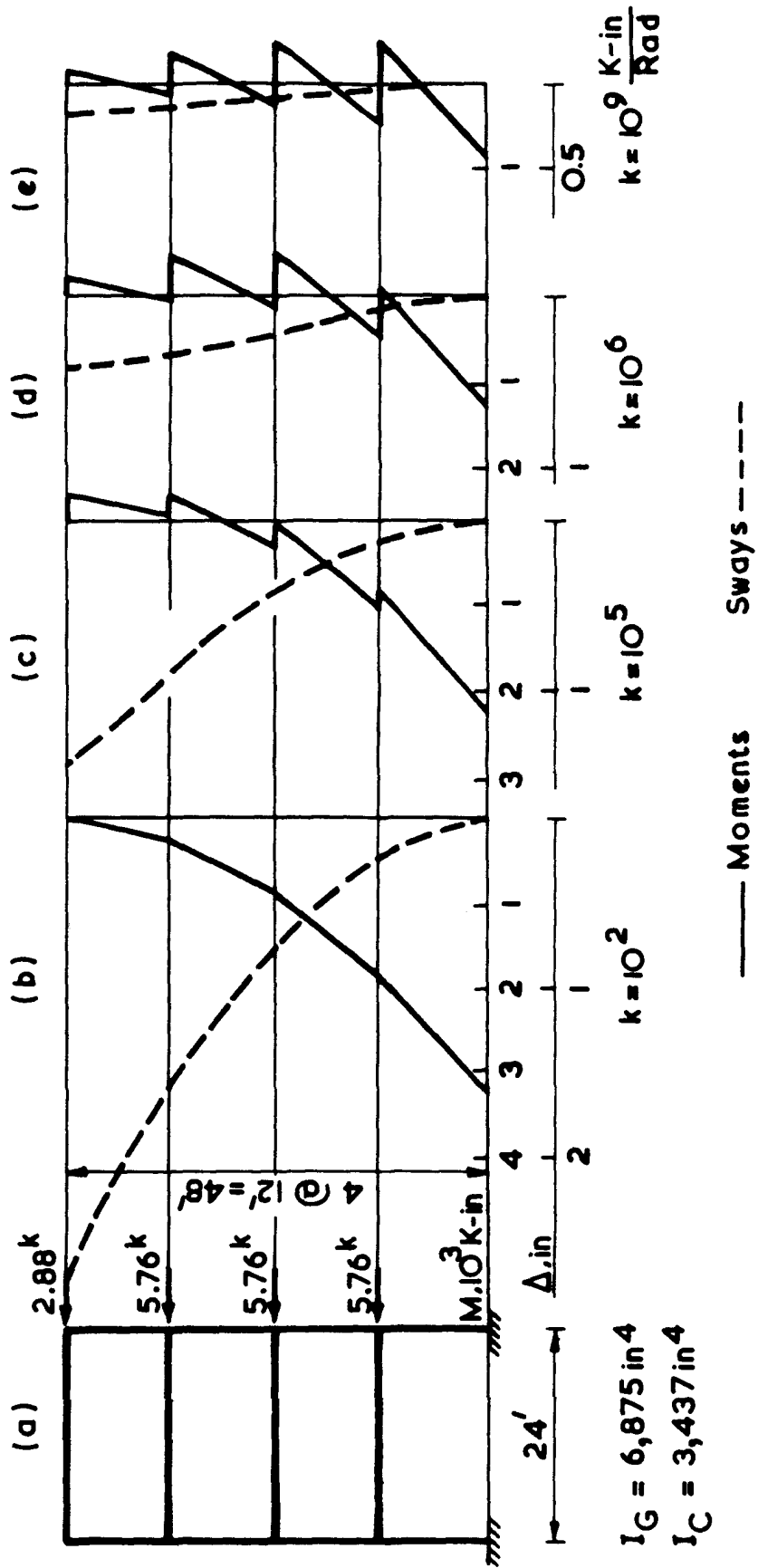

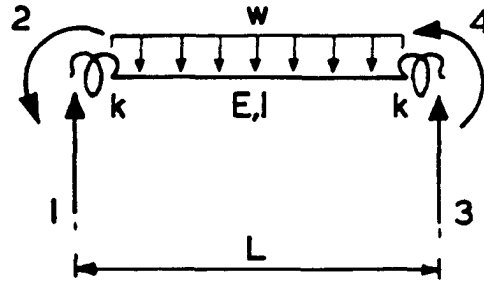

$$K = \frac{EI}{L^3} \frac{1}{1 + 8 \frac{EI}{KL} + 12 \left(\frac{EI}{KL}\right)^2} \begin{bmatrix} 12\left(1 + 2\frac{EI}{KL}\right) & 6\left(1 + 2\frac{EI}{KL}\right)L & -12\left(1 + 2\frac{EI}{KL}\right) & 6\left(1 + 2\frac{EI}{KL}\right)L \\ & 4\left(1 + 3\frac{EI}{KL}\right)L^2 & -6\left(1 + 2\frac{EI}{KL}\right)L & 2L^2 \\ & & 12\left(1 + 2\frac{EI}{KL}\right) & -6\left(1 + 2\frac{EI}{KL}\right)L \\ \text{SYM.} & & & 4\left(1 + 3\frac{EI}{KL}\right)L \end{bmatrix}$$

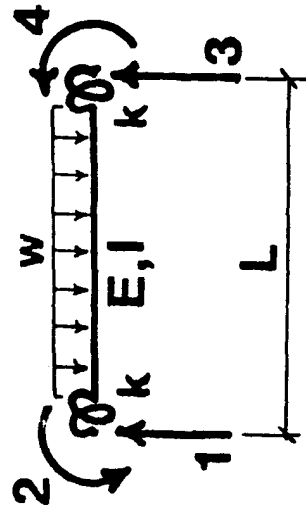
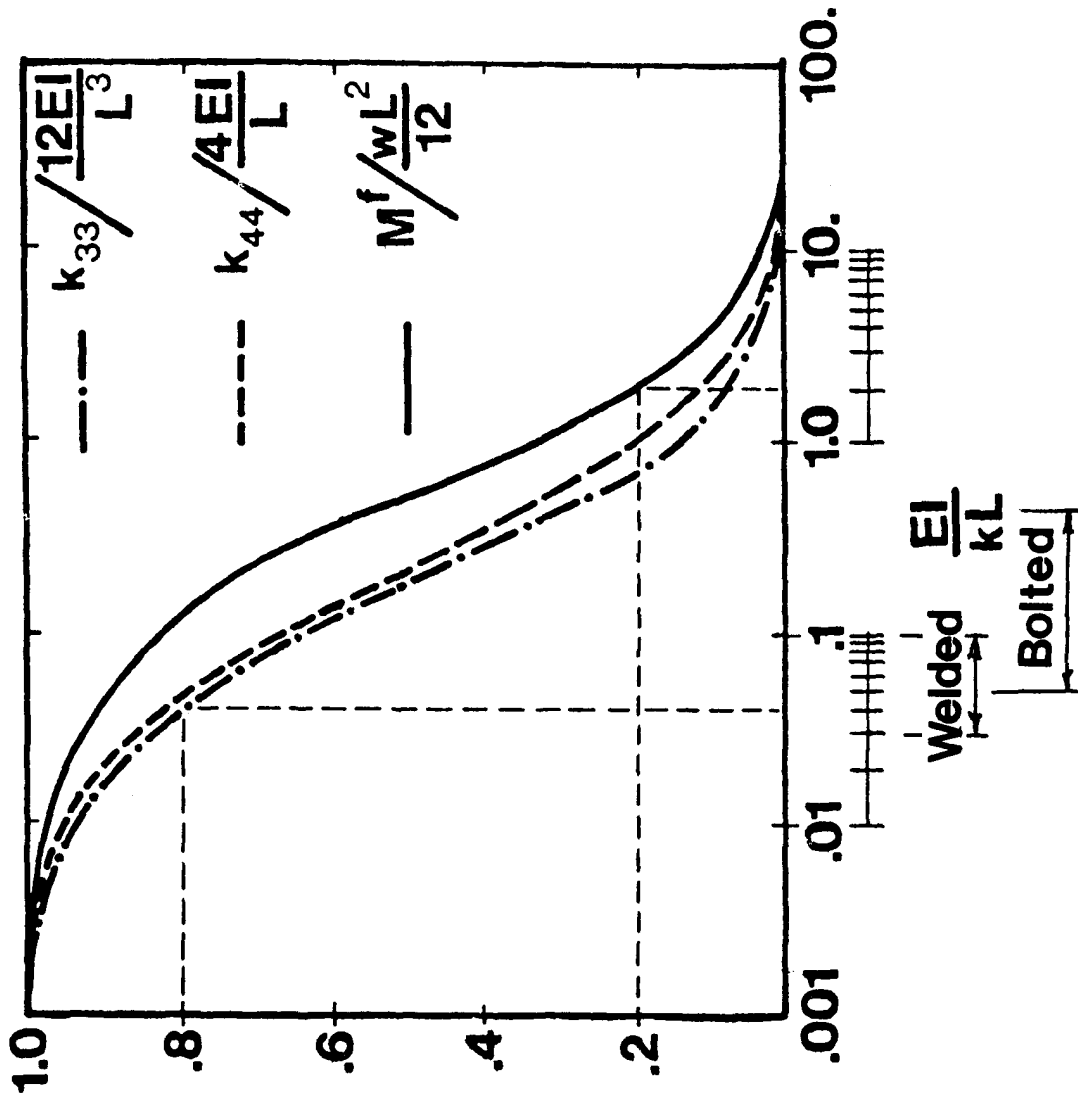

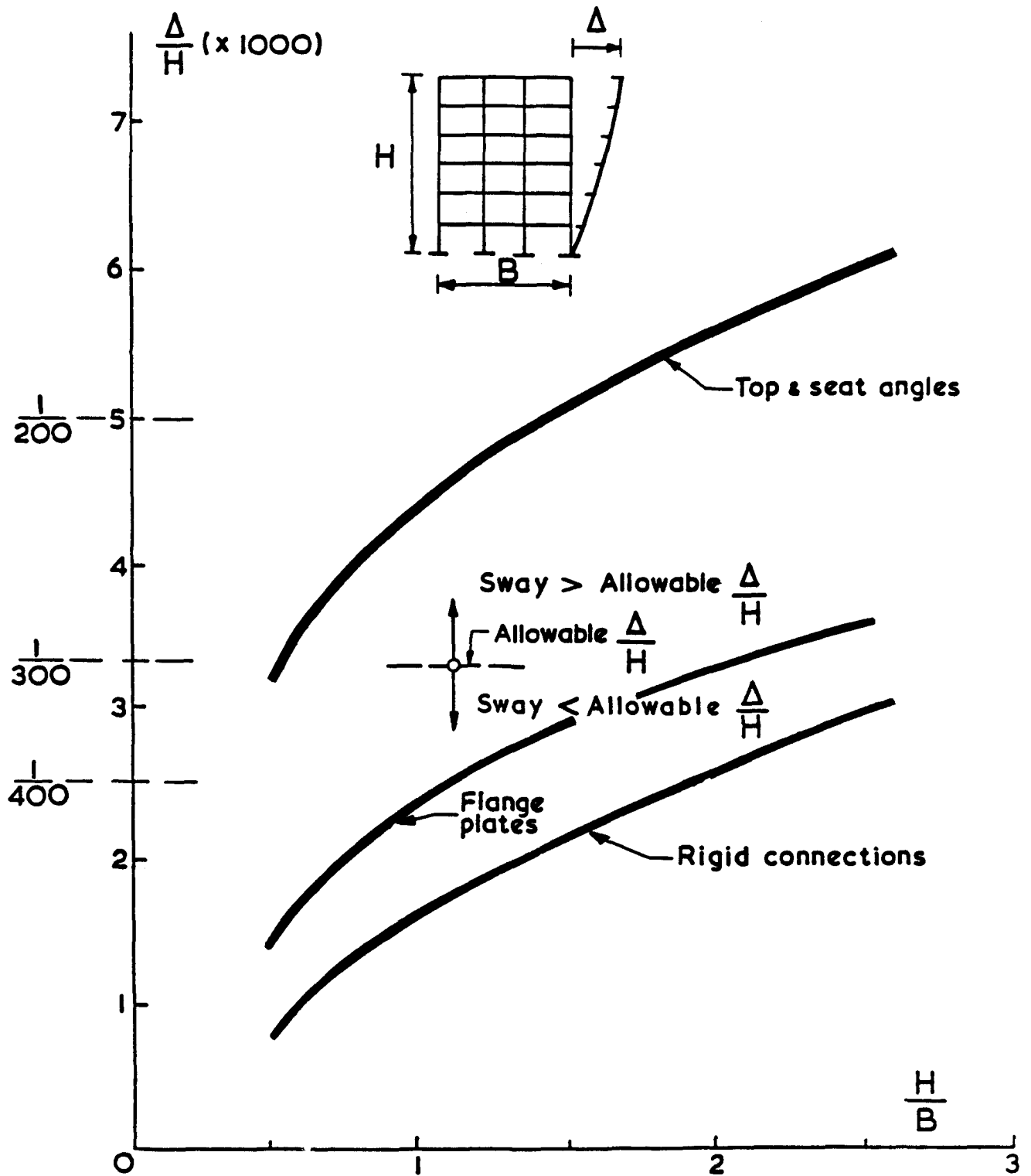

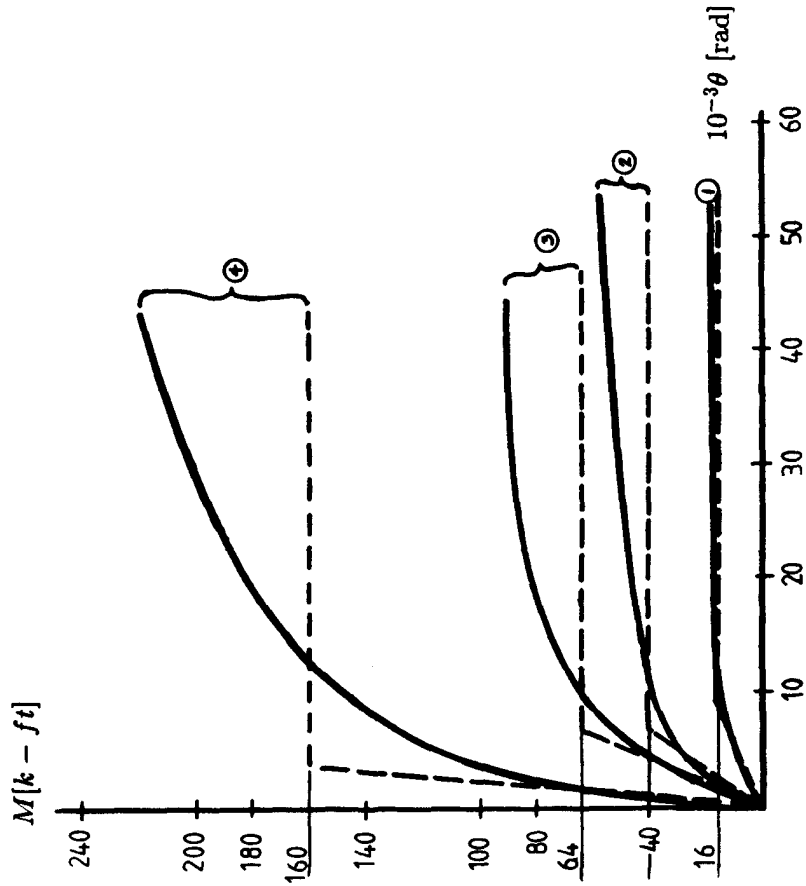
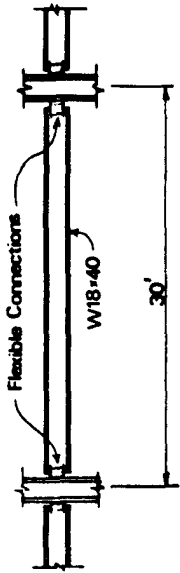

— Non-Linear
 - - - Elastic-Plastic

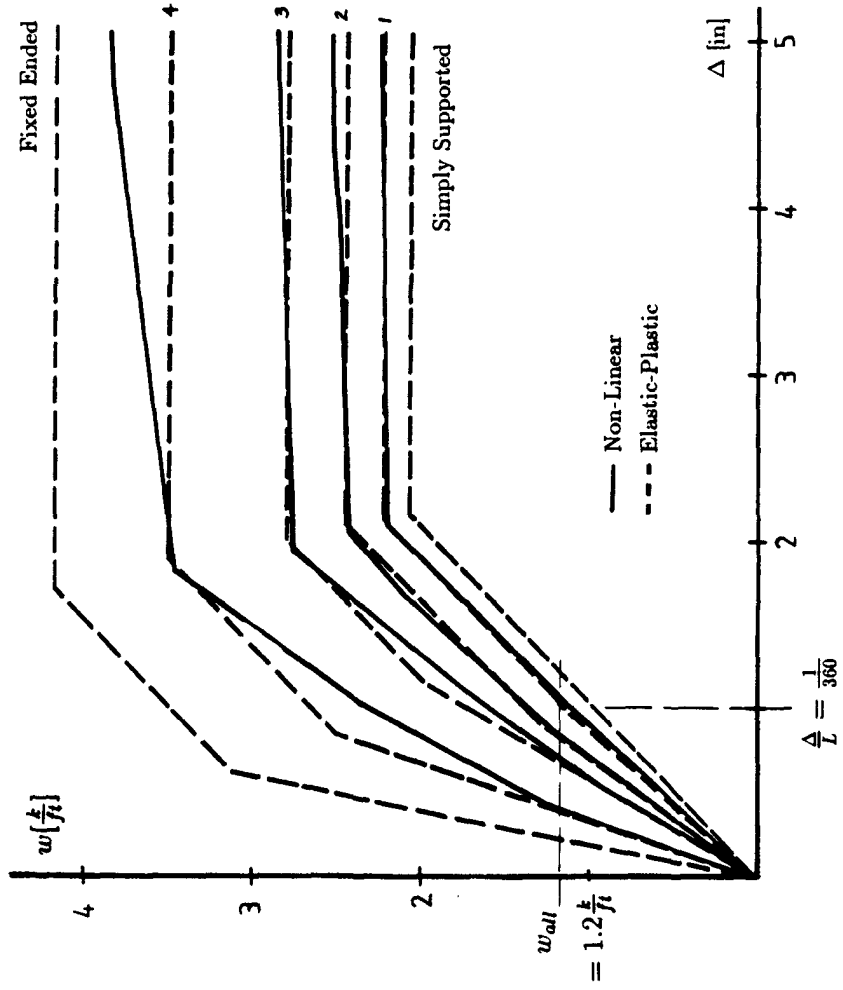

— Non-Linear
 - - - Elastic-Plastic

STORY	MEMBER	TYPE 1 CONSTRUCTION			TYPE 2 CONSTRUCTION			
		PRELIM	Fully Welded		PRELIM	Flange Plates		
			ITERATION 1	ITERATION 2		ITERATION 1	ITERATION 2	T+S Angles
						ITERATION 1	ITERATION 2	
	EXT COL	W14x68	W14x74	W14x61	W14x68	W14x74	W14x74	W14x74
	INT COL	W14x78	W14x84	W14x78	W14x84	W14x84	W14x87	W14x87
	GIRD	W18x40	W18x40	W21x49	W18x40	W18x40	W21x44	W18x40
	EXT COL	W14x61	W14x61	W14x53	W14x53	W14x61	W14x61	W14x61
2	INT COL	W14x68	W14x68	W14x68	W14x68	W14x68	W14x68	W14x68
	GIRD	W18x45	W18x40	W21x49	W18x40	W18x40	W21x44	W18x40
	EXT COL	W14x53	W14x48	W14x30	W14x38	W14x43	W14x38	W14x43
3	INT COL	W14x61	W14x48	W14x61	W14x53	W14x53	W14x53	W14x53
	GIRD	W18x40	W18x35	W21x49	W18x40	W18x35	W21x44	W21x44
	EXT COL	W14x43	W14x38	W14x30	W14x34	W14x34	W14x34	W14x34
4	INT COL	W14x30	W14x34	W14x30	W14x34	W14x34	W14x34	W14x34
	GIRD	W16x36	W18x35	W21x49	W18x40	W18x35	W21x44	W21x44
	EXT COL	W14x30	W14x34	W14x30	W14x34	W14x34	W14x34	W14x34
5	INT COL	W14x30	W14x34	W14x30	W14x34	W14x34	W14x34	W14x34
	GIRD	W16x36	W18x35	W21x49	W18x40	W18x40	W21x49	W21x44
TOTAL WEIGHT (lbs)		24,588	23,364	26,004	24,000	23,856	25,908	25,248

STANDARD DESIGN

HDCPY

TRAILS

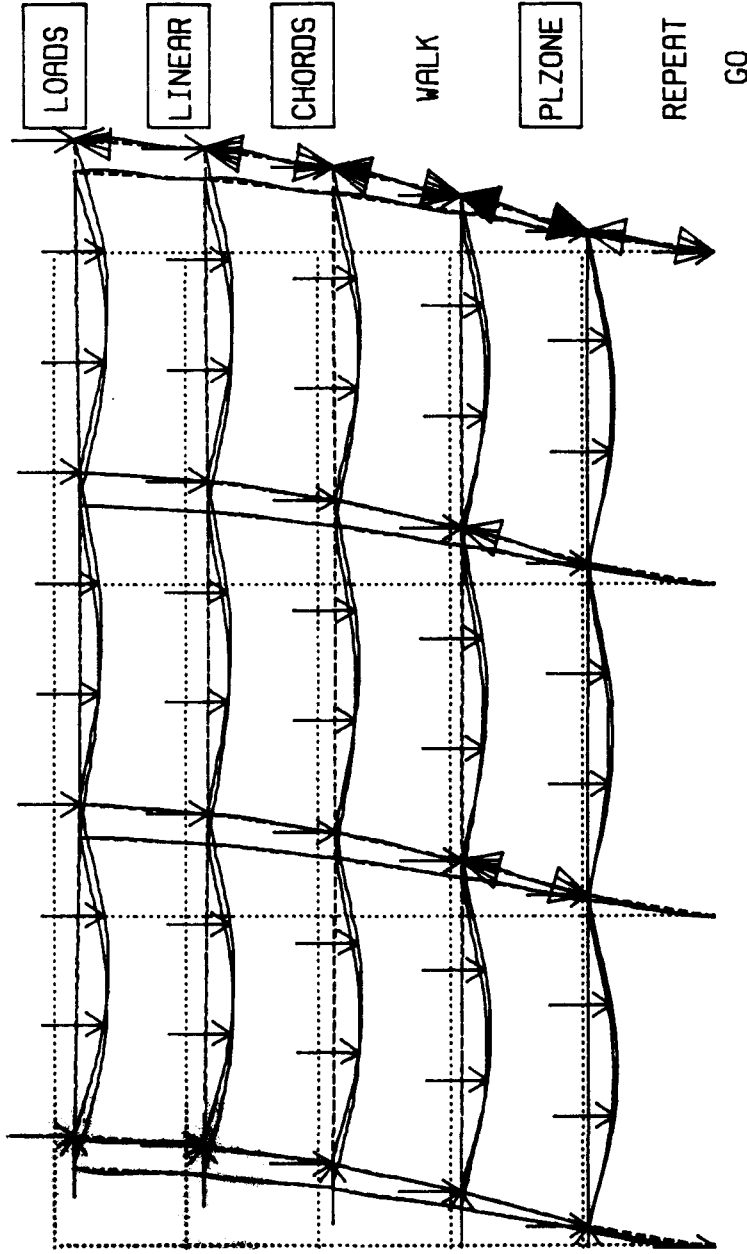

CURRENT LOAD 55.530

MAXIMUM LOAD 55.530

RETURN

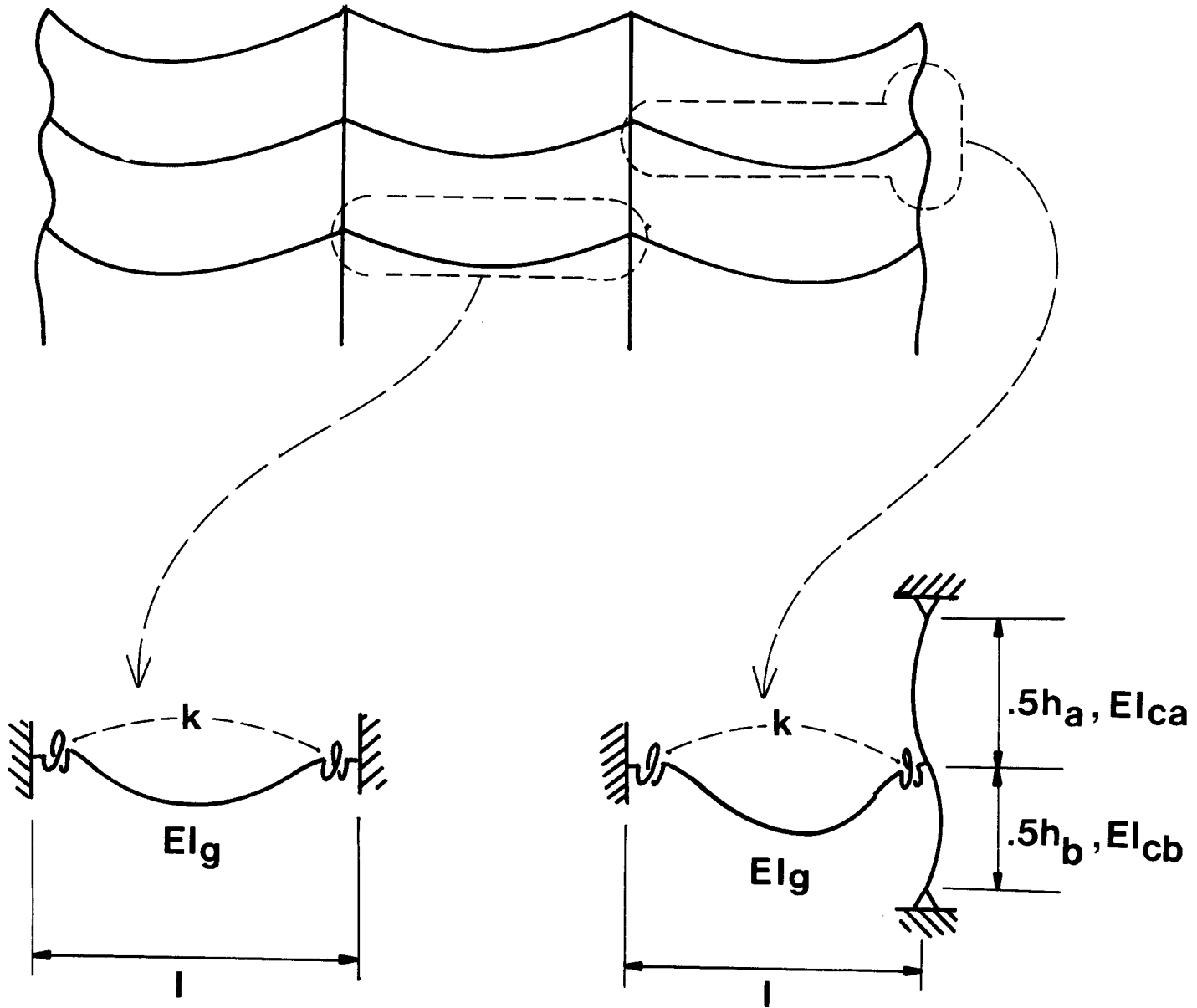

ANALYZE FRAME AS TYPE 2

DESIGN MEMBERS AND CONNECTIONS
($K_x = 1.5$) (wind moment)

REFINE GRAVITY ANALYSIS

A. Connection Flexibility Parameters

- calculate k_i , M_p

- calculate k

$k = k_i$ (elastic-plastic)

$k = .5k_i$ (nonlinear)

- $a = \frac{EI_g}{kl}$

B. Relative Flexibility Factors

$$g = \frac{I_g/l}{\sum I_c/h}$$

C. Flexible End Moments

$$C_i = 1 + 2a - g / (3(g + 1 + 6a))$$

$$M_i = M_f / C_i$$

$$C_e = 1 + 2a + 2g(1 + 3a) / (3(1 + 6a))$$

$$M_e = M_f / C_e$$

D. Distribute Flexible End Moments

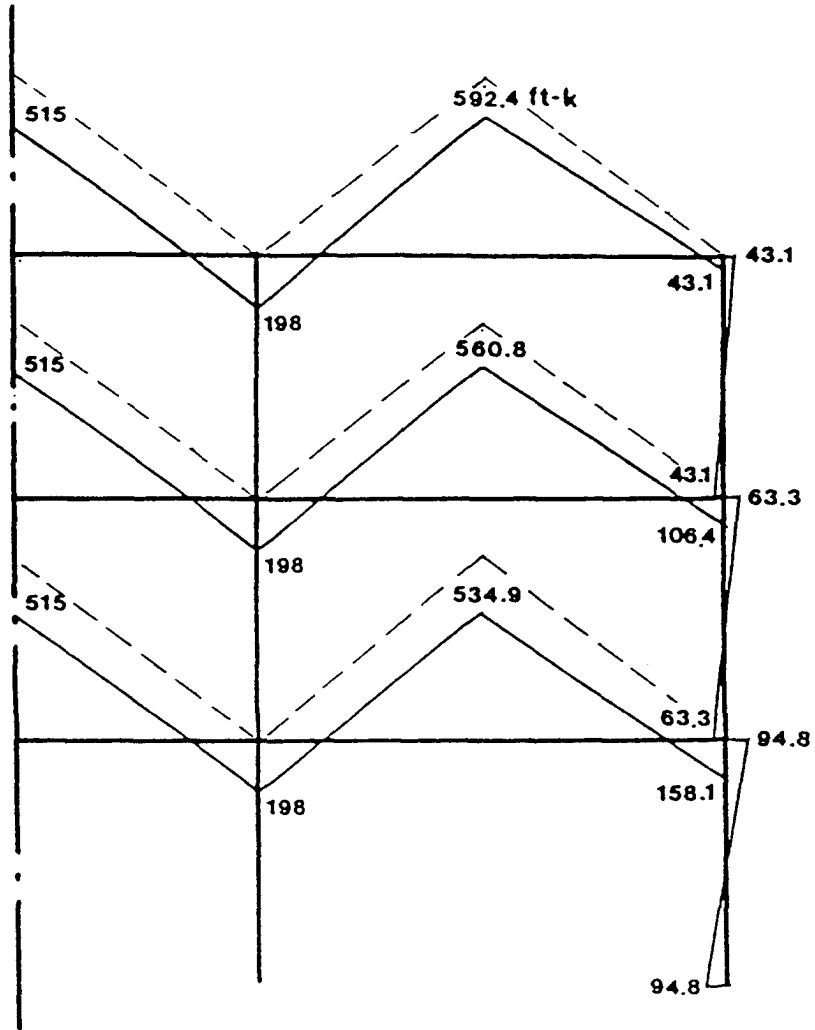

----- Type 2 moments

————— Redistributed moments

Column Axial

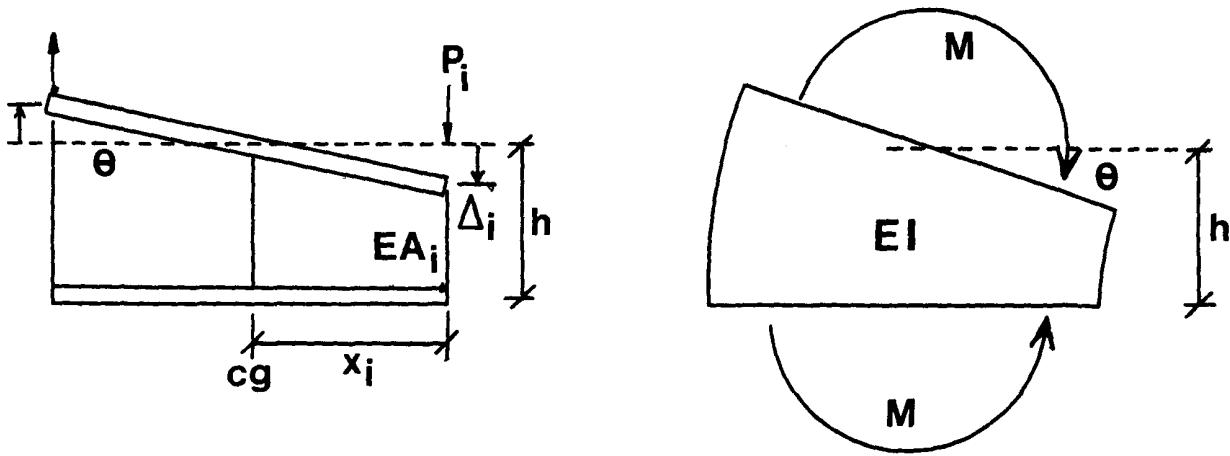

Column Bending

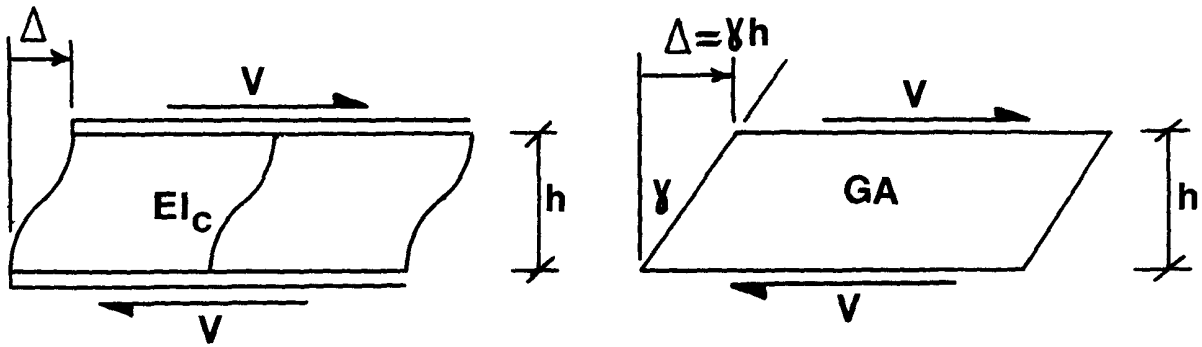

Flexibly - Connected Girders

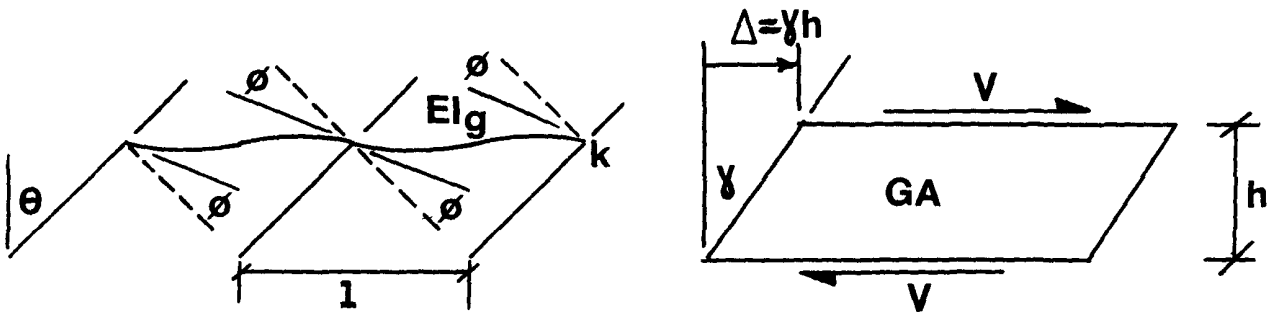

BUILDING DRIFT

Lateral displacements at story levels

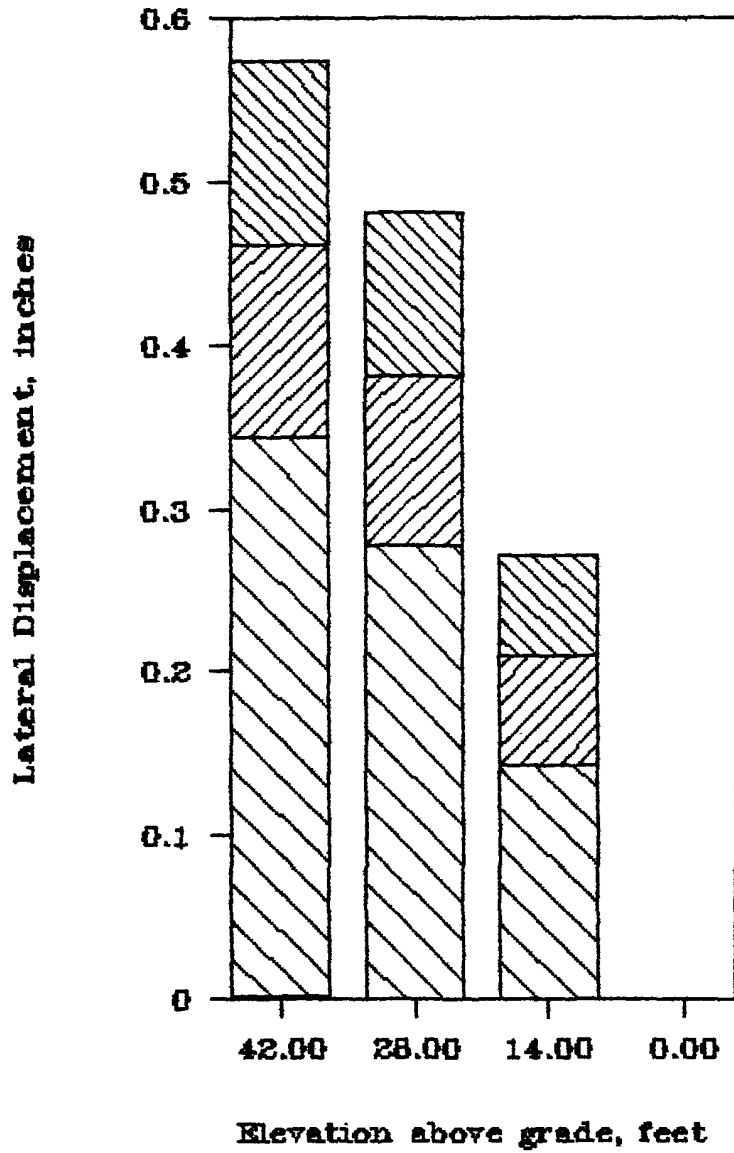

Axiel

Col Head

Beam

Conn