

NATIONAL STEEL LUMBER SECTIONS

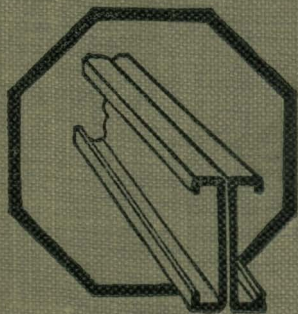

1921

AISC E&R Library



5548

B261

HANDBOOK *of*
National Steel Lumber

PRODUCED BY

THE NATIONAL PRESSED STEEL CO.

Main Office and Works

MASSILLON, OHIO



Copyright, 1921
By The National Pressed Steel Co.
Massillon, Ohio

Prepared by

THE STEEL LUMBER DIVISION

under the direction of

H. M. NAUGLE

STANLEY MACOMBER

DISTRICT OFFICES

Atlanta
Baltimore
Boston
Chicago

Cleveland
Dallas
Detroit
Indianapolis

Kansas City
Minneapolis
New York
Philadelphia

Distributors in all principal cities

Foreword

MERIT is largely a question of comparison. Therefore to visualize more clearly the efficiency and practicality of Steel Lumber construction it is proper to compare it with other accepted types of fire-safe designs. Considerable space is given in this handbook to the consideration of costs of construction—attention being directed to conditions that affect the total costs of the structural part of a building.

In order that the Architect and Engineer may more readily grasp the efficiency of Steel Lumber and the effect of its use on other portions of the building various comparisons are drawn. Let it be understood that these comparisons are not made with any spirit of criticism, but for the purpose of securing a better understanding as to the particular field in which a type of construction is the most practical.

Good engineering calls for the use of those materials which under given conditions will most efficiently and economically meet the requirements. There is no material nor any one type of construction that universally proves the best. The proper combination of materials structurally and otherwise requires special and intelligent study.

Confidence in the practicability and durability of steel construction is derived from a thorough understanding of the action of steel under high temperatures. Such information is presented in this book and the difference between structural and National shapes is pointed out. The relative efficiency of the two products and the requisite fire protection required for each is discussed.

Notice

IN this second edition of the National Steel Lumber Handbook is embodied complete information and authentic data pertaining to the use of Steel Lumber Sections and kindred materials.

The last two years have witnessed a remarkable increase in the tonnage of Steel Lumber Sections installed throughout the country. Experience during this time has developed a number of improvements in the product. Some changes have been made in the design of National Sections resulting in greater efficiency. The Spring Lath Clip has provided a firmer bond between lath and joists, simplified distribution and reduced installation costs. This edition of the Handbook covers all recent developments and amplifies in many respects the contents of the first edition.

The first edition of the National Steel Lumber Handbook was founded upon data compiled during a period of twelve years by the individuals who conceived the idea of Steel Lumber and developed the product throughout the engineering, manufacturing and installation stages. This second edition has been prepared by an organization, manufacturing on a mill basis in large quantities and long lengths and distributing over every portion of the United States.

Steel buildings, as developed through the use of structural steel skeleton frame supporting Steel Joist floors, are rapidly proving their superiority in every respect over all other known types of fire-safe construction. The leading steel fabricating interests throughout the country advocating this type of structure and rendering designing service recognized as of the highest standard, form a responsible distributing unit upon which the building public can depend with absolute confidence. The dealer organization developing around the fabricating industry is carrying the availability of steel construction into every community and for all classes of buildings, large and small.

Stocks of National Steel Lumber, structural steel and steel lath have been established in all principal distributing centers to insure prompt deliveries and facilitate the maintenance of a high standard of service.

Preface

Steel Lumber was designed primarily to take the place of wood joists and studs in floor and partition construction. The use of steel lath, which is secured to the steel sections by means of spring lath clips attached over the flanges, provides a construction which entirely eliminates combustible material. The result is a light weight, fireproof and indestructible building at slightly increased cost over that of wood.

The value of this material in reducing the enormous annual fire losses and the economic necessity of bringing the cost of fireproof construction within the range of the average individual have been evidenced by the rapid and substantial growth of the demand for Steel Lumber.

In order to supply this increasing demand we installed special mills, machinery and equipment to the extent that sufficient quantity, proper quality and service are assured.

National Steel Sections are the result of intimate first-hand knowledge of the Steel Lumber industry. In every respect they are so designed as to develop the greatest efficiency and economic advantage. The salient points of every phase of the industry have been given full consideration. The result is a co-ordination of the various features applying from every angle in a section design that is basic in its economy and efficiency.

The process of manufacturing the steel and forming the product as embodied in our plant is the best that engineering ability and mechanical facilities have produced. The analysis and working of the steel are such that the greatest advantages are secured in quality and strength.

The information presented in this handbook is intended as a real aid to the architect and engineer in economically designing buildings by using National Steel Lumber. Information regarding standard sections only is given but special shapes can be produced at small additional cost.

TABLE OF CONTENTS

	Page
Notice	3
Preface.....	4
National Steel Lumber.....	5
Strength of Steel at High Temperatures	6-7
National Steel Joist Development and Comparison	8-11
National Steel Lumber Sections.....	12-20
Accessories.....	21
Designing Data.....	22
Safe Loading Tables.....	23-35
Beam Clips	36-37
Beam Furring Clips.....	38-39
Steel Lath	40-43
Spring Clips.....	44-48
Bridging.....	49-53
Installing Steel Joists.....	54-55
Estimating Data.....	56-62
Economy of Steel Construction.....	63
Cost Data.....	64-73
Construction Details.....	74-101
Stairway Construction.....	102-105

TABLE OF CONTENTS

	Page
Fireproofing of Structural Steel.....	106-110
Footing Design.....	111-115
Comparisons of Dead Weight.....	116-119
Specifications	120-124
Framing Openings.....	125-127
Garage Floors.....	128
Strength of Slab on Joists.....	129
Weight of National Steel Lumber Floors	130-131
General Information.....	132-148
Various Uses of Steel Lumber.....	149-155
Live Loads.....	156-157
Bending Moments and Formulæ.....	158-159
Weights of Building Materials.....	160-161
Coefficients of Deflection.....	162
Safe Unit Fibre Stress.....	163
Structural Timber.....	164-168
National Strip Steel.....	169
Gauge Equivalents.....	170
National Steel Lumber Distributers.....	180

(For Complete Detail of Contents, see Index)

National Steel Lumber

NATIONAL Steel Lumber is made from a high quality basic open hearth steel, rolled from a slab to the finished product in our own mills under strict supervision and inspection.

These sections can be furnished in maximum lengths of one hundred feet if desired, thus eliminating all splicing. As the strips receive even rolling and are of uniform thickness over the entire width, they come from the mill perfectly flat showing the absence of internal stresses.

After the strip is thoroughly cooled, it is then formed into the section, which insures uniformity throughout, and which uniformity eliminates the possibility of distortion due to internal stress if subjected to high temperature. On account of the uniformity of the thickness of the section and the uniformity of the steel contained therein, a maximum strength is obtained at comparatively high temperatures. Actual fire tests have proven this and show the superior merits of Steel Lumber for fireproof construction.

The strength of National Steel Joist is ample for the purpose intended—all tables being computed on the basis of a safety factor of 4 with a fibre stress of 16,000 lbs. per square inch. The manufacturing processes that give the joists a greater fibre strength and uniformity are not adapted to the production of heavy sections such as are found in structural steel. The function of the steel joist is to pick up the floor loads of buildings, and when such loads have reached a sufficient total transfer them to the heavier sections comprising the skeleton frame or to supporting walls.

The success of Steel Lumber is based upon: fire proof qualities—sound proof qualities—low cost—simplicity of design and installation—adaptability—durability—ease of inspection—light weight, and rapidity of erection.

Temperature-Strength Curve-Low Carbon Steels

As used in Structural and National Shapes

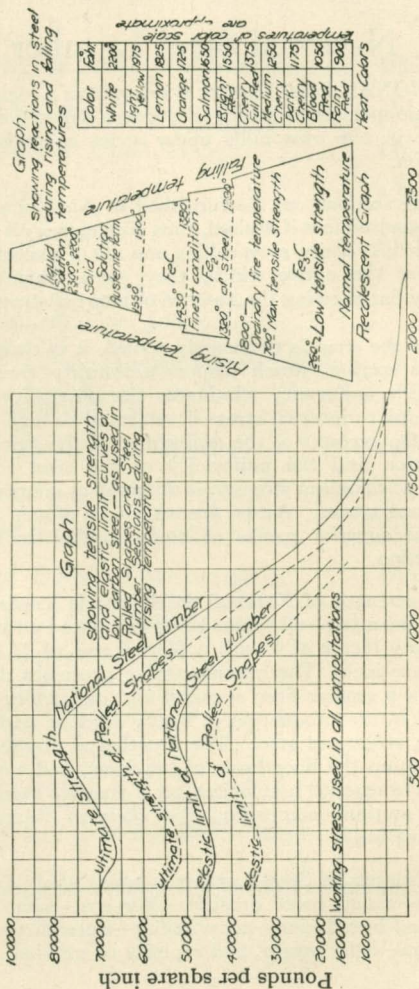

Temperature in degrees Fahrenheit.

Strength of Steel at High Temperatures

The use of iron and steel is universal. No other metal contributes so much to the welfare and comfort of man. No other metal is capable of giving the great range in physical properties that makes iron available for so many purposes. Different methods of production and the changing of alloy contents produce finished steels of entirely different physical properties and available for widely different purposes. Daily contact with some articles of steel composition has familiarized the layman with the nature of this metal. The superior quality of a refined steel as used in a razor blade is recognized and understood. Other metallurgical principles such as the action of steel under high temperatures are not generally known. Referring to building construction where steel is commonly used it is proper that the results of different production methods and the action of different steels under possible temperature conditions should be thoroughly analyzed.

The different methods used in producing National and structural sections are described on pages 5 and 132. The result is an ultimate strength in the structural section of approximately 55,000 lbs. per sq. inch and in the National Sections exceeding 70,000 lbs. per sq. inch. The extra working of material which greatly refines the steel fibre in National Sections raises the elastic limit to relatively a much higher point.

On page 9 the different actions of National Steel Lumber and Rolled Structural Shapes when subjected to high temperatures is discussed. The next point of interest is the relative strength of steel under these conditions. The curves, page 6, graphically illustrate the change in strength under changing temperatures.

Although steel of the structural grade has a greater ultimate strength at temperatures around 700° F., structural shapes because of their process of production tend to twist and distort under that condition. For that reason it is necessary to provide ample fire protection (1½ to 2" of concrete or cement plaster on steel lath) for maintaining the temperature around the sections below that danger point.

With Steel Lumber ample strength is available up to temperatures around 1000° F. to 1200° F. with no tendency to twist or distort. therefore the same amount of protection is not required.

Only a very small percentage of fires develop temperatures exceeding 1200° F. to 1500° F., but the designer must take into account the unusual condition. Repeated fire tests have proven that ¾" of cement ceiling plaster will protect Steel Joist floor construction against temperatures as high as 1700° F., such condition developing less than 550° F. around the joists. This temperature is amply safe even for structural sections but because of the greater responsibility and lower danger point columns should always be more heavily protected. The same being true of main supporting girders in higher buildings.

National Steel Joist Development and Comparison

Discussing Fig. 1, a wood joist, we have a section which has been used effectively from a standpoint of strength and adaptability, but not from the standpoint of an economical use of material. The wood joist proves low in cost, only on account of its ease of production, but this condition is rapidly changing, and the wood joist is becoming more expensive and questionable in quality. If the wood joist could be substituted by a plate of steel placed on edge, at the same strength but less weight, efficiency would be readily admitted. This is substantially what has been done in producing National Steel Joists, excepting that flanges have been added to produce lateral stiffness, serve as a means of fastening finished floor and ceiling to the joist section, and contribute additional strength.

An analysis of the wood joist shows that the tension, compression and shearing stresses are resisted entirely by what might be termed a web section, or what corresponds to the web section of a steel joist or a rolled steel beam.

Referring to Fig. 2, the rolled steel beam of equal depth performs its function in a different way than the wood joist. The top flange, bottom flange and web are designed to resist the compression, tension and shearing stresses respectively.

In producing the standard rolled steel section, it is impossible to have every portion of the steel making up the section receive the same amount of rolling. This is



Fig. 1.

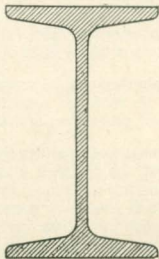

Fig. 2

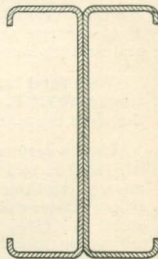

Fig. 3

because of the horizontal groove rolls employed in the old style shape mills.

When this shape comes from the rolls, finished as to size, and naturally of comparatively high temperature, it is very crooked and must be run through straightening rolls in the cooling process. This straightening is made necessary by the deformation caused by unequal expansion and contraction due to the varying thickness and unequal density of material making up the section. The web is the only part of the section properly rolled in the mill, the flanges being produced by crowding or dragging the metal through the flanged grooves of the rolls.

Since this condition of internal stress is produced originally by temperature reactions through cooling, it is natural that a similar condition will prevail when the section is again subjected to a high temperature for the latent stresses in the section, created in the process of straightening, are released, causing deformation and distortions until the stresses in the steel are either in equilibrium or the beam fails. Invariably the primary cause of failure of rolled steel beams in buildings subjected to fire is due to internal stress caused by excessive temperature being applied to either the top or bottom flange, or both. Therefore, the necessity of totally incasing a rolled steel beam with tile, metal lath and plaster, concrete or some other protective fireproof material.

An analysis of the rolled steel beam (Fig. 2) will show that the flanges contribute 44% each of the resisting inches or section modulus, while the web contributes only 12%. Since the bottom flange is the one most likely to be subjected to excessive temperature, and since this flange is required to resist tension stresses, it is the practice to provide approximately 2 inches of fireproof protection.

A careful analysis of Fig. 3, illustrating a National Steel Joist, shows a different condition prevailing. The web contributes a large percentage of the resisting inches or section modulus. In the case of the National Steel Joist the web contributes 40%, the flanges 30% each. It is readily seen that the bottom flange is not of such importance as is the case with the rolled steel beam. The protection of the flange with approximately $\frac{7}{8}$ -inch of plaster produces a result which is equal to the protection of a rolled steel beam with 2 inches of fire-proof material. In addition to this the National Steel Joist is free from internal stresses due to unequal rolling and thickness, and conse-

quently will not twist and distort under high temperatures. By application of the floor and ceiling to the flanges of the joist the web is surrounded by a dead air space, which is the best method of insulation.

Other Points of Merit

Steel Joist construction provides a first-class fire-proof building with the lightest floors, and so reduces dead load weight on beams, columns, walls and foundation.

It is sound proof, making it ideal for installation in all classes of buildings.

It gives a finish in a building not obtainable in many other types of fireproof construction. Plaster is mechanically bonded to the metal lath and becomes a permanent part of the building.

It provides a safe and dependable means of economical construction during winter months; the prosecution of the work not being handicapped by usual protective measures, and the danger of serious results from freezing being entirely eliminated.

The more simple a construction the less is the chance for failure. Steel Joist construction is the most simple of floor constructions. It is consequently the most reliable. The joists provide the entire carrying capacity of the floor panel; dependence not being placed on a combination of a number of different materials to develop the total required strength. Steel joists can be erected safely and quickly with very little supervision and inspection, whereas with all other fireproof systems skilled supervision and inspection is required. The accuracy of placing the steel is not simply a point of good workmanship, but a matter of vital importance as regards the actual strength and carrying capacity of the structure.

It has always been recognized that the ideal building material, whether for beams, girders, floors or columns, is a shop fabricated material; that the custom of using loose bars with the attendant necessity of dependence upon the human element was wrong in principle and dangerous in action. All attempts, however, to supply the proper construction for floors, whose members were properly fabricated in advance, have proved failures commercially owing to the excessive cost of fabrication, and the impossibility of shipping the ordinary flimsy fabricated units without serious damage in transit, and

the excessive cost of erection, until the idea and application of steel joist construction was successfully worked out.

A perfect floor construction must be one whose separate integral parts will satisfy the following conditions:— The integral parts must be technically correct, and the units made up of these parts must be rigid in construction, and so designed that every detail and part of the construction will automatically and without dependence upon skill or care, take and hold, under all conditions, its proper place in the construction — it must be adaptable to its specific purpose in the construction — it must be a construction whose safety is not dependent upon the personal equation. Weather changes and their attendant discomforts should not affect the reliability of the construction.

These points are all met by National Steel Lumber construction. It is a unit system in its fullest sense. Each and every joist is a unit of the floor and entirely supports the loads superimposed thereon. A National Steel Joist floor is one that supports all the varied stresses with individual units.

Heavy or intricate members are absent in National Steel Joist floors. There are no loose parts to get lost, no work requiring the services of those having previous experience in handling this material. The joist is an entire unit in itself, it is solid, self contained and rigid, and is in every way a rugged, practical, workmanlike device to do just one thing and do it well with the least amount of assistance.

Strength of Standard Steel Joist Floors

It is interesting to note that because of the high ultimate strength and elastic limit of the steel in National Steel Joists that the finished floor construction will carry without undue deflection much heavier loads than contemplated in design. Many authoritative loading tests have been made, and in every instance it takes at least two and one-half times the designed live load superimposed on the standard floor construction to develop a maximum deflection equal to $1/360$ of the net span. For testing to failure a load at least eight times the designed load will be required.

National Steel Lumber Sections

National I Joists are symmetrical in section. The flanges are uniform in thickness and one-half the thickness of the web. Heavier sections are obtained by increasing the thickness of material used. Weights shown are minimum and for standard sections. Special sections both as to weight and shape can be produced by special arrangement.

The particular field for Steel Lumber construction is in buildings designed for medium live loads. The dimensions and weights of the joist sections have been worked out to provide the most efficient and practical design for that purpose, experience having demonstrated that in every respect the standard sections provide sufficient latitude for all variations in loading conditions.

Flange widths are held well within the limits which insure full working stress of all parts of the section. Thickness of material is increased with the depth of section, as experience and repeated tests have proven that this is necessary in order to maintain the same high degree of efficiency in all sizes.

For convenience in identification and specifying, sections are designated by their depth and weight, i. e.,

10"—8.7 lb. I

4"—1.85 lb. C

All sections are given a dip coat of paint before leaving the mill. The National base covers painted sections, mill delivery, cut for stock with a two-foot tolerance in length of sections. Maximum lengths being controlled by shipping facilities.

Lengths will be cut to a $\frac{3}{8}$ " tolerance (for specification) at an extra cost.

Sections are furnished only on catalog weights and to an allowable variation of $2\frac{1}{2}\%$ from published weights.

Accessory items such as Bridging, Beam Clips, Furring Clips and Spring Lath Clips have been designed to simplify and improve the construction and are shown on page 21. They are required on practically every installation and are carried in stock in ample quantities at all distributing points.

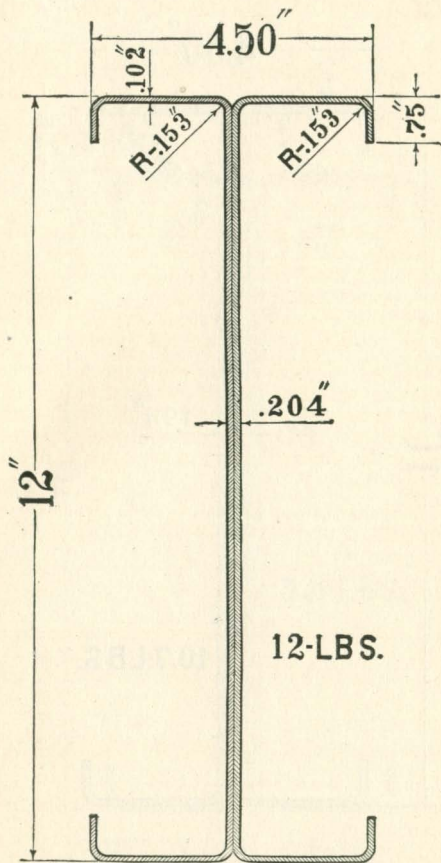

12"—12 lb. I Joist

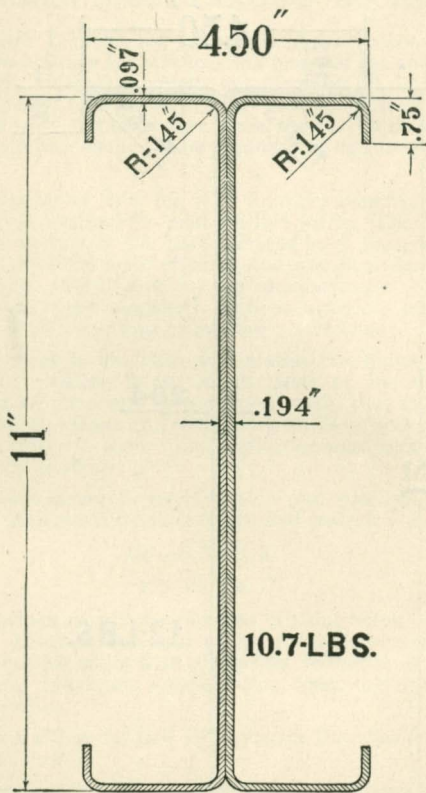

11"—10.7 lbs. I Joist

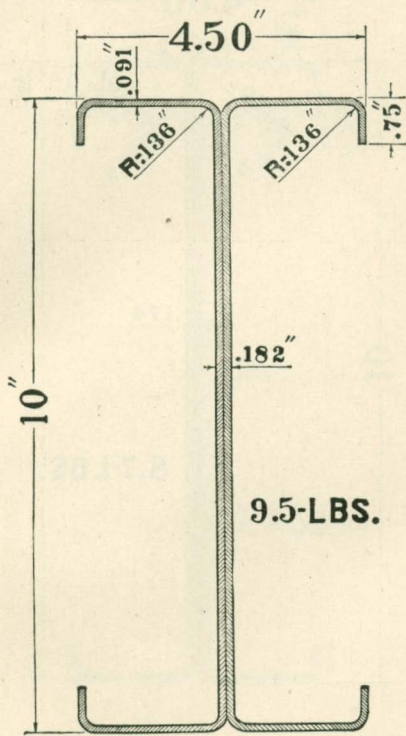

10" — 9.5 lb. I Joist

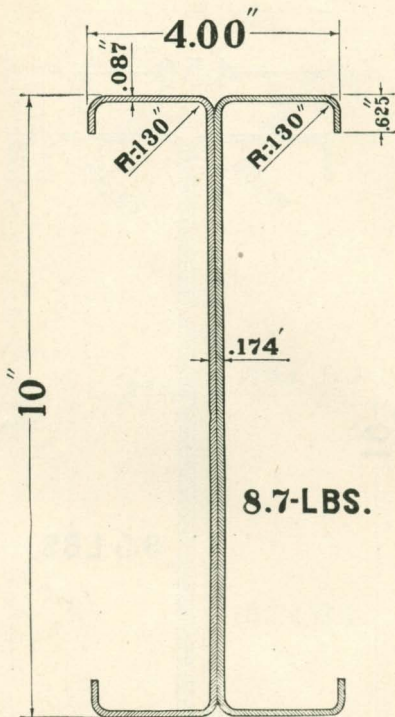

10"—8.7 lb. I Joist

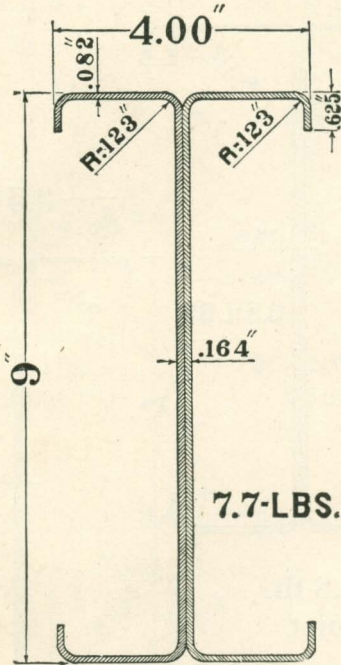

9"—7.7 lb. I Joist

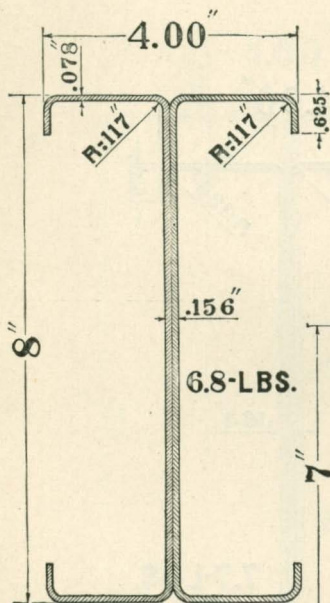

8"—6.8 lb.
I Joist

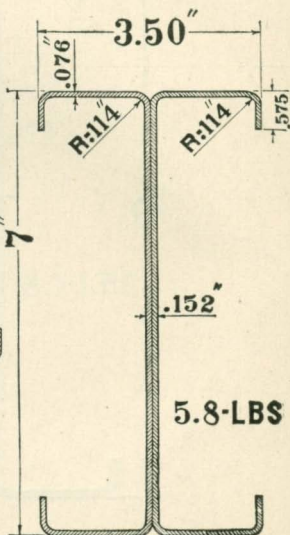

7"—5.8 lb.
I Joist

THE NATIONAL PRESSED STEEL COMPANY

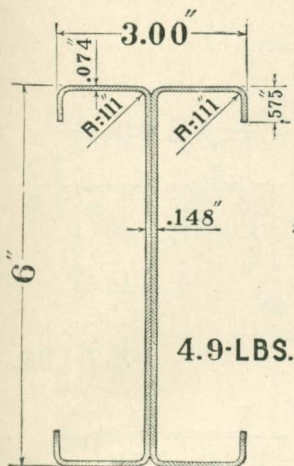

6"—4.9 lb.
I Joist

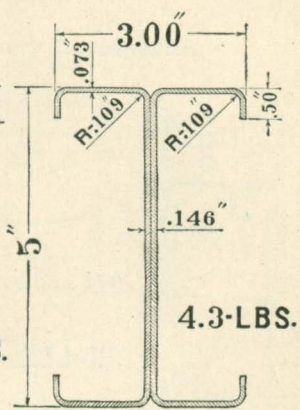

5"—4.3 lb.
I Joist

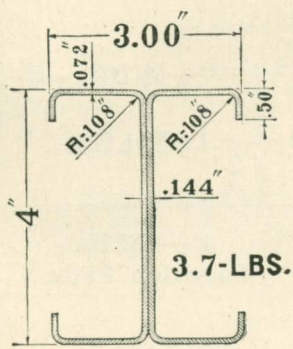

4"—3.7 lb. I Joist

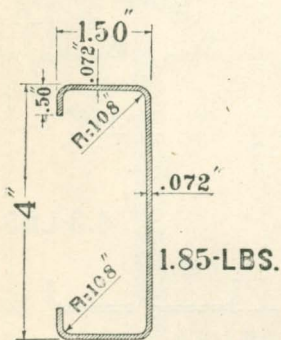

4"—1.85 lb.
Channel Stud

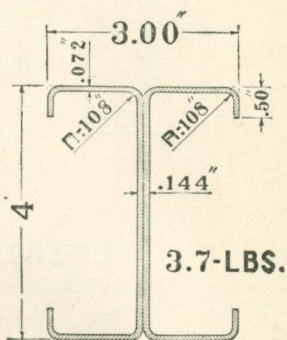

4"—3.7 lb.
I Stud

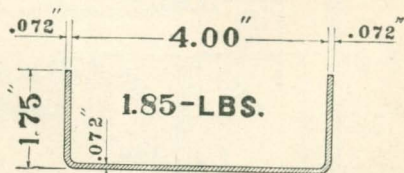

4"—1.85 lb.
Partition Plate

Steel Lumber Accessories

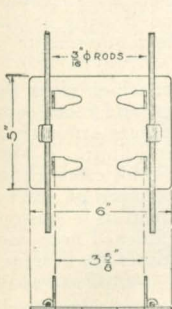

BEAM CLIP-A
FOR
4'-5'-6' & 7' STEEL JOIST.

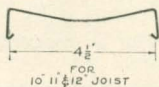

4 1/2"
FOR
10'-11' & 12' JOIST

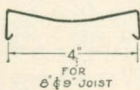

4"
FOR
6' & 9' JOIST

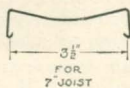

3 1/2"
FOR
7' JOIST

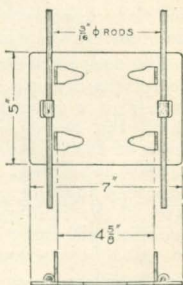

BEAM CLIP-B
FOR
6'-9'-10'-11' & 12' STEEL JOIST

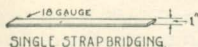

10 GAUGE
SINGLE STRAP BRIDGING

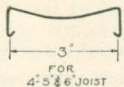

3"
FOR
4'-5' & 6' JOIST

SPRING LATH CLIPS

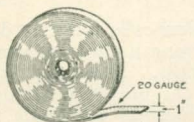

20 GAUGE
CONTINUOUS BRIDGING

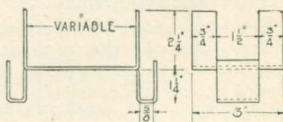

BEAM FURRING CLIP

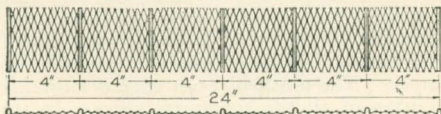

STEEL LATH

DESIGNING DATA

In designing Steel Lumber floor construction, the strength of the Steel Joists only is taken into account. The type of floor or ceiling finish has no bearing on the carrying capacity except as concerns the requirements of the span between joists.

Because of the method of production, which gives the steel extra heating and working, a refined and more compact fibre is secured, resulting in an ultimate strength of 72,000 lbs. per sq. inch with a high elastic limit. A fibre stress of 16,000 lbs. per sq. inch is used in all calculations in this handbook, which gives a high factor of safety. Repeated loading tests under official direction in various parts of the country have shown that a finished floor construction will carry approximately three times the designed live load before deflecting as much as $1/360$ of the span.

When supported on masonry walls the joists should have a bearing equal to one half their depth and not less than 4 inches. When supported on steel sections they should have a bearing not less than two inches. Joists should never be riveted to steel supporting members except where some special framing detail is required.

Reference to the cost curve, page 67, will indicate the more economical spans for any loading condition. These curves should be studied in designing panel sizes with the object of effecting the greatest economy consistent with architectural requirements.

Economy in building construction calls for that design which develops the requisite strength and measure of durability without waste of materials. Live load requirements should be consistent with the proposed occupancy and uniform dependability of structural materials to be used. Designed floor slab spans have a decided effect on building costs. Certain architectural features sometimes develop a structural cost exceeding any possible worth. Necessarily each project offers individual problems which demand careful study to insure efficient economy.

Structural designing involves careful comparison and analysis. The finished result should represent a balanced condition of all the structural parts. In this handbook an effort has been made to present such information as will enable the designer to lay out the structural features with the greatest resulting economy consistent with the architectural requirements.

Safe Loading Tables

EXPLANATORY NOTES

The National Steel Joist is a light weight member produced by an entirely different method and performs a different function than Rolled Structural Sections. All safe loading tables assume the steel joists to be braced laterally. This bracing being automatically taken care of in either the floor or partition construction by steel bridging, steel lath and concrete as called for in the specifications.

The method of production and the carbon content of material produces a steel with ultimate strength running uniformly over 70,000 lbs. per square inch with elastic limit uniformly over 60,000 lbs. per square inch. In all safe loading computations a fibre stress of 16,000 lbs. per inch has been used, thus giving a safety factor against the elastic limit of practically 4. In cases where code regulations permit, a fibre stress of 20,000 lbs. per sq. inch is amply safe giving due consideration to deflection limits.

To accommodate the 96-inch length of steel lath sheets four common spacings of steel joists have been developed as standard—12", 16", 19" and 24". The spring lath clip makes firm attachment at the end of the lath sheet and practically no lath is lost in end laps. The proper spacing of joists to be used is largely a matter of economical design, bearing in mind the use to which the floor is intended. Because of the concentrated loads which may be applied a garage floor should have the joists spaced as a rule not more than 16" c-c, while a school house or office building floor can be economically and safely constructed with joists 24" c-c. Wherever heavy concentrated loads may be applied it is advisable to check into the strength of the floor slab between joists (Table page 129).

Properties of Sections.—The properties given are calculated from the exact dimensions as shown on pages 24 to 33 inclusive. These properties being the basis of all computations for safe loadings.

Safe Loading Tables.—A Fibre stress of 16,000 lbs. per sq. inch has been used throughout except where correction is made for deflection, page 163, and for a Moment = $WL/8$. For continuous beam running over supporting girders use corrected loadings as per formulæ given (page 158). In all cases the loads shown include dead and live load. For dead load of floor see page 130.

Total Uniformly Distributed Loads.—This table shows the total uniformly distributed loads. Heavy lines show theoretical deflection limit of $1/360$ of the span (page 26).

Total Uniformly Distributed Loads Corrected for Deflection.—None of the loads shown on this table will give a deflection exceeding $1/360$ of the span (page 27).

Total Uniformly Distributed Loads per Square Foot of Floor Area.—For convenience in designing these square foot floor load tables have been developed for the four standard joist spacings. All of the loads shown will give a deflection less than $1/360$ of the span (pages 28-31).

Safe Partition Loads.—Where steel studs are used in partition construction with lath and plaster on both sides, the carrying capacity of the studs is based on the long radius of gyration (page 32).

Safe Strut Loads.—Where Steel Lumber Sections are used as struts without lath and plaster, safe loads are based on the short radius of gyration (page 32).

Web Crippling Values.—Safe loads uniformly distributed on the spans given in loading tables will not produce average shearing stresses in the web greater than 10,000 lbs. per sq. inch. In order to check web values for unusual conditions, information has been developed as shown in table (page 33).

PROPERTIES OF NATIONAL STEEL I JOISTS

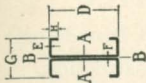

Depth D Inches	Weight per Ft. Pounds	Area of Section Sq. In.	Thickness of Metal		Width of Flanges		A—A			B—B			Depth D Inches
			E Inches	F Inches	G Inches	H Inches	I	S	R	I	S	R	
4	3.7	1.08	.072	.144	3.00	.50	2.57	1.28	1.54	.55	.37	.72	4
5	4.3	1.24	.073	.146	3.00	.50	4.44	1.77	1.90	.56	.37	.67	5
6	4.9	1.42	.074	.148	3.00	.575	7.11	2.36	2.23	.61	.40	.66	6
7	5.8	1.69	.076	.152	3.50	.575	11.49	3.28	2.61	.93	.53	.74	7
8	6.8	1.98	.078	.156	4.00	.625	17.67	4.42	3.00	1.40	.70	.84	8
9	7.7	2.24	.082	.164	4.00	.625	24.60	5.46	3.32	1.46	.73	.81	9
10	8.7	2.54	.087	.174	4.00	.625	33.60	6.72	3.64	1.54	.77	.78	10
10	9.5	2.79	.091	.182	4.50	.75	38.07	7.61	3.69	2.42	1.08	.94	10
11	10.7	3.16	.097	.194	4.50	.75	50.92	9.26	4.00	2.54	1.13	.90	11
12	12.0	3.52	.102	.204	4.50	.75	66.03	11.00	4.33	2.63	1.17	.87	12

I = Moment of Inertia S = Section Modulus R = Radius of Gyration

NATIONAL STEEL I JOISTS

Total Safe Loads in Pounds Uniformly Distributed.

Loads Given Include Weight of Construction.

Fibre Stress Not Exceeding 16,000 Lbs. per Square Inch.

Size	4"	5"	6"	7"	8"	9"	10"	10"	11"	12"	
Weight	3.7	4.3	4.9	5.8	6.8	7.7	8.7	9.5	10.7	12.0	
Clear Span in Feet	6'	2285	3158	4216	
	7'	1958	2707	3614	
	8'	1713	2368	3162	4375	
	9'	1523	2105	2811	3888	5244	6466	
	10'	1371	1895	2530	3500	4720	5820	7170	8120	9880	11720
	11'	1248	1721	2300	3180	4290	5290	6520	7380	8980	10680
	12'	1142	1579	2107	2918	3930	4850	5975	6770	8230	9790
	13'	1055	1458	1945	2690	3630	4480	5520	6250	7600	9040
	14'	980	1354	1805	2500	3370	4160	5120	5800	7060	8390
	15'	1262	1688	2330	3145	3880	4780	5420	6580	7830
	16'	1185	1580	2185	2950	3640	4480	5080	6170	7340
	17'	1115	1489	2060	2787	3422	4220	4780	5810	6910
	18'	1052	1405	1943	2620	3235	3985	4520	5480	6520
	19'	1332	1842	2482	3064	3770	4280	5200	6180
	20'	1265	1750	2360	2910	3585	4060	4940	5860
	21'	1665	2248	2770	3410	3870	4700	5590
	22'	1590	2142	2645	3260	3690	4480	5340
	23'	4290	5110
	24'	4115	4890
	25'	3950	4690
	26'	3800	4520

NOTE—For loads below horizontal lines, deflection is theoretically greater than the allowable limit for plastered ceilings (1/360 of the span).

The above safe loads assume that the joists are braced laterally as in the standard floor construction.

THE NATIONAL PRESSED STEEL COMPANY

NATIONAL STEEL I JOISTS

Total Safe Loads in Pounds Uniformly Distributed.
 Loads Given Include Weight of Floor Construction.
 Fibre Stress Not Exceeding 16,000 Lbs. per Square Inch.
 No Deflections Greater Than 1/360 of the Span
 Produced by the Given Safe Loads.

Size	4"	5"	6"	7"	8"	9"	10"	10"	11"	12"	
Weight	3.7	4.3	4.9	5.8	6.8	7.7	8.7	9.5	10.7	12.0	
Clear Span in Feet	6'	2285	3158	4216	
	7'	1958	2707	3614	
	8'	1713	2368	3162	4375	
	9'	1364	2105	2811	3888	5244	6466	
	10'	1103	1895	2530	3500	4720	5820	7170	8120	9880	11720
	11'	913	1575	2300	3180	4290	5290	6520	7380	8980	10680
	12'	768	1323	2107	2918	3930	4850	5975	6770	8230	9790
	13'	1128	1805	2690	3630	4480	5520	6250	7600	9040
	14'	973	1558	2500	3370	4160	5120	5800	7060	8390
	15'	1358	2190	3145	3880	4780	5420	6580	7830
	16'	1192	1925	2950	3640	4480	5080	6170	7340
	17'	1705	2625	3422	4220	4780	5810	6910
	18'	1520	2340	3235	3985	4520	5480	6520
	19'	2100	2918	3770	4280	5200	6180
	20'	1895	2638	3585	4060	4940	5860
	21'	2395	3280	3720	4700	5590
	22'	2178	2990	3390	4480	5340
	23'	3100	4130	5110
	24'	2840	3790	4890
	25'	2620	3500	4530
26'	2420	3230	4190	

NOTE—The above safe loads assume that the joists are braced laterally as in the standard floor construction.

NATIONAL STEEL I JOISTS

Total Safe Loads in Pounds per Square Foot of Floor Area.

Loads Given Include Weight of Floor Construction.

Fibre Stress Not Exceeding 16,000 Lbs. per Square Inch.

No Deflections Greater Than 1/360 of the Span

Produced by the Given Safe Loads.

JOIST SPACED 12" ON CENTERS

Size	4"	5"	6"	7"	8"	9"	10"	10"	11"	12"	
Weight	3.7	4.3	4.9	5.8	6.8	7.7	8.7	9.5	10.7	12.0	
Clear Span in Feet	6'	381	527	703	
	7'	280	387	516	
	8'	214	296	395	547	
	9'	152	234	312	432	583	718	885	
	10'	110	190	253	350	472	582	717	
	11'	83	144	209	289	390	481	593	
	12'	64	110	176	243	328	404	498	
	13'	87	139	207	279	345	425	482	585	695
	14'	70	111	179	241	297	366	414	504	598
	15'	91	146	210	258	318	361	438	522
	16'	75	120	184	228	280	318	386	458
	17'	100	154	202	248	281	342	406
	18'	84	130	180	222	251	304	362
	19'	110	153	198	225	274	325
	20'	95	132	179	203	247	293
	21'	114	156	177	224	266
22'	99	136	154	204	242	
23'	135	179	222	
24'	118	158	204	
25'	105	140	181	
26'	93	124	161	

NOTE—The above safe loads assume that the joists are braced laterally as in the standard floor construction.

THE NATIONAL PRESSED STEEL COMPANY

NATIONAL STEEL I JOISTS

Total Safe Loads in Pounds per Square Foot of Floor Area.

Loads Given Include Weight of Floor Construction.

Fibre Stress Not Exceeding 16,000 Lbs. per Square Inch.

No Deflections Greater Than 1/360 of the Span
Produced by the Given Safe Loads.

JOISTS SPACED 16" ON CENTERS

Size	4"	5"	6"	7"	8"	9"	10"	10"	11"	12"	
Weight	3.7	4.3	4.9	5.8	6.8	7.7	8.7	9.5	10.7	12.0	
Clear Span in Feet	6'	286	395	526	
	7'	210	290	387	
	8'	161	222	297	410	
	9'	114	176	234	324	
	10'	83	142	190	263	354	437	538	608	
	11'	62	108	157	217	292	361	445	503	
	12'	48	83	132	183	246	303	374	423	
	13'	...	65	104	155	210	259	319	361	438	521
	14'	...	52	84	134	181	223	275	311	378	448
	15'	68	110	158	194	239	271	328	392
	16'	56	90	138	171	210	238	289	344
	17'	75	116	151	186	211	257	305
	18'	63	98	135	166	188	228	272
	19'	83	115	149	169	205	244
	20'	71	99	135	152	185	220
	21'	85	117	133	168	200
22'	74	102	116	153	182	
23'	101	135	167	
24'	89	118	153	
25'	79	105	136	
26'	70	93	121	

NOTE—The above safe loads assume that the joists are braced laterally as in the standard floor construction.

NATIONAL STEEL I JOISTS

Total Safe Loads in Pounds per Square Foot of Floor Area.

Loads Given Include Weight of Floor Construction.

Fibre Stress Not Exceeding 16,000 Lbs. per Square Inch.

No Deflections Greater Than 1/360 of the Span

Produced by the Given Loads.

JOIST SPACED 19" ON CENTERS

Size	4"	5"	6"	7"	8"	9"	10"	10"	11"	12"	
Weight	3.7	4.3	4.9	5.8	6.8	7.7	8.7	9.5	10.7	12.0	
Clear Span in Feet	6'	241	332	443	
	7'	177	244	326	
	8'	135	187	250	346	
	9'	96	148	197	273	
	10'	70	120	160	222	298	368	452	513	
	11'	53	90	132	183	247	304	375	423	
	12'	41	70	111	153	207	256	315	356	
	13'	55	88	131	176	218	269	304	369	439
	14'	44	70	113	152	188	231	262	318	378
	15'	57	92	132	163	201	228	277	329
	16'	47	76	116	144	177	200	244	290
	17'	63	98	127	157	177	216	257
	18'	53	82	114	140	159	192	229
	19'	70	97	126	142	173	206
	20'	60	83	113	128	156	185
	21'	72	99	112	141	168
	22'	62	86	97	129	153
23'	85	114	140	
24'	75	100	129	
25'	66	88	114	
26'	59	78	102	

NOTE—The above safe loads assume that the joists are braced laterally as in the standard floor construction.

NATIONAL STEEL I JOISTS

Total Safe Loads in Pounds per Square Foot of Floor Area.

Loads Given Include Weight of Floor Construction.

Fibre Stress Not Exceeding 16,000 Lbs. per Square Inch.

No Deflections Greater Than 1/360 of the Span

Produced by the Given Loads.

JOISTS SPACED 24" ON CENTERS

Size	4"	5"	6"	7"	8"	9"	10"	10"	11"	12"
Weight	3.7	4.3	4.9	5.8	6.8	7.7	8.7	9.5	10.7	12.0
6'	191	264	351
7'	140	194	258
8'	107	148	198	274
9'	76	117	156	216	292	359
10'	55	95	127	175	236	291	359	406
11'	42	72	105	145	195	240	296	335
12'	32	55	88	122	164	202	249	282
13'	43	70	104	140	172	212	240	292	348
14'	35	56	89	120	149	183	207	252	299
15'	45	73	105	129	159	180	219	261
16'	37	60	92	114	140	159	193	229
17'	50	77	100	124	140	171	203
18'	42	65	90	111	125	152	181
19'	55	77	99	113	137	162
20'	47	66	90	101	123	146
21'	57	78	89	112	133
22'	49	68	77	102	121
23'	67	90	111
24'	59	79	102
25'	52	70	91
26'	47	62	81

NOTE—The above safe loads assume that the joists are braced laterally as in the standard floor construction.

NATIONAL STEEL PARTITION STUDS

Total Safe Load in Pounds for Each Stud. Using Column Formula for Fibre Stress.

$(f-19000 \text{ lb.} - \frac{100f}{r})$ with Max. of 13000 lb. per Sq. Inch

R, About Axis A-A is for Studs Plastered both sides.

R, About Axis B-B is for Unplastered Studs.

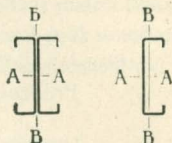

Axis A-A Plastered Both Sides			Axis B-B Unsupported Studs		
Size	4" C	4" I	4" C	4" I	Size
Weight	1.85	3.7	1.85	3.7	Weight
2	6980	13975	2
3	6680	13975	3
4	5500	13200	4
5	4320	11420	5
6	6988	13975	3140	9640	6
7	6988	13975	1980	7840	7
8	6864	13728	806	5988	8
9	6425	12850	4200	9
10	6025	12050	2370	10
11	5600	11200	11
12	5180	10360	12
13	4775	9550	13
14	4360	8720	14
15	3925	7850	15
16	3510	7020	16
17	3090	6180	17
18	2685	5370	18
19	2260	4520	19
20	1830	3660	20

Safe load values above horizontal lines are for ratios of l/r not over 120.

No loads given for ratios of l/r greater than 200.

Web Resistance Values

d		t	V	R	
Depth of Joist	Weight Per Foot	Single Thickness of Web	Allowable Web Shear	Allowable Buckling Resistance	Results of Test (Average)
Inches	Pounds	Inches	Pounds	Pounds	Pounds
4	3.7	.072	5760	3410	8760
5	4.3	.073	7300	3420	7470
6	4.9	.074	8880	3340	7660
7	5.8	.076	10640	3330	6340
8	6.8	.078	12480	3320	6620
9	7.7	.082	14760	3540	7380
10	8.7	.087	17400	3860	7750
10	9.5	.091	18200	4350	8630
11	10.7	.097	21340	4840	9370
12	12.0	.102	24480	5230	9970

Example explaining method of computation shown on page 34.

WEB RESISTANCE

The web of a steel joist differs from the web of a structural section in that it is composed of two pieces. The question naturally rises as to whether the two parts of the web will act together and give the same results as one piece of the same total thickness. Theoretical analysis of the web acting as a beam indicates, and loading tests prove, that in the consideration of bending moments and horizontal shear the results are the same as in a one piece web. The reverse is true, however, in resistance to buckling.

One column in table, page 33 shows the results of tests to the elastic limit. This series of tests were run on sections four feet long. Each sample was supported at each end and the load applied at one end of the joist. This condition exactly duplicated the loading which would be applied on the joists by a bearing partition and developed the web resistance to direct crushing load. The figures given are for the elastic limit which was always evidenced by the dropping of the machine scale arm when that point was reached.

Each result given represents the average of six test pieces. The samples were cut with the spot welds at various distance from the end. The location of the spot weld made no difference in the results, all the figures running very uniform.

Theoretical analysis indicates that in this regard the web of a steel joist should be considered as two separate sections. It is true that the welds hold the channel webs together and that they work in unison, but for ample safety in design we recommend they be considered as operating independently.

With the above in mind and wishing to determine the total shear in pounds due to end reaction, the following formula is developed.

d—total depth of joists
t—thickness of strip

Taking Cambria formula for total shear due to end reaction	$\frac{12000 \ d t}{c^2}$ $1 + 3000 \ t^2$
---	--

As there are no fillets at the angle of flange and web in the steel joist, the total depth of joist is used. $d = c$.

THE NATIONAL PRESSED STEEL COMPANY

The web is considered as two columns each with a thickness of (t)

Then

Total Resistance to Buckling

$$R = \frac{2 \times 12000dt}{1 + \frac{d^2}{3000 t^2}} = \frac{24000 dt}{1 + \frac{d^2}{3000 t^2}}$$

The results for safe buckling due to end action in table, page 33 are computed on this formula.

It is interesting to note that in the test above mentioned all the samples when submitted at a later date, to a second, identical test loading, developed from seventy-five to eighty per cent of their original strength.

All tables of safe loads for National Steel Joist sections are calculated on the assumption that proper provision is made to prevent lateral deflection and turning of the sections.

Such condition is provided in the standard floor construction where the joists will in every instance exceed the loading values given.

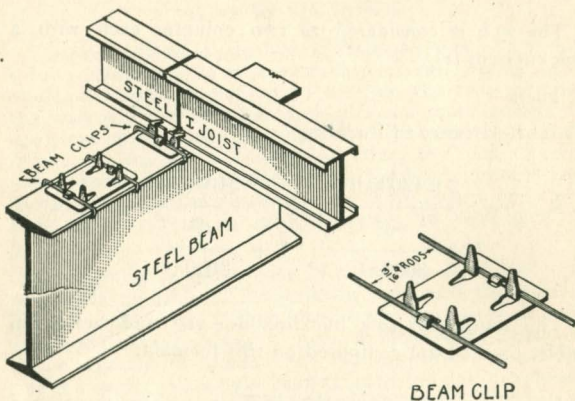

BEAM CLIPS

Where steel joists rest directly on top of rolled steel beams it is advisable that joist be held in place by a clip as illustrated above.

The clip serves to securely anchor the joist to the beam, to preserve correct spacing and otherwise prevent all movement of joists during installation.

In roof construction, in floors over basement, or wherever projection of beams is permissible, joists should rest on the top flange, thereby eliminating the cost of shelf angles and fabricating expense on beams.

The same clip may be used to secure joists to top chord of roof trusses and to flange of riveted girders.

Clips are quickly attached to beams by the simple operation of bending ends of rods down and under the beam flange.

Table on next page gives proper size of clip required for different Rolled Steel beams.

Beam Clips are made from No. 14 Ga. (.083"), black strip steel.

THE NATIONAL PRESSED STEEL COMPANY

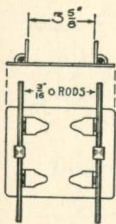

CLIP "A"
for
4" 5" 6" & 7" Steel I Joist

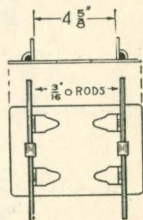
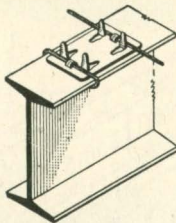

CLIP "B" for
8" 9" 10" 11" & 12"
Steel I Joist

Beam Clips for Various Sizes Steel I Joists and Structural Steel Beams

Beam Clip Designation Mark		Length of Rods	Structural Steel Beams		Weight per 100 Pieces A	Weight per 100 Pieces B
			Standard	Bethlehem		
A	B	9"	10"—I	8"—I	80	90
			12"—I	9"—I		
			15"—I			
A	B	10"	18"—I	10"—I	80	90
			20"—I	12"—I		
A	B	11"	42"—I	15"—I	80	90
A	B	12"	18"—I	85	95
				20"—I		
A	B	13"	24"—I	85	95
A	B	14"	26"—I	85	95
				28"—I		

When ordering beam clips give A or B designation mark, also length of rods as "A—9" or "B—9."

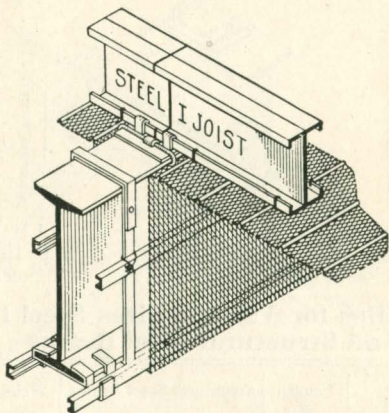

BEAM FURRING CLIPS

To properly fireproof rolled steel beams, the steel lath should be furred away so as to secure an air space between plaster and beam. This is accomplished by the use of beam furring clips illustrated above which are securely fastened to the I beam by bending leg of clip over the beam flanges.

Three-quarter inch channels are supported on the seat of clip and held in a manner to prevent contact of fireproofing with beam and also to insure a true form for beam and straight edge for application of lath and plaster.

Clips should be spaced not to exceed 30" centers along the beams.

Table on next page shows size of clip required for various Rolled Steel Beams.

Beam Furring Clips are made from No. 15 Gauge (.072") black strip steel.

THE NATIONAL PRESSED STEEL COMPANY

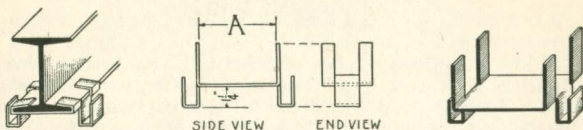

Beam Furring Clip for Various Sizes of Structural Steel Beams

Designation Mark	Dimension A	Structural Steel Beams		Weight per 100 pcs.
		Standard	Bethlehem	
F—3	3 "	4"—I@ 10.5 5"—I@ 10.0		50
F—3½	3½ "	5"—I@ 14.75 6"—I@ 14.75		53
F—4	4 "	7"—I@ 20.0 8"—I@ 18.4		57
F—4½	4½ "	9"—I@ 21.8		60
F—5	5 "	10"—I@ 25.4 12" I@ 31.8		63
F—5½	5½ "	12"—I@ 40 15"—I@ 42.9	8"—I@ 17.5 9"—I@ 20	67
F—6	6 "	15"—I@ 60 18"—I@ 54.7	10"—I@ 23.5	70
F—6½	6½ "	20"—I@ 65.4	12"—I@ 28.5 12"—I@ 36	73
F—7	7 "	20"—I@ 80 24"—I@ 80	15"—I@ 38 15"—I@ 54	76
F—8	8 "	24"—I@ 105	20"—I@ 59	83
F—9	9 "	24"—I@ 74 27"—I@ 90	20"—I@ 72 24"—I@ 73	89
F—10	10 "		28"—I@ 105	96

When ordering Beam Furring Clips give designation mark as "F—7."

STEEL LATH

There are many types of Steel Lath made in various gauges, and each type possessing distinctive merit for some specific purpose. Few of the various types are particularly well qualified, however, for use with Steel Lumber. When choosing a lath for that purpose the following points should be considered:

Rigidity	Size of sheet
Area of openings	Gauge and weight
Key	Ease of handling
Plastering surface	Adaptability

In considering the rigidity of a lath the joist spacing on the job in question is a deciding factor. As any installation is apt to use at some point a 24" joist spacing it is well to pick a lath adapted for that condition. Certainty of satisfaction on the closer centering is then assured. The term rigidity means supporting strength. The measure of rigidity of a lath is the amount of deflection under load or pressure.

To visualize the importance of rigidity examine a normal condition resulting from the use of many types of lath. Assume joist spacing 24" and a lath deflection of $2\frac{1}{2}$ " at the center under application of 2" of wet concrete. This loss of concrete means an added thickness averaging 1 inch for every square foot of floor area. The cost of this concrete waste at least equals the cost of the lath. The use of a cheap lath should always be guarded against as the resulting loss in concrete will amount to many times the saving in the cost of lath.

When applied to ceilings there is nothing so detrimental to good rapid plastering as a lath that "springs," deflects under pressure of the trowel. On the other hand, a good, rigid steel lath with a mesh design which holds fresh plaster is the best plastering surface obtainable.

The best results in connection with Steel Lumber on all spacings will always be secured by using a Ribbed Lath. The same lath should always be used on both floors and ceilings. They are equally important.

The area of the mesh openings affects the amount of plaster used and if too large, will permit floor slab concrete to run through the mesh. The area of opening is controlled by the percentage of expansion, the width of strands and the position of the strands. In some laths

THE NATIONAL PRESSED STEEL COMPANY

where the opening area is very large the expansion has been carried to the point where the strand metal is past the elastic limit. Any further stress applied in handling or installing will break many strands. The width of strands is important for the reason that a narrow cut strand will not hold fresh plaster, neither does it have the lateral stiffness so important to the lather in handling. The position of the strand refers to whether it lies vertical or horizontal. If the strand presents a cutting edge to the plaster it decreases the necessary pressure of applying. Neither a vertical or horizontal strand gives best results in this regard. The horizontal strand gives the strongest key and better holds fresh plaster. The most efficient position is slightly tilted from horizontal thus presenting cutting edge to plasterer and at the same time retaining the fresh plaster.

The shape of the mesh is important. Long rectangular meshes being very wasteful. Experience has proven that the most practical and serviceable mesh is the so-called "Diamond" design, with clear dimensions not exceeding $1\frac{1}{4}$ " by $\frac{9}{32}$ ".

If in installation the lather can place a wider sheet of one lath in the same time that he would place a narrow sheet of another, the results are lower lathing costs. Also the loss on side laps and time in lap wiring is decreased. The lateral stiffness of a lath determines the width of sheet that can be efficiently handled. Lateral stiffness being dependent on the mesh design and gauge of metal. A lath easily handled in a 24" by 96" sheet is the most practical.

What is called the body of the lath is directly dependent on its gauge. Gauge also is the important factor for durability under every circumstance. The weight of lath determines the strand width for any particular design and gauge. In connection with Steel Lumber a 24 gauge ribbed Diamond mesh lath weighing 4 lbs. to the sq. yd. will always give good service. In many places for 16" joist spacing the same lath, made of 26 gauge steel and, weighing 3 lbs. to the square yard. is ample.

If a lath is so designed as to be easy to handle, with no ragged, sharp, cutting edges in the mesh it will be erected more economically and satisfactorily. If the same design, weight and gauge of lath will economically meet every condition of loading and spacing of supports, the erection problem is greatly simplified. A lath easily

installed and universally adapted to all joist spacings, whether used in floors, ceilings or walls, functioning with a minimum of deflection, and giving the greatest reinforcing value to both plaster and floor slab concrete, is the best in combination with Steel Lumber.

We recommend the universal use of 24 gauge ribbed, Diamond mesh lath, weighing not less than 4 pounds to the sq. yard. For mesh and other general dimensions refer to page 21. A number of good laths will serve the purpose equally well but the adopting of this design as a comparative standard will result in good material and greater satisfaction with Steel Lumber construction. On 16" spacing under most conditions, the same design of lath in 26 gauge, weighing 3 pounds to the square yard, is satisfactory.

METHOD OF APPLYING RIBBED DIAMOND MESH STEEL LATH

Floors:

Lath should be applied with ribs up, the sheets running at right angles to direction of joists and fastened by means of spring clips illustrated on page 47. The lath should be secured every 12 inches, that is three clips be used across the lath at each joist, one clip at center of sheet and one clip at each side. Side lap should be made by nesting the outside rib of lath. This provides an effective covering width of 24 inches for each sheet. The lap at ends of sheet should occur over the center of joists. By springing clips over the ribs greater rigidity is secured.

Ceilings:

Ceiling lath should be applied with ribs up and secured to the joists by means of spring clips illustrated on page 45. End and side laps should be accomplished in same manner as described above for floor lath. Care should be taken to wire the edges of the two sheets midway between the joists so that the sheets cannot separate when plaster is applied. At the junction of ceiling and wall it is good practice to run ceiling lath down wall a distance of 6 inches, this for the purpose of reinforcing plaster at that point and preventing cracks.

Partitions:

Steel lath is secured to Steel Lumber Channel Studs by wiring through holes punched in flanges for that purpose. This punching of the Channel Studs is usually done in the field by a hand punch, sometimes at fabricating plant, depending on arrangements made. (Punching never done at the mill.) Lath should be carefully attached at edges and at intervals of 6 inches along the studs. The ends of sheets on partition construction should be staggered alternately to provide additional lateral bracing for the studs during erection.

Where plain channels, angles or other forms of supports are provided either in partition construction or in beam or column furring, steel lath is tied to the support with No. 18 gauge, galvanized tie wire, at intervals of approximately 6 inches or as required to provide a firm and rigid surface to receive the plaster.

General:

The standard spacing as established for joists, published elsewhere in handbook, provides for the economical use of a standard 96" sheet of Steel Lath without waste. When supports are spaced not to exceed 24-inch centers a 24 gauge ribbed Diamond mesh lath, weighing not less than 4 lbs. per square yard, is sufficiently rigid to support a concrete slab or plaster ceiling without intermediate support or centering.

Note:

When joist spacing is such that the ends of the lath sheets butt at centre of joist without lapping, the spring lath clip holds the lath rigidly. When lath is being nailed to the joist then each lath sheet must cover the center of joist. The spring lath clip in this way saves waste of lath at end laps. Page 47.

SPRING CLIPS

The adoption of Spring Clips for fastening steel lath to Steel Joists has been an important development in Steel Lumber Construction. The old-fashioned prongs or the regularly spaced holes punched from the joist flange, both of which reduce the strength of the section and add to manufacturing costs, are eliminated. The top and bottom flanges, therefore, are identical and being symmetrical the joists can be handled with greater facility and more quickly erected without regard for top or bottom side.

Spring Clips are made from highest grade spring steel, heat treated and oil tempered to provide proper degree of toughness and strength. The clips are so shaped as to fit the joist flange, the convex center pressing upon the flange provides the elasticity which firmly holds the lath to the joist after clip is sprung into place. As the clip is supported at the outer edge of the joist it extends entirely across the flange, thereby giving the widest possible support for the lath as well as reducing to a minimum the net span of the lath.

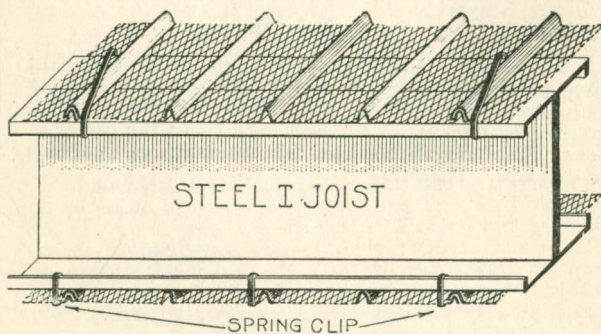

Clips Sprung Over Ribs

Applying Spring Lath Clips

A diamond mesh rib lath as described on pages 40 to 42 is recommended for universal use in connection with Steel Lumber. This lath lends itself to the use of spring clips as the clips can be applied over the ribs, thereby providing a much firmer fastening for the lath, also the clips can be more easily and quickly inserted through the diamond shaped meshes than is possible with other types of lath.

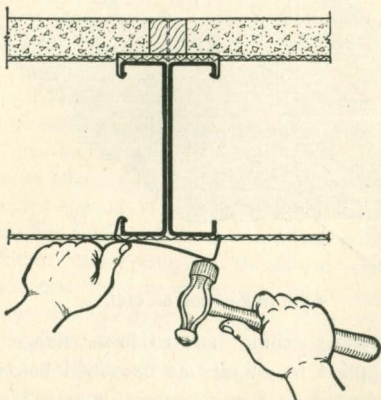

The method of attaching the clip is extremely simple. One end of the clip is passed through the mesh of the lath and hooked over the small vertical flange of the joist. With the clip in this position pass the other end through the lath in like manner. Tap the free end of clip lightly with a hammer, forcing the angle end of clip to extend through lath and hook itself over vertical joist flange.

The spring clip fits snugly up against the lath and is so designed as to equalize any differences in length of the secondary flanges on the steel joists.

Spring Lath Clips Used on Ceilings

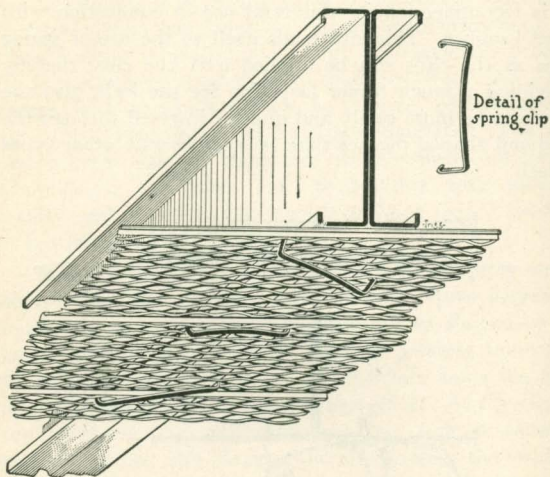

Lath in Position on Ceiling

For fastening ceiling lath to lower flange of joist, clips are applied in manner as described before. They should be spaced on 8-inch centers or over every other rib (when ribs are spaced 4 inches center to center). Where lath sheets lap at sides the clip should be applied over both ribs after they are nested. This practice results in more economical use of clips, at same time provides more rigidity in the lath and a smoother ceiling for the application of plaster.

When joists are spaced 24 inches on centers it is advisable to wire the edges of the two sheets midway between the joists so that sheets cannot separate when plaster is applied.

Spring Lath Clips Used on Floors

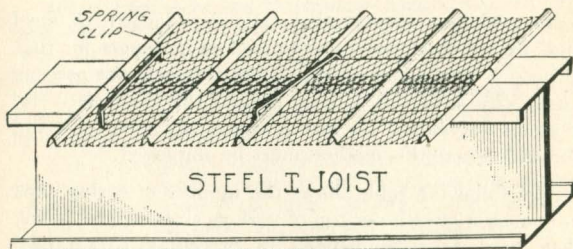

Lath Sheets Lapped

The use of spring clips on floors is recommended in preference to the older method of nailing into web of joist. The clip is more easily and rapidly applied and decidedly more effective in making a secure fastening for the lath. Clips spaced 12 inches on centers along joists or three clips for each 24-inch sheet of lath will securely hold the lath in place. One clip should be applied over center rib and one clip over rib at side where lap is made by nesting the ribs of adjoining sheets. The clip holding the middle of sheet should alternate on different ribs and where end of lath sheet butts or laps over joist it is advisable to use two clips instead of one to fasten middle of sheet.

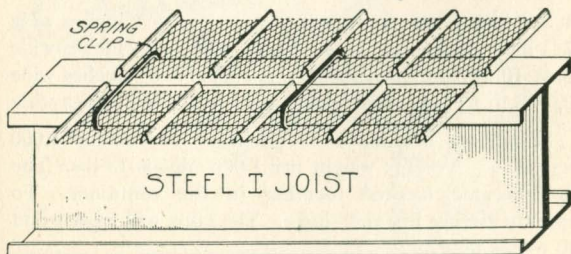

Lath Sheets Butted

Partitions:

In partition construction lath is attached to steel studs by wiring through holes punched in flanges for that purpose or when hot or cold rolled channels are used as studs, wire is passed entirely around the channels. No. 18 gauge galvanized tie wire is commonly used for tying steel lath where this method must be employed.

The following table shows the number of spring clips for one layer of lath per ton of various sizes of steel joists, when used as recommended in preceding paragraphs. Quantity includes five per cent for waste.

Number of Clips Required per Ton of Joists

Size of Joist	Weight per foot	Floors 12" C. to C.	Ceilings 8" C. to C.
12	12.0	180	265
11	10.7	200	295
10	9.5	220	330
10	8.7	240	360
9	7.7	275	410
8	6.8	310	465
7	5.8	365	545
6	4.9	430	645
5	4.3	490	735
4	3.7	567	850

Clips for various depth of joists are furnished in sizes as listed below:

- 4, 5, 6 inch joists.....3 inches wide
- 7 inch joists.....3½ inches wide
- 8, 9, 10, (8.7 lb.) inch joists.4 inches wide
- 10, (9.5 lb.) 11, 12 inch joists.....4½ inches wide

Shipments are made in packages containing 1,000 clips each. Average weight per 1,000 clips is 13 lbs. The clips become meshed together in the container. To separate simply lift and shake. The clips will loosen and fall to the floor.

BRIDGING

Many Engineers and Architects believe that in steel joist construction the concrete slab above the joists gives sufficient distribution of concentrated loads for ordinary light occupancy buildings. We recommend, however, that bridging be used and particularly on the deeper joists. For the smaller joists on short spans and close spacing bridging is not required.

The function of bridging is twofold. First, to hold the joists in an upright position and maintain the spacing prior to the placing of the lath. Second, to provide lateral rigidity and distribute concentrated loadings during the life of the building.

To efficiently function for the first requirement the bridging does not need to be tight. If fastened to the top of the joists and installed more or less loosely as shown in sketch "A", Page 53 it will hold the joists in place during that period before the installation of lath. Bridging installed in this manner is of no value after completion of the floor.

For the bridging to provide lateral stiffness and aid in the distribution of loads it must be straight and taut between joists. Installed as shown in sketch "B," Page 53.

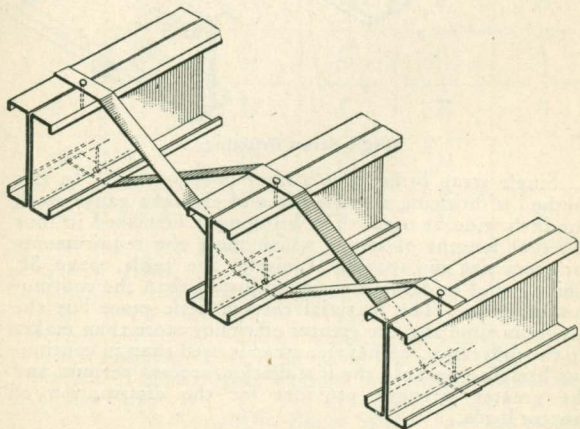

Continuous Bridging

There are two types of bridging. Continuous bridging has been used for a number of years. This material is twenty gauge steel one inch wide, furnished in coils. The continuous bridging is woven through the joists across the panel, then tightened up by pulling out the slack. This is a difficult operation and good work is secured only by giving it careful attention. In this method the bridging is secured to the joists by nailing through the bridging into the joists both top and bottom.

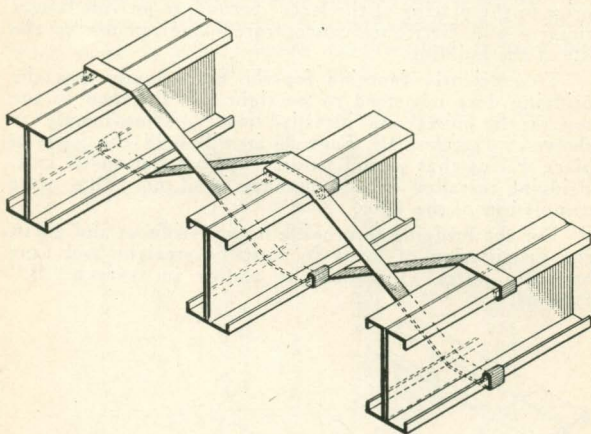

Single Strap Bridging

Single strap bridging is a later development. In this method of bridging a single piece of eighteen gauge steel, one inch wide, is used. The bridging is furnished in four different lengths of straps which meet the requirements for every size and spacing of joists. See table, page 51. This type of bridging is easier to install than the continuous bridging. The material costs a little more but the saving in time and the greater efficiency more than makes up the difference. A heavier strap is used than in continuous bridging because the installation process permits and the greater strength provides for the distribution of greater loads.

SINGLE STRAP BRIDGING

Designation Letter
for
Standard Bridging Lengths
Strap A—34½" long.
Strap B—31½" long.
Strap C—27½" long.
Strap D—24" long.

Steel Joists		Spacing of Joists—Center to Center			
Size	Weight	12"	16"	19"	24"
4	3.7	D	D	C	B
5	4.3	D	D	C	B
6	4.9	D	D	C	B
7	5.8	D	D	C	B
8	6.8	D	C	C	A
9	7.7	D	C	B	A
10	8.7	D	C	B	A
10	9.5	C	C	B	A
11	10.7	C	B	B	A
12	12.0	C	B	B	A

When ordering, give designation letter, as Strap "A."
Single Strap Bridging shipped in bundles containing
25 straps each.

Furnished in No. 18Ga. Black Steel. Average weight
per bundle, 10 lbs.

Installing Single Strap Bridging

To install single strap bridging lay the end of the strap over the top of a joist as in sketch "C." Bend about $1\frac{1}{2}$ " at the end down at right angles. On the other side of the joist bend the strap down approximately in line with the bottom of the next joist. Then as in sketch "D" put the bent end of the strap under the next joist. Bend the end clear around the lip or secondary flange of the joist. Pull the strap tight and bend down as shown by dotted line over the top of next joist. The bridging can be bent tight around the lip of the joist by using a claw hammer or other tool as shown by sketch "E."

In bridging a panel, first have the temporary wood strip in place near each line of bridging. Have each end joist in the panel anchored as shown on page 55. Then put clear across the panel all the straps of the bridging which run in the same direction. Start back with the cross straps, using the same method of applying. See sketch "F."

Before clinching the bridging to the top of each joist use a bar as shown by sketch "F." With this bar pry the bottom of the joist "a" toward the joist "b". After the bridging strap is clinched relieve the pressure and the bridging between those joists, including both straps, is very tight. The tightness of the bridging depending upon how much pressure is exerted on the bar. Care should always be taken to see that the joists are not pried out of a vertical alignment.

See that the straps are well clinched around each lip. The bridging can then be nailed to the joists the same as in continuous bridging, but this is not necessary.

Bridging put on in this manner will always give a good workmanlike job. The material will function in every respect. It cannot come loose or slip from the joists lips, particularly after the floor concrete and ceiling plaster have been placed.

THE NATIONAL PRESSED STEEL COMPANY

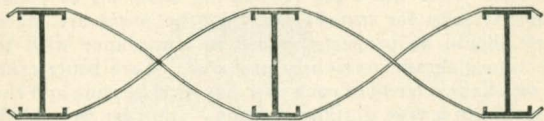

SKETCH-A

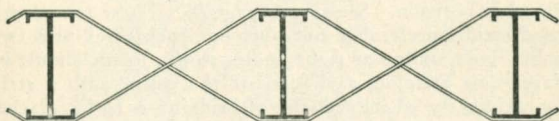

SKETCH-B

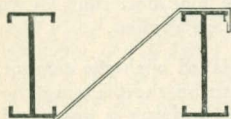

SKETCH-C

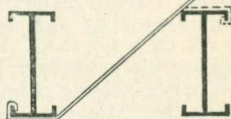

SKETCH-D

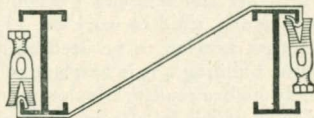

SKETCH-E

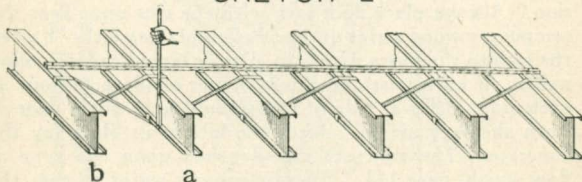

SKETCH-F

INSTALLING STEEL JOISTS

Steel joists leave the fabricating shop cut to proper lengths ready for installation. As the joists are placed they should be properly spaced in accordance with the erection diagram previously prepared. Care being taken to see that each end of each joist has level bearing and that they are in a true upright position. In order to hold the joists in place strips of wood should be temporarily nailed to the top of the joists immediately after they have been placed in position. See sketch page 55. These temporary wood strips, preferably not over one inch thick and two inches wide, nailed at right angles to the joists, should be placed one strip at each end of the joists and a strip approximately where each line of bridging is to be placed. The purpose of these strips is to save work of respacing and relining the sections, to hold the joists rigid while bridging is installed and make the floor more rigid for working on before lath and concrete are applied.

After the joists have been placed with the temporary wood strips holding them in position the bridging should be installed. Installation of the bridging is described on page 52.

With the bridging and temporary wood strips in place the panel is sufficiently rigid to work on. Lay temporary sheathing over that portion to be used and proceed with other work on the building. It is best not to place the floor lath until shortly before ready to lay concrete, as the lath catches any debris which falls from work above. Before placing floor lath see that the joists are in a vertical position. Always place floor lath with the ribs up. Tear the temporary wood strips up just before placing lath. Fasten the lath to the joists with lath clips or large headed roofing nails. At each joist one clip in center of sheet and one at each side. Clip at side of lath should hold down edge of both sheets, page 44. After the lath is in place lay the concrete. The concrete mix depends upon the type of floor finish, page 143. Use just enough water so that the mix will not run through the lath. Never use gravel passing through a screen larger than $\frac{3}{4}$ ". Ceiling lath is then erected and slab is ready for ceiling plaster.

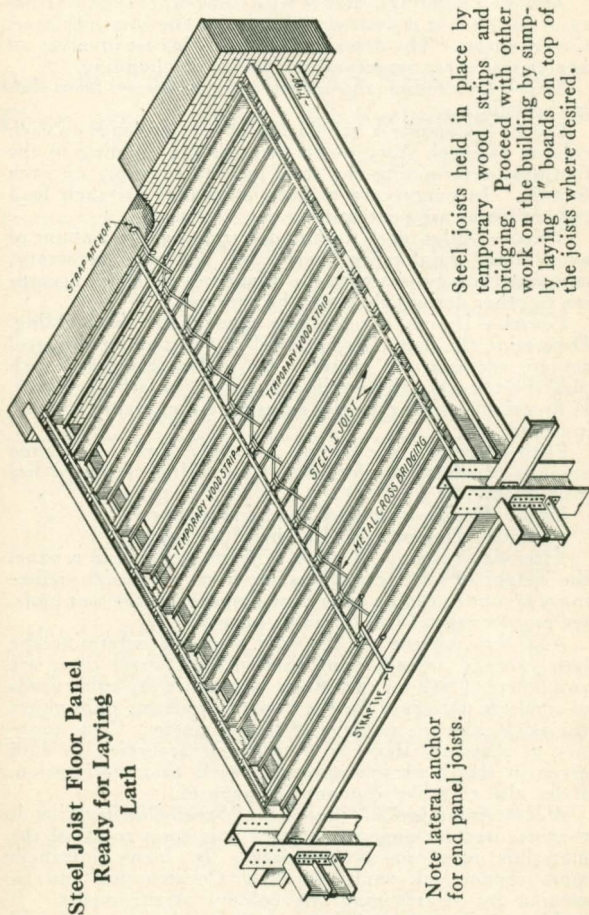

Steel Joist Floor Panel
Ready for Laying
Lath

Note lateral anchor
for end panel joists.

Steel joists held in place by temporary wood strips and bridging. Proceed with other work on the building by simply laying 1" boards on top of the joists where desired.

ESTIMATING DATA

Assume a building designed with some other type of structural layout. It is desired to determine the cost with Steel Construction. The determination of this cost involves an analysis of every structural portion of the building.

First—Determine the exact area of every floor slab in the building.

Second—Compile a tabulation of column loads on each column for each story down through the building to the footings, determining the total loading to apply on each footing. In every case making allowance for such load reductions as are permissible.

Third—Design each footing determining the amount of excavation, reinforcing steel and concrete necessary, compare these results with the quantities called for according to other designs that may be specified.

Fourth—Design the columns throughout the building. Determine the materials involved in fireproofing the steel column sections. If columns are to be fireproofed with plaster on Steel Lath compile the yardage of lath necessary. If fireproofed with clay tile determine the quantity of tile involved.

Fifth—Design supporting beams and determine amount of materials involved in providing required fire protection.

Sixth—Design stairways and window lintels.

Seventh—Design Steel Lumber floor slabs.

After determining the size of joists required in a panel the weight of joists can be taken from an actual preliminary layout or can be determined on the square foot basis, see graphs pages 58 to 61, table page 57.

Add five percent to the floor areas to determine the lath yardage, remembering that in most cases there are two layers of lath for each floor. Compute the cubic yards of concrete necessary for the two inch concrete slabs above the joists, also the yardage of ceiling plaster. The quantity of accessory items is determined according to data given in this book in connection with their description. Refer also to table of quantities page 62.

A determination of the cost of Steel Construction is then secured by applying correct unit costs to all of the materials involved as indicated. In many instances more economical results in Steel Construction can be secured by re-arranging the column arrangements. If architectural considerations permit advantage should be taken of such economical opportunities.

Pounds of Steel I Joist per Square Foot of Floor Area Required for Various Spacings

National Steel I Joist Section	Lineal Feet of Joist per Sq. Ft. Floor Area				National Steel I Joist Section
	1.0	.75	.632	.50	
	Steel Joist Spacing				
	12"	16"	19"	24"	
Pounds of Joist per Sq. Ft. Floor Area					
4"	3.70	2.77	2.33	1.85	4"
5"	4.30	3.22	2.71	2.15	5"
6"	4.90	3.68	3.09	2.45	6"
7"	5.80	4.35	3.66	2.90	7"
8"	6.80	5.10	4.29	3.40	8"
9"	7.70	5.77	4.86	3.85	9"
10"	8.70	6.52	5.50	4.35	10"
10"	9.50	7.12	6.00	4.75	10"
11"	10.70	8.02	6.75	5.35	11"
12"	12.00	9.00	7.58	6.00	12"

In estimating total weight of steel joist in a floor, figure area to include full length of joist.

**POUNDS OF STEEL JOISTS PER SQUARE FOOT
FOR GIVEN LOADS AND SPANS**

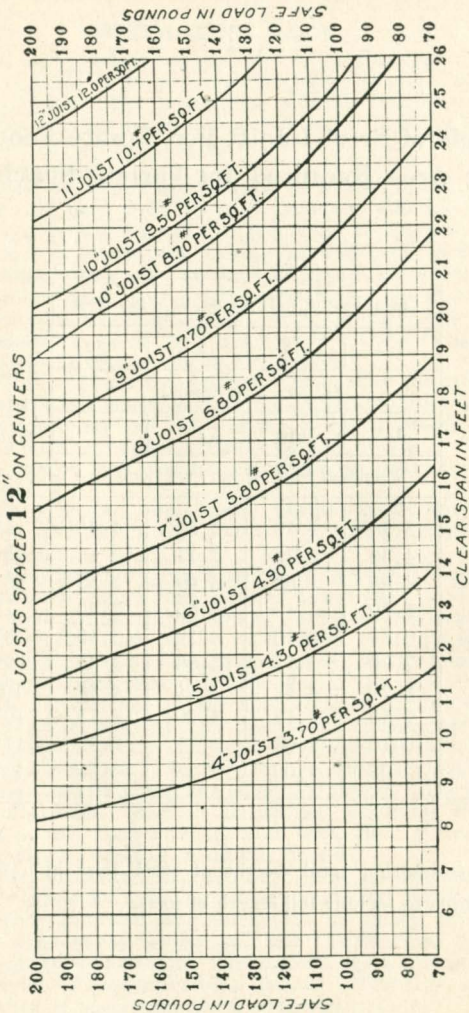

Total Load includes weight of Floor Construction.
 Fibre Stress not exceeding 16,000 lbs. per square inch.
 In estimating total weight of Steel Joists in a floor, figure to include full length of joists.

POUNDS OF STEEL JOISTS PER SQUARE FOOT
FOR GIVEN LOADS AND SPANS

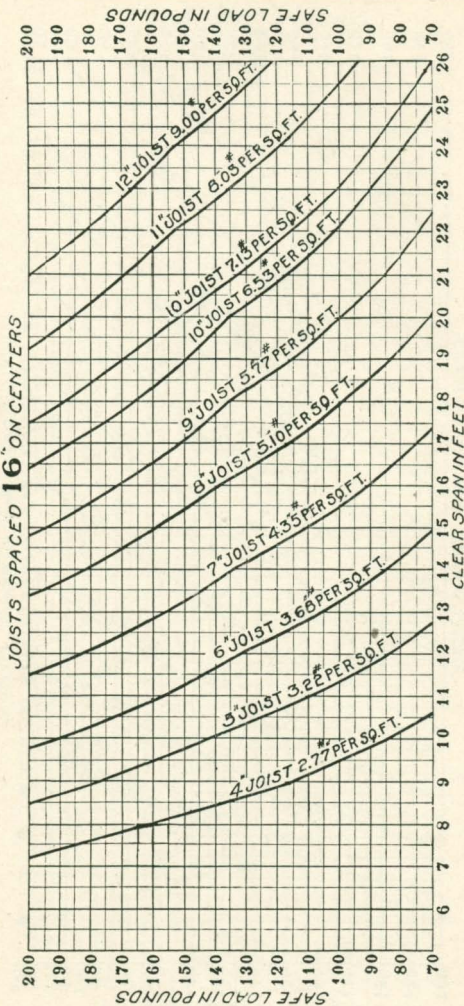

Total Load includes weight of Floor Construction.

Fibre Stress not exceeding 16,000 lbs. per square inch.

In estimating total weight of Steel Joists in a floor, figure to include full length of joists.

POUNDS OF STEEL JOISTS PER SQUARE FOOT
FOR GIVEN LOADS AND SPANS

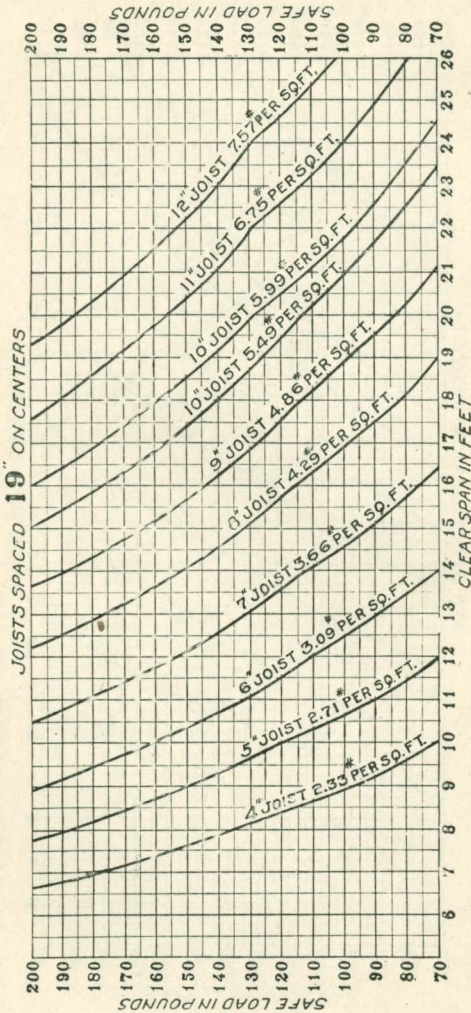

Total Load includes weight of Floor Construction.
Fibre Stress not exceeding 16,000 lbs. per square inch.
In estimating total weight of Steel Joists in a floor, figure to include full length of joists.

POUNDS OF STEEL JOISTS PER SQUARE FOOT
FOR GIVEN LOADS AND SPANS

JOISTS SPACED **24"** ON CENTERS

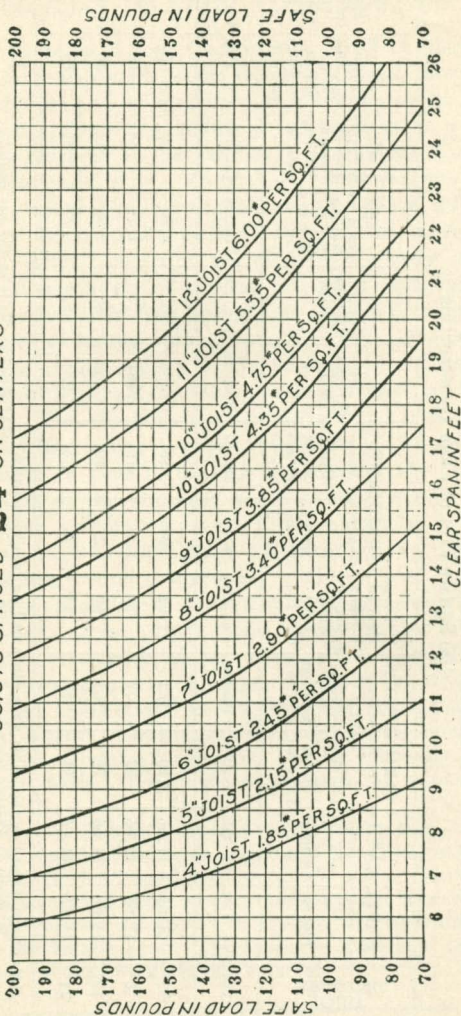

Total Load includes weight of Floor Construction.
Fibre Stress not exceeding 16,000 lbs. per square inch.
In estimating total weight of Steel Joists in a floor, figure to include full length of joists.

QUANTITIES OF ACCESSORIES

Required in Connection with Steel Lumber Joists for Each
100 Square Feet of Floor Construction

JOIST SPACING	STEEL LATH		SPRING-CLIPS For Attaching Lath		1" Large Headed Roofing Nails for Floor Lath 8" c to c	BRIDGING		6d Bridging Nails	Wood Nailing Strips	16d Nails for Nailing Strips. 18" c to c	2" Concrete Fill be- tween Nailing Strips	2" Concrete Continu- ous Slab Over Joists, No Nail- ing Strip.	3/4" Finish for Con- crete finished Floor
	Floors	Ceilings	Floors 12" c to c	Ceilings 8" c to c		Con- tinuous	Using Single Straps						
c to c	Sq. Yds.	Sq. Yds.	Pieces	Pieces	Pounds	Feet	Straps	Pounds	Lin. Ft.	Pounds	Cu. Yds.	Cu. Yds.	Cu. Yds.
12"	11.66	11.66	110	162	1.02	29	16	.106	103	1.50	.53	.60	.23
16"	11.66	11.66	82	122	.80	28	12	.081	78	1.14	.54	.60	.23
19"	11.66	11.66	70	105	.68	27	10	.068	66	.96	.55	.60	.23
24"	11.66	11.66	55	83	.53	26	8	.055	52	.77	.56	.60	.23

Quantities named in this table were estimated on following basis:

6d Nails at 181 per pound.
16d Nails at 49 per pound.

1" Roofing Nails at 158 per pound.
5% Included for waste in Nails and Lath Clips.
2% Included for waste in Nailing Strips.

Additional information regarding the use and application of Steel Lath, Spring Clips and Bridging is contained elsewhere in Hand Book under their respective titles.

ECONOMY OF STEEL CONSTRUCTION

The economy of Steel Construction (Steel Lumber and Structural Steel) begins on the architect's board. Simplicity in design and adaptability to desired architectural conditions relieve the architect for application to the planning features of the building. During erection the inspection problem is reduced. All through from first inception to final completion of structure the architect's work is simplified and his efforts directed with more confidence. After completion the absolute certainty of the structural dependability assures the client's satisfaction.

The reduction in dead load of floor slabs in turn reduces the weight of beams, columns and footings. The saving in volume of materials to be transported, carted, hoisted and manhandled affects every structural portion of the building. The elimination of extraneous material cleans up the job and promotes greater efficiency of all workmen. The saving in time of construction enables the quicker occupation of the structure and shortens the period of investment without returns. Little economies in construction, such as scaffolding, false flooring and the like, total to respectable proportions.

Every operation is always that much definitely accomplished. Every trade once started works through steadily to completion of their work. Weather conditions have comparatively little effect on Steel Construction. The saving never ends. Low depreciation reduces annual upkeep expense. The durability and permanence of a building is directly dependable on the efficiency of its structural basis. Time only emphasizes the advantages of steel.

Economy does not mean cheap construction. None of the materials entering a building of this type are cheap. It is the efficient combination of materials, the taking advantage of their basic merits that results in an economical and efficient design. The savings are impossible of complete visualization. They can be generally realized and best secured by designing in steel.

COST DATA

Construction costs are very important to the owner and architect. Also this one point is the most difficult to resolve into the status of definite information. So many factors enter to effect the costs on each operation that the best advance determination is after all only an estimate. In giving information on costs we intend only to indicate the better methods of arriving at a reasonably accurate advance estimate and to particularly call attention to those more important factors involved which do materially effect the total expenditure.

The unit costs used represent a general average over a large section of the country in March, 1921. It is improbable that at that time they would have applied on any operation anywhere. However, the percentage of variation between localities can not be large. When resolved into square foot costs it is even less obvious. The value of the data given lies in comparisons. The efficiency of one type of construction against another for certain conditions being clearly brought out. The use of unit costs actually applying locally will correct the total costs for that condition but will not materially effect the relative standing of various designs.

No one type of construction can claim greater efficiency and economy under all conditions. Steel Construction (Structural Steel and Steel Lumber) is particularly adapted to the field of buildings with live loads running under 150 pounds per square foot and spans under 24 feet. This line of demarkation is not fixed. Local conditions cause it to fluctuate. In the field described a close analysis will usually show the greater economy of steel.

In making comparisons between steel designs and other types of construction our purpose is not one of criticism. In this volume we are only trying to develop all those points pertaining to Steel Designs which will be of interest to the building public. Realizing that the maximum efficiency of any type of construction can always be secured by originally planning for that design, we wish to indicate the proper method of initially determining wherein lies the greatest economy.

The Architect, Engineer and Owner are necessarily in an unprejudiced frame of mind. They are invariably seeking for real information reflecting to their own interests. Such information must be correctly based to be of value. We have therefore unhesitatingly shown the true conditions regarding costs applying to Steel Construction. The effect of increasing spans and live loads on the cost of Steel Lumber floor slabs is clearly indicated on page 67. An analysis of how the square foot costs were determined for developing the curves is shown.

The Steel Fabricating industry is in position to give further detailed information on this subject.

FLOOR SLAB COSTS

The Floor Slab Cost Curve, page 67 indicates the effect of loads and spans on the cost of floors and shows a comparison of three types of floor construction.

The curves were developed on the following designing basis:—

Fibre Stress—Steel 16,000 lbs. per sq. inch.
Concrete 650 lbs. per sq. inch.
Wood 1,200 lbs. per sq. inch.

Moments —Concrete Joists $\frac{WI}{10}$
Steel Joists and Wood Joists $\frac{WI}{8}$

Cost analysis per sq. foot

60 lb. live load on 18 foot span.

Concrete Joist Floors

Detail shown on curve page 67

Weight of material used—88 lbs. per sq. foot.	
3½ B. F. form lumber at \$35 M. ft.	\$0.12
Labor of placing and tearing down.....	.10
.3 cu. ft. concrete in place at \$10.80 cu. yd.....	.12
2.4 lbs. reinforcing steel bent and placed at 5 cents lb.....	.12
6 in. terra cotta tile.....	.14
Placing terra cotta tile.....	.03
Concrete floor finish (¾ in.).....	.08
Plaster ceiling—assuming smooth surface at 63 cents sq. yd.....	.07
Total cost per sq. ft. concreté finish floor surface.....	<u>\$0.78</u>

For Wood Floor Finish as detail A

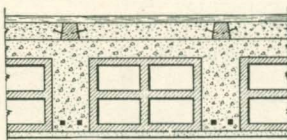

Detail A

Deduct concrete floor finish.....	.08
	<u>\$0.70</u>
Add—	
Screeds—beveled and leveled.....	.04
Maple flooring finished.....	.30
Concrete fill between screeds.....	.07
Total cost per sq. ft. with wood floor surface.....	<u>\$1.11</u>

FLOOR SLABS COSTS—Continued

Steel Joist Floors

Detail shown on curve page 67.

Weight of material used—37 lbs.

3.8 lbs. steel lumber joists at 6.3 cents lb.....	\$0.24
Steel lath (top and bottom) at 36 cents sq. yd.....	.08
Labor placing joists and bridging.....	.025
Labor placing steel lath.....	.025
Ceiling 17 cents sq. yd.	
Floor 5 cents sq. yd.	
2 in. concrete fill.....	.085
Concrete floor finish (3/4 in.).....	.08
Plaster ceiling at 86 cents sq. yd.....	.095
Total cost per sq. ft. concrete finish floor surface.....	<u>\$0.63</u>

For Wood Floor Finish as detail B

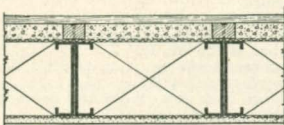

Detail B

Deduct 1/8 of concrete fill.....	\$0.01
Deduct concrete finish.....	.08
	<u>\$0.54</u>
Add—	
Screeds—plain—nailed to joists.....	.02
Maple flooring finished.....	.30
Total cost per sq. ft. with wood floor surface.....	<u>\$0.86</u>

Wood Joist Floors

Weight of material used—25 lbs. per sq. ft.

Wood joists in place at \$45 per M. B. F.	\$0.08
Wood ceiling lath in place at 27 cents per sq. yd.....	.03
7/8 in. sub-floor in place.....	.07
Bridging in place.....	.01
Finished maple wood flooring in place.....	.30
Plastered ceiling at 71 cents sq. yd.....	.08
	<u>\$0.57</u>

For fire-safe floors where the live load is under 150 lbs. to the square foot, Steel Joist Construction is usually the more economical design. The saving in time of erection of the entire structure is a factor of economy, not shown in the above cost analysis.

Curves Showing Relative Costs
Concrete Joists—Steel Joists—Wood Joists—Floor Slabs

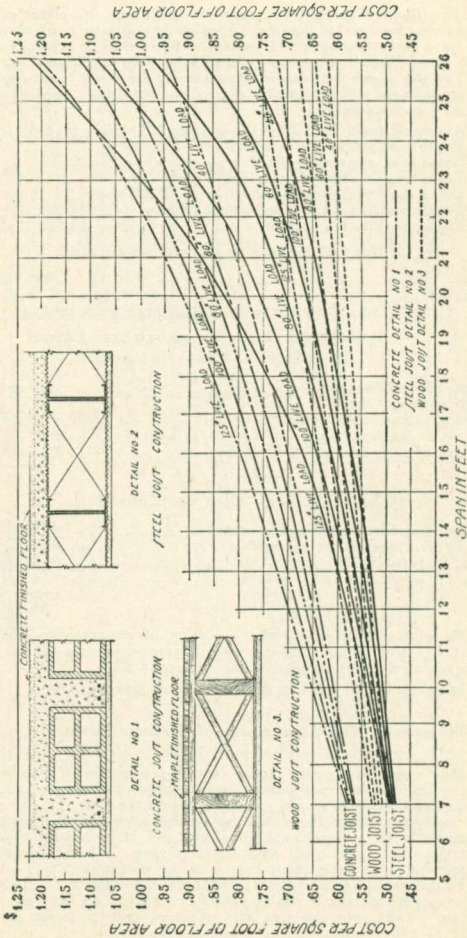

The reduction in dead load makes the saving.

THE NATIONAL PRESSED STEEL COMPANY

BEAM COSTS

The Beam Cost Curve, page 69, indicates the effect of loads and spans on the cost of beams. It also brings out the relative cost of concrete beams supporting concrete floor constructions as compared with Steel Beams supporting Steel Joist floor construction.

For the same position in a structure the total load applied on the concrete beam will materially exceed the total load applied on the steel beam. For example:—

- Assume panels 16 x 20'—beam span 20'. Live load 60 lbs.
- Dead load steel joist floor—38 lbs. per sq. ft.
- Dead load concrete joist floor—84 lbs. per sq. ft.
- Total dead weight steel beam—1,250 lbs.
- Total dead weight concrete beam—7,600 lbs.
- Then total load applying on steel beam—32,610 lbs.
- Then total load applying on concrete beam—53,680 lbs.

Cost of Beams as shown on Curves

Steel.....	\$3.52 per lin. ft.
Concrete.....	4.15 per lin. ft.
The difference in total load makes the saving.	

Analyzing Cost Curves at these Points

Steel Beam—Cost per lineal ft.

Beam 15"—42 lbs.	}	51 lbs. at 5 cents in place.....	= \$2.55	} Projection		
Shelf angles, 9 lbs.					below	
Furring clips, channels, in place.....						ceiling 7"
3½ sq. ft. lath in place, at 5 cents.....						
Plaster 2"—3½ sq. ft. at 17 cents.....						
			\$3.52-			

Concrete Beam—Cost per lineal ft.

17 lbs. Reinforcing steel at 5 cents.....	}	= \$0.85	} Projection		
3.6 cu. ft. concrete at 45 cents.....				below	
5 sq. ft. forms at 25 cents.....					ceiling 17"
5 sq. ft. of plaster at 8.5 cents.....					

Note that in figuring the quantity of concrete in the beam an arbitrary dimension of 6" for the T extension was taken. Depth of T same as floor thickness. This instance 8".

Moment of $\frac{Wl}{8}$ used in design of Steel Beam

Moment of $\frac{Wl}{10}$ used in design of Concrete Beam.

One very important factor is the projection of the beam below ceiling line. If the projection for the concrete beam was held to that of the Steel Beam it would greatly increase its cost. On the other hand, if a story clearance from floor to beams is to be maintained then the concrete beam necessitates an additional 10" on height of all walls, partitions, columns and risers in all piping. This difference in beam projection is an important factor to be considered in building costs.

In determining the relative economy of beams in Steel Construction always compute the loads applying on the beams for various types of design. Take into account the effect of greater beam projection on costs of other parts of the structure and give full consideration to time saved in installation.

Curves Showing Relative Costs Reinforced Concrete and Steel Beams

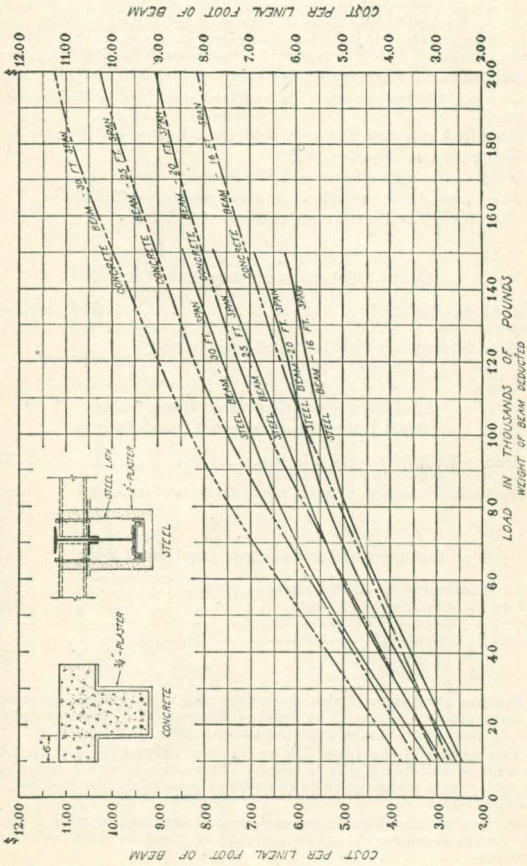

The reduction in total load makes the saving.

THE NATIONAL PRESSED STEEL COMPANY

COLUMN COSTS

The column cost curves, page 71, give relative costs of reinforced concrete and structural steel columns. A Steel Lumber and Structural design is of much lighter dead weight than reinforced concrete, and in using these curves full consideration must be given to this difference in dead weight. This will readily be seen from following example—

Assume column supporting five floors—panel 20 ft. x 20 ft.

Live load 60 lbs. per sq. ft. Dead load steel lumber floors—40 lbs. per sq. ft.

Dead load concrete floors on concrete columns—90 lbs. per sq. ft.

Weight of steel beam—1,200 lbs.

Weight of concrete beam—12,300 lbs.

Then total load on structural steel column—205,200 lbs.

Then total load on concrete column—361,500 lbs.

Cost of Columns as shown on Curves

Steel 12 ft. high.....	\$3.53 per lin. ft.
Concrete.....	6.35 " " "

The difference in total load makes the saving.

Analyzing Cost Curves at these Points

Steel Column—Cost per Lineal Foot

10" Beth.—54 lbs. at 5 cents in place.....	\$2.70
3 $\frac{1}{2}$ sq. ft. Fireproofing at 25 cents.....	.83
(Includes 2" cement plaster, metal lath and furring.)	
	<u>\$3.53</u>

Concrete Column—Cost per Lineal Foot

36 lbs. reinforcing steel, at 5 cents in place.....	\$1.80
4.27 cu. ft. concrete at 45 cents.....	1.92
7 $\frac{1}{2}$ sq. ft. forms at 25 cents.....	1.88
7 $\frac{1}{2}$ sq. ft. plastering at 10 cents.....	.75
	<u>\$6.35</u>

Further analysis will also show very marked saving in floor space by using steel columns. The finished dimensions of steel column are 16 in. x 16 in., and that of concrete column 29 $\frac{1}{2}$ in. in diameter.

The saving is therefore 2.9 sq. ft. per column or 140 sq. ft. on one floor of building 100 ft. x 140 ft. This saving in floor space is an important item which must be considered both as to cost and net floor space available.

In determining the relative economy of columns in steel construction always compute the loads applying on columns for various types of design.

This reduction in load effects a very material saving. Freight, cartage, hoisting and placing a ton of material costs money. Also check the square feet of floor area taken up by columns and give this item consideration in the cost comparison.

Curves Showing Relative Costs Reinforced Concrete and Steel Columns

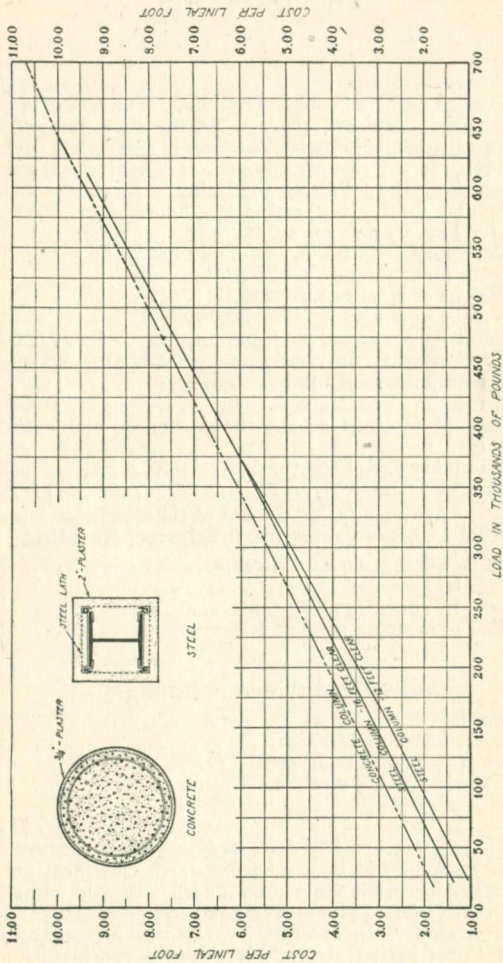

The reduction in total load makes the saving.

FOOTING COSTS

The footing cost curves page 73 give costs for various loadings. They are utilized to show the saving in supporting a Structural Steel and Steel Lumber building as compared to a reinforced concrete building. The saving of dead weight over reinforced concrete in the steel lumber and structural steel building is considerable and should be fully considered in any cost comparison. The saving will readily be seen from the following example:

Assume footing supporting five floors, panel 20' x 20'.	
Live load 60 lbs. per sq. ft.	
Dead load steel lumber floors 40 lbs.	
Dead load concrete floors 90 lbs.	
Weight of steel beam 1,200 lbs.	
Weight of concrete beam, 12,300 lbs.	
Total weight struc. steel columns fireproofed, 9,000 lbs.	
Total weight reinforced concrete columns, 30,000 lbs.	
Then total load steel lumber design.....	214200 lbs.
Then total load concrete design.....	391500 lbs.
Cost of footings as shown on curves, soil pressure, 6,000 lbs.	
Steel Lumber and Structural Steel.....	\$30.00
Reinforced Concrete.....	72.00

Analyzing Cost Curves at these points:

Steel Lumber and Structural Steel Building—

71 cu. ft. excavation at 5½ cents.....	\$ 3.90
15.8 sq. ft. forms at 15 cents.....	2.37
60.3 cu. ft. concrete at 30 cents.....	18.09
131 lbs. reinforcing steel at 4.3 cents.....	5.64
	<hr/>
	\$30.00

Reinforced Concrete Building—

179 cu. ft. excavation at 5½ cents.....	\$ 9.84
29 sq. ft. forms at 15 cents.....	4.35
150 cu.ft. concrete at 30 cents.....	45.00
298 lbs. reinforcing steel at 4.3 cents.....	12.81
	<hr/>
	\$72.00

These costs are based on ordinary earth excavation. If the footings run into a harder earth classification the difference in cost is more pronounced. In a building 100' x 140' the example given develops a saving of \$2,016.00 for footings alone. In determining the relative economy of Steel Construction always give careful consideration to the effect of decreased dead load on footing costs.

Curves Showing Costs Reinforced Concrete Footings

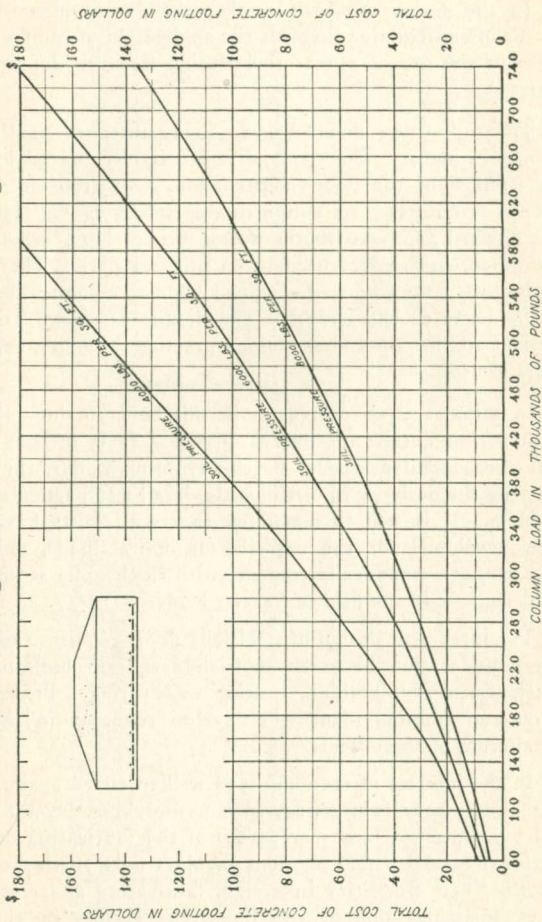

The reduction in total load makes the saving.

CONSTRUCTION DETAILS

In the design of Steel Lumber the development of details of construction involves the application of common sense in the use of a material lending itself to definite designing.

The supporting member is in every instance rigidly framed in place. The steel joists are rigidly braced by the balance of the floor construction. All transfer of stresses from joists to supporting members is vertical. The finished floor construction forms a rigid slab of which the supporting girders become an integral part. There is absolutely nothing to be gained by direct connection of the joists to the girders. The details as shown are efficient and have become common practice through many years of use.

It is impractical to attempt in this book to show all construction details for every purpose. It is intended that the general principles be clearly brought out, thus enabling the designer to intelligently detail any particular problem. It is well to remember that steel joists have been developed for the carrying of lighter loads, and they cannot economically compete with the heavier structural sections in the field of heavier loads.

The intelligent design of steel joist floors requires that due consideration be given to such details in building construction as plumbing, heating and wiring. Proper layouts of framing plans will develop economy in the installation of these items.

In the interest of economy it is well to guard against any unnecessary fabricating, such as notching, levelling and punching. A large percentage of the fabricating on National Steel Lumber Sections involves only cutting to length. This simplicity in design, fabricating and erection constitutes one of the important factors in the value of National Sections.

CONSTRUCTION DETAILS

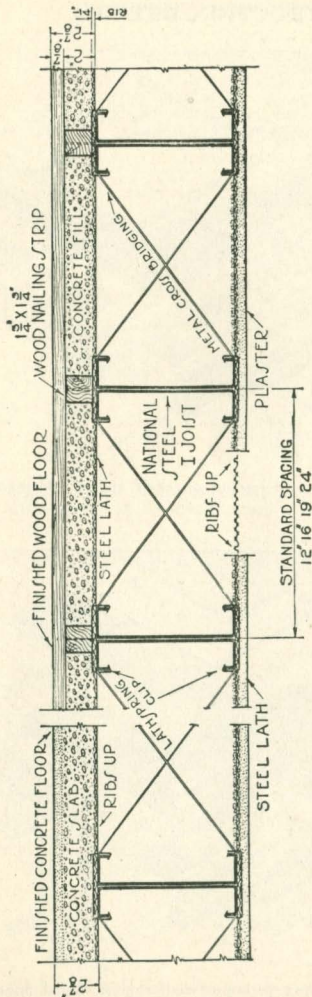

Standard Steel Joist Floor Construction

This cross section shows the details of the standard steel joist floor construction with various floor finishes. The steel lath is placed on top of the joists and securely fastened to each joist by using large headed roofing nails or spring lath clips. In case of a wood floor finish a nailing strip is placed on top of the lath and nailed securely to the joist. Concrete is then placed on top of the lath as shown. Ceiling lath is fastened to the bottom of the joists by using spring lath clips not more than 8" on center. The standard construction for a first class firesafe floor calls for a 7/8" thickness of cement plaster or other plaster equally as fire resisting.

CONSTRUCTION DETAILS

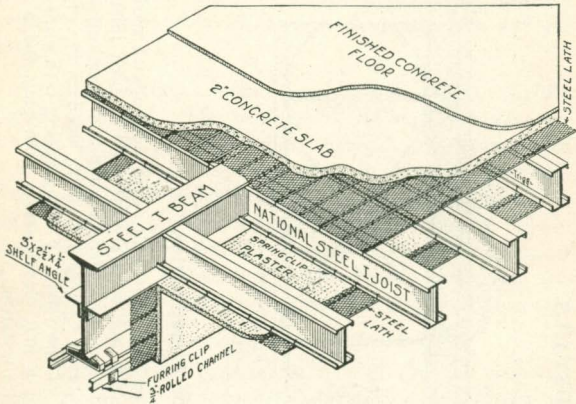

Girder support with joists resting on shelf angles. Cement floor finish.

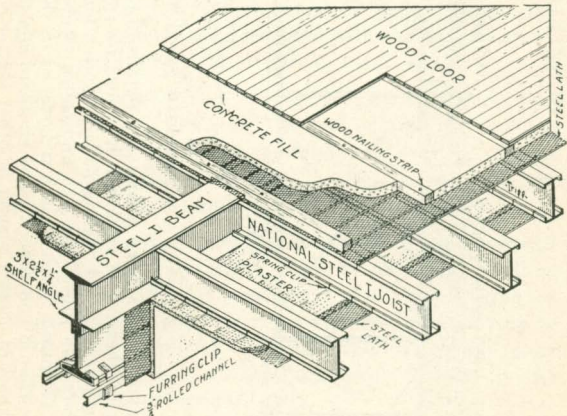

Girder support with joists resting on shelf angles. Wood floor finish.

CONSTRUCTION DETAILS

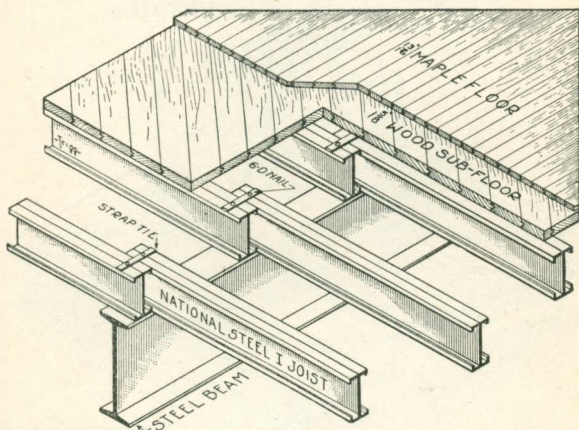

Non-firesafe floor. Wood sheathing nailed directly to the joists. Joists resting on top of girder and lapped with strap bridging tie.

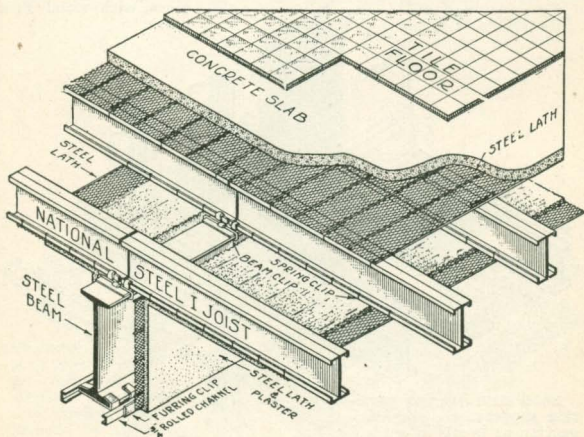

Tile finish floor with beam clips holding joists to top flange of girder.

CONSTRUCTION
DETAILS

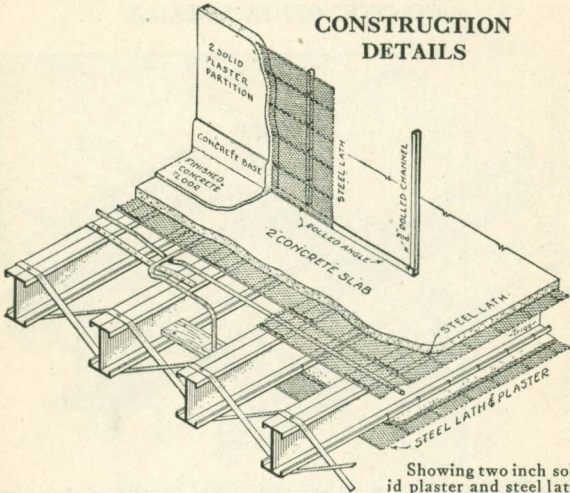

Showing two inch solid plaster and steel lath non-bearing partition, conduits and water pipes, with wood floor finish.

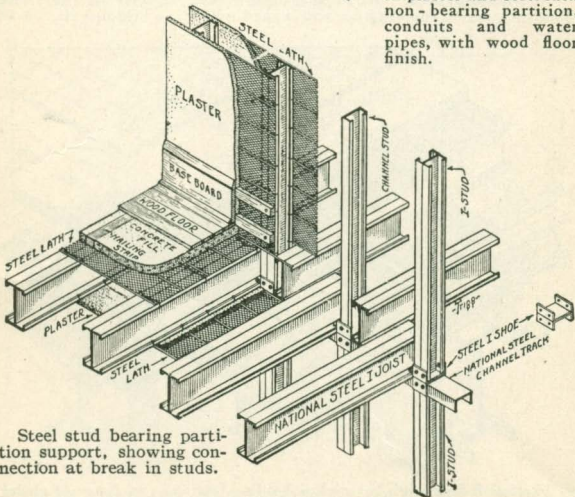

Steel stud bearing partition support, showing connection at break in studs.

CONSTRUCTION
DETAILS

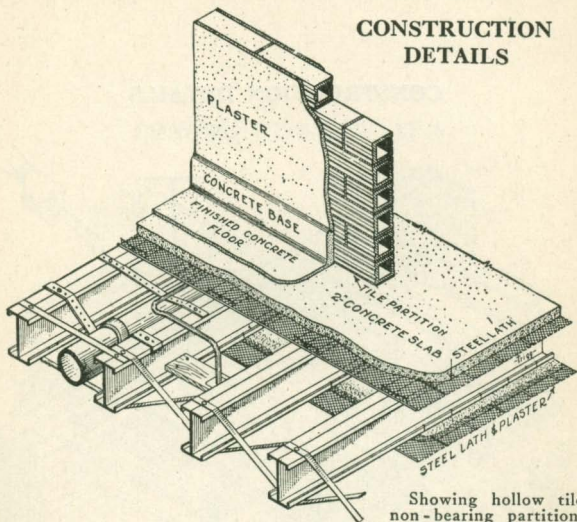

Showing hollow tile non-bearing partition, conduits and soil pipes. Tile partition built on top of 2" concrete fill.

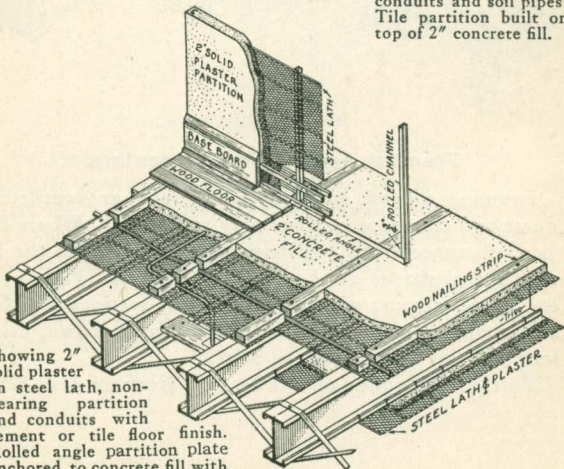

Showing 2" solid plaster on steel lath, non-bearing partition and conduits with cement or tile floor finish. Rolled angle partition plate anchored to concrete fill with expansion bolt.

CONSTRUCTION DETAILS

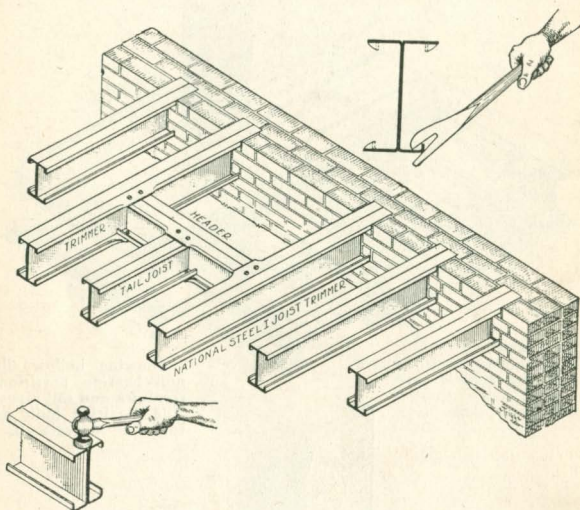

Framing Around Small Openings

Framing around small openings such as ventilating ducts and chimneys requires only steel joist. Where the header connects with the trimmer simply flatten the lip with a tool shaped as shown, (Pipe wrench). Pound the end of the trimmer with a sledge, fit the sections together and connect the flanges top and bottom as shown, using four $\frac{1}{4}$ " soft rivets or stove bolts.

Further description of this detail is given on page 125.

CONSTRUCTION DETAILS

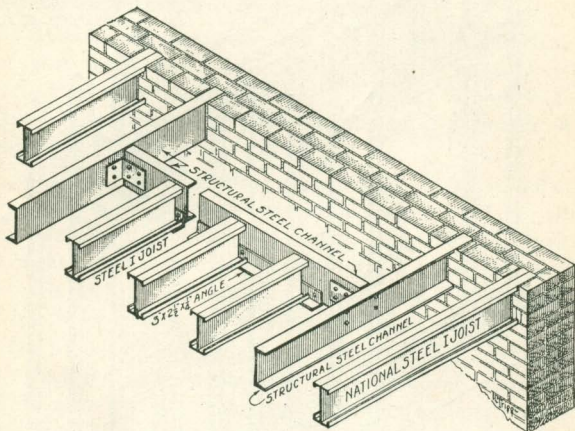

Framing Details

Framing around large openings such as stairwells requires structural steel headers and trimmers. In most cases the light weight structural channel the same depth as the joists will carry the loads. Standard connection details are used. The steel joist trailers being supported on shelf angle riveted to the back of the header channel.

Refer to pages 125 to 127 for tables and further description of this detail.

CONSTRUCTION DETAILS

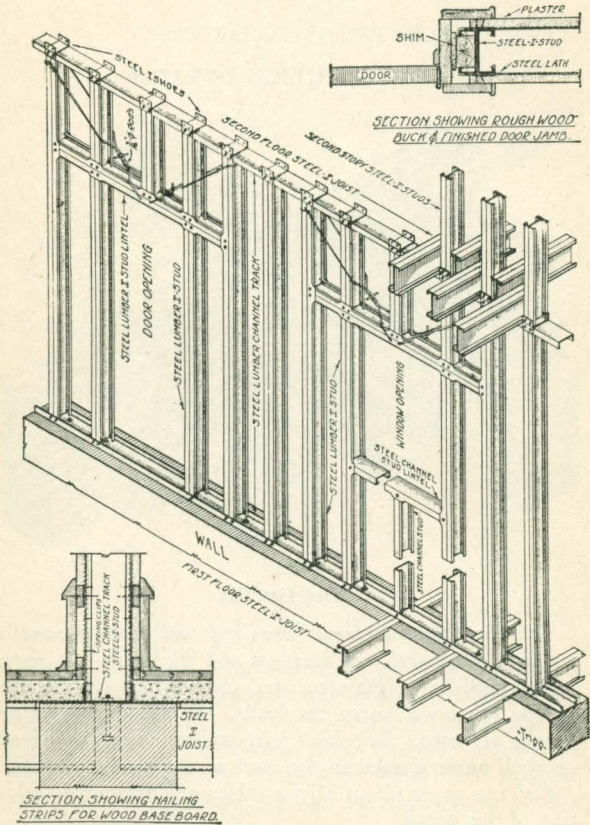

Bearing Partitions

In certain types of buildings where the design is very regular, bearing partitions can sometimes be economically used in place of columns and beams for supporting the

Bearing Partitions—Continued

floors. For these partitions attention is called to the framing of the studs around doors and windows. The sill and cap plates at the top and bottom of the partition studs are the special four inch channel section shown on page 20. The studs are connected to these plates top and bottom with $\frac{1}{4}$ " rivets or stove bolts.

For wide openings where the load applied is sufficient to cause more than the allowable deflection in members spanning the opening, special support must be provided. The best detail for this special support is the use of No. 8 wire placed and twisted as shown.

In laying out the framing plans for partitions or walls, first make a detail of the standard openings. This detail can simply be indicated at the locations desired and straight studs spaced in between. Ordinarily the fabricator furnishes the studs cut to length and the punching of bolt holes is done in the field with a hand punch.

On large installations it is more economical to spot weld the sections, using a portable gas tank outfit. Sections of the same size are fitted into each other as described on page 80. The customary size of studs is four inch, using either the channel or I section as required by the loading.

When channel sections are used, holes are punched in the flanges with a hand punch at approximately eight inch centers. The steel lath is then wired to the channels. When I studs are used the lath is secured to the stud with the spring lath clip.

The details for door jambs and window frames are similar to those used in wood frame construction. See details shown.

A steel stud and lath bearing partition carries a surprisingly heavy load and provides an economical firesafe partition and wall construction.

CONSTRUCTION DETAILS

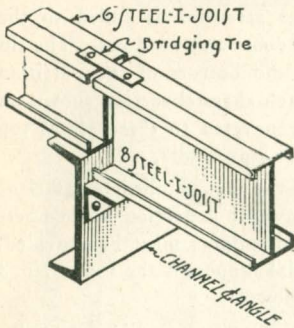

Where joists of different depths are supported on a channel section the floor level is maintained by using shelf angle to support the deeper joist.

Where the depth of joist and supporting girder does not permit the shelf angle flange extending down, the angle is reversed as shown. Care being taken to cut the joists shorter so that ample clearance for leg of shelf angle and rivet heads is provided.

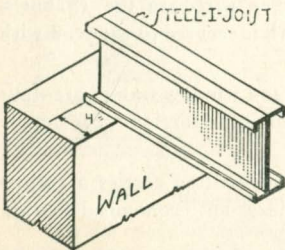
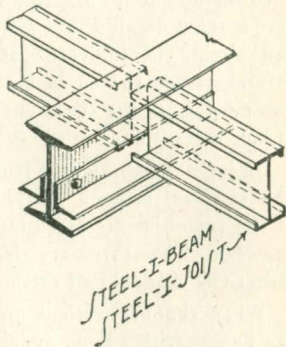

Joists supported on masonry walls should always have at least four inch bearing and not less than one-half the depth of the joist.

CONSTRUCTION DETAILS

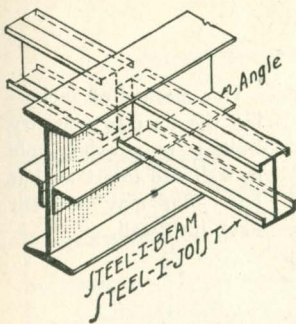

The usual method of supporting the joists is by using a shelf angle riveted to the web of the girder. This reduces the beam projection below ceiling line.

Where the flange of supporting girder is sufficiently wide the joists can be butted and held in place by using beam clips.

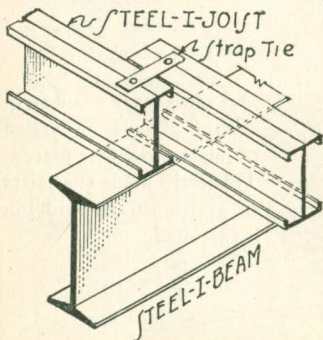
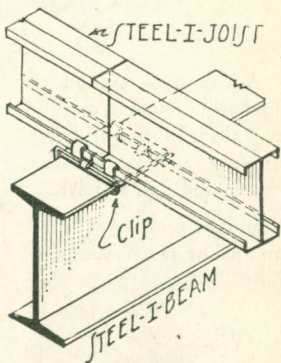

Showing steel joists set on top of supporting girder, with joists lapped. Strap tie nailed to top of each joist holds them in vertical position.

CONSTRUCTION DETAILS

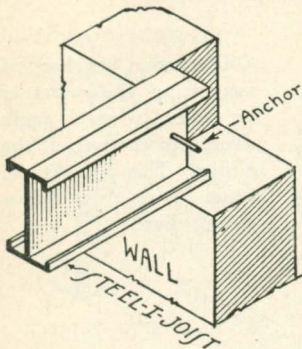

One method of anchoring the joist to masonry walls is to punch a hole in web and insert anchor bar. Bar may be bent back into wall.

A common method of anchoring joists to masonry walls is to turn bridging around anchor bar as shown and nail to joist.

Standard practice calls for an anchor at every fourth joist.

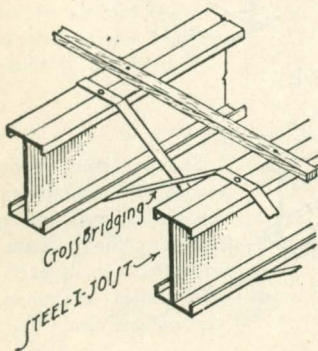
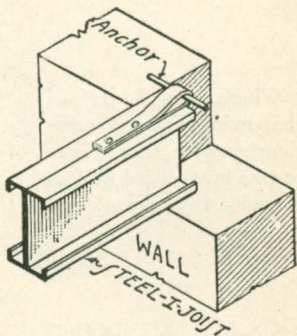

A temporary wood strip should always be nailed to joists when first placed. This strip holds the joists in position until bridging is installed.

CONSTRUCTION DETAILS

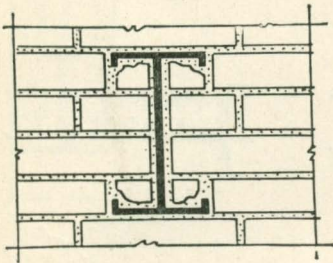

When the joists are set in a brick wall, cement mortar should be slushed in around the joist to insure a tight job.

When it is desired to have the top of joists level with the top of supporting girders, the top flange of the joists is beveled or coped out as shown. An oblique bevel cut simplifies fabrication, thereby reducing cost and has proven equally as efficient as the notched cope.

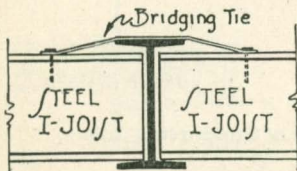
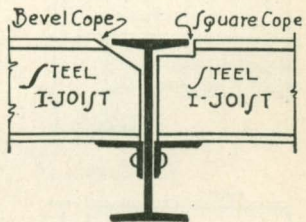

Joists are tied end to end as shown with bridging nailed to the joists.

CONSTRUCTION DETAILS

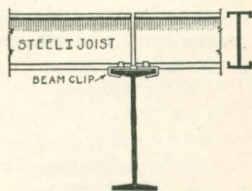
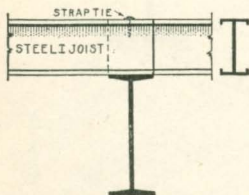
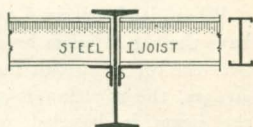
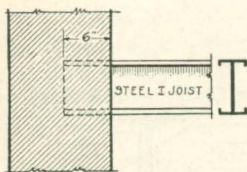
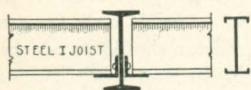

Joists lapped.

Joists butted

Details for Methods of Supporting Joists.

CONSTRUCTION DETAILS

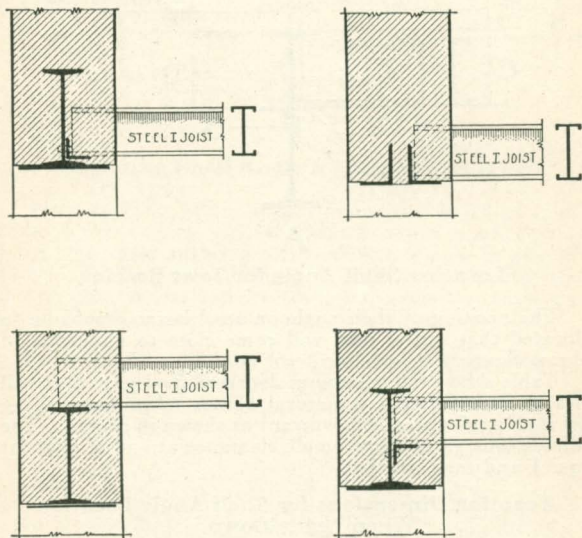

Details where steel joists are supported on Lintels in masonry walls.

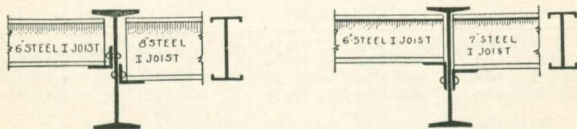

Steel Joists of different sizes set on shelf angles.

CONSTRUCTION DETAILS

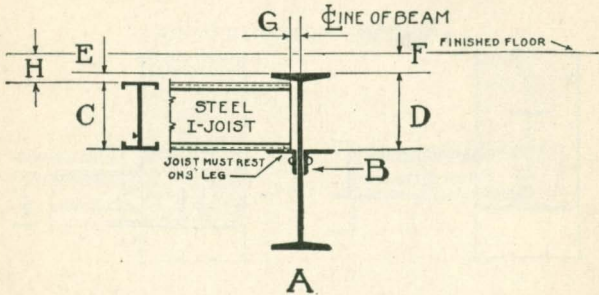

Locating Shelf Angle for Joist Bearing

The position of shelf angle on steel beam should be so located that top of joist will come close to underside of beam flange.

Table shows the maximum depth of steel joist that will frame into different structural beams when vertical leg of shelf angle extends downward as shown in sketch. The dimensions given allow ample clearance at end of joist for quick and easy erection.

Framing Dimensions for Shelf Angle Location When Leg is Down.

Standard I Beams	Bethlehem I Beams	Size of Angles	Max. Depth Steel Joist	Distance From			Clearance at End of Joist	Thickness of Standard Floor
				Angle to Top of Beam	Joist to Top of Beam	Beam to Fin. Floor		
A	A	B	C				G	H
8" @18.4lbs.	8" @17.5lbs.	3x2 1/2x 1/4	4"	4 3/4"	3/4"	2 1/8"	3/4"	2 7/8"
9" @21.8lbs.	9" @20.0lbs.	3x2 1/2x 1/4	5"	5 3/4"	3/4"	2 1/8"	3/4"	2 7/8"
10" @25.4lbs.	10" @23.5lbs.	3x2 1/2x 1/4	6"	6 3/4"	3/4"	2 1/8"	3/4"	2 7/8"
12" @31.8lbs.	12" @28.5lbs.	3x2 1/2x 1/4	7"	8"	1"	1 7/8"	3/4"	2 7/8"
	15" @38.0lbs.							
15" @42.9lbs.	18" @48.5lbs.	3x2 1/2x 1/4	10"	11"	1"	1 7/8"	3/4"	2 7/8"
18" @54.7lbs.	20" @59.0lbs.	3x2 1/2x 1/4	12"	13 1/8"	1 1/8"	1 3/4"	3/4"	2 7/8"
20" @65.4lbs.	24" @73.0lbs.	3x2 1/2x 1/4	12"	13 1/8"	1 1/8"	1 3/4"	7/8"	2 7/8"
24" @79.9lbs.	26" @90.0lbs.	3x3 x 1/4	12"	13 1/4"	1 1/4"	1 5/8"	1"	2 7/8"

CONSTRUCTION DETAILS

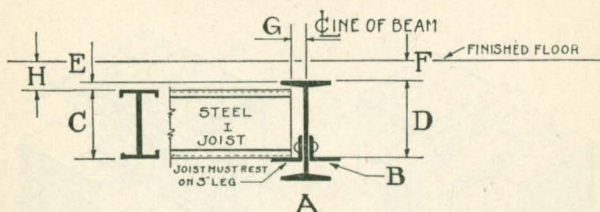

Locating Shelf Angle for Joist Bearing.

When depth of joists approximates the depth of steel beam so that vertical leg of shelf angle cannot extend downward, the shelf angles are reversed as shown in sketch above. In this case the length of joists should be slightly shorter than in detail on preceding page to allow clearance for thickness of angle and protruding rivet heads.

Framing Dimensions for Shelf Angle Location
When Leg is Up.

Standard I Beams	Bethlehem I Beams	Size of Angles	Max. Depth Steel Joist	Distance From			Clearance at End of Joist	Thickness of Standard Floor
				Angle to Top of Beam	Joist to Top of Beam	Beam to Finished Floor		
A	A	B	C	D	E	F	G	H
8" @18.4lbs.	8" @17.5lbs.	3x2 1/2x 1/4	6"	6 3/4"	3/4"	2 1/8"	1 1/8"	2 7/8"
9" @21.8lbs.	9" @20.0lbs.	3x2 1/2x 1/4	7"	7 3/4"	3/4"	2 1/8"	1 1/8"	2 7/8"
10" @25.4lbs.	10" @23.5lbs.	3x2 1/2x 1/4	8"	8 3/4"	3/4"	2 1/8"	1 1/8"	2 7/8"
12" @31.8lbs.	12" @28.5lbs.	3x2 1/2x 1/4	10"	10 3/4"	3/4"	2 1/8"	1 1/8"	2 7/8"
	15" @38.0lbs.							
15" @42.9lbs.	18" @48.5lbs.	3x2 1/2x 1/4	12"	12 7/8"	7/8"	2"	1 1/8"	2 7/8"
18" @54.7lbs.	20" @59.0lbs.	3x2 1/2x 1/4	12"	13"	1"	1 7/8"	1 1/8"	2 7/8"
20" @65.4lbs.	24" @73.0lbs.	3x2 1/2x 1/4	12"	13 1/8"	1 1/8"	1 3/4"	1 1/8"	2 7/8"
24" @79.9lbs.	26" @90.0lbs.	3x3 x 1/4	12"	13 1/4"	1 1/4"	1 5/8"	1 1/8"	2 7/8"

CONSTRUCTION DETAILS

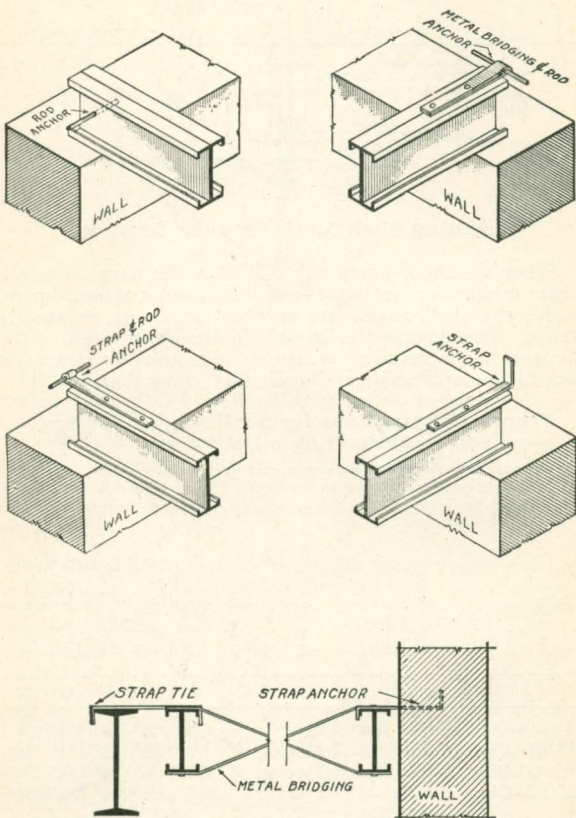

Details showing the various methods of anchoring joists to walls. The end joists in a panel should always be anchored laterally.

CONSTRUCTION DETAILS

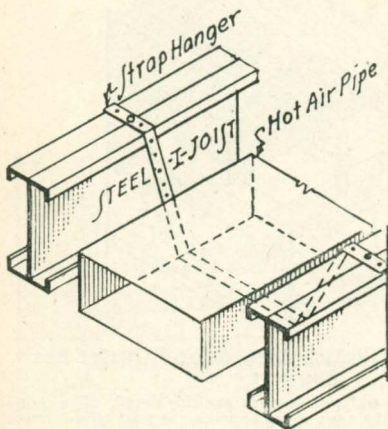

Nail the bridging strap to the joist with 6d nails.

For supporting air ducts, pipes, etc., use coiled bridging as shown in the details. For pipes hung below the joists a bar may be supported on the bottom flange of two joists around which the strap hanger is fastened, or a bridging strap fastened to the top of joist as shown.

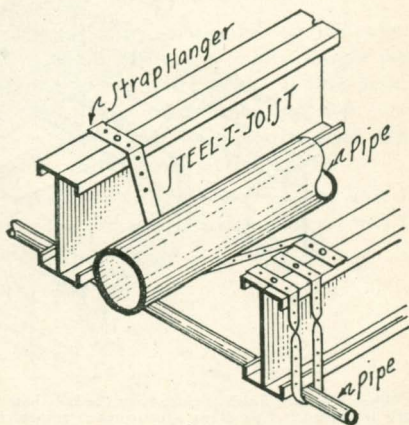

CONSTRUCTION DETAILS

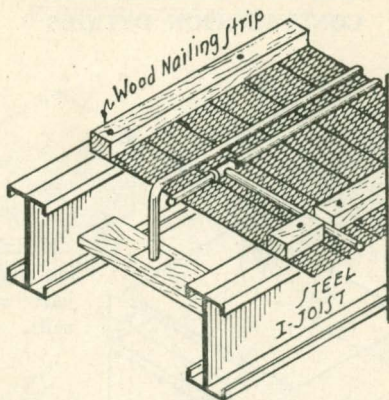

Details showing Piping, Screeds and Outlet Box Support

Various methods are employed to work out this detail. The shape of the joist section and the open space between the joist afford ample facility to carry out any of the methods commonly used.

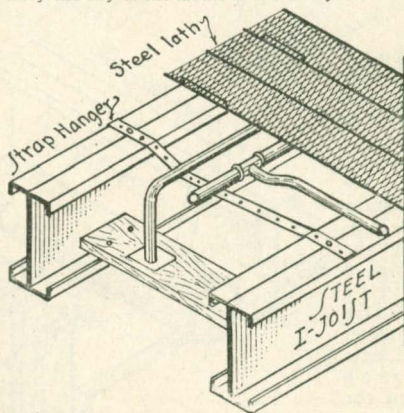

When the floor finish is cement or tile it is best to lay piping before lath is placed. This gives a continuous reinforcing to the slab and prevents cracks over pipes.

CONSTRUCTION DETAILS

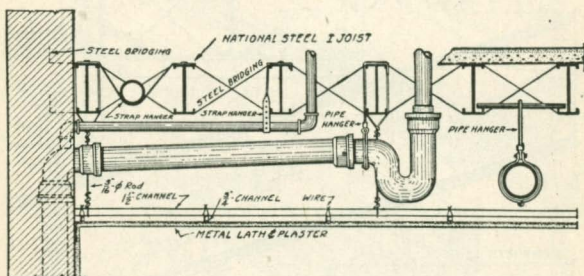

Pipe Installation

Electric conduits and other small pipes are laid on top of the joists and buried in the concrete fill. Larger pipes are placed in space between joists when running parallel with the latter. When running at right angles to joists, pipes are hung with standard pipe hangers, steel straps or bridging as shown in the cross section above.

Where pipes extend below the joists the ceiling lath and plaster is suspended. The floor construction permits the economical covering of all piping.

CONSTRUCTION DETAILS

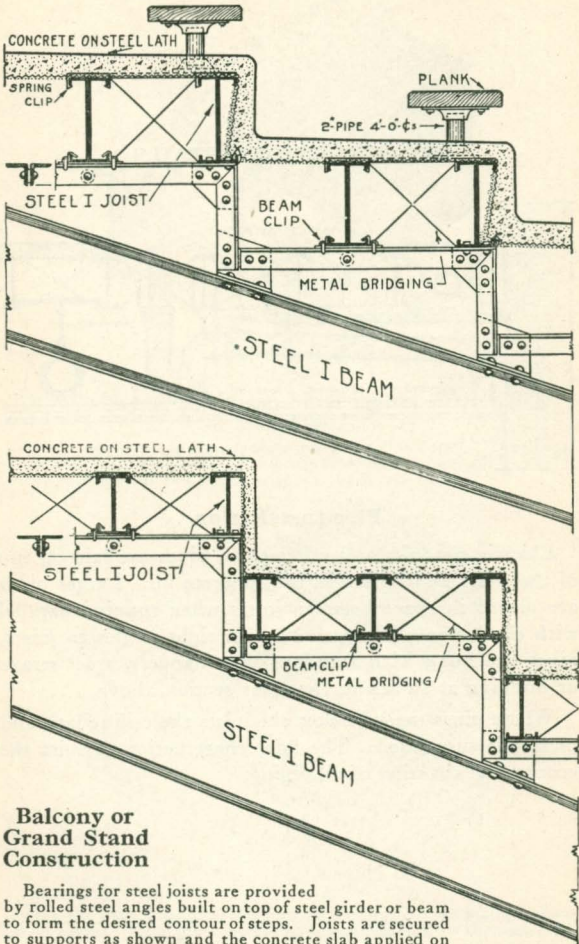

Balcony or Grand Stand Construction

Bearings for steel joists are provided by rolled steel angles built on top of steel girder or beam to form the desired contour of steps. Joists are secured to supports as shown and the concrete slab applied on metal lath as in standard floor construction.

CONSTRUCTION DETAILS

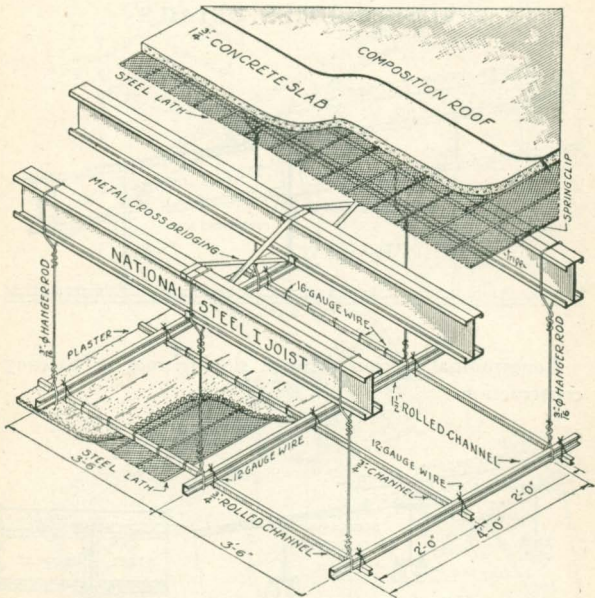

Suspended Ceilings

When the architectural features of a building make a suspended ceiling desirable, the ceiling lath is attached by tie wires to a frame work constructed as shown.

Either hot or cold rolled channel sections are used for this frame work. The sections are wired together in the field, making a rigid frame for the lath.

CONSTRUCTION DETAILS

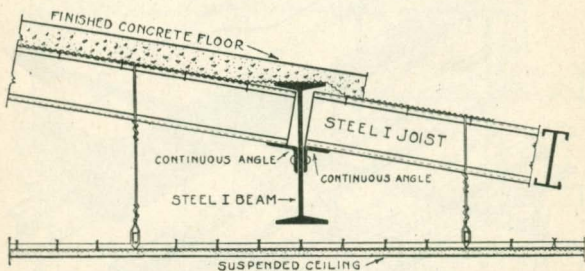

Longitudinal section through sloping roof or balcony construction.

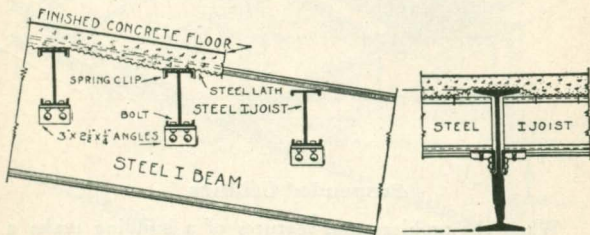

Cross Section through roof or balcony construction when supporting girders are on a slope.

CONSTRUCTION DETAILS

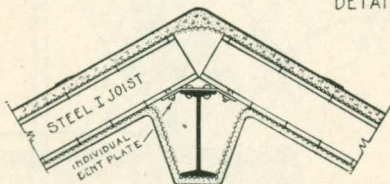
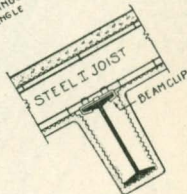
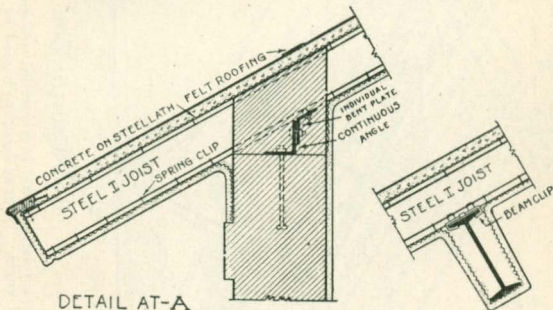
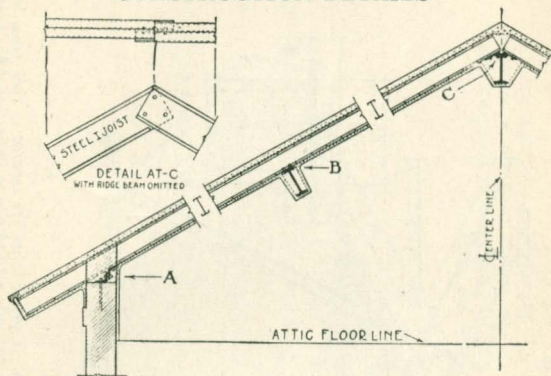

DETAIL AT-C
Roof Construction
Details of steel joist hip roof construction.

CONSTRUCTION DETAILS

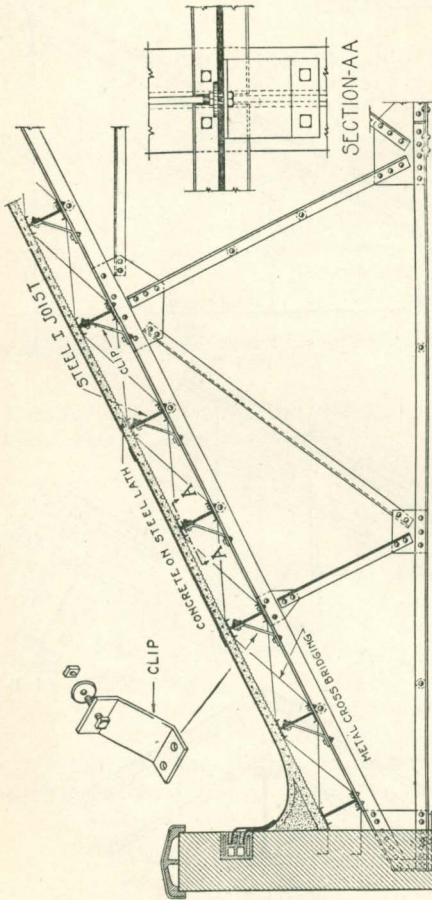

Roof Construction

Details of roof construction when joists are not in a vertical position. Ends of joists are secured to roof truss by bolting one flange of joist to chord angle. Webs of joist are braced by a specially formed clip as in Section AA. Steel lath and concrete fill are applied on top of joists as in standard floor construction.

CONSTRUCTION DETAILS

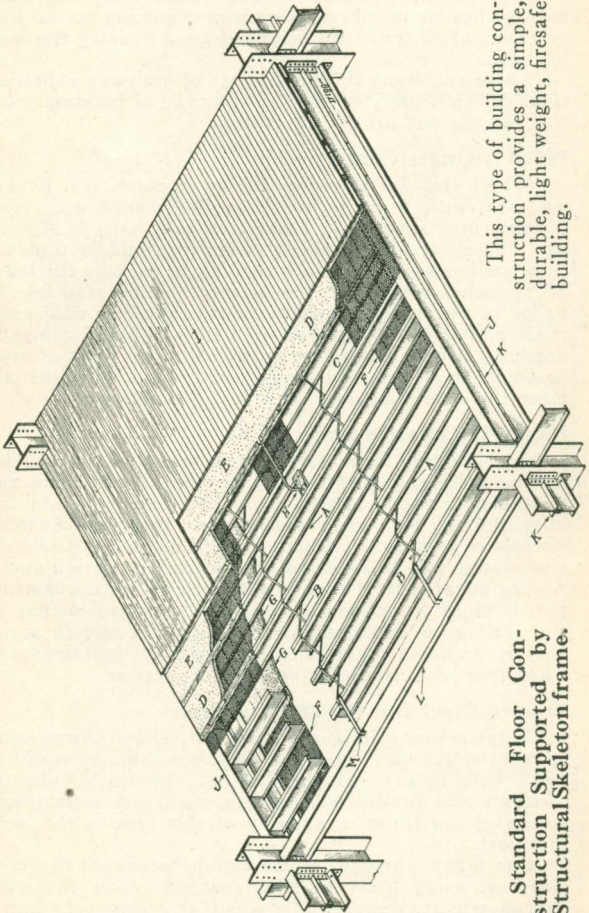

This type of building construction provides a simple, durable, light weight, firesafe building.

Standard Floor Construction Supported by Structural Skeleton frame.

STAIRWAY CONSTRUCTION

In framing around stairwells, structural steel beams are used as header members, the sections coming at the foot and head of all stair runs being designed to carry stairway loadings.

There are many different types of stairway construction, choice being governed by the type of building, location of stair and artistic effect desired.

Wood Stringer Construction

Where this fire retarding design is permitted, heavy, well seasoned, wood stringers can be placed with ends framing into supporting beams top and bottom of stair run. Steel lath to be nailed directly to and underneath these stringers, and this lath then plastered to a thickness of $\frac{7}{8}$ inches with approved plaster. Wood stair blocks nailed to the stringers may be finished directly with wood risers and treads or covered with steel lath and concrete, finishing either in concrete or wood. This type of stair is simple in design and easily constructed, but does not meet the requirements of a fireproof building.

Concrete Construction

After building forms for concrete stairs, the main reinforcing rods are placed lengthwise with the stair run and hooked over supporting beams. The placing of and size of reinforcing bars to provide against shear and bending stresses is a matter of design in each instance. Concrete stair design can be adjusted to most any condition and is readily adapted to change in plans. The form construction is more or less complicated and the dead weight of the stair runs is comparatively high. Concrete stairs comply with the requirements of fireproof buildings and when properly installed give excellent service.

Pressed Steel and Ornamental Iron

There are many designs of Pressed Steel and Ornamental Iron stairways on the market. Their popularity is due to light weight, ease of installation, simplicity, beauty, economy and durability. In connection with a structural steel skeleton frame a stairway of this type is the most practical.

For many purposes stairs can be economically constructed, using Steel Lumber sections. The following cuts show three designs, all of which give good substantial economical stairs.

STAIRWAY CONSTRUCTION

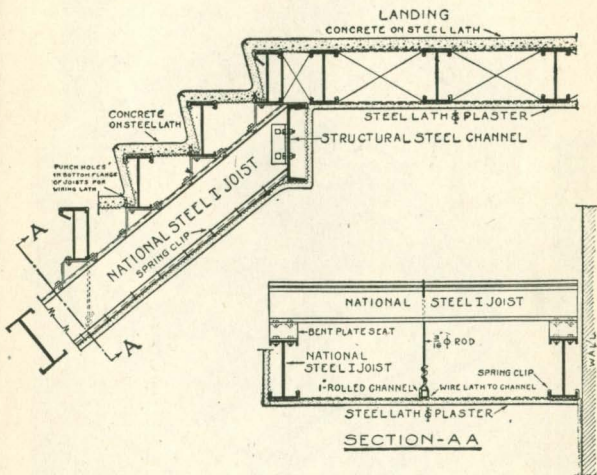

Joist Type

For stair construction to sustain unusually heavy loads this design is particularly adaptable. Supporting joists are placed as close as desired. This design is simple in construction, the strap brackets being riveted on to the stringers in the fabricating plant.

STAIRWAY CONSTRUCTION

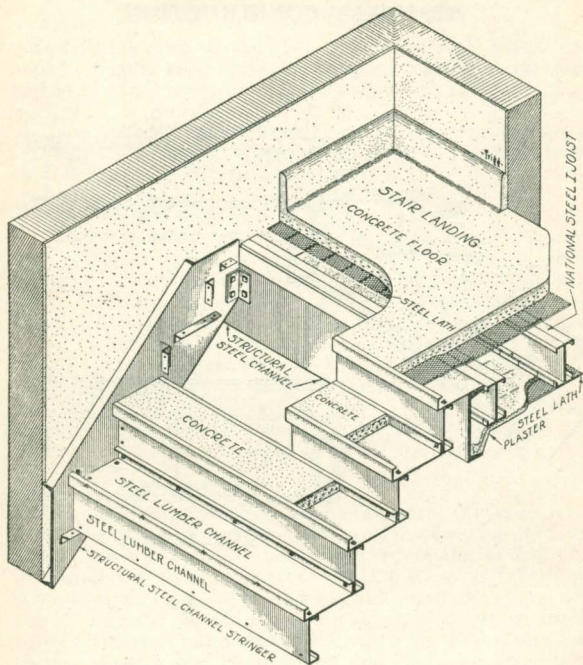

Channel Type

This stairway is fabricated in the structural steel shop and is installed at the building very rapidly. The treads can be finished in concrete tile or composition. The underside can be protected by plaster on steel lath or left uncovered as shown on the cut. The run is supported by structural steel channels on either side, clip angles being riveted in proper position on the back of the channels. The risers give support lengthwise with the tread sufficient for stairway width of ten feet.

STAIRWAY CONSTRUCTION

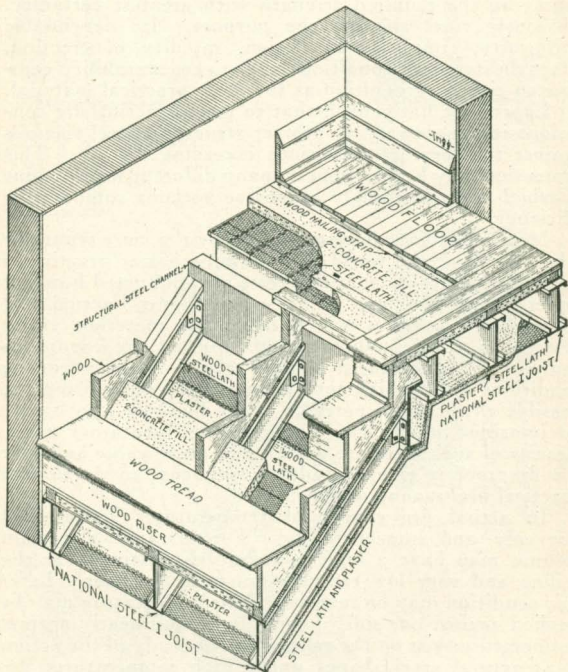

Standard Type

This design is similar to the standard steel joist floor construction, the nailing-strip being diverted into the stair horses which are securely nailed to the I Joist Stringers, the details of the construction being clearly shown in the cut. This is a good, general purpose stair design and can be completely fabricated right on the job.

The use of Steel Lumber sections in stair construction is rapidly becoming more universal. The adaptability of these three designs to all conditions, the light weight and economy make them the more desirable type for use in fireproof buildings in connection with structural steel skeleton frame.

FIREPROOFING OF STRUCTURAL STEEL

In building designs the most desirable material for the structural portions is that utilizing the least space and supplying the required strength with greatest certainty. Obviously steel answers the purpose. Its dependable uniformity, simplicity in design, rapidity of erection, adaptability to all conditions and rugged durability combine to give it recognition as the most practical material.

Experience has proven that to meet exacting fire conditions it is necessary to protect structural steel sections against temperature conditions exceeding 700° F. This protection may be provided in many different ways—some of which are exceedingly expensive without comparative efficiency.

Many tests have been carried on by the more reputable laboratories of the world to determine better practice in fireproof construction. Such tests are conducted however under serious handicap. They cannot control actual field construction practice which in certain materials varies directly as the human equation. Actual fire conditions cannot be duplicated in test furnaces. Actual stressing conditions during high temperature fires, recognizing the possible effect on all portions of the building, can hardly be imagined much less duplicated in laboratory tests. Results of such tests are however of great value and give the fireproofing engineer added confidence in developing practical fireproofing designs.

In actual fire conditions temperatures are applied unevenly and intermittently. For instance a certain column may have a high temperature existing near the ceiling and very low temperature near the floor. Later this condition may be reversed. The temperature may be applied against one side of the column and nearly normal temperature exist on the other side. A study of the action of structural steel shapes under high temperatures develops that uneven temperatures have far more effect on the section than even temperatures.

Heating of only the bottom flange or of one end of an I beam causes more distortion than when the heat is uniformly applied over the entire section. Therefore one of the first problems in fireproofing is to equalize this uneven application of heat of actual fire conditions. This may be accomplished by using expensive volume or mass of fire retarding materials of such thickness that the heat cannot penetrate. This practice however calls for the exercise of judgment, as all fire conditions present the

THE NATIONAL PRESSED STEEL COMPANY

probability of the application of fire streams under pressure. Many materials capable of resisting high temperature cannot, regardless of volume, stand up under the combination of high temperature and water applied under pressure.

The most efficient, and certainly the most economical method of equalizing uneven temperatures, is by use of the air space. A beam completely encompassed on both sides and underneath with an air space not less than one inch thick under the lower flange cannot be heated much in excess at any one point. If high temperature is applied at one end on the lower flange it is in time going to develop increase in temperature on the inside of the fire protection. With the air space this increase in temperature will be immediately distributed over the entire section. An enormous amount of heat must be applied on any given area in order to develop a material increase in temperature throughout the extent of the air space around the section.

The next point for consideration is the type of fire retarding covering to use. Aligning the desirable features the following conditions fully met would represent a truly satisfactory condition:

(1) Low Depreciation under Maximum Fire Conditions.

This calls for rugged resistance under combined application of high temperatures and water. Minimum of expense to repair back to pre-fire efficiency.

(2) Maximum Protection.

Accepted standards of maximum fire conditions call for application of 1700° F. for four hours followed with application of 1½" fire streams under 85 pounds nozzle pressure. This condition is of course very unusual in actual fires but gives a good gauge for determining fire retarding efficiency. The protection used should hold the temperature in the air space to less than 600° F.

(3) Thickness of Material.

If for nothing more than commercial reasons it is desirable to use even at higher cost that design of protection taking up the least area.

(4) Simplicity of Installation.

The elimination of the personal element in construction work always gives greater uniformity and security in results. That form of protection presenting the simplest construction problem and permitting the more positive inspection will always give the more uniform service.

(5) Economy.

In the last analysis costs always enter as a deciding

Fireproofing Structural Steel Beams

Steel Joist Supported on Top Flange

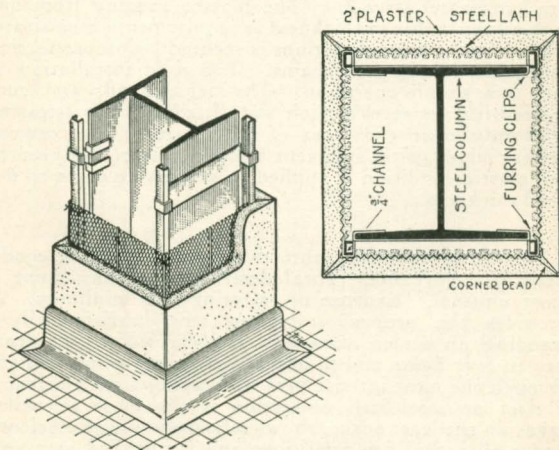
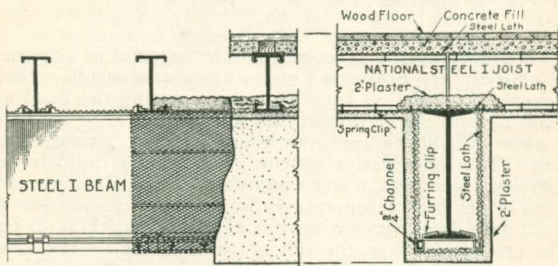

Column Fireproofing

The fire protection is rigidly secured to the steel section. The result is a combination of materials providing the most rugged resistance to high temperature fire conditions.

factor in the type of construction. That protection affording the desired efficiency at the least cost will be more universally used and developed to the highest standard of general practice.

Hollow clay tile three to four inches thick is accepted as efficient fire protection to columns and beams. This material provides an easy means of securing the dead air space around the section in case of columns. For beams it is more difficult to apply without fitting snug to the section. The depreciation of the protection is rapid under combined heat and water conditions. Tile does not expand under high temperatures in the same proportion as steel. In column protection this results in cracking of the tile protection near the top of the column. Tile does however give measurably good protection and is easily installed at a reasonable cost.

Cement plaster on steel lath provides a rugged efficient fire barrier, see page 7. The plaster ranging from one inch to two inches in thickness as requirements necessitate. The air space around sections is secured by proper furring for either columns or beams. The rigid installation of lath is a simple operation. The lath expands and contracts with the steel section and distributes this stressing uniformly over the area of the plaster. The cement mortar mixed with sufficient hydrated lime to give proper plastic condition is applied in successive coats to desired thickness.

The resistance of this protection to most exacting conditions is remarkable. Total destruction at any point is most unusual. Expense of restoring is a minimum. It provides the proper protection most satisfactorily—standing up under maximum artificial conditions from two to four hours and in actual conditions going straight through the most intense fires with unimpaired efficiency. Plaster on steel lath protection is the most scientific, takes up the least space, shows relatively higher efficiency under all actual fire conditions and is installed at a cost within the range of all builders. Cement plaster on steel lath is a good method of fireproofing structural steel. It is adaptable to all locations and types of buildings. Details of application are shown on pages 107 and 109.

FOOTING DESIGN

The following tabulated information has been developed for the purpose of aiding in the design of simple footings. The method of design is that recommended by the University of Illinois. The application of this design is illustrated by example.

Unit stress in concrete.....	650 lbs. per sq. inch
Unit stress in steel.....	16,000 lbs. per sq. inch
Unit bond stress.....	100 lbs. per sq. inch
Unit punching shear.....	120 lbs. per sq. inch
Unit bearing of steel plate.....	500 lbs. per sq. inch

Assume a column load of 600,000 lbs., soil pressure of 8,000 lbs. per sq. ft., Weight of footing 390 lbs. per sq. ft.

The net soil pressure will be :
 $8,000 - 390 = 7,610$ lbs. per sq. ft.

The area of footing will be :

$$\frac{600,000}{7,610} = 79 \text{ sq. ft.}$$

Make footing 9'0" square.

Allowing 500 lbs. per sq. in. for bearing the area of steel base plate will be:

$$\frac{600,000}{500} = 1200 \text{ sq. in.}$$

Make plate 35" square.

Make top of footing 39" square to give good full bearing for plate.

The effective depth of the footing equals the column load less the weight of the footing, divided by the perimeter of the base plate multiplied by the unit punching shear.

$$\frac{600,000 - (81 \times 390)}{35 \times 4 \times 120} = 34 \text{ in.}$$

To this effective depth add 3" for protection of steel, giving a total depth of 37".

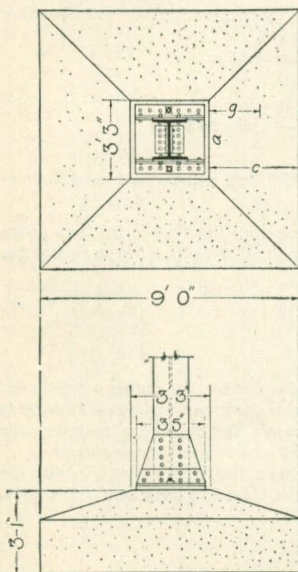

THE NATIONAL PRESSED STEEL COMPANY

The center of gravity of the projecting side of the footing =

$$g = \frac{\frac{(2.92 \times 3.04)}{2} + \frac{2}{3} \text{ of } (3.04) \times 2}{2.92 + 3.04} = 1.78 \text{ ft.}$$

The Bending Moment =

$$\frac{2.92 + 9}{2} \times 3.04 \times 7610 \times 1.78 = 243,000 \text{ ft. pounds.}$$

The resisting moment for the steel per sq. in. =

$$16,000 \times .87 \times 2.83 = 39,400 \text{ lbs.}$$

$$As = \frac{243,000}{39,400} = 6.17 \text{ sq. in.} = 20 - \frac{5}{8}'' \text{ round bars.}$$

The number of bars necessary to hold within the unit bonding stress of 100 lbs. per sq. inch equals:

The perimeter of a $\frac{5}{8}''$ round bar = 1.96 in.

$$\frac{\frac{2.92 + 9.0}{2} \times 3.04 \times 7610}{100 \times 1.96 \times 87 \times 34} = 24 \text{ bars.}$$

Therefore 24 - $\frac{5}{8}''$ round bars 8'9" long will be used in each direction.

The tables give quantities of materials involved in footings under various loadings for soil pressure values of 4,000, 6,000 and 8,000 lbs. per sq. ft.

Good engineering calls for a footing design that amply provides for the loads applied. Under-designing is dangerous and over-designing is useless waste. In making an alternate design always re-design the footings and insure obtaining the full economy in the use of steel.

Inherent merit in materials used has a great deal more to do with the strength and durability of a structure than does mere bulk and weight.

THE NATIONAL PRESSED STEEL COMPANY

FOOTING TABLE

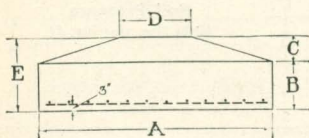

Soil Pressure
4000 lbs. per sq. ft.

A	Col. Load	Minimum Area Base Plate Sq. In.	B	C	D	E	Round Bars Each Way		Wt. of Steel Lbs.	Volume of Concrete Cu. Ft.
							No	Size		
4'-0"	62,000	121	10	5	14	15	9	1/2"	45.5	17.0
4'-6"	78,000	144	10	6	15	16	11	1/2"	62.5	22.2
5'-0"	96,000	196	11	6	17	17	12	1/2"	77.0	29.8
5'-6"	116,000	225	12	7	18	19	13	1/2"	91.5	38.7
6'-0"	138,000	256	13	7	19	20	14	1/2"	104.0	49.4
6'-6"	161,000	361	13	7	22	20	16	1/2"	134.0	59.9
7'-0"	186,000	361	15	7	22	22	17	1/2"	154.0	76.3
7'-3"	200,000	400	15	8	23	23	18	1/2"	170.0	84.3
7'-6"	214,000	441	16	8	24	24	19	1/2"	185.0	94.5
7'-9"	228,000	441	16	9	24	25	19	1/2"	191.0	103.0
8'-0"	240,000	484	16	9	25	25	21	1/2"	218.0	110.9
8'-3"	255,000	529	16	9	26	25	23	1/2"	246.0	117.7
8'-6"	272,000	576	17	9	27	26	24	1/2"	266.0	132.0
8'-9"	288,000	576	17	9	27	26	16	5/8"	283.0	140.8
9'-0"	303,000	625	17	10	28	27	17	5/8"	310.0	150.8
9'-3"	318,000	625	18	10	28	28	18	5/8"	338.0	165.9
9'-6"	333,000	676	18	10	29	28	19	5/8"	366.0	175.2
9'-9"	352,000	676	18	11	29	29	19	5/8"	376.0	190.4
10'-0"	370,000	729	18	11	30	29	19	5/8"	386.0	199.0
10'-3"	388,000	729	20	10	30	30	20	5/8"	416.0	222.0
10'-6"	405,000	784	20	11	31	31	20	5/8"	426.0	235.5
10'-9"	423,000	841	20	11	32	31	20	5/8"	437.0	245.7
11'-0"	442,000	841	20	12	32	32	21	5/8"	470.0	266.0
11'-3"	463,000	900	20	12	33	32	22	5/8"	505.0	278.9
11'-6"	484,000	961	22	11	34	33	22	5/8"	515.0	306.5
11'-9"	504,000	961	22	12	34	34	23	5/8"	550.0	326.1
12'-0"	524,000	1024	22	12	35	34	23	5/8"	563.0	339.7

THE NATIONAL PRESSED STEEL COMPANY

FOOTING TABLE

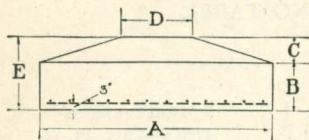

Soil Pressure
6000 lbs. per sq. ft.

A	Col. Load	Minimum Area Base Plate Sq. In.	B	C	D	E	Round Bars Each Way		Wt. of Steel Lbs.	Volume of Concrete Cu. Ft.
							No	Size		
3'-0"	53,000	100	9	5	13	14	8	1/2"	29.0	9.1
3'-6"	72,000	144	10	5	15	15	10	1/2"	43.0	13.1
4'-0"	94,000	196	11	6	17	17	11	1/2"	55.0	19.2
4'-6"	118,000	256	12	6	19	18	13	1/2"	74.0	25.9
5'-0"	146,000	289	13	7	20	20	14	1/2"	89.0	35.0
5'-3"	160,000	324	14	7	21	21	15	1/2"	100.0	41.1
5'-6"	176,000	361	14	8	22	22	16	1/2"	112.0	46.5
5'-9"	192,000	400	15	8	23	23	16	1/2"	118.0	53.7
6'-0"	208,000	400	16	8	23	24	17	1/2"	131.0	61.3
6'-3"	226,000	441	16	9	24	25	17	1/2"	136.0	68.3
6'-6"	244,000	484	17	9	25	26	18	1/2"	151.0	77.5
6'-9"	262,000	529	18	9	26	27	18	1/2"	157.0	87.2
7'-0"	282,000	576	18	10	27	28	19	1/2"	171.0	96.0
7'-3"	302,000	625	19	10	28	29	19	1/2"	178.0	107.3
7'-6"	322,000	625	20	10	28	30	20	1/2"	194.0	119.4
7'-9"	344,000	676	20	11	29	31	21	1/2"	210.0	130.3
8'-0"	366,000	729	20	11	30	31	23	1/2"	238.0	139.0
8'-3"	389,000	784	21	11	31	32	24	1/2"	256.0	153.4
8'-6"	412,000	841	22	11	32	33	25	1/2"	276.0	169.0
8'-9"	435,000	900	22	12	33	34	26	1/2"	296.0	182.6
9'-0"	461,000	900	23	12	33	35	28	1/2"	328.0	199.9
9'-3"	486,000	961	24	12	34	36	20	5/8"	376.0	217.8
9'-6"	512,000	1024	24	12	35	36	21	5/8"	406.0	230.5
9'-9"	539,000	1089	24	13	36	37	22	5/8"	437.0	246.4
10'-0"	566,000	1156	25	13	37	38	22	5/8"	449.0	267.1
10'-3"	594,000	1225	26	13	38	39	23	5/8"	480.0	290.1
10'-6"	622,000	1225	26	14	38	40	24	5/8"	514.0	309.0
10'-9"	650,000	1296	27	14	39	41	25	5/8"	547.0	333.6
11'-0"	681,000	1369	27	14	40	41	27	5/8"	606.0	349.2
11'-3"	711,000	1444	28	14	41	42	28	5/8"	644.0	375.8
11'-6"	744,000	1521	28	15	42	43	29	5/8"	681.0	398.6

FOOTING TABLE

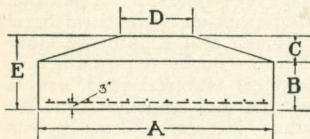

Soil Pressure
8000 lbs. per sq. ft.

A	Col. Load	Minimum Area Base Plate Sq. In.	B	C	D	E	Round Bars Each Way		Wt. of Steel Lbs.	Volume of Concrete Cu. Ft.
							No.	Size		
2'-6"	49,000	100	8	5	13	13	8	1/2"	24.0	5.7
3'-0"	71,000	144	10	5	15	15	10	1/2"	37.0	9.7
3'-6"	96,000	196	11	6	17	17	11	1/2"	48.0	14.9
4'-0"	125,000	256	12	7	19	19	13	1/2"	65.0	21.4
4'-3"	141,000	289	13	7	20	20	14	1/2"	75.0	25.6
4'-6"	158,000	324	14	7	21	21	14	1/2"	80.0	30.4
4'-9"	176,000	361	14	8	22	22	15	1/2"	90.0	35.1
5'-0"	195,000	400	15	8	23	23	16	1/2"	101.0	40.9
5'-3"	215,000	441	16	8	24	24	17	1/2"	114.0	47.3
5'-6"	236,000	484	16	9	25	25	17	1/2"	119.0	53.4
5'-9"	257,000	529	17	9	26	26	18	1/2"	132.0	61.2
6'-0"	279,000	576	18	9	27	27	19	1/2"	146.0	69.4
6'-3"	303,000	625	18	10	28	28	20	1/2"	160.0	77.0
6'-6"	327,000	676	19	10	29	29	20	1/2"	167.0	86.9
6'-9"	352,000	729	20	10	30	30	21	1/2"	183.0	97.5
7'-0"	378,000	784	20	11	31	31	22	1/2"	198.0	107.3
7'-3"	405,000	841	21	11	32	32	23	1/2"	215.0	119.5
7'-6"	434,000	900	22	11	33	33	23	1/2"	223.0	132.5
7'-9"	462,000	961	22	12	34	34	24	1/2"	240.0	144.0
8'-0"	491,000	1024	23	12	35	35	25	1/2"	259.0	159.2
8'-3"	522,000	1089	24	12	36	36	26	1/2"	278.0	174.5
8'-6"	554,000	1089	25	13	36	38	26	1/2"	286.0	194.0
8'-9"	586,000	1156	26	13	37	39	28	1/2"	318.0	212.5
9'-0"	619,000	1225	26	14	38	40	29	1/2"	339.0	229.1
9'-3"	652,000	1296	27	14	39	41	31	1/2"	373.0	248.6
9'-6"	689,000	1369	28	14	40	42	23	5/8"	445.0	269.7
9'-9"	724,000	1444	28	15	41	43	24	5/8"	476.0	288.6
10'-0"	760,000	1521	29	15	42	44	24	5/8"	487.0	312.3

COMPARISON OF DEAD WEIGHT IN FLOOR SLAB ITS EFFECT ON COST AND HEIGHT OF BUILDING

Many interesting facts are developed by a parallel comparison between Steel Construction (Structural Steel Skeleton and Steel Lumber Floors) and Reinforced Concrete Construction. The difference in the required height of building, weight and volume of material used, usable floor area in the finished buildings and length of time for construction are all important factors. These points should all be analyzed and considered before the design of the structure is started.

Steel Joist floors have a very low dead weight (35 to 40 pounds per square foot) and thereby reduce the total load to be carried by the beams. The loads supported by these members are reflected in the reduced size of steel columns, and further in the footings which carry the total load.

In steel construction strength and stability are provided by individual steel members of known quality. The high unit strength of steel results in comparatively small structural members. As compared with reinforced concrete, the floors and particularly the beams, are usually reduced in depth and the columns less in area.

Referring to the floor slab sections shown on page 131, the concrete joist design using steel cores is the lightest weight concrete slab shown. This floor slab design has proven its efficiency and is in many parts of the country the most economical of any shown excepting steel joists.

The development of the concrete joist design of floor slab was a big step in advance. Originally secured by the use of hollow tile it reduced dead load of slab and increased the length of economical span. The further development of the steel core increased the efficiency of the concrete joist floor slab, the basic efficiency of the design and the later increased efficiency by use of steel cores being entirely due to the resulting decrease in dead load. This reduction in dead load means saving of material to handle and reduced cost in all supporting parts of the building.

In principle this idea is carried further in the steel joist floor slab. Further reduction of weight is accomplished by reverting back to a steel unit for all stress resistance, fire resistance being maintained by retention of the concrete slab above and plaster on steel lath ceiling below.

To clearly demonstrate the difference in materials involved and one reason for the basic efficiency and

THE NATIONAL PRESSED STEEL COMPANY

economy of steel joist floors, examine a floor slab design. Building area—100' x 200' with three rows of columns giving slab span of approximately 24 feet. Live load 60 lbs. per sq. ft. Leave out the lath and plaster ceiling and wood floor finish, as they are the same in either case. Do not consider beams, columns and footings, although they only add to the saving in materials.

CONCRETE JOIST FLOOR SLAB 12" Steel Core—3" Concrete.

Item	Weight
Reinforcing steel.....	29,300 lbs.
Steel cores.....	35,500 "
End caps.....	1,200 "
97 cu. yds. concrete (fill between screeds)	
463 " " " (structural)	
615 cu. yds. gravel (10% waste).....	1,700,000 "
275 " " sand (10% waste).....	725,000 "
695 bbls. cement.....	264,000 "
64,000 B. F. form lumber.....	202,000 "
Total.....	2,957,000 lbs.

Approximately 75 carloads of material.

STEEL JOIST FLOOR SLAB

Item	Weight
404 Pcs. 12" @ 12 lbs. joist.....	119,300 lbs.
103 cu. yds. concrete (fill between screeds)	
113 cu. yds. gravel (10% waste).....	310,000 "
48 " " sand (10% waste).....	130,000 "
110 bbls. cement.....	41,800 "
2220 sq. yds. steel lath.....	8,900 "
Total.....	610,000 lbs.

Approximately 15 carloads of material.

On less than 20,000 sq. ft. of floor area a total difference in weight of materials involved in the construction of the two slabs, which amounts to a saving of—

2,347,000 pounds
1,173 tons
60 carloads.

Sixty carloads of material that does not have to be transported, carted, hoisted, manhandled and supported in position during the life of the building. In one instance a floor slab involving the use of 1,479 tons of material to support a specified live load of 570 tons. In the steel joist

THE NATIONAL PRESSED STEEL COMPANY

construction a slab weighing 305 tons to support the specified live load of 570 tons.

Where storage space around a job is limited and where cartage haul is more than an average distance the question of volume and weight of materials assumes great importance. The importance of this reduced dead weight of floors is illustrated on page 119. This shows a typical column section designed for concrete construction and steel construction respectively, required for a building containing six stories and basement having floor panels 20 ft. square and live loads as follows: First floor 125 lbs., second floor 100 lbs., upper floors 70 lbs., and roof 40 lbs. per square foot. The clear story heights were measured from top of finished floor to under side of projecting beam, thus establishing the total height of building in each construction.

The weights given are for construction materials only (dead load) including items of finish as wood floors, plaster and fireproofing.

Materials in one section	Concrete	Steel
Weight of floors and roof including beams (pounds)...	356,000	138,000
Weight of columns.....	47,750	12,560
Total weight on footing (pounds)	405,520	150,560
Excavation for footing . . . cu. yds.	10.00	cu. yds. 2.53
Volume of concrete in footing.....	“ “ 8.72	“ “ 2.02
Weight of reinforcing steel in footing	pounds 426	pounds 119

The weights enumerated above represent only one section of the building as shown on drawings. The total saving will be this difference multiplied by the number of columns in the building.

The cost saved due to decreased height of building exceeds the column and footing savings. In this example the height of building is reduced approximately 5%, resulting in a corresponding saving of that much brick work all around the building and the same per cent of partition materials, surfaces of wall and partitions to be plastered, length of piping, conduits and similar items.

This example is worthy of very careful consideration. The same savings apply on practically every building operation.

SPECIFICATIONS

The following specifications have been developed for the purpose of aiding Architects in properly specifying Steel Lumber Construction and to aid Building Inspectors in drafting building code sections. The specifications can be used with absolute confidence either in whole or part as they represent the best thought and what is standard practice at the present time.

Description

Steel Joist floor construction to consist of steel joists of proper size and weight for the spacing used with given loading and span. In no case shall steel joists be of lighter weight for given spacing than shown on plans. Joists are placed parallel to each other on supporting beams, partitions or walls, secured as shown by detailed drawings and bridged at approximately the one-third span points or about 6'0" c-c with steel cross bridging.

Over the joists a layer of painted 24 gauge diamond mesh rib lath is placed as a centering and reinforcing for the concrete slab. Under the joists the same kind of steel lath reinforces and supports the plaster ceiling.

Steel Joists

The steel joists to be made up of two symmetrical channel sections placed back to back and securely spot welded together. The steel shall conform to the following requirements as to chemical composition:

Phosphorus	{	Acid.....	not over	0.06	per cent
		Basic.....	" "	0.04	" "
Sulphur.....		" "	" "	0.05	" "

The thickness of steel to be not less than .072-inch (No. 15 Gauge Birmingham). Flanges not to extend more than 2½ inches from the web of the joist. All steel entering into the manufacture of these sections must show an ultimate tensile strength of not less than 64,000 lbs. per sq. in. of section, and elongation percentage equal to 1,400,000 divided by the ultimate strength, and an elastic limit of not less than one-half the ultimate strength.

Full facilities must be provided for the inspector to make, or have made, physical or chemical tests as in his judgment are necessary to determine the quality of material.

All Steel Lumber sections shall be given a dipped coat of paint before shipment to destination.

Bridging

Bridging shall be at least 1" wide, not less than No. 20 gauge steel supplied in continuous lengths. Bridging to be secured to top and bottom of joists by 6d nails driven into the web. Single straps of not less than size and gauge above specified may be used. These straps shall extend from top flange of joist to the lower flange of adjoining joist. The straps must be drawn taut and fastened to the joists by bending the ends over flange and around and under secondary flange of joist. Rows of cross bridging should be placed at approximately the one-third points of span.

Steel Lath

Steel Lath shall be painted diamond mesh rib lath made from No. 24 Gauge steel and shall weigh not less than 4 pounds per square yard. Ribs shall run parallel with length of sheet and occur at regular intervals of 4 inches across width of sheet. Lath shall always be applied with the long way of the sheet at right angles to joist.

Floor Lath

Floor Lath shall be placed on joists with ribs up and secured by means of spring clips about 12 inches on centers or by large headed roofing nails driven into web of joists. Ends of sheets shall lap directly over joists; sides shall lap by nesting ribs of adjoining sheets. Floor lath shall not be placed until floor is ready to receive concrete fill.

Ceiling Lath

Ceiling lath shall be applied with ribs up and in direct contact with joists. End laps shall occur under joists. Side laps shall be made by nesting ribs of adjoining sheets. Side laps shall be wired once at midway between supports. Lath shall be secured to the joists by means of spring clips spaced not over 8" on centers and applied in a manner to provide an even and rigid surface for plastering.

Lath Clips

Clips for fastening the steel lath shall be made from spring steel, so designed as to support lath over the full width of joist flange.

Floor Filling

The top lath is covered with floor filling as specified and shown on drawings and floor finish then applied.

Nailing Strips

Where wood floor finish is specified a $1\frac{3}{4} \times 1\frac{3}{4}$ " screed or nailing strip shall be placed on top of the lath, parallel with and centering over the joists. This screed to be securely nailed to the web of the joists at frequent intervals with 16d nails. The floor filling between screeds leveled off and lightly tamped slightly below their surface. Wood floor finish to be nailed directly to the screeds.

Supporting Partitions

Steel studs for supporting partitions shall consist of channel or I sections of sufficient strength to carry the load of floors to be supported. All connections shall be made with $\frac{5}{16}$ inch stove bolts or rivets. The steel lath shall be attached to studs with lath clips.

Spacing

In no case shall joists in floor construction, or any studs in bearing partition construction, be spaced more than 24" c-c. In roof construction where steel lath and a concrete slab are used above the steel joists, the joists shall not be spaced more than 30" c-c. Where steel joists are used to support cement tile on flat roofs spacing of the joists may be increased to meet the tile requirements, provided the joists are tied together at intervals not exceeding 6'0" on center by a half inch round steel tie rod securely fastened through the joists at each end of the rods. The punching or holes for rod connections to be along the neutral axis of the joists.

Bearings

Where steel joists are supported by masonry walls, the joist shall have end bearing measured along the web of the joists equal at least to one-half the depth of the joists, and in no case less than 4". Where steel joists are supported by rolled structural sections, the bearing for all sizes of joists to be at least $2\frac{1}{2}$ ".

Steel joists supported by structural steel beams may be placed on top of the structural beams or on shelf angles riveted to webs of structural beams. The steel joists shall not be riveted or bolted to beams excepting under special conditions where standard details would not apply. Steel joists supported on top flanges of beams shall be fastened with clips designed for this purpose. Joists supported on shelf angles require no fastening.

Where necessary to make bolted or riveted connections between steel lumber sections or between steel lumber and rolled steel sections, use $\frac{5}{16}$ " stove bolts or $\frac{5}{16}$ " soft cold headed rivets. This to apply excepting where special conditions require other connections. In every instance standard practice applying to shear on rivets will govern each connection.

Plaster Used with Steel Lumber

All plaster used on ceilings and walls in connection with steel lumber sections shall be an accepted prepared plaster, prepared and mixed according to the manufacturer's instructions, or other plaster, but shall in any case have fire retarding qualities equal to cement plaster of the following proportions and mix:

Cement Plaster: The first (scratch) coat shall consist of one part of Portland cement, one-tenth part of hydrated lime, one-tenth part of wood fibre and two and one-half parts of clean, sharp sand. All parts by volume, a sack of cement being counted as one cubic foot. All shall be mixed together dry until a uniform color and then water added to required consistency. Add sufficient long cattle hair or cocoanut fibre to bond mortar (about two pounds per bag of cement). Apply with considerable pressure, obtaining a good key and completely covering the steel lath, and then roughen the surface by scratching diagonally in both directions.

The second (brown) coat to be of the same mixture with the hair omitted, and should be applied to the first coat after the latter has hardened sufficiently, but before it has become dry.

Immediately before the application of the second coat, or any subsequent coat, the preceding coat to be well drenched with water applied with a brush or through a hose provided with a sprinkler nozzle. Bring second coat to a true and even surface within one-eighth inch to three-sixteenths inch of the face of the grounds. After this coat has been darbied and straightened in all directions lightly scratch same with a scratcher.

The finish coat to be one part Portland cement, one-tenth part of hydrated lime and two and one-half parts of clean, sharp sand. After the second coat has set firm and hard, but while still green (within twelve hours after wall has been browned out) apply a finish coat of the above mixture with a trowel and float it with a cork or carpet float to a true and even granular surface, using plenty of water in floating to secure an even surface.

Suspended Ceilings

Suspended ceilings shall be constructed of $\frac{3}{4}$ " rolled channels spaced 2'0" c-c and secured with No. 12 gauge wire to $1\frac{1}{2}$ " rolled channels spaced 3'6" to 4'0" c-c, which in turn shall be suspended with $\frac{3}{16}$ " soft wire spaced 3'6" to 4'0" c-c secured by looping over joist above, before concrete has been placed. Apply same rib lath as specified heretofore to the $\frac{3}{4}$ " channels with No. 16 gauge soft wire.

Supporting Columns and Beams

The Structural Steel skeleton frame which is an integral part of Steel Lumber Construction shall be protected as follows:

Beams

Structural steel beams supporting Steel Joist floors shall be protected from high temperatures by extending the ceiling lath down the exposed sides of the beam below the bottom of the joists and under the beam. This lath to be securely fastened on a rigid frame work clipped to the beam. Plaster as above specified to be applied to this lath, adding extra coats to bring the total thickness to $1\frac{1}{2}$ " or 2" as required.

Columns

Structural steel columns shall be protected from high temperatures by plastering on steel lath securely fastened to a frame clipped to the column section. Plaster to be applied in successive coats to required thickness of $1\frac{1}{2}$ " or 2".

Note—In every case the protection around structural steel columns and beams to be applied in such a manner as to provide an unbroken air space around the section.

FRAMING OPENINGS

Steel Lumber Sections are used for framing only around the smaller openings as hot air pipes, ventilating flues, dumb-waiters and the like. Details as shown on page 80. For larger openings as stairwells, light shafts or skylights, where the framing members act as headers and trimmers, the resulting concentrated load is often heavier than can be economically carried on Steel Lumber sections. In such cases structural steel beams or channels are commonly used as framing members. Details as shown on page 81. Tables of carrying capacity of structural sections for steel joist sizes are given on page 126. For concentrated loading conditions use formulas, pages 158 and 159.

Header and trimmer members should always be the same depth as the joists in order to preserve the flat ceiling and uniform thickness of floor. In first floor construction in some types of buildings, as in residences, an I section can be used as a column under framing points. This reduces the concentrated loading condition and often permits the use of Steel Lumber sections as framing members. Details page 146. Where architectural conditions show supporting partitions alongside of openings the framing can be handled as per details, page 147.

In every case the determination of concentrated loads and required framing members is a straight designing problem. All framing members should be securely framed. The details of construction as shown in this handbook represent common practice.

FRAMING MEMBERS

Safe Loads in Pounds Uniformly Distributed for
Standard Structural I Beams.

Safe Loads are Figured for Fibre Stress of 16,000 Pounds per Square Inch and Include Weight of Beam.

Size	4"	5"	6"	7"	8"	9"	10'	12"	Size
Wt.	7.7	10.0	12.5	15.3	18.4	21.8	25.4	31.8	Weight
6'	5300	8600	12910	18400	25280	6'
7'	4540	7370	11070	15770	21670	7'
8'	<u>3980</u>	6450	9680	13800	18960	25160	8'
9'	3530	5730	8610	12270	16850	22370	9'
10'	3180	<u>5160</u>	7750	11040	15170	20130	26050	38370	10'
11'	2890	4690	7040	10040	13790	18300	23680	34880	11'
12'	2650	4300	<u>6460</u>	9200	12640	16770	21710	31970	12'
13'	2450	3970	5960	8490	11670	15480	20040	29510	13'
14'	2270	3680	5530	<u>7890</u>	10830	14380	18610	27400	14'
15'	2120	3440	5160	7360	10110	13420	17360	25580	15'
16'	3220	4840	6900	<u>9480</u>	12580	16280	23980	16'
17'	3030	4560	6490	8920	11840	15320	22570	17'
18'	4300	6130	8430	<u>11180</u>	14470	21310	18'
19'	<u>4080</u>	5810	7980	10590	13710	20190	19'
20'	5520	7580	10064	<u>13020</u>	19180	20'
21'	5260	7220	9590	12400	18270	21'
22'	6890	9150	11840	17440	22'
23'	6590	8750	11320	16680	23'
24'	8390	10850	<u>15990</u>	24'
25'	8050	10420	15350	25'
26'	10020	14760	26'

For safe loads below the heavy lines, the deflections will be greater than the allowable limit for plastered ceilings—1/360 of span.

THE NATIONAL PRESSED STEEL COMPANY

FRAMING MEMBERS

Safe Loads in Pounds Uniformly Distributed for
Standard Structural Channels.

Safe Loads Figured for Fibre Stress of 16,000 Pounds per
Square Inch and Include Weight of Channel.

Size	4"	5"	6"	7"	8"	9"	10"	12"	Size	
Weight	5.4	6.7	8.2	9.8	11.5	13.4	15.3	20.7	Weight	
Clear Span in Feet	6'	3370	5270	7700	10710	14360	18690	6'
	7'	2890	4520	6600	9180	12310	16020	7'
	8'	<u>2530</u>	3960	5780	8030	10770	14020	8'
	9'	2250	3520	5130	7140	9570	12460	9'
	10'	2020	<u>3160</u>	4620	6430	8610	11220	14270	22780	10'
	11'	1840	2880	4200	5840	7830	10200	12970	20700	11'
	12'	1690	2640	<u>3850</u>	5360	7180	9350	11890	18980	12'
	13'	1560	2430	3550	4940	6630	8630	10980	17520	13'
	14'	1440	2260	3300	<u>4590</u>	6150	8010	10190	16270	14'
	15'	1350	2110	3080	4280	5740	7480	9510	15180	15'
	16'	1980	2890	4020	<u>5380</u>	7010	8920	14230	16'
	17'	1860	2720	3780	5070	6600	8390	13400	17'
	18'	2570	3570	4790	<u>6230</u>	7930	12650	18'
	19'	2430	3380	4530	5900	7510	11990	19'
	20'	3210	4310	5610	<u>7130</u>	11390	20'
	21'	3060	4100	5340	6790	10850	21'
	22'	3920	5100	6490	10350	22'
	23'	3750	4880	6200	9900	23'
	24'	4670	5940	<u>9490</u>	24'
	25'	4490	5710	9110	25'
	26'	5490	8760	26'

For safe loads below the heavy lines, the deflections will be greater than the allowable limit for plastered ceilings—1/360 of span.

Garage Floors

In garage construction the floors offer special problems, particularly in view of the uncertainty of future developments in the Automotive industry. The questions arising in this class of buildings revolve around the application of concentrated loads. In steel joist floor construction this necessitates special consideration of the concrete slab over the joists and spanning between them. Experience has shown that when the joists are spaced 16" on centers that 2" of concrete on steel lath will support all concentrated loads which happen to apply between joists.

In analyzing the slab this efficiency is hard to verify by theoretical designing. This for two reasons:—first, The slab is so perfectly reinforced by the expanded metal (steel lath) that higher loading values are secured than safe designing principles as applied to ordinary concrete work will theoretically develop. Second, The loads as applied on garage floors are not actually concentrated loads when the short net length of the slab span is considered. This span in most cases does not exceed twelve inches between joist flanges. Truck wheels are now designed so that the bearing area increases with the loading capacity. A load is not applied along a line but is applied over an area of some width and length. It is more nearly a uniform loading than a concentrated loading as far as the concrete slab over the joists is concerned.

The large open area in garages makes it advisable that attention be given to proper provision against cracking from expansion and contraction. The floor should be divided into panels by expansion joints or reinforced with temperature reinforcing bars.

Satisfactory results will always be secured on garage floors by spacing the joists 16" c-c laying a concrete slab on top of the floor lath with a finished thickness of two and one half inches and cutting expansion joints about twelve feet on centers each way.

In designing floors always give attention to that factor which because of the intended occupancy assumes relatively the greatest importance. In garage floors for instance the strength of the concrete slab between joists to support concentrations of loading. On the other hand if designing a dance hall floor the question of rigidity is more important. In such case it is better to use a deeper joist on a wider spacing. The greater joist depth giving greater rigidity.

STRENGTH OF SLAB ON JOISTS

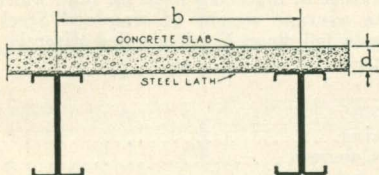

When floors are finished in concrete, tile or the like, the concrete slab over the joists carries the floor loads between joists. These loads may be concentrated as in case of partitions or heavy safes. The table below gives the safe uniform square foot loading and safe concentrated loadings applied between the joists. This table does not take into consideration the reinforcement value of bars that may be used as temperature reinforcement although such bars add considerable to the transverse strength of the concrete slab on top of Steel Joists.

TOTAL SAFE LOADS

W = Load per Square Foot, Uniformly Distributed.

P = Load Concentrated at Center of Span.

Thickness of Slab "d"	Area of Steel per Foot of Width of Slab	SPAN "b"							
		12"		16"		19"		24"	
		W	P	W	P	W	P	W	P
2"	.135	2136	1600	1606	1200	1285	1012	800	800
2½"	.135	2700	2025	2025	1522	1626	1281	1012	1012
3"	.135	3240	2430	2436	1827	1950	1538	1215	1215

Unit Working Stresses:

Concrete in Compression not over 550 lbs., per square inch.

Tension in Steel not over 16,000 lbs., per square inch.

Unit Shear not over 50 lbs., per square inch.

Weight of National Steel Lumber Floors

The dead weight of floor construction will vary according to the nature of materials used for floor finish. Below is given the average weight of standard Steel Lumber floor having wood floor finish applied directly to wood nailing strips—

	Weight per sq. ft.
Wood Flooring.....	3 lbs.
1¾ inches Concrete.....	21 lbs.
Steel Joists and Bridging (Average).....	4 lbs.
Plaster Ceiling and Lath.....	8 lbs.
Total.....	36 lbs.

In determining the average weight of steel joists a nine inch section spaced 24 inches on centers was assumed.

Cement, Terrazo or Tile floor finishes increase the dead weight of floor to some extent. Usually the total thickness over joists, including the concrete fill and finish, averages 2½ inches, which would increase the total weight of floor construction, after first deducting weight of wood flooring, to 42 lbs. per square foot.

Proper correction in the above table should be made according to size and spacing of joists and nature of floor finish required in the design.

Forty pounds can be safely assumed as the dead load per square foot of finished Steel Joist floor construction. A difference of a few pounds per square foot over an extended floor area is of sufficient importance to warrant actual computation of dead load in every instance.

The floor sections shown on page 131 constitute the more popular types of floor construction. Note the design of each slab. Consider the various factors involved. The strength of the steel joist floor is confined to a section made under conditions permitting of positive inspection and resulting in known uniformity. The fire protection is scientific, practical and utilizes the more dependable merits of the materials involved. The Steel Joist floor is equally as meritorious in every respect as any other type of floor construction ever devised. A comparison of weight, efficiency, merit and cost recommends Steel Joist Floor Construction for favorable consideration.

THE NATIONAL PRESSED STEEL COMPANY

COMPARISON OF WEIGHT PER SQUARE FOOT
VARIOUS FIREPROOF FLOOR CONSTRUCTIONS
WORKED OUT FOR SAME LOADING AND SPAN

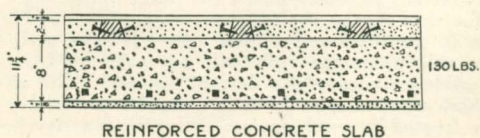
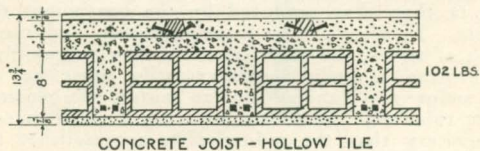
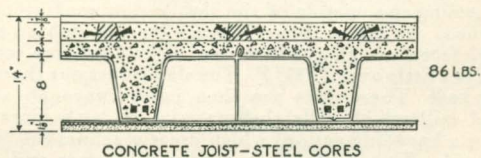
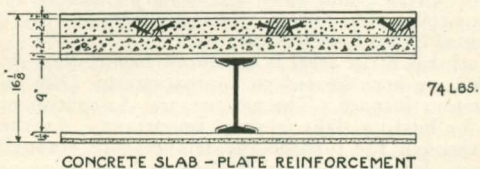
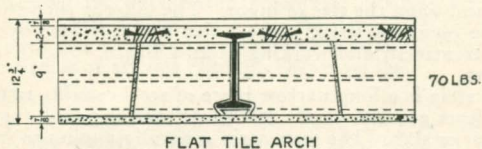
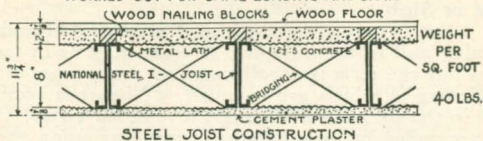

GENERAL INFORMATION

Billet or Slab.

A billet is a semi-finished steel product reduced in a blooming mill from an ingot. A billet may be in various shapes but the term is usually applied to a square section, the corners of which are rounded. When the section is rolled in the shape of a rectangle it is called a slab. Billet bars are rolled in long lengths, depending upon the section and upon the size of ingot. The billet is then sheared to the length desired. The billet bar receives the same heat treatment and working as an I Beam.

Strips.

A strip is a long narrow piece of steel ranging in thickness from approximately $\frac{1}{8}$ " to $\frac{1}{16}$ " and is rolled out from a billet or slab. The term strip generally applies to widths from 4" to 24", and they are usually produced on continuous rolls. The length of strip is from 90 to 130 feet.

National Strip Production.

National Strip Steel is produced from billets or slabs which have been heated to approximately 2100° F. in a continuous furnace. The advantages of a continuous furnace for heating slabs is very important. As the slab goes through the furnace the temperature gradually increases. Instead of a quick burning heat being applied and scaling the outside of the slab a slow soaking heat is obtained. It takes about 3 hours for the slab to travel the 62 feet through our furnaces. The discharge temperature is a little over 2100° F. The slab comes out thoroughly soaked. These slabs are then passed through a universal mill which rolls the material in both directions, giving a kneading action, which greatly refines the fibre of the steel. This results in a steel much softer and easier to work than that produced by the continuous rolling process. In view of the large reduction and the long length of strips, the material cools off very rapidly and the process of reduction necessarily must be rapid. The strips are handled on an automatic electrically driven table and the rolls are all run at high speed. It is necessary that the reduction be accomplished before the material has cooled below the lower recolesence point and for that reason the finished temperature of National Strips is approximately 1300° F. If the strips cool below this point the rolls will not take hold and it is impossible to secure the desired gauges. The effect of this high temperature finish is that the material is absolutely free of internal stresses, being in exactly the same

condition as an annealed sheet with the exception that there has been no reduction in ultimate strength, as is the case with an annealed material.

Coils.

After the strip has been reduced to its proper width and gauge it is coiled to facilitate handling. These coils are then carried to the stock pile. From the stock pile it is handled to the forming machines. At the forming machine the coil is placed on a spindle, one end of the strip introduced into the forming mill and the strip automatically uncoiled as it travels through this machine.

Forming Mill.

The forming mill rolls the strip into a channel section, see sketch. This operation is performed by a series of rolls which gradually form up the desired shape. As the strip enters the forming mill it passes between rolls that run in oil. The main purpose of this oiling process is to facilitate production. It also serves to oil the backs of the channels, preventing any chance for corrosion in the seam of the I joist. Every step in the production of Steel Lumber is a rolling process. The channel sections come from the forming mill in lengths from 90 to 130 feet long.

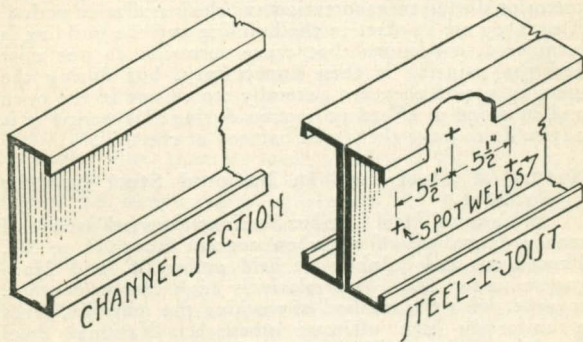

I Joist Welding.

After the steel lumber channels are formed they are sorted for length. Two channel sections are placed back to back, and in this position are passed through an electric spot welding machine which spot welds the webs together. The location of these welds is as shown above.

These welds are $\frac{3}{8}$ " in diameter. The entire elimination of the human equation results in absolute uniformity. The amount and time of current and pressure applied being constant the welds will not break. Tested to destruction a disc is torn out of one of the plates.

Cutting.

A friction type of saw is most suitable for cutting steel joists to desired lengths. This type of saw is designed so that bevel cuts can be made equally as well as straight cuts.

Painting National Sections.

Before Steel Lumber sections are shipped they are dipped in a special asphalt base paint. The method used in dipping the section is to place the joists in neat piles convenient for handling. These piles are then picked up by crane and dipped into a large paint vat. A suction pump forces the paint through the joist stacks insuring complete covering of entire surfaces of all sections. They are then placed on a drying rack for about two hours before loading, then loaded into cars.

Steel Lumber sections are painted to protect them from corrosion during transportation and the installation period. After they are in place in the building and the building is completed, conditions that cause corrosion do not exist and the painting is then unnecessary, but during the erection period they are generally stored out in the open and in order to afford protection during this period it is advisable to have them well painted at the mill.

Nature of Steel used in National Steel Lumber Sections.

In National Steel Lumber Sections the steel used is of standard analysis of a carbon content from .16 to .24. Phosphorus and Sulphur are held under .04, and Manganese under .35. This relatively high carbon content, together with the method of working the material, gives a uniformly high ultimate strength. National Steel Lumber Sections will show a uniform average ultimate strength exceeding 72,000 lbs. per sq. in.

Types of Buildings to which Steel Lumber Construction is more Particularly Adapted.

Steel Lumber construction is efficient from a structural point of view for any class of building. Ordinarily it

is more particularly applicable to those buildings where the live loadings are less than 150 lbs. per sq. ft. On account of the lack of dead weight and inertia it is not a desirable floor construction for heavy factory buildings with vibratory loads. This does not apply, however, for light factory buildings with loadings from 125 to 150 lbs. per sq. ft. The efficiency and basic merit of Steel Lumber construction is more apparent in such buildings as hotels, office buildings, apartment houses, hospitals, garages, schools, residences and the like.

Principal Advantages of Steel Lumber Construction.

The principal advantages of Steel Lumber Construction are its fireproof qualities, sound-proof qualities, durability, economy, adaptability, rigidity, low dead weight, simplicity of design, ease and rapidity of installation and sanitary qualities.

Fireproof Quality.

To start with the elimination of combustible materials in a building always decreases the fire hazard. Secondly, Steel Lumber sections being absolutely free from all internal stresses will not twist or distort under high temperatures as do ordinary structural steel sections. In common with all low carbon steels the material from which steel joists are made reaches its maximum strength under comparatively high temperatures. In fact, National Steel Joists will carry their greatest loads at around 700° F. With plaster on steel lath ceiling applied underneath the joists higher fire temperatures underneath the floor slab will not develop temperatures exceeding 500° F. between the joists. Conservatively speaking at least 90% of the fires in buildings do not develop temperatures exceeding 1200° F., and under these temperatures without any ceiling plaster protection there will be no detrimental effect on the joists. Graph page 6. One and one-half to two inches of concrete on steel lath above the joists furnishes an ample fire block to prevent the spreading of the fire from one floor to another. It is, of course, imperative that in all first class fireproof buildings that plaster on steel lath be applied to ceilings and that the columns and beams supporting the steel lumber be properly protected.

Sound Proof Qualities.

In the study of the transmission of sound it is first necessary to recognize that sound is vibration, and it may be transmitted in buildings either by molecular vibration or by what is termed body vibration. Given any one continuous material a vibration will be transmitted more readily than it will through a series of materials with different densities. In Steel Lumber construction the sound in order to pass through a given floor or partition must pass through first a layer of concrete, then either the steel joists or the air space, then through a layer of plaster. The densities of all these materials are widely different. The result is that it is very difficult to transmit any sound whatever through a Steel Lumber floor or partition. As to body vibration or what would entail the vibrating of an entire floor or partition, the rigidity of the construction precludes the possibility of transmitting sound in this manner. There is practically no information upon the actual relative sound-proof qualities of various building materials, and the only manner in which this can be checked up at present is by actual observation of existing buildings. The question of design and construction enters so prominently into the efficiency of any building as to sound-proof qualities that the relative merit of materials used is of only relative importance. It is a well known fact attested to by hundreds of owners that a Steel Lumber building gives absolute satisfaction on this point.

Durability.

In designing a fire-proof permanent building it is the endeavor of all concerned to construct a building which will have the smallest possible depreciation over the longest term of years. The elements start to cause depreciation as soon as the building is completed, and this depreciation eventually shows up in many ways. Steel is a known material and its durability and permanence under given conditions are established as a result of past experiences. It is known that in buildings there is no opportunity for corrosion of steel excepting for those conditions which may be introduced locally, such as a leaky steam pipe or water pipe. Any such condition is always evidenced immediately under the ceiling plaster and ample opportunity given for correction long before any detrimental results have taken place on the steel structural members—such local conditions occurring very rarely offer no problem for consideration in connection with the durability of steel in building construction. The condition

THE NATIONAL PRESSED STEEL COMPANY

of ceilings, walls and floors as to cracking, etc., is one of the principal features of a Steel Lumber building. All plastered surfaces being mechanically bonded to and reinforced by steel lath give the most highly satisfactory results. Large areas of concrete floors under the hardest usage will stand up with surprisingly little depreciation. In other words, the general appearance of a building after years of usage is the concrete evidence of the durability of the type of construction used. An examination of Steel Lumber structures in comparison with buildings of other types of construction of equal age emphasizes the desirable qualities inherent to the use of this material.

Corrosion.

In order for corrosion to start or continue on steel, moisture and oxygen must be supplied. In buildings the moisture, except from local conditions, must be supplied from the atmosphere. This necessitates condensation which requires a difference in temperature between the steel and the surrounding air. As the temperature around the steel is the same at all times this condition cannot exist and corrosion cannot follow.

With structural steel columns and beams protected with steel lath and plaster supporting the standard steel joist floor construction the structure will never deteriorate because of corrosion. This applies regardless of the location or relative humidity.

Economy.

The relative economy of any construction is directly dependent on the cost of materials, efficiency of labor, time consumed in erection, cartage and handling.

The materials involved in Steel Lumber construction are not cheap. Concrete is of course relatively the same as in any other type of design. Steel Lath is a high class material involving an expensive manufacturing process. Steel Joists are more expensive per pound than reinforcing bars or rolled I beams. This directly resulting from a necessarily more expensive production process. However the combination of these materials in such a manner as to take advantage of the merits of each gives a most economical result. Comparing the cost of all the materials involved in steel joist floors with those of other designs will usually show a favorable saving. The dead weight of a finished steel joist floor slab is approximately thirty-eight (38) pounds per sq. ft. This weight is only one-third to one-half of other equally efficient designs. This reduction in weight materially reduces the size of main carrying girders and supporting columns, making a saving in

THE NATIONAL PRESSED STEEL COMPANY

materials involved in the entire skeleton frame and all footings. To secure the full benefit of the possible savings in materials a careful analysis should be made of every structural portion of the building.

The efficiency of labor on an operation does not necessarily mean the actual degree of application of each individual. More important is the opportunity for efficiently applying the labor so as to more quickly gain the desired end. Compare the simplicity of steel construction with others. The usual muss and clutter, maze of temporary timbers, huge piles of sand and gravel and the like are conspicuous by their absence. In place of every appearance of confusion there is a prevailing incentive to simple efficiency. The various crafts have opportunity to take up their work in natural order and to continuously prosecute their work without delay. Every step, every operation in the construction of a Structural Steel and Steel Lumber building is so much definitely accomplished. No part is put in place temporarily and later entailing the work of tearing out. Even the necessary attention of the designing Architect or Engineer, the inspection of the work, is greatly decreased and at the same time made more positive.

The owner of a building is ordinarily anxious for completion. From the time work is first started the operation involves an investment. On this investment no returns can be realized until the building is turned over for possession. In many instances this item involves a considerable sum per month, and any reduction in time of erection results in a direct saving to be credited to construction cost. Because of the simplicity of construction and the opportunity for all trades to operate continuously, the saving in erection time effected by the use of Steel construction, compared with other equally efficient designs, is from twenty to thirty per cent. The season of the year has a decided effect on the cost of any construction work but this effect is considerably less on steel installations. Structural Steel and Steel Lumber can be erected in the winter time with nearly the same efficiency as in the other seasons.

The cost of cartage and handling are directly in proportion to volume weight and bulk of materials used. A construction saving from fifty to sixty-five per cent on weight and bulk certainly effects a big saving. The longer this cartage distance and the higher the building the greater the economy of steel designs.

Adaptability.

Steel Lumber Sections are adaptable to all kinds of buildings regardless of where they may be located. The cost per sq. ft. of installing Steel Lumber floors in a small building is no more than the cost of installing in a large building. Also the location of a building, whether in a city or in the country, does not effect the installation cost. In other words, the construction is equally applicable to large and small buildings regardless of their location. This for the reason that no special equipment is necessary for erection and either common or skilled labor can be used to advantage.

Rigidity.

Any floor construction to give satisfactory results over a long period of years must be rigid enough to stand up under all designed loading conditions with a minimum of deflection. A common principle in design is that the depth of beam in inches should be at least one-half the net span in feet. This regardless of the shape or width of section. In any construction wherein the structural sections in the floor slab run under this requirement there must be an allowance in the designed stresses or eventually the error will show up in a deterioration of floors and ceilings. Steel Lumber Sections are so designed as to meet all requirements of rigidity, and the material itself, due to its high elastic limit, gives a minimum of deflection under any given loading and will resume its normal position under excessive deflections. Results of this inherent quality in the material are apparent in those buildings constructed many years ago, the ceilings and floors of which are today in the very best of condition.

Dead Weight.

What is known as dead load or the weight of the construction itself constitutes volume and weight of material which has to be supported and held in place in addition to any live loadings which are contemplated and will be superimposed on the slabs. The efficiency of using a floor slab weighing not to exceed more than 40 lbs. per sq. ft. to carry a live load of 80 lbs. as compared with a floor slab weighing 100 lbs. per sq. ft. to carry the same live load can be readily appreciated. In addition every pound that can be saved in the weight of floor construction reduces the load on supporting beams, columns and footings. It also means that much less material has to be transported, carted, hoisted and manhandled. The handling of less

material expedites the construction of a building, which further results in greater economy.

Refer also to pages 116 to 119 where data on comparative weights is given.

Simplicity.

Any structural unit which is self contained is much simpler in design than one which has to be built up of a number of materials during the course of erection. Also the adaption of steel joists to any other floor construction is very similar to the adaption of wood joists and offers a minimum problem in framing and taking care of various small openings. Further, the knowledge that the material will positively give the results desired eliminates the necessity of providing for the large unknown factors existing in any type of construction which entails a combination of materials for structural purposes.

Installation.

The installation of steel joists involves practically the same operations as the installation of wood joists. The preparation of steel joists for the job is done at the fabricating plant, and they are delivered ready to place in position. The application of lath to steel joists is much more rapid than is the application of wood lath to wood joists. The ease of installation is apparent and one of those qualities most quickly recognized by contractors. Page 55.

Comparison with Wood Construction.

The comparative cost of steel joist and wood joist construction depends very largely on the type of floor finish used in each case. A careful consideration of this item will often result in the adoption of fire safe construction at practically the same cost as wood construction. Considering the superior merits, i. e., fire safeness, sound proofness, sanitary conditions, elimination of rodents, elimination of plaster cracks, rigidity and so on, the investment of a considerable extra sum only represents true economy. The resulting sense of satisfaction and security is worth a real investment. The way to eliminate fire losses is not by continuing to pay insurance premiums but to build fires out of buildings. Wood as a structural material represents the pioneer stage in this country. Certainly for the purpose and the time it had no equal; this because of its adaptability and universal availability. We are now past the stage of pioneer building. This country in no part can long afford to continue building of flimsy, inflammable materials.

Fire Safe First Floors.

A step in the right direction is to at least build in fire safe first floors. This can be done without increasing the cost of other portions of the building. Usually the foundations provided for a wood structure are sufficient for supporting a Steel Joist first floor. The balance of the building can be put up in wood. As the greater fire risk in the ordinary building is in the basement a large measure of absolute protection is afforded by fireproofing the first floor. In addition the elimination of shrinkage which invariably occurs in wood members results in a reduction if not entire elimination of all plaster cracks. The lower depreciation rate and increased value of the structure offset the small additional cost.

Supports.

Steel Lumber floor construction can be supported on brick, concrete, tile or any kind of masonry walls, also structural steel I beams, channels, built up girders and reinforced concrete beams. When steel joists bear on masonry walls the joists should have a bearing equal to one-half the depth of the joist, and never less than 4" measured along length of joist. It is well to slush cement mortar around joists when they are imbedded in brick walls. This to prevent moisture creeping through along the joist and to insure a tight wall, see page 87. In connection with structural steel members the joists may be supported directly on top of beams, being held in place by Beam Clips which fasten around the upper flange of the rolled beam and the lower flange of the steel joist, page 36. When carried on top of a supporting beam the joists may be either butted or lapped. Where the joists lap it is unnecessary to use a beam clip but instead they are tied together by nailing a strip of bridging across the top of joists into the web directly over bearing, see page 85. A very common method of supporting joists is on shelf angles riveted to the web of supporting beams. This is a desirable method where it is necessary to save in head room. The shelf angles should be not less than 3 x 2½ x ¼" and in all cases the 3" leg of the angle should form the bearing for the steel joist. The angles should be located so that top of steel lumber joists can be placed under the top flange of structural steel I beam, allowing for a slight clearance. Refer to tables on page 90. Steel joists can be framed flush with top of structural steel members but by so doing it is necessary to cope off the top flanges of the joists at the ends, see page 87. This entails extra fabrication and

increases the cost of the construction without in most cases any particular benefit.

Where steel joists bear on structural steel beams they should have at least 2" bearing. Where the flanges of the beams are not wide enough to permit this bearing the joist ends should be lapped, see page 85.

Joist Spacing.

The standard spacings for steel floor joists are 12", 16", 19" and 24". The maximum spacing of floor joists when used in garages, factory buildings, warehouses, or buildings of this type more or less heavily loaded, should not be greater than 16" on centers. Tables page 129. For hotels, school houses, apartments, hospitals, residences, office buildings, or other buildings of similar character, 24" centering of joists as a maximum gives satisfactory results. In roof construction it is permissible on account of the absolute uniform loading applied to increase the spacing of joists to 30". The reason for the particular spacings above noted is on account of the standard length of steel lath sheets, which is 96".

Erection of Steel Lumber.

The installation of steel joist and accessory materials is very simple. See page 55. The operations are very similar to those followed in erecting wood joist floors. After the bearings have been prepared the joists are placed in position. Temporary wood strips are placed on top of and at right angles to the joists and nailed in position. These strips should be placed near each end of the joists and approximately at each line of bridging. These strips hold the joists true to spacing, keep them in an upright position and materially aid in the proper installation of the building. These strips to be taken up just prior to the placing of the floor lath.

Heating, Plumbing Pipes and Conduits.

After the bridging has been placed all pipes should be installed. Pipes may be hung between or under the joists by means of strap pipe hangers. Methods of handling pipes are illustrated on pages 93 to 95. Where wood floor finish is to be applied small pipes and electric conduits may be placed on top of joists above the lath, but where a concrete or tile finish is to be applied all such pipes should be laid before the floor lath is applied. This provides for the reinforcing of concrete over the pipes and prevents cracking. Page 78.

Steel Lath Installation.

Steel lath is laid with the long way of the sheet at right angles to the joist. The lath should be given proper side laps. The side lap not less than $\frac{1}{2}$ inch if the ordinary flat Diamond Mesh Lath is used. With a rib lath the side lap is taken care of by nesting the side ribs. It is advisable on wider spacings to wire these side laps at least once at center between each row of joists. The lath is secured to the top flanges of the steel joist by the use of large headed roofing nails or spring lath clips. These should be spaced about 12" on centers. Refer to pages 44 to 48. In case pipes are hung below bottom of joists as shown on page 95, it is necessary to use a suspended ceiling to cover them. In this case $\frac{3}{16}$ " round rods are dropped down from the joists, one of the ends of the rod hooking over the top flange of the joists. These rods should be spaced every 3'6" to 4'0" along the length of the joists and 3'6" to 4'0" centers in the opposite direction. In applying lath to suspended ceiling frame work it is wired in place. Where applied directly to the bottom flanges of the joists it is fastened by spring lath clips which rigidly and positively hold the lath in place.

Wood Nailing Strips.

The wood nailing strips are applied directly on top of the steel lath over the joists. These nailing strips are $1\frac{3}{4}$ " x $1\frac{3}{4}$ " continuous wood strips and are laid parallel with and on top of joists and securely nailed to the joists with a 16d nail. Nails should be spaced 18 to 20" on center and the strip cut around any pipes or conduits running at right angles to the joists. See page 94.

By nailing the strips directly to the joists a positive connection is formed which precludes the possibility of nailing strip loosening up and causing squeaking floors. This is a particularly desirable point in Steel Lumber construction as compared with constructions where the nailing screed is simply embedded in concrete and held in place by that material.

Concrete Fill.

After the nailing strips are in place the concrete fill is put on top of lath in between the strips. The concrete is spread so that the fill, when tamped, will be about $\frac{1}{8}$ " below top of nailing strip. Where a wood finished floor is used the concrete fill can be a comparatively inexpensive mixture as it acts entirely as a fire block. The concrete must not be mixed wet enough to run through the lath, but should be sufficiently plastic to allow a good bond with

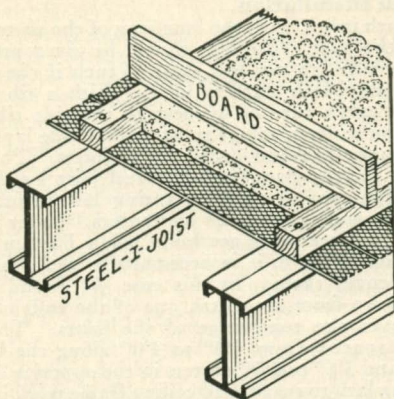

the lath. In case a concrete, tile, marble or terrazo finish floor is desired, the wood nailing strips are eliminated. The mixture of concrete essential for this type of construction must be the standard mixture as used in any good floor slab work. The application of the finished surface is installed in the usual manner. Refer to page 77. There are preparations on the market which take the place of concrete and in which nails can be readily driven. The use of some of these materials is often practical, taking the place of the concrete and nailing strips. Wood flooring then being nailed directly to the filler.

Spring Lath Clips.

Spring lath clips are made from the very highest grade of spring steel and are simple and easy to apply. The principal advantage in using the spring lath clip for ceiling work is to eliminate the old fashioned prongs which were punched in the bottom flanges of the Steel Lumber joists. These prongs made the handling of the joists very unhandy and in a great many cases they were broken off while being shipped and installed on the job. In addition, the prongs only held the lath at one point while the clips hold the lath rigidly the full width of the lower flange of the joist. The elimination of the prong leaves a smooth surface to work against when applying the lath. In securing the lath by means of the spring clip one end of the clip is passed through the mesh of the lath and hooked over the

small vertical flange of the steel joist. With the clip in this position pass the other end of the clip through the mesh over the opposite vertical flange and hook tightly and rigidly in place. This can easily be done by tapping lightly with a hammer. Refer to page 45.

After the spring clips are in place and the plaster applied, the clips are entirely imbedded in the plaster, which will prevent any movement whatever either of the lath or the clip.

Furring Structural Steel.

When steel joists are supported on structural steel beams these beams must be furred. The first operation necessary in furring is to secure furring clips to the bottom flanges of the structural steel members. The clips used for this purpose are so designed that they can be clamped around the bottom flange of the steel beam by a few raps of the hammer. Clips should not be spaced further than 30" center to center along the flanges of the beam. After the furring clips are in place $\frac{3}{4}$ " channels are laid parallel to the structural beam into seat of the furring clip which holds them in place, the $\frac{3}{4}$ " channels acting as a support for the steel lath between furring clips. After the channels are placed the steel lath is applied by bringing it down from the bottom of the steel joists around the bottom of the rolled beam, properly lapping at all joists and wiring it with a soft No. 16 gauge wire to the $\frac{3}{4}$ " channels. See page 38.

Where deep structural steel supporting members are used in connection with steel floor joists, such as plate girders and deep girder beams, it is necessary to reinforce the steel lath. This is accomplished by placing light strap iron or metal bridging around the girders, spacing these straps not more than 30" center to center. To these straps wire $\frac{3}{4}$ " channels running lengthwise with the rolled beam, and in turn wire the lath to the channel.

In cases where code requirements call for 2" of concrete all around structural members, the steel lath is to be wrapped clear up the sides of the rolled sections, split so as to go around steel joists, and all wired securely in place. Page 107. The proper thickness of cement plaster then to be applied to this lath. All plaster used on ceilings and walls in connection with Steel Lumber sections should be an accepted prepared plaster, prepared and mixed according to the manufacturer's instructions, or other plaster, but should in any case have fire retarding qualities equal to cement plaster. For column and beam fire-protection, refer to page 109.

Plaster.

The plaster used will of course depend upon the type and location of building. For many buildings the ordinary lime plaster will give sufficient protection. Where conditions call for maximum fire protection a cement mortar or good hardwall plaster should be used. All reference to plaster in this handbook is confined to cement plaster. This merely represents a basis of comparison and it is assumed that architects and engineers will accept any other plaster giving equally as good results. Refer to specifications page 123.

Framing.

Where Steel Lumber joists are used in residential work it is practical to frame around stair openings with steel joists, particularly where used for first floor construction. When framing around stair openings for this type of building it is advisable to place 4" Steel Lumber I sections to act

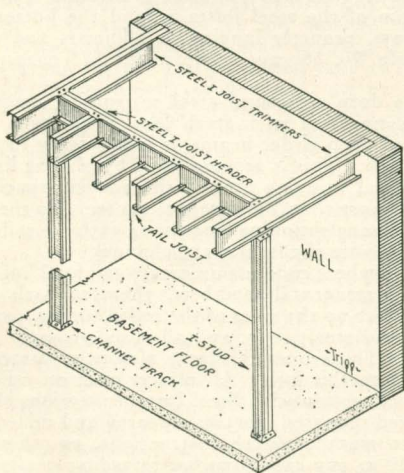

Steel Joist Columns Supporting Light Floor Load

THE NATIONAL PRESSED STEEL COMPANY

as columns under the points where the steel joist headers frame into the steel joist trimmers. Of course, all loads must be considered and all Steel Lumber sections must be of the proper size and strength necessary to sustain all loads that may be transferred to them. When steel joist sections are used as columns in this manner always wrap them with lath and plaster to at least one inch thickness. In all cases where tail joists frame into headers, and header joists into trimmers, all connections must be bolted or riveted with not less than four bolts or rivets at each connection. Steel joists can be readily framed into each other by flattening out the small vertical flanges of the trimmers at the points where the header joist is to frame into them. Before headers can be fit into trimmers it will be necessary to rap the end of them with a hammer which will slightly decrease their depth, allowing them to snugly fit in between top and bottom flanges of trimmers. This in turn is true also where the tail joist frames into the header. See page 80.

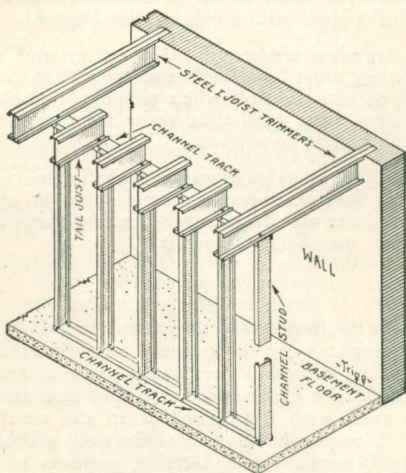

Steel Joist bearing partition supporting Steel Joist floor

In some cases it is possible to eliminate the header member by using a Steel Lumber partition for supporting tail joist. When used in this manner the tail joists would rest on top of Steel Lumber supporting partition and be secured by rivet or bolt connections. This construction can be used in cases where the load may be too great for the depth of the joist that might be necessary to use as a header, as depth of this member must be governed by the size joists used in the main floor construction. See page 80. All openings in the heavier type of buildings, such as stairs, elevators, openings for vent and heat ducts, when not built up with brick walls, also hatch-ways and smoke stacks, should be framed out with structural steel to support Steel Lumber joists. A good method for framing around smoke stacks, heat and vent ducts, or any openings of this type, is to use structural steel channels as trimmers and headers. By riveting a $3 \times 2\frac{1}{2} \times \frac{1}{4}$ " structural steel angle to back of channel header, the Steel Lumber joists, which would be the tail joists, can be supported on same. In most any case the structural steel channel members can be made the same depth as the Steel Lumber joists, thus making a level ceiling below. See Page 81.

When framing structural members around stairs or elevators, they must be of sufficient strength to carry Steel Lumber joist construction when supported on them, also stair and any other load that these structural members may be called upon to support.

All small openings that might occur in floors, such as openings for foot warmers or a single vent or heat duct, can be framed out with Steel Lumber joist without additional supporting members. Page 80.

Note—It is impossible to present in this book sufficient information to cover in detail every question which may arise. An effort has been made to present such data as will enable the experienced engineer and architect to design in steel with confidence as to the results to be secured. Structural Steel Fabricators stocking and fabricating National Steel Lumber sections are located in all principal cities. They will gladly furnish any further information that may be desired including estimates and quotations.

VARIOUS USES OF STEEL LUMBER

National Steel Lumber sections are produced for use as joists and studs in floor and partition construction. When used for this purpose they function to the best advantage and give absolute satisfaction. Familiarity with the material on the part of Architects, Engineers and Construction men has resulted in the sections being used for other purposes than those originally intended, in many instances such application gradually developing to the promise of standard practice. No doubt the future will develop many places where the rugged strength, uniformity, durability and shape of Steel Lumber sections can be applied with decided advantage.

Canopies:

Because of the light weight and relatively high strength, National Steel Lumber sections have proved very efficient when used in Canopy construction. The details of design are not materially changed by using these shapes.

Bridge Floors:

In bridge floor panels the joists are used similarly as used in building floor construction, excepting that all sections are directly connected with supporting members. The result is a completed structure of unusual rigidity and light weight.

Troughs or Chutes:

Channel Sections make very good concrete chutes, the secondary flange preventing any slopping over the sides. Manufacturing plants conveying material such as wheat by gravity in chutes, find the channel sections efficient for the purpose.

Roof Trusses:

For many purposes, steel joist sections are commonly used in Roof Truss designs. They build up a strong, light weight truss for comparatively short spans. Care should always be taken in such construction that the trusses are amply braced laterally.

Lintels:

For lintels over smaller openings use a design similar to sketch. The I joist carries the wall and applied floor loads, the necessary depth being determined by reference to the loading tables, page 26. The hot rolled channel merely supporting and holding in position a few layers of face brick. The window frame can be nailed directly to the joist section, making the connection tight.

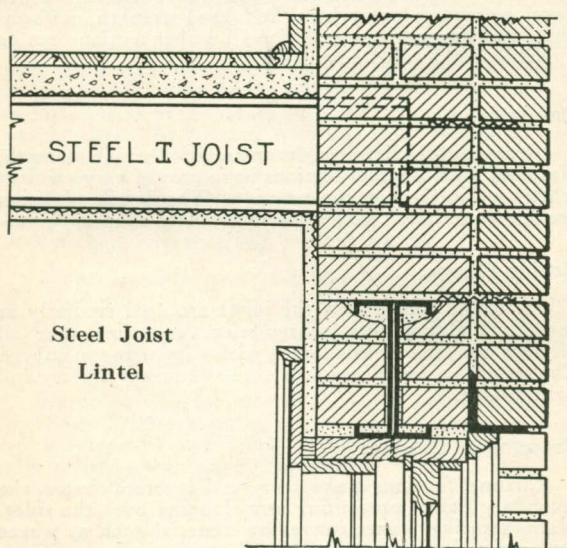

Steel Joist
Lintel

Truck and Auto Frames:

I Joists and Channel sections are used in the construction of Truck and Auto frames. They may constitute the entire frame or be used only in cross braces. A straight, rolled section is much cheaper than an irregular shape formed on a press. Wherever such shapes can be used, the economy of National sections are in evidence.

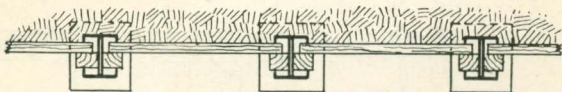
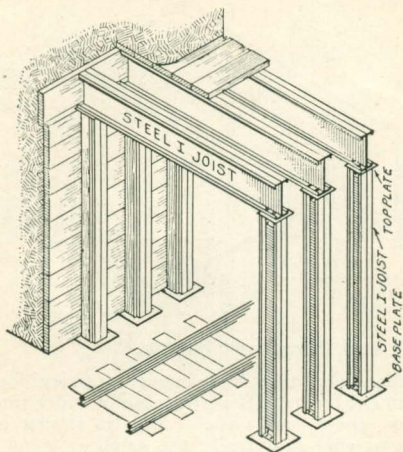

SECTION THRU SIDE WALLS

Props and Shoring:

In mines and all tunnel work steel joist sections may be used for Props and Roof Shoring. For Props cut the joists to desired length and by riveted angle detail connect bearing plates both ends. Slot these plates so that roof supports can be bolted to them. Joist sections for Roofs to have flanges slotted at both ends for bolting to prop bearing plates.

Back planking and bracing supports as shown in sketch is very simple. This type of roof and wall support is quickly put into place, all steel sections to be given a second coat of good thick paint before installation.

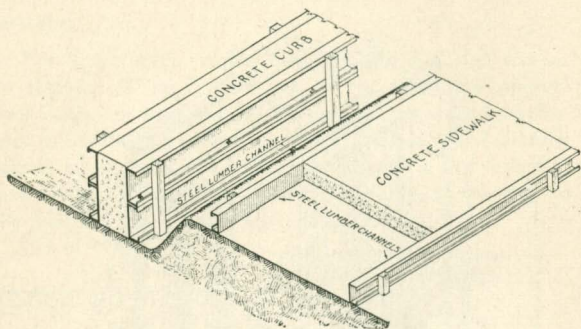

Sidewalk and Pavement Forms:

The channel sections have proved practical for sidewalk and pavement forms. Their durability under rough handling gives them long life. Use is shown in sketch. These forms cost practically the same as wood members for the same purpose and have all the advantages of steel.

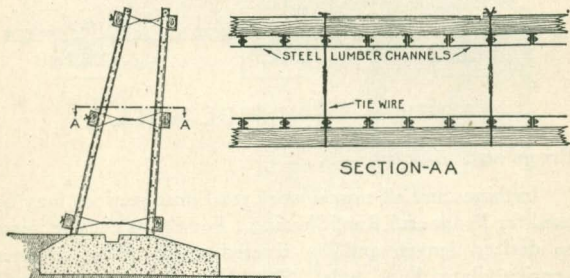

Concrete Forms:

When building concrete retaining walls and similar work where economy necessitates the re-use of forms, the channel section proves efficient. The flanges are punched with $\frac{1}{2}$ x 2" slots every eight inches to provide ample opportunity for bolted connections. Channels are supported at sufficient intervals with heavy timbers to maintain proper thickness of wall.

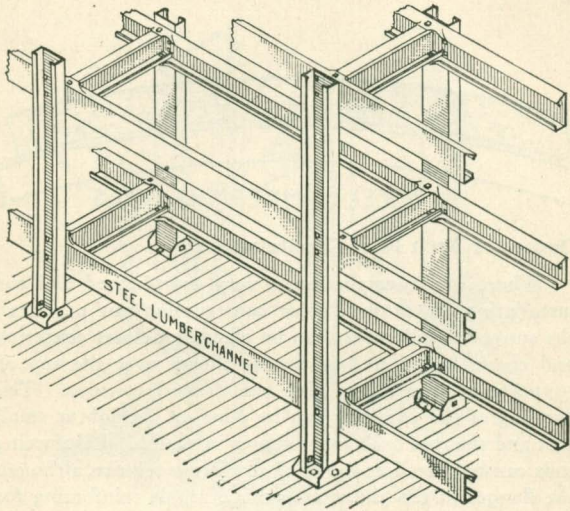

Tire Racks, Frames or Shelving

Sketch shows Steel Lumber sections assembled to form tire storage racks. In this construction channels are employed for all members of the frame. The flange of the channel that serves as horizontal support or shelf is bent down slightly to conform with the curve of the tire, thus the sharp edge of the channel support is eliminated and a wider bearing provided for the tire.

A similar assembly may serve as storage racks or shelving. Practically any desired strength can be secured by the use of deeper channels or I sections. Either flange or web connections may be employed, the nature of National Steel Lumber sections make these accessible to any kind of framing connections.

If in assembly the various members are bolted together they can readily be dissembled and reset as desired.

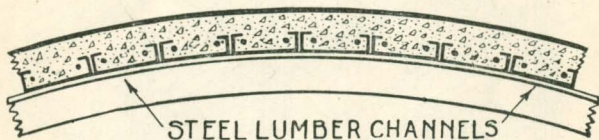

Domes or Arch Roof Construction:

Where roof construction is very complicated and the installation of standard floor construction not practical, the supporting members can be placed on closer centering and channel sections laid flat as shown over the top of supporting channels to give the desired contour. The bending of the channels can be done on the job at small cost and the roof built up as shown in sketch. Reinforcing rods can be placed as shown if conditions require, although the flanges of the channels provide ample reinforcing for all ordinary purposes. This type of roof construction is economical only where the contours required do not facilitate the use of standard designs. In such case it is simple, effective and installed at considerable saving.

In constructing this type of roof slab care should be taken that the channels are accessible for painting. Channels placed in this manner are subjected to differences in temperature on the two faces resulting in a possibility of condensation. To prevent corrosion the exposed surface of the channels should be kept well painted.

This opportunity for condensation does not exist where the steel joists are set vertically as in the standard floor or roof construction. There is no chance for corrosion on the sections excepting when they are placed flat as in sketch.

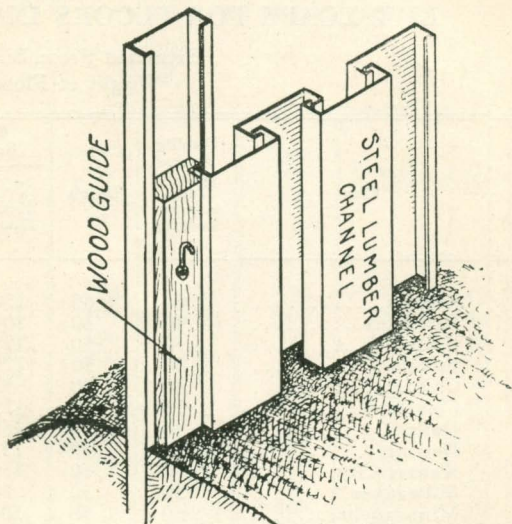

Piling:

On shallow operations where length of piles is not excessive, the channel sections provide an efficient interlocking sheet piling. A wood guide is used in driving. This guide being only as long as the length of pile standing above ground surface. A wood buffer should be used on top of pile in driving. The channel sections show surprising durability on this kind of work and with proper use of driving guides give excellent results.

When using National Steel Lumber for various purposes other than intended, always bear in mind that the sections cannot be expected to stand up under the same loading conditions as heavier shapes of the same size. Within the range of their limitations they are comparatively more rugged than other steel shapes. Used under conditions beyond their range of adaptability, results secured will be unsatisfactory. Complying with the basic principles covered by the range of Steel Lumber adaptability, the service rendered by these sections will always merit approval.

LIVE LOADS FOR FLOORS IN DIF

Extracted From Building
Weight of Floor Con

No.	City	Dwell'g Apart- ments Tene- ments or Lodging	Hotels	Office Buildings	
				First Floor	Upper Floors
1	Atlanta.....	60	60	150	75
2	Baltimore.....	(b) 40	40	100	50
3	Boston.....	50	50	125	75
4	Buffalo.....	50	50	120	50
5	Chicago.....	40	50	50	50
6	Cleveland.....	70	70	125	70
7	Dallas.....	40	50	150	50
8	Detroit.....	40	40	125	50
9	Kansas City.....	60	60	150	75
10	Milwaukee.....	30	30	80	40
11	Minneapolis.....	50	50	100	75
12	New York.....	40	40	60	60
13	New Orleans.....	(a) 40	40	125	70
14	Omaha.....	50	50	50	50
15	Philadelphia.....	40	40	120	60
16	Pittsburgh.....	(b) 40	50
17	Portland, Ore.....	(b) 50	50	125	60
18	Providence.....	(c) 50	50	150	75
19	San Francisco.....	40	40	125	40
20	St. Louis.....	50	50	100	60
21	St. Paul.....	40	50	50	50
22	Seattle.....	40	40	125	50
23	General Average of other Cities.....	40	40	100	50

Office and Public Rooms (a) 70, (b) 80, (c) 100.
Corridors (d) 80.
Fixed Seats (e) 80, (f) 75.

THE NATIONAL PRESSED STEEL COMPANY

FERENT CLASSES OF BUILDINGS

Codes of Various Cities.
struction Not Included.

Schools		Build'gs for Public Assem- bly	Stores	Light Mfg. and Light Storage	Garages (Public)	Roofs (Flat)	No.
Class Rooms	Auditor- iums and Corri- dors						
75	75	90	120	120	75	40	1
75	100	100	100	100	90	40	2
50	100	100	125	150	40	3
50	(d)100	(e)100	120	120	120	30	4
75	100	100	100	100	100	40	5
70	70	100	(g)100	125	(i) 100	35	6
60	90	(f) 100	120	120	80	25	7
50	80	(f) 100	(g)100	125	100	30	8
60	90	90	120	120	80	50	9
40	60	(k) 50	100	100	80	30	10
75	(n)100	125	100	100	100	50	11
75	75	100	120	120	120	40	12
60	125	(l) 125	125	125	30	13
50	75	100	100	100	100	30	14
75	100	100	(j) 100	120	120	30	15
.....	125	40	16
60	75	80	(g)100	125	(g) 80	40	17
60	125	(m)125	125	125	150	40	18
75	125	(f) 125	100	125	100	30	19
75	100	100	150	100	100	30	20
60	125	100	125	100	100	30	21
50	100	100	100	125	40	22
60	80	(e) 90	100	125	80	40	23

First Floor (g) 125, (h) 100, (i) 150, (j) 120.
Drill or Dance Halls (k) 100, (l) 150, (m) 200.
Assembly Rooms (n) 125.

Bending Moments and Deflection of Beams for Usual Methods of Loading

P & W = Total Load

L = Length of Net Span

M = Maximum Bending Moment

I = Moment of Inertia

E = Modulus of Elasticity

S = Maximum Shear

Beam Fixed at One End and Loaded at Other

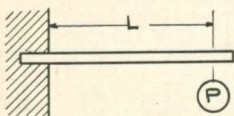

Safe load = $\frac{1}{8}$ that shown in tables

$M = PL$ at point of support

$S = P$ at point of support

Deflection = $\frac{PL^3}{3EI}$

Beam Fixed at One End and Uniformly Loaded

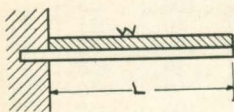

Safe load = $\frac{1}{4}$ that shown in tables

$M = \frac{WL}{2}$ point of support

$S = W$ point of support

Deflection = $\frac{WL^3}{8EI}$

Beam Supported at Both Ends, Single Load in Middle

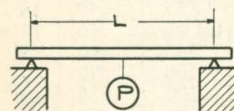

Safe load = $\frac{1}{2}$ that shown in tables

$M = \frac{PL}{4}$ middle of beam

$S = \frac{P}{2}$ at points of support

Deflection = $\frac{PL^3}{48EI}$

Beam Supported at Both Ends and Uniformly Loaded

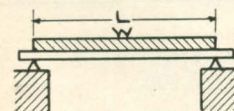

Safe load = that shown in tables

$M = \frac{WL}{8}$ at middle of beam

$S = \frac{W}{2}$ at points of support

Deflection = $\frac{5WL^3}{384EI}$

Beam Continuous Over Support at One End Uniformly Loaded

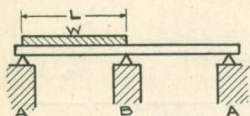

Safe load = $1\frac{1}{8}$ that shown in tables

$$M = \frac{WL}{9} \text{ at middle of beam}$$

$$S = \frac{W}{2} \text{ at points of support}$$

$$\text{Deflection} = \frac{3WL^3}{384 EI}$$

Beam Continuous Over Support at Both Ends and Uniformly Loaded

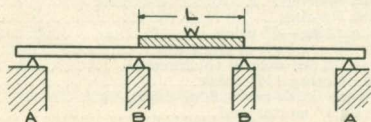

Safe load = $1\frac{1}{4}$ that shown

$$S = \frac{W}{2} \text{ at point of support}$$

$$M = \frac{WL}{10} \text{ at middle of beam}$$

$$\text{Deflection} = \frac{WL^3}{384 EI}$$

Beam Supported at Both Ends—Single Unsymmetrical Load

Safe load = that given in tables $\times \frac{L^2}{8 AB}$

$$M = \frac{PAB}{L} \text{ under load}$$

$$S = \begin{cases} \text{A End} = \frac{PB}{L} \\ \text{B End} = \frac{PA}{L} \end{cases}$$

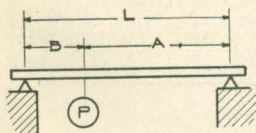

$$\text{Deflection} = \frac{PAB(2L-A)}{9 EI L} \sqrt{\frac{1}{3} A(2L-A)}$$

Beam Supported at Ends—Two Symmetrical Loads

Safe load = that shown in tables $\times \frac{L}{4A}$

$$M = \frac{PA}{2} \text{ between loads}$$

$$S = \frac{P}{2} \text{ bet. load \& nearest support}$$

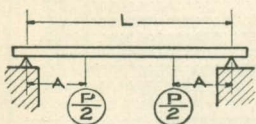

$$\text{Deflection} = \frac{PA}{48 EI} (3L^2 - 4A^2)$$

WEIGHTS OF BUILDING MATERIALS

Material and Purpose for Which Used	Wt. in Lbs. per Sq. Ft.
FLOORS	
7/8" Oak finish flooring.....	3 2/3
3/8" Oak finish flooring.....	1 2/3
7/8" Maple finish flooring.....	3
3/8" Maple finish flooring.....	1 1/2
Yellow Pine sheathing—1" thick.....	4
Stone Concrete fill per inch of thickness.....	12
Cinder Concrete fill per inch of thickness.....	9
Asphalt Mastic flooring 1 1/2" thick.....	18
Cement or Terrazo finish per inch of thickness.....	13
Solid Flat Tile on 1" mortar bed.....	23
CEILINGS	
Plaster on Tile or Concrete.....	6
Plaster on Metal Lath.....	7
Metal Lath.....	1/3
Suspended Metal Lath and Plaster.....	9
ROOFS	
Yellow Pine sheathing 1" thick.....	4
Slate 1/4" thick.....	9
Cement Tile.....	16
Cinder Fill per inch thickness.....	3 1/2
Three Ply Ready Roofing.....	1
Four Ply Felt and Gravel.....	5 1/2
Five Ply Felt and Gravel.....	6
WALLS	
9" Brick Wall—unplastered.....	84
13" Brick Wall—unplastered.....	121
18" Brick Wall—unplastered.....	168
22" Brick Wall—unplastered.....	205
26" Brick Wall—unplastered.....	243
4" Brick 4" Tile Backing—unplastered.....	60
4" Brick 8" Tile Backing—unplastered.....	75
9" Brick 4" Tile Backing—unplastered.....	102
8" Tile—unplastered.....	33
12" Tile—unplastered.....	45
Plaster on Brick or Tile Walls—one side.....	5

THE NATIONAL PRESSED STEEL COMPANY

WEIGHTS OF BUILDING MATERIALS

Kind and Purpose for Which Used	Wt. in Lbs. per Sq. Ft.
PARTITIONS	
3" Clay Tile—both sides plastered.....	27
4" Clay Tile—both sides plastered.....	28
6" Clay Tile—both sides plastered.....	35
8" Clay Tile—both sides plastered.....	41
3" Gypsum Block—both sides plastered.....	20
4" Gypsum Block—both sides plastered.....	22
5" Gypsum Block—both sides plastered.....	24
6" Gypsum Block—both sides plastered.....	26
2" Solid Plaster.....	20
4" Hollow Plaster.....	22

MASONRY

Kind	Wt. in Lbs. per Cu. Ft.
Concrete, cinder.....	110
Concrete, stone.....	144
Concrete, reinforced stone.....	150
Brick, masonry, soft.....	100
Brick, masonry, common.....	125
Brick, masonry, pressed.....	140
Granite, dressed.....	165
Marble.....	165
Limestone.....	162
Sandstone.....	150

MISCELLANEOUS

	Weight lbs.
Cement, Portland, per barrel.....	376
Cement, Portland, per cubic foot.....	85 to 90
Lime, per barrel.....	225
Sand, per cubic foot.....	90 to 106
Gravel, per cubic foot.....	120
Cinders, per cubic foot.....	40
Dimension Lumber, per foot B.M.....	3
Iron, per cubic foot.....	480
Steel, per cubic foot.....	489.6
Water, at 32° F., per cubic foot.....	62.417

SAFE UNIT FIBRE STRESSES

To be used in determining total uniform loading for maximum deflection of 1/360 of span.
Based on 16000 pounds fibre stress for spans less than those indicated.

Beam Size Inches	SPAN IN FEET															
	9	10	11	12	13	14	15	16	17	18	19	20	21	22	23	24
4.....	14400	12900	11700	10700
5.....	16000	14600	13400	12400	11500
6.....	16000	14800	13800	12900	12100
7.....	16000	15000	14100	13300	12500
8.....	16000	15200	14300	13600	12800
9.....	16000	15300	14500	13800	13200
10.....	16000	15400	14600	14000	13400

Beam Size Inches	SPAN IN FEET															
	23	24	25	26	27	28	31	32	33	34	37	38	40	41	42	44
10.....	14000	13400
11.....	15500	14300	14200	13600	13100
12.....	16000	15500	14900	14300	13800
15.....	16000	15600	15100	14700	14200	14500	14500	14500	14500	14500
18.....	16000	15700	15300	16000	15700	15300	14700
20.....

NOTE:—Stresses given to nearest 100 in inch pounds.

STRUCTURAL TIMBER

Commercial timbers which are in common use in building construction are not uniform in character. Therefore in the design and construction of wood frame structures great care should be exercised. The strength of structural timbers depends upon—the kind of wood, the age of the tree, the time of year in which it is felled, the method of sawing, the character of the seasoning with the resulting moisture content, the proportion of heart wood to sap-wood and the proportion of knots to clear wood.

As a result of the various factors effecting the strength of timber, the working unit stresses approved by the building laws of different cities vary widely. However, researches by technical and engineering associations and by the Forestry Division have established unit stresses for various kinds of wood which actual construction has approved as good practice.

The safe load tables for wood joists which follow may be accepted as reliable. The uniformly distributed safe loads are given for rectangular sections one inch thick. The safe load for a beam of any thickness is found by multiplying the tabular value by thickness of the beam in inches. The safe loads include the weight of the beam and are based on the assumption that the beams are braced against lateral deflection.

The deflection of beams intended to carry plastered ceiling should not exceed $1/360$ of the span. The maximum spans for this limit are given.

In the use of wood floor joists care should be taken that unavoidable knots are at the top or compression side of beams instead of in the lower or tension side. The details of construction should be such as to eliminate in so far as possible the evil effects caused by the shrinkage of the joists.

STRUCTURAL TIMBERS

Average Safe Allowable Working Unit Stress, in Pounds per Square inch.

Kind of Timber	Weight per Foot	BENDING		SHEARING		COMPRESSION		
		Safe Stress	Modulus of Elasticity	With Grain	Across Grain	WITH GRAIN		
						End Bearing	Cols. Less Than 15" Dia.	Across Grain
Safety Factor		6	2	4	4	5	5	4
White Oak	4.16	1200	750000	200	1000	1400	1000	500
White Pine	1.98	800	500000	100	500	1100	750	200
Long Leaf Pine	3.17	1200	750000	150	1250	1400	1000	350
Douglas Fir	2.65	1000	750000	150	1200	1200	900	200
Short Leaf Pine	2.65	1000	650000	125	1000	1200	900	250
Spruce	2.08	900	600000	100	750	1100	800	200
Hemlock	2.08	800	500000	125	600	1200	800	150
Cypress	2.39	900	500000	125	1000	1000	800	200
Cedar	1.93	750	400000	100	400	1000	700	200
Redwood	2.01	800	350000	100	900	700	700	150
Tamrack	3.00	900	600000	150	1000	750

Maximum Spans in Feet for Permanent Loads

Kind of Wood	DEPTH OF WOOD BEAMS IN INCHES											
	2	4	6	8	10	12	14	16	18	20	22	24
White Oak	2.3	4.7	7.0	9.3	11.6	13.9	16.3	18.6	20.9	23.2	25.6	27.9
Long Leaf Pine	2.8	5.5	8.3	11.0	13.8	16.5	19.3	22.0	24.8	27.6	30.3	33.1
Short Leaf Pine	3.0	6.0	9.0	12.0	15.0	17.9	20.9	23.9	26.9	29.9	32.9	35.9
Hemlock	3.0	6.0	9.0	12.0	15.0	17.9	20.9	23.9	26.9	29.9	32.9	35.9
Douglas Fir	2.8	5.6	8.4	11.2	14.0	16.7	19.5	22.3	25.1	27.9	30.7	34.5
Spruce	2.9	5.8	8.7	11.6	14.6	17.5	20.4	23.3	26.2	29.1	32.0	37.9

Shows the maximum span in lineal feet for a maximum deflection of 1/360 of the span.

THE NATIONAL PRESSED STEEL COMPANY

Safe Loads in Pounds Uniformly Distributed. For Rectangular Beams One Inch Thick

Allowable Fibre Stress 1200 Pounds per Square Inch

To find the safe load for any size wood beam, take the load shown in tables for the given beam depth and multiply by the width of beam in inches.

Span in Feet	DEPTH OF BEAM IN INCHES																		Deflection Coefficient
	4	5	6	7	8	9	10	11	12	13	14	15	16	17	18				
6	355	556	800	1090	1420	1800	2220	2690	3200	3760	436086	
7	305	477	685	934	1220	1542	1902	2310	2740	3220	3730	1.18	
8	266	417	600	817	1068	1350	1662	2020	2400	2818	3262	1.54	
9	238	371	534	726	949	1200	1480	1792	2130	2500	2903	3325	3790	4280	4800	1.94	
10	214	334	480	653	854	1080	1332	1612	1920	2250	2610	3000	3420	3850	4320	2.40	
11	195	304	437	594	776	983	1212	1470	1748	2045	2380	2725	3103	3500	3925	2.90	
12	178	287	400	545	712	900	1112	1342	1600	1880	2180	2500	2842	3200	3600	3.46	
13	164	257	370	503	656	830	1025	1240	1480	1732	2010	2305	2624	2960	3320	4.06	
14	152	238	343	467	610	772	952	1151	1372	1610	1868	2142	2438	2750	3082	4.70	
15	143	222	323	436	568	720	790	1075	1280	1505	1742	2000	2275	2570	2880	5.40	
16	133	209	300	408	534	676	833	1008	1200	1410	1632	1880	2135	2400	2700	6.14	
17	126	196	282	384	502	635	785	950	1130	1325	1540	1768	2005	2260	2540	6.94	
18	119	185	266	363	474	600	741	896	1068	1252	1451	1668	1898	2145	2400	7.78	
19	113	175	253	344	448	568	702	850	1010	1182	1372	1580	1795	2025	2275	8.66	
20	107	167	240	336	428	540	668	806	960	1125	1308	1500	1710	1925	2160	9.60	
21	102	158	228	311	407	515	635	768	915	1070	1242	1430	1625	1832	2060	10.58	
22	97	151	218	296	388	491	606	734	874	1025	1190	1362	1550	1752	1960	11.62	

To determine the maximum deflection at center of wood beam under uniform loading divide the given coefficient for deflection by the depth of beam in inches. If deflection amounts to more than 1/360 of the span then a deeper beam should be used.

REQUIRED WIDTH OF WOOD JOIST

Equaling the Strength of National Steel Joists.
All Sections in Horizontal Lines are of Equal Strength.

STEEL JOIST	DEPTH OF WOOD JOIST																			
	Depth	4"		6"		8"		10"		12"		14"		16"		18"		20"		
		Weight per Lineal Foot	Ins. Wid.	Lbs. Wt.	Ins. Wid.	Lbs. Wt.	Ins. Wid.	Lbs. Wt.	Ins. Wid.	Lbs. Wt.	Ins. Wid.	Lbs. Wt.	Ins. Wid.	Lbs. Wt.	Ins. Wid.	Lbs. Wt.	Ins. Wid.	Lbs. Wt.	Ins. Wid.	Lbs. Wt.
4"	3.7	7.8	7.1	3.4	4.7	1.8	3.4	1.1	2.6	.77	2.2
5"	4.3	10.8	9.8	4.5	6.3	2.5	4.7	1.6	3.8	1.1	3.2	.77	2.6
6"	4.9	6.2	8.5	3.3	6.2	2.1	5.0	1.4	4.0	1.0	3.4
7"	5.8	8.7	12.0	4.6	8.6	2.9	6.9	2.0	5.8	1.4	4.7	1.1	4.3
8"	6.8	6.3	11.8	3.9	9.3	2.7	7.8	1.9	6.4	1.5	5.8	1.2	5.3
9"	7.7	7.8	14.6	4.8	11.4	3.3	9.5	2.4	8.1	1.8	7.0	1.4	6.1	1.1	5.4	..
10"	8.7	8.4	16.8	5.4	13.5	3.7	11.1	2.7	9.4	2.1	8.4	1.7	7.5	1.3	6.5	..
11"	9.5	10.8	20.2	6.7	15.9	4.6	13.2	3.3	11.1	2.5	9.7	2.0	8.7	1.6	7.8	..
12"	10.7	8.2	19.4	5.6	16.1	4.1	13.8	3.1	12.0	2.4	10.5	1.9	9.3	..
12.0	9.8	23.2	6.6	19.0	4.8	16.2	3.7	14.3	2.9	12.7	2.3	11.2	..

NOTE:—Above comparative figures are based on the average allowable stress of 1,200 lbs. per square inch for wood and 16,000 lbs. per square inch for steel. Weight of wood 3 lbs. per board foot. DEFLECTION NOT CONSIDERED. Refer to table of limiting spans for wood beams on (Page 165).

THE NATIONAL PRESSED STEEL COMPANY

BOARD MEASURE

This table shows the exact number of feet in any piece of dimension timber.

Size in Inches	LENGTH IN FEET											
	10	12	14	16	18	20	22	24	26	28	30	32
2 x 4...	6	8	9	10	12	13	14	16	17	18	20	21
2 x 6...	10	12	14	16	18	20	22	24	26	28	30	32
2 x 8...	13	16	18	21	24	26	29	32	34	37	40	42
2 x 10...	16	20	23	26	30	33	36	40	43	46	50	53
2 x 12...	20	24	28	32	36	40	44	48	52	56	60	64
2 x 14...	23	28	32	37	42	46	51	56	60	65	70	74
2 x 16...	26	32	37	42	48	53	58	64	69	74	80	85
2 1/2 x 12...	25	30	35	40	45	50	55	60	65	70	75	80
2 1/2 x 14...	29	35	40	46	52	58	64	70	75	81	87	94
2 1/2 x 16...	33	40	46	53	60	66	73	80	86	93	100	106
3 x 6...	15	18	21	24	27	30	33	36	39	42	45	48
3 x 8...	20	24	28	32	36	40	44	48	52	56	60	64
3 x 10...	25	30	35	40	45	50	55	60	65	70	75	80
3 x 12...	30	36	42	48	54	60	66	72	78	84	90	96
3 x 14...	35	42	49	56	63	70	77	84	91	98	105	112
3 x 16...	40	48	56	64	72	80	88	96	104	112	120	128
4 x 4...	13	16	18	21	24	26	29	32	34	37	40	42
4 x 6...	20	24	28	32	36	40	44	48	52	56	60	64
4 x 8...	26	32	37	42	48	53	58	64	69	74	80	85
4 x 10...	33	40	46	53	60	66	73	80	86	93	100	106
4 x 12...	40	48	56	64	72	80	88	96	104	112	120	128
4 x 14...	46	56	65	74	84	93	102	112	121	130	140	149
6 x 6...	30	36	42	48	54	60	66	72	78	84	90	96
6 x 8...	40	48	56	64	72	80	88	96	104	112	120	128
6 x 10...	50	60	70	80	90	100	110	120	130	140	150	160
6 x 12...	60	72	84	96	108	120	132	144	156	168	180	196
6 x 14...	70	84	98	112	126	140	154	168	182	196	210	224
8 x 8...	53	64	74	85	96	106	117	128	138	149	160	170
8 x 10...	66	80	93	106	120	133	146	160	173	186	200	213
8 x 12...	80	96	112	128	144	160	176	192	208	224	240	256
8 x 14...	93	112	130	149	168	186	205	224	242	261	280	298
10 x 10...	83	100	116	133	150	166	183	200	216	233	250	266
10 x 12...	100	120	140	160	180	200	220	240	260	280	300	320
10 x 14...	116	140	163	186	210	233	256	280	303	326	350	373
10 x 16...	133	160	186	213	240	266	293	320	346	373	400	426
12 x 12...	120	144	168	192	216	240	264	288	312	336	360	384
12 x 14...	140	168	196	224	252	280	308	336	364	392	420	448
12 x 16...	160	192	224	256	288	320	352	384	416	448	480	512
14 x 14...	163	196	228	261	294	326	359	392	424	457	490	522
14 x 16...	186	224	261	298	336	373	410	448	485	522	560	597

NATIONAL STRIP STEEL

Straight standard carbon and special or standard alloy analyses especially for Pressing, Stamping and Deep Drawing in following sizes:

Widths—Minimum, 3"; maximum, 14" to 24" (under 8" sheared edges).

Gauges—No. 15 (.072") to No. 00 (.380").

Lengths—Hot Coiled 80' to 120'; or cut to specified lengths.

Finish and Treatment—Plain Black, Pickled, Oiled, Limed or Annealed as desired.

STANDARD EXTRAS IN CENTS PER 100 LBS.

Width	9 Ga. .148" and Heavier	Under 9 Ga. to and Incl. 12 Ga. .109"	13 Ga. .095"	14 Ga. .083"	15 Ga. .072"	16 Ga. .065"
3 "	base	\$0.05	\$0.10	\$0.10	\$0.10	\$0.15
3 ¹ / ₁₆ " to 4 "	base	.05	.10	.15	.20	.30
4 ¹ / ₁₆ " to 5 "	base	.10	.15	.20	.30	.50
5 ¹ / ₈ " to 6 "	base	.10	.20	.30	.40	.70
6 ¹ / ₁₆ " to 8 "	.10	.20	.30	.45	.60	.80
8 ¹ / ₁₆ " to 10 "	.10	.20	.40	.55	.80	1.05
10 ¹ / ₁₆ " to 12 ¹ / ₂ "	.20	.30	.50	.75	.95	1.25
12 ⁹ / ₁₆ " to 15 "	.30	.40	.60	.90
15 ¹ / ₁₆ " and wider	.40	.60	.75	1.00
Extra for slitting	.25	.25	.25	.25	.40	.40
Extra for pickling	.40	.40	.45	.50	.55	.60

In coils or cut to length 5 feet and over including shorter pieces that accrue in cutting.

Cutting to length 5 feet and over without

short pieces.....10% extra

Annealing.....\$0.50

Cutting to length over 48, under 60 inches..... .05

Cutting to length over 24 to 48 inches inclusive.... .10

Cutting to length over 12 to 24 inches inclusive.... .20

Cutting to length under 12 inches—on application at least.....(minimum) .30

For intermediate thickness the extra for next lighter will apply. Birmingham wire or Stubb's gauge (see opposite page) applies on this list.

Less than 2000 to 1000 pounds.....\$0.15

Less than 1000 pounds..... .35

Charges for other than mill inspection will apply according to work involved.

THE NATIONAL PRESSED STEEL COMPANY

GAUGE EQUIVALENTS

And Weights per Lineal Foot

Gauge No.	Birmingham or Stubbs		U. S. Standard Decimal Thickness	Fractions of an Inch
	Decimal Thickness	Lbs. per lin. ft. 1" wide		
0000	.454	1.54	.4063	$\frac{1}{4}$ — .016
000	.425	1.44	.3750	$\frac{3}{8}$ — .031
00	.380	1.29	.3438	$\frac{1}{2}$ — .047
0	.340	1.16	.3125	$\frac{3}{4}$ — .063
1	.300	1.02	.2813	$\frac{7}{8}$ — .078
2	.284	.966	.2656	$\frac{1}{8}$ — .094
3	.259	.881	.2500	$\frac{1}{4}$ — .109
4	.238	.809	.2344	$\frac{1}{8}$ — .125
5	.220	.748	.2188	$\frac{3}{16}$ — .140
6	.203	.690	.2031	$\frac{1}{4}$ — .156
7	.180	.612	.1875	$\frac{3}{16}$ — .172
8	.165	.561	.1719	$\frac{1}{4}$ — .188
9	.148	.503	.1563	$\frac{1}{4}$ — .203
10	.134	.456	.1406	$\frac{1}{8}$ — .219
11	.120	.408	.1250	$\frac{1}{4}$ — .234
12	.109	.371	.1094	$\frac{1}{4}$ — .250
13	.095	.323	.0938	$\frac{3}{8}$ — .281
14	.083	.282	.0781	$\frac{1}{8}$ — .313
15	.072	.245	.0703	$\frac{1}{8}$ — .344
16	.065	.221	.0625	$\frac{3}{8}$ — .375
17	.058	.197	.0563	$\frac{1}{2}$ — .406
18	.049	.167	.0500	$\frac{1}{2}$ — .438
19	.042	.143	.4038	$\frac{1}{2}$ — .469
20	.035	.119	.0375	$\frac{1}{2}$ — .500
21	.032	.109	.0344	$\frac{1}{2}$ — .531
22	.028	.095	.0313	$\frac{3}{4}$ — .563
23	.025	.085	.0281	$\frac{1}{2}$ — .594
24	.022	.075	.0250	$\frac{3}{4}$ — .625
25	.020	.068	.0219	$\frac{1}{2}$ — .656
26	.018	.061	.0188	$\frac{1}{4}$ — .688
27	.016	.054	.0172	$\frac{1}{4}$ — .719
28	.014	.047	.0156	$\frac{1}{4}$ — .750
29	.013	.044	.0141	$\frac{1}{4}$ — .781
30	.012	.040	.0125	$\frac{1}{4}$ — .813
31	.010	.034	.0109	$\frac{1}{4}$ — .844
32	.009	.030	.0102	$\frac{1}{4}$ — .875
33	.008	.027	.0094	$\frac{1}{4}$ — .906
34	.007	.024	.0086	$\frac{1}{4}$ — .938
35	.005	.017	.0078	$\frac{1}{4}$ — .969
36	.004	.014	.0070	1 — 1.000

The Birmingham (or Stubbs) Gauge is universally recognized as Standard by manufacturers of Hot Rolled Strip Steel. Specifications by gauge number will be interpreted accordingly unless otherwise stated.

INDEX

	PAGE
Accessories.....	12, 21
table of quantities.....	62
Adaptability, steel construction.....	139
Advantages of steel construction.....	135
Analysis, chemical, of steel joists.....	120, 134
Anchors, joist.....	86, 92
Angles, shelf.....	88-91
location of.....	90, 91
Area of finished columns.....	70, 119
Application of steel lath.....	42
Asphalt mastic flooring, weight of.....	160
Atlanta, code specifications for live loads.....	156, 157
Auto frames.....	150
Balcony construction.....	96
Baltimore, code specifications for live loads.....	156, 157
Barrel cement, weight of.....	161
Base, pricing of steel joist.....	12
Beams, coefficients for deflection.....	162
general formulæ for flexure.....	158, 159
stresses, safe for deflection.....	163
Birmingham gauge.....	170
Beam Clips, description.....	36
application of.....	36, 85
table for designing.....	37
Beam Furring Clips, description of.....	38
application of.....	38, 107
table for designing.....	39
Beam costs.....	68, 69
Beam fireproofing.....	106, 107
Bearing partitions.....	78, 82, 147
Bearing, for steel joists.....	22, 84-91
specifications for.....	122
Billets.....	132
Board measure, table of.....	168
Boston, code specifications for live loads.....	156, 157
Bracing of steel joists.....	23, 49-53
Brick, masonry, weights of.....	160, 161
Bridge floor construction.....	149
Bridging, description of.....	21, 49-53
function of.....	49
installation of.....	52
table of quantities.....	62
table of sizes, strap bridging.....	51
specifications of.....	112

INDEX—Continued

	PAGE
Buffalo, code specifications for live loads.....	156, 157
Building materials, weights of.....	160, 161
Building code, live load specifications.....	156, 157
Canopies.....	149
Ceilings, weights of.....	160
specifications for suspended.....	124
suspended.....	97
Ceiling hangers.....	97
Cement, barrel, weight of.....	161
flooring, weight of.....	160
Channels, cuts of sections, Steel Lumber.....	20, 133
safe loading tables structural steel.....	127
Chemical analysis, steel joists.....	120, 134
Chicago, code specifications for live loads.....	156, 157
Cinders, weights of.....	161
Cleveland, code specifications for live loads.....	156, 157
Clips, table of quantities.....	62
beam.....	36
beam furring.....	38
roof bracing steel joists.....	100
spring lath.....	44
Code specifications, various cities.....	156, 157
Coefficients for deflection.....	162
Coils.....	133
Columns, comparison in design and weight.....	118
costs.....	70, 71
fireproofing of.....	108, 109
Concentrated floor loads.....	128
Concrete, design of slab.....	129, 143
footings.....	111-115
forms.....	152
stairways.....	102
strength of slab.....	129
weight of.....	161
Conduits, installation of.....	79, 93-95
Construction details.....	74, 101
Continuous bridging.....	21, 49
Common formulæ.....	158, 159
Comparison, floor design.....	131
costs.....	64-73
steel and wood joists.....	140, 167
steel joists with rolled I beam.....	9
weights of construction.....	116-119
Coping.....	87

INDEX—Continued

	PAGE
Corrosion, steel joists.....	137
Cost data.....	64
Crippling of webs, steel joists.....	34
Curb forms.....	152
Cuts of sections, standard steel joists.....	13-20
accessory materials.....	21
Cutting extras, strip steel.....	169
Cutting tolerances, steel joists.....	12
Cutting of steel joists.....	134
Dallas, code specifications for live loads.....	156, 157
Dance hall or assembly floor design.....	128
Dead load, comparison of firesafe floor designs.....	131
calculation for steel lumber construction.....	130, 139
steel construction.....	116-119
Decimal gauges.....	170
Deflection, coefficients for.....	162
limit of span, structural timber.....	165
unit fibre stresses.....	163
of steel joists.....	11
Depreciation of steel construction.....	136
Description of steel joists.....	9, 12, 120
Designing data.....	22
formulae.....	158, 159
Designation of steel joists.....	12
Detroit, code specifications for live loads.....	156, 157
Dimensions of, steel joists.....	13-20
beam clips.....	21, 37
beam furring clips.....	21, 39
spring lath clips.....	21, 48
shelf angle location.....	90, 91
Dome roof construction.....	154
Durability of steel construction.....	136
Economy of steel construction.....	63, 116-119, 137
Economical spans, steel joists.....	22, 67
Erection of steel joists.....	54, 140, 142
Estimating data.....	56
steel joists.....	56
accessory quantities.....	62
Explanatory notes, safe loading tables.....	23
Fibre stresses, safe for various spans.....	163
for designing.....	22-24
structural timbers.....	165
Field for use of steel lumber.....	12, 139
Fill, concrete.....	132

THE NATIONAL PRESSED STEEL COMPANY

INDEX—Continued

	PAGE
Fireproof qualities of steel joists.....	7, 9, 135
Fireproofing, structural steel.....	106-109
requirements for.....	7, 9
Firesafe first floors.....	141
Flexure of beams, formula for.....	158, 159
Floor construction, standard steel joist.....	55, 75, 101
bridging for.....	49-53
comparison of weight.....	117, 131
comparison of costs.....	65-67
concrete fill.....	121, 129, 143
dead load, method of calculating.....	131
description.....	120
development of.....	116
floor finishes.....	76-79
floor loads.....	156, 157
framing details (see construction details).....	125
steel lath for.....	40
spacing of joists.....	23, 128, 142
specifications.....	120
Footings, design.....	111-115
comparative costs.....	72, 73
table of quantities.....	113-115
unit stresses for.....	111
Formulæ, bending moments.....	158, 159
web buckling.....	34
Framing details, floors.....	80, 81, 146, 147
structural steel framing.....	125-127
dimensions for locating shelf angles.....	90, 91
Function of bridging.....	49
steel joists.....	5
Furring, beams.....	107
clips.....	21, 39
Garage floors.....	128
Gauge equivalents.....	170
United States standard.....	170
Birmingham.....	170
General information.....	132-148
Grand stand construction.....	96
Granite, masonry, weight of.....	161
Gypsum block, weight of.....	161
Heating pipes, installation.....	93, 142
Hangers, pipe.....	93, 95
Identification of steel lumber sections.....	12
Installation, conduits, pipes, etc.	93, 95, 142

THE NATIONAL PRESSED STEEL COMPANY

INDEX—Continued

	PAGE
steel joists.....	54, 140, 142
strap bridging.....	52
time of steel construction.....	138
Iron, weight of.....	161
Joists, steel, analysis of.....	9, 120, 134
accessories.....	12, 21
analysis of sections.....	9, 120, 134
base for pricing.....	12
bearings for.....	78, 84, 89, 122
chemical analysis.....	120
coefficients for deflection.....	162
comparison of weight.....	116-119, 131
with wood joists.....	167
corrosion.....	137
cutting of.....	134
cutting tolerances.....	12
deflection.....	11
designation of.....	12
designing data.....	22
description of.....	12
development of.....	8
economy of.....	63, 137
economical span.....	22, 67
erection.....	142
estimating data.....	56
fibre stress.....	24
field for use.....	12
fireproofing of.....	7
fireproof qualities.....	135
floor construction, standard.....	55, 75, 101, 120
formulæ for calculation.....	158, 159
framing of.....	80, 81, 133, 146, 147
forming of.....	133
function of.....	5
installation of.....	54
lateral bracing.....	23, 54
maximum strength, temperature.....	7
method of production.....	9, 132
methods of supporting.....	22, 84-91, 141
painting.....	134
panel construction.....	55, 101
physical qualities.....	9, 134
points of merit.....	10
properties of.....	23-25

INDEX—Continued

	PAGE
safe loading tables.....	23-33
spacing.....	23, 122, 142
special sections.....	12
specifications.....	120
steel, comparison with wood joists.....	167
stresses, safe for deflection.....	163
wall anchors for.....	86, 92
welding of.....	133
weight of.....	13, 20, 130
ultimate strength.....	23
web resistance.....	34
Kansas City, code specifications for live loads.....	156, 157
Lath, steel.....	40-43
adapted to steel joists.....	40
basis of merit.....	40
erection of.....	42, 44, 48, 143
specifications for.....	121
Lath clips, description.....	44-48, 144
number clips required.....	48
method of installing.....	45
manner packed.....	48
method of separating clips in package.....	48
spacing on floors and ceilings.....	46-47
Lateral bracing, steel joists.....	23, 54
Length of sections, steel joists.....	133
Lintels.....	150
Limestone masonry, weight of.....	161
Live load specifications.....	156-157
Loading tables.....	23-33
Locating shelf angles.....	90, 91
Location of welds, steel joists.....	133
Lumber, weight of.....	161
Mastic flooring, weight of.....	160
Marble, weight of.....	161
Masonry walls, weight of.....	161
Maple flooring, weight of.....	160
Maximum spans for structural timbers.....	165
Metal lath, (see also lath) sheet sizes.....	23
Method, estimating steel joists.....	56
framing openings.....	80, 81
fireproofing structural steel.....	106-109
installing lath clips.....	45
producing steel lumber.....	132
Milwaukee, code specifications for live loads.....	156, 157

THE NATIONAL PRESSED STEEL COMPANY

INDEX—Continued

	PAGE
Minneapolis, code specifications for live loads.....	156, 157
Moments of inertia, steel joists.....	25
bending for beams.....	158, 159
Nails, attaching bridging to steel joists, quantity.....	62
Nailing strip.....	76, 79, 94, 143
specifications for.....	121
National strip production.....	132
National strip steel.....	169
New Orleans, code specifications for live loads.....	156, 157
Oak flooring, weight of.....	160
Omaha, code specifications for live loads.....	156, 157
Outlet boxes, method of attaching.....	94
Painting, steel joists.....	134
Partition construction, illustrations of.....	78, 79, 82
safe loading tables.....	32
Pavement forms.....	152
Philadelphia, code specifications for live loads.....	156, 157
Piling, sheet.....	155
Piping, installation with steel joists.....	79, 93-95
Pittsburgh, code specifications for live loads.....	156, 157
Placing concrete on floor lath.....	144
Plaster, specifications for.....	123
weight of.....	161
Points of merit, steel joist floors.....	10
Portland, code specifications for live loads.....	156, 157
Pounds of steel joist per sq. ft. floor area.....	57-61
Production of strip steel.....	132
Properties of sections, steel joists.....	25
Providence, code specifications for live loads.....	156, 157
Rivet sizes, steel joist connections.....	80, 83
Rolled steel sections, framing members.....	126, 127
Rigidity of steel construction.....	139
Roof construction.....	97-100
spacing of joists.....	122, 142
Roof trusses, steel joists.....	149
Roofing materials, weight of.....	161
Safe loading tables, steel joists.....	23-33
rolled steel framing members.....	126, 127
structural timbers.....	166
explanatory notes.....	23
Sandstone, weight of.....	161
San Francisco, code specifications for live loads.....	156, 157
Screeds, nailing.....	76, 79, 94, 143
Seattle, code specifications for live loads.....	156, 157

THE NATIONAL PRESSED STEEL COMPANY

INDEX—Continued

	PAGE
Sheet metal gauges.....	170
Shelf angles, location of.....	90, 91
Shelving.....	153
Sheet Piling.....	155
Sidewalk forms.....	152
Simplicity of steel construction.....	140
Single strap bridging, sizes of.....	51
Sizes of, beam furring clips.....	21, 39
Beam clips.....	21, 37
Spring lath clips.....	21, 48
Soundproof qualities, steel joist floors.....	136
Spacing of steel joists.....	23, 142
Specifications.....	120-124
live loads.....	156, 157
bridging.....	121
plaster.....	123
steel joists.....	120
steel lath.....	121
suspended ceiling.....	124
Special steel joist sections.....	12
Spring lath clips.....	21, 44-48, 144
number required.....	48
manner packed.....	48
weight of.....	48
spacing.....	46
Stairway construction.....	102, 105
Standard steel joist floor construction.....	55, 75, 101
Standard extras for strip steel.....	169
Standard sections.....	13-20
Steel, weight of.....	161, 170
Steel Construction, adaptability of.....	139
cost data.....	64
dead weight of.....	139
economy of.....	63, 137, 116, 119
erection of.....	54, 140, 142
rigidity.....	139
simplicity of.....	140
Steel joist (see also joist).....	13-20
Steel lath.....	21, 40-43
application of.....	42, 48, 143
basis of merit.....	40
specifications.....	121
St. Louis, code specifications for live loads.....	156, 157
Strap bridging (see also bridging).....	21

INDEX—Continued

	PAGE
Strength of, concrete fill over joists.....	129
steel joist floors.....	11
steel at high temperature.....	6
Strip steel production.....	132
Structural steel, cost of.....	68-71
fireproofing of.....	7, 106-109
framing members.....	125-127
method of production.....	9
necessity of fireproofing.....	9
Structural timbers, comparison with steel joists.....	167
fibre stress.....	165
maximum spans.....	165
safe loading.....	166
Suspended ceiling.....	97
specifications for.....	124
Steel lumber sections, various uses.....	149-155
Table of board measure.....	168
Temperature strength curve, steel.....	6
Terrazo flooring, weight of.....	161
Ties, lateral for steel joists.....	55, 92
Tile, hollow walls, weight of.....	160
flat flooring, weight of.....	161
fireproofing structural steel.....	110
Tire racks.....	153
Tolerances.....	12
Truck frames.....	150
Tunnel shoring.....	151
Ultimate strength, steel joists.....	7
U. S. standard gauge.....	170
Various uses for National Sections.....	149-155
Wall anchors for steel joists.....	86, 92
Walls, masonry, weight of.....	160
Water, weight of.....	161
Web resistance.....	34
Weights of, steel joist.....	13-20
steel joist floors.....	130
strip steel.....	170
building materials.....	160, 161
various firesafe floor slabs.....	131
Welding, steel joists.....	133
Widths of National strip steel.....	169
Wood joists, comparison with steel joists.....	8, 167

DISTRIBUTERS OF NATIONAL STEEL LUMBER

Akron, Ohio	H. L. Thomas Co.
Albany, Ala.....	Decatur Cornice & Roofing Co.
Albany, N. Y.....	N. C. Clausen Architectural Iron Works.
Atlanta, Ga.....	Austin Bros.
Aurora, Ill.....	Garbe Iron Works.
Baltimore, Md.....	Chesapeake Iron Works.
Bethlehem, Pa.....	Bethlehem Construction Co.
Birmingham, Ala.....	Ingalls Iron Works.
Boston, Mass.....	Boston Structural Steel Co. (Cambridge)
Buffalo, N. Y.....	Buffalo Structural Steel Co.
Cambridge, Mass.....	Boston Structural Steel Co.
Cedar Rapids, Ia.....	Iowa Steel & Iron Works.
Charlotte, N. C.....	Southern Engineering Co.
Chattanooga, Tenn.	Converse Bridge & Steel Co.
Chicago, Ill.....	Duffin Iron Co. Gage Structural Steel Co. Holmes-Pyott Co. Kenwood Bridge Co. Union Foundry Works. Vanderkloot Steel Works.
Cincinnati, Ohio	The General Iron Works Co.
Cleveland, Ohio	The Van Dorn Iron Works Co.
Columbus, Miss.....	Decatur Cornice & Roofing Co.
Columbus, Ohio	The Fred A. TARRIER Co.

THE NATIONAL PRESSED STEEL COMPANY

National Steel Lumber Distributers.—Continued

Dallas, Texas	Mosher Steel & Machinery Co.
Dayton, Ohio	The Dayton Structural Steel Co.
Decatur, Ill.....	Decatur Bridge Co.
Denver, Colo.....	Robt. C. Cornett & Co. Minneapolis Steel & Machinery Co.
Des Moines, Ia.....	Des Moines Steel Co.
Detroit, Mich.....	Lewis-Hall Iron Works.
Erie, Pa.....	Erie Steel Construction Co.
Evansville, Ind.....	International Steel & Iron Co.
Ft. Wayne, Ind.....	The Engineering Co.
Great Falls, Mont.	Minneapolis Steel & Machinery Co.
Greenville, S. C.....	Decatur Cornice & Roofing Co.
Hartford, Conn.....	J. C. Bidwell & Co.
Houston, Texas	Houston Structural Steel Co.
Indianapolis, Ind.....	Hetherington & Berner.
Jacksonville, Fla.....	Decatur Cornice & Roofing Co.
Johnstown, Pa.....	Geo. J. Griffith Co.
Kansas City, Mo.....	Kansas City Structural Steel Co.
Kansas City, Kansas ..	Kansas City Structural Steel Co.
Little Rock, Ark.....	Bemberg & Sons Iron Works.
Long Island City.....	National Bridge Works.
Mansfield, Ohio	The Hughes-Keenan Co.
Massillon, Ohio.....	The Massillon Bridge & Structural Co.
Memphis, Tenn.....	Pidgeon-Thomas Iron Co.
Meriden, Conn.....	National Bridge Works.

THE NATIONAL PRESSED STEEL COMPANY

National Steel Lumber Distributers.—Continued

Milwaukee, Wis.....	A. F. Wagner Architectural Iron Works Co.
Minneapolis, Minn.....	Crown Iron Works Co. Minneapolis Steel & Machinery Co.
Muskogee, Okla.....	Muskogee Iron Works.
Nashville, Tenn.....	Nashville Bridge Co.
Newark, N. J.....	A. S. Reid & Co.
New Orleans, La.....	Christopher & Simpson Iron Works Nashville Bridge Co.
New York City.....	National Bridge Works (Long Island City).
Norfolk, Va.....	Richmond Structural Steel Co.
Oklahoma City, Okla.	J. B. Klein Iron & Foundry Co.
Omaha, Neb.....	Omaha Steel Works.
Philadelphia, Pa.....	Belmont Iron Works.
Pittsburgh, Pa.....	Taylor & Dean.
Portland, Ore.....	Walter A. Scott Co.
Providence, R. I.....	Providence Steel & Iron Co.
Quincy, Ill.....	Michelmann Steel Construction Co.
Richmond, Va.....	Richmond Structural Steel Co.
Roanoke, Va.....	Roanoke Iron & Bridge Works.
Rockford, Ill.....	A. C. Woods & Co.
Rock Island, Ill.....	Rock Island Bridge & Iron Works.
Rochester, N. Y.....	F. L. Heughes & Co.
Salt Lake City, Utah ..	Minneapolis Steel & Machinery Co.
San Francisco, Cal.....	Walter A. Scott Co.

THE NATIONAL PRESSED STEEL COMPANY

National Steel Lumber Distributers.—Continued

Scranton, Pa.....	Anthracite Bridge Co.
Seattle, Wash.....	S. W. R. Dally Co.
Spokane, Wash.....	S. W. R. Dally Co. Minneapolis Steel & Machinery Co.
St. Louis, Mo.....	Christopher & Simpson Iron Works.
St. Joseph, Mo.....	St. Joseph Structural Steel Co.
Syracuse, N. Y.....	Syracuse Engineering Co.
Tacoma, Wash.....	S. W. R. Dally Co.
Toledo, Ohio	Geo. L. Kirby Co.
Utica, N. Y.....	Utica Steam Engine & Boiler Works.
Waukesha, Wis.....	Federal Bridge & Structural Co.
Wheeling, W. Va.....	The J. E. Moss Iron Works.

NATIONAL STEEL LUMBER SECTIONS

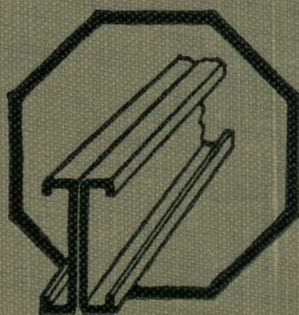

1921