

POCKET COMPANION

AISC E&R Library
5442

ARCH
TA685
.C46
1923

5442

CARNEGIE STEEL COMPANY
PITTSBURGH, PA.

B

POCKET COMPANION

FOR

ENGINEERS, ARCHITECTS AND BUILDERS

CONTAINING

USEFUL INFORMATION AND TABLES

APPERTAINING TO THE USE OF

STEEL

MANUFACTURED BY

CARNEGIE STEEL COMPANY

PITTSBURGH, PA.

Copyright 1923 by
CARNEGIE STEEL COMPANY
Pittsburgh, Pa.

Twenty-Third Edition, January 1, 1923.

Printed in U. S. A.

THE first edition of Carnegie Pocket Companion appeared in 1872 and was issued by Carnegie, Kloman & Company, Proprietors of the Union Iron Mills, Pittsburgh, Pa.

This book and its successive editions have served to advance the interests of standardization in structural practice and record the stages of development in the manufacture of structural steel and its fabrication into bridges, buildings, cars and ships.

In this, the twenty-third edition, the dimensions and weights of beams and channels conform to the action taken by the Association of American Steel Manufacturers effective September 1, 1920, by which fillets and roundings are included in the computation of weights. The properties of sections of intermediate and maximum thicknesses have been recomputed and the safe load tables have been exactly adjusted to the new properties.

Attention is called to changes in section numbers of standard beams and particularly in section numbers of angles. Purchasers are requested to show the new section numbers on all orders.

The sections shown in profiles and tables are those which are most suitable for use in bridge, building, car and ship construction. A complete list of all the sections rolled by Carnegie Steel Company, together with tables of weights and other data in regard to these products, is given in Carnegie Shape Book.

The specifications of the American Society for Testing Materials, published in previous editions of the Carnegie Pocket Companion, have been omitted in the present edition; these and other standard specifications pertaining to steel entering into the construction of bridges, buildings, ships, locomotives and cars, also specifications for wheels, axles and similar forgings, are published in a separate pamphlet entitled "Standard Specifications" issued by Carnegie Steel Company and sent to users of steel upon application.

ORDERING MATERIAL

GENERAL INSTRUCTIONS

Structural steel for bridges, buildings, cars and ships, steel reinforcement bars and rivet steel are rolled to permissible variations given in the specifications of the American Society for Testing Materials and of the Association of American Steel Manufacturers. In cases of design which require close fitting, allowance should be made for rolling variations so as to insure ample clearances between abutting or interfitting surfaces.

All dimensions given on profiles are theoretical. The exact dimensions of structural sections depend on conditions of rolls.

Wherever the profile applies to more than one weight of section, the dimensions are for the normal profile, which is the section of minimum thickness unless otherwise indicated in bold type. Sections having but one weight specified are rolled to that weight only.

Weights of rails are given per lineal yard of section but, unless otherwise indicated, all other weights are per lineal foot. Structural Sections should be ordered to weight per foot, length in feet and inches. Orders for Plates should specify all dimensions in inches. Orders for Rounds, Squares and other bar mill products should specify width and thickness in inches and length in feet and inches. Rails, Ties and other track accessories should be ordered by section number and not by linear weight.

Section number should be specified on orders for all sections.

The Association of American Steel Manufacturers has recommended certain angle sections as standard for bridge, car, ship and general building construction, and quicker deliveries can be obtained by ordering these standard sizes. Angles not standard are marked "special" on the profile pages.

INCREASE OF SECTIONAL AREAS

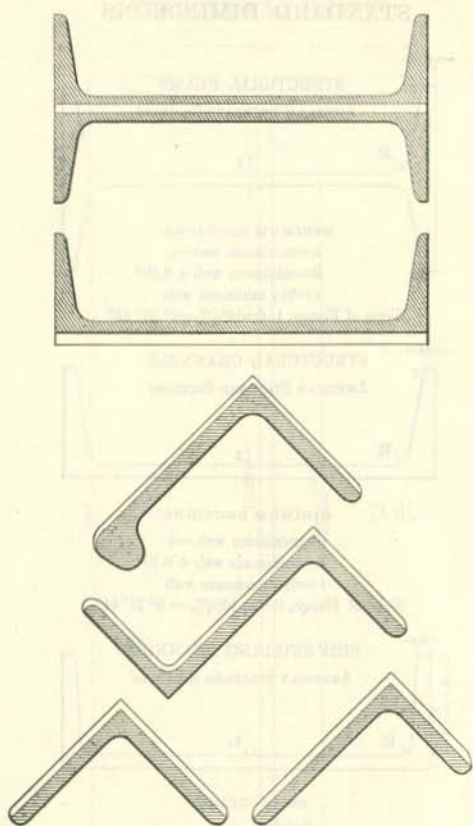

The above figures show the method of increasing the sectional areas and weights of structural shapes. Cross hatched portions represent the minimum sections and the blank portions the added areas.

In the case of Channels, and I-Beams the enlargement of the section adds an equal amount to the thickness of the web and the width of the flanges. In the case of Angles and Zees, the effect of spreading the rolls is slightly to increase the length of the legs. In the case of Ship Building Bulb Angles, as a rule, each increase or decrease in web thickness carries with it about one-half that increase or decrease in flange thickness.

Inasmuch as the roll passes are modified in the wear of the rolls, the actual dimensions will not always conform to the theoretical, even in the case of the minimum weight sections. Designers and detailers of structural work should arrange for ample clearances.

STANDARD DIMENSIONS

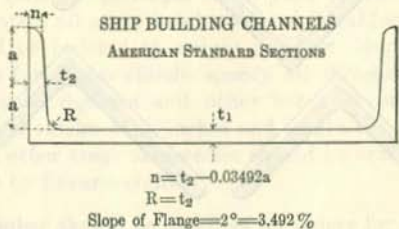
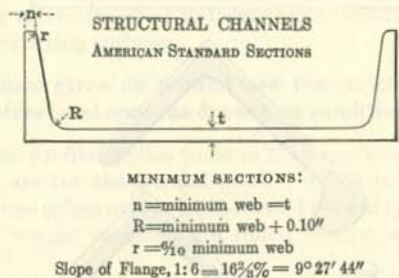
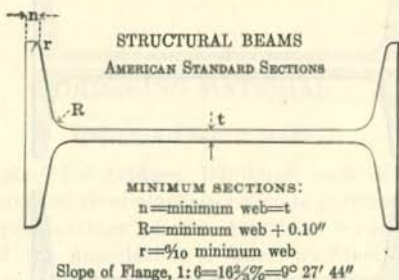

Dimensions for Structural Beams are those adopted by the Association of American Steel Manufacturers and apply to all Structural Beams, except American Standard Sections B 1, B 2 and B 3, also Sections B 18 and B 19.

The dimensions of the Supplementary Beams, B 61 to B 68, inclusive, cannot be readily reduced to formulas. Slope of flange is 1:11 = $5^\circ 11' 40''$.

Dimensions for Structural Channels are those adopted by the Association of American Steel Manufacturers and apply to all Structural Channels, except Sections C 20, C 60 and C 170.

Dimensions for Ship Building Channels are those adopted by the Association of American Steel Manufacturers and conform to the 1903 Standards of the British Engineering Standards Association; they apply to all Ship Building Channels.

STRUCTURAL BEAMS



B 61

Section Index	Depth of Beam, Inches	Weight per Foot, Pounds	Flange Width, Inches		Web Thickness, Inches	
			Decimal	Fractional	Decimal	Fractional
*B 61	27	90.0	9.00	9	0.524	$17/32$

*Supplementary Beam.

CARNEGIE STEEL COMPANY

STRUCTURAL BEAMS—Continued

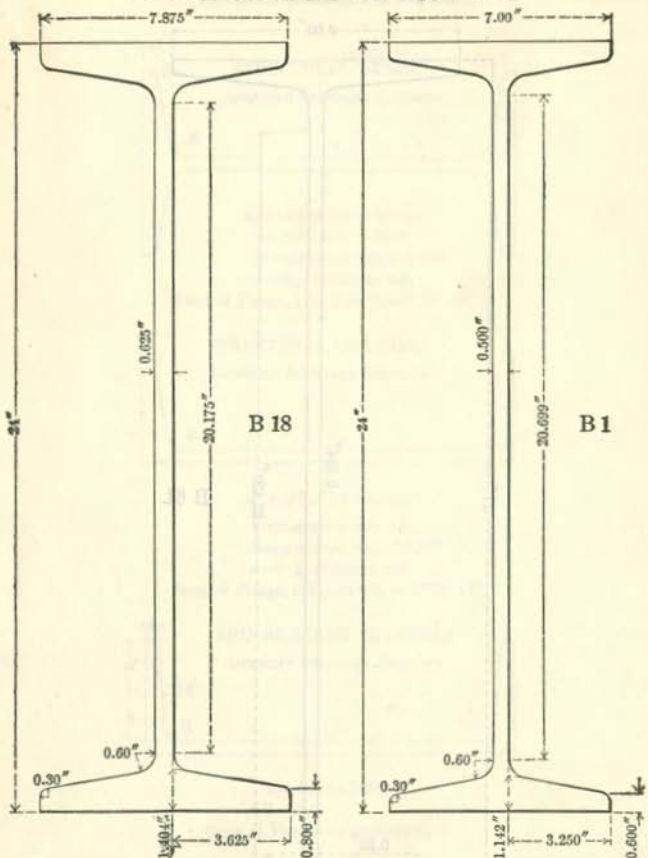

Section Index	Depth of Beam, Inches	Weight per Foot, Pounds	Flange Width, Inches		Web Thickness, Inches	
			Decimal	Fractional	Decimal	Fractional
B 18 (Old No. B 24)	24	120.0	8.048	$8\frac{3}{64}$	0.798	$5\frac{1}{64}$
		115.0	7.987	$7\frac{63}{64}$	0.737	$4\frac{7}{64}$
		110.0	7.925	$7\frac{59}{64}$	0.675	$4\frac{5}{64}$
		105.9	7.875	$7\frac{7}{8}$	0.625	$5\frac{1}{8}$
B 1	24	100.0	7.247	$7\frac{1}{4}$	0.747	$3\frac{3}{4}$
		95.0	7.186	$7\frac{9}{16}$	0.686	$1\frac{11}{16}$
		90.0	7.124	$7\frac{1}{8}$	0.624	$5\frac{9}{8}$
		85.0	7.063	$7\frac{1}{16}$	0.563	$9\frac{1}{16}$
		79.9	7.000	7	0.500	$1\frac{1}{2}$

STRUCTURAL BEAMS—Continued

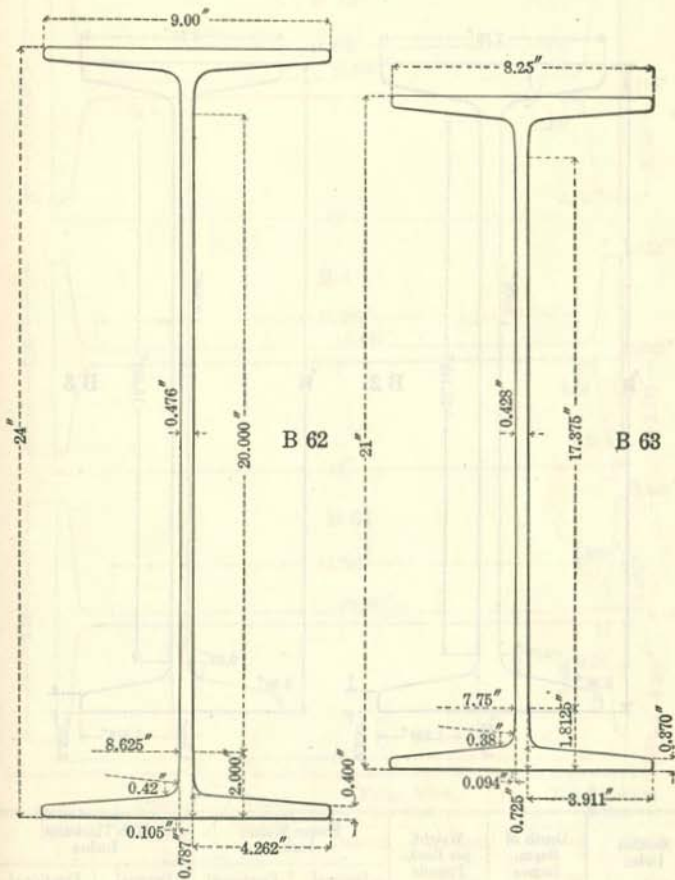

Section Index	Depth of Beam, Inches	Weight per Foot, Pounds	Flange Width, Inches		Web Thickness, Inches	
			Decimal	Fractional	Decimal	Fractional
*B 62	24	74.2	9.00	9	0.476	$\frac{15}{32}$
*B 63	21	60.4	8.25	$8\frac{1}{4}$	0.428	$\frac{27}{64}$

*Supplementary Beam.

STRUCTURAL BEAMS—Continued

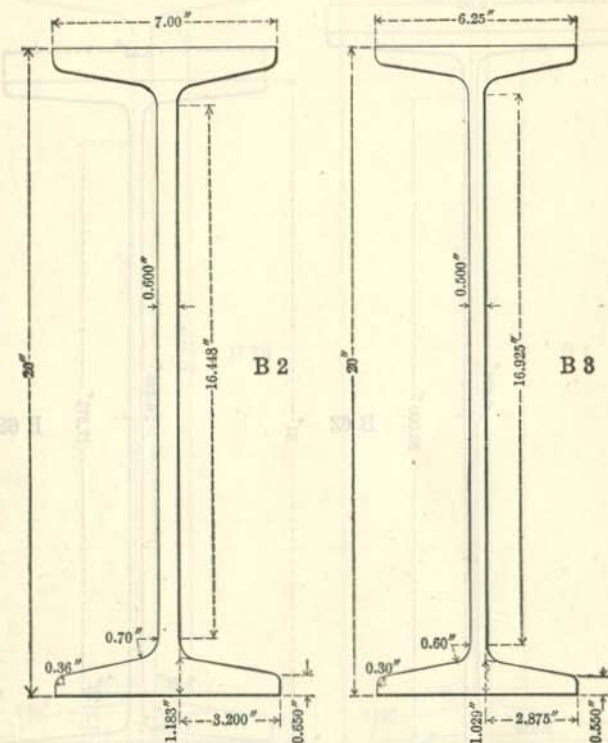

Section Index	Depth of Beam, Inches	Weight per Foot, Pounds	Flange Width, Inches		Web Thickness, Inches	
			Decimal	Fractional	Decimal	Fractional
B 2	20	100.0	7.273	7 ¹⁷ / ₆₄	0.873	⁷ / ₈
		95.0	7.200	7 ¹³ / ₆₄	0.800	⁵¹ / ₆₄
		90.0	7.126	7 ¹ / ₈	0.726	²³ / ₃₂
		85.0	7.053	7 ⁹ / ₆₄	0.653	²¹ / ₃₂
		81.4	7.000	7	0.600	¹⁹ / ₃₂
B 3	20	75.0	6.391	6 ²⁵ / ₆₄	0.641	⁴¹ / ₆₄
		70.0	6.317	6 ²¹ / ₆₄	0.567	⁹ / ₁₆
		65.4	6.250	6 ¹ / ₄	0.500	¹ / ₂

STRUCTURAL BEAMS—Continued

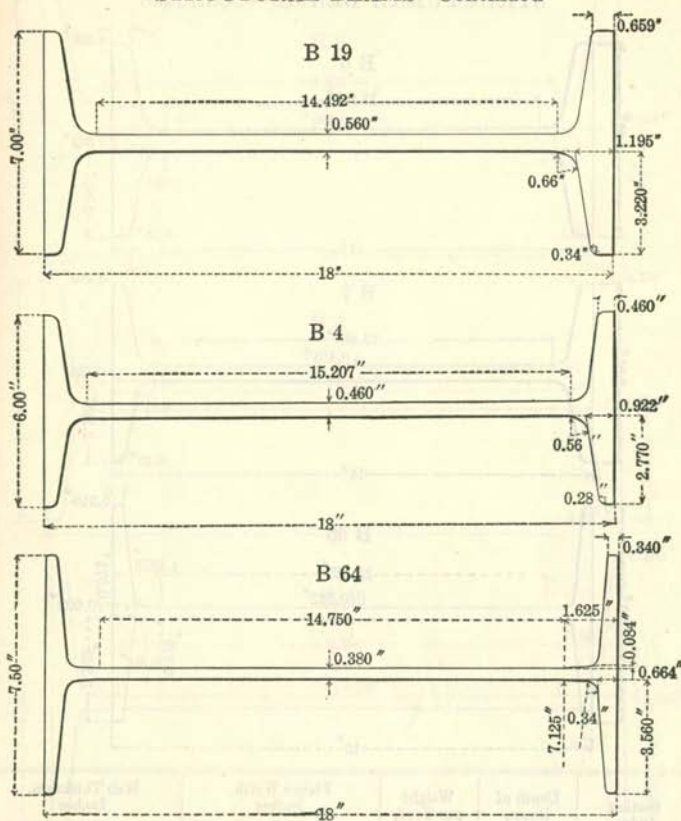

Section Index	Depth of Beam, Inches	Weight per Foot, Pounds	Flange Width, Inches		Web Thickness, Inches	
			Decimal	Fractional	Decimal	Fractional
B 19 (Old No. B 81)	18	90.0	7.236	7 ¹⁵ / ₆₄	0.796	5 ¹ / ₆₄
		85.0	7.154	7 ⁵ / ₃₂	0.714	2 ³ / ₃₂
		80.0	7.072	7 ⁹ / ₆₄	0.632	5 ⁵ / ₈
		75.6	7.000	7	0.560	7 ¹ / ₁₆
B 4 (Old No. B 80)	18	70.0	6.251	6 ¹ / ₄	0.711	2 ³ / ₃₂
		65.0	6.169	6 ¹¹ / ₆₄	0.629	5 ⁵ / ₈
		60.0	6.087	6 ³ / ₃₂	0.547	3 ⁵ / ₆₄
		54.7	6.000	6	0.460	2 ⁹ / ₆₄
*B 64	18	48.2	7.500	7 ¹ / ₂	0.380	3 ⁵ / ₈

*Supplementary Beam.

CARNEGIE STEEL COMPANY

STRUCTURAL BEAMS—Continued

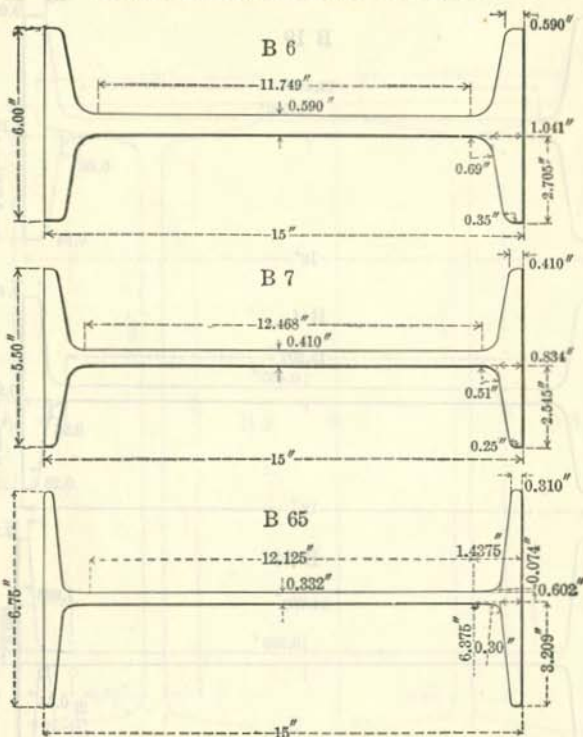

Section Index	Depth of Beam, Inches	Weight per Foot, Pounds	Flange Width, Inches		Web Thickness, Inches	
			Decimal	Fractional	Decimal	Fractional
B 6 (Old No. B5)	15	75.0	6.278	6 $\frac{9}{32}$	0.868	$\frac{7}{8}$
		70.0	6.180	6 $\frac{3}{16}$	0.770	$\frac{49}{64}$
		65.0	6.082	6 $\frac{5}{64}$	0.672	$\frac{43}{64}$
		60.8	6.000	6	0.590	$1\frac{19}{32}$
B 7	15	55.0	5.738	5 $\frac{47}{64}$	0.648	$\frac{41}{64}$
		50.0	5.640	5 $\frac{41}{64}$	0.550	$\frac{35}{64}$
		45.0	5.542	5 $\frac{35}{64}$	0.452	$\frac{29}{64}$
		42.9	5.500	5 $\frac{1}{2}$	0.410	$1\frac{13}{32}$
*B 65	15	37.3	6.750	6 $\frac{3}{4}$	0.332	$\frac{21}{64}$

* Supplementary Beam.

STRUCTURAL BEAMS—Continued

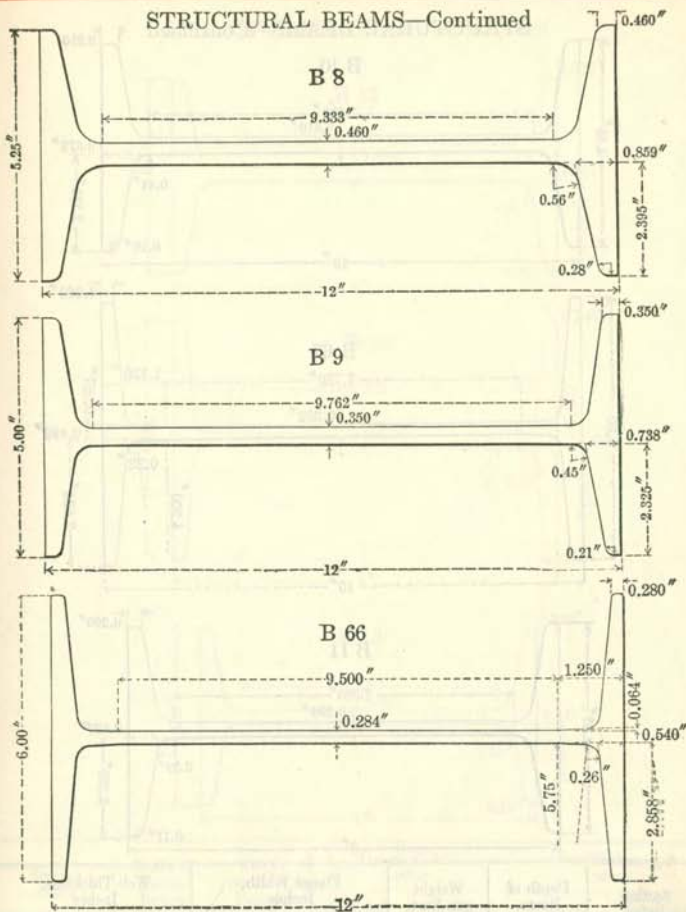

Section Index	Depth of Beam, Inches	Weight per Foot, Pounds	Flange Width, Inches		Web Thickness, Inches	
			Decimal	Fractional	Decimal	Fractional
B 8	12	55.0	5.600	$5\frac{19}{64}$	0.810	$1\frac{3}{16}$
		50.0	5.477	$5\frac{31}{64}$	0.687	$1\frac{1}{16}$
		45.0	5.355	$5\frac{28}{64}$	0.565	$\frac{9}{16}$
		40.8	5.250	$5\frac{1}{4}$	0.460	$29\frac{64}{64}$
B 9	12	35.0	5.078	$5\frac{9}{64}$	0.428	$27\frac{64}{64}$
		31.8	5.000	5	0.350	$1\frac{1}{8}$
*B 66	12	27.9	6.000	6	0.284	$\frac{9}{32}$

*Supplementary Beam.

CARNEGIE STEEL COMPANY

STRUCTURAL BEAMS—Continued

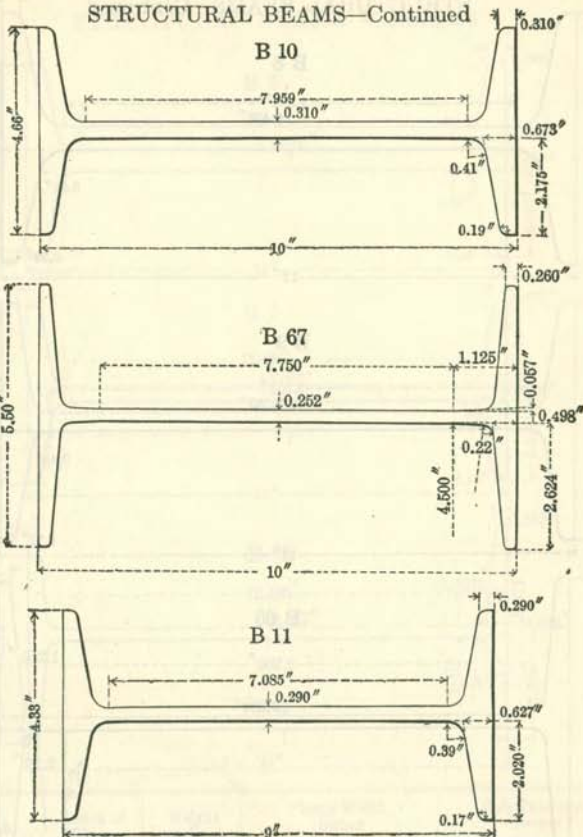

Section Index	Depth of Beam, Inches	Weight per Foot, Pounds	Flange Width, Inches		Web Thickness, Inches	
			Decimal	Fractional	Decimal	Fractional
B 10 (Old No. B 11)	10	40.0	5.091	5 $\frac{9}{32}$	0.741	4 $\frac{7}{64}$
		35.0	4.944	4 $\frac{17}{16}$	0.594	1 $\frac{9}{32}$
		30.0	4.797	4 $\frac{51}{64}$	0.447	2 $\frac{9}{64}$
		25.4	4.660	4 $\frac{21}{32}$	0.310	5 $\frac{1}{16}$
*B 67	10	22.4	5.500	5 $\frac{1}{2}$	0.252	$\frac{1}{4}$
B 11 (Old No. B 13)	9	35.0	4.764	4 $\frac{9}{64}$	0.724	2 $\frac{9}{32}$
		30.0	4.601	4 $\frac{19}{32}$	0.561	9 $\frac{1}{8}$
		25.0	4.437	4 $\frac{7}{16}$	0.397	2 $\frac{5}{64}$
		21.8	4.330	4 $\frac{21}{64}$	0.290	1 $\frac{9}{64}$

*Supplementary Beam.

STRUCTURAL BEAMS—Continued

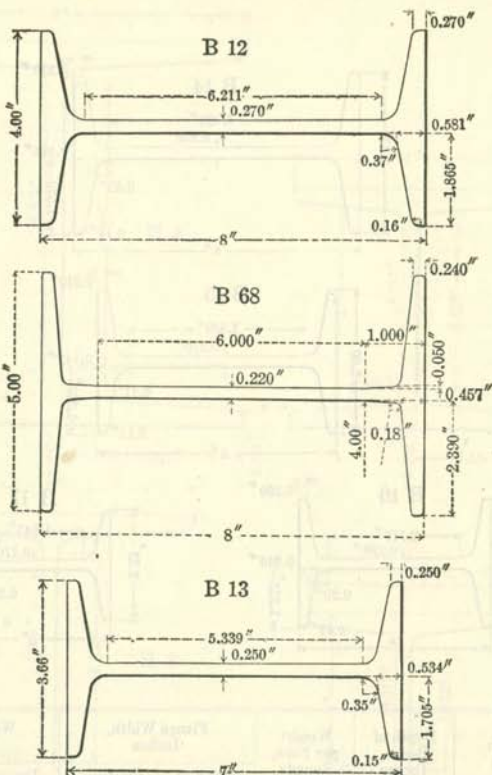

Section Index	Depth of Beam, Inches	Weight per Foot, Pounds	Flange Width, Inches		Web Thickness, Inches	
			Decimal	Fractional	Decimal	Fractional
B 12 (Old No. B 15)	8	25.5	4.262	4 $\frac{17}{64}$	0.532	1 $\frac{7}{32}$
		23.0	4.171	4 $\frac{11}{64}$	0.441	$\frac{7}{16}$
		20.5	4.079	4 $\frac{5}{64}$	0.349	1 $\frac{1}{32}$
		18.4	4.000	4	0.270	1 $\frac{1}{4}$
*B 68	8	17.5	5.000	5	0.220	$\frac{7}{32}$
		20.0	3.860	3 $\frac{55}{64}$	0.450	2 $\frac{3}{64}$
B 13 (Old No. B 17)	7	17.5	3.755	3 $\frac{3}{4}$	0.345	1 $\frac{1}{32}$
		15.3	3.660	3 $\frac{21}{32}$	0.250	$\frac{1}{4}$

*Supplementary Beam.

STRUCTURAL BEAMS—Concluded

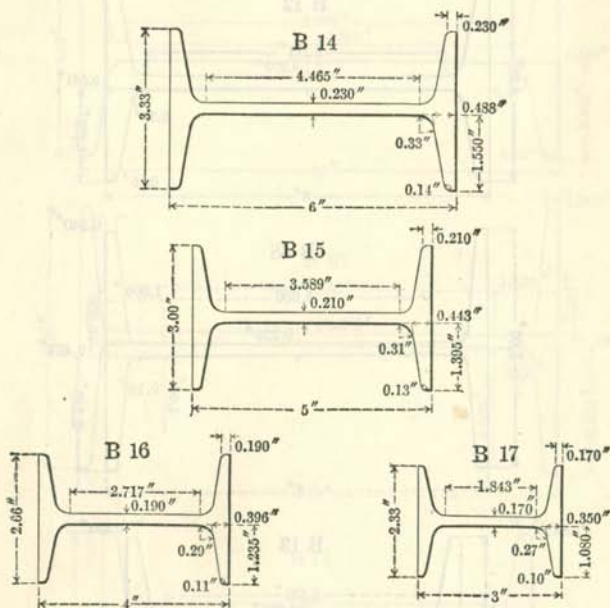

Section Index	Depth of Beam, Inches	Weight per Foot, Pounds	Flange Width, Inches		Web Thickness, Inches	
			Decimal	Fractional	Decimal	Fractional
B 14 (Old No. B 19)	6	17.25	3.565	$3\frac{9}{16}$	0.465	$1\frac{5}{32}$
		14.75	3.443	$3\frac{7}{16}$	0.343	$1\frac{1}{8}$
		12.5	3.330	$3\frac{21}{64}$	0.230	$1\frac{5}{64}$
B 15 (Old No. B 21)	5	14.75	3.284	$3\frac{9}{32}$	0.494	$\frac{1}{2}$
		12.25	3.137	$3\frac{3}{64}$	0.347	$1\frac{1}{32}$
		10.0	3.000	3	0.210	$1\frac{3}{64}$
B 16 (Old No. B 23)	4	10.5	2.870	$2\frac{7}{8}$	0.400	$1\frac{5}{32}$
		9.5	2.796	$2\frac{51}{64}$	0.326	$2\frac{1}{64}$
		8.5	2.723	$2\frac{23}{32}$	0.253	$\frac{1}{4}$
B 17 (Old No. B 77)	3	7.7	2.660	$2\frac{21}{32}$	0.190	$\frac{3}{16}$
		7.5	2.509	$2\frac{33}{64}$	0.349	$1\frac{1}{32}$
		6.5	2.411	$2\frac{13}{32}$	0.251	$\frac{1}{4}$
		5.7	2.330	$2\frac{21}{64}$	0.170	$1\frac{1}{64}$

BEAMS

H-BEAMS

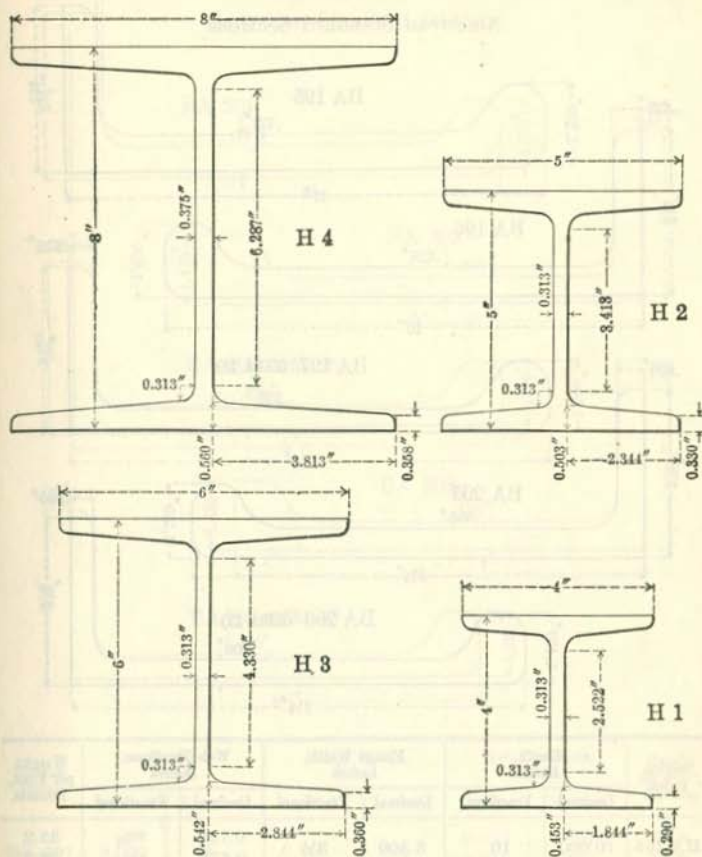

Section Index	Depth of Beam, Inches	Weight per Foot, Pounds	Flange Width, Inches		Web Thickness, Inches	
			Decimal	Fractional	Decimal	Fractional
H 4	8	37.7	8.125	8½	0.500	½
		34.3	8.000	8	0.375	¾
		32.6	7.938	7½⅞	0.313	⅝
H 3	6	26.7	6.125	6½	0.438	⅞
		24.1	6.000	6	0.313	⅝
		22.8	5.938	5½⅞	0.250	¼
H 2	5	18.9	5.000	5	0.313	⅝
H 1	4	13.8	4.000	4	0.313	⅝

Full information as to uses of H-Beams is given in pamphlet entitled "Steel Mine Timbers."

CARNEGIE STEEL COMPANY

SHIP BUILDING BULB ANGLES

American Standard Sections

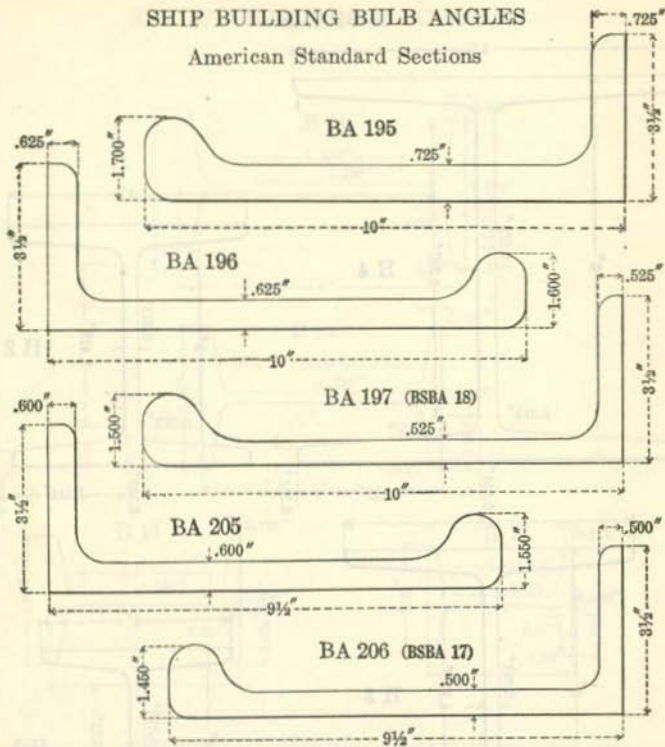

Section Index	Depth, Inches		Flange Width, Inches		Web Thickness, Inches		Weight per Foot, Pounds
	Decimal	Fractional	Decimal	Fractional	Decimal	Fractional	
BA 195	10.000	10	3.500	3½	0.725	$\frac{29}{32}$	35.2
					0.675	$\frac{49}{64}$	33.2
BA 196	10.000	10	3.500	3½	0.625	$\frac{5}{8}$	31.1
					0.575	$\frac{27}{64}$	29.1
BA 197 (BSBA 18)	10.000	10	3.500	3½	0.525	$\frac{17}{32}$	26.9
					0.475	$\frac{15}{32}$	24.9
BA 205	9.500	9½	3.500	3½	0.600	$\frac{19}{32}$	28.8
					0.550	$\frac{25}{64}$	26.9
BA 206 (BSBA 17)	9.500	9½	3.500	3½	0.500	$\frac{1}{2}$	24.7
					0.450	$\frac{29}{64}$	22.8

Dimensions of British Standard Sections are indicated in bold type.

BULB ANGLES

SHIP BUILDING BULB ANGLES—Continued
American Standard Sections

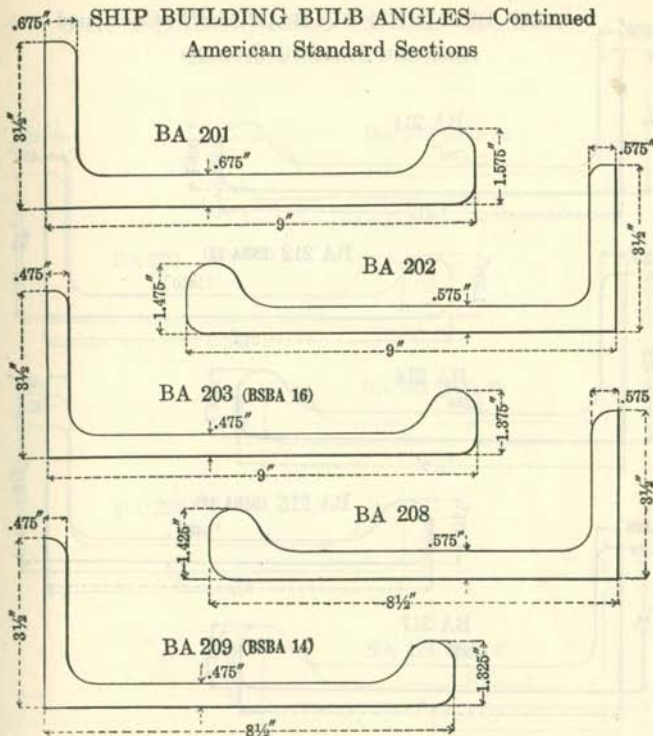

Section Index	Depth, Inches		Flange Width, Inches		Web Thickness, Inches		Weight per Foot, Pounds
	Decimal	Fractional	Decimal	Fractional	Decimal	Fractional	
BA 201	9.000	9	3.500	3½	0.675 0.625	4 ₃₂ 5 ₈	30.4 28.6
BA 202	9.000	9	3.500	3½	0.575 0.525	37 ₆₄ 17 ₃₂	26.6 24.8
BA 203 (BSBA 16)	9.000	9	3.500	3½	0.475 0.425	15 ₃₂ 27 ₆₄	22.7 20.9
BA 208	8.500	8½	3.500	3½	0.575 0.525	37 ₆₄ 17 ₃₂	25.3 23.5
BA 209 (BSBA 14)	8.500	8½	3.500	3½	0.475 0.425	15 ₃₂ 27 ₆₄	21.6 19.8

Dimensions of British Standard Sections are indicated in bold type.

CARNEGIE STEEL COMPANY

SHIP BUILDING BULB ANGLES—Continued
American Standard Sections

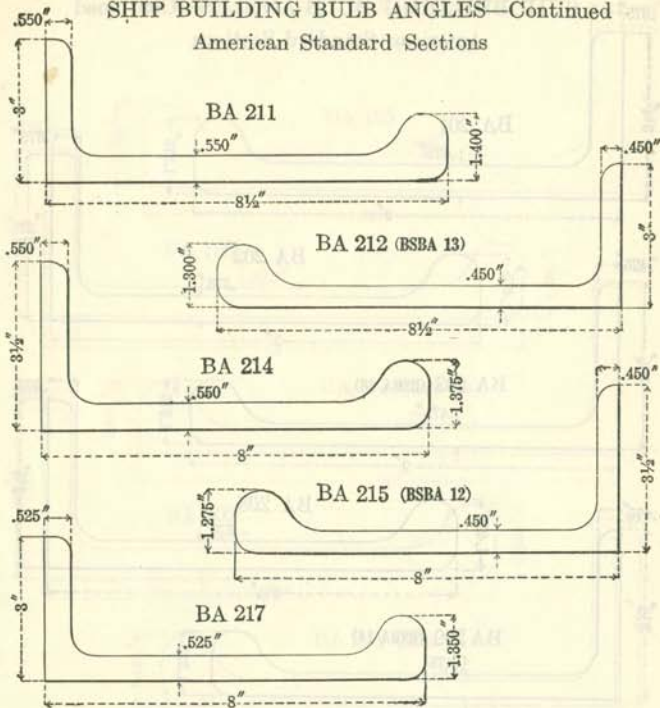

Section Index	Depth, Inches		Flange Width, Inches		Web Thickness, Inches		Weight per Foot, Pounds
	Decimal	Fractional	Decimal	Fractional	Decimal	Fractional	
BA 211	8.500	8½	3.000	3	0.550	35/64	23.4
					0.500	1/2	21.7
BA 212 (BSBA 13)	8.500	8½	3.000	3	0.450	29/64	19.8
					0.400	13/32	18.1
BA 214	8.000	8	3.500	3½	0.550	35/64	23.2
					0.500	1/2	21.6
BA 215 (BSBA 12)	8.000	8	3.500	3½	0.450	29/64	19.6
					0.400	13/32	18.0
BA 217	8.000	8	3.000	3	0.575	37/64	23.1
					0.525	17/32	21.4

Dimensions of British Standard Sections are indicated in bold type.

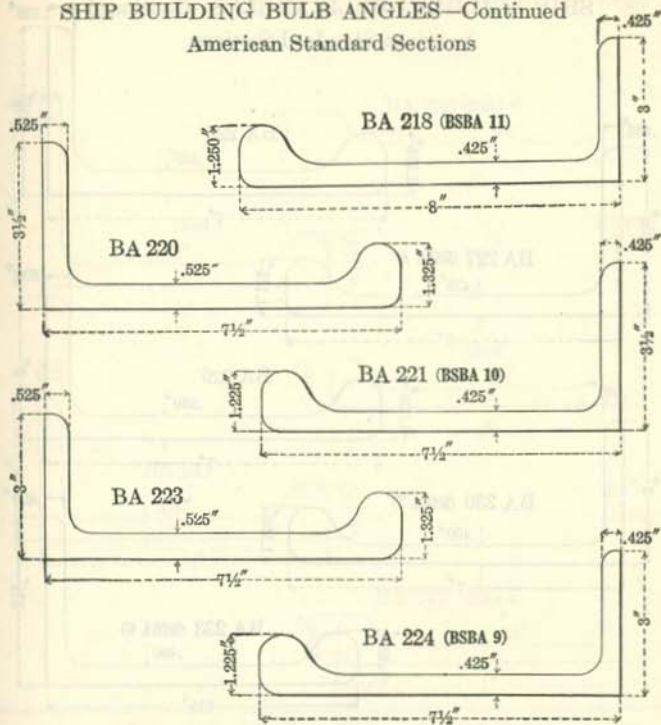
SHIP BUILDING BULB ANGLES—Continued
American Standard Sections

Section Index	Depth, Inches		Flange Width, Inches		Web Thickness, Inches		Weight per Foot, Pounds
	Decimal	Fractional	Decimal	Fractional	Decimal	Fractional	
BA 218 (BSBA 11)	8.000	8	3.000	3	0.475	$\frac{15}{32}$	19.6
					0.425	$\frac{27}{64}$	18.0
BA 220	7.500	$7\frac{1}{2}$	3.500	$3\frac{1}{2}$	0.575	$\frac{23}{64}$	22.8
					0.525	$\frac{17}{32}$	21.2
BA 221 (BSBA 10)	7.500	$7\frac{1}{2}$	3.500	$3\frac{1}{2}$	0.475	$\frac{15}{32}$	19.4
					0.425	$\frac{27}{64}$	17.8
BA 223	7.500	$7\frac{1}{2}$	3.000	3	0.525	$\frac{17}{32}$	20.3
					0.475	$\frac{15}{32}$	18.8
BA 224 (BSBA 9)	7.500	$7\frac{1}{2}$	3.000	3	0.425	$\frac{27}{64}$	17.1
					0.375	$\frac{3}{8}$	15.6

Dimensions of British Standard Sections are indicated in bold type.

CARNEGIE STEEL COMPANY

SHIP BUILDING BULB ANGLES—Continued
American Standard Sections

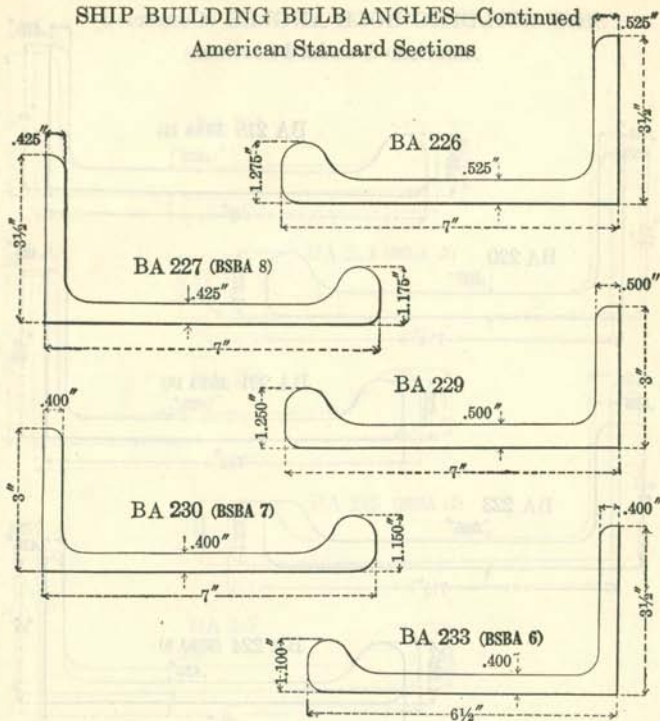

Section Index	Depth, Inches		Flange Width, Inches		Web Thickness, Inches		Weight per Foot, Pounds
	Decimal	Fractional	Decimal	Fractional	Decimal	Fractional	
BA 226	7.000	7	3.500	3½	0.525	17/32	20.0
					0.475	15/32	18.6
BA 227 (BSBA 8)	7.000	7	3.500	3½	0.425	27/64	16.8
					0.375	3/8	15.3
BA 229	7.000	7	3.000	3	0.500	½	18.4
					0.450	29/64	16.9
BA 230 (BSBA 7)	7.000	7	3.000	3	0.400	13/32	15.3
					0.350	11/32	13.9
BA 233 (BSBA 6)	6.500	6½	3.500	3½	0.400	13/32	15.0
					0.350	11/32	13.6

Dimensions of British Standard Sections are indicated in bold type.

BULB ANGLES

SHIP BUILDING BULB ANGLES—Continued
American Standard Sections

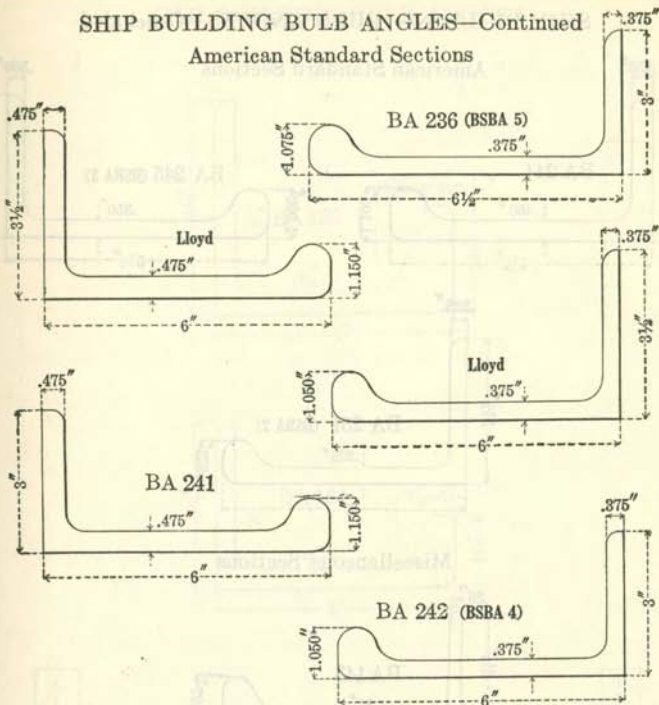

Section Index	Depth, Inches		Flange Width, Inches		Web Thickness, Inches		Weight per Foot, Pounds
	Decimal	Fractional	Decimal	Fractional	Decimal	Fractional	
BA 236 (BSBA 5)	6.500	6½	3.000	3	0.425	27/64	15.0
					0.375	3/8	13.6
					0.350	11/32	12.9
† Lloyd	6.000	6	3.500	3½	0.475	15/32	16.4
					0.425	27/64	14.8
† Lloyd	6.000	6	3.500	3½	0.375	3/8	13.4
					0.350	11/32	12.8
BA 241	6.000	6	3.000	3	0.525	17/32	16.8
					0.475	15/32	15.6
BA 242 (BSBA 4)	6.000	6	3.000	3	0.425	27/64	14.1
					0.375	3/8	12.8
					0.350	11/32	12.2

†Rolled by Penney Iron Works (60A).

Dimensions of British Standard Sections are indicated in **bold type**.

CARNEGIE STEEL COMPANY

SHIP BUILDING BULB ANGLES—Concluded

American Standard Sections

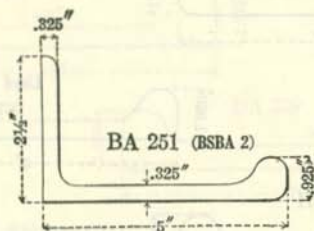
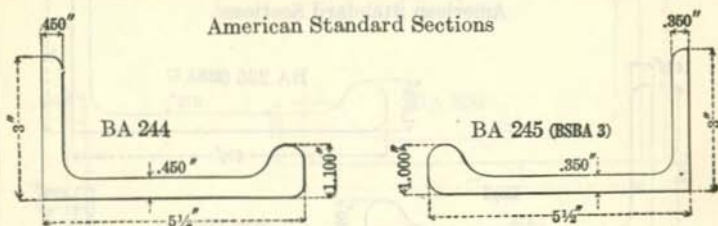

Miscellaneous Sections

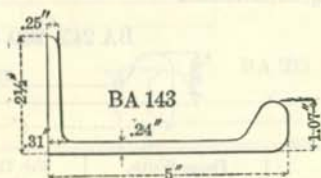

Section Index	Depth, Inches		Flange Width, Inches		Web Thickness, Inches		Weight per Foot, Pounds
	Decimal	Fractional	Decimal	Fractional	Decimal	Fractional	
BA 244	5.500	5½	3.000	3	0.500	½	15.1
					0.450	29/64	13.9
BA 245 (BSBA 3)	5.500	5½	3.000	3	0.400	13/32	12.5
					0.350	11/32	11.3
					0.325	21/64	10.7
BA 251 (BSBA 2)	5.000	5	2.500	2½	0.375	3/8	10.4
					0.325	21/64	9.3
					0.300	19/64	8.8
*BA 143	5.000	5	2.500	2½	0.240	¼	8.3

*Furnished only by special arrangement.

Dimensions of British Standard Sections are indicated in **bold type**.

CAR BUILDING BULB ANGLES

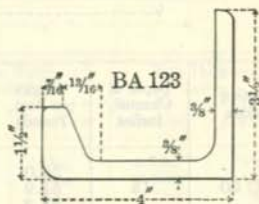
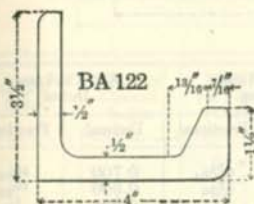
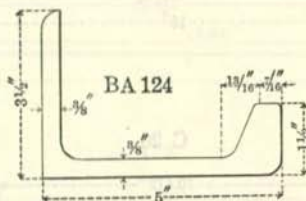
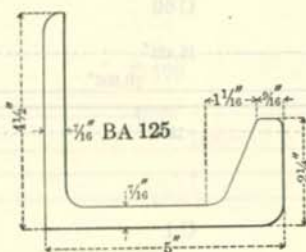

Section Index	Depth, Inches		Flange Width, Inches		Web Thickness, Inches		Weight per Foot, Pounds
	Decimal	Fractional	Decimal	Fractional	Decimal	Fractional	
BA 125	5.000	5	4.500	4 1/2	0.438	7/16	19.3
BA 124	5.000	5	3.500	3 1/2	0.375	3/8	13.2
BA 122	4.000	4	3.500	3 1/2	0.500	1/2	14.3
BA 123	4.000	4	3.500	3 1/2	0.375	3/8	11.9

STRUCTURAL CHANNELS

American Standard Sections

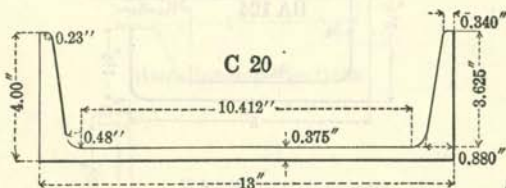
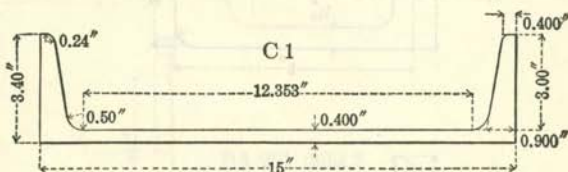
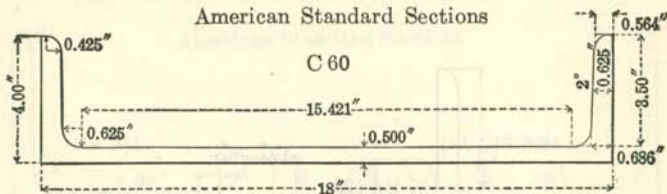

Section Index	Depth of Channel, Inches	Weight per Foot, Pounds	Flange Width, Inches		Web Thickness, Inches	
			Decimal	Fractional	Decimal	Fractional
†C 60	18	58.0	4.200	$4\frac{13}{64}$	0.700	$4\frac{5}{64}$
		51.9	4.100	$4\frac{3}{32}$	0.600	$1\frac{19}{32}$
		45.8	4.000	4	0.500	$\frac{1}{2}$
		42.7	3.950	$3\frac{61}{64}$	0.450	$2\frac{9}{64}$
C 1	15	55.0	3.814	$3\frac{19}{16}$	0.814	$1\frac{3}{16}$
		50.0	3.716	$3\frac{23}{32}$	0.716	$2\frac{23}{32}$
		45.0	3.618	$3\frac{5}{8}$	0.618	$\frac{5}{8}$
		40.0	3.520	$3\frac{33}{64}$	0.520	$3\frac{33}{64}$
		35.0	3.422	$3\frac{27}{64}$	0.422	$2\frac{27}{64}$
33.9	3.400	$3\frac{19}{32}$	0.400	$1\frac{19}{32}$		
†C 20	13	50.0	4.412	$4\frac{13}{32}$	0.787	$2\frac{5}{32}$
		45.0	4.298	$4\frac{15}{64}$	0.673	$4\frac{5}{64}$
		40.0	4.185	$4\frac{7}{16}$	0.560	$9\frac{1}{16}$
		37.0	4.117	$4\frac{7}{64}$	0.492	$3\frac{1}{64}$
		35.0	4.072	$4\frac{5}{64}$	0.447	$2\frac{9}{64}$
31.8	4.000	4	0.375	$\frac{3}{8}$		

†C 60 is a Ship Building Channel (not an American Standard.) †C 20 is a Car Building Channel.

STRUCTURAL CHANNELS—Continued
American Standard Sections

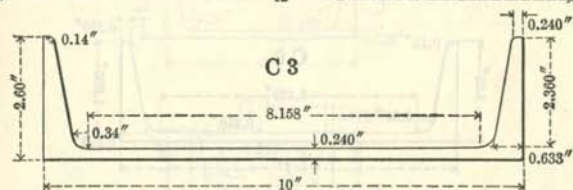
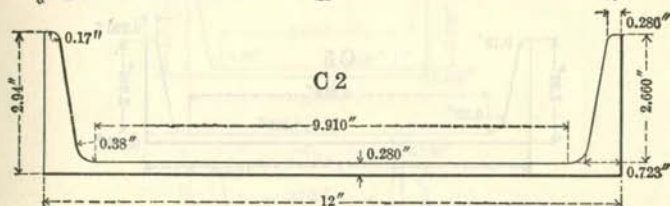
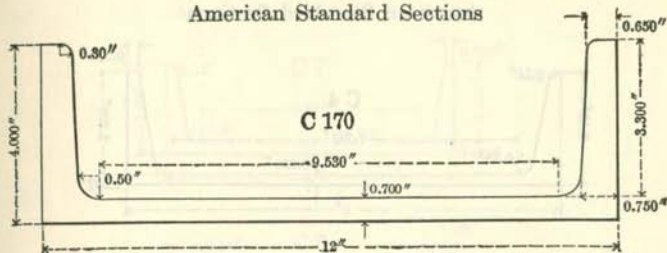

Section Index	Depth of Channel, Inches	Weight per Foot, Pounds	Flange Width, Inches		Web Thickness, Inches	
			Decimal	Fractional	Decimal	Fractional
†C 170	12	50.0	4.135	4 ⁹ / ₆₄	0.835	5 ⁸ / ₆₄
		48.6	4.100	4 ⁵ / ₃₂	0.800	5 ¹ / ₆₄
		46.6	4.050	4 ⁵ / ₆₄	0.750	3 ¹ / ₄
		44.5	4.000	4	0.700	4 ⁵ / ₆₄
		40.0	3.890	3 ⁵⁷ / ₆₄	0.590	1 ¹⁵ / ₃₂
		35.0	3.767	3 ⁴ / ₆₄	0.467	1 ⁵ / ₃₂
C 2	12	40.0	3.415	3 ²⁷ / ₆₄	0.755	3 ¹ / ₄
		35.0	3.292	3 ¹⁹ / ₆₄	0.632	5 ⁵ / ₁₆
		30.0	3.170	3 ¹¹ / ₆₄	0.510	3 ⁵ / ₆₄
		25.0	3.047	3 ³ / ₆₄	0.387	2 ⁵ / ₆₄
		20.7	2.940	2 ¹⁵ / ₁₆	0.280	9 ⁷ / ₃₂
C 3	10	35.0	3.180	3 ³ / ₁₆	0.820	1 ¹³ / ₁₆
		30.0	3.033	3 ¹ / ₃₂	0.673	4 ³ / ₆₄
		25.0	2.886	2 ⁵⁷ / ₆₄	0.526	1 ¹⁷ / ₃₂
		20.0	2.739	2 ⁴⁷ / ₆₄	0.379	5 ⁷ / ₈
		15.3	2.600	2 ¹ / ₃₂	0.240	1 ⁷ / ₆₄

†C 170 is a Car Building Channel (not an American Standard.)

STRUCTURAL CHANNELS—Continued
American Standard Sections

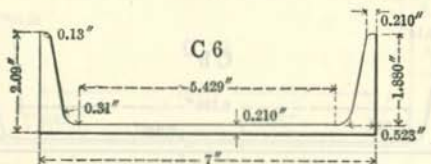
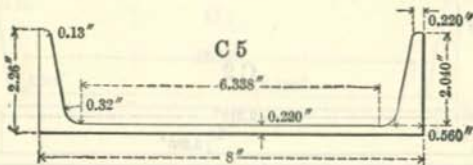
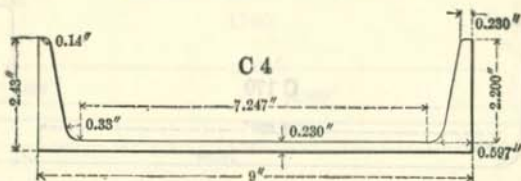

Section Index	Depth of Channel, Inches	Weight per Foot, Pounds	Flange Width, Inches		Web Thickness, Inches	
			Decimal	Fractional	Decimal	Fractional
C 4	9	25.0	2.812	$2\frac{13}{16}$	0.612	$\frac{39}{64}$
		20.0	2.648	$2\frac{41}{64}$	0.448	$\frac{29}{64}$
		15.0	2.485	$2\frac{31}{64}$	0.285	$\frac{9}{32}$
		13.4	2.430	$2\frac{7}{16}$	0.230	$\frac{15}{64}$
C 5	8	21.25	2.619	$2\frac{5}{8}$	0.579	$\frac{37}{64}$
		18.75	2.527	$2\frac{17}{32}$	0.487	$\frac{31}{64}$
		16.25	2.435	$2\frac{7}{16}$	0.395	$\frac{25}{64}$
		13.75	2.343	$2\frac{13}{32}$	0.303	$\frac{19}{64}$
		11.5	2.260	$2\frac{17}{64}$	0.220	$\frac{7}{32}$
C 6	7	19.75	2.509	$2\frac{25}{64}$	0.629	$\frac{5}{8}$
		17.25	2.404	$2\frac{13}{32}$	0.524	$\frac{17}{32}$
		14.75	2.299	$2\frac{19}{64}$	0.419	$\frac{27}{64}$
		12.25	2.194	$2\frac{3}{16}$	0.314	$\frac{5}{16}$
		9.8	2.090	$2\frac{3}{32}$	0.210	$\frac{13}{64}$

STRUCTURAL CHANNELS—Concluded
American Standard Sections

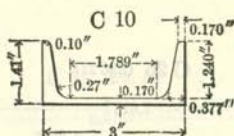
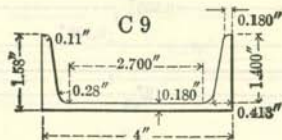
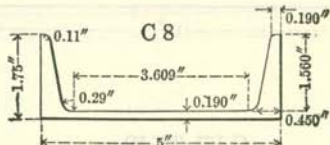
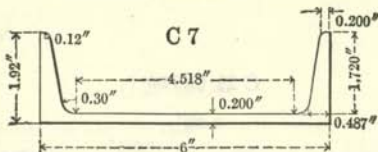

Section Index	Depth of Channel, Inches	Weight per Foot, Pounds	Flange Width, Inches		Web Thickness, Inches	
			Decimal	Fractional	Decimal	Fractional
C 7	6	15.5	2.279	$2\frac{9}{32}$	0.559	$\frac{9}{16}$
		13.0	2.157	$2\frac{5}{32}$	0.437	$\frac{7}{16}$
		10.5	2.034	$2\frac{1}{32}$	0.314	$\frac{5}{16}$
		8.2	1.920	$1\frac{59}{64}$	0.200	$1\frac{3}{64}$
C 8	5	11.5	2.032	$2\frac{1}{32}$	0.472	$1\frac{5}{32}$
		9.0	1.885	$1\frac{67}{64}$	0.325	$2\frac{1}{64}$
		6.7	1.750	$1\frac{3}{4}$	0.190	$\frac{3}{16}$
C 9	4	7.25	1.720	$1\frac{23}{32}$	0.320	$\frac{5}{16}$
		6.25	1.647	$1\frac{41}{64}$	0.247	$\frac{1}{4}$
		5.4	1.580	$1\frac{37}{64}$	0.180	$\frac{3}{16}$
C 10 (Old No. C 72)	3	6.0	1.596	$1\frac{19}{32}$	0.356	$2\frac{3}{64}$
		5.0	1.498	$1\frac{1}{2}$	0.258	$\frac{1}{4}$
		4.1	1.410	$1\frac{13}{32}$	0.170	$1\frac{1}{64}$

CARNEGIE STEEL COMPANY

SHIP BUILDING CHANNELS
American Standard Sections

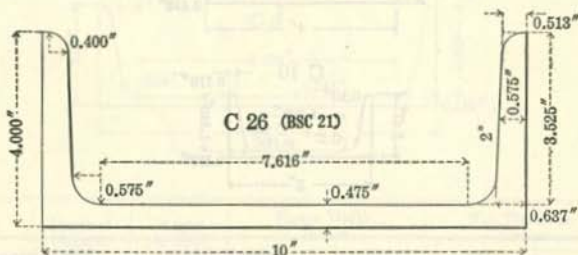
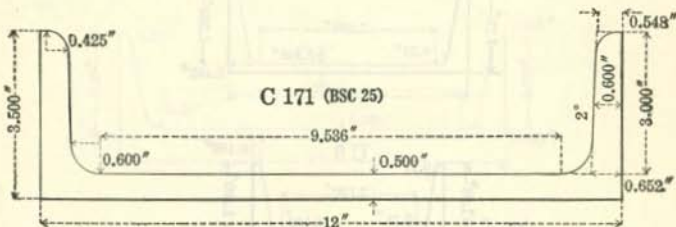
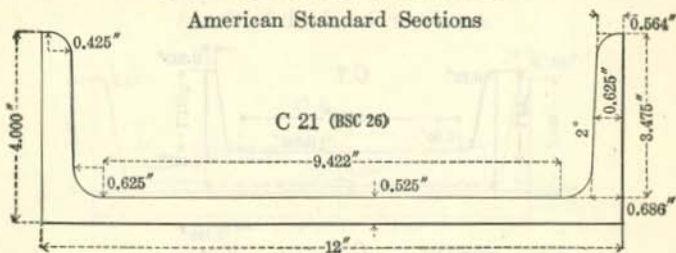

Section Index	Depth of Channel, Inches	Weight per Foot, Pounds	Flange Width, Inches		Web Thickness, Inches	
			Decimal	Fractional	Decimal	Fractional
C 21 (BSC 26)	12	44.7	4.200	$4\frac{1}{4}$	0.725	$\frac{29}{32}$
		40.6	4.100	$4\frac{9}{32}$	0.625	$\frac{5}{8}$
		36.5	4.000	4	0.525	$1\frac{17}{32}$
		34.5	3.950	$3\frac{1}{16}$	0.475	$1\frac{15}{32}$
C 171 (BSC 25)	12	41.1	3.700	$3\frac{5}{16}$	0.700	$4\frac{5}{16}$
		37.0	3.600	$3\frac{19}{32}$	0.600	$1\frac{19}{32}$
		32.9	3.500	$3\frac{1}{2}$	0.500	$\frac{1}{2}$
		30.9	3.450	$3\frac{29}{64}$	0.450	$2\frac{9}{64}$
C 26 (BSC 21)	10	37.0	4.200	$4\frac{1}{8}$	0.675	$4\frac{9}{16}$
		33.6	4.100	$4\frac{9}{32}$	0.575	$4\frac{11}{16}$
		30.2	4.000	4	0.475	$1\frac{15}{32}$
		28.5	3.950	$3\frac{1}{16}$	0.425	$2\frac{7}{16}$

Dimensions and properties of the British Standard Sections are indicated in bold type.

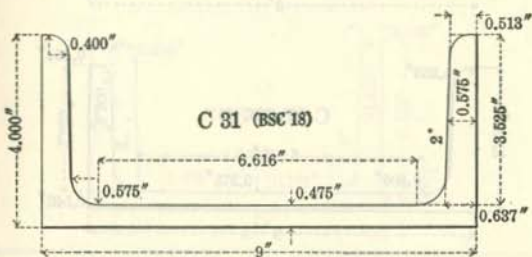
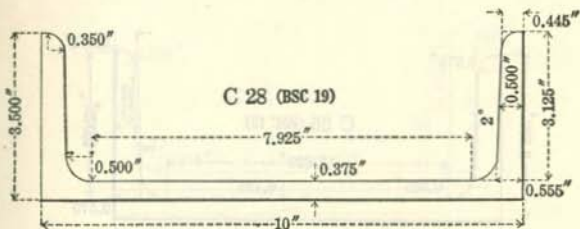
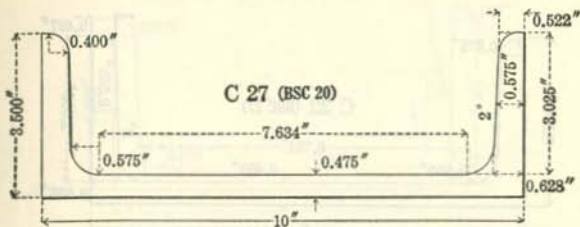
SHIP BUILDING CHANNELS—Continued
 American Standard Sections

Section Index	Depth of Channel, Inches	Weight per Foot, Pounds	Flange Width, Inches		Web Thickness, Inches	
			Decimal	Fractional	Decimal	Fractional
C 27 (BSC 20)	10	35.1	3.700	$3\frac{5}{16}$	0.675	$\frac{43}{64}$
		31.7	3.600	$3\frac{19}{32}$	0.575	$\frac{37}{64}$
		28.3	3.500	$3\frac{1}{2}$	0.475	$\frac{15}{32}$
		26.6	3.450	$3\frac{29}{64}$	0.425	$\frac{27}{64}$
		24.9	3.400	$3\frac{13}{32}$	0.375	$\frac{3}{8}$
C 28 (BSC 19)	10	25.3	3.550	$3\frac{5}{16}$	0.425	$\frac{27}{64}$
		23.6	3.500	$3\frac{1}{2}$	0.375	$\frac{3}{8}$
		21.9	3.450	$3\frac{29}{64}$	0.325	$\frac{21}{64}$
C 31 (BSC 18)	9	34.7	4.200	$4\frac{13}{16}$	0.675	$\frac{43}{64}$
		31.7	4.100	$4\frac{9}{32}$	0.575	$\frac{37}{64}$
		28.6	4.000	4	0.475	$\frac{15}{32}$
		27.1	3.950	$3\frac{61}{64}$	0.425	$\frac{27}{64}$

Dimensions and properties of the British Standard Sections are indicated in bold type.

SHIP BUILDING CHANNELS—Continued
American Standard Sections

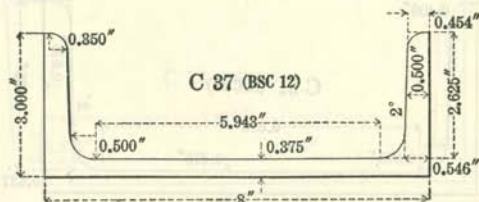
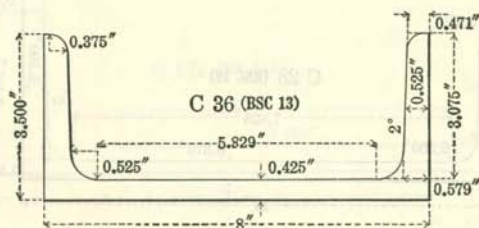
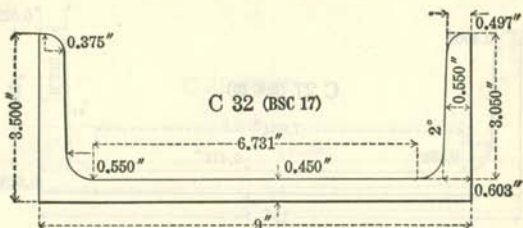

Section Index	Depth of Channel, Inches	Weight per Foot, Pounds	Flange Width, Inches		Web Thickness, Inches	
			Decimal	Fractional	Decimal	Fractional
C 32 (BSC 17)	9	31.6	3.700	$3\frac{45}{64}$	0.650	$2\frac{1}{32}$
		28.5	3.600	$3\frac{19}{32}$	0.550	$3\frac{5}{64}$
		25.4	3.500	$3\frac{1}{2}$	0.450	$2\frac{9}{64}$
		23.9	3.450	$3\frac{29}{64}$	0.400	$1\frac{13}{32}$
C 36 (BSC 13)	8	28.2	3.700	$3\frac{45}{64}$	0.625	$5/8$
		25.5	3.600	$3\frac{19}{32}$	0.525	$1\frac{7}{32}$
		22.8	3.500	$3\frac{1}{2}$	0.425	$2\frac{7}{64}$
		21.4	3.450	$3\frac{29}{64}$	0.375	$3/8$
C 37 (BSC 12)	8	25.5	3.225	$3\frac{7}{32}$	0.600	$1\frac{9}{32}$
		22.7	3.125	$3\frac{1}{8}$	0.500	$1/2$
		20.0	3.025	$3\frac{1}{8}$	0.400	$1\frac{15}{32}$
		19.3	3.000	3	0.375	$3/8$
		18.7	2.975	$2\frac{31}{32}$	0.350	$1\frac{11}{32}$

Dimensions and properties of the British Standard Sections are indicated in bold type.

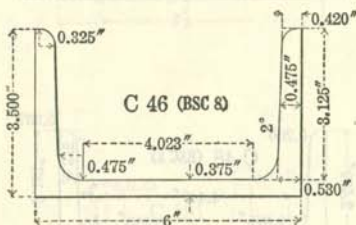
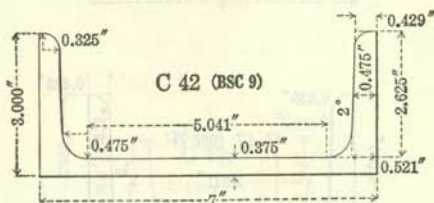
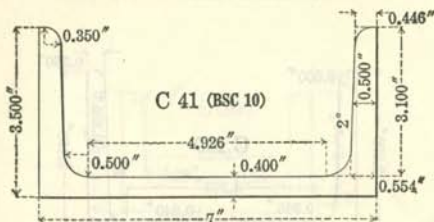
SHIP BUILDING CHANNELS—Continued
American Standard Sections

Section Index	Depth of Channel, Inches	Weight per Foot, Pounds	Flange Width, Inches		Web Thickness, Inches	
			Decimal	Fractional	Decimal	Fractional
C 41 (BSC 10)	7	25.0	3.700	$3\frac{5}{64}$	0.600	$1\frac{9}{32}$
		22.7	3.600	$3\frac{19}{32}$	0.500	$1\frac{1}{2}$
		20.3	3.500	$3\frac{1}{2}$	0.400	$1\frac{13}{32}$
		19.1	3.450	$3\frac{29}{64}$	0.350	$1\frac{11}{32}$
C 42 (BSC 9)	7	20.0	3.100	$3\frac{3}{8}$	0.475	$1\frac{5}{32}$
		17.6	3.000	3	0.375	$\frac{3}{8}$
		16.4	2.950	$2\frac{91}{64}$	0.325	$2\frac{1}{64}$
C 46 (BSC 8)	6	22.0	3.700	$3\frac{5}{64}$	0.575	$2\frac{37}{64}$
		20.0	3.600	$3\frac{19}{32}$	0.475	$1\frac{15}{32}$
		18.0	3.500	$3\frac{1}{2}$	0.375	$\frac{3}{8}$
		16.9	3.450	$3\frac{29}{64}$	0.325	$2\frac{1}{64}$

Dimensions and properties of the British Standard Sections are indicated in bold type.

SHIP BUILDING CHANNELS—Concluded
American Standard Sections

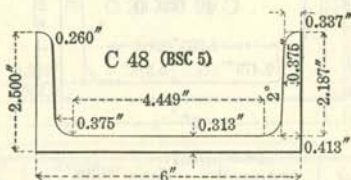
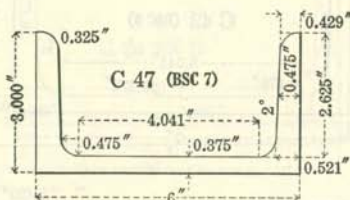
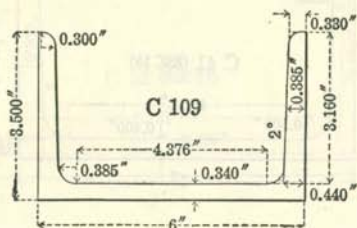

Section Index	Depth of Channel, Inches	Weight per Foot, Pounds	Flange Width, Inches		Web Thickness, Inches	
			Decimal	Fractional	Decimal	Fractional
C 109	6	15.3	3.500	3½	0.340	1½/32
C 47	6	16.3	3.000	3	0.375	3/8
(BSC 7)		15.1	2.938	2½ 5/16	0.313	5/16
C 48	6	13.3	2.563	2 9/16	0.375	3/8
(BSC 5)		12.0	2.500	2½	0.313	5/16

Dimensions and properties of the British Standard Sections are indicated in bold type.

CHANNELS

MISCELLANEOUS CAR BUILDING CHANNELS

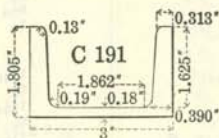
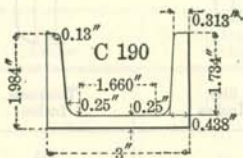
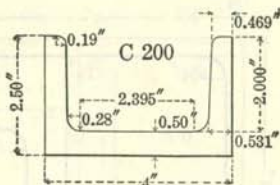

Section Index	Depth of Channel, Inches	Weight per Foot, Pounds	Flange Width, Inches		Web Thickness, Inches	
			Decimal	Fractional	Decimal	Fractional
*C 200	4	13.8	2.500	2½	0.500	½
*C 190	3	7.1	1.984	1¾	0.250	¼
*C 191	3	6.5 5.8	1.875 1.805	1¾ 1⅞	0.250 0.180	¼ ⅜

*Furnished only by special arrangement.

CARNEGIE STEEL COMPANY

EQUAL ANGLES

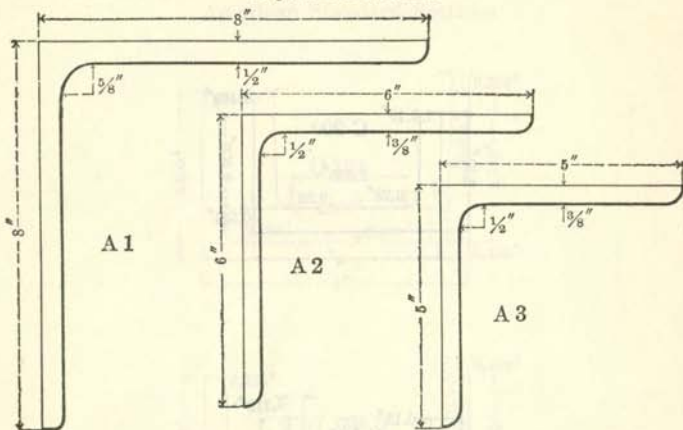

Section Index	Size, Inches	Thickness, Inches	Weight per Foot, Pounds
A 1	8 x 8	1 1/8	56.9
		1 1/16	54.0
		1	51.0
		15/16	48.1
		7/8	45.0
		13/16	42.0
		3/4	38.9
		11/16	35.8
		5/8	32.7
A 2	6 x 6	9/16	29.6
		1/2	26.4
		1	37.4
		15/16	35.3
		7/8	33.1
		13/16	31.0
		3/4	28.7
		11/16	26.5
		5/8	24.2
A 3	5 x 5	9/16	21.9
		1/2	19.6
		7/16	17.2
		3/8	14.9
		*1	30.6
		* 15/16	28.9
		* 7/8	27.2
		* 13/16	25.4
		* 3/4	23.6
* 11/16	21.8		
* 5/8	20.0		
* 9/16	18.1		
* 1/2	16.2		
* 7/16	14.3		
* 3/8	12.3		

*Special, see page 4.

EQUAL ANGLES—Continued

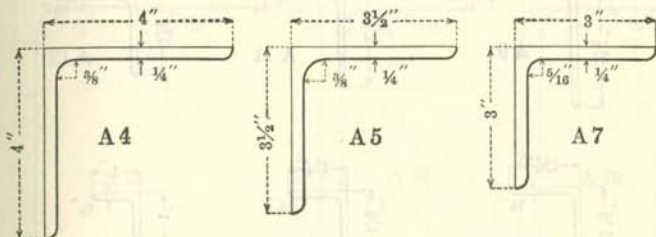

Section Index	Size, Inches	Thickness, Inches	Weight per Foot, Pounds
		*13/16	19.9
		3/4	18.5
		11/16	17.1
		5/8	15.7
A 4	4 x 4	9/16	14.3
		1/2	12.8
		7/16	11.3
		3/8	9.8
		5/16	8.2
		* 1/4	6.6
		*13/16	17.1
		* 3/4	16.0
		*11/16	14.8
		5/8	13.6
A 5	3 1/2 x 3 1/2	9/16	12.4
		1/2	11.1
		7/16	9.8
		3/8	8.5
		5/16	7.2
		* 1/4	5.8
		* 5/8	11.5
		* 9/16	10.4
		1/2	9.4
A 7	3 x 3	7/16	8.3
		3/8	7.2
		5/16	6.1
		1/4	4.9

*Special, see page 4.

CARNEGIE STEEL COMPANY

EQUAL ANGLES—Concluded

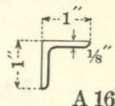
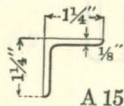
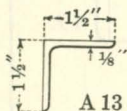
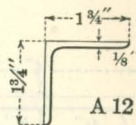
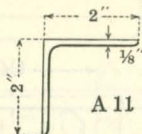
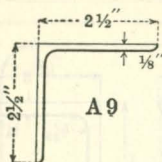

Section Index	Size, Inches	Thickness, Inches	Weight per Foot, Pounds
A 9	2 1/2 x 2 1/2	* 1/2	7.7
		7/16	6.8
		3/8	5.9
		5/16	5.0
		1/4	4.1
		3/16	3.07
A 11	2 x 2	* 1/8	2.08
		* 7/16	5.3
		3/8	4.7
		5/16	3.92
		1/4	3.19
		3/16	2.44
A 12	1 3/4 x 1 3/4	* 1/8	1.65
		* 7/16	4.6
		* 3/8	3.99
		* 5/16	3.39
		* 1/4	2.77
		* 3/16	2.12
A 13	1 1/2 x 1 1/2	* 1/8	1.44
		* 3/8	3.35
		5/16	2.86
		1/4	2.34
		3/16	1.80
		1/8	1.23
A 15	1 1/4 x 1 1/4	* 5/16	2.33
		* 1/4	1.92
		* 3/16	1.48
		* 1/8	1.01
A 16	1 x 1	* 1/4	1.49
		* 3/16	1.16
		* 1/8	0.80

*Special, see page 4.

UNEQUAL ANGLES

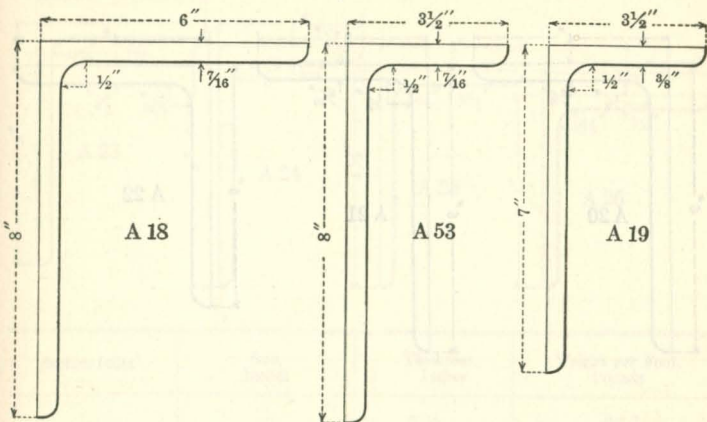

Section Index	Size, Inches	Thickness, Inches	Weight per Foot, Pounds
A 18	8 x 6	*1	44.2
		* 15/16	41.7
		* 7/8	39.1
		* 13/16	36.5
		* 3/4	33.8
		* 11/16	31.2
		* 5/8	28.5
		* 9/16	25.7
A 53	8 x 3 1/2	* 1/2	23.0
		* 7/16	20.2
		*1	35.7
		* 15/16	33.7
		* 7/8	31.7
		* 13/16	29.6
		* 3/4	27.5
		* 11/16	25.3
A 19	7 x 3 1/2	* 5/8	23.2
		* 9/16	21.0
		* 1/2	18.7
		* 7/16	16.5
		*1	32.3
		* 15/16	30.5
		* 7/8	28.7
		* 13/16	26.8
* 3/4	24.9		
* 11/16	23.0		
* 5/8	21.0		
* 9/16	19.1		
* 1/2	17.0		
* 7/16	15.0		
* 3/8	13.0		

*Special, see page 4.

CARNEGIE STEEL COMPANY

UNEQUAL ANGLES—Continued

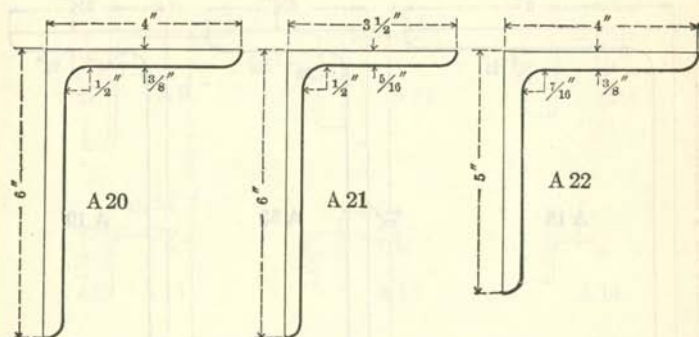

Section Index	Size, Inches	Thickness, Inches	Weight per Foot, Pounds
A 20	6 x 4	*1	30.6
		* 15/16	28.9
		7/8	27.2
		13/16	25.4
		3/4	23.6
		11/16	21.8
		5/8	20.0
		9/16	18.1
		1/2	16.2
A 21	6 x 3 1/2	7/16	14.3
		3/8	12.3
		*1	28.9
		* 15/16	27.3
		7/8	25.7
		13/16	24.0
		3/4	22.4
		11/16	20.6
		5/8	18.9
A 22	5 x 4	9/16	17.1
		1/2	15.3
		7/16	13.5
		3/8	11.7
		* 5/16	9.8
		* 7/8	24.2
		* 13/16	22.7
		* 3/4	21.1
		* 11/16	19.5
* 5/8	17.8		
* 9/16	16.2		
* 1/2	14.5		
* 7/16	12.8		
* 3/8	11.0		

* Special, see page 4.

UNEQUAL ANGLES—Continued

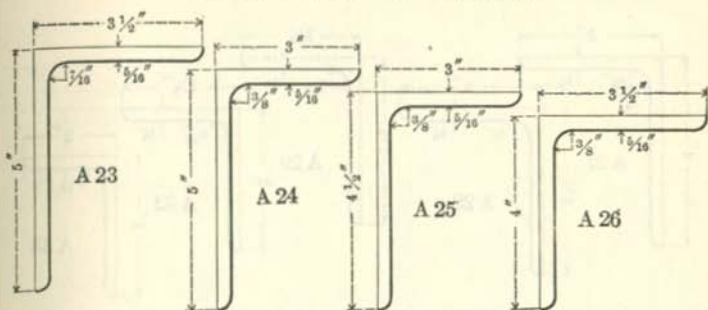

Section Index	Size, Inches	Thickness, Inches	Weight per Foot, Pounds
A 23	5 x 3 1/2	* 7/8	22.7
		* 13/16	21.3
		* 3/4	19.8
		* 11/16	18.3
		* 5/8	16.8
		* 9/16	15.2
		* 1/2	13.6
		* 7/16	12.0
		* 3/8	10.4
		* 5/16	8.7
A 24	5 x 3	* 13/16	19.9
		* 3/4	18.5
		* 11/16	17.1
		* 5/8	15.7
		* 9/16	14.3
		* 1/2	12.8
		* 7/16	11.3
		* 3/8	9.8
A 25	4 1/2 x 3	* 13/16	18.5
		* 3/4	17.3
		* 11/16	16.0
		* 5/8	14.7
		* 9/16	13.3
		* 1/2	11.9
		* 7/16	10.6
		* 3/8	9.1
* 5/16	7.7		
A 26	4 x 3 1/2	* 13/16	18.5
		* 3/4	17.3
		* 11/16	16.0
		* 5/8	14.7
		* 9/16	13.3
		* 1/2	11.9
* 7/16	10.6		
* 3/8	9.1		
* 5/16	7.7		

* Special, see page 4.

CARNEGIE STEEL COMPANY

UNEQUAL ANGLES—Continued

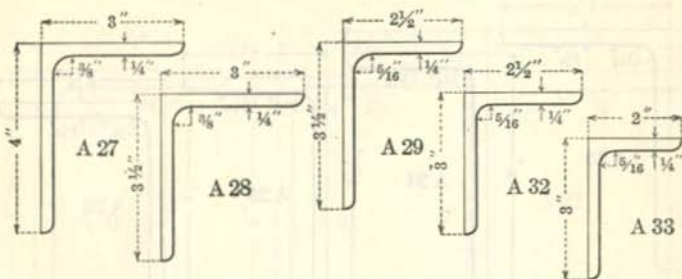

Section Index	Size, Inches	Thickness, Inches	Weight per Foot, Pounds
A 27	4 x 3	*13/16	17.1
		* 5/8	16.0
		*11/16	14.8
		5/8	13.6
		9/16	12.4
		1/2	11.1
		7/16	9.8
		3/8	8.5
		5/16	7.2
		* 1/4	5.8
A 28	3 1/2 x 3	*13/16	15.8
		* 5/8	14.7
		*11/16	13.6
		* 5/8	12.5
		9/16	11.4
		1/2	10.2
		7/16	9.1
		3/8	7.9
		5/16	6.6
		* 1/4	5.4
A 29	3 1/2 x 2 1/2	*11/16	12.5
		* 7/16	11.5
		* 5/8	10.4
		9/16	9.4
		1/2	8.3
		7/16	7.2
		3/8	6.1
5/16	4.9		
A 32	3 x 2 1/2	* 9/16	9.5
		* 1/2	8.5
		7/16	7.6
		3/8	6.6
		5/16	5.6
		1/4	4.5
A 33	3 x 2	* 1/2	7.7
		* 7/16	6.8
		* 3/8	5.9
		* 5/16	5.0
		* 1/4	4.1

*Special, see page 4.

UNEQUAL ANGLES—Concluded

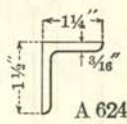
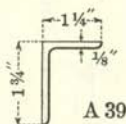
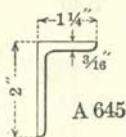
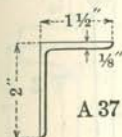
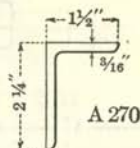
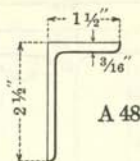
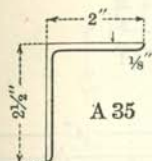

Section Index	Size, Inches	Thickness, Inches	Weight per Foot, Pounds
A 35	2 1/2 x 2	* 1/2	6.8
		* 7/16	6.1
		3/8	5.3
		* 5/16	4.5
		1/4	3.62
		* 3/16	2.75
A 48	2 1/2 x 1 1/2	* 1/8	1.86
		* 5/16	3.92
		* 1/4	3.19
A 270	2 1/4 x 1 1/2	* 3/16	2.44
		* 1/2	5.6
		* 7/16	5.0
		3/8	4.4
		* 5/16	3.66
		* 1/4	2.98
A 37	2 x 1 1/2	* 3/16	2.28
		* 3/8	3.99
		* 5/16	3.39
		* 1/4	2.77
		* 3/16	2.12
A 645	2 x 1 1/4	* 1/8	1.44
		* 1/4	2.55
		* 3/16	1.96
A 39	1 3/4 x 1 1/4	* 1/4	2.34
		* 3/16	1.80
		* 1/8	1.23
A 624	1 1/2 x 1 1/4	* 5/16	2.59
		* 1/4	2.13
		* 3/16	1.64

*Special, see page 4.

CARNEGIE STEEL COMPANY

EQUAL TEES

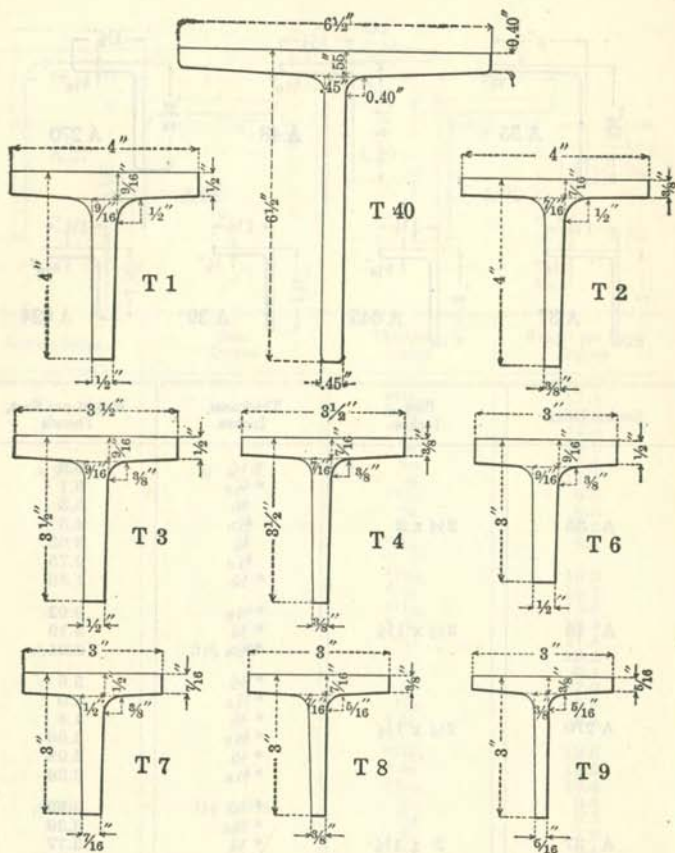

Section Index	Size, Inches		Thickness, Inches		Weight per Foot, Pounds
	Flange	Stem	Flange	Stem	
T 40	6 1/2	6 1/2	0.40 to 0.55	0.45	19.8
T 1	4	4	1/2 to 9/16	1/2 to 9/16	13.5
T 2	4	4	3/8 to 7/16	3/8 to 7/16	10.5
T 3	3 1/2	3 1/2	1/2 to 9/16	1/2 to 9/16	11.7
T 4	3 1/2	3 1/2	3/8 to 7/16	3/8 to 7/16	9.2
T 6	3	3	1/2 to 9/16	1/2 to 9/16	9.9
T 7	3	3	7/16 to 1/2	7/16 to 1/2	8.9
T 8	3	3	3/8 to 7/16	3/8 to 7/16	7.8
T 9	3	3	9/16 to 3/8	9/16 to 3/8	6.7

EQUAL TEES—Concluded

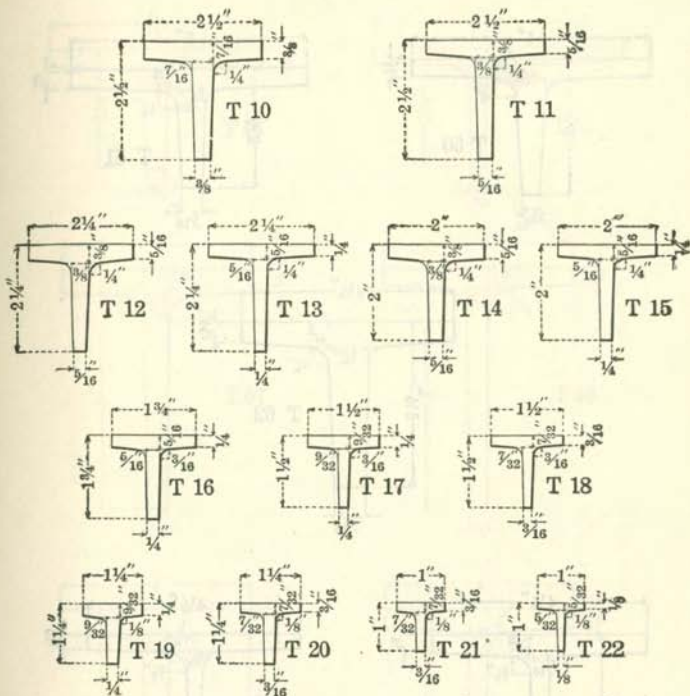

Section Index	Size, Inches		Thickness, Inches		Weight per Foot, Pounds
	Flange	Stem	Flange	Stem	
T 10	2½	2½	⅜ to ⅞	⅜ to ⅞	6.4
T 11	2½	2½	⅝ to ⅝	⅝ to ⅝	5.5
T 12	2¼	2¼	⅝ to ⅝	⅝ to ⅝	4.9
T 13	2¼	2¼	¼ to ⅝	¼ to ⅝	4.1
T 14	2	2	⅝ to ⅝	⅝ to ⅝	4.3
T 15	2	2	¼ to ⅝	¼ to ⅝	3.56
T 16	1¾	1¾	¼ to ⅝	¼ to ⅝	3.09
T 17	1½	1½	¼ to ⅝	¼ to ⅝	2.47
T 18	1½	1½	⅜ to ⅝	⅜ to ⅝	1.94
T 19	1¼	1¼	¼ to ⅝	¼ to ⅝	2.02
T 20	1¼	1¼	⅜ to ⅝	⅜ to ⅝	1.59
T 21	1	1	⅜ to ⅝	⅜ to ⅝	1.25
T 22	1	1	⅜ to ⅝	⅜ to ⅝	0.89

UNEQUAL TEES

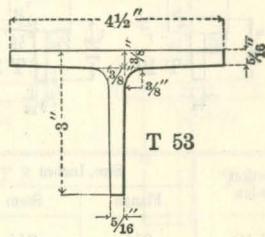
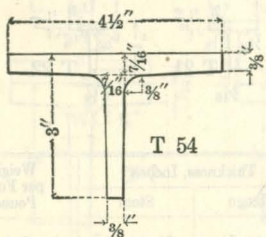
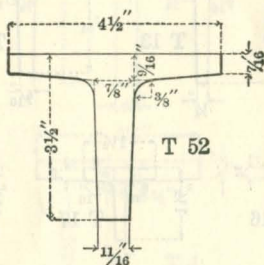
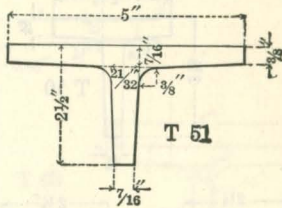
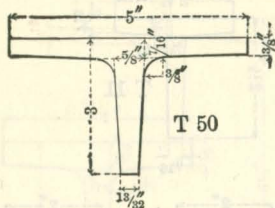

Section Index	Size, Inches		Thickness, Inches		Weight per Foot, Pounds
	Flange	Stem	Flange	Stem	
†T 50	5	3	3/8 to 7/16	1 3/32 to 5/8	11.5
†T 51	5	2 1/2	3/8 to 7/16	7/16 to 2 1/8	10.9
T 52	4 1/2	3 1/2	7/16 to 9/16	1 1/16 to 7/8	15.7
T 54	4 1/2	3	3/8 to 7/16	3/8 to 7/16	9.8
T 53	4 1/2	3	5/16 to 3/8	5/16 to 3/8	8.4

† T 50 can be rolled with flange 1/2" to 9/16", and stem 3 1/8"; weight 13.6 lbs. per foot.
 † T 51 can be rolled with flange 1/2" to 9/16", and stem 2 5/8"; weight 13.0 lbs. per foot.

UNEQUAL TEES—Continued

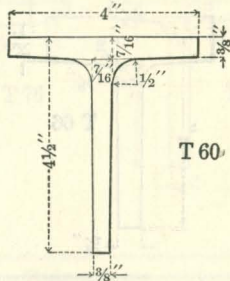
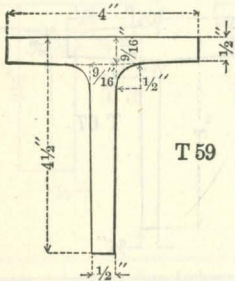
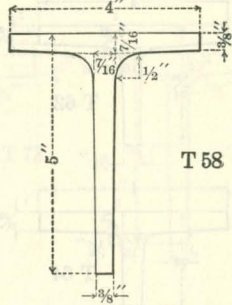
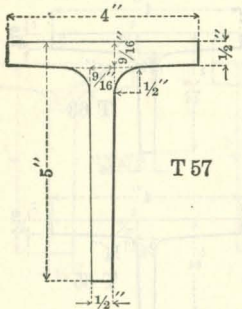
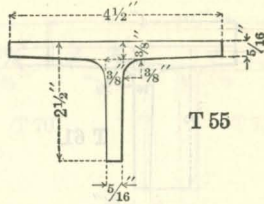
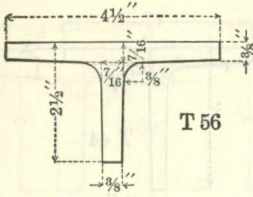

Section Index	Size, Inches		Thickness, Inches		Weight per Foot, Pounds
	Flange	Stem	Flange	Stem	
T 56	4 1/2	2 1/2	3/8 to 7/16	3/8 to 7/16	9.2
T 55	4 1/2	2 1/2	5/16 to 3/8	5/16 to 3/8	7.8
T 57	4	5	1/2 to 9/16	1/2 to 9/16	15.3
T 58	4	5	3/8 to 7/16	3/8 to 7/16	11.9
T 59	4	4 1/2	1/2 to 9/16	1/2 to 9/16	14.4
T 60	4	4 1/2	3/8 to 7/16	3/8 to 7/16	11.2

UNEQUAL TEES—Continued

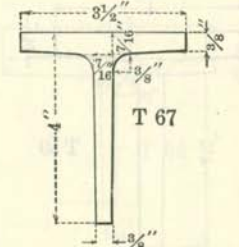
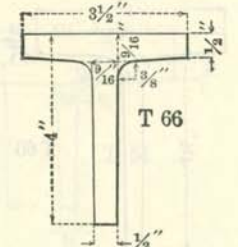
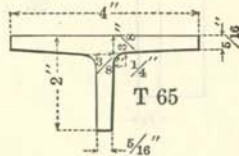
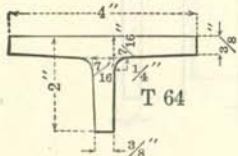
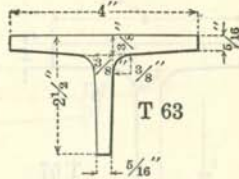
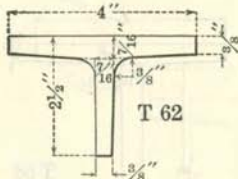
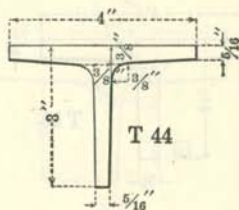
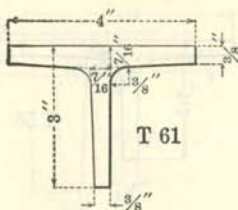

Section Index	Size, Inches		Thickness, Inches		Weight per Foot, Pounds
	Flange	Stem	Flange	Stem	
T 61	4	3	3/8 to 1/8	3/8 to 1/8	9.2
T 44	4	3	5/16 to 3/8	5/16 to 3/8	7.8
T 62	4	2 1/2	3/8 to 1/8	3/8 to 1/8	8.5
T 63	4	2 1/2	5/16 to 3/8	5/16 to 3/8	7.2
T 64	4	2	3/8 to 1/8	3/8 to 1/8	7.8
T 65	4	2	5/16 to 3/8	5/16 to 3/8	6.7
T 66	3 1/2	4	1/2 to 3/8	1/2 to 3/8	12.6
T 67	3 1/2	4	3/8 to 1/8	3/8 to 1/8	9.8

UNEQUAL TEES—Continued

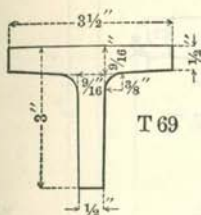

T 69

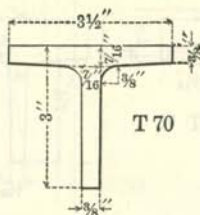

T 70

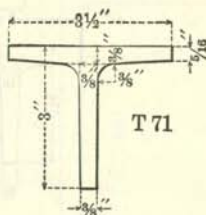

T 71

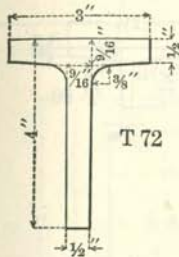

T 72

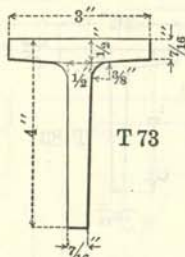

T 73

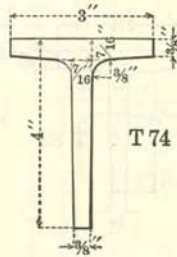

T 74

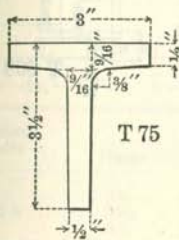

T 75

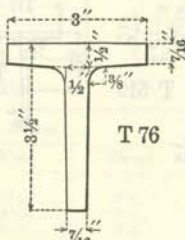

T 76

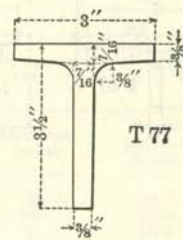

T 77

Section Index	Size, Inches		Thickness, Inches		Weight per Foot, Pounds
	Flange	Stem	Flange	Stem	
T 69	3 1/2	3	1/2 to 9/16	1/2 to 9/16	10.8
T 70	3 1/2	3	3/8 to 7/16	3/8 to 7/16	8.5
T 71	3 1/2	3	5/16 to 3/8	3/8	7.5
T 72	3	4	1/2 to 9/16	1/2 to 9/16	11.7
T 73	3	4	7/16 to 1/2	7/16 to 1/2	10.5
T 74	3	4	3/8 to 7/16	3/8 to 7/16	9.2
T 75	3	3 1/2	1/2 to 9/16	1/2 to 9/16	10.8
T 76	3	3 1/2	7/16 to 1/2	7/16 to 1/2	9.7
T 77	3	3 1/2	3/8 to 7/16	3/8 to 7/16	8.5

CARNEGIE STEEL COMPANY

UNEQUAL TEES—Concluded

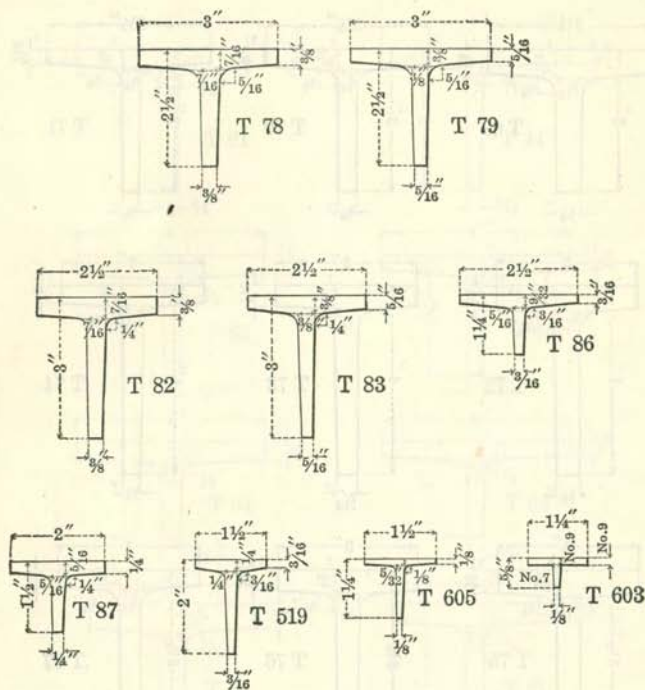

Section Index	Size, Inches		Thickness, Inches		Weight per Foot, Pounds
	Flange	Stem	Flange	Stem	
T 78	3	2½	¾ to ⅞	¾ to ⅞	7.1
T 79	3	2½	⅝ to ¾	⅝ to ¾	6.1
T 82	2½	3	¾ to ⅞	¾ to ⅞	7.1
T 83	2½	3	⅝ to ¾	⅝ to ¾	6.1
T 86	2½	1¼	⅝ to ⅝ ₂	⅝ to ⅝ ₁₆	2.87
T 87	2	1½	¼ to ⅝ ₁₆	¼ to ⅝ ₁₆	3.09
T 519	1½	2	⅝ ₁₆ to ¼	⅝ ₁₆ to ¼	2.45
T 605	1½	1¼	½ to ⅝ ₂	½ to ⅝ ₂	1.25
*T 603	1¼	¾	No. 9	½ to No. 7	0.88

* Furnished only by special arrangement.

ZEE'S

ZEE'S

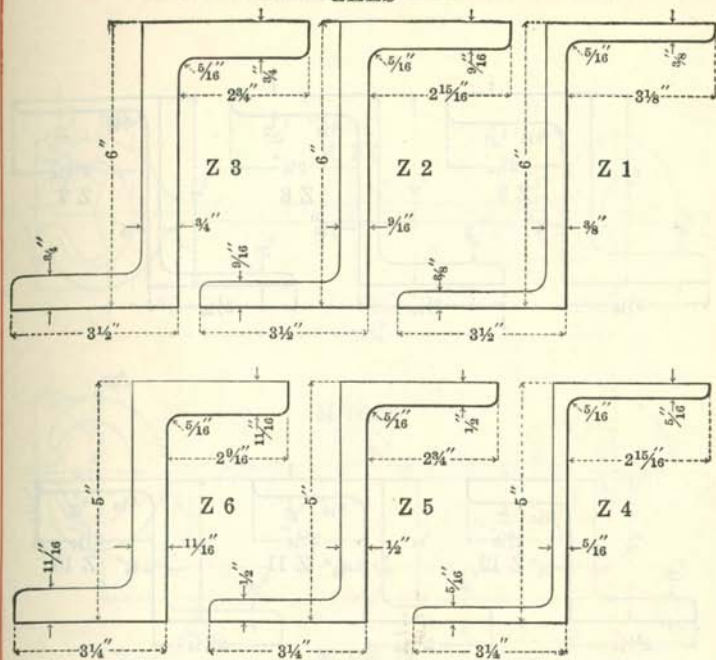

Section Index	Size, Inches			Thickness, Inches	Weight per Foot, Pounds
	Flange	Web	Flange		
Z 3	3 5/8	6 1/8	3 5/8	7/8	34.6
	3 9/16	6 1/16	3 9/16	1 3/16	32.0
	3 1/2	6	3 1/2	3/4	29.4
Z 2	3 5/8	6 1/8	3 5/8	1 1/16	28.1
	3 9/16	6 1/16	3 9/16	5/8	25.4
	3 1/2	6	3 1/2	9/16	22.8
Z 1	3 5/8	6 1/8	3 5/8	1/2	21.1
	3 9/16	6 1/16	3 9/16	7/16	18.4
	3 1/2	6	3 1/2	3/8	15.7
Z 6	3 3/8	5 1/8	3 3/8	1 3/16	28.4
	3 9/16	5 1/16	3 9/16	3/4	26.0
	3 1/4	5	3 1/4	1 1/16	23.7
Z 5	3 3/8	5 1/8	3 3/8	5/8	22.6
	3 9/16	5 1/16	3 9/16	9/16	20.2
	3 1/4	5	3 1/4	1/2	17.9
Z 4	3 3/8	5 1/8	3 3/8	7/16	16.4
	3 9/16	5 1/16	3 9/16	3/8	14.0
	3 1/4	5	3 1/4	9/16	11.6

CARNEGIE STEEL COMPANY

ZEES—Concluded

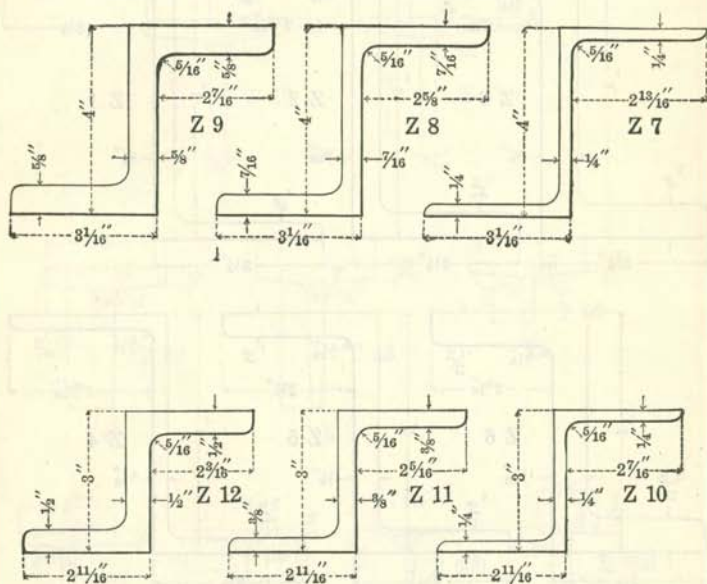

Section Index	Size, Inches			Thickness, Inches	Weight per Foot, Pounds
	Flange	Web	Flange		
Z 9	3 9/16	4 1/8	3 9/16	9/16	23.0
	3 1/8	4 1/16	3 1/8	1 1/16	20.9
	3 1/16	4	3 1/16	5/8	18.9
Z 8	3 3/16	4 1/8	3 3/16	9/16	18.0
	3 1/8	4 1/16	3 1/8	7/16	15.9
	3 1/16	4	3 1/16	7/16	13.8
Z 7	3 9/16	4 1/8	3 9/16	7/8	12.5
	3 1/8	4 1/16	3 1/8	5/16	10.3
	3 1/16	4	3 1/16	3/4	8.2
Z 12	2 3/4	3 1/16	2 3/4	9/16	14.3
	2 11/16	3	2 11/16	1/2	12.6
Z 11	2 3/4	3 1/16	2 3/4	7/16	11.5
	2 11/16	3	2 11/16	3/8	9.8
Z 10	2 3/4	3 1/16	2 3/4	5/16	8.5
	2 11/16	3	2 11/16	1/4	6.7

STEEL SHEET PILING

UNITED STATES STEEL SHEET PILING

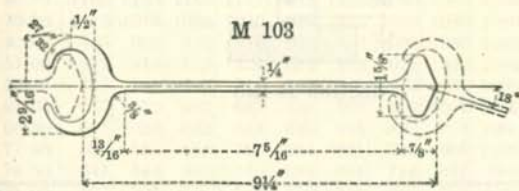
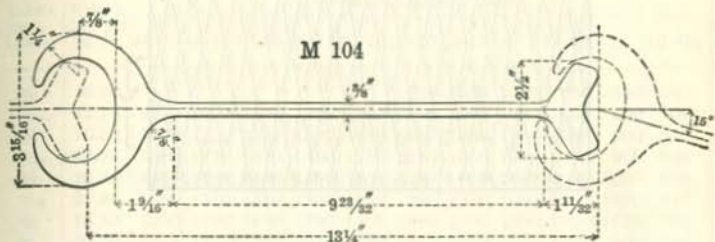
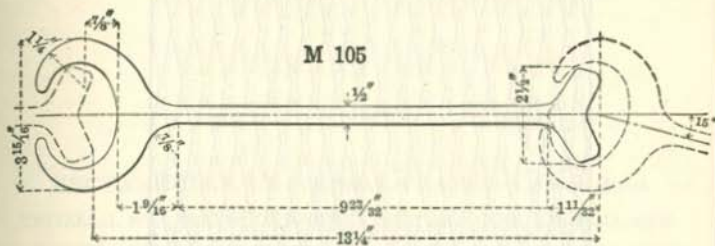

Section Index	Width, Inches	Web Thickness, Inches	Weight per Foot, Pounds
M 105	$13\frac{1}{4}$	$\frac{1}{2}$	42.5
M 104	$13\frac{1}{4}$	$\frac{3}{8}$	38
M 103	$9\frac{1}{4}$	$\frac{1}{4}$	16

Full information as to the properties and uses of these sections is given in a separate pamphlet entitled "Steel Sheet Piling."

CARNEGIE STEEL COMPANY

CHECKERED PLATES

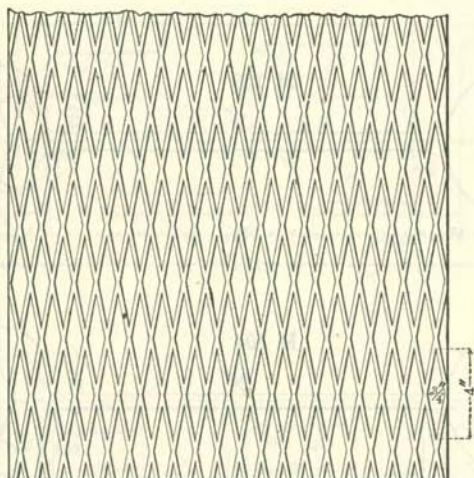

Section at Rib

Section Index	Thick-ness, Inches	Width and Length, Inches						Weight per Sq. Foot, Pounds
		Over 6 to 12	Over 12 to 24	Over 24 to 36	Over 36 to 48	Over 48 to 60	Over 60 to 66	
M 56	$\frac{3}{4}$...	120	180	280	264	240	31.6
M 55	$\frac{5}{8}$...	180	200	300	300	260	26.5
M 54	$\frac{1}{2}$	120	240	240	320	360	300	21.4
M 53	$\frac{7}{16}$	120	240	240	340	360	300	18.9
M 52	$\frac{3}{8}$	120	240	300	340	360	300	16.3
M 51	$\frac{5}{16}$	120	240	300	320	360	300	13.8
M 50	$\frac{1}{4}$	120	240	300	320	360	240	11.2
M 49	$\frac{3}{16}$	120	240	300	320	360	240	8.7

Checkered plates of greater lengths than shown in above table may be submitted for special consideration.

FLAT ROLLED STEEL

RECTANGULAR UNIVERSAL PLATES—Carbon Steel

UNIVERSAL MILL PLATES, ONE-FOURTH INCH AND OVER, EXTREME SIZES

Thick- ness, Inches	Weight, Lbs. per Sq. Ft.	Widths and Lengths in Inches										
		48-46	45-41	40-36	35-31	30-26	25-20	19-17	16-15	14-12	11	10-6½
¼	10.20						1020	1020	1020	1020	540	540
⅓	12.75	1020	1020	1140	1260	1320	1320	1080	1080	1080	600	600
⅔	15.30	1200	1200	1320	1380	1380	1380	1080	1080	1080	900	840
⅞	17.85	1320	1320	1380	1380	1380	1380	1080	1080	1080	900	840
1	20.40	1380	1380	1380	1380	1380	1380	1080	1080	1080	1020	840
1 ¼	22.95	1380	1380	1380	1380	1380	1380	1080	1080	1080	1020	840
1 ½	25.50	1380	1380	1380	1380	1380	1380	1080	1080	1080	1020	840
1 ¾	30.60	1353	1357	1363	1372	1380	1380	1080	1080	1080	900	840
2	35.70	1160	1163	1169	1177	1188	1203	1080	1080	1080	900	840
2 ¼	40.80	1015	1018	1023	1030	1039	1052	1080	1080	1080	900	840
2 ½	45.90	903	905	910	916	924	936	1080	1080	1080	840	840
2 ¾	51.00	812	814	818	824	832	842	1071	1080	1080	840	840
3	56.10	738	740	744	749	756	766	973	1080	1080	840	840
3 ¼	61.20	677	679	682	687	693	702	892	1059	1080	840	840
3 ½	66.30	625	626	629	634	640	648	823	978	1080	840	840
3 ¾	71.40	580	581	584	588	594	601	765	908	1038	720	720
4	76.50	541	543	545	549	554	561	714	847	968	660	720
4 ¼	81.60	507	509	511	515	519	526	669	794	907	600	720

Plates of greater dimensions than shown in above table may be submitted for special consideration.

CARNEGIE STEEL COMPANY

RECTANGULAR AND CIRCULAR PLATES—Carbon Steel
SHEARED PLATES, THREE-SIXTEENTH INCH AND OVER, EXTREME SIZES

Thick- ness, Inches	Weight, Lbs. per Sq. Ft.	Widths and Lengths in Inches										Diam., Inches
		128	126	120	114	108	102	96	90	84	78	
3/16	7.65								270	320	345	90
1/4	10.20				175	250	280	300	330	375	400	115
5/16	12.75			240	270	320	360	380	420	440	460	120
3/8	15.30	220	240	270	320	365	380	410	450	500	550	130
7/16	17.85	240	270	300	360	370	410	430	460	510	550	130
1/2	20.40	260	270	320	365	400	450	480	510	550	580	130
9/16	22.95	260	270	330	373	420	470	500	530	570	600	130
5/8	25.50	260	300	350	390	450	500	520	540	600	620	130
11/16	28.05	260	300	360	420	450	500	520	540	600	620	130
3/4	30.60	260	300	360	400	450	490	520	540	600	620	130
13/16	33.15	260	300	340	385	440	490	510	530	600	620	130
7/8	35.70	260	300	330	375	440	480	510	530	600	620	130
1	40.80	250	300	300	340	440	460	500	530	580	600	130
1 1/8	45.90	250	300	300	330	410	440	450	500	550	580	130
1 1/4	51.00	240	270	300	310	380	400	420	490	530	550	130
1 1/2	61.20	220	230	260	280	330	320	340	420	440	480	130
1 3/4	71.40	200	200	220	240	280	270	300	380	380	410	130
2	81.60	180	180	190	210	240	240	260	320	330	360	130
2 1/4	91.80	150	160	170	190	210	210	230	280	295	320	130

Thick- ness, Inches	Weight, Lbs. per Sq. Ft.	72	66	60	54	50	48	42	36	30	24	Diam., Inches
3/16	7.65	375	420	470	480	480	480	480	480	480	480	90
1/4	10.20	430	475	525	530	530	530	530	530	530	530	115
5/16	12.75	480	500	560	550	575	575	550	550	550	580	120
3/8	15.30	600	600	620	620	620	620	600	580	600	600	130
7/16	17.85	600	630	630	640	640	640	600	580	600	600	130
1/2	20.40	610	630	630	640	640	640	600	580	630	600	130
9/16	22.95	620	640	640	640	640	640	600	580	630	600	130
5/8	25.50	620	640	640	640	640	640	600	580	600	600	130
11/16	28.05	620	640	640	640	640	640	600	580	600	580	130
3/4	30.60	620	640	640	640	640	640	600	580	600	580	130
13/16	33.15	620	640	640	640	640	640	600	580	570	550	130
7/8	35.70	620	640	640	640	640	640	600	580	550	550	130
1	40.80	600	630	630	640	640	640	580	580	520	530	130
1 1/8	45.90	580	620	620	640	640	640	580	580	520	500	130
1 1/4	51.00	550	600	600	600	600	600	560	560	520	450	130
1 1/2	61.20	530	600	600	600	600	600	540	540	470	430	130
1 3/4	71.40	450	490	550	550	550	550	540	540	430	380	130
2	81.60	400	440	480	500	500	500	500	500	400	350	130
2 1/4	91.80	350	390	420	450	450	450	450	450	300	200	130

Plates 48" wide and under can also be rolled on Universal Mills.

For greater length and Universal Mill Sizes, see Universal Mill Plate Table.

Plates of greater dimensions than shown in above table may be submitted for special consideration.

FLAT ROLLED STEEL

RECTANGULAR PLATES—Nickel Steel

SHEARED PLATES, ONE-FOURTH INCH AND OVER, EXTREME SIZES

Thick- ness, Inches	Widths and Lengths in Inches														
	102	96	90	84	78	72	66	60	54	50	48	42	36	30	24
1/4						240	240	260	280	280	280	280	280	260	260
5/16					260	260	270	300	310	310	340	340	340	310	310
3/8		280	340	390	420	450	500	500	500	500	480	450	450	430	430
7/16	260	300	360	400	430	480	520	520	520	520	500	490	490	480	480
1/2	270	320	380	420	460	485	520	520	520	520	500	490	490	480	480
5/8	270	320	380	420	460	485	520	520	520	520	500	490	490	480	480
3/4	270	300	355	390	440	480	520	520	520	520	500	500	500	480	450
7/8	260	300	355	390	440	460	490	500	500	500	500	500	480	480	450
1	260	300	355	390	440	450	460	500	500	500	500	500	480	480	450
1 1/8	260	300	355	390	440	460	480	500	500	500	500	500	480	480	440
1 1/4	260	300	355	390	440	460	480	480	480	480	480	480	480	480	440
1 1/2	260	300	355	390	440	460	480	480	480	480	480	480	480	480	440
1 3/4	260	290	320	370	400	430	440	460	480	480	480	480	440	420	420
2	250	270	295	330	375	400	410	420	440	440	440	440	440	420	420
1 1/8	240	260	290	315	330	350	360	380	390	400	400	420	420	400	400
1 1/4	230	260	290	290	310	330	350	370	390	390	390	390	380	380	360
1 1/2	220	230	250	270	300	310	330	350	370	390	390	360	340	340	320
1 3/4	220	230	250	270	300	310	330	350	370	390	390	360	340	340	320
2	210	230	250	260	290	295	310	330	350	370	370	340	320	320	290

RECTANGULAR PLATES—Nickel Steel

UNIVERSAL MILL PLATES, ONE-FOURTH INCH AND OVER, EXTREME SIZES

Thick- ness, Inches	Widths and Lengths in Inches										
	48-46	45-41	40-36	35-31	30-26	25-20	19-17	16-15	14-12	11	10-6 1/2
1/4							660	660	660	540	540
5/16	540	540	600	660	720	780	780	780	780	600	600
3/8	720	720	780	840	960	960	1020	1020	1020	900	840
7/16	840	840	960	1020	1080	1080	1020	1020	1020	900	840
1/2	960	960	1080	1140	1200	1200	1020	1020	1020	1020	840
5/8	960	960	1080	1140	1200	1200	1020	1020	1020	1020	840
3/4	900	900	1020	1080	1140	1140	1000	1000	1020	1020	840
7/8	840	840	960	1020	1080	1080	1000	1000	1020	900	840
1	780	780	840	960	960	960	1000	1000	1000	900	840
1 1/8	720	750	780	816	840	900	1000	1000	1000	900	840
1 1/4	640	667	693	725	744	800	1000	1000	1000	840	840
1 1/2	575	600	624	652	672	720	1000	1000	1000	840	840
1 3/4	525	545	567	593	600	655	970	1000	1000	840	840
2	480	500	520	544	540	600	890	1000	980	840	840
1 1/8	444	461	480	502	504	554	820	978	980	840	840
1 1/4	410	428	445	466	480	514	765	908	980	720	720
1 1/2	384	400	416	435	444	480	710	847	968	660	720
1 3/4	360	375	390	408	420	450	670	794	908	600	720

All sizes of Rectangular Nickel Steel Plates given in above tables under 1/2" thick should be specified to gage only. Plates 1/2" thick and over can be rolled to either gage or weight per square foot.

SQUARE EDGE FLATS

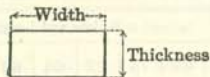

	$\frac{3}{8}$ " to 1" wide, x $\frac{1}{8}$ " to $\frac{1}{8}$ "	$6\frac{1}{8}$ " to $6\frac{3}{8}$ " wide, x $\frac{1}{4}$ " to $2\frac{1}{2}$ "
Over 1" to 2"	wide, x $\frac{3}{16}$ " to $1\frac{3}{4}$ "	$6\frac{1}{2}$ " to $6\frac{3}{8}$ " wide, x $\frac{1}{4}$ " to $2\frac{3}{8}$ "
Over 2" to $4\frac{1}{4}$ "	wide, x $\frac{1}{4}$ " to $2\frac{1}{4}$ "	$6\frac{3}{4}$ " wide, x $\frac{1}{4}$ " to $2\frac{1}{4}$ "
Over $4\frac{1}{4}$ " to $4\frac{7}{8}$ "	wide, x $\frac{1}{4}$ " to 2"	$6\frac{7}{8}$ " to $7\frac{1}{4}$ " wide, x $\frac{1}{4}$ " to 2"
5" to $5\frac{1}{4}$ "	wide, x $\frac{3}{4}$ " to 3"	$7\frac{3}{8}$ " wide, x $\frac{1}{4}$ " to $1\frac{3}{4}$ "
$5\frac{3}{8}$ "	wide, x $\frac{1}{4}$ " to $2\frac{7}{8}$ "	$7\frac{1}{2}$ " to $7\frac{3}{4}$ " wide, x $\frac{1}{4}$ " to $1\frac{3}{4}$ "
$5\frac{1}{2}$ " to $5\frac{5}{8}$ "	wide, x $\frac{1}{4}$ " to $2\frac{3}{4}$ "	$7\frac{7}{8}$ " to 8" wide, x $\frac{1}{4}$ " to $1\frac{1}{8}$ "
$5\frac{3}{4}$ " to 6"	wide, x $\frac{1}{4}$ " to $2\frac{5}{8}$ "	

Sizes not listed will be considered.

NUT STEEL FLATS

All sizes of Nut Steel Flats within the range of Square Edge Flats can be furnished. Some of the smaller sizes can be furnished in coils.

BAND EDGE FLATS

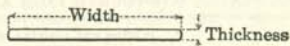

$\frac{3}{8}$ "	wide, x No. 18 to No. 4 B.W.G.
$\frac{7}{16}$ "	wide, x No. 19 to No. 4 B.W.G.
$\frac{1}{2}$ "	wide, x No. 22 to No. 4 B.W.G.
$\frac{9}{16}$ " to 1",	wide, x No. 23 to No. 4 B.W.G.
$1\frac{1}{16}$ " to 2",	wide, x No. 21 to No. 4 B.W.G.
$2\frac{1}{16}$ " to 3",	wide, x No. 20 to No. 1 B.W.G.
$3\frac{1}{16}$ " to $3\frac{1}{2}$ ",	wide, x No. 19 to No. 1 B.W.G.
$3\frac{9}{16}$ " to 4",	wide, x No. 18 to No. 1 B.W.G.
$4\frac{1}{16}$ " to $4\frac{1}{2}$ "	wide, x No. 17 to No. 1 B.W.G.
$4\frac{9}{16}$ " to $5\frac{1}{16}$ ",	wide, x No. 16 to No. 1 B.W.G.
$5\frac{1}{8}$ " to $6\frac{3}{4}$ ",	wide, x No. 15 to No. 0 B.W.G.
$6\frac{3}{16}$ " to 9",	wide, x No. 14 to No. 0 B.W.G.
$9\frac{1}{8}$ " to 12",	wide, x No. 12 to No. 0 B.W.G.
$12\frac{1}{6}$ " to 15",	wide, x No. 10 to No. 0 B.W.G.
$15\frac{1}{8}$ " to 16",	wide, x No. 8 to No. 0 B.W.G.

Sizes not listed will be considered.

SKELP

All sizes within the range of Sheared Plates, Universal Mill Plates, and Band Edge Flats can be furnished.

WEIGHTS OF FLAT ROLLED STEEL

WEIGHTS OF FLAT ROLLED STEEL

· POUNDS PER LINEAL FOOT

Width, Inches	Thickness, Inches																	
	1/16	1/8	3/16	1/4	5/16	3/8	7/16	1/2	5/8	3/4	7/8	1 1/8	1 1/4	1 3/8	1 1/2	1 5/8	1 3/4	
1/4	.053	.106	.159	.213	.27	.32	.37	.43	.48	.53	.58	.64	.69	.74	.80	.85		
1/2	.106	.213	.319	.425	.53	.64	.74	.85	.96	1.06	1.17	1.28	1.38	1.49	1.59	1.70		
3/4	.159	.319	.478	.638	.80	.96	1.12	1.28	1.43	1.59	1.75	1.91	2.07	2.23	2.39	2.55		
1	.213	.425	.638	.850	1.06	1.28	1.49	1.70	1.91	2.13	2.34	2.55	2.76	2.98	3.19	3.40		
1 1/4	.266	.531	.797	1.063	1.33	1.59	1.86	2.13	2.39	2.66	2.92	3.19	3.45	3.72	3.98	4.25		
1 1/2	.319	.638	.956	1.275	1.59	1.91	2.23	2.55	2.87	3.19	3.51	3.83	4.14	4.46	4.78	5.10		
1 3/4	.372	.744	1.116	1.488	1.86	2.23	2.60	2.98	3.35	3.72	4.09	4.46	4.83	5.21	5.58	5.95		
2	.425	.850	1.275	1.700	2.13	2.55	2.98	3.40	3.83	4.25	4.68	5.10	5.53	5.95	6.38	6.80		
2 1/4	.478	.956	1.434	1.913	2.39	2.87	3.35	3.83	4.30	4.78	5.26	5.74	6.22	6.69	7.17	7.65		
2 1/2	.531	1.063	1.594	2.125	2.66	3.19	3.72	4.25	4.78	5.31	5.84	6.38	6.91	7.44	7.97	8.50		
2 3/4	.584	1.169	1.753	2.338	2.92	3.51	4.09	4.68	5.26	5.84	6.43	7.01	7.60	8.18	8.77	9.35		
3	.638	1.275	1.913	2.550	3.19	3.83	4.46	5.10	5.74	6.38	7.01	7.65	8.29	8.93	9.56	10.20		
3 1/4	.691	1.381	2.072	2.763	3.45	4.14	4.83	5.53	6.22	6.91	7.60	8.29	8.98	9.67	10.36	11.05		
3 1/2	.744	1.488	2.231	2.975	3.72	4.46	5.21	5.95	6.69	7.44	8.18	8.93	9.67	10.41	11.16	11.90		
3 3/4	.797	1.594	2.391	3.188	3.98	4.78	5.58	6.38	7.17	7.97	8.77	9.56	10.36	11.16	11.95	12.75		
4	.850	1.700	2.550	3.400	4.25	5.10	5.95	6.80	7.65	8.50	9.35	10.20	11.05	11.90	12.75	13.60		
4 1/4	.903	1.806	2.709	3.613	4.52	5.42	6.32	7.23	8.13	9.03	9.93	10.84	11.74	12.64	13.55	14.45		
4 1/2	.956	1.913	2.869	3.825	4.78	5.74	6.69	7.65	8.61	9.56	10.52	11.48	12.43	13.39	14.34	15.30		
4 3/4	1.000	2.019	3.028	4.038	5.05	6.06	7.07	8.08	9.08	10.09	11.10	12.11	13.12	14.13	15.14	16.15		
5	1.063	2.125	3.188	4.250	5.31	6.38	7.44	8.50	9.56	10.63	11.69	12.75	13.81	14.88	15.94	17.00		
5 1/4	1.116	2.231	3.347	4.463	5.58	6.69	7.81	8.93	10.04	11.16	12.27	13.39	14.50	15.62	16.73	17.85		
5 1/2	1.169	2.338	3.506	4.675	5.84	7.01	8.18	9.35	10.52	11.69	12.86	14.03	15.19	16.36	17.53	18.70		
5 3/4	1.222	2.444	3.666	4.888	6.11	7.33	8.55	9.78	11.00	12.22	13.44	14.66	15.88	17.11	18.33	19.55		
6	1.275	2.550	3.825	5.100	6.38	7.65	8.93	10.20	11.48	12.75	14.03	15.30	16.58	17.85	19.13	20.40		
6 1/4	1.328	2.656	3.984	5.313	6.64	7.97	9.30	10.63	11.95	13.28	14.61	15.94	17.27	18.59	19.92	21.25		
6 1/2	1.381	2.763	4.144	5.525	6.91	8.29	9.67	11.05	12.43	13.81	15.19	16.58	17.96	19.34	20.72	22.10		
6 3/4	1.434	2.869	4.303	5.738	7.17	8.61	10.04	11.48	12.91	14.34	15.78	17.21	18.65	20.08	21.52	22.95		
7	1.488	2.975	4.463	5.950	7.44	8.93	10.41	11.90	13.39	14.88	16.36	17.85	19.34	20.83	22.31	23.80		
7 1/4	1.541	3.081	4.622	6.163	7.70	9.24	10.78	12.33	13.87	15.41	16.95	18.49	20.03	21.57	23.11	24.65		
7 1/2	1.594	3.188	4.781	6.375	7.97	9.56	11.16	12.75	14.34	15.94	17.53	19.13	20.72	22.31	23.91	25.50		
7 3/4	1.647	3.294	4.941	6.588	8.23	9.88	11.53	13.18	14.82	16.47	18.12	19.76	21.41	23.06	24.70	26.35		
8	1.700	3.400	5.100	6.800	8.50	10.20	11.90	13.60	15.30	17.00	18.70	20.40	22.10	23.80	25.50	27.20		
8 1/4	1.753	3.506	5.259	7.013	8.77	10.52	12.27	14.03	15.78	17.53	19.28	21.04	22.79	24.54	26.30	28.05		
8 1/2	1.806	3.613	5.419	7.225	9.03	10.84	12.64	14.45	16.26	18.06	19.87	21.68	23.48	25.29	27.09	28.90		
8 3/4	1.859	3.719	5.578	7.438	9.30	11.16	13.02	14.88	16.73	18.59	20.45	22.31	24.17	26.03	27.89	29.75		
9	1.913	3.825	5.738	7.650	9.56	11.48	13.39	15.30	17.21	19.13	21.04	22.95	24.86	26.78	28.69	30.60		
9 1/4	1.966	3.931	5.897	7.863	9.83	11.79	13.76	15.73	17.69	19.66	21.62	23.59	25.55	27.52	29.48	31.45		
9 1/2	2.019	4.038	6.056	8.075	10.09	12.11	14.13	16.15	18.17	20.19	22.21	24.23	26.24	28.26	30.28	32.30		
9 3/4	2.072	4.144	6.216	8.288	10.36	12.43	14.50	16.58	18.65	20.72	22.79	24.86	26.93	29.01	31.08	33.15		
10	2.125	4.250	6.375	8.500	10.63	12.75	14.88	17.00	19.13	21.25	23.38	25.50	27.63	29.75	31.88	34.00		
10 1/4	2.178	4.356	6.534	8.713	10.89	13.07	15.25	17.43	19.60	21.78	23.96	26.14	28.32	30.49	32.67	34.85		
10 1/2	2.231	4.463	6.694	8.925	11.16	13.39	15.62	17.85	20.08	22.31	24.54	26.78	29.01	31.24	33.47	35.70		
10 3/4	2.284	4.569	6.853	9.138	11.42	13.71	15.99	18.28	20.56	22.84	25.13	27.41	29.70	31.98	34.27	36.55		
11	2.338	4.675	7.013	9.350	11.69	14.03	16.36	18.70	21.04	23.38	25.71	28.05	30.39	32.73	35.06	37.40		
11 1/4	2.391	4.781	7.172	9.563	11.95	14.34	16.73	19.13	21.52	23.91	26.30	28.69	31.08	33.47	35.86	38.25		
11 1/2	2.444	4.888	7.331	9.775	12.22	14.66	17.11	19.55	21.99	24.44	26.88	29.33	31.77	34.21	36.66	39.10		
11 3/4	2.497	4.994	7.491	9.988	12.48	14.98	17.48	19.98	22.47	24.97	27.47	29.96	32.46	34.96	37.45	39.95		
12	2.550	5.100	7.650	10.20	12.75	15.30	17.85	20.40	22.95	25.50	28.05	30.60	33.15	35.70	38.25	40.80		

CARNEGIE STEEL COMPANY

WEIGHTS OF FLAT ROLLED STEEL—Continued

POUNDS PER LINEAL FOOT

Width, Inches	Thickness, Inches															
	1/16	1/8	3/16	1/4	5/16	3/8	7/16	1/2	9/16	5/8	11/16	3/4	13/16	7/8	15/16	1
12 1/2	2.66	5.31	7.97	10.63	13.28	15.94	18.59	21.25	23.91	26.56	29.22	31.9	34.5	37.2	39.8	42.5
13	2.76	5.53	8.29	11.05	13.81	16.58	19.34	22.10	24.86	27.63	30.4	33.2	35.9	38.7	41.4	44.2
13 1/2	2.87	5.74	8.61	11.48	14.34	17.21	20.08	22.95	25.82	28.69	31.6	34.4	37.3	40.2	43.0	45.9
14	2.98	5.95	8.93	11.90	14.88	17.85	20.83	23.80	26.78	29.75	32.7	35.7	38.7	41.7	44.6	47.6
14 1/2	3.08	6.16	9.24	12.33	15.41	18.49	21.57	24.65	27.73	30.81	33.9	37.0	40.1	43.1	46.2	49.3
15	3.19	6.38	9.56	12.75	15.94	19.13	22.31	25.50	28.69	31.88	35.1	38.3	41.4	44.6	47.8	51.0
15 1/2	3.29	6.59	9.88	13.18	16.47	19.76	23.06	26.35	29.64	32.94	36.2	39.5	42.8	46.1	49.4	52.7
16	3.40	6.80	10.20	13.60	17.00	20.40	23.80	27.20	30.60	34.00	37.4	40.8	44.2	47.6	51.0	54.4
16 1/2	3.51	7.01	10.52	14.03	17.53	21.04	24.54	28.05	31.56	35.06	38.6	42.1	45.6	49.1	52.6	56.1
17	3.61	7.23	10.84	14.45	18.06	21.68	25.29	28.90	32.51	36.13	39.7	43.4	47.0	50.6	54.2	57.8
17 1/2	3.72	7.44	11.16	14.88	18.59	22.31	26.03	29.75	33.47	37.19	40.9	44.6	48.3	52.1	55.8	59.5
18	3.83	7.65	11.48	15.30	19.13	22.95	26.78	30.60	34.43	38.25	42.1	45.9	49.7	53.6	57.4	61.2
18 1/2	3.93	7.86	11.79	15.73	19.66	23.59	27.52	31.45	35.38	39.31	43.2	47.2	51.1	55.0	59.0	62.9
19	4.04	8.08	12.11	16.15	20.19	24.23	28.26	32.30	36.34	40.38	44.4	48.5	52.5	56.5	60.6	64.6
19 1/2	4.14	8.29	12.43	16.58	20.72	24.86	29.01	33.15	37.29	41.44	45.6	49.7	53.9	58.0	62.2	66.3
20	4.25	8.50	12.75	17.00	21.25	25.50	29.75	34.00	38.25	42.50	46.8	51.0	55.3	59.5	63.8	68.0
20 1/2	4.36	8.71	13.07	17.43	21.78	26.14	30.49	34.85	39.21	43.56	47.9	52.3	56.6	61.0	65.3	69.7
21	4.46	8.93	13.39	17.85	22.31	26.78	31.24	35.70	40.16	44.63	49.1	53.6	58.0	62.5	66.9	71.4
21 1/2	4.57	9.14	13.71	18.28	22.84	27.41	31.98	36.55	41.12	45.69	50.3	54.8	59.4	64.0	68.5	73.1
22	4.68	9.35	14.03	18.70	23.38	28.05	32.73	37.40	42.08	46.75	51.4	56.1	60.8	65.5	70.1	74.8
22 1/2	4.78	9.56	14.34	19.13	23.91	28.69	33.47	38.25	43.03	47.81	52.6	57.4	62.2	66.9	71.7	76.5
23	4.89	9.78	14.66	19.55	24.44	29.33	34.21	39.10	43.99	48.88	53.8	58.7	63.5	68.4	73.3	78.2
23 1/2	4.99	9.99	14.98	19.98	24.97	29.96	34.96	39.95	44.94	49.94	54.9	59.9	64.9	69.9	74.9	79.9
24	5.10	10.20	15.30	20.40	25.50	30.60	35.70	40.80	45.90	51.00	56.1	61.2	66.3	71.4	76.5	81.6
25	5.31	10.63	15.94	21.25	26.56	31.88	37.19	42.50	47.81	53.13	58.4	63.8	69.1	74.4	79.7	85.0
26	5.53	11.05	16.58	22.10	27.63	33.15	38.68	44.20	49.73	55.25	60.8	66.3	71.8	77.4	82.9	88.4
27	5.74	11.48	17.21	22.95	28.69	34.43	40.16	45.90	51.64	57.38	63.1	68.9	74.6	80.3	86.1	91.8
28	5.95	11.90	17.85	23.80	29.75	35.70	41.65	47.60	53.55	59.50	65.5	71.4	77.4	83.3	89.3	95.2
29	6.16	12.33	18.49	24.65	30.81	36.98	43.14	49.30	55.46	61.63	67.8	74.0	80.1	86.3	92.4	98.6
30	6.38	12.75	19.13	25.50	31.88	38.25	44.63	51.00	57.38	63.75	70.1	76.5	82.9	89.3	95.6	102.0
31	6.59	13.18	19.76	26.35	32.94	39.53	46.11	52.70	59.29	65.88	72.5	79.1	85.6	92.2	98.8	105.4
32	6.80	13.60	20.40	27.20	34.00	40.80	47.60	54.40	61.20	68.00	74.8	81.6	88.4	95.2	102.0	108.8
33	7.01	14.03	21.04	28.05	35.06	42.08	49.09	56.10	63.11	70.13	77.1	84.2	91.2	98.2	105.2	112.2
34	7.23	14.45	21.68	28.90	36.13	43.35	50.58	57.80	65.03	72.25	79.5	86.7	93.9	101.2	108.4	115.6
35	7.44	14.88	22.31	29.75	37.19	44.63	52.06	59.50	66.94	74.38	81.8	89.3	96.7	104.1	111.6	119.0
36	7.65	15.30	22.95	30.60	38.25	45.90	53.55	61.20	68.85	76.50	84.2	91.8	99.5	107.1	114.8	122.4
37	7.86	15.73	23.59	31.45	39.31	47.18	55.04	62.90	70.76	78.63	86.5	94.4	102.2	110.1	117.9	125.8
38	8.08	16.15	24.23	32.30	40.38	48.45	56.53	64.60	72.68	80.75	88.8	96.9	105.0	113.1	121.1	129.2
39	8.29	16.58	24.86	33.15	41.44	49.73	58.01	66.30	74.59	82.88	91.2	99.5	107.7	116.0	124.3	132.6
40	8.50	17.00	25.50	34.00	42.50	51.00	59.50	68.00	76.50	85.00	93.5	102.0	110.5	119.0	127.5	136.0
41	8.71	17.43	26.14	34.85	43.56	52.28	60.99	69.70	78.41	87.13	95.8	104.6	113.3	122.0	130.7	139.4
42	8.93	17.85	26.78	35.70	44.63	53.55	62.48	71.40	80.33	89.25	98.2	107.1	116.0	125.0	133.9	142.8
43	9.14	18.28	27.41	36.55	45.69	54.83	63.96	73.10	82.24	91.38	100.5	109.7	118.8	127.9	137.1	146.2
44	9.35	18.70	28.05	37.40	46.75	56.10	65.45	74.80	84.15	93.50	102.9	112.2	121.6	130.9	140.3	149.6
45	9.56	19.13	28.69	38.25	47.81	57.38	66.94	76.50	86.06	95.63	105.2	114.8	124.3	133.9	143.4	153.0
46	9.78	19.55	29.33	39.10	48.88	58.55	68.43	78.20	87.98	97.75	107.5	117.3	127.1	136.9	146.6	156.4
47	9.99	19.98	29.96	39.95	49.94	59.93	69.91	79.90	89.89	99.88	109.9	119.9	129.8	139.8	149.8	159.8
48	10.20	20.40	30.60	40.80	51.00	61.20	71.40	81.60	91.80	102.0	112.2	122.4	132.6	142.8	153.0	163.2

WEIGHTS OF FLAT ROLLED STEEL

WEIGHTS OF FLAT ROLLED STEEL—Concluded
POUNDS PER LINEAL FOOT

Width, Inches	Thickness, Inches															
	1/16	1/8	3/16	1/4	5/16	3/8	7/16	1/2	9/16	5/8	11/16	3/4	13/16	7/8	15/16	1
49	10.4	20.8	31.2	41.7	52.1	62.5	72.9	83.3	93.7	104.1	114.5	125.0	135.4	145.8	156.2	166.6
50	10.6	21.3	31.9	42.5	53.1	63.8	74.4	85.0	95.6	106.3	116.9	127.5	138.1	148.8	159.4	170.0
51	10.8	21.7	32.5	43.4	54.2	65.0	75.9	86.7	97.5	108.4	119.2	130.1	140.9	151.7	162.6	173.4
52	11.1	22.1	33.2	44.2	55.3	66.3	77.4	88.4	99.5	110.5	121.6	132.6	143.7	154.7	165.8	176.8
53	11.3	22.5	33.8	45.1	56.3	67.6	78.8	90.1	101.4	112.6	123.9	135.2	146.4	157.7	168.9	180.2
54	11.5	23.0	34.4	45.9	57.4	68.9	80.3	91.8	103.3	114.8	126.2	137.7	149.2	160.7	172.1	183.6
55	11.7	23.4	35.1	46.8	58.4	70.1	81.8	93.5	105.2	116.9	128.6	140.3	151.9	163.6	175.3	187.0
56	11.9	23.8	35.7	47.6	59.5	71.4	83.3	95.2	107.1	119.0	130.9	142.8	154.7	166.6	178.5	190.4
57	12.1	24.2	36.3	48.5	60.6	72.7	84.8	96.9	109.0	121.1	133.2	145.4	157.5	169.6	181.7	193.8
58	12.3	24.7	37.0	49.3	61.6	74.0	86.3	98.6	110.9	123.3	135.6	147.9	160.2	172.6	184.9	197.2
59	12.5	25.1	37.6	50.2	62.7	75.2	87.8	100.3	112.8	125.4	137.9	150.5	163.0	175.5	188.1	200.6
60	12.8	25.5	38.3	51.0	63.8	76.5	89.3	102.0	114.8	127.5	140.3	153.0	165.8	178.5	191.3	204.0
61	13.0	25.9	38.9	51.9	64.8	77.8	90.7	103.7	116.7	129.6	142.6	155.6	168.5	181.5	194.4	207.4
62	13.2	26.4	39.5	52.7	65.9	79.1	92.2	105.4	118.6	131.8	144.9	158.1	171.3	184.5	197.6	210.8
63	13.4	26.8	40.2	53.6	66.9	80.3	93.7	107.1	120.5	133.9	147.3	160.7	174.0	187.4	200.8	214.2
64	13.6	27.2	40.8	54.4	68.0	81.6	95.2	108.8	122.4	136.0	149.6	163.2	176.8	190.4	204.0	217.6
65	13.8	27.6	41.4	55.3	69.1	82.9	96.7	110.5	124.3	138.1	151.9	165.8	179.6	193.4	207.2	221.0
66	14.0	28.1	42.1	56.1	70.1	84.2	98.2	112.2	126.2	140.3	154.3	168.3	182.3	196.4	210.4	224.4
67	14.2	28.5	42.7	57.0	71.2	85.4	99.7	113.9	128.1	142.4	156.6	170.9	185.1	199.3	213.6	227.8
68	14.5	28.9	43.4	57.8	72.3	86.7	101.2	115.6	130.1	144.5	159.0	173.4	187.9	202.3	216.8	231.2
69	14.7	29.3	44.0	58.7	73.3	88.0	102.6	117.3	132.0	146.6	161.3	176.0	190.6	205.3	219.9	234.6
70	14.9	29.8	44.6	59.5	74.4	89.3	104.1	119.0	133.9	148.8	163.6	178.5	193.4	208.3	223.1	238.0
71	15.1	30.2	45.3	60.4	75.4	90.5	105.6	120.7	135.8	150.9	166.0	181.1	196.1	211.2	226.3	241.4
72	15.3	30.6	45.9	61.2	76.5	91.8	107.1	122.4	137.7	153.0	168.3	183.6	198.9	214.2	229.5	244.8
73	15.5	31.0	46.5	62.1	77.6	93.1	108.6	124.1	139.6	155.1	170.6	186.2	201.7	217.2	232.7	248.2
74	15.7	31.5	47.2	62.9	78.6	94.4	110.1	125.8	141.5	157.3	173.0	188.7	204.4	220.2	235.9	251.6
75	15.9	31.9	47.8	63.8	79.7	95.6	111.6	127.5	143.4	159.4	175.3	191.3	207.2	223.1	239.1	255.0
76	16.2	32.3	48.5	64.6	80.8	96.9	113.1	129.2	145.4	161.5	177.7	193.8	210.0	226.1	242.3	258.4
77	16.4	32.7	49.1	65.5	81.8	98.2	114.5	130.9	147.3	163.6	180.0	196.4	212.7	229.1	245.4	261.8
78	16.6	33.2	49.7	66.3	82.9	99.5	116.0	132.6	149.2	165.8	182.3	198.9	215.5	232.1	248.6	265.2
79	16.8	33.6	50.4	67.2	83.9	100.7	117.5	134.3	151.1	167.9	184.7	201.5	218.2	235.0	251.8	268.6
80	17.0	34.0	51.0	68.0	85.0	102.0	119.0	136.0	153.0	170.0	187.0	204.0	221.0	238.0	255.0	272.0
81	17.2	34.4	51.6	68.9	86.1	103.3	120.5	137.7	154.9	172.1	189.3	206.6	223.8	241.0	258.2	275.4
82	17.4	34.9	52.3	69.7	87.1	104.6	122.0	139.4	156.8	174.3	191.7	209.1	226.5	244.0	261.4	278.8
83	17.6	35.3	52.9	70.6	88.2	105.8	123.5	141.1	158.7	176.4	194.0	211.7	229.3	246.9	264.6	282.2
84	17.9	35.7	53.6	71.4	89.3	107.1	125.0	142.8	160.7	178.5	196.4	214.2	232.1	249.9	267.8	285.6
85	18.1	36.1	54.2	72.3	90.3	108.4	126.4	144.5	162.6	180.6	198.7	216.8	234.8	252.9	270.9	289.0
86	18.3	36.6	54.8	73.1	91.4	109.7	127.9	146.2	164.5	182.8	201.0	219.3	237.6	255.9	274.1	292.4
87	18.5	37.0	55.5	74.0	92.4	110.9	129.4	147.9	166.4	184.9	203.4	221.9	240.3	258.8	277.3	295.8
88	18.7	37.4	56.1	74.8	93.5	112.2	130.9	149.6	168.3	187.0	205.7	224.4	243.1	261.8	280.5	299.2
89	18.9	37.8	56.7	75.7	94.6	113.5	132.4	151.3	170.2	189.1	208.0	227.0	245.9	264.8	283.7	302.6
90	19.1	38.3	57.4	76.5	95.6	114.8	133.9	153.0	172.1	191.3	210.4	229.5	248.6	267.8	286.9	306.0
91	19.3	38.7	58.0	77.4	96.7	116.0	135.4	154.7	174.0	193.4	212.7	232.1	251.4	270.7	290.1	309.4
92	19.6	39.1	58.7	78.2	97.8	117.3	136.9	156.4	176.0	195.5	215.1	234.6	254.2	273.7	293.3	312.8
93	19.8	39.5	59.3	79.1	98.8	118.6	138.3	158.1	177.9	197.6	217.4	237.2	256.9	276.7	296.4	316.2
94	20.0	40.0	59.9	79.9	99.9	119.9	139.8	159.8	179.8	199.8	219.7	239.7	259.7	279.7	299.6	319.6
95	20.2	40.4	60.6	80.8	100.9	121.1	141.3	161.5	181.7	201.9	222.1	242.3	262.4	282.6	302.8	323.0
96	20.4	40.8	61.2	81.6	102.0	122.4	142.8	163.2	183.6	204.0	224.4	244.5	265.2	285.6	306.0	326.4
97	20.6	41.2	61.8	82.5	103.1	123.7	144.3	164.9	185.5	206.1	226.7	247.4	268.0	288.6	309.2	329.8
98	20.8	41.7	62.5	83.3	104.1	125.0	145.8	166.6	187.4	208.3	229.1	249.9	270.7	291.6	312.4	333.2
99	21.0	42.1	63.1	84.2	105.2	126.2	147.3	168.3	189.3	210.4	231.4	252.5	273.5	294.5	315.6	336.6
100	21.3	42.5	63.8	85.0	106.3	127.5	148.8	170.0	191.3	212.5	233.8	255.0	276.3	297.5	318.8	340.0

CARNEGIE STEEL COMPANY

AREAS OF RECTANGULAR SECTIONS

SQUARE INCHES

Width, Inches	Thickness, Inches																	
	$\frac{1}{16}$	$\frac{3}{16}$	$\frac{1}{8}$	$\frac{3}{16}$	$\frac{1}{2}$	$\frac{5}{16}$	$\frac{3}{8}$	$\frac{7}{16}$	$\frac{1}{2}$	$\frac{5}{8}$	$\frac{3}{4}$	$\frac{7}{8}$	1	$1\frac{1}{8}$	$1\frac{1}{4}$	$1\frac{3}{8}$	$1\frac{1}{2}$	
$\frac{1}{4}$.016	.031	.047	.063	.078	.094	.109	.125	.141	.156	.172	.188	.203	.22	.23	.25		
$\frac{1}{2}$.031	.063	.094	.125	.156	.188	.219	.250	.281	.313	.344	.375	.406	.44	.47	.50		
$\frac{3}{4}$.047	.094	.141	.188	.234	.281	.328	.375	.422	.469	.516	.563	.609	.66	.70	.75		
1	.063	.125	.188	.250	.313	.375	.438	.500	.563	.625	.688	.750	.813	.88	.94	1.00		
$1\frac{1}{4}$.078	.156	.234	.313	.391	.469	.547	.625	.703	.781	.859	.938	1.016	1.09	1.17	1.25		
$1\frac{1}{2}$.094	.188	.281	.375	.469	.563	.656	.750	.844	.938	1.031	1.125	1.219	1.31	1.41	1.50		
$1\frac{3}{4}$.109	.219	.328	.438	.547	.656	.766	.875	.984	1.094	1.203	1.313	1.422	1.53	1.64	1.75		
2	.125	.250	.375	.500	.625	.750	.875	1.000	1.125	1.250	1.375	1.500	1.625	1.75	1.88	2.00		
$2\frac{1}{4}$.141	.281	.422	.563	.703	.844	.984	1.125	1.266	1.406	1.547	1.688	1.828	1.97	2.11	2.25		
$2\frac{1}{2}$.156	.313	.469	.625	.781	.938	1.094	1.250	1.406	1.563	1.719	1.875	2.031	2.19	2.34	2.50		
$2\frac{3}{4}$.172	.344	.516	.688	.859	1.031	1.203	1.375	1.547	1.719	1.891	2.063	2.234	2.41	2.58	2.75		
3	.188	.375	.563	.750	.938	1.125	1.313	1.500	1.688	1.875	2.063	2.250	2.438	2.63	2.81	3.00		
$3\frac{1}{4}$.203	.406	.609	.813	1.016	1.219	1.422	1.625	1.828	2.031	2.234	2.438	2.641	2.84	3.05	3.25		
$3\frac{1}{2}$.219	.438	.656	.875	1.094	1.313	1.531	1.750	1.969	2.188	2.406	2.625	2.844	3.06	3.28	3.50		
$3\frac{3}{4}$.234	.469	.703	.938	1.172	1.406	1.641	1.875	2.109	2.344	2.578	2.813	3.047	3.28	3.52	3.75		
4	.250	.500	.750	1.000	1.250	1.500	1.750	2.000	2.250	2.500	2.750	3.000	3.250	3.50	3.75	4.00		
$4\frac{1}{4}$.266	.531	.797	1.063	1.328	1.594	1.859	2.125	2.391	2.656	2.922	3.188	3.453	3.72	3.98	4.25		
$4\frac{1}{2}$.281	.563	.844	1.125	1.406	1.688	1.969	2.250	2.531	2.813	3.094	3.375	3.656	3.94	4.22	4.50		
$4\frac{3}{4}$.297	.594	.891	1.188	1.484	1.781	2.078	2.375	2.672	2.969	3.266	3.563	3.859	4.16	4.45	4.75		
5	.313	.625	.938	1.250	1.563	1.875	2.188	2.500	2.813	3.125	3.438	3.750	4.063	4.38	4.69	5.00		
$5\frac{1}{4}$.328	.656	.984	1.313	1.641	1.969	2.297	2.625	2.953	3.281	3.609	3.938	4.266	4.59	4.92	5.25		
$5\frac{1}{2}$.344	.688	1.031	1.375	1.719	2.063	2.406	2.750	3.094	3.438	3.781	4.125	4.469	4.81	5.16	5.50		
$5\frac{3}{4}$.359	.719	1.078	1.438	1.797	2.156	2.516	2.875	3.234	3.594	3.953	4.313	4.672	5.03	5.39	5.75		
6	.375	.750	1.125	1.500	1.875	2.250	2.625	3.000	3.375	3.750	4.125	4.500	4.875	5.25	5.63	6.00		
$6\frac{1}{4}$.391	.781	1.172	1.563	1.953	2.344	2.734	3.125	3.516	3.906	4.297	4.688	5.078	5.47	5.86	6.25		
$6\frac{1}{2}$.406	.813	1.219	1.625	2.031	2.438	2.844	3.250	3.656	4.063	4.469	4.875	5.281	5.69	6.09	6.50		
$6\frac{3}{4}$.422	.844	1.266	1.688	2.109	2.531	2.953	3.375	3.797	4.219	4.641	5.063	5.484	5.91	6.33	6.75		
7	.438	.875	1.313	1.750	2.188	2.625	3.063	3.500	3.938	4.375	4.813	5.250	5.688	6.13	6.56	7.00		
$7\frac{1}{4}$.453	.906	1.359	1.813	2.266	2.719	3.172	3.625	4.078	4.531	4.984	5.438	5.891	6.34	6.80	7.25		
$7\frac{1}{2}$.469	.938	1.406	1.875	2.344	2.813	3.281	3.750	4.219	4.688	5.156	5.625	6.094	6.56	7.03	7.50		
$7\frac{3}{4}$.484	.969	1.453	1.938	2.422	2.906	3.391	3.875	4.359	4.844	5.328	5.813	6.297	6.78	7.27	7.75		
8	.500	1.000	1.500	2.000	2.500	3.000	3.500	4.000	4.500	5.000	5.500	6.000	6.500	7.00	7.50	8.00		
$8\frac{1}{4}$.516	1.031	1.547	2.063	2.578	3.094	3.609	4.125	4.641	5.156	5.672	6.188	6.703	7.22	7.73	8.25		
$8\frac{1}{2}$.531	1.063	1.594	2.125	2.656	3.188	3.719	4.250	4.781	5.313	5.844	6.375	6.906	7.44	7.97	8.50		
$8\frac{3}{4}$.547	1.094	1.641	2.188	2.734	3.281	3.828	4.375	4.922	5.469	6.016	6.563	7.109	7.66	8.20	8.75		
9	.563	1.125	1.688	2.250	2.813	3.375	3.938	4.500	5.063	5.625	6.188	6.750	7.313	7.88	8.44	9.00		
$9\frac{1}{4}$.578	1.156	1.734	2.313	2.891	3.469	4.047	4.625	5.203	5.781	6.359	6.938	7.516	8.09	8.67	9.25		
$9\frac{1}{2}$.594	1.188	1.781	2.375	2.969	3.563	4.156	4.750	5.344	5.938	6.531	7.125	7.719	8.31	8.91	9.50		
$9\frac{3}{4}$.609	1.219	1.828	2.438	3.047	3.656	4.266	4.875	5.484	6.094	6.703	7.313	7.922	8.53	9.14	9.75		
10	.625	1.250	1.875	2.500	3.125	3.750	4.375	5.000	5.625	6.250	6.875	7.500	8.125	8.75	9.38	10.00		
$10\frac{1}{4}$.641	1.281	1.922	2.563	3.203	3.844	4.484	5.125	5.766	6.406	7.047	7.688	8.328	8.97	9.61	10.25		
$10\frac{1}{2}$.656	1.313	1.969	2.625	3.281	3.938	4.594	5.250	5.906	6.563	7.219	7.875	8.531	9.19	9.84	10.50		
$10\frac{3}{4}$.672	1.344	2.016	2.688	3.359	4.031	4.703	5.375	6.047	6.719	7.391	8.063	8.734	9.41	10.08	10.75		
11	.688	1.375	2.063	2.750	3.438	4.125	4.813	5.500	6.188	6.875	7.563	8.250	8.938	9.63	10.31	11.00		
$11\frac{1}{4}$.703	1.406	2.109	2.813	3.516	4.219	4.922	5.625	6.328	7.031	7.734	8.438	9.141	9.84	10.55	11.25		
$11\frac{1}{2}$.719	1.438	2.156	2.875	3.594	4.313	5.031	5.750	6.469	7.188	7.906	8.625	9.344	10.06	10.78	11.50		
$11\frac{3}{4}$.734	1.469	2.203	2.938	3.672	4.406	5.141	5.875	6.609	7.344	8.078	8.813	9.547	10.28	11.02	11.75		
12	.750	1.500	2.250	3.000	3.750	4.500	5.250	6.000	6.750	7.500	8.250	9.000	9.750	10.50	11.25	12.00		

AREAS OF RECTANGLES

AREAS OF RECTANGULAR SECTIONS—Continued

SQUARE INCHES

Width, Inches	Thickness, Inches															
	$\frac{1}{16}$	$\frac{1}{8}$	$\frac{3}{16}$	$\frac{1}{4}$	$\frac{5}{16}$	$\frac{3}{8}$	$\frac{7}{16}$	$\frac{1}{2}$	$\frac{9}{16}$	$\frac{5}{8}$	$1\frac{1}{16}$	$\frac{3}{4}$	$1\frac{1}{8}$	$\frac{7}{8}$	$1\frac{3}{8}$	1
12½	.781	1.563	2.344	3.13	3.91	4.69	5.47	6.25	7.03	7.81	8.59	9.38	10.16	10.94	11.72	12.50
13	.813	1.625	2.438	3.25	4.06	4.88	5.69	6.50	7.31	8.13	8.94	9.75	10.56	11.38	12.19	13.00
13½	.844	1.688	2.531	3.38	4.22	5.06	5.91	6.75	7.59	8.44	9.28	10.13	10.97	11.81	12.66	13.50
14	.875	1.750	2.625	3.50	4.38	5.25	6.13	7.00	7.88	8.75	9.63	10.50	11.38	12.25	13.13	14.00
14½	.906	1.813	2.719	3.63	4.53	5.44	6.34	7.25	8.16	9.06	9.97	10.88	11.78	12.69	13.59	14.50
15	.938	1.875	2.813	3.75	4.69	5.63	6.56	7.50	8.44	9.38	10.31	11.25	12.19	13.13	14.06	15.00
15½	.969	1.938	2.906	3.88	4.84	5.81	6.78	7.75	8.72	9.69	10.66	11.63	12.59	13.56	14.53	15.50
16	1.000	2.000	3.000	4.00	5.00	6.00	7.00	8.00	9.00	10.00	11.00	12.00	13.00	14.00	15.00	16.00
16½	1.031	2.063	3.094	4.13	5.16	6.19	7.22	8.25	9.28	10.31	11.34	12.38	13.41	14.44	15.47	16.50
17	1.063	2.125	3.188	4.25	5.31	6.38	7.44	8.50	9.56	10.63	11.69	12.75	13.81	14.88	15.94	17.00
17½	1.094	2.188	3.281	4.38	5.47	6.56	7.66	8.75	9.84	10.94	12.03	13.13	14.22	15.31	16.41	17.50
18	1.125	2.250	3.375	4.50	5.63	6.75	7.88	9.00	10.13	11.25	12.38	13.50	14.63	15.75	16.88	18.00
18½	1.156	2.313	3.469	4.63	5.78	6.94	8.09	9.25	10.41	11.56	12.72	13.88	15.03	16.19	17.34	18.50
19	1.188	2.375	3.563	4.75	5.94	7.13	8.31	9.50	10.69	11.88	13.06	14.25	15.44	16.63	17.81	19.00
19½	1.219	2.438	3.656	4.88	6.09	7.31	8.53	9.75	10.97	12.19	13.41	14.63	15.84	17.06	18.28	19.50
20	1.250	2.500	3.750	5.00	6.25	7.50	8.75	10.00	11.25	12.50	13.75	15.00	16.25	17.50	18.75	20.00
20½	1.281	2.563	3.844	5.13	6.41	7.69	8.97	10.25	11.53	12.81	14.09	15.38	16.66	17.94	19.22	20.50
21	1.313	2.625	3.938	5.25	6.56	7.88	9.19	10.50	11.81	13.13	14.44	15.75	17.06	18.38	19.69	21.00
21½	1.344	2.688	4.031	5.38	6.72	8.06	9.41	10.75	12.09	13.44	14.78	16.13	17.47	18.81	20.16	21.50
22	1.375	2.750	4.125	5.50	6.88	8.25	9.63	11.00	12.38	13.75	15.13	16.50	17.88	19.25	20.63	22.00
22½	1.406	2.813	4.219	5.63	7.03	8.44	9.84	11.25	12.66	14.06	15.47	16.88	18.28	19.69	21.09	22.50
23	1.438	2.875	4.313	5.75	7.19	8.63	10.06	11.50	12.94	14.38	15.81	17.25	18.69	20.13	21.56	23.00
23½	1.469	2.938	4.406	5.88	7.34	8.81	10.28	11.75	13.22	14.69	16.16	17.63	19.09	20.56	22.03	23.50
24	1.500	3.000	4.500	6.00	7.50	9.00	10.50	12.00	13.50	15.00	16.50	18.00	19.50	21.00	22.50	24.00
25	1.563	3.125	4.688	6.25	7.81	9.38	10.94	12.50	14.06	15.63	17.19	18.75	20.31	21.88	23.44	25.00
26	1.625	3.250	4.875	6.50	8.13	9.75	11.38	13.00	14.63	16.25	17.88	19.50	21.13	22.75	24.38	26.00
27	1.688	3.375	5.063	6.75	8.44	10.13	11.81	13.50	15.19	16.88	18.56	20.25	21.94	23.63	25.31	27.00
28	1.750	3.500	5.250	7.00	8.75	10.50	12.25	14.00	15.75	17.50	19.25	21.00	22.75	24.50	26.25	28.00
29	1.813	3.625	5.438	7.25	9.06	10.88	12.69	14.50	16.31	18.13	19.94	21.75	23.56	25.38	27.19	29.00
30	1.875	3.750	5.625	7.50	9.38	11.25	13.13	15.00	16.88	18.75	20.63	22.50	24.38	26.25	28.13	30.00
31	1.938	3.875	5.813	7.75	9.69	11.63	13.56	15.50	17.44	19.38	21.31	23.25	25.19	27.13	29.06	31.00
32	2.000	4.000	6.000	8.00	10.00	12.00	14.00	16.00	18.00	20.00	22.00	24.00	26.00	28.00	30.00	32.00
33	2.063	4.125	6.188	8.25	10.31	12.38	14.44	16.50	18.56	20.63	22.69	24.75	26.81	28.88	30.94	33.00
34	2.125	4.250	6.375	8.50	10.63	12.75	14.88	17.00	19.13	21.25	23.38	25.50	27.63	29.75	31.88	34.00
35	2.188	4.375	6.563	8.75	10.94	13.13	15.31	17.50	19.69	21.88	24.06	26.25	28.44	30.63	32.81	35.00
36	2.250	4.500	6.750	9.00	11.25	13.50	15.75	18.00	20.25	22.50	24.75	27.00	29.25	31.50	33.75	36.00
37	2.313	4.625	6.938	9.25	11.56	13.88	16.19	18.50	20.81	23.13	25.44	27.75	30.06	32.38	34.69	37.00
38	2.375	4.750	7.125	9.50	11.88	14.25	16.63	19.00	21.38	23.75	26.13	28.50	30.88	33.25	35.63	38.00
39	2.438	4.875	7.313	9.75	12.19	14.63	17.06	19.50	21.94	24.38	26.81	29.25	31.69	34.13	36.56	39.00
40	2.500	5.000	7.500	10.00	12.50	15.00	17.50	20.00	22.50	25.00	27.50	30.00	32.50	35.00	37.50	40.00
41	2.563	5.125	7.688	10.25	12.81	15.38	17.94	20.50	23.06	25.63	28.19	30.75	33.31	35.88	38.44	41.00
42	2.625	5.250	7.875	10.50	13.13	15.75	18.38	21.00	23.63	26.25	28.88	31.50	34.13	36.75	39.38	42.00
43	2.688	5.375	8.063	10.75	13.44	16.13	18.81	21.50	24.19	26.88	29.56	32.25	34.94	37.63	40.31	43.00
44	2.750	5.500	8.250	11.00	13.75	16.50	19.25	22.00	24.75	27.50	30.25	33.00	35.75	38.50	41.25	44.00
45	2.813	5.625	8.438	11.25	14.06	16.88	19.69	22.50	25.31	28.13	30.94	33.75	36.56	39.38	42.19	45.00
46	2.875	5.750	8.625	11.50	14.38	17.25	20.13	23.00	25.88	28.75	31.63	34.50	37.38	40.25	43.13	46.00
47	2.938	5.875	8.813	11.75	14.69	17.63	20.56	23.50	26.44	29.38	32.31	35.25	38.19	41.13	44.06	47.00
48	3.000	6.000	9.000	12.00	15.00	18.00	21.00	24.00	27.00	30.00	33.00	36.00	39.00	42.00	45.00	48.00

CARNEGIE STEEL COMPANY

AREAS OF RECTANGULAR SECTIONS—Concluded
SQUARE INCHES

Width, Inches	Thickness, Inches																
	1/16	1/8	3/16	1/4	5/16	3/8	7/16	1/2	9/16	5/8	11/16	3/4	13/16	7/8	15/16	1	
49	3.06	6.13	9.19	12.25	15.31	18.38	21.44	24.50	27.56	30.63	33.69	36.75	39.81	42.88	45.94	49.00	
50	3.13	6.25	9.38	12.50	15.63	18.75	21.88	25.00	28.13	31.25	34.38	37.50	40.63	43.75	46.88	50.00	
51	3.19	6.38	9.56	12.75	15.94	19.13	22.31	25.50	28.69	31.88	35.06	38.25	41.44	44.63	47.81	51.00	
52	3.25	6.50	9.75	13.00	16.25	19.50	22.75	26.00	29.25	32.50	35.75	39.00	42.25	45.50	48.75	52.00	
53	3.31	6.63	9.94	13.25	16.56	19.88	23.19	26.50	29.81	33.13	36.44	39.75	43.06	46.38	49.69	53.00	
54	3.38	6.75	10.13	13.50	16.88	20.25	23.63	27.00	30.38	33.75	37.13	40.50	43.88	47.25	50.63	54.00	
55	3.44	6.88	10.31	13.75	17.19	20.63	24.06	27.50	30.94	34.38	37.81	41.25	44.69	48.13	51.56	55.00	
56	3.50	7.00	10.50	14.00	17.50	21.00	24.50	28.00	31.50	35.00	38.50	42.00	45.50	49.00	52.50	56.00	
57	3.56	7.13	10.69	14.25	17.81	21.38	24.94	28.50	32.06	35.63	39.19	42.75	46.31	49.88	53.44	57.00	
58	3.63	7.25	10.88	14.50	18.13	21.75	25.38	29.00	32.63	36.25	39.88	43.50	47.13	50.75	54.38	58.00	
59	3.69	7.38	11.06	14.75	18.44	22.13	25.81	29.50	33.19	36.88	40.56	44.25	47.94	51.63	55.31	59.00	
60	3.75	7.50	11.25	15.00	18.75	22.50	26.25	30.00	33.75	37.50	41.25	45.00	48.75	52.50	56.25	60.00	
61	3.81	7.63	11.44	15.25	19.06	22.88	26.69	30.50	34.31	38.13	41.94	45.75	49.50	53.38	57.19	61.00	
62	3.88	7.75	11.63	15.50	19.38	23.25	27.13	31.00	34.88	38.75	42.63	46.50	50.38	54.25	58.13	62.00	
63	3.94	7.88	11.81	15.75	19.69	23.63	27.56	31.50	35.44	39.38	43.31	47.25	51.19	55.13	59.06	63.00	
64	4.00	8.00	12.00	16.00	20.00	24.00	28.00	32.00	36.00	40.00	44.00	48.00	52.00	56.00	60.00	64.00	
65	4.06	8.13	12.19	16.25	20.31	24.38	28.44	32.50	36.56	40.63	44.69	48.75	52.81	56.88	60.94	65.00	
66	4.13	8.25	12.38	16.50	20.63	24.75	28.88	33.00	37.13	41.25	45.38	49.50	53.63	57.75	61.88	66.00	
67	4.19	8.38	12.56	16.75	20.94	25.13	29.31	33.50	37.69	41.88	46.06	50.25	54.44	58.63	62.81	67.00	
68	4.25	8.50	12.75	17.00	21.25	25.50	29.75	34.00	38.25	42.50	46.75	51.00	55.25	59.50	63.75	68.00	
69	4.31	8.63	12.94	17.25	21.56	25.88	30.19	34.50	38.81	43.13	47.44	51.75	56.06	60.38	64.69	69.00	
70	4.38	8.75	13.13	17.50	21.88	26.25	30.63	35.00	39.38	43.75	48.13	52.50	56.88	61.25	65.63	70.00	
71	4.44	8.88	13.31	17.75	22.19	26.63	31.06	35.50	39.94	44.38	48.81	53.25	57.69	62.13	66.56	71.00	
72	4.50	9.00	13.50	18.00	22.50	27.00	31.50	36.00	40.50	45.00	49.50	54.00	58.50	63.00	67.50	72.00	
73	4.56	9.13	13.69	18.25	22.81	27.38	31.94	36.50	41.06	45.63	50.19	54.75	59.31	63.88	68.44	73.00	
74	4.63	9.25	13.88	18.50	23.13	27.75	32.38	37.00	41.63	46.25	50.88	55.50	60.13	64.75	69.38	74.00	
75	4.69	9.38	14.06	18.75	23.44	28.13	32.81	37.50	42.19	46.88	51.56	56.25	60.94	65.63	70.31	75.00	
76	4.75	9.50	14.25	19.00	23.75	28.50	33.25	38.00	42.75	47.50	52.25	57.00	61.75	66.50	71.25	76.00	
77	4.81	9.63	14.44	19.25	24.06	28.88	33.69	38.50	43.31	48.13	52.94	57.75	62.56	67.38	72.19	77.00	
78	4.88	9.75	14.63	19.50	24.38	29.25	34.13	39.00	43.88	48.75	53.63	58.50	63.38	68.25	73.13	78.00	
79	4.94	9.88	14.81	19.75	24.69	29.63	34.56	39.50	44.44	49.38	54.31	59.25	64.19	69.13	74.06	79.00	
80	5.00	10.00	15.00	20.00	25.00	30.00	35.00	40.00	45.00	50.00	55.00	60.00	65.00	70.00	75.00	80.00	
81	5.06	10.13	15.19	20.25	25.31	30.38	35.44	40.50	45.56	50.63	55.69	60.75	65.81	70.88	75.94	81.00	
82	5.13	10.25	15.38	20.50	25.63	30.75	35.88	41.00	46.13	51.25	56.38	61.50	66.63	71.75	76.88	82.00	
83	5.19	10.38	15.56	20.75	25.94	31.13	36.31	41.50	46.69	51.88	57.06	62.25	67.44	72.63	77.81	83.00	
84	5.25	10.50	15.75	21.00	26.25	31.50	36.75	42.00	47.25	52.50	57.75	63.00	68.25	73.50	78.75	84.00	
85	5.31	10.63	15.94	21.25	26.56	31.88	37.19	42.50	47.81	53.13	58.44	63.75	69.06	74.38	79.69	85.00	
86	5.38	10.75	16.13	21.50	26.88	32.25	37.63	43.00	48.38	53.75	59.13	64.50	69.88	75.25	80.63	86.00	
87	5.44	10.88	16.31	21.75	27.19	32.63	38.06	43.50	48.94	54.38	59.81	65.25	70.69	76.13	81.56	87.00	
88	5.50	11.00	16.50	22.00	27.50	33.00	38.50	44.00	49.50	55.00	60.50	66.00	71.50	77.00	82.50	88.00	
89	5.56	11.13	16.69	22.25	27.81	33.38	38.94	44.50	50.06	55.63	61.19	66.75	72.31	77.88	83.44	89.00	
90	5.63	11.25	16.88	22.50	28.13	33.75	39.38	45.00	50.63	56.25	61.88	67.50	73.13	78.75	84.38	90.00	
91	5.69	11.38	17.06	22.75	28.44	34.13	39.81	45.50	51.19	56.88	62.56	68.25	73.94	79.63	85.31	91.00	
92	5.75	11.50	17.25	23.00	28.75	34.50	40.25	46.00	51.75	57.50	63.25	69.00	74.75	80.50	86.25	92.00	
93	5.81	11.63	17.44	23.25	29.06	34.88	40.69	46.50	52.31	58.13	63.94	69.75	75.56	81.38	87.19	93.00	
94	5.88	11.75	17.63	23.50	29.38	35.25	41.13	47.00	52.88	58.75	64.63	70.50	76.38	82.25	88.13	94.00	
95	5.94	11.88	17.81	23.75	29.69	35.63	41.56	47.50	53.44	59.38	65.31	71.25	77.19	83.13	89.06	95.00	
96	6.00	12.00	18.00	24.00	30.00	36.00	42.00	48.00	54.00	60.00	66.00	72.00	78.00	84.00	90.00	96.00	
97	6.06	12.13	18.19	24.25	30.31	36.38	42.44	48.50	54.56	60.63	66.69	72.75	78.81	84.88	90.94	97.00	
98	6.13	12.25	18.38	24.50	30.63	36.75	42.88	49.00	55.13	61.25	67.38	73.50	79.63	85.75	91.88	98.00	
99	6.19	12.38	18.56	24.75	30.94	37.13	43.31	49.50	55.69	61.88	68.06	74.25	80.44	86.63	92.81	99.00	
100	6.25	12.50	18.75	25.00	31.25	37.50	43.75	50.00	56.25	62.50	68.75	75.00	81.25	87.50	93.75	100.0	

MERCHANT BARS

SQUARES

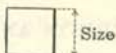

Size $\frac{1}{4}$ " to 2", inclusive, advancing by 64ths.

Size $2\frac{1}{32}$ " to $3\frac{1}{2}$ ", inclusive, advancing by 32ds.

Size $3\frac{3}{16}$ " to $5\frac{1}{2}$ ", inclusive, advancing by 16ths.

Squares can also be rolled to decimal dimensions, if so arranged.

Squares $\frac{1}{8}$ " and smaller can be furnished in coils.

ROUND CORNERED SQUARES

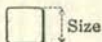

Size $\frac{1}{4}$ " to $\frac{3}{4}$ ", inclusive, advancing by 64ths.

ROUNDS

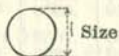

Size $\frac{1}{4}$ " to $1\frac{3}{4}$ ", inclusive, advancing by 64ths.

Size $1\frac{29}{32}$ " to $3\frac{1}{4}$ ", inclusive, advancing by 32ds.

Size $3\frac{3}{16}$ " to 7", inclusive, advancing by 16ths.

Rounds can also be rolled to decimal dimensions, if so arranged.

Rounds $\frac{1}{8}$ " and smaller can be furnished in coils.

HALF ROUNDS



Size $\frac{3}{8}$ " to $\frac{1}{2}$ ", inclusive, advancing by 64ths.

Size $1\frac{1}{16}$ " to $1\frac{3}{4}$ ", inclusive, advancing by 16ths.

Size 2", $2\frac{1}{2}$ ", 3".

HEXAGONS

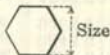

Size $\frac{3}{8}$ " to $1\frac{1}{16}$ ", inclusive, advancing by 32ds.

Size $1\frac{1}{4}$ " to $3\frac{3}{16}$ ", inclusive, advancing by 16ths.

CARNEGIE STEEL COMPANY

SQUARE AND ROUND BARS

WEIGHTS AND AREAS

Size, Inches	Weight, Lbs. per Foot		Area, Square Inches		Size, Inches	Weight, Lbs. per Foot		Area, Square Inches	
	□	○	□	○		□	○	□	○
0					3	30.60	24.03	9.000	7.069
1/16	.013	.010	.0039	.0031	1/16	31.89	25.05	9.379	7.366
1/8	.053	.042	.0156	.0123	1/8	33.20	26.08	9.766	7.670
3/16	.120	.094	.0352	.0276	3/16	34.54	27.13	10.160	7.980
1/4	.213	.167	.0625	.0491	1/4	35.91	28.21	10.563	8.296
5/16	.332	.261	.0977	.0767	5/16	37.31	29.30	10.973	8.618
3/8	.478	.376	.1406	.1105	3/8	38.73	30.42	11.391	8.946
7/16	.651	.511	.1914	.1503	7/16	40.18	31.55	11.816	9.281
1/2	.850	.668	.2500	.1963	1/2	41.65	32.71	12.250	9.621
9/16	1.076	.845	.3164	.2485	9/16	43.15	33.89	12.691	9.968
5/8	1.328	1.043	.3906	.3068	5/8	44.68	35.09	13.141	10.321
11/16	1.607	1.262	.4727	.3712	11/16	46.23	36.31	13.598	10.680
3/4	1.913	1.502	.5625	.4418	3/4	47.81	37.55	14.063	11.045
13/16	2.245	1.763	.6602	.5185	13/16	49.42	38.81	14.535	11.416
7/8	2.603	2.044	.7656	.6013	7/8	51.05	40.10	15.016	11.793
15/16	2.988	2.347	.8789	.6903	15/16	52.71	41.40	15.504	12.177
1	3.400	2.670	1.0000	.7854	4	54.40	42.73	16.000	12.566
1/16	3.838	3.015	1.1289	.8866	1/16	56.11	44.07	16.504	12.962
1/8	4.303	3.380	1.2656	.9940	1/8	57.85	45.44	17.016	13.364
3/16	4.795	3.766	1.4102	1.1075	3/16	59.62	46.83	17.535	13.772
1/4	5.313	4.172	1.5625	1.2272	1/4	61.41	48.23	18.063	14.186
5/16	5.857	4.600	1.7227	1.3530	5/16	63.23	49.66	18.598	14.607
3/8	6.428	5.049	1.8906	1.4849	3/8	65.08	51.11	19.141	15.033
7/16	7.026	5.518	2.0664	1.6230	7/16	66.95	52.58	19.691	15.466
1/2	7.650	6.008	2.2500	1.7671	1/2	68.85	54.07	20.250	15.904
9/16	8.301	6.519	2.4414	1.9175	9/16	70.78	55.59	20.816	16.349
5/8	8.978	7.051	2.6406	2.0739	5/8	72.73	57.12	21.391	16.800
11/16	9.682	7.604	2.8477	2.2365	11/16	74.71	58.67	21.973	17.257
3/4	10.413	8.178	3.0625	2.4053	3/4	76.71	60.25	22.563	17.721
13/16	11.170	8.773	3.2852	2.5802	13/16	78.74	61.85	23.160	18.190
7/8	11.953	9.388	3.5156	2.7612	7/8	80.80	63.46	23.766	18.665
15/16	12.763	10.024	3.7539	2.9483	15/16	82.89	65.10	24.379	19.147
2	13.600	10.681	4.0000	3.1416	5	85.00	66.76	25.000	19.635
1/16	14.463	11.359	4.2539	3.3410	1/16	87.14	68.44	25.629	20.129
1/8	15.353	12.058	4.5156	3.5466	1/8	89.30	70.14	26.266	20.629
3/16	16.270	12.778	4.7852	3.7583	3/16	91.49	71.86	26.910	21.135
1/4	17.213	13.519	5.0625	3.9761	1/4	93.71	73.60	27.563	21.648
5/16	18.182	14.280	5.3477	4.2000	5/16	95.96	75.36	28.223	22.166
3/8	19.178	15.062	5.6406	4.4301	3/8	98.23	77.15	28.891	22.691
7/16	20.201	15.866	5.9414	4.6664	7/16	100.53	78.95	29.566	23.221
1/2	21.250	16.690	6.2500	4.9087	1/2	102.85	80.78	30.250	23.758
9/16	22.326	17.534	6.5664	5.1572	9/16	105.20	82.62	30.941	24.301
5/8	23.428	18.400	6.8906	5.4119	5/8	107.58	84.49	31.641	24.850
11/16	24.557	19.287	7.2227	5.6727	11/16	109.98	86.38	32.348	25.406
3/4	25.713	20.195	7.5625	5.9396	3/4	112.41	88.29	33.063	25.967
13/16	26.895	21.123	7.9102	6.2126	13/16	114.87	90.22	33.785	26.535
7/8	28.103	22.072	8.2656	6.4918	7/8	117.35	92.17	34.516	27.109
15/16	29.338	23.042	8.6289	6.7771	15/16	119.86	94.14	35.254	27.688
3	30.600	24.033	9.0000	7.0686	6	122.40	96.13	36.000	28.274

WEIGHTS OF BAR

SQUARE AND ROUND BARS

WEIGHTS AND AREAS

Size, Inches	Weight, Lbs. per Foot		Area, Square Inches		Size, Inches	Weight, Lbs. per Foot		Area, Square Inches	
	□	○	□	○		□	○	□	○
6	122.40	96.13	36.000	28.274	9	275.40	216.30	81.000	63.617
1/16	124.96	98.15	36.754	28.866	1/16	279.24	219.31	82.129	64.504
1/8	127.55	100.18	37.516	29.465	1/8	283.10	222.35	83.266	65.397
3/16	130.17	102.23	38.285	30.069	3/16	286.99	225.41	84.410	66.296
1/4	132.81	104.31	39.063	30.680	1/4	290.91	228.48	85.563	67.201
5/16	135.48	106.41	39.848	31.296	5/16	294.86	231.58	86.723	68.112
3/8	138.18	108.53	40.641	31.919	3/8	298.83	234.70	87.891	69.029
7/16	140.90	110.66	41.441	32.548	7/16	302.83	237.84	89.066	69.953
1/2	143.65	112.82	42.250	33.183	1/2	306.85	241.00	90.250	70.882
5/8	146.43	115.00	43.066	33.824	5/8	310.90	244.18	91.441	71.818
3/4	149.23	117.20	43.891	34.472	3/4	314.98	247.38	92.641	72.760
7/8	152.06	119.43	44.723	35.125	7/8	319.08	250.61	93.848	73.708
1 1/16	154.91	121.67	45.563	35.785	1 1/16	323.21	253.85	95.063	74.662
1 1/8	157.79	123.93	46.410	36.450	1 1/8	327.37	257.12	96.285	75.622
1 1/4	160.70	126.22	47.266	37.122	1 1/4	331.55	260.40	97.516	76.589
1 1/2	163.64	128.52	48.129	37.800	1 1/2	335.76	263.71	98.754	77.561
7	166.60	130.85	49.000	38.485	10	340.00	267.04	100.000	78.540
1/16	169.59	133.19	49.879	39.175	1/16	344.26	270.38	101.254	79.525
1/8	172.60	135.56	50.766	39.871	1/8	348.55	273.75	102.516	80.516
3/16	175.64	137.95	51.660	40.574	3/16	352.87	277.14	103.785	81.513
1/4	178.71	140.36	52.563	41.282	1/4	357.21	280.55	105.063	82.516
5/16	181.81	142.79	53.473	41.997	5/16	361.58	283.99	106.348	83.525
3/8	184.93	145.24	54.391	42.718	3/8	365.98	287.44	107.641	84.541
7/16	188.07	147.71	55.316	43.445	7/16	370.40	290.91	108.941	85.563
1/2	191.25	150.21	56.250	44.179	1/2	374.85	294.41	110.250	86.590
5/8	194.45	152.72	57.191	44.918	5/8	379.33	297.92	111.566	87.624
3/4	197.68	155.26	58.141	45.664	3/4	383.83	301.46	112.891	88.664
7/8	200.93	157.81	59.098	46.415	7/8	388.36	305.02	114.223	89.710
1 1/16	204.21	160.39	60.063	47.173	1 1/16	392.91	308.59	115.563	90.763
1 1/8	207.52	162.99	61.035	47.937	1 1/8	397.49	312.19	116.910	91.821
1 1/4	210.85	165.60	62.016	48.707	1 1/4	402.10	315.81	118.266	92.886
1 1/2	214.21	168.24	63.004	49.483	1 1/2	406.74	319.45	119.629	93.957
8	217.60	170.90	64.000	50.265	11	411.40	323.11	121.000	95.033
1/16	221.01	173.58	65.004	51.054	1/16	416.09	326.80	122.379	96.116
1/8	224.45	176.29	66.016	51.849	1/8	420.80	330.50	123.766	97.205
3/16	227.92	179.01	67.035	52.649	3/16	425.54	334.22	125.160	98.301
1/4	231.41	181.75	68.063	53.456	1/4	430.31	337.97	126.563	99.402
5/16	234.93	184.52	69.098	54.269	5/16	435.11	341.73	127.973	100.510
3/8	238.48	187.30	70.141	55.088	3/8	439.93	345.52	129.391	101.623
7/16	242.05	190.11	71.191	55.914	7/16	444.78	349.33	130.816	102.743
1/2	245.65	192.93	72.250	56.745	1/2	449.65	353.16	132.250	103.869
5/8	249.28	195.78	73.316	57.583	5/8	454.55	357.00	133.691	105.001
3/4	252.93	198.65	74.391	58.426	3/4	459.48	360.87	135.141	106.139
7/8	256.61	201.54	75.473	59.276	7/8	464.43	364.76	136.598	107.284
1 1/16	260.31	204.45	76.563	60.132	1 1/16	469.41	368.68	138.063	108.434
1 1/8	264.04	207.38	77.660	60.994	1 1/8	474.42	372.61	139.535	109.591
1 1/4	267.80	210.33	78.766	61.863	1 1/4	479.45	376.56	141.016	110.754
1 1/2	271.59	213.31	79.879	62.737	1 1/2	484.51	380.54	142.504	111.923
9	275.40	216.30	81.000	63.617	12	489.60	384.53	144.000	113.098

CARNEGIE STEEL COMPANY

CONCRETE REINFORCEMENT BARS

COLD TWISTED SQUARE BARS

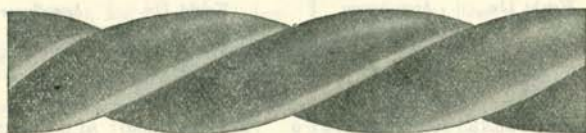

Section Index	Size, Inches	Weight per Foot, Pounds	Section Index	Size, Inches	Weight per Foot, Pounds
			$\frac{7}{8}$	0.7656	2.603
2	4.0000	13.600	$1\frac{1}{16}$	0.6602	2.245
$1\frac{1}{8}$	3.5156	11.953	$\frac{3}{4}$	0.5625	1.913
$1\frac{1}{4}$	3.0625	10.413	$1\frac{1}{16}$	0.4727	1.607
$1\frac{5}{8}$	2.6406	8.978	$\frac{5}{8}$	0.3906	1.328
$1\frac{1}{2}$	2.2500	7.650	$\frac{9}{16}$	0.3164	1.076
$1\frac{3}{8}$	1.8906	6.428	$\frac{1}{2}$	0.2500	0.850
$1\frac{1}{4}$	1.5625	5.313	$\frac{7}{16}$	0.1914	0.651
$1\frac{1}{8}$	1.2656	4.303	$\frac{3}{8}$	0.1406	0.478
1	1.0000	3.400	$\frac{5}{16}$	0.0977	0.332
$\frac{15}{16}$	0.8789	2.988	$\frac{1}{4}$	0.0625	0.213

Cold twisted bars will conform to Manufacturers' Standard Specifications, unless otherwise specified.

CUP BARS



Section Index	Size, Inches	Weight per Foot, Pounds	Section Index	Size, Inches	Weight per Foot, Pounds
*M 1528	$1\frac{1}{2}$	7.65	*M 1533	$\frac{7}{8}$	2.60
*M 1530	$1\frac{1}{4}$	5.31	*M 1534	$\frac{3}{4}$	1.91
*M 1531	$1\frac{1}{8}$	4.30	*M 1535	$\frac{5}{8}$	1.33
*M 1532	1	3.40	*M 1536	$\frac{1}{2}$	0.85
			*M 1537	$\frac{3}{8}$	0.48

* Furnished only by special arrangement.

CARNEGIE STEEL COMPANY

A. S. C. E. RAILS AND LIGHT RAILS

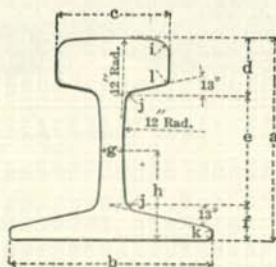

Section Index	Weight per Yard, Pounds	a	b	c	d	e	f	g	h	i	j	k	l
		In.	In.	In.	In.	In.	In.	In.	In.	In.	In.	In.	In.
10040	100	5 $\frac{3}{4}$	5 $\frac{3}{4}$	2 $\frac{3}{4}$	14 $\frac{5}{64}$	3 $\frac{5}{64}$	21 $\frac{3}{32}$	5 $\frac{1}{16}$	2 $\frac{55}{128}$	5 $\frac{1}{16}$	1 $\frac{1}{4}$	1 $\frac{1}{16}$	1 $\frac{1}{16}$
9040	90	5 $\frac{3}{8}$	5 $\frac{3}{8}$	2 $\frac{5}{8}$	11 $\frac{19}{32}$	2 $\frac{55}{64}$	17 $\frac{5}{64}$	5 $\frac{9}{64}$	2 $\frac{45}{128}$	5 $\frac{1}{16}$	1 $\frac{1}{4}$	1 $\frac{1}{16}$	1 $\frac{1}{16}$
8540	85	5 $\frac{1}{16}$	5 $\frac{1}{16}$	2 $\frac{1}{16}$	13 $\frac{59}{64}$	2 $\frac{3}{4}$	17 $\frac{5}{64}$	5 $\frac{9}{64}$	2 $\frac{17}{64}$	5 $\frac{1}{16}$	1 $\frac{1}{4}$	1 $\frac{1}{16}$	1 $\frac{1}{16}$
8040	80	5	5	2 $\frac{1}{2}$	11 $\frac{1}{2}$	2 $\frac{5}{8}$	17 $\frac{3}{8}$	5 $\frac{7}{8}$	2 $\frac{5}{64}$	5 $\frac{1}{16}$	1 $\frac{1}{4}$	1 $\frac{1}{16}$	1 $\frac{1}{16}$
7540	75	4 $\frac{13}{16}$	4 $\frac{13}{16}$	2 $\frac{19}{32}$	12 $\frac{7}{64}$	2 $\frac{55}{64}$	17 $\frac{3}{32}$	5 $\frac{17}{32}$	2 $\frac{15}{128}$	5 $\frac{1}{16}$	1 $\frac{1}{4}$	1 $\frac{1}{16}$	1 $\frac{1}{16}$
7040	70	4 $\frac{5}{8}$	4 $\frac{5}{8}$	2 $\frac{7}{16}$	11 $\frac{13}{32}$	2 $\frac{15}{32}$	17 $\frac{1}{16}$	5 $\frac{33}{64}$	2 $\frac{3}{64}$	5 $\frac{1}{16}$	1 $\frac{1}{4}$	1 $\frac{1}{16}$	1 $\frac{1}{16}$
6540	65	4 $\frac{7}{16}$	4 $\frac{7}{16}$	2 $\frac{19}{32}$	11 $\frac{9}{32}$	2 $\frac{3}{8}$	17 $\frac{5}{32}$	5 $\frac{1}{2}$	1 $\frac{13}{32}$	5 $\frac{1}{16}$	1 $\frac{1}{4}$	1 $\frac{1}{16}$	1 $\frac{1}{16}$
6040	60	4 $\frac{1}{4}$	4 $\frac{1}{4}$	2 $\frac{3}{8}$	11 $\frac{3}{32}$	2 $\frac{17}{64}$	17 $\frac{49}{64}$	5 $\frac{31}{64}$	1 $\frac{113}{128}$	5 $\frac{1}{16}$	1 $\frac{1}{4}$	1 $\frac{1}{16}$	1 $\frac{1}{16}$
5540	55	4 $\frac{1}{16}$	4 $\frac{1}{16}$	2 $\frac{1}{4}$	11 $\frac{1}{64}$	2 $\frac{11}{64}$	17 $\frac{23}{32}$	5 $\frac{15}{32}$	1 $\frac{103}{128}$	5 $\frac{1}{16}$	1 $\frac{1}{4}$	1 $\frac{1}{16}$	1 $\frac{1}{16}$
5040	50	3 $\frac{3}{8}$	3 $\frac{3}{8}$	2 $\frac{1}{8}$	11 $\frac{1}{8}$	2 $\frac{1}{16}$	17 $\frac{1}{16}$	5 $\frac{7}{16}$	1 $\frac{23}{32}$	5 $\frac{1}{16}$	1 $\frac{1}{4}$	1 $\frac{1}{16}$	1 $\frac{1}{16}$
4540	45	3 $\frac{11}{16}$	3 $\frac{11}{16}$	2	11 $\frac{1}{16}$	1 $\frac{13}{32}$	17 $\frac{21}{32}$	5 $\frac{27}{64}$	1 $\frac{41}{64}$	5 $\frac{1}{16}$	1 $\frac{1}{4}$	1 $\frac{1}{16}$	1 $\frac{1}{16}$
4040	40	3 $\frac{1}{2}$	3 $\frac{1}{2}$	1 $\frac{7}{8}$	11 $\frac{1}{64}$	1 $\frac{55}{64}$	17 $\frac{9}{8}$	5 $\frac{25}{64}$	1 $\frac{171}{128}$	5 $\frac{1}{16}$	1 $\frac{1}{4}$	1 $\frac{1}{16}$	1 $\frac{1}{16}$
3540	35	3 $\frac{5}{16}$	3 $\frac{5}{16}$	1 $\frac{3}{4}$	11 $\frac{61}{64}$	1 $\frac{25}{32}$	17 $\frac{27}{64}$	5 $\frac{23}{64}$	1 $\frac{153}{32}$	5 $\frac{1}{16}$	1 $\frac{1}{4}$	1 $\frac{1}{16}$	1 $\frac{1}{16}$
3040	30	3 $\frac{1}{16}$	3 $\frac{1}{16}$	1 $\frac{11}{16}$	11 $\frac{7}{16}$	1 $\frac{23}{32}$	17 $\frac{17}{32}$	5 $\frac{21}{64}$	1 $\frac{135}{64}$	5 $\frac{1}{16}$	1 $\frac{1}{4}$	1 $\frac{1}{16}$	1 $\frac{1}{16}$
2540	25	2 $\frac{3}{4}$	2 $\frac{3}{4}$	1 $\frac{1}{2}$	11 $\frac{29}{32}$	1 $\frac{131}{64}$	17 $\frac{31}{64}$	5 $\frac{19}{64}$	1 $\frac{129}{128}$	5 $\frac{1}{16}$	1 $\frac{1}{4}$	1 $\frac{1}{16}$	1 $\frac{1}{16}$
2040	20	2 $\frac{5}{8}$	2 $\frac{5}{8}$	1 $\frac{13}{32}$	11 $\frac{13}{32}$	1 $\frac{119}{32}$	17 $\frac{7}{16}$	5 $\frac{1}{4}$	1 $\frac{111}{64}$	5 $\frac{1}{16}$	1 $\frac{1}{4}$	1 $\frac{1}{16}$	1 $\frac{1}{16}$
1640	16	2 $\frac{3}{8}$	2 $\frac{3}{8}$	1 $\frac{11}{64}$	11 $\frac{43}{64}$	1 $\frac{23}{64}$	17 $\frac{3}{8}$	5 $\frac{7}{32}$	1 $\frac{71}{128}$	5 $\frac{1}{16}$	1 $\frac{1}{16}$	1 $\frac{1}{16}$	1 $\frac{1}{16}$
1440	14	2 $\frac{1}{16}$	2 $\frac{1}{16}$	1 $\frac{1}{16}$	11 $\frac{5}{16}$	1 $\frac{17}{32}$	17 $\frac{11}{32}$	5 $\frac{1}{4}$	1 $\frac{57}{64}$	5 $\frac{1}{16}$	1 $\frac{1}{16}$	1 $\frac{1}{16}$	1 $\frac{1}{16}$
1240	12	2	2	1	11 $\frac{9}{16}$	1 $\frac{17}{32}$	17 $\frac{11}{32}$	5 $\frac{3}{16}$	1 $\frac{57}{64}$	5 $\frac{1}{16}$	1 $\frac{1}{16}$	1 $\frac{1}{16}$	1 $\frac{1}{16}$
1040	10	1 $\frac{3}{4}$	1 $\frac{3}{4}$	1 $\frac{15}{16}$	11 $\frac{15}{16}$	1 $\frac{19}{64}$	17 $\frac{19}{64}$	5 $\frac{1}{16}$	1 $\frac{49}{64}$	5 $\frac{1}{16}$	1 $\frac{1}{16}$	1 $\frac{1}{16}$	1 $\frac{1}{16}$
840	8	1 $\frac{1}{16}$	1 $\frac{1}{16}$	1 $\frac{1}{16}$	11 $\frac{15}{32}$	1 $\frac{13}{16}$	17 $\frac{9}{32}$	5 $\frac{5}{32}$	1 $\frac{11}{16}$	5 $\frac{1}{16}$	1 $\frac{1}{16}$	1 $\frac{1}{16}$	1 $\frac{1}{16}$

RAILS AND SPLICE BARS

SPLICE BARS

A. S. C. E. RAILS AND LIGHT RAILS

S 10040 to S 5540

S 5040 to S 3040

S 2540

S 2040

S 1640 to S 840

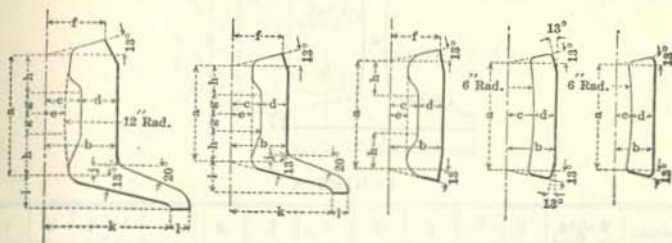

Section Index	Weight per Foot, Unfinished Pounds	a	b	c	d	e	f	g	h	i	j	k	l
		In.	In.	In.	In.	In.	In.	In.	In.	In.	In.	In.	In.
S 10040	15.8	3 ⁵ / ₆₄	1 ²³ / ₃₂	2 ⁷ / ₃₂	5 ⁵ / ₁₆	1 ⁵ / ₁₆	1 ³ / ₈	1 ¹ / ₂	1 ⁵ / ₁₂₈	2 ⁷ / ₃₂	9 ⁵ / ₃₂	3 ¹ / ₈	1 ¹ / ₂
S 9040	13.5	2 ⁵⁵ / ₆₄	1 ⁵ / ₈	1 ³ / ₁₆	1 ³ / ₁₆	1 ⁵ / ₁₆	1 ⁵ / ₁₆	1 ¹ / ₂	1 ¹⁹ / ₁₂₈	5 ¹ / ₆₄	1 ⁵ / ₆₄	2 ¹⁵ / ₁₆	1 ¹ / ₂
S 8540	12.4	2 ³ / ₄	1 ³⁷ / ₆₄	5 ¹ / ₆₄	2 ⁷ / ₃₂	1 ⁵ / ₁₆	1 ⁵ / ₁₆	1 ¹ / ₂	7 ⁵ / ₈	4 ⁹ / ₆₄	7 ⁵ / ₃₂	2 ⁷ / ₃₂	1 ¹ / ₂
S 8040	11.5	2 ⁵ / ₈	1 ¹⁷ / ₃₂	2 ⁵ / ₃₂	3 ¹ / ₄	2 ⁹ / ₆₄	1 ¹ / ₄	7 ¹ / ₁₆	7 ⁵ / ₈	3 ¹ / ₄	5 ¹ / ₁₆	2 ³ / ₄	7 ¹ / ₁₆
S 7540	10.7	2 ²⁵ / ₆₄	1 ³¹ / ₆₄	4 ⁹ / ₆₄	2 ³ / ₃₂	7 ¹ / ₁₆	1 ¹⁵ / ₆₄	7 ¹ / ₁₆	1 ⁶⁷ / ₁₂₈	2 ³ / ₃₂	2 ¹ / ₁₂₈	2 ¹ / ₃₂	7 ¹ / ₁₆
S 7040	10.0	2 ¹⁵ / ₃₂	1 ²⁷ / ₆₄	4 ⁷ / ₆₄	1 ¹ / ₁₆	2 ⁷ / ₆₄	1 ⁷ / ₃₂	7 ¹ / ₁₆	5 ¹ / ₆₄	2 ³ / ₃₂	1 ¹ / ₆₄	2 ¹ / ₃₂	7 ¹ / ₁₆
S 6540	9.2	2 ³ / ₈	1 ²³ / ₆₄	4 ⁵ / ₆₄	2 ¹ / ₃₂	1 ³ / ₁₆	1 ³ / ₁₆	7 ¹ / ₁₆	3 ¹ / ₄	1 ¹ / ₁₆	5 ⁵ / ₃₂	2 ¹ / ₃₂	7 ¹ / ₁₆
S 6040	8.4	2 ¹⁷ / ₆₄	1 ¹⁹ / ₆₄	4 ³ / ₆₄	5 ⁵ / ₁₆	2 ⁵ / ₆₄	1 ³ / ₁₆	7 ¹ / ₁₆	8 ⁹ / ₁₂₈	4 ³ / ₆₄	2 ¹ / ₁₂₈	2 ⁵ / ₁₆	3 ⁵ / ₈
S 5540	7.5	2 ¹ / ₁₆	1 ¹⁵ / ₆₄	4 ¹ / ₆₄	1 ³ / ₃₂	9 ⁵ / ₁₆	1 ³ / ₈	7 ¹ / ₁₆	8 ⁵ / ₁₂₈	5 ⁵ / ₃₂	5 ⁵ / ₃₂	2 ⁷ / ₃₂	3 ⁵ / ₈
S 5040	6.6	2 ¹ / ₁₆	1 ¹ / ₈	1 ⁹ / ₃₂	1 ⁷ / ₃₂	3 ⁵ / ₈	1 ³ / ₈	1 ³ / ₁₆	5 ⁵ / ₈	5 ⁵ / ₈	9 ⁵ / ₆₄	2 ¹ / ₁₆	3 ⁵ / ₈
S 4540	5.8	1 ³¹ / ₆₄	1 ³ / ₆₄	3 ⁵ / ₆₄	1 ¹ / ₂	2 ⁹ / ₆₄	8 ¹ / ₃₂	1 ³ / ₁₆	3 ⁷ / ₆₄	1 ⁹ / ₃₂	7 ⁵ / ₆₄	1 ³ / ₁₆	3 ⁵ / ₈
S 4040	5.0	1 ⁵ / ₆₄	3 ¹ / ₃₂	1 ¹ / ₂	1 ⁵ / ₃₂	1 ¹ / ₃₂	2 ⁹ / ₃₂	1 ³ / ₁₆	6 ⁷ / ₁₂₈	9 ¹ / ₁₆	9 ¹ / ₁₂₈	1 ⁷ / ₈	5 ¹ / ₁₆
S 3540	4.6	1 ²⁵ / ₃₂	2 ⁷ / ₆₄	2 ⁹ / ₆₄	7 ¹ / ₁₆	5 ¹ / ₁₆	2 ⁷ / ₃₂	1 ¹ / ₁₆	2 ⁵ / ₆₄	3 ³ / ₆₄	7 ⁵ / ₆₄	1 ² / ₃₂	5 ¹ / ₁₆
S 3040	3.97	1 ²³ / ₃₂	2 ⁷ / ₃₂	7 ¹ / ₁₆	1 ³ / ₁₆	5 ¹ / ₁₆	2 ⁵ / ₃₂	1 ³ / ₁₆	2 ⁹ / ₆₄	1 ¹ / ₂	5 ⁵ / ₆₄	1 ¹ / ₁₆	5 ¹ / ₁₆
S 2540	2.20	1 ³¹ / ₆₄	3 ¹ / ₄	1 ³ / ₃₂	1 ¹ / ₃₂	9 ⁵ / ₃₂	1 ¹ / ₁₆	9 ⁵ / ₃₂	5 ⁹ / ₁₂₈				
S 2040	1.87	1 ¹⁵ / ₃₂	1 ¹ / ₁₆	3 ⁵ / ₈	5 ¹ / ₁₆								
S 1640	1.70	1 ²³ / ₆₄	2 ⁷ / ₆₄	1 ⁷ / ₆₄	2 ⁵ / ₁₆								
S 1440	1.36	1 ³ / ₃₂	1 ⁷ / ₃₂	7 ⁵ / ₃₂	5 ¹ / ₁₆								
S 1240	1.36	1 ³ / ₃₂	1 ⁷ / ₃₂	7 ⁵ / ₃₂	5 ¹ / ₁₆								
S 1040	0.99	1 ⁵ / ₁₆	1 ⁵ / ₃₂	7 ⁵ / ₃₂	3 ¹ / ₄								
S 840	0.75	1 ³ / ₁₆	7 ¹ / ₁₆	7 ⁵ / ₃₂	7 ⁵ / ₃₂								

Splice Bars S 10040 to S 5040, inclusive, are for A. S. C. E. Rails.

Splice Bars S 4540 to S 840, inclusive, are for Light Rails.

AMERICAN RAILWAY ASSOCIATION RAILS

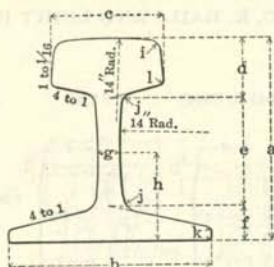

SERIES A

Section Index	Weight per Yard, Pounds	a	b	c	d	e	f	g	h	i	j	k	l
		In.	In.	In.	In.	In.	In.	In.	In.	In.	In.	In.	In.
10020	100	6	5½	2¾	1¾ ₁₆	3¾	1¼ ₁₆	¾ ₁₆	2¼ ₁₆	¾	¾	¼ ₁₆	¼ ₁₆
9020	90	5¾	5½	2¾ ₁₆	1½ ₁₆	3¾ ₂	1	¾ ₁₆	2 ²⁹ / ₃₂	¾	¾	¼ ₁₆	¼ ₁₆
8020	80	5½	4¾	2½	1¾ ₁₆	2 ²³ / ₃₂	¾ ₁₆	¾ ₁₆	2 ²⁹ / ₃₂	¾	¾	¼ ₁₆	¼ ₁₆
7020	70	4¾	4¼	2¾	1½ ₁₆	2½	¾ ₁₆	¾	2¼ ₁₆	¾	¾	¼ ₁₆	¼ ₁₆
6020	60	4½	4	2¼	1½ ₁₆	2 ²⁹ / ₆₄	¾ ₁₆	1 ⁵ / ₃₂	2¼ ₆₄	¾	¾	¼ ₁₆	¼ ₁₆

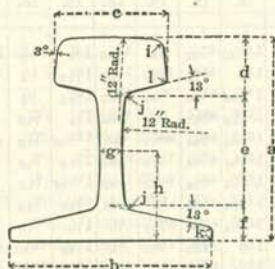

SERIES B

Section Index	Weight per Yard, Pounds	a	b	c	d	e	f	g	h	i	j	k	l
		In.	In.	In.	In.	In.	In.	In.	In.	In.	In.	In.	In.
10030	100	5¼ ₆₄	5 ⁹ / ₆₄	2 ²¹ / ₃₂	1 ⁴ / ₆₄	2 ⁵ / ₆₄	1 ⁵ / ₆₄	¾ ₁₆	2 ⁶⁵ / ₁₂₈	¾	¾	¼ ₁₆	¼ ₁₆
9030	90	5¼ ₆₄	4 ⁴⁹ / ₆₄	2 ⁹ / ₁₆	1 ³⁹ / ₆₄	2 ⁵ / ₁₆	1 ¹³ / ₃₂	¾ ₁₆	2 ¹¹ / ₃₂	¾	¾	¼ ₁₆	¼ ₁₆
8030	80	4 ¹⁹ / ₁₆	4 ⁷ / ₁₆	2 ⁷ / ₁₆	1 ¹⁵ / ₃₂	2 ¹⁹ / ₃₂	1	¾ ₁₆	2 ¹⁵ / ₆₄	¾	¾	¼ ₁₆	¼ ₁₆
*7030	70	4 ³⁵ / ₆₄	4 ³ / ₆₄	2 ³ / ₈	1 ²⁵ / ₆₄	2¼ ₆₄	5 ⁹ / ₆₄	¾ ₁₆	2 ⁷ / ₁₂₈	¾	¾	¼ ₁₆	¼ ₁₆
*6030	60	4 ³ / ₁₆	3 ¹¹ / ₁₆	2½	1¼	2¼ ₁₆	¾	¾ ₁₆	1 ²⁹ / ₃₂	¾	¾	¼ ₁₆	¼ ₁₆

*Not rolled by Carnegie Steel Company.

RAILS AND SPLICE BARS

SPLICE BARS—Concluded

AMERICAN RAILWAY ASSOCIATION RAILS



SERIES A

Section Index	Weight per Foot, Unfinished Pounds	a	b	c	d	e	f	g	g¹	h	i	j	k	l
		In.	In.	In.	In.	In.	In.	In.	In.	In.	In.	In.	In.	In.
S 10020	19.0	3 $\frac{3}{8}$	1 $\frac{39}{32}$	3 $\frac{1}{32}$	3 $\frac{1}{4}$	1 $\frac{5}{32}$	1 $\frac{3}{8}$	1 $\frac{7}{32}$	3 $\frac{1}{4}$	2 $\frac{1}{32}$	1	1 $\frac{5}{32}$	3 $\frac{3}{16}$	7 $\frac{1}{8}$
S 9020	16.6	3 $\frac{5}{32}$	1 $\frac{21}{32}$	1 $\frac{5}{16}$	2 $\frac{3}{32}$	1 $\frac{5}{32}$	1 $\frac{9}{32}$	1 $\frac{11}{32}$	1 $\frac{9}{32}$	9 $\frac{1}{16}$	1 $\frac{5}{16}$	7 $\frac{1}{16}$	3	1 $\frac{3}{16}$
*S 8020	13.4	2 $\frac{29}{32}$	1 $\frac{17}{32}$	7 $\frac{1}{8}$	2 $\frac{1}{32}$	5 $\frac{7}{128}$	1 $\frac{1}{4}$	1 $\frac{5}{64}$	3 $\frac{3}{64}$	2 $\frac{3}{64}$	2 $\frac{9}{32}$	2 $\frac{5}{64}$	2 $\frac{3}{4}$	3 $\frac{1}{4}$
S 7020	11.6	2 $\frac{1}{2}$	1 $\frac{27}{64}$	5 $\frac{1}{64}$	5 $\frac{1}{8}$	1 $\frac{3}{32}$	1 $\frac{3}{16}$	1 $\frac{7}{64}$	3 $\frac{3}{64}$	2 $\frac{5}{64}$	2 $\frac{7}{32}$	2 $\frac{8}{64}$	2 $\frac{9}{16}$	1 $\frac{1}{16}$
S 6020	10.6	2 $\frac{29}{64}$	1 $\frac{21}{64}$	4 $\frac{5}{64}$	5 $\frac{1}{8}$	2 $\frac{5}{64}$	1 $\frac{1}{8}$	1 $\frac{7}{128}$	5 $\frac{1}{128}$	5 $\frac{1}{128}$	3 $\frac{1}{4}$	4 $\frac{5}{128}$	2 $\frac{7}{16}$	5 $\frac{1}{8}$

S 10030

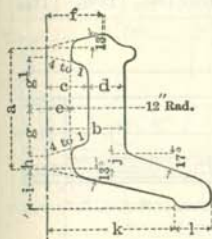

SERIES B

S 9030 to S 6030

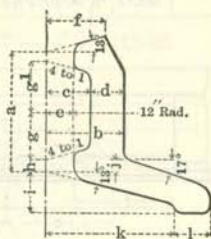

Section Index	Weight per Foot, Unfinished Pounds	a	b	c	d	e	f	g	g¹	h	i	j	k	l
		In.	In.	In.	In.	In.	In.	In.	In.	In.	In.	In.	In.	In.
*S 10030	16.9	2 $\frac{55}{64}$	1 $\frac{23}{32}$	2 $\frac{9}{32}$	1 $\frac{3}{16}$	1 $\frac{5}{32}$	1 $\frac{21}{64}$	1 $\frac{1}{32}$	2 $\frac{9}{32}$	5 $\frac{1}{128}$	6 $\frac{1}{64}$	4 $\frac{5}{128}$	3 $\frac{1}{128}$	7 $\frac{1}{8}$
*S 9030	14.4	2 $\frac{5}{8}$	1 $\frac{23}{32}$	2 $\frac{9}{32}$	1 $\frac{3}{16}$	1 $\frac{5}{32}$	1 $\frac{9}{32}$	1 $\frac{1}{32}$	2 $\frac{9}{32}$	9 $\frac{1}{32}$	2 $\frac{9}{32}$	1 $\frac{7}{64}$	2 $\frac{105}{128}$	2 $\frac{7}{32}$
*S 8030	12.6	2 $\frac{15}{32}$	1 $\frac{19}{32}$	2 $\frac{7}{32}$	3 $\frac{1}{4}$	5 $\frac{9}{128}$	1 $\frac{7}{32}$	1 $\frac{1}{128}$	2 $\frac{7}{32}$	2 $\frac{9}{128}$	7 $\frac{1}{8}$	1 $\frac{7}{64}$	2 $\frac{21}{32}$	1 $\frac{3}{16}$
*S 7030	11.9	2 $\frac{17}{64}$	1 $\frac{9}{16}$	1 $\frac{3}{16}$	3 $\frac{1}{4}$	5 $\frac{9}{128}$	1 $\frac{3}{16}$	5 $\frac{5}{64}$	3 $\frac{1}{4}$	3 $\frac{9}{128}$	5 $\frac{1}{64}$	4 $\frac{5}{128}$	2 $\frac{59}{128}$	3 $\frac{1}{4}$
*S 6030	9.5	2 $\frac{1}{16}$	1 $\frac{3}{8}$	1 $\frac{1}{16}$	1 $\frac{1}{16}$	5 $\frac{1}{128}$	1 $\frac{3}{16}$	5 $\frac{5}{64}$	3 $\frac{1}{4}$	1 $\frac{1}{64}$	3 $\frac{1}{4}$	7 $\frac{1}{32}$	2 $\frac{9}{32}$	2 $\frac{3}{32}$

*Not rolled by Carnegie Steel Company.

CARNEGIE STEEL COMPANY

RAILS AND SPLICE BARS

DIMENSIONS FOR STANDARD DRILLING AND PUNCHING IN INCHES



Rails		Splice Bars	H	m	n	Rails		Splice Bars	H	m	n
A. S. C. E. Rails	10040	S10040	2 ⁰⁵ / ₁₂₈	2 ⁴⁹ / ₁₂₈	1 ³ / ₁₆	Light Rails	4540	S 4540	1 ⁴ / ₆₄	1 ⁰⁷ / ₆₄	9/ ₁₆
	9040	S 9040	2 ⁴⁵ / ₁₂₈	2 ²⁹ / ₁₂₈	1 ³ / ₁₆		4040	S 4040	1 ⁷ / ₁₂₈	1 ⁰⁵ / ₁₂₈	1/2
	8540	S 8540	2 ¹⁷ / ₆₄	2 ⁹ / ₆₄	1 ³ / ₁₆		3540	S 3540	1 ⁵ / ₃₂	1 ¹³ / ₃₂	1/2
	8040	S 8040	2 ³ / ₁₆	2 ¹ / ₁₆	3/4		3040	S 3040	1 ²⁵ / ₆₄	1 ²³ / ₆₄	1/2
	7540	S 7540	2 ¹⁹ / ₁₂₈	1 ¹²⁷ / ₁₂₈	3/4		2540	S 2540	1 ²⁹ / ₁₂₈		
	7040	S 7040	2 ³ / ₆₄	1 ⁰¹ / ₆₄	1 ¹ / ₁₆		2040	S 2040	1 ¹ / ₆₄		
	6540	S 6540	1 ³ / ₃₂	1 ⁷ / ₈	1 ¹ / ₁₆		1640	S 1640	1 ⁷ / ₁₂₈		
	6040	S 6040	1 ¹¹⁵ / ₁₂₈	1 ¹⁰⁸ / ₁₂₈	5/8		1440	S 1440	5 ⁷ / ₆₄		
	5540	S 5540	1 ¹⁰⁸ / ₁₂₈	1 ⁹¹ / ₁₂₈	5/8		1240	S 1240	5 ⁷ / ₆₄		
	5040	S 5040	1 ²³ / ₃₂	1 ²¹ / ₃₂	9/16		1040	S 1040	4 ⁹ / ₆₄		
					840	S 840	1 ¹ / ₁₆				
A. R. A. Rails	10020	S10020	2 ³ / ₄	2 ¹¹ / ₁₆	1 ³ / ₈	A. R. A. Rails	10030	S10030	2 ⁰⁵ / ₁₂₈	2 ⁴⁹ / ₁₂₈	1 ³ / ₈
	9020	S 9020	2 ³⁷ / ₆₄	2 ³³ / ₆₄	1 ⁵ / ₁₆		9030	S 9030	2 ¹ / ₃₂	2 ⁷ / ₃₂	1 ¹ / ₁₆
	8020	S 8020	2 ²¹ / ₆₄	2 ¹⁷ / ₆₄	1 ¹ / ₄		8030	S 8030	2 ¹⁵ / ₆₄	2 ⁷ / ₆₄	1 ⁵ / ₁₆
	7020	S 7020	2 ⁵ / ₃₂	2 ³ / ₃₂	1 ³ / ₁₆		7030	S 7030	2 ⁷ / ₁₂₈	1 ¹¹⁹ / ₁₂₈	1 ¹ / ₄
	6020	S 6020	2 ⁵ / ₁₂₈	1 ¹²⁵ / ₁₂₈	1 ¹ / ₈		6030	S 6030	1 ²⁹ / ₃₂	1 ²⁵ / ₃₂	1 ⁷ / ₃₂

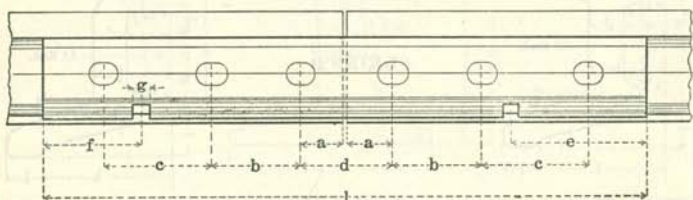

Rails, Lb. per Yd.	Hole in Rail	Hole in Splice Bar	a	b	c	d	e	f	g	l
90 and over	1 ¹ / ₄	1 ¹ / ₈ x 1 ³ / ₈	2 ¹ / ₂	5	6	5 ¹ / ₁₆	7 ¹ / ₂	5 ¹ / ₂	1 ¹ / ₁₆	34
85 to 75	1 ¹ / ₈	1 x 1 ¹ / ₄	2 ¹ / ₂	5	6	5 ¹ / ₁₆	7 ¹ / ₂	5 ¹ / ₂	1 ¹ / ₁₆	34
72 to 70	1	7/8 x 1 ¹ / ₈	2 ¹ / ₂	5	6	5 ¹ / ₁₆	7 ¹ / ₂	5 ¹ / ₂	1 ¹ / ₁₆	34
67 to 50	1	7/8 x 1 ¹ / ₈	2 ¹ / ₂	5	5	5 ¹ / ₁₆	6 ¹ / ₂	2 ¹ / ₂	1 ¹ / ₁₆	24
45 to 40	7/8	1 ³ / ₁₆ x 1 ¹ / ₈	2 ¹ / ₂	5	5	5 ¹ / ₈	3 ³ / ₈	1 ¹ / ₈	3/4	20
35 to 30	3/4	1 ¹ / ₁₆ x 3 ¹ / ₃₂	2	4	4	4 ¹ / ₈				16 ¹ / ₈
25 to 12	5/8	9/16 x 3/4	2	4	4	4 ¹ / ₈				16 ¹ / ₈
10 to 8	1/2	7/16 x 5/8	2	4	4	4 ¹ / ₈				16 ¹ / ₈

AMERICAN RAILWAY ENGINEERING ASSOCIATION RAILS

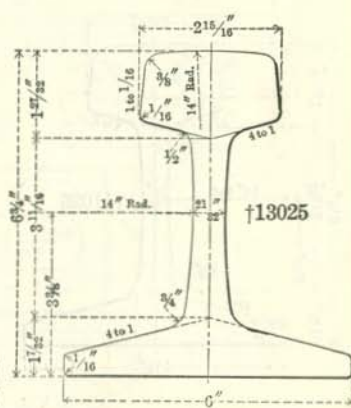
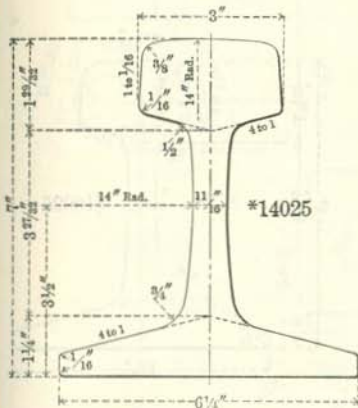
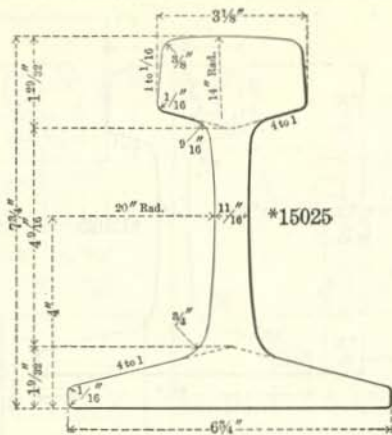

Section Index	Weight per Yard	Area of Section A	Moment of Inertia I	Section Modulus		Neutral Axis	
				Base	Head	Base	Head
				I/x	I/y	x	y
	Lb.	In. ²	In. ⁴	In. ³	In. ³	In.	In.
*15025	150.45	14.75	121.1	35.1	28.2	3 ²⁹ / ₆₄	4 ¹⁹ / ₆₄
*14025	138.52	13.58	89.2	28.4	23.1	3 ⁹ / ₆₄	3 ²⁵ / ₆₄
†13025	129.64	12.71	77.4	25.6	20.8	3 ¹ / ₃₂	3 ²⁵ / ₃₂

*Not rolled by C. S. Co., I. S. Co., or T. C. I. & R. R. Co.

†Rolled by C. S. Co. and I. S. Co.

AMERICAN RAILWAY ENGINEERING ASSOCIATION RAILS

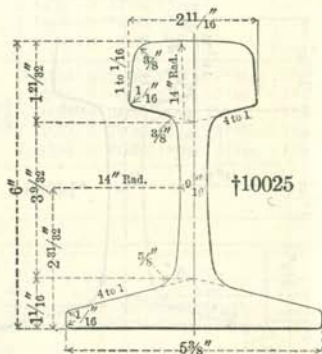
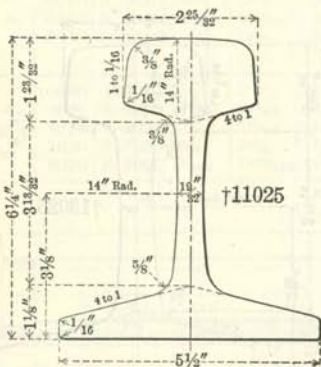
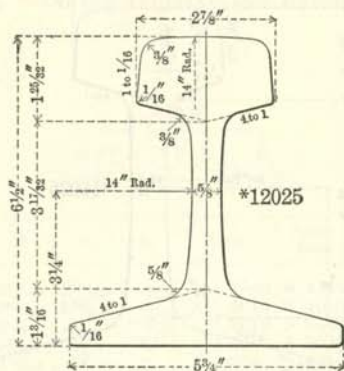

Section Index	Weight per Yard	Area of Section A	Moment of Inertia I	Section Modulus		Neutral Axis	
				Base	Head	Base	Head
				I/x	I/y	x	y
	Lb.	In. ²	In. ⁴	In. ³	In. ³	In.	In.
*12025	120.87	11.85	67.6	23.1	18.9	2 ⁵⁹ / ₆₄	3 ³⁷ / ₆₄
†11025	110.36	10.82	57.0	20.1	16.7	2 ⁵⁹ / ₆₄	3 ²⁷ / ₆₄
†10025	101.49	9.95	49.0	17.8	15.1	2 ³ / ₄	3 ¹ / ₄

*Not rolled by C. S. Co., I. S. Co., or T. C. I. & R. R. Co.
 †Rolled by I. S. Co. and T. C. I. & R. R. Co.

RAIL ACCESSORIES

RAIL CLIPS

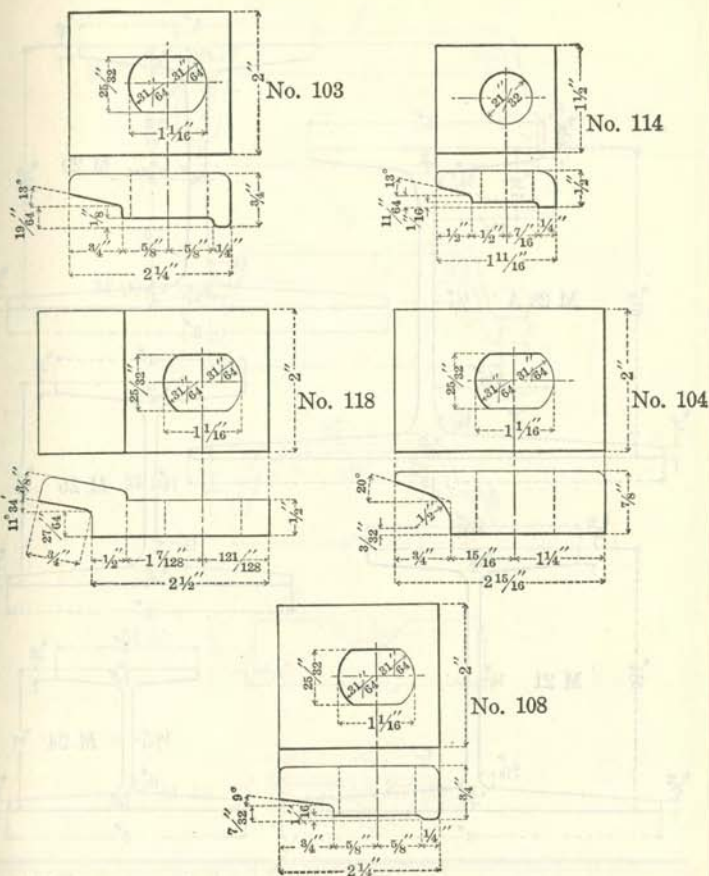

Rail Clip No.	Size, Inches	Weight per Foot, Pounds	Weight of Finished Clip, Pounds	Rail Section
103	2 1/4 x 2	4.4	0.64	100 to 60 lb. A. S. C. E. Rails.
114	1 11/16 x 1 1/2	2.3	0.25	50 to 20 lb. A. S. C. E. Rails.
118	2 1/2 x 2	5.7	0.85	100 to 60 lb. R. B. Rails.
104	2 1 3/10 x 2	7.3	1.10	100 to 60 lb. A.S.C.E. Angle Bars
108	2 1/4 x 2	4.8	0.70	Girder Rails.

Clips can be furnished with 25/32" diameter holes.

CROSS TIE SECTIONS

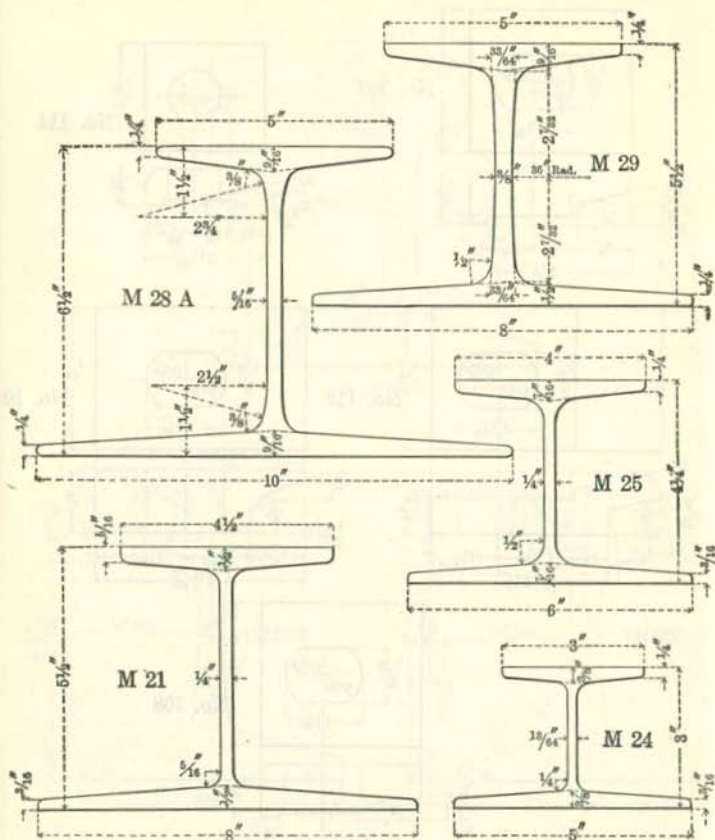

Section Index	Depth, Inches	Width of Flanges		Web Thickness, Inches	Weight per Foot, Pounds
		Top, Inches	Bottom, Inches		
M 28A	6 1/2	5	10	3/16	29.8
M 29	5 1/2	5	8	3/8 to 33/64	24.0
M 21	5 1/2	4 1/2	8	1/4	20.0
M 25	4 1/2	4	6	1/4	14.5
M 24	3	3	5	13/64	9.5

Full information as to uses of steel cross ties is given in a separate pamphlet on Steel Cross Ties.

CROSS TIE SECTIONS—Concluded

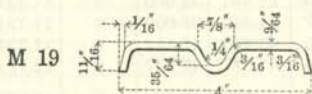
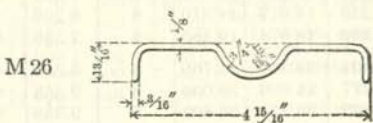
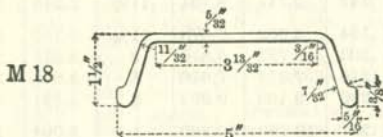
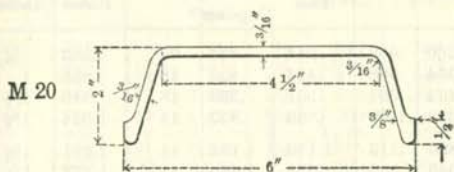
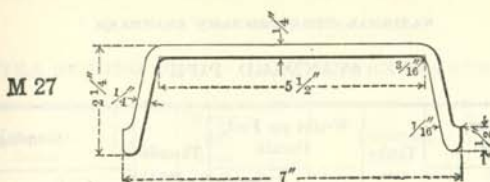

Section, Index	Depth, Inches	Width, Inches	Web Thickness, Inches	Weight per Foot, Pounds
M 27	2 1/4	7	3/16	9.0
M 20	2	6	3/16	6.0
M 18	1 1/2	5	5/32	4.0
M 26	1 3/16	4 15/16	1/8	3.20
M 19	1 1/16	4	35/64	2.50

Full information as to uses of steel cross ties is given in a separate pamphlet on Steel Cross Ties.

CARNEGIE STEEL COMPANY

PIPE—BLACK AND GALVANIZED

NATIONAL TUBE COMPANY STANDARD

STANDARD PIPE

Size, In.	Diameters, Inches		Thick- ness, Inches	Weight per Foot, Pounds		Threads per Inch	Couplings		
	External	Internal		Plain Ends	Threads and Couplings		Diameter, Inches	Length, Inches	Weight, Pounds
3/8	.405	.269	.068	.244	.245	27	.562	7/8	.029
1/2	.540	.364	.088	.424	.425	18	.685	1	.043
5/8	.675	.493	.091	.567	.568	18	.848	1 1/8	.070
3/4	.840	.622	.109	.850	.852	14	1.024	1 3/8	.116
7/8	1.050	.824	.113	1.130	1.134	14	1.281	1 5/8	.209
1	1.315	1.049	.133	1.678	1.684	11 1/2	1.576	1 7/8	.343
1 1/4	1.660	1.380	.140	2.272	2.281	11 1/2	1.950	2 1/8	.535
1 1/2	1.900	1.610	.145	2.717	2.731	11 1/2	2.218	2 3/8	.743
2	2.375	2.067	.154	3.652	3.678	11 1/2	2.760	2 5/8	1.208
2 1/2	2.875	2.469	.203	5.793	5.819	8	3.276	2 7/8	1.720
3	3.500	3.068	.216	7.575	7.616	8	3.948	3 1/8	2.498
3 1/2	4.000	3.548	.226	9.109	9.202	8	4.591	3 5/8	4.241
4	4.500	4.026	.237	10.790	10.889	8	5.091	3 3/4	4.741
4 1/2	5.000	4.506	.247	12.538	12.642	8	5.591	3 5/4	5.241
5	5.563	5.047	.258	14.617	14.810	8	6.296	4 1/8	8.091
6	6.625	6.065	.280	18.974	19.185	8	7.358	4 3/8	9.554
7	7.625	7.023	.301	23.544	23.769	8	8.358	4 1/2	10.932
8	8.625	8.071	.277	24.696	25.000	8	9.358	4 5/8	13.905
8	8.625	7.981	.322	28.554	28.809	8	9.358	4 5/8	13.905
9	9.625	8.941	.342	33.907	34.188	8	10.358	5 1/8	17.236
10	10.750	10.192	.279	31.201	32.000	8	11.721	6 1/8	29.877
10	10.750	10.136	.307	34.240	35.000	8	11.721	6 1/8	29.877
10	10.750	10.020	.365	40.483	41.132	8	11.721	6 1/8	29.877
11	11.750	11.000	.375	45.557	46.247	8	12.721	6 1/8	32.550
12	12.750	12.090	.330	43.773	45.000	8	13.958	6 1/8	43.098
12	12.750	12.000	.375	49.562	50.706	8	13.958	6 1/8	43.098
13	14.000	13.250	.375	54.568	55.824	8	15.208	6 1/8	47.152
14	15.000	14.250	.375	58.573	60.375	8	16.446	6 1/8	59.493
15	16.000	15.250	.375	62.579	64.500	8	17.446	6 1/8	63.294

The permissible variation in weight is 5 per cent. above and 5 per cent. below.

Furnished with threads and couplings and in random lengths unless otherwise ordered.

Taper of threads is 3/4" diameter per foot length for all sizes.

The weight per foot of pipe with threads and couplings is based on a length of 20 feet, including the coupling, but shipping lengths of small sizes will usually average less than 20 feet.

All weights and dimensions are nominal. On sizes made in more than one weight, weight desired must be specified.

PIPE

PIPE—BLACK AND GALVANIZED—Concluded

NATIONAL TUBE COMPANY STANDARD

EXTRA STRONG PIPE

DOUBLE EXTRA STRONG PIPE

Size, In.	Diameters, Inches		Thick-ness, Inches	Weight, per Foot, Pounds	Size, In.	Diameters, Inches		Thick-ness, Inches	Weight per Foot, Pounds
	External	Internal				Plain Ends	External		
3/8	.405	.215	.095	.314	1/2	.840	.252	.294	1.714
1/2	.540	.302	.119	.535	3/4	1.050	.434	.308	2.440
5/8	.675	.423	.126	.738	1	1.315	.599	.358	3.659
3/4	.840	.546	.147	1.087	1 1/4	1.660	.896	.382	5.214
1	1.050	.742	.154	1.473	1 1/2	1.900	1.100	.400	6.408
1 1/4	1.315	.957	.179	2.171	2	2.375	1.508	.436	9.029
1 1/2	1.660	1.278	.191	2.996	2 1/2	2.875	1.771	.552	13.695
2	2.375	1.939	.218	5.022	3	3.500	2.300	.600	18.583
2 1/2	2.875	2.323	.276	7.661	3 1/2	4.000	2.728	.636	22.850
3	3.500	2.900	.300	10.252	4	4.500	3.152	.674	27.541
3 1/2	4.000	3.364	.318	12.505	4 1/2	5.000	3.580	.710	32.530
4	4.500	3.826	.337	14.983	5	5.563	4.063	.750	38.552
4 1/2	5.000	4.290	.355	17.611	6	6.625	4.897	.864	53.160
5	5.563	4.813	.375	20.778	7	7.625	5.875	.875	63.079
6	6.625	5.761	.432	28.573	8	8.625	6.875	.875	72.424
7	7.625	6.625	.500	38.048	Furnished with plain ends and in random lengths unless otherwise ordered. Permissible variation in weight, for extra strong pipe, 5 per cent. above and 5 per cent. below. For double extra strong pipe, 10 per cent. above and 10 per cent. below. All weights and dimensions are nominal.				
8	8.625	7.625	.500	43.388					
9	9.625	8.625	.500	48.728					
10	10.750	9.750	.500	54.735					
11	11.750	10.750	.500	60.075					
12	12.750	11.750	.500	65.415					
13	14.000	13.000	.500	72.091					
14	15.000	14.000	.500	77.431					
15	16.000	15.000	.500	82.771					

LARGE O. D. PIPE

Size, In.	Weight per Foot, Pounds									
	Thickness, Inches									
	3/4	5/8	3/4	7/16	1/2	9/16	5/8	3/4	7/8	1
14	36.713	45.682	54.568	63.371	72.091	80.726	89.279	106.134	122.654	138.842
15	39.383	49.020	58.573	68.044	77.431	86.734	95.954	114.144	132.000	149.522
16	42.053	52.357	62.579	72.716	82.771	92.742	102.629	122.154	141.345	160.202
17	44.723	55.695	66.584	77.389	88.111	98.749	109.304	130.164	150.690	170.882
18	47.393	59.032	70.589	82.061	93.451	104.757	115.979	138.174	160.035	181.562
20		65.708	78.599	91.407	104.131	116.772	129.330	154.194	178.725	202.923
21		69.045	82.604	96.079	109.471	122.780	136.005	162.204		
22		72.383	86.609	100.752	114.811	128.787	142.680	170.215		
24			94.619	110.097	125.491	140.802	156.030	186.235		
26			102.629	119.442	136.172	152.818	169.380	202.255		
28				128.787	146.852	164.833	182.730	218.275		
30				138.132	157.532	176.848	196.081	234.296		

Furnished with plain ends and in random lengths, unless otherwise ordered. All weights and dimensions are nominal.

CARNEGIE STEEL COMPANY

SCREW THREADS

AMERICAN BRIDGE COMPANY STANDARD

BOLTS, RODS, EYE BARS, TURNBUCKLES, SLEEVE NUTS, AND CLEVISSES

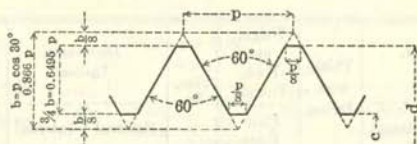

Diameter		Area		Number of Threads per Inch	Diameter		Area		Number of Threads per Inch
Total d, In.	Net, c, In.	Total Dia., d, Sq. In.	Net Dia., c, Sq. In.		Total, d, In.	Net, c, In.	Total Dia., d, Sq. In.	Net Dia., c, Sq. In.	
1/4	.185	.049	.027	20	2 1/2	2.175	4.909	3.716	4
3/8	.294	.110	.068	16	2 3/8	2.300	5.412	4.156	4
1/2	.400	.196	.126	13	2 3/4	2.425	5.940	4.619	4
5/8	.507	.307	.202	11	2 7/8	2.550	6.492	5.108	3 1/2
3/4	.620	.442	.302	10	3	2.629	7.069	5.428	3 1/2
7/8	.731	.601	.419	9	3 1/4	2.879	8.296	6.509	3 1/2
1	.838	.785	.551	8	3 1/2	3.100	9.621	7.549	3 1/4
1 1/8	.939	.994	.693	7	3 3/4	3.317	11.045	8.641	3
1 1/4	1.064	1.227	.890	7	4	3.567	12.566	9.993	3
1 3/8	1.158	1.485	1.054	6	4 1/4	3.798	14.186	11.330	2 7/8
1 1/2	1.283	1.767	1.294	6	4 1/2	4.028	15.904	12.741	2 3/4
1 3/4	1.389	2.074	1.515	5 1/2	4 3/4	4.255	17.721	14.221	2 3/8
1 7/8	1.490	2.405	1.744	5	5	4.480	19.635	15.766	2 1/2
2	1.615	2.761	2.049	5	5 1/4	4.730	21.648	17.574	2 1/2
2 1/8	1.711	3.142	2.300	4 1/2	5 1/2	4.953	23.758	19.268	2 3/8
2 1/4	1.836	3.547	2.649	4 1/2	5 3/4	5.203	25.967	21.262	2 3/8
2 3/8	1.961	3.976	3.021	4 1/2	6	5.423	28.274	23.095	2 1/4
2 1/2	2.086	4.430	3.419	4					

BOLT HEADS AND NUTS

AMERICAN BRIDGE COMPANY STANDARD

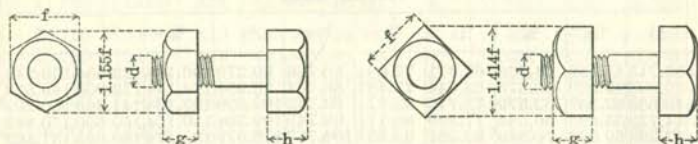







Rough Nut		Finished Nut		Rough Head		Finished Head	
f	g	f	g	f	h	f	h
$1.5d + 1/8''$	d	$1.5d + 3/16''$	$d - 1/16''$	$1.5d + 1/8''$	$0.5f$	$1.5d + 3/16''$	$0.5f - 1/16''$

For Screw Threads, Bolt Heads and Nuts, the American Bridge Company has adopted the Franklin Institute Standard, commonly known as United States Standard.

BOLTS

BOLT HEADS AND NUTS, DIMENSIONS IN INCHES

AMERICAN BRIDGE COMPANY STANDARD

Diameter of Bolt, Inches	HEAD						Diameter of Bolt, Inches	NUT					
	Hexagonal		Hex. or Square		Square			Hexagonal		Hex. or Square		Square	
													
	Diameter		Height	Diameter		Height		Diameter		Height	Diameter		Height
	Long	Short		Long	Short			Long	Short		Long	Short	
1/4	5/16	1/2	1/4	11/16	1/2	1/4	5/16	1/2	1/4	11/16	1/2	5/16	11/16
5/16	3/8	11/16	3/8	1	11/16	3/8	3/8	13/16	3/8	1	11/16	3/8	11/16
3/8	1	7/8	7/16	1 1/4	7/8	1	1	7/8	1 1/2	7/8	1 1/4	7/8	7/8
1/2	1 1/4	1 1/2	9/16	1 1/2	1 1/2	1 1/2	1 1/4	1 1/2	1 1/2	1 1/2	1 1/2	1 1/2	1 1/4
5/8	1 1/2	1 3/4	5/8	1 13/16	1 3/4	1 3/4	1 1/2	1 3/4	1 3/4	1 3/4	1 3/4	1 3/4	1 3/4
3/4	1 3/4	2	3/4	1 7/8	2	2	1 3/4	2	2	2	2	2	1 3/4
7/8	2	2 1/4	7/8	2	2 1/8	2 1/8	2	2 1/8	2 1/8	2 1/8	2 1/8	2 1/8	2 1/8
1	2 1/4	2 1/2	1 1/2	2 1/4	2 1/2	2 1/2	2 1/4	2 1/2	2 1/2	2 1/2	2 1/2	2 1/2	2 1/4
1 1/8	2 1/2	2 3/4	1 3/4	2 3/4	2 3/4	2 3/4	2 1/2	2 3/4	2 3/4	2 3/4	2 3/4	2 3/4	2 3/4
1 1/4	2 3/4	3	1 3/4	3	3	3	2 3/4	3	3	3	3	3	2 3/4
1 1/2	3	3 1/4	2	3 1/4	3 1/4	3 1/4	3	3 1/4	3 1/4	3 1/4	3 1/4	3 1/4	3 1/4
1 3/8	3 1/4	3 1/2	2 1/8	3 1/2	3 1/2	3 1/2	3 1/4	3 1/2	3 1/2	3 1/2	3 1/2	3 1/2	3 1/4
1 3/4	3 1/2	3 3/4	2 1/4	3 3/4	3 3/4	3 3/4	3 1/2	3 3/4	3 3/4	3 3/4	3 3/4	3 3/4	3 3/4
1 7/8	3 3/4	4	2 1/4	4	4	4	3 3/4	4	4	4	4	4	3 3/4
2	4	4 1/4	2 1/2	4 1/4	4 1/4	4 1/4	4	4 1/4	4 1/4	4 1/4	4 1/4	4 1/4	4 1/4
2 1/8	4 1/4	4 1/2	2 3/8	4 1/2	4 1/2	4 1/2	4 1/4	4 1/2	4 1/2	4 1/2	4 1/2	4 1/2	4 1/4
2 1/4	4 1/2	4 3/4	2 1/2	4 3/4	4 3/4	4 3/4	4 1/2	4 3/4	4 3/4	4 3/4	4 3/4	4 3/4	4 1/2
2 3/8	4 3/4	5	2 3/4	5	5	5	4 3/4	5	5	5	5	5	4 3/4
2 1/2	5	5 1/4	3	5 1/4	5 1/4	5 1/4	5	5 1/4	5 1/4	5 1/4	5 1/4	5 1/4	5 1/4
2 3/4	5 1/4	5 1/2	3 1/8	5 1/2	5 1/2	5 1/2	5 1/4	5 1/2	5 1/2	5 1/2	5 1/2	5 1/2	5 1/4
3	5 1/2	5 3/4	3 1/4	5 3/4	5 3/4	5 3/4	5 1/2	5 3/4	5 3/4	5 3/4	5 3/4	5 3/4	5 1/2
3 1/8	5 3/4	6	3 1/2	6	6	6	5 3/4	6	6	6	6	6	5 3/4
3 1/4	6	6 1/4	3 3/8	6 1/4	6 1/4	6 1/4	6	6 1/4	6 1/4	6 1/4	6 1/4	6 1/4	6
3 1/2	6 1/4	6 1/2	3 5/8	6 1/2	6 1/2	6 1/2	6 1/4	6 1/2	6 1/2	6 1/2	6 1/2	6 1/2	6 1/4

BOLT THREADS, LENGTH IN INCHES

AMERICAN BRIDGE COMPANY STANDARD

Length, Inches	Diameter, Inches									
	1/4	3/8	1/2	5/8	3/4	7/8	1	1 1/8	1 1/4	1 1/2
1 to 1 1/2	3/4	3/4	1	1 1/4						
1 1/2 to 2	3/4	3/4	1	1 1/4	1 1/2	1 1/2				
2 1/2 to 2 3/4	3/4	3/4	1	1 1/4	1 1/2	1 3/4	1 3/4			
2 3/4 to 3	7/8	7/8	1	1 1/4	1 1/2	1 3/4	1 3/4	1 3/4		
3 1/2 to 4	7/8	7/8	1 1/4	1 1/4	1 1/2	1 3/4	1 3/4	1 3/4	2 1/4	
4 1/2 to 8	1	1	1 1/4	1 1/2	1 3/4	2	2 1/4	2 1/4	2 1/2	2 3/4
8 1/2 to 12	1	1	1 1/2	1 3/4	2	2 1/4	2 1/2	2 1/2	3	3
12 1/2 to 20	1	1	1 1/2	2	2	2 1/4	2 1/2	2 1/2	3	3

Bolts not listed are threaded about 3 times the diameter; in no case are standard bolts threaded closer to the head than 1/4 inch.

CARNEGIE STEEL COMPANY

BOLTS WITH SQUARE HEADS AND NUTS

AMERICAN BRIDGE COMPANY STANDARD

WEIGHT IN POUNDS PER 100 BOLTS

Length Under Head, Inches	Diameter of Bolt, Inches								
	¼	⅝	¾	7/16	½	⅝	¾	7/8	1
1	4	7	11	15	22	37	56		
1¼	4	7	11	16	23	39	59		
1½	5	8	12	17	24	41	62		
1¾	5	8	13	18	26	43	64		
2	5	9	14	19	27	45	67	101	144
2¼	6	9	15	20	28	47	71	104	150
2½	6	10	15	21	30	49	74	109	155
2¾	6	10	16	22	31	51	77	113	161
3	7	11	17	24	33	54	80	117	167
3½	7	12	18	25	35	58	86	126	178
4	8	13	20	28	38	62	92	134	189
4½	9	14	21	30	41	66	98	142	198
5	10	15	23	32	43	71	104	151	209
5½	10	16	25	34	46	75	111	159	220
6	11	17	26	36	49	79	117	168	232
6½			28	38	52	84	123	176	243
7			29	40	55	88	129	185	254
7½			31	42	57	92	136	193	265
8			32	45	60	97	142	202	276
9			34	49	65	105	154	218	298
10				53	71	114	167	235	320
12				61	82	131	192	269	364
14					93	148	217	303	409
Per Inch Additional	1.4	2.2	3.1	4.3	5.6	8.7	12.5	17.0	22.3

SQUARE NUTS AND BOLT HEADS

AMERICAN BRIDGE COMPANY STANDARD

WEIGHTS IN POUNDS FOR ONE HEAD AND ONE NUT

Diameter of Bolt, Inches	1¼	1½	1¾	2	2½	3
Square Head and Nut....	2.05	3.51	5.48	8.08	15.5	26.2
Weight of Shank per Inch	.3477	.5007	.6815	.8900	1.391	2.003

BOLTS

BOLTS WITH HEXAGON HEADS AND NUTS

AMERICAN BRIDGE COMPANY STANDARD

WEIGHT IN POUNDS PER 100 BOLTS

Length Under Head, Inches	Diameter of Bolt, Inches					Length Under Head, Inches	Diameter of Bolt, Inches				
	½	¾	¾	¾	1		½	¾	¾	¾	1
1	19	33	52			8	58	92	137	194	264
1¼	20	34	54			8½	60	96	143	202	274
1½	22	36	57			9	63	100	149	210	285
1¾	23	38	60			9½	66	105	156	219	296
2	24	40	63	93	132	10	68	109	162	227	307
2¼	26	43	66	97	137	10½	71	114	168	236	318
2½	27	45	69	101	143	11	74	118	174	244	329
2¾	29	47	72	105	148	11½	77	122	181	253	341
3	30	49	75	109	154	12	80	127	187	261	352
3¼	31	51	78	114	160	12½	82	131	193	270	363
3½	33	54	82	118	165	13	85	135	199	278	374
3¾	34	56	85	122	171	13½	88	139	206	287	385
4	35	58	88	126	176	14	91	144	212	295	396
4¼	37	60	90	130	180	14½	93	148	218	304	407
4½	38	62	94	134	186	15	96	152	225	312	418
4¾	39	64	97	138	191	15½	99	157	231	321	430
5	41	66	100	143	197	16	102	161	237	329	441
5¼	42	68	103	147	202	16½	105	165	243	338	452
5½	44	71	106	151	208	17	107	170	250	346	463
5¾	45	73	109	156	213	17½	110	174	256	355	474
6	46	75	112	160	219	18	113	177	262	364	485
6¼	48	77	115	164	225	18½	116	183	268	372	496
6½	49	79	119	168	230	19	119	187	275	381	507
6¾	51	81	122	173	236	19½	121	191	281	389	519
7	52	84	125	177	241	20	124	196	287	398	530
7¼	53	86	128	181	247						
7½	55	88	131	185	252						
7¾	56	90	134	190	258						
Per Inch Additional	5.6	8.7	12.5	17.0	22.3	Per Inch Additional	5.6	8.7	12.5	17.0	22.3

HEXAGON NUTS AND BOLT HEADS

AMERICAN BRIDGE COMPANY STANDARD

WEIGHTS IN POUNDS FOR ONE HEAD AND ONE NUT

Diameter of Bolt, Inches	1¼	1½	1¾	2	2½	3
Hexagon Head and Nut . .	1.73	2.95	4.61	6.79	13.0	22.0
Weight of Shank per Inch	.3477	.5007	.6815	.8900	1.391	2.003

CARNEGIE STEEL COMPANY

UPSET SCREW ENDS FOR SQUARE BARS

AMERICAN BRIDGE COMPANY STANDARD

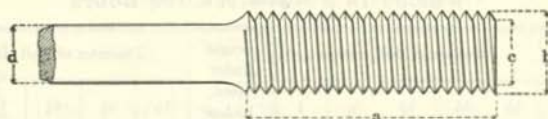

Pitch and Shape of Thread A. B. Co. Standard

BAR			UPSET					
Side of Square d, Inches	Area, Sq. Inches	Weight per Foot, Lbs.	Diameter b, Inches	Length a, Inches	Additional Length for Upset +10%, Inches	Diameter at Root of Thread c, Inches	Area	
							At Root of Thread, Sq. Inches	Excess Over Area of Bar, %
* ¼	0.563	1.91	1½	4	4	0.939	0.693	23.2
* ⅜	0.766	2.60	1½	4	3½	1.064	0.890	16.2
1	1.000	3.40	1½	4	4	1.283	1.294	29.4
1½	1.266	4.30	1½	4	3½	1.389	1.515	19.7
1¾	1.563	5.31	1½	4½	4½	1.615	2.049	31.1
1¾	1.891	6.43	2	4½	4	1.711	2.300	21.7
1½	2.250	7.65	2¼	5	5	1.961	3.021	34.3
1¾	2.641	8.98	2½	5	4½	2.086	3.419	29.5
1¾	3.063	10.41	2½	5½	4½	2.175	3.716	21.3
1¾	3.516	11.95	2¾	5½	5	2.425	4.619	31.4
2	4.000	13.60	2¾	6	5	2.550	5.108	27.7
2½	4.516	15.35	3	6	4½	2.629	5.428	20.2
2¾	5.063	17.21	3¼	6½	5½	2.879	6.509	28.6
2¾	5.641	19.18	3½	7	6½	3.100	7.549	33.8
2½	6.250	21.25	3¾	7	7	3.317	8.641	38.3
2¾	6.891	23.43	3¾	7	5½	3.317	8.641	25.4
2¾	7.563	25.71	4	7½	6½	3.567	9.993	32.1
2¾	8.266	28.10	4¼	8	7½	3.798	11.330	37.1
3	9.000	30.60	4½	8	6	3.798	11.330	25.9
3½	9.766	33.20	4½	8½	7	4.028	12.741	30.5
3½	10.563	35.91	4¾	8½	7½	4.255	14.221	34.6

Upsets marked * are special.

UPSET SCREW ENDS

UPSET SCREW ENDS FOR ROUND BARS

AMERICAN BRIDGE COMPANY STANDARD

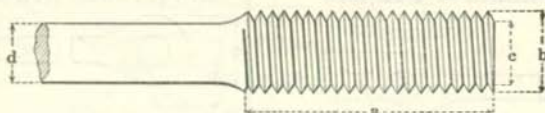

Pitch and Shape of Thread A. B. Co. Standard

BAR			UPSET					
Diameter d, Inches	Area, Sq. Inches	Weight per Foot, Lbs.	Diameter b, Inches	Length a, Inches	Additional Length for Upset +10%, Inches	Diameter at Root of Thread c, Inches	Area	
							At Root of Thread, Sq. Inches	Excess Over Area of Bar, %
* 3/4	0.442	1.50	1	4	4	0.838	0.551	24.7
* 7/8	0.601	2.04	1 1/4	4	5	1.064	0.890	48.0
1	0.785	2.67	1 1/2	4	4	1.158	1.054	34.2
1 1/8	0.994	3.38	1 1/2	4	4	1.283	1.294	30.2
1 1/4	1.227	4.17	1 3/4	4	4	1.389	1.515	23.5
1 1/2	1.485	5.05	1 3/4	4	4	1.490	1.744	17.5
1 3/4	1.767	6.01	2	4 1/2	4 1/2	1.711	2.300	30.2
1 7/8	2.074	7.05	2 1/8	4 1/2	4	1.836	2.649	27.7
1 7/8	2.405	8.18	2 1/4	5	4	1.961	3.021	25.6
1 7/8	2.761	9.39	2 3/8	5	4	2.086	3.419	23.8
2	3.142	10.68	2 1/2	5 1/2	4	2.175	3.716	18.3
2 1/8	3.547	12.06	2 5/8	5 1/2	3 1/2	2.300	4.156	17.2
2 1/4	3.976	13.52	2 7/8	6	4 1/2	2.550	5.108	28.4
2 1/2	4.430	15.06	3	6	4 1/2	2.629	5.428	22.5
2 3/4	4.909	16.69	3 1/4	6 1/2	5 1/2	2.879	6.509	32.6
2 3/4	5.412	18.40	3 1/2	6 1/2	4 1/2	2.879	6.509	20.3
2 3/4	5.940	20.19	3 3/4	7	5 1/2	3.100	7.549	27.1
2 3/4	6.492	22.07	3 3/4	7	6	3.317	8.641	33.1
3	7.069	24.03	3 3/4	7	5	3.317	8.641	22.2
3 1/8	7.670	26.08	4	7 1/2	6	3.567	9.993	30.3
3 1/4	8.296	28.21	4	7 1/2	5	3.567	9.993	20.5
3 1/2	8.946	30.42	4 1/4	8	5 1/2	3.798	11.330	26.6
3 1/2	9.621	32.71	4 1/4	8	5	3.798	11.330	17.8
3 3/4	10.321	35.09	4 1/2	8 1/2	5 1/2	4.028	12.741	23.4
3 3/4	11.045	37.55	4 3/4	8 1/2	6	4.255	14.221	28.8
3 3/4	11.793	40.10	4 3/4	8 1/2	5 1/2	4.255	14.221	20.6

Upsets marked * are special.

LOOP RODS

LOOP RODS

AMERICAN BRIDGE COMPANY STANDARD

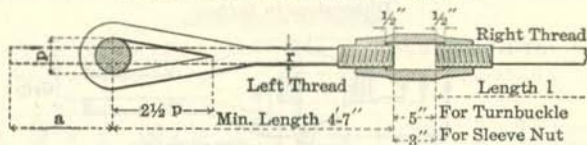

Pitch and Shape of Thread A. B. Co. Standard

ADDITIONAL LENGTH "A" IN FEET AND INCHES FOR ONE LOOP

$$A = 4.17p + 5.89r$$

Diam. of Pin, p	Diameter or Side "r" of Rod in Inches										
	3/4	7/8	1	1 1/8	1 1/4	1 3/8	1 1/2	1 5/8	1 3/4	1 7/8	2
1 1/8	0- 9 1/2	0-10	0-11	0-11 1/2							
1 1/4	0-10	0-10 1/2	0-11 1/2	1- 0	1- 1						
1 3/8	0-11	0-11 1/2	1- 0 1/2	1- 1	1- 2	1- 2 1/2					
1 1/2	1- 0	1- 0 1/2	1- 1 1/2	1- 2	1- 3	1- 3 1/2	1- 4 1/2	1- 5	1- 6		
2	1- 1	1- 1 1/2	1- 2 1/2	1- 3	1- 4	1- 4 1/2	1- 5 1/2	1- 6	1- 7	1- 7 1/2	1- 8 1/2
2 1/4	1- 2	1- 3	1- 3 1/2	1- 4 1/2	1- 5	1- 5 1/2	1- 6 1/2	1- 7	1- 8	1- 8 1/2	1- 9 1/2
2 1/2	1- 3	1- 4	1- 4 1/2	1- 5 1/2	1- 6	1- 7	1- 7 1/2	1- 8	1- 9	1- 9 1/2	1-10 1/2
2 3/4	1- 4	1- 5	1- 5 1/2	1- 6 1/2	1- 7	1- 8	1- 8 1/2	1- 9 1/2	1-10	1-11	1-11 1/2
3	1- 5	1- 6	1- 6 1/2	1- 7 1/2	1- 8	1- 9	1- 9 1/2	1-10 1/2	1-11	2- 0	2- 0 1/2
*3 1/4	1- 6	1- 7	1- 7 1/2	1- 8 1/2	1- 9	1-10	1-10 1/2	1-11 1/2	2- 0	2- 1	2- 1 1/2
3 1/2	1- 7 1/2	1- 8	1- 8 1/2	1- 9 1/2	1-10	1-11	1-11 1/2	2- 0 1/2	2- 1	2- 2	2- 2 1/2
*3 3/4	1- 8 1/2	1- 9	1-10	1-10 1/2	1-11	2- 0	2- 0 1/2	2- 1 1/2	2- 2	2- 3	2- 3 1/2
4	1- 9 1/2	1-10	1-11	1-11 1/2	2- 0 1/2	2- 1	2- 2	2- 2 1/2	2- 3	2- 4	2- 4 1/2
*4 1/4		1-11	2- 0	2- 0 1/2	2- 1 1/2	2- 2	2- 3	2- 3 1/2	2- 4 1/2	2- 5	2- 6
4 1/2		2- 0	2- 1	2- 1 1/2	2- 2 1/2	2- 3	2- 4	2- 4 1/2	2- 5 1/2	2- 6	2- 7
*4 3/4		2- 1	2- 2	2- 2 1/2	2- 3 1/2	2- 4	2- 5	2- 5 1/2	2- 6 1/2	2- 7	2- 8
5		2- 2 1/2	2- 3	2- 3 1/2	2- 4 1/2	2- 5	2- 6	2- 6 1/2	2- 7 1/2	2- 8	2- 9
*5 1/4			2- 4	2- 5	2- 5 1/2	2- 6	2- 7	2- 7 1/2	2- 8 1/2	2- 9	2-10
5 1/2			2- 5	2- 6	2- 6 1/2	2- 7 1/2	2- 8	2- 9	2- 9 1/2	2-10	2-11
*5 3/4			2- 6	2- 7	2- 7 1/2	2- 8 1/2	2- 9	2-10	2-10 1/2	2-11 1/2	3- 0
6			2- 7	2- 8	2- 8 1/2	2- 9 1/2	2-10	2-11	2-11 1/2	3- 0 1/2	3- 1
*6 1/4				2- 9	2- 9 1/2	2-10 1/2	2-11	3- 0	3- 0 1/2	3- 1 1/2	3- 2
6 1/2				2-10	2-10 1/2	2-11 1/2	3- 0	3- 1	3- 1 1/2	3- 2 1/2	3- 3
*6 3/4				2-11	3- 0	3- 0 1/2	3- 1	3- 2	3- 2 1/2	3- 3 1/2	3- 4
7				3- 0	3- 1	3- 1 1/2	3- 2 1/2	3- 3	3- 3 1/2	3- 4 1/2	3- 5

Pins marked * are special. Maximum shipping length of "1"=35 feet.

CARNEGIE STEEL COMPANY

CLEVISSES

AMERICAN BRIDGE COMPANY STANDARD

Dimensions in Inches

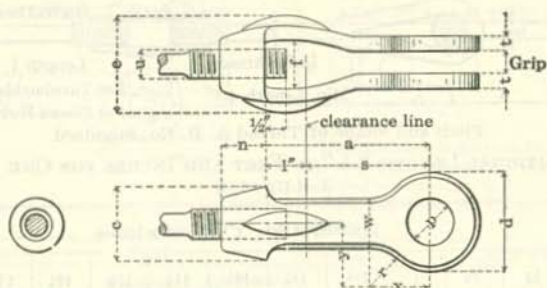

Grip—thickness of plate + 1/4" but must not exceed dimension f

Cleviss Number	Head							Nut					Fork			Weight, Pounds	
	d	w	t	Max. p	Min. p	r	x	y	n	e	Max. u	Min. u	e	f	a		s
3	3	1 1/2	1/2	1 1/2	1	2 1/4	2 1/4	3	1 1/2	2 1/4	1 3/8	1	3 1/2	1 1/4	5	4	4
4	4	2	3/2	2	1 3/4	3	3	4	1 3/4	2 3/4	1 3/8	1 1/2	3 3/8	1 3/4	6	5	8
5	5	2 1/2	5/8	2 1/2	1 1/2	3 3/4	3 3/4	5	2 1/4	3 3/4	2 1/8	1 1/2	4 1/2	2 1/4	7	6	16
6	6	3	3/4	3	2	4 1/2	4 1/2	6	2 1/2	4 3/4	2 3/8	2	5 3/8	2 3/4	8	7	26
7	7	3 1/2	7/8	3 1/2	2 1/4	5 1/4	5 1/4	7	3	5	3	2 1/4	6 1/8	3 1/4	9	8	36

CLEVIS NUMBERS FOR VARIOUS RODS AND PINS

Rods			Pins										
Round	Square	Upset	1	1 1/4	1 1/2	1 3/4	2	2 1/4	2 1/2	2 3/4	3	3 1/4	3 1/2
3/4	1	3	3	3								
.....	3/4	1 1/8	3	3	3	4	4						
.....	7/8	1 1/4		4	4	4	4						
1	1 3/8		4	4	4	4						
1 1/8	1 1/2		4	4	4	4	5	5				
1 1/4	1 5/8		4	4	4	4	5	5				
1 1/2	1 3/4			5	5	5	5	5				
.....	1 3/4	1 3/8			5	5	5	5	5				
1 1/2	2			5	5	5	5	5	6	6		
1 3/4	2 1/8			5	5	5	5	5	6	6		
1 3/4	2 1/4					6	6	6	6	6	7	7
1 3/8	2 3/8					6	6	6	6	6	7	7
2	2 1/2					6	6	6	6	6	7	7
2 1/8	2 5/8					6	6	6	6	6	7	7
.....	1 7/8	2 3/4							7	7	7	7	7
2 1/4	2 3/8							7	7	7	7	7
2 1/2	3							7	7	7	7	7

Clevises above and to right of zigzag line may be used with forks straight, those below and to left of this line should have forks closed so as not to overstrain pin.

TURNBUCKLES AND SLEEVE NUTS

TURNBUCKLES AND SLEEVE NUTS

AMERICAN BRIDGE COMPANY STANDARD

MANUFACTURERS STANDARD

Dimensions in Inches

TURNBUCKLES

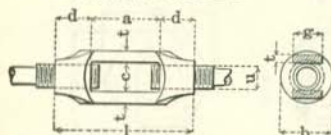

SLEEVE NUTS

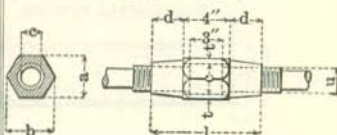

a=6''; a=9'' for turnbuckles marked *.
Pitch and shape of thread, A. B. Co. Standard.

Diam. of Screw u	Standard Dimensions						Weight, Pounds	Diam. of Screw u	Standard Dimensions						Weight, Pounds
	d	l	c	t	g	b			d	l	a	b	c	t	
3/8	9/16	7/8	9/16	3/8	1/2	1 1/16	1								
7/16	2 1/16	7 9/16	5/8	1/4	5/8	1 3/8	1								
1/2	3/4	7 1/2	5/8	1/4	5/8	1 3/8	1								
9/16	2 7/16	7 1 1/16	1 3/16	5/16	3/4	1 9/16	1 1/2								
5/8	1 1/2	7 7/8	1 1/16	5/16	3/4	1 9/16	1 1/2								
3/4	1 3/8	8 3/4	1 1/16	1 3/16	7/8	2	2								
7/8	1 9/16	8 5/8	1 1/4	3/8	1	2 1/4	3	7/8	1 1/2	7	1 3/8	1 7/8	1 3/8	1/4	3
1	1 1/2	9	1 3/16	7/16	1 1/4	2 7/16	4	1	1 1/2	7	1 3/8	1 7/8	1 3/8	1/4	3
1 1/8	1 1 1/16	9 3/8	1 7/16	1/2	1 1/4	2 9/16	5	1 1/8	1 3/4	7 1/2	2	2 3/16	1 3/8	5/16	4
1 1/4	1 7/8	9 3/4	1 9/16	1/2	1 1/2	2 3/4	6	1 1/4	1 3/4	7 3/4	2	2 3/16	1 3/8	5/16	4
1 1/2	2 1/16	10 1/8	1 1 1/16	1/2	1 5/8	3 1/16	7	1 1/2	2	8	2 3/8	2 3/4	1 5/8	3/8	5
1 3/4	2 1/4	10 1/2	1 3/4	5/8	1 3/4	3 3/16	8	1 3/4	2	8	2 3/8	2 3/4	1 5/8	3/8	6
1 5/8	2 7/16	10 7/8	2	5/8	1 7/8	3 1/2	10	1 5/8	2 1/4	8 1/2	2 3/4	3 3/16	1 7/8	7/16	8
1 7/8	2 3/8	11 1/4	2 1/16	5/8	2	3 3/8	11	1 7/8	2 1/4	8 1/2	2 3/4	3 3/16	1 7/8	7/16	9
2	2 1 1/16	11 5/8	2 3/16	1 1/16	2 1/8	3 7/8	12	2	2 1/2	9	3 1/8	3 5/8	2 3/8	1/2	10
2 1/8	3	12	2 3/8	1 1/16	2 1/4	4 1/4	14	2	2 1/2	9	3 1/8	3 5/8	2 3/8	1/2	11
2 1/4	3 3/16	12 3/8	2 1/2	2 3/16	2 1/2	4 1/2	17	2 1/8	2 3/4	9 1/2	3 1/2	4 1/16	2 3/8	9/16	14
2 1/2	3 3/8	12 3/4	2 1 1/16	1 9/16	2 1/2	4 3/4	20	2 1/4	2 3/4	9 1/2	3 1/2	4 1/16	2 3/8	9/16	15
2 3/8	3 9/16	13 1/8	2 3/4	1 9/16	2 3/4	4 7/8	22	2 3/8	3	10	3 7/8	4 1/2	2 3/8	5/8	18
2 1/2	3 3/4	13 1/2	3 1/16	2 7/16	3	5 3/8	25	2 1/2	3	10	3 7/8	4 1/2	2 3/8	5/8	19
2 3/4	4 1/8	14 1/4	3 1/4	1 9/16	3 1/4	5 3/4	33	2 3/4	3 1/4	10 1/2	4 1/4	4 19/16	2 7/8	1 1/16	23
2 7/8	4 9/16	14 3/8	3 7/16	1 1/2	3 1/4	6 1/16	36	2 7/8	3 1/2	11	4 5/8	5 3/8	3 3/8	3/4	27
3	4 1/2	15	3 3/8	1 1/2	3 1/2	6 3/8	40	3	3 1/2	11	4 5/8	5 3/8	3 3/8	3/4	28
3 1/4	4 7/8	15 3/4	3 7/8	1 1/16	4	6 3/4	50	3 1/4	3 3/4	11 1/2	5	5 19/16	3 3/8	1 3/16	35
3 1/2	5 1/4	16 1/2	4 1/4	1 7/16	4	7 1/4	65	3 1/2	4	12	5 3/8	6 1/4	3 3/8	7/8	40
3 3/4	5 5/8	17 1/4	4 7/16	1 5/16	5	8 3/4	95	3 3/4	4 1/4	12 1/2	5 3/4	6 1 1/16	3 7/8	1 5/16	47
4	6	18	4 5/8	1 7/16	5	8 3/4	108	4	4 1/2	13	6 1/8	7 1/16	4 3/8	1	55
*4 1/4	6 1/4	21 1/2	4 5/8	1 5/8	5 5/16	9 1/4	140	4 1/4	4 3/4	13 1/2	6 1/4	7 1/2	4 3/8	1 1/16	65
*4 1/2	6 3/4	22 1/2	5 1/2	1 3/4	6 1/2	10 3/4	195	4 1/2	5	14	6 1/8	7 1 1/16	4 3/8	1 1/16	75
*4 3/4	7 1/4	23 1/2	5 5/8	2	6 1/2	11 1/4	205								
*5	7 1/2	24	6	2 1/4	6 1/2	11 3/8	250								

CARNEGIE STEEL COMPANY

RECESSED PIN NUTS

AMERICAN BRIDGE COMPANY STANDARD

Dimensions in Inches

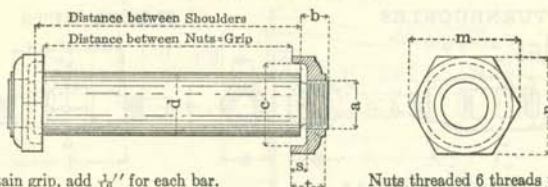

To obtain grip, add $\frac{1}{16}$ " for each bar.

Nuts threaded 6 threads per inch.

To obtain distance between shoulders, add amount given in table to grip.

Diameter of Pin, d	Pin				Nut							
	Thread		Add to Grip	Thick-ness t	Diameter			Depth s	Diameter rough hole	Weight, Pounds	Pattern No.	
	a	b			n	m	c					
2,	2 1/4	2 1/4	1 1/2	1	1 1/4	3/8	2 1/4	3 3/8	2 3/8	1 1/2	1.1	PN 21
	2 1/2	2 3/4	2	1 1/8	1 1/4	1	3 3/16	4 1/8	3 1/8	1 1/4	1.7	PN 22
	*3 3/4	3 1/2	2 1/2	1 1/4	1 1/4	1 1/8	4 5/16	5	3 7/8	1 1/2	2.5	PN 23
	3	3 1/2	3	1 3/8	1 1/2	1 1/4	4 7/8	5 5/8	4 3/8	1 1/2	3.7	PN 24
*4 1/4,	4 1/2	*4 3/4	3 1/2	1 1/2	1 1/2	1 3/8	5 3/4	6 5/8	5 1/4	1 1/2	4.6	PN 25
	5,	*5 1/4	4	1 5/8	1 1/2	1 1/2	6 1/4	7 1/8	5 3/4	1 1/2	6.2	PN 26
5 1/2,	*5 3/4	6	4 1/2	1 3/4	1 1/2	1 5/8	7	8 1/8	6 1/2	1 1/2	7.8	PN 27
	*6 1/4	*6 1/2	5	1 7/8	1 3/4	1 3/4	7 5/8	8 7/8	7	1 1/2	9.9	PN 28
	*6 3/4	7	5 1/2	2	1 3/4	1 3/4	8 1/8	9 3/8	7 1/2	1 3/4	11.8	PN 29
*7 1/4,	*7 1/2	8	5 3/2	2	1 3/4	1 3/4	8 5/8	10	8	1 3/4	14.3	PN 30
*7 3/4,	8,	*8 1/4	6	2 1/4	2 1/4	2 1/8	9 3/8	10 7/8	8 3/4	1 3/4	18.6	PN 31
*8 1/2,	9	6	2 1/4	2 1/4	2 1/8	10 1/4	11 1/8	9 3/8	9 3/4	1 3/4	23.8	PN 32
*9 1/4,	10	6	2 3/8	2 3/8	2 1/4	11 1/4	13	10 3/8	10 3/4	1 3/4	31.1	PN 33

Pins marked * are special.

COTTER PINS

AMERICAN BRIDGE COMPANY STANDARD

All Dimensions in Inches

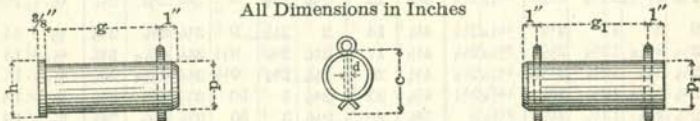

HORIZONTAL OR VERTICAL PIN FINISHED

HORIZONTAL PIN ROUGH OR FINISHED

Pin p	Head h	g	Cotter		Pin p1	g1	Cotter		
			c	d			c	d	
1 1/4	1 1/2	Net Grip + 1/2"	2	1/4	1 1/4	Net Grip + 3/4"	2	1/4	
1 1/2	1 3/4		2 1/2	1/4	1 1/2		2 1/2	2 1/2	1/4
1 3/4	2		2 3/4	1/4	1 3/4		2 3/4	2 3/4	1/4
2	2 3/8		3	3/8	2		3	3	1/4
2 1/4	2 5/8		3 1/4	3/8	2 1/4		3 1/4	3 1/4	1/4
2 1/2	2 7/8		3 3/4	3/8	2 1/2		3 3/4	3 3/4	1/4
2 3/4	3 1/8		4	3/8	2 3/4		4	4	1/4
2 5/8	3 3/8		4 1/4	3/8	2 5/8		4 1/4	4 1/4	1/4
3	3 1/2		5	1/2	3		5	5	1/4
3 1/4	3 3/4		5	1/2	3 1/4		5	5	1/4
3 1/2	4		6	1/2	3 1/2		6	6	1/4
3 3/4	4 1/4		6	1/2	3 3/4		6	6	1/4

RIVETS

STRUCTURAL RIVETS

AMERICAN BRIDGE COMPANY STANDARD

Dimensions in Inches

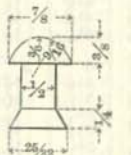
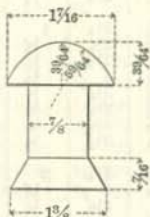
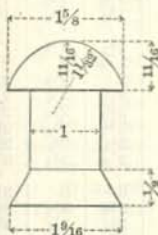
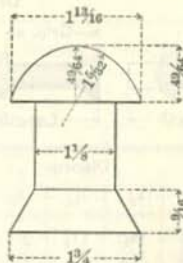
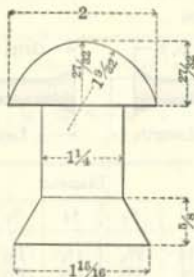

GENERAL FORMULAS FOR PROPORTIONS OF RIVETS, IN INCHES

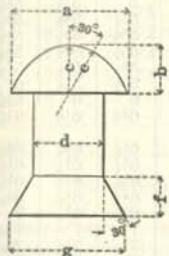

Full driven head, diameter, $a = 1.5 d + 1/8''$

" " " depth, $b = 0.425 a$

" " " radius, $c = b$

" " " radius, $e = 1.5 b$

Countersunk head, depth, $f = 0.5 d$

" " " diameter, $g = 1.577 d$

STRUCTURAL RIVETS

AMERICAN BRIDGE COMPANY STANDARD

LENGTHS OF FIELD RIVETS FOR VARIOUS GRIPS

Dimensions in Inches

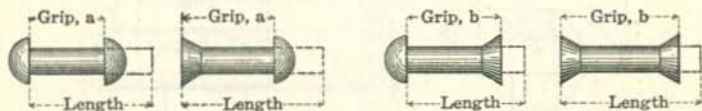

Grip a	Diameter					Grip b	Diameter				
	1/2	5/8	3/4	7/8	1		1/2	5/8	3/4	7/8	1
1/2	1 1/8	1 3/8	1 1/2	2	2 1/8	1/2	1 1/8	1 1/4	1 1/4	1 3/8	1 3/4
5/8	1 3/8	1 5/8	1 3/4	2 1/8	2 3/8	5/8	1 3/8	1 5/8	1 3/4	1 5/8	1 5/4
3/4	1 5/8	2	2 1/8	2 3/8	2 5/8	3/4	1 5/8	1 3/2	1 3/2	1 3/2	1 3/4
7/8	1 3/4	2 1/8	2 1/4	2 3/4	2 7/8	7/8	1 3/4	1 3/8	1 3/8	1 3/4	1 3/4
1	2	2 1/4	2 3/8	2 3/4	2 3/4	1	1 3/4	1 3/4	1 3/4	1 3/4	1 3/4
1 1/8	2 1/8	2 3/8	2 3/4	2 3/4	2 3/4	1 1/8	1 3/4	1 3/8	1 3/8	1 3/4	1 3/4
1 1/4	2 1/4	2 3/8	2 3/4	2 3/4	2 3/8	1 1/4	1 3/8	2	2	2 1/4	2 1/4
1 1/2	2 1/8	2 3/8	2 3/4	2 3/4	2 3/8	1 1/2	1 3/8	2	2	2 1/4	2 1/4
1 3/4	2 3/8	2 3/8	2 3/4	2 3/4	2 3/8	1 3/4	1 3/8	2 1/8	2 1/8	2 1/4	2 1/4
1 5/8	2 3/8	2 3/8	2 3/4	2 3/4	2 3/8	1 5/8	1 3/8	2 1/8	2 1/8	2 1/4	2 1/4
1 7/8	2 3/8	2 3/8	2 3/4	2 3/4	2 3/8	1 7/8	1 3/8	2 1/8	2 1/8	2 1/4	2 1/4
2	2 3/4	3	3 1/8	3 1/4	3 3/8	2	2 1/8	2 1/8	2 1/8	2 1/4	2 1/4
2 1/8	3 1/4	3 1/4	3 1/8	3 1/4	3 3/8	2 1/8	2 1/8	2 1/8	2 1/8	2 1/4	2 1/4
2 1/4	3 1/4	3 1/4	3 1/8	3 1/4	3 3/8	2 1/4	2 1/8	2 1/8	2 1/8	2 1/4	2 1/4
2 1/2	3 1/4	3 1/4	3 1/8	3 1/4	3 3/8	2 1/2	2 1/8	2 1/8	2 1/8	2 1/4	2 1/4
2 3/4	3 1/4	3 1/4	3 1/8	3 1/4	3 3/8	2 3/4	2 1/8	2 1/8	2 1/8	2 1/4	2 1/4
3	3 1/2	3 3/4	3 1/2	3 3/4	3 3/4	3	2 1/8	2 1/8	2 1/8	2 1/4	2 1/4
3 1/8	3 3/4	3 3/4	3 1/2	3 3/4	3 3/4	3 1/8	2 1/8	2 1/8	2 1/8	2 1/4	2 1/4
3 1/4	3 3/4	3 3/4	3 1/2	3 3/4	3 3/4	3 1/4	2 1/8	2 1/8	2 1/8	2 1/4	2 1/4
3 1/2	3 3/4	3 3/4	3 1/2	3 3/4	3 3/4	3 1/2	2 1/8	2 1/8	2 1/8	2 1/4	2 1/4
3 3/4	3 3/4	3 3/4	3 1/2	3 3/4	3 3/4	3 3/4	2 1/8	2 1/8	2 1/8	2 1/4	2 1/4
3 5/8	3 3/4	3 3/4	3 1/2	3 3/4	3 3/4	3 5/8	2 1/8	2 1/8	2 1/8	2 1/4	2 1/4
4	4 1/8	4 1/8	4 1/2	4 1/2	4 3/8	4	2 1/8	2 1/8	2 1/8	2 1/4	2 1/4
4 1/8	4 1/8	4 1/8	4 1/2	4 1/2	4 3/8	4 1/8	2 1/8	2 1/8	2 1/8	2 1/4	2 1/4
4 1/4	4 1/8	4 1/8	4 1/2	4 1/2	4 3/8	4 1/4	2 1/8	2 1/8	2 1/8	2 1/4	2 1/4
4 1/2	4 1/8	4 1/8	4 1/2	4 1/2	4 3/8	4 1/2	2 1/8	2 1/8	2 1/8	2 1/4	2 1/4
4 3/4	4 1/8	4 1/8	4 1/2	4 1/2	4 3/8	4 3/4	2 1/8	2 1/8	2 1/8	2 1/4	2 1/4
5	4 3/4	4 3/4	4 1/2	4 3/4	4 3/4	5	2 1/8	2 1/8	2 1/8	2 1/4	2 1/4
5 1/8	4 3/4	4 3/4	4 1/2	4 3/4	4 3/4	5 1/8	2 1/8	2 1/8	2 1/8	2 1/4	2 1/4
5 1/4	4 3/4	4 3/4	4 1/2	4 3/4	4 3/4	5 1/4	2 1/8	2 1/8	2 1/8	2 1/4	2 1/4
5 1/2	4 3/4	4 3/4	4 1/2	4 3/4	4 3/4	5 1/2	2 1/8	2 1/8	2 1/8	2 1/4	2 1/4
5 3/4	4 3/4	4 3/4	4 1/2	4 3/4	4 3/4	5 3/4	2 1/8	2 1/8	2 1/8	2 1/4	2 1/4
6	4 3/4	4 3/4	4 1/2	4 3/4	4 3/4	6	2 1/8	2 1/8	2 1/8	2 1/4	2 1/4
6 1/8	4 3/4	4 3/4	4 1/2	4 3/4	4 3/4	6 1/8	2 1/8	2 1/8	2 1/8	2 1/4	2 1/4
6 1/4	4 3/4	4 3/4	4 1/2	4 3/4	4 3/4	6 1/4	2 1/8	2 1/8	2 1/8	2 1/4	2 1/4
6 1/2	4 3/4	4 3/4	4 1/2	4 3/4	4 3/4	6 1/2	2 1/8	2 1/8	2 1/8	2 1/4	2 1/4
6 3/4	4 3/4	4 3/4	4 1/2	4 3/4	4 3/4	6 3/4	2 1/8	2 1/8	2 1/8	2 1/4	2 1/4
7	4 3/4	4 3/4	4 1/2	4 3/4	4 3/4	7	2 1/8	2 1/8	2 1/8	2 1/4	2 1/4
7 1/8	4 3/4	4 3/4	4 1/2	4 3/4	4 3/4	7 1/8	2 1/8	2 1/8	2 1/8	2 1/4	2 1/4
7 1/4	4 3/4	4 3/4	4 1/2	4 3/4	4 3/4	7 1/4	2 1/8	2 1/8	2 1/8	2 1/4	2 1/4
7 1/2	4 3/4	4 3/4	4 1/2	4 3/4	4 3/4	7 1/2	2 1/8	2 1/8	2 1/8	2 1/4	2 1/4
7 3/4	4 3/4	4 3/4	4 1/2	4 3/4	4 3/4	7 3/4	2 1/8	2 1/8	2 1/8	2 1/4	2 1/4
8	4 3/4	4 3/4	4 1/2	4 3/4	4 3/4	8	2 1/8	2 1/8	2 1/8	2 1/4	2 1/4
8 1/8	4 3/4	4 3/4	4 1/2	4 3/4	4 3/4	8 1/8	2 1/8	2 1/8	2 1/8	2 1/4	2 1/4
8 1/4	4 3/4	4 3/4	4 1/2	4 3/4	4 3/4	8 1/4	2 1/8	2 1/8	2 1/8	2 1/4	2 1/4
8 1/2	4 3/4	4 3/4	4 1/2	4 3/4	4 3/4	8 1/2	2 1/8	2 1/8	2 1/8	2 1/4	2 1/4
8 3/4	4 3/4	4 3/4	4 1/2	4 3/4	4 3/4	8 3/4	2 1/8	2 1/8	2 1/8	2 1/4	2 1/4
9	4 3/4	4 3/4	4 1/2	4 3/4	4 3/4	9	2 1/8	2 1/8	2 1/8	2 1/4	2 1/4

RIVETS

STRUCTURAL RIVETS

AMERICAN BRIDGE COMPANY STANDARD

WEIGHT IN POUNDS PER 100 RIVETS WITH BUTTON HEADS

Length Under Head, Inches	Diameter of Rivet, Inches								Length Under Head, Inches	Diameter of Rivet, Inches							
	3/8	1/2	5/8	3/4	7/8	1	1 1/8	1 1/4		3/8	1/2	5/8	3/4	7/8	1	1 1/8	1 1/4
									5	18	33	53	78	109	146	190	252
									1/2	18	34	54	80	111	149	193	256
1 1/4	6	12							3/4	19	34	55	82	113	152	197	260
3/8	7	13							5/8	19	35	56	83	115	155	200	265
1/2	7	13	23	35	50	68	91	130	1/2	20	36	57	85	118	157	204	269
5/8	7	14	24	36	52	71	95	134	5/8	20	36	58	86	120	160	207	273
3/4	8	15	25	37	54	74	98	139	3/4	20	37	60	88	122	163	211	278
7/8	8	15	26	39	56	77	102	143	7/8	21	38	61	89	124	166	214	282
2	9	16	27	41	58	80	105	148	6	21	38	62	91	126	169	218	287
3/8	9	17	28	43	60	82	109	152	1/2	22	39	63	93	128	171	222	291
1/2	9	18	29	44	62	85	112	156	3/4	22	40	64	94	130	174	225	295
5/8	10	18	30	46	64	88	116	161	5/8	22	40	65	96	132	177	229	300
3/4	10	19	31	47	67	91	119	165	1/2	23	41	66	97	135	180	232	304
7/8	11	20	32	49	69	93	123	169	3/4	23	42	67	99	137	182	236	308
2	11	20	34	50	71	96	126	174	5/8	24	43	68	100	139	185	239	313
3/8	11	21	35	52	73	99	130	178	7/8	24	43	69	102	141	188	243	317
1/2	12	22	36	54	75	102	133	182	7	24	44	70	104	143	191	246	321
5/8	12	22	37	55	77	105	137	187	1/2	25	45	71	105	145	194	250	326
3/4	13	23	38	57	79	107	141	191	3/4	25	45	73	107	147	196	253	330
7/8	13	24	39	58	81	110	144	195	5/8	26	46	74	108	149	199	257	334
2	13	24	40	60	84	113	148	200	1/2	26	47	75	110	152	202	260	339
3/8	14	25	41	61	86	116	151	204	3/4	26	47	76	111	154	205	264	343
1/2	14	26	42	63	88	118	155	208	5/8	27	48	77	113	156	207	267	347
5/8	15	27	43	64	90	121	158	213	7/8	27	49	78	114	158	210	271	352
3/4	15	27	44	66	92	124	162	217	8	27	50	79	116	160	213	274	356
7/8	15	28	45	68	94	127	165	221	1/2	28	50	80	118	162	216	278	360
2	16	29	47	69	96	130	169	226	3/4	28	51	81	119	164	219	281	365
3/8	16	29	48	71	98	132	172	230	5/8	29	52	82	121	166	221	285	369
1/2	16	30	49	72	101	135	176	234	7/8	29	52	83	122	169	224	288	373
5/8	17	31	50	74	103	138	179	239	1/2	29	53	84	124	171	227	292	378
3/4	17	31	51	75	105	141	183	243	3/4	30	54	86	125	173	230	295	382
7/8	18	32	52	77	107	143	186	247	7/8	30	54	87	127	175	232	299	386

Button Heads	Diameter of Rivets, Inches							
	3/8	1/2	5/8	3/4	7/8	1	1 1/8	1 1/4
100 Heads as made on rivets, Pounds...	2.4	5.0	9.7	16.0	24.0	35.0	49.0	78.0
100 Heads as driven in work, Pounds...	1.9	4.0	7.5	12.5	18.5	27.0	37.5	51.0

AMERICAN BRIDGE COMPANY

SPECIFICATIONS

FOR

STEEL STRUCTURES

DESIGN, DETAILS OF CONSTRUCTION AND WORKMANSHIP

ADOPTED 1912

DESIGN

1. **Loads.** The steel frame of all structures shall be designed so as to safely support the dead and live loads. The dead load shall consist of the weight of all permanent construction and fixtures, such as walls, floors, roofs, interior partitions, and fixed or permanent appliances. The live load shall consist of movable loads on floors, loads due to machinery or other appliances, and the exterior loads due to snow on the roof and to wind.

2. For structures carrying traveling machinery, such as cranes, conveyors, etc., 25 per cent shall be added to the stresses resulting from such live load, to provide for the effect of impact and vibrations.

3. The wind pressure shall be assumed acting horizontally in any direction as follows:—

First: For finished structures—A pressure of 20 pounds per square foot on the sides and ends of buildings and on the vertical projection of roof surfaces, or

Second: In process of construction—A pressure of 30 pounds per square foot on vertical surfaces and the vertical projection of inclined surfaces of all exposed metal or other frame work.

CONSTRUCTION SPECIFICATIONS

4. **Unit Stresses.** All parts of structures shall be proportioned so that the sum of the dead and live loads, together with the impact, if any, shall not cause the stresses to exceed the following unit stresses in pounds per square inch:

Tension, net section, rolled steel.....	16000
Direct compression, rolled steel and steel castings.....	16000
Bending, on extreme fibers of rolled shapes, built sections, girders, and steel castings.....	16000
Bending on extreme fibers of pins.....	24000
Shear on shop rivets and pins.....	12000
Shear on bolts and field rivets.....	10000
Shear—average—on webs of plate girders and rolled beams, gross section.....	10000
Bearing pressure on shop rivets and pins.....	24000
Bearing on bolts and field rivets.....	20000
Pressure per linear inch on expansion rollers shall not exceed 600 times the diameter of rollers in inches.	

Axial compression of gross sections of columns, for
 ratio of l/r up to 120.....19000—100 l/r
 with a maximum of.....13000
 where l =effective length of member in inches,
 r =corresponding radius of gyration of section in inches.

For ratios of l/r up to 120, and for greater ratios up to 200, use the maximum stresses given in the following table. For intermediate ratios, proportional amounts are used.

Unit Stress: 19000—100 l/r		Unit Stress: 13000—50 l/r	
Ratio, l/r	Max. Stress, lb./sq. in.	Ratio, l/r	Max. Stress, lb./sq. in.
60	13000	130	6500
70	12000	140	6000
80	11000	150	5500
90	10000	160	5000
100	9000	170	4500
110	8000	180	4000
120	7000	190	3500

5. For bracing and combined stresses due to wind and other loading, the permissible working stresses may be increased 25 per cent—provided the section thus found is not less than that required by the dead and live loads alone.

PROPORTION OF PARTS

6. **General.** The effective or unsupported length of main compression members shall not exceed 120 times and for secondary members 200 times the least radius of gyration.

7. In proportioning columns, provision must be made for eccentric loading.

8. In proportioning tension members, net section must be used. Rivet holes deducted must be taken $\frac{1}{8}$ inch larger than the nominal size of rivets.

9. Members subject to the action of both axial and bending stresses shall be proportioned so that the greatest fiber stress will not exceed the allowed limits in that member.

10. Members subject to alternate stresses of tension and compression shall be proportioned for the stress giving the largest section, but their connections shall be proportioned for the sum of the stresses.

11. **Girders.** Rolled beams and channels, and built-up members used as beams and girders shall be proportioned by the moment of inertia of their gross sections.

12. Plate girder webs shall have a thickness not less than $\frac{1}{160}$ of the unsupported distance between flange angles. The webs shall have stiffeners, generally in pairs, over bearings, at points of concentrated loading, and at other points where the thickness of the web is less than $\frac{1}{60}$ of the unsupported distance between flange angles, generally not farther apart than the depth of the web plate, with a maximum limit of 6 feet.

13. The lateral unsupported length of beams and girders shall not exceed forty times the width of the compression flange. When the unsupported length (l) exceeds ten times the width (b) of the compression flange, the stress per square inch in the compression flange shall not exceed $19000 - 300 l/b$.

DETAILS OF STEEL CONSTRUCTION

14. **General.** Adjustable members in any part of structures shall preferably be avoided.

15. Sections shall preferably be made symmetrical.

16. No connection, except lattice bars, shall have less than two rivets.

CONSTRUCTION SPECIFICATIONS

17. Trusses shall preferably be riveted structures. Heavy trusses of long span, where the riveted field connections would become unwieldy, or for other good reasons, may be designed as pin-connected structures.

18. Abutting joint in compression members faced for bearing shall be spliced sufficiently to hold the connecting members accurately in place. All other joints in riveted work, whether in tension or compression, shall be fully spliced.

19. Lateral, longitudinal and transverse bracing in all structures shall preferably be composed of rigid members, and shall be designed to be sufficient to withstand wind and other lateral forces when building is in process of erection as well as after completion.

20. **Girders.** When two or more rolled beams are used to form a girder, they shall be connected by bolts and separators at intervals of not more than 5 feet. All beams having a depth of 12 inches and more shall have at least two bolts to each separator.

21. The flange plates of all girders shall be limited in width, so as not to extend more than 6 inches beyond the outer line of rivets connecting them to the angles, or eight times the thickness of the thinnest plate.

22. Web stiffeners shall be in pairs and shall have a close bearing against the flange angles. Those over the end bearing or forming the connection between girder and column shall be on fillers. Intermediate stiffeners may be on fillers or crimped over the flange angles.

23. Web plates of girders must be spliced at all points by a plate on each side of the web, capable of transmitting the full stress through splice rivets.

24. **Riveting.** The minimum distance between centers of rivet holes shall be three diameters of the rivet; but the distance shall preferably be not less than 3 inches for $\frac{1}{8}$ -inch rivets, $2\frac{1}{2}$ inches for $\frac{3}{4}$ -inch rivets, 2 inches for $\frac{5}{8}$ -inch rivets, and $1\frac{3}{4}$ inches for $\frac{1}{2}$ -inch rivets. The maximum pitch in the line of stress of compression members composed of plates and shapes will not exceed sixteen times the thinnest outside plate with a maximum of 12 inches, or twenty times the thinnest enclosed plate with a maximum of 15 inches. Rivets used to stitch two or more plates or shapes together, not in line of stress, will be spaced not to exceed twenty-four times the thinnest plate or shape.

25. For angles in built sections with two gage lines, with rivets staggered, the maximum pitch in the line of stress in each gage line shall not exceed twenty-four times the thinnest plate, with a maximum of 18 inches.

26. The minimum distance from the center of any rivet hole to a sheared edge shall be $1\frac{1}{2}$ inches for $\frac{7}{8}$ -inch rivets, $1\frac{1}{4}$ inches for $\frac{3}{4}$ -inch rivets, $1\frac{1}{8}$ inches for $\frac{5}{8}$ -inch rivets, and 1 inch for $\frac{1}{2}$ -inch rivets; and to a rolled edge, $1\frac{1}{4}$, $1\frac{1}{8}$, 1, and $\frac{7}{8}$ inches, respectively.

27. The maximum distance from any edge shall be eight times the thickness of the plate.

28. The pitch of rivets at the ends of built compression members shall not exceed four diameters of the rivets for a length equal to one and one-half times the maximum width of the member.

29. **Latticing.** The open sides of compression members shall be provided with lattice bars, having tie plates at each end and at intermediate points where the lattice is interrupted. The tie plates shall be as near the ends as practicable. In main members carrying calculated stresses, the end tie plates shall have a length not less than the distance between the lines of rivets connecting them to the flanges, and intermediate ones not less than half this distance. Their thickness shall not be less than $\frac{1}{50}$ of the same distance.

30. The latticing of compression members shall be proportioned to resist a shearing stress equal to 2 per cent of the direct stress. The minimum thickness of lattice bars shall be for single lattice, $\frac{1}{40}$, and for double lattice, $\frac{1}{60}$ of the distance between the end rivets. Their minimum width shall be as follows:

- For 15-inch channels, or
built sections with $3\frac{1}{2}$ and 4-inch angles, $2\frac{1}{2}$ inches ($\frac{3}{8}$ -inch rivets).
- For 12-10-and 9-inch channels, or
built sections with 3-inch angles $2\frac{1}{4}$ inches ($\frac{3}{4}$ -inch rivets).
- For 8-and 7-inch channels, or
built sections with $2\frac{1}{2}$ -inch angles 2 inches ($\frac{5}{8}$ -inch rivets).
- For 6-and 5-inch channels, or
built sections with 2-inch angles $1\frac{3}{4}$ inches ($\frac{1}{2}$ -inch rivets).

31. The inclination of lattice bars with the axis of the member shall generally be not less than 45 degrees. When the distance between the rivet lines in the flanges is more than 15 inches, if a single rivet bar is used, the lattice shall be double.

32. The pitch of lattice connections, along the flange, divided by the least radius of gyration of the member between connections, shall be less than the corresponding ratio of the member as a whole.

CONSTRUCTION SPECIFICATION

33. **Pins.** Pin holes shall be reinforced by plates where necessary. At least one plate shall be as wide as the projecting flanges will allow; where angles are used, this plate shall be on the same side as the angles. The plates shall contain sufficient rivets to distribute their portion of the pin pressure to the full cross section of the member.

34. Pins shall be long enough to insure a full bearing of all parts connected upon the turned-down body of the pin. Members packed on pins shall be held against lateral movement.

WORKMANSHIP

35. **General.** The workmanship shall be equal to the best practice in modern structural works. Shearing shall be done accurately, and all portions of the work exposed to view shall be neatly finished.

36. **Punching.** The diameter of the punch shall not be more than $\frac{1}{16}$ inch, nor that of the die more than $\frac{1}{8}$ inch, larger than the diameter of the rivet. Punching shall be done accurately, but an occasional slight inaccuracy in the matching of holes may be corrected with reamer. Drifting to enlarge unfair holes will not be allowed.

37. **Riveting.** The size of rivets shall be as called for on the plans. Rivets shall be driven by pressure tools wherever possible. Pneumatic hammers shall be used in preference to hand driving. Rivets shall look neat and finished, with heads of approved shape, full and of equal size. They shall be centered on the shank and shall grip the assembled pieces firmly.

38. **Assembling.** Riveted members shall have all parts well pinned up and firmly drawn together with bolts before riveting is commenced. Contact surfaces shall be painted. Abutting joints shall be cut or dressed true and straight and fitted closely together. In compression joints depending on contact bearing, the surfaces shall be truly faced, so as to have even bearing after they are riveted up complete and when perfectly aligned. The several pieces forming one built member shall be straight and shall fit closely together, and finished members shall be free from twists, bends or open joints.

39. **Eye Bars.** Eye bars shall be straight and true to size, and shall be free from twists, folds in the neck or head, or any other defect. Heads shall be made by upsetting, rolling or forging. Welding will not be allowed. Before boring, each eye bar shall be perfectly annealed and carefully straightened. Pin holes shall be in the center line of bars and in the center of heads. Bars of the same length shall be bored so accurately that, when placed together, pins $\frac{1}{32}$ inch smaller in diameter than the pin holes can be passed through the holes at both ends of the bars at the same time.

40. **Pins.** Pins and rollers shall be turned accurately to gages, and shall be straight, smooth and entirely free from flaws. Pin holes shall be bored true to gages, smooth and straight, at right angles to the axis of the member and parallel to each other, unless otherwise called for. Wherever possible, the boring shall be done after the member is riveted up. The distance from center to center of pin holes shall be correct within $\frac{1}{32}$ inch, and the diameter of the hole not more than $\frac{1}{50}$ inch larger than that of the pin for pins up to 5 inches diameter, and $\frac{1}{32}$ inch for larger pins.

41. **Bed Plates.** Expansion bed plates shall be planed true and smooth. The cut of the planing tool shall correspond with the direction of expansion.

42. **Annealing.** Steel, except in minor details, which has been partially heated, shall be properly annealed. Welds in steel will not be allowed. All steel castings shall be annealed.

43. **Painting.** Steel work, before leaving the shop, shall be thoroughly cleaned and given one good coating of such paint as may be called for, well worked into all joints and open spaces.

44. In riveted work, the surfaces coming in contact shall be painted before being riveted together.

45. Machine-finished bearing surfaces coming in contact with similar surfaces should be coated with white lead and tallow before shipment.

46. **Inspection.** The manufacturer shall furnish all facilities for inspecting and testing the weight, quality of material and workmanship. He shall furnish a suitable testing machine for testing the specimens, as well as prepare the pieces for the machine free of charge.

47. He shall give the inspector for the purchaser free access to all parts of the works where the material under inspection is manufactured.

ELEMENTS OF SECTIONS

In the computation of the values of structural shapes for the various conditions under which they are subjected to stress, certain mathematical expressions are used. In the tables of Elements of Sections, which follow, these values or properties are given in inch-units.

Neutral Axis. The line, in the cross section of a beam or column in a state of flexure, on which there is neither tension nor compression; the neutral axis passes through the center of gravity of the section when unit stresses do not exceed the elastic limit of the material. In the usual position of structural sections there are two neutral axes, perpendicular to each other, their normal distance from extreme fiber of the section being designated by x and y .

Moment of Inertia— I . The sum of the products obtained by multiplying each of the elementary areas of which the section is composed, by the square of its normal distance from a neutral axis of the section or from any axis of moments assumed for purposes of calculation.

Section Modulus— S . The moment of inertia divided by the normal distance from the axis to which it refers to extreme fiber of the section. For the two moments of inertia, corresponding to the two principal axes of a section, there are also two section moduli.

The section modulus is used to determine the stress in the extreme fiber of a section, subjected to bending stresses, by dividing the bending moment by the section modulus referred to neutral axis normal to line of force, both values being expressed in like units of measure; the section modulus of a section, is obtained by dividing the bending stress by the allowable fiber stress, both values also in like units of measure; the proper section is then obtained from this section modulus by reference to the tables of Elements of Sections.

Radius of Gyration— r . The normal distance from a neutral axis to the center of gyration, the point where the entire area is considered to be concentrated and have the same moment of inertia as the actual area. The radius of gyration of a section referred to a neutral axis, or any axis of moments, is equal to the square root of (moment of inertia, referred to that axis, divided by the area).

The radius of gyration of a section is used to ascertain the safe load this section will sustain when used in compression, as a strut or column. The unbraced length of the section divided by the least radius of gyration is denominated the Ratio of Slenderness.

The elements and also the areas of structural sections on pages 110 to 129 have been computed from theoretical straight-line dimensions in accordance with formulas given on pages 106 and 107, and no account has been taken of fillets and roundings.

SQUARE
Axis of moments through center

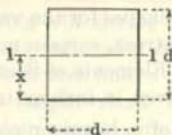

$$A = d^2$$

$$x = \frac{d}{2}$$

$$I_{1-1} = \frac{d^4}{12}$$

$$S_{1-1} = \frac{d^3}{6}$$

$$r_{1-1} = \frac{d}{\sqrt{12}} = 0.288675d$$

SQUARE
Axis of moments on base

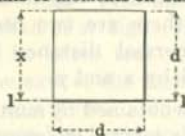

$$A = d^2$$

$$x = d$$

$$I_{1-1} = \frac{d^4}{3}$$

$$S_{1-1} = \frac{d^3}{3}$$

$$r_{1-1} = \frac{d}{\sqrt{3}} = 0.577350d$$

SQUARE
Axis of moments on diagonal

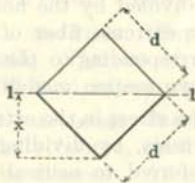

$$A = d^2$$

$$x = \frac{d}{\sqrt{2}} = 0.707107d$$

$$I_{1-1} = \frac{d^4}{12}$$

$$S_{1-1} = \frac{d^3}{6\sqrt{2}} = 0.117851 d^3$$

$$r_{1-1} = \frac{d}{\sqrt{12}} = 0.288675d$$

HOLLOW SQUARE
Axis of moments through center

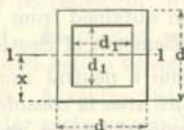

$$A = d^2 - d_1^2$$

$$x = \frac{d}{2}$$

$$I_{1-1} = \frac{d^4 - d_1^4}{12}$$

$$S_{1-1} = \frac{d^3 - d_1^3}{6d}$$

$$r_{1-1} = \sqrt{\frac{d^2 + d_1^2}{12}}$$

HOLLOW SQUARE
Axis of moments on diagonal

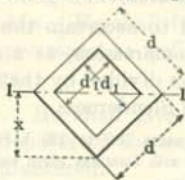

$$A = d^2 - d_1^2$$

$$x = \frac{d}{\sqrt{2}}$$

$$I_{1-1} = \frac{d^4 - d_1^4}{12}$$

$$S_{1-1} = \frac{d^3 - d_1^3}{6d\sqrt{2}} = 0.117851 \frac{d^3 - d_1^3}{d}$$

$$r_{1-1} = \sqrt{\frac{d^2 + d_1^2}{12}} = 0.288675 \sqrt{d^2 + d_1^2}$$

ELEMENTS OF SECTIONS

RECTANGLE
Axis of moments through center

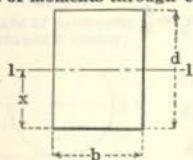

$$A = bd$$

$$x = \frac{d}{2}$$

$$I_{1-1} = \frac{bd^3}{12}$$

$$S_{1-1} = \frac{bd^2}{6}$$

$$r_{1-1} = \frac{d}{\sqrt{12}} = 0.288675d$$

RECTANGLE
Axis of moments on base



$$A = bd$$

$$x = d$$

$$I_{1-1} = \frac{bd^3}{3}$$

$$S_{1-1} = \frac{bd^2}{3}$$

$$r_{1-1} = \frac{d}{\sqrt{3}} = 0.577350d$$

RECTANGLE
Axis of moments on diagonal

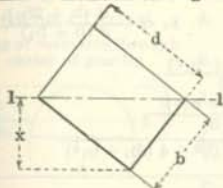

$$A = bd$$

$$x = \frac{bd}{\sqrt{b^2+d^2}}$$

$$I_{1-1} = \frac{b^3 d^3}{6(b^2+d^2)}$$

$$S_{1-1} = \frac{b^2 d^2}{6\sqrt{b^2+d^2}}$$

$$r_{1-1} = \frac{bd}{\sqrt{6(b^2+d^2)}}$$

RECTANGLE
Axis of moments any line through center of gravity

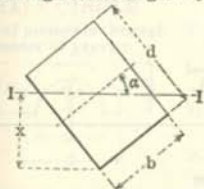

$$A = bd$$

$$x = \frac{b \sin \alpha + d \cos \alpha}{2}$$

$$I_{1-1} = \frac{bd(b^2 \sin^2 \alpha + d^2 \cos^2 \alpha)}{12}$$

$$S_{1-1} = \frac{bd(b^2 \sin^2 \alpha + d^2 \cos^2 \alpha)}{6(b \sin \alpha + d \cos \alpha)}$$

$$r_{1-1} = \sqrt{\frac{b^2 \sin^2 \alpha + d^2 \cos^2 \alpha}{12}}$$

HOLLOW RECTANGLE
Axis of moments through center

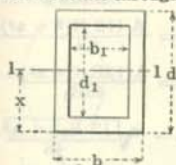

$$A = bd - b_1 d_1$$

$$x = \frac{d}{2}$$

$$I_{1-1} = \frac{bd^3 - b_1 d_1^3}{12}$$

$$S_{1-1} = \frac{bd^2 - b_1 d_1^2}{6d}$$

$$r_{1-1} = \sqrt{\frac{bd^3 - b_1 d_1^3}{12(bd - b_1 d_1)}}$$

TRIANGLE
Axis of moments through center of gravity

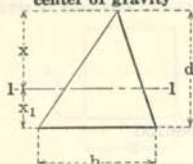

$$A = \frac{bd}{2}$$

$$x = \frac{2d}{3}$$

$$x_1 = \frac{d}{3}$$

$$I_{1-1} = \frac{bd^3}{36}$$

$$S_{1-1} = \frac{bd^2}{24}$$

$$r_{1-1} = \frac{d}{\sqrt{18}} = 0.235702d$$

TRIANGLE
Axis of moments on base

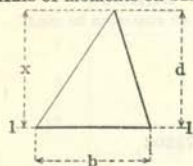

$$A = \frac{bd}{2}$$

$$x = d$$

$$I_{1-1} = \frac{bd^3}{12}$$

$$S_{1-1} = \frac{bd^2}{12}$$

$$r_{1-1} = \frac{d}{\sqrt{6}} = 0.408248d$$

TRAPEZOID
Axis of moments through center of gravity

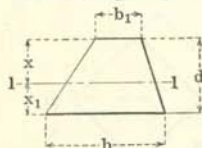

$$A = \frac{d(b + b_1)}{2}$$

$$x = \frac{d(b_1 + 2b)}{3(b + b_1)}$$

$$x_1 = \frac{d(b + 2b_1)}{3(b + b_1)}$$

$$I_{1-1} = \frac{d^3(b^2 + 4bb_1 + b_1^2)}{36(b + b_1)}$$

$$S_{1-1} = \frac{d^2(b^2 + 4bb_1 + b_1^2)}{12(b_1 + 2b)}$$

$$r_{1-1} = \frac{d}{6(b + b_1)} \sqrt{2(b^2 + 4bb_1 + b_1^2)}$$

TRAPEZOID
Axis of moments on base

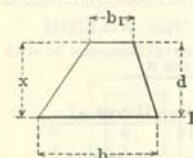

$$A = \frac{d(b + b_1)}{2}$$

$$x = d$$

$$I_{1-1} = \frac{d^3(b + 3b_1)}{12}$$

$$S_{1-1} = \frac{d^2(b + 3b_1)}{12}$$

$$r_{1-1} = \frac{d}{\sqrt{6}} \sqrt{\frac{b + 3b_1}{b + b_1}}$$

REGULAR POLYGON
Axis of moments through center

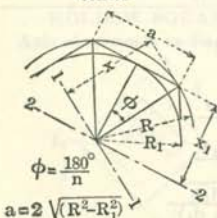

$n =$ Number of Sides

$$A = \frac{1}{4} na^2 \cot \phi = \frac{1}{2} nR^2 \sin 2\phi = nR^2 \tan \phi$$

$$x = R = \frac{a}{2 \sin \phi} \quad x_1 = R_1 = \frac{a}{2 \tan \phi}$$

$$I_{1-1} = \frac{A(6R^2 - a^2)}{24} = I_{2-2} = \frac{A(12R_1^2 + a^2)}{48}$$

$$S_{1-1} = \frac{A(6R^2 - a^2)}{24R} \quad S_{2-2} = \frac{A(12R_1^2 + a^2)}{48R_1}$$

$$r_{1-1} = \sqrt{\frac{6R^2 - a^2}{24}} = r_{2-2} = \sqrt{\frac{12R_1^2 + a^2}{48}}$$

$$a = 2\sqrt{R^2 - R_1^2}$$

ELEMENTS OF SECTIONS

CIRCLE
Axis of moments
through center



$$A = \frac{\pi d^2}{4} = 0.785398 d^2$$

$$x = \frac{d}{2}$$

$$I_{1-1} = \frac{\pi d^4}{64} = 0.049087 d^4$$

$$S_{1-1} = \frac{\pi d^3}{32} = 0.098175 d^3$$

$$r_{1-1} = \frac{d}{4}$$

HOLLOW CIRCLE
Axis of moments
through center



$$A = \frac{\pi (d^2 - d_1^2)}{4} = 0.785398 (d^2 - d_1^2)$$

$$x = \frac{d}{2}$$

$$I_{1-1} = \frac{\pi (d^4 - d_1^4)}{64} = 0.049087 (d^4 - d_1^4)$$

$$S_{1-1} = \frac{\pi (d^4 - d_1^4)}{32d} = 0.098175 \frac{(d^4 - d_1^4)}{d}$$

$$r_{1-1} = \frac{\sqrt{d^2 + d_1^2}}{4}$$

HALF CIRCLE
Axis of moments through
center of gravity

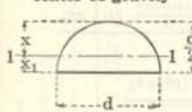

$$A = \frac{\pi d^2}{8} = 0.392699 d^2$$

$$x = \frac{d(3\pi - 4)}{6\pi} = 0.287793d \quad x_1 = \frac{2d}{3\pi} = 0.212207d$$

$$I_{1-1} = \frac{d^4(9\pi^2 - 64)}{1152\pi} = 0.006860 d^4$$

$$S_{1-1} = \frac{d^3(9\pi^2 - 64)}{192(3\pi - 4)} = 0.023836 d^3$$

$$r_{1-1} = d \sqrt{\frac{9\pi^2 - 64}{12\pi}} = 0.132168 d$$

HOLLOW HALF CIRCLE
Axis of moments through
center of gravity

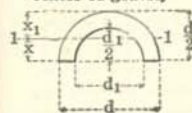

$$A = \frac{\pi(d^2 - d_1^2)}{8} = 0.392699 (d^2 - d_1^2)$$

$$x = \frac{2(d^2 - d_1^2)}{3\pi(d^2 - d_1^2)} \quad x_1 = \frac{3\pi d(d^2 - d_1^2) - 4(d^3 - d_1^3)}{6\pi(d^2 - d_1^2)}$$

$$I_{1-1} = \frac{9\pi^2(d^4 - d_1^4)(d^2 - d_1^2) - 64(d^3 - d_1^3)^2}{1152\pi(d^2 - d_1^2)}$$

$$S_{1-1} = \frac{I}{x} \text{ if } x > x_1 \quad S_{1-1} = \frac{I}{x_1} \text{ if } x_1 > x$$

$$r_{1-1} = \frac{1}{12\pi} \sqrt{\frac{9\pi^2(d^4 - d_1^4)(d^2 - d_1^2) - 64(d^3 - d_1^3)^2}{(d^2 - d_1^2)^2}}$$

ELLIPSE
Axis of moments
through center

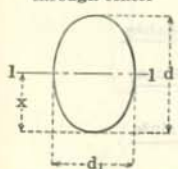

$$A = \frac{\pi d d_1}{4} = 0.785398 d d_1$$

$$x = \frac{d}{2}$$

$$I_{1-1} = \frac{\pi d^3 d_1}{64} = 0.049087 d^3 d_1$$

$$S_{1-1} = \frac{\pi d^2 d_1}{32} = 0.098175 d^2 d_1$$

$$r_{1-1} = \frac{d}{4}$$

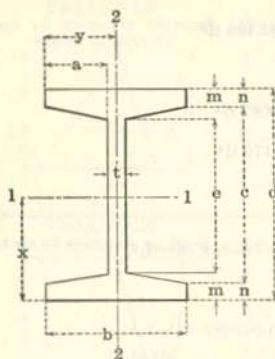

BEAM

$$A = dt + 2a(m+n)$$

$$x = \frac{d}{2}$$

$$y = \frac{b}{2}$$

$$I_{1-1} = \frac{bd^3 - \frac{a}{4(m-n)}(c^4 - e^4)}{12}$$

$$I_{2-2} = \frac{2nb^3 + et^3 + \frac{m-n}{4a}(b^4 - t^4)}{12}$$

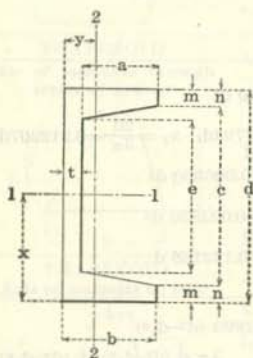

CHANNEL

$$A = dt + a(m+n)$$

$$x = \frac{d}{2}$$

$$y = \frac{b^2n + \frac{ct^2}{2} + \frac{a(m-n)}{3}(b+2t)}{A}$$

$$I_{1-1} = \frac{bd^3 - \frac{a}{8(m-n)}(c^4 - e^4)}{12}$$

$$I_{2-2} = \frac{2nb^3 + et^3 + \frac{m-n}{2a}(b^4 - t^4)}{3} - Ay^2$$

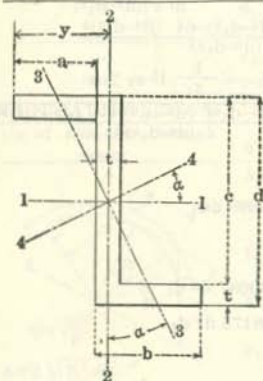

ZEE

$$A = t(d+2a)$$

$$x = \frac{d}{2}$$

$$y = \frac{2b-t}{2}$$

$$\tan 2\alpha = \frac{(dt-t^2)(b^2-bt)}{I_{1-1} - I_{2-2}}$$

$$I_{1-1} = \frac{bd^3 - a(d-2t)^2}{12}$$

$$I_{2-2} = \frac{d(b+a)^2 - 2a^2c - 6ab^2c}{12}$$

$$I_{3-3} = \frac{I_{2-2} \cos^2\alpha - I_{1-1} \sin^2\alpha}{\cos 2\alpha}$$

$$I_{4-4} = \frac{I_{1-1} \cos^2\alpha - I_{2-2} \sin^2\alpha}{\cos 2\alpha}$$

ELEMENTS OF SECTIONS

EQUAL ANGLE

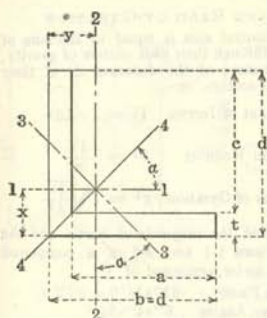

$$A = t(b+c)$$

$$x = \frac{b^2+ct}{2(b+c)}$$

$$y = x$$

$$a = 45^\circ$$

$$I_{1-1} = \frac{t(b-x)^3+bx^3-a(x-t)^3}{3}$$

$$I_{2-2} = I_{1-1}$$

$$I_{3-3} = \frac{ct^3+c^3t+3ct(b-4x+2t)^2+t^4+6t^2(2x-t)^2}{12}$$

$$I_{4-4} = \frac{ct^3+c^3t+3ctb^2+t^4}{12}$$

UNEQUAL ANGLE

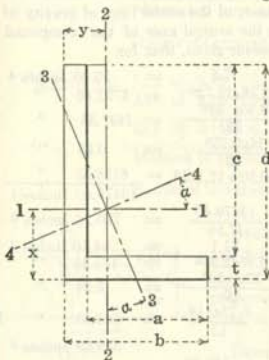

$$A = t(b+c)$$

$$x = \frac{t(b+2c)+c^2}{2(b+c)}$$

$$y = \frac{t(2a+d)+a^2}{2(a+d)}$$

$$\tan 3a = \frac{t(2y-t)d(d-2x)+a(2x-t)(b+t-2y)}{2(I_{1-1}-I_{2-2})}$$

$$I_{1-1} = \frac{t(d-x)^3+bx^3-a(x-t)^3}{3}$$

$$I_{2-2} = \frac{t(b-y)^3+dy^3-c(y-t)^3}{3}$$

$$I_{3-3} = \frac{I_{2-2}\cos^2 a - I_{1-1}\sin^2 a}{\cos 2a}$$

$$I_{4-4} = \frac{I_{1-1}\cos^2 a - I_{2-2}\sin^2 a}{\cos 2a}$$

TEE

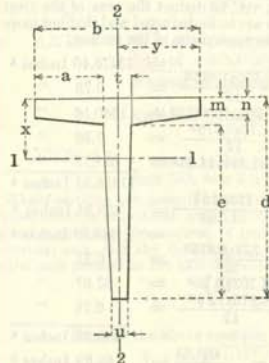

$$A = \frac{e(t+u)}{2} + m^2 + a(m+1)$$

$$x = \frac{6an^2+2a(m-n)(m+2n)+3td^2-e(t-u)(3d-e)}{6A}$$

$$y = \frac{l}{2}$$

$$I_{1-1} = \frac{e^3(3u+t)+4bm^3-2a(m-n)^3}{12} - A(x-m)^2$$

$$I_{2-2} = \frac{nb^3+(m-n)t^3+eu^3}{12} + \frac{a(m-n)[2a^2+(2a+3t)^2]}{36} + \frac{e(t-u)[(t-u)^2+2(t+2u)^2]}{144}$$

COMPOUND SECTIONS

MOMENTS OF INERTIA, SECTION MODULI, AND RADII OF GYRATION

The moment of inertia of a compound section about its neutral axis is equal to the sum of the moment of inertia, I , of the component parts about axes through their own centers of gravity, plus the areas A , of the component parts multiplied by the squares of the distances d , of their own centers of gravity from the neutral axis of the compound section, or

$$\text{Moment of Inertia } I^1 = I + Ad^2$$

$$\text{Section Modulus } S^1 = \frac{I^1}{n}$$

$$\text{Radius of Gyration } r^1 = \sqrt{\frac{I^1}{A^1}}$$

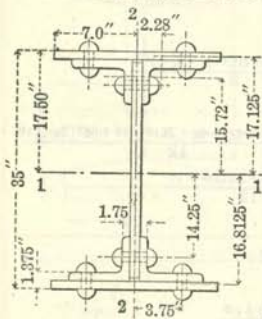

EXAMPLE 1. Required the moments of inertia and the section moduli about axes 1-1 and 2-2 of a compound section to be used as a girder, composed of

- 1 Web Plate 33''x $\frac{1}{2}$ ''
- 4 Flange Angles 6''x4''x $\frac{5}{8}$ ''
- 2 Flange Plates 14''x $\frac{3}{4}$ ''

basing the properties on the gross area of the section.

Determine the distances, of the center lines of gravity of plates and angles, from the neutral axes of the compound section, from the dimensions given, then for

AXIS 1-1	I_{1-1} of 4-6''x4''x $\frac{5}{8}$ '' Angles	= 4 x 7.5	= 30.00 Inches ⁴
	Ad^2 of 4-6''x4''x $\frac{5}{8}$ '' "	= 4 x 5.86x15.72 ²	= 5792.46 "
	I_{1-1} of 1-33''x $\frac{1}{2}$ '' Plate	= 1 x $\frac{0.50x33^3}{12}$	= 1497.38 "
	I_{1-1} of 2-14''x $\frac{3}{4}$ '' "	= 2 x $\frac{14x0.75^3}{12}$	= 0.98 "
	Ad^2 of 2-14''x $\frac{3}{4}$ '' "	= 2 x 10.50 x 17.125 ²	= 6158.58 "
	Moment of Inertia, gross section		13479.40 Inches ⁴
	Section Modulus, " "	= $\frac{13479.40}{17.50}$	= 770.26 Inches ³
AXIS 2-2	I_{2-2} of 4-6''x4''x $\frac{5}{8}$ '' Angles	= 4 x 21.1	= 84.40 Inches ⁴
	Ad^2 of 4-6''x4''x $\frac{5}{8}$ '' "	= 4 x 5.86x2.28 ²	= 121.85 "
	I_{2-2} of 1-33''x $\frac{1}{2}$ '' Plate	= 1 x $\frac{33x0.50^3}{12}$	= 0.34 "
	I_{2-2} of 2-14''x $\frac{3}{4}$ '' "	= 2 x $\frac{0.75x14^3}{12}$	= 343.00 "
	Moment of Inertia, gross section		549.59 Inches ⁴
	Section Modulus, " "	= $\frac{549.59}{7}$	= 78.51 Inches ³

If it is desired to calculate the properties of the net section, viz., to deduct the area of the rivet holes, proceed as follows, assuming that $\frac{3}{8}$ '' holes for $\frac{3}{4}$ '' rivets are to be deducted and that not more than one rivet will be driven in any one leg of the angles in the same plane of the section.

AXIS 1-1	I_{1-1} of gross section		= 13479.40 Inches ⁴
Deduct	I_{1-1} of 4-0.875''x1.375'' Rectangles	= 4 x $\frac{0.875x1.375^3}{12}$	= 0.76 "
"	Ad^2 of 4-0.875''x1.375'' "	= 4 x 1.203x16.8125 ²	= 1360.16 "
"	I_{1-1} of 2-0.875''x1.75'' "	= 2 x $\frac{1.75x0.875^3}{12}$	= 0.20 "
"	Ad^2 of 2-0.875''x1.75'' "	= 2x1.531x14.25 ²	= 621.77 "
	Moment of Inertia, net section		11496.51 Inches ⁴
	Section Modulus, " "	= $\frac{11496.51}{17.50}$	= 656.94 Inches ³
AXIS 2-2	I_{2-2} of gross section		= 549.59 Inches ⁴
Deduct	I_{2-2} of 4-0.875''x1.375'' Rectangles	= 4 x $\frac{1.375x0.875^3}{12}$	= 0.31 "
"	Ad^2 of 4-0.875''x1.375'' "	= 4 x 1.203x3.75 ²	= 67.67 "
"	I_{2-2} of 2-0.875''x1.75'' "	= 2 x $\frac{0.875x1.75^3}{12}$	= 0.78 "
	Moment of Inertia, net section		480.83 Inches ⁴
	Section Modulus, " "	= $\frac{480.83}{7}$	= 68.69 Inches ³

COMPOUND SECTIONS—Concluded

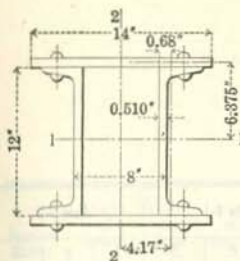

EXAMPLE 2. Required the moments of inertia and radii of gyration about axes 1-1 and 2-2 of a column section composed as follows:—

2 Channels 12" x 30 pounds per foot,
2 Flange Plates 14" x 3/4",

properties to be based on the gross section, no deduction being made for holes.

Determine the distances, d , of center lines of gravity for the various sections from the neutral axes 1-1 and 2-2, in accordance with the dimensions given, then for

AXIS 1-1	I_{1-1} of 2-12" Channels 30 lbs.	$= 2 \times 161.2$	$= 322.40$	Inches ⁴
	I_{1-1} of 2-14" x 3/4" Plates	$= 2 \times \frac{14 \times 0.75^3}{12}$	$= 0.98$	"
	Ad^2 of 2-14" x 3/4" "	$= 2 \times 10.5 \times 6.375^2$	$= 853.45$	"
	Moment of Inertia, gross section		1176.83	Inches ⁴
	Radius of Gyration, " "	$= \sqrt{\frac{1176.83}{38.58}}$	$= 5.52$	Inches

AXIS 2-2	I_{2-2} of 2-12" Channels 30 lbs.	$= 2 \times 5.2$	$= 10.40$	Inches ⁴
	I_{2-2} of 2-12" Channels 30 lbs.	$= 2 \times 8.70 \times 4.17^2$	$= 305.70$	"
	I_{2-2} of 2-14" x 3/4" Plates	$= 2 \times \frac{0.75 \times 14^3}{12}$	$= 343.00$	"
	Moment of Inertia, gross section		659.10	Inches ⁴
	Radius of Gyration, " "	$= \sqrt{\frac{659.10}{38.58}}$	$= 4.13$	Inches

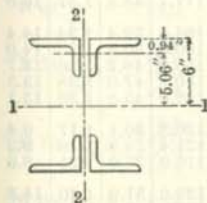

EXAMPLE 3. Required the radii of gyration about axes 1-1 and 2-2 of a strut section composed as follows:—

4-6" x 4" x 3/8" Angles latticed by 5/16" bars,

properties to be based on the gross section of angles, no deductions being made for rivet holes nor any allowance for lattice bars.

Determine the distances, d , of center lines of gravity of angles from neutral axes 1-1 and 2-2 in accordance with the dimensions given, then for

AXIS 1-1	I_{1-1} of 4-6" x 4" x 3/8" Angles	$= 4 \times 4.9$	$= 19.60$	Inches ⁴
	Ad^2 of 4-6" x 4" x 3/8" "	$= 4 \times 3.61 \times 5.06^2$	$= 369.72$	"
	Moment of Inertia, gross section		389.32	Inches ⁴
	Radius of Gyration, " "	$= \sqrt{\frac{389.32}{14.44}}$	$= 5.19$	Inches

AXIS 2-2 From tables of radii of gyration for 2 angles placed back to back page 133, axis 2-2, 5/16" apart, r_{2-2} of 4-6" x 4" x 3/8" angles = 2.97 Inches.

Where sections are assembled without any web or flange plates, as, for example, latticed channel columns or latticed angle struts, the radius of gyration, r_{1-1} can be readily obtained, without considering the moment of inertia, from the radius of gyration, r of one section about its neutral axis, and the distance, d , between the center of gravity of the section and the neutral axis parallel to the axis of section.

$$r_{1-1} = \sqrt{\frac{I + Ad^2}{A}}, \text{ where } \frac{I}{A} = r^2, \text{ and } r_{1-1} = \sqrt{r^2 + d^2}$$

Thus, in the above example,

$$r_{1-1} = \sqrt{1.17^2 + 5.06^2} = 5.19 \text{ Inches}$$

CARNEGIE STEEL COMPANY

ELEMENTS OF STRUCTURAL BEAMS

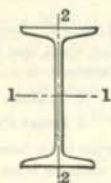

Section Index	Depth of Beam	Weight per Foot	Area of Section	Width of Flange	Thick-ness of Web	Axis 1-1			Axis 2-2		
						I	r	S	I	r	S
						In. ⁴	In.	In. ³	In. ⁴	In.	In. ³
B 61	27	90.0	26.34	9.000	0.524	2958.3	10.60	219.1	75.3	1.69	16.7
B 18	24	120.0	35.13	8.048	0.798	3010.8	9.26	250.9	84.9	1.56	21.1
		115.0	33.67	7.987	0.737	2940.5	9.35	245.0	82.8	1.57	20.7
		110.0	32.18	7.925	0.675	2869.1	9.44	239.1	80.6	1.58	20.3
		105.9	30.98	7.875	0.625	2811.5	9.53	234.3	78.9	1.60	20.0
B 1	24	100.0	29.25	7.247	0.747	2371.8	9.05	197.6	48.4	1.29	13.4
		95.0	27.79	7.186	0.686	2301.5	9.08	191.8	47.0	1.30	13.0
		90.0	26.30	7.124	0.624	2230.1	9.21	185.8	45.5	1.32	12.8
		85.0	24.84	7.063	0.563	2159.8	9.33	180.0	44.2	1.33	12.5
		79.9	23.33	7.000	0.500	2087.2	9.46	173.9	42.9	1.36	12.2
B 62	24	74.2	21.70	9.000	0.476	1950.1	9.48	162.5	61.2	1.68	13.6
B 63	21	60.4	17.68	8.250	0.428	1235.5	8.36	117.7	43.5	1.57	10.6
		100.0	29.20	7.273	0.873	1648.3	7.51	164.8	52.4	1.34	14.4
		95.0	27.74	7.200	0.800	1599.7	7.59	160.0	50.5	1.35	14.0
		90.0	26.26	7.126	0.726	1550.3	7.68	155.0	48.7	1.36	13.7
B 2	20	85.0	24.80	7.053	0.653	1501.7	7.78	150.2	47.0	1.38	13.3
		81.4	23.74	7.000	0.600	1466.3	7.86	146.6	45.8	1.39	13.1
		75.0	21.90	6.391	0.641	1263.5	7.60	126.3	30.1	1.17	9.4
		70.0	20.42	6.317	0.567	1214.2	7.71	121.4	28.9	1.19	9.2
		65.4	19.08	6.250	0.500	1169.5	7.83	116.9	27.9	1.21	8.9
B 19	18	90.0	26.29	7.236	0.796	1256.5	6.91	139.6	51.9	1.40	14.3
		85.0	24.81	7.154	0.714	1216.6	7.00	135.2	49.8	1.42	14.0
		80.0	23.34	7.072	0.632	1176.8	7.10	130.8	47.9	1.43	13.6
		75.6	22.04	7.000	0.560	1141.8	7.20	126.9	46.3	1.45	13.2
4	18	70.0	20.46	6.251	0.711	917.5	6.70	101.9	24.5	1.09	7.8
		65.0	18.98	6.169	0.629	877.7	6.80	97.5	23.4	1.11	7.6
		60.0	17.50	6.087	0.547	837.8	6.92	93.1	22.3	1.13	7.3
		54.7	15.94	6.000	0.460	795.5	7.07	88.4	21.2	1.15	7.1
4	18	48.2	14.09	7.500	0.380	737.1	7.23	81.9	30.0	1.46	8.0
6	15	75.0	21.85	6.278	0.868	687.2	5.61	91.6	30.6	1.18	9.8
		70.0	20.38	6.180	0.770	659.6	5.69	87.9	28.8	1.19	9.3
		65.0	18.91	6.082	0.672	632.1	5.78	84.3	27.2	1.20	8.9
		60.8	17.68	6.000	0.590	609.0	5.87	81.2	26.0	1.21	8.7
B 7	15	55.0	16.06	5.738	0.648	508.7	5.63	67.8	17.0	1.03	5.9
		50.0	14.59	5.640	0.550	481.1	5.74	64.2	16.0	1.05	5.7
		45.0	13.12	5.542	0.452	453.6	5.88	60.5	15.0	1.07	5.4
		42.9	12.49	5.500	0.410	441.8	5.95	58.9	14.6	1.08	5.3
B 65	15	37.3	10.91	6.750	0.332	405.5	6.10	54.1	19.9	1.35	5.9

ELEMENTS OF SECTIONS

ELEMENTS OF STRUCTURAL BEAMS—Concluded

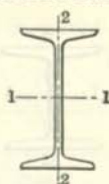

Section Index	Depth of Beam	Weight per Foot	Area of Section	Width of Flange	Thickness of Web	Axis 1-1			Axis 2-2		
						I	r	S	I	r	S
						In. ⁴	In.	In. ³	In. ⁴	In.	In. ³
B 8	12	55.0	16.04	5.600	0.810	319.3	4.46	53.2	17.3	1.04	6.2
		50.0	14.57	5.477	0.687	301.6	4.55	50.3	16.0	1.05	5.8
		45.0	13.10	5.355	0.565	284.1	4.66	47.3	14.8	1.06	5.5
		40.8	11.84	5.250	0.460	268.9	4.77	44.8	13.8	1.08	5.3
B 9	12	35.0	10.20	5.078	0.428	227.0	4.72	37.8	10.0	0.99	3.9
		31.8	9.26	5.000	0.350	215.8	4.83	36.0	9.5	1.01	3.8
B 66	12	27.9	8.15	6.000	0.284	199.4	4.95	33.2	12.6	1.24	4.2
B 10	10	40.0	11.69	5.091	0.741	158.0	3.68	31.6	9.4	0.90	3.7
		35.0	10.22	4.944	0.594	145.8	3.78	29.2	8.5	0.91	3.4
		30.0	8.75	4.797	0.447	133.5	3.91	26.7	7.6	0.93	3.2
		25.4	7.38	4.660	0.310	122.1	4.07	24.4	6.9	0.97	3.0
B 67	10	22.4	6.54	5.500	0.252	113.6	4.17	22.7	9.0	1.17	3.3
B 11	9	35.0	10.22	4.764	0.724	111.3	3.30	24.7	7.3	0.84	3.0
		30.0	8.76	4.601	0.561	101.4	3.40	22.5	6.4	0.85	2.8
		25.0	7.28	4.437	0.397	91.4	3.54	20.3	5.6	0.88	2.5
		21.8	6.32	4.330	0.290	84.9	3.67	18.9	5.2	0.90	2.4
B 12	8	25.5	7.43	4.262	0.532	68.1	3.03	17.0	4.7	0.80	2.2
		23.0	6.71	4.171	0.441	64.2	3.09	16.0	4.4	0.81	2.1
		20.5	5.97	4.079	0.349	60.2	3.18	15.1	4.0	0.82	2.0
		18.4	5.34	4.000	0.270	56.9	3.26	14.2	3.8	0.84	1.9
B 68	8	17.5	5.13	5.000	0.220	58.4	3.38	14.6	6.2	1.10	2.5
B 13	7	20.0	5.83	3.860	0.450	41.9	2.68	12.0	3.1	0.74	1.6
		17.5	5.09	3.755	0.345	38.9	2.77	11.1	2.9	0.76	1.6
		15.3	4.43	3.660	0.250	36.2	2.86	10.4	2.7	0.78	1.5
B 14	6	17.25	5.02	3.565	0.465	26.0	2.28	8.7	2.3	0.68	1.3
		14.75	4.29	3.443	0.343	23.8	2.36	7.9	2.1	0.69	1.2
		12.5	3.61	3.330	0.230	21.8	2.46	7.3	1.8	0.72	1.1
B 15	5	14.75	4.29	3.284	0.494	15.0	1.87	6.0	1.7	0.63	1.0
		12.25	3.56	3.137	0.347	13.5	1.95	5.4	1.4	0.63	0.91
		10.0	2.87	3.000	0.210	12.1	2.05	4.8	1.2	0.65	0.82
B 16	4	10.5	3.05	2.870	0.400	7.1	1.52	3.5	1.0	0.57	0.70
		9.5	2.76	2.796	0.326	6.7	1.56	3.3	0.91	0.58	0.65
		8.5	2.46	2.723	0.253	6.3	1.60	3.2	0.83	0.58	0.61
		7.7	2.21	2.660	0.190	6.0	1.64	3.0	0.77	0.59	0.58
B 17	3	7.5	2.17	2.509	0.349	2.9	1.15	1.9	0.59	0.52	0.47
		6.5	1.88	2.411	0.251	2.7	1.19	1.8	0.51	0.52	0.43
		5.7	1.64	2.330	0.170	2.5	1.23	1.7	0.46	0.53	0.40

CARNEGIE STEEL COMPANY

ELEMENTS OF H BEAMS

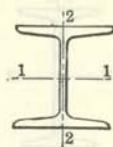

Section Index	Depth of Beam	Weight per Foot	Area of Section	Width of Flange	Thickness of Web	Axis 1-1			Axis 2-2		
						I	r	S	I	r	S
						In. ⁴	In.	In. ³	In. ⁴	In.	In. ³
H 4	8	37.7	11.00	8.125	0.500	120.8	3.31	30.2	36.9	1.83	9.1
		34.3	10.00	8.000	0.375	115.5	3.40	28.9	35.1	1.87	8.8
		32.6	9.50	7.938	0.313	112.8	3.45	28.2	34.2	1.90	8.6
H 3	6	26.7	7.76	6.125	0.438	47.4	2.47	15.8	15.7	1.42	5.1
		24.1	7.01	6.000	0.313	45.1	2.54	15.0	14.7	1.45	4.9
		22.8	6.63	5.938	0.250	44.0	2.58	14.7	14.2	1.46	4.8
H 2	5	18.9	5.47	5.000	0.313	23.8	2.08	9.5	7.8	1.20	3.1
H 1	4	13.8	3.99	4.000	0.313	10.7	1.64	5.3	3.6	0.95	1.8

ELEMENTS OF U. S. STEEL SHEET PILING SECTIONS

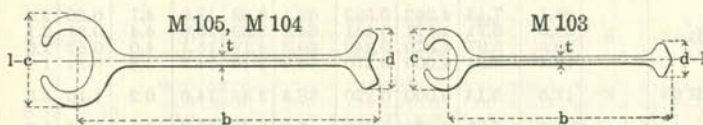

Section Index	Dimensions				Weight per Foot	Area of Section	Axis 1-1		
	b	c	d	t			I	r	S
	In.	In.	In.	In.			In. ⁴	In.	In. ³
M 105	13 1/4	3 15/16	2 1/2	1/2	42.5	12.51	8.56	0.83	4.35
M 104	13 1/4	3 15/16	2 1/2	3/8	38	11.30	8.50	0.87	4.32
M 103	9 1/4	2 9/16	1 5/8	1/4	16	4.71	1.45	0.56	1.13

ELEMENTS OF SECTIONS

ELEMENTS OF STRUCTURAL CHANNELS

American Standard Sections

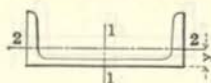

Section Index	Depth of Channel	Weight per Foot	Area of Section	Width of Flange	Thick-ness of Web	Axis 1-1			Axis 2-2			
						I	r	S	I	r	S	y
						In. ⁴	In.	In. ³	In. ⁴	In.	In. ³	In.
C 1	15	55.0	16.11	3.814	0.814	429.0	5.16	57.2	12.1	0.87	4.1	0.82
		50.0	14.64	3.716	0.716	401.4	5.24	53.6	11.2	0.87	3.8	0.80
		45.0	13.17	3.618	0.618	373.9	5.33	49.8	10.3	0.88	3.6	0.79
		40.0	11.70	3.520	0.520	346.3	5.44	46.2	9.3	0.89	3.4	0.78
		35.0	10.23	3.422	0.422	318.7	5.58	42.5	8.4	0.91	3.2	0.79
		33.9	9.90	3.400	0.400	312.6	5.62	41.7	8.2	0.91	3.2	0.79
C 2	12	40.0	11.73	3.415	0.755	196.5	4.09	32.8	6.6	0.75	2.5	0.72
		35.0	10.26	3.292	0.632	178.8	4.18	29.8	5.9	0.76	2.3	0.69
		30.0	8.79	3.170	0.510	161.2	4.28	26.9	5.2	0.77	2.1	0.68
		25.0	7.32	3.047	0.387	143.5	4.43	23.9	4.5	0.79	1.9	0.68
		20.7	6.03	2.940	0.280	128.1	4.61	21.4	3.9	0.81	1.7	0.70
C 3	10	35.0	10.27	3.180	0.820	115.2	3.34	23.0	4.6	0.67	1.9	0.69
		30.0	8.80	3.033	0.673	103.0	3.42	20.6	4.0	0.67	1.7	0.65
		25.0	7.33	2.886	0.526	90.7	3.52	18.1	3.4	0.68	1.5	0.62
		20.0	5.86	2.739	0.379	78.5	3.66	15.7	2.8	0.70	1.3	0.61
		15.3	4.47	2.600	0.240	66.9	3.87	13.4	2.3	0.72	1.2	0.64
C 4	9	25.0	7.33	2.812	0.612	70.5	3.10	15.7	3.0	0.64	1.4	0.61
		20.0	5.86	2.648	0.448	60.6	3.22	13.5	2.4	0.65	1.2	0.59
		15.0	4.39	2.485	0.285	50.7	3.40	11.3	1.9	0.67	1.0	0.59
		13.4	3.89	2.430	0.230	47.3	3.49	10.5	1.8	0.67	0.97	0.61
C 5	8	21.25	6.23	2.619	0.579	47.6	2.77	11.9	2.2	0.60	1.1	0.59
		18.75	5.49	2.527	0.457	43.7	2.82	10.9	2.0	0.60	1.0	0.57
		16.25	4.76	2.435	0.395	39.8	2.89	9.9	1.8	0.61	0.94	0.56
		13.75	4.02	2.343	0.303	35.8	2.99	9.0	1.5	0.62	0.86	0.56
		11.5	3.36	2.260	0.220	32.3	3.10	8.1	1.3	0.63	0.79	0.58
C 6	7	19.75	5.79	2.509	0.629	33.1	2.39	9.4	1.8	0.56	0.96	0.58
		17.25	5.05	2.404	0.524	30.1	2.44	8.6	1.6	0.56	0.86	0.55
		14.75	4.32	2.299	0.419	27.1	2.51	7.7	1.4	0.57	0.79	0.53
		12.25	3.58	2.194	0.314	24.1	2.59	6.9	1.2	0.58	0.71	0.53
		9.8	2.85	2.090	0.210	21.1	2.72	6.0	0.98	0.59	0.63	0.55
C 7	6	15.5	4.54	2.279	0.559	19.5	2.07	6.5	1.3	0.53	0.73	0.55
		13.0	3.81	2.157	0.437	17.3	2.13	5.8	1.1	0.53	0.65	0.52
		10.5	3.07	2.034	0.314	15.1	2.22	5.0	0.87	0.53	0.57	0.50
		8.2	2.39	1.920	0.200	13.0	2.34	4.3	0.70	0.54	0.50	0.52
C 8	5	11.5	3.36	2.032	0.472	10.4	1.76	4.1	0.82	0.49	0.54	0.51
		9.0	2.63	1.885	0.325	8.8	1.83	3.5	0.64	0.49	0.45	0.48
		6.7	1.95	1.750	0.190	7.4	1.95	3.0	0.48	0.50	0.38	0.49
C 9	4	7.25	2.12	1.720	0.320	4.5	1.47	2.3	0.44	0.46	0.35	0.46
		6.25	1.82	1.647	0.247	4.1	1.50	2.1	0.38	0.45	0.32	0.46
		5.4	1.56	1.580	0.180	3.8	1.56	1.9	0.32	0.45	0.29	0.46
C 10	3	6.0	1.75	1.596	0.356	2.1	1.08	1.4	0.31	0.42	0.27	0.46
		5.0	1.46	1.498	0.258	1.8	1.12	1.2	0.25	0.41	0.24	0.44
		4.1	1.19	1.410	0.170	1.6	1.17	1.1	0.20	0.41	0.21	0.44

CARNEGIE STEEL COMPANY

ELEMENTS OF SHIP BUILDING CHANNELS
American Standard Sections

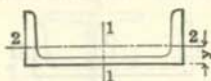

Section Index	Depth of Channel	Wt. per Foot	Area of Section	Width of Flange	Thick-ness of Web	Axis 1-1			Axis 2-2			
						I	r	S	I	r	S	y
						In. ⁴	In.	In. ³	In. ⁴	In.	In. ³	In.
†C 60	18	58.0	16.98	4.200	.700	670.7	6.29	74.5	18.5	1.04	5.6	0.88
		51.9	15.18	4.100	.600	622.1	6.40	69.1	17.1	1.06	5.3	0.87
		45.8	13.38	4.000	.500	573.5	6.55	63.7	15.8	1.09	5.1	0.89
		42.7	12.48	3.950	.450	549.2	6.64	61.0	15.0	1.10	4.9	0.90
C 21 (BSC 26)	12	44.7	13.05	4.200	.725	245.0	4.33	40.8	16.8	1.14	5.3	1.04
		40.6	11.85	4.100	.625	230.6	4.41	38.4	15.5	1.15	5.1	1.04
		36.5	10.65	4.000	.525	216.2	4.51	36.0	14.2	1.16	4.8	1.06
		34.5	10.05	3.950	.475	209.0	4.57	34.8	13.5	1.16	4.7	1.07
C 171 (BSC 25)	12	41.1	12.00	3.700	.700	217.8	4.26	36.3	11.3	0.97	4.0	0.89
		37.0	10.80	3.600	.600	203.4	4.34	33.9	10.3	0.98	3.8	0.89
		32.9	9.60	3.500	.500	189.0	4.44	31.5	9.4	0.99	3.6	0.89
		30.9	9.00	3.450	.450	181.8	4.50	30.3	8.9	0.99	3.5	0.90
C 26 (BSC 21)	10	37.0	10.81	4.200	.675	146.3	3.68	29.3	14.9	1.18	4.8	1.10
		33.6	9.81	4.100	.575	138.0	3.75	27.6	13.7	1.18	4.6	1.11
		30.2	8.81	4.000	.475	129.7	3.84	25.9	12.5	1.19	4.3	1.13
		28.5	8.31	3.950	.425	125.5	3.89	25.1	11.8	1.19	4.2	1.15
C 27 (BSC 20)	10	35.1	10.23	3.700	.675	133.6	3.61	26.7	10.4	1.01	3.8	0.95
		31.7	9.23	3.600	.575	125.2	3.69	25.0	9.5	1.01	3.6	0.95
		28.3	8.23	3.500	.475	116.9	3.77	23.4	8.6	1.02	3.4	0.96
		26.6	7.73	3.450	.425	112.7	3.82	22.5	8.1	1.02	3.3	0.97
C 28 (BSC 19)	10	25.3	7.38	3.550	.425	106.0	3.79	21.2	7.9	1.04	3.0	0.94
		23.6	6.88	3.500	.375	101.8	3.85	20.4	7.5	1.04	2.9	0.96
		21.9	6.38	3.450	.325	97.6	3.91	19.5	7.0	1.05	2.8	0.98
		34.7	10.13	4.200	.675	113.0	3.34	25.1	14.5	1.20	4.8	1.15
C 31 (BSC 18)	9	31.7	9.23	4.100	.575	106.9	3.40	23.8	13.3	1.20	4.5	1.16
		28.6	8.33	4.000	.475	100.9	3.48	22.4	12.1	1.20	4.3	1.18
		27.1	7.88	3.950	.425	97.8	3.52	21.7	11.4	1.20	4.2	1.20
		31.6	9.21	3.700	.650	99.4	3.29	22.1	9.7	1.03	3.6	0.98
C 32 (BSC 17)	9	28.5	8.31	3.600	.550	93.4	3.35	20.7	8.8	1.03	3.4	0.98
		25.4	7.41	3.500	.450	87.3	3.43	19.4	8.0	1.04	3.2	1.00
		23.9	6.96	3.450	.400	84.3	3.48	18.7	7.5	1.04	3.1	1.01
		28.2	8.23	3.700	.625	71.8	2.95	18.0	9.0	1.05	3.4	1.02
C 36 (BSC 13)	8	25.5	7.43	3.600	.525	67.6	3.02	16.9	8.2	1.05	3.2	1.02
		22.8	6.63	3.500	.425	63.3	3.09	15.8	7.4	1.05	3.0	1.04
		21.4	6.23	3.450	.375	61.2	3.13	15.3	6.9	1.05	2.9	1.05
		25.5	7.43	3.225	.600	62.6	2.90	15.6	5.8	0.89	2.5	0.86
C 37 (BSC 12)	8	22.7	6.63	3.125	.500	58.3	2.97	14.6	5.3	0.89	2.3	0.85
		20.0	5.83	3.025	.400	54.0	3.05	13.5	4.7	0.90	2.2	0.86
		19.3	5.63	3.000	.375	53.0	3.07	13.2	4.5	0.90	2.1	0.87
		18.7	5.43	2.975	.350	51.9	3.09	13.0	4.4	0.90	2.1	0.88

Dimensions and properties of the British Standard Sections are indicated in bold type.
†C 60 is not an American Standard Section; profile is shown on page 66 with Structural Channels.

ELEMENTS OF SECTIONS

ELEMENTS OF SHIP BUILDING CHANNELS

American Standard Sections

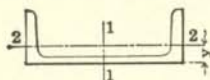

Section Index	Depth of Channel	Wt. per Foot	Area of Section	Width of Flange	Thick-ness of Web	Axis 1-1			Axis 2-2			
						I	r	S	I	r	S	y
						In. ⁴	In.	In. ³	In. ⁴	In.	In. ³	In.
C 41 (BSC 10)	7	25.0	7.30	3.7000	0.600	49.9	2.62	14.3	8.3	1.07	3.2	1.06
		22.7	6.60	3.6000	0.500	47.1	2.67	13.5	7.5	1.07	3.0	1.07
		20.3	5.90	3.5000	0.400	44.2	2.74	12.6	6.7	1.07	2.8	1.09
		19.1	5.55	3.4500	0.350	42.8	2.78	12.2	6.3	1.07	2.7	1.11
C 42 (BSC 9)	7	20.0	5.82	3.1000	0.475	40.2	2.63	11.5	4.7	0.90	2.1	0.88
		17.6	5.12	3.0000	0.375	37.3	2.70	10.7	4.2	0.90	2.0	0.90
		16.4	4.77	2.9500	0.325	35.9	2.74	10.2	3.9	0.90	1.9	0.91
C 46 (BSC 8)	6	22.0	6.42	3.7000	0.575	33.0	2.27	11.0	7.6	1.09	2.9	1.12
		20.0	5.82	3.6000	0.375	31.2	2.32	10.4	6.9	1.09	2.8	1.13
		18.0	5.22	3.5000	0.475	29.4	2.38	9.8	6.1	1.08	2.6	1.15
		16.9	4.92	3.4500	0.325	28.5	2.41	9.5	5.7	1.08	2.5	1.17
C 109	6	15.3	4.48	3.5000	0.340	25.3	2.38	8.4	5.1	1.08	2.1	1.08
C 47 (BSC 7)	6	16.3	4.75	3.0000	0.375	25.8	2.33	8.6	4.0	0.91	1.9	0.95
		15.1	4.37	2.9380	0.313	24.7	2.38	8.2	3.6	0.91	1.8	0.97
C 48 (BSC 5)	6	13.3	3.90	2.5630	0.375	19.7	2.25	6.6	2.1	0.74	1.2	0.71
		12.0	3.52	2.5000	0.313	18.6	2.30	6.2	2.0	0.75	1.1	0.72

Dimensions and properties of the British Standard Sections are indicated in **bold type**.

ELEMENTS OF CAR BUILDING CHANNELS

†C 20	13	50.0	14.664	4.4120	0.787	312.9	4.62	48.1	16.7	1.07	4.9	0.98
		45.0	13.184	2.980	0.673	292.0	4.71	44.9	15.3	1.08	4.6	0.97
		40.0	11.714	1.850	0.560	271.4	4.82	41.7	13.9	1.09	4.3	0.97
		37.0	10.824	1.170	0.492	258.9	4.89	39.8	13.0	1.10	4.2	0.98
		35.0	10.244	0.720	0.447	250.7	4.95	38.6	12.5	1.10	4.0	0.99
		31.8	9.304	0.000	0.375	237.5	5.05	36.5	11.6	1.11	3.9	1.01
†C 170	12	50.0	14.644	4.1350	0.835	268.1	4.28	44.7	17.8	1.10	5.8	1.06
		48.6	14.224	4.1000	0.800	263.0	4.30	43.8	17.3	1.10	5.7	1.05
		46.6	13.624	4.0500	0.750	255.8	4.33	42.6	16.6	1.11	5.5	1.05
		44.5	13.024	4.0000	0.700	248.6	4.37	41.4	16.0	1.11	5.4	1.05
		40.0	11.703	3.8900	0.590	232.8	4.46	38.8	14.5	1.12	5.1	1.05
		35.0	10.233	3.767	0.467	215.1	4.59	35.8	12.9	1.12	4.8	1.07
C 200	4	13.8	4.00	2.5000	0.500	8.8	1.49	4.4	2.2	0.74	1.4	0.86
C 190	3	7.1	2.06	1.9840	0.250	2.8	1.17	1.9	0.75	0.60	0.60	0.72
C 191	3	6.5	1.89	1.8750	0.250	2.6	1.17	1.7	0.63	0.58	0.52	0.67
		5.8	1.68	1.8050	0.180	2.4	1.20	1.6	0.53	0.56	0.47	0.68

†Profiles of C 20 and C 170 are shown with Structural Channels.

CARNEGIE STEEL COMPANY

ELEMENTS OF SHIP BUILDING BULB ANGLES

American Standard Sections



Section Index	Size	Thick-ness of Web	Wt. per Foot	Area of Section	Axis 1-1				Axis 2-2			
					I	r	S	x	I	r	S	y
					In. ⁴	In.	In. ³	In.	In. ⁴	In.	In. ³	In.
BA 195	10 x 3½	0.725	35.2	10.35	122.0	3.43	22.3	4.53	6.3	0.78	2.3	0.76
		0.675	33.2	9.77	115.9	3.44	21.2	4.52	5.8	0.77	2.1	0.74
BA 196	10 x 3½	0.625	31.1	9.14	110.4	3.48	20.3	4.56	5.6	0.78	2.0	0.72
		0.575	29.1	8.55	104.3	3.49	19.2	4.56	5.1	0.77	1.9	0.70
BA 197 (BSBA 18)	10 x 3½	0.525	26.9	7.90	98.2	3.53	18.3	4.62	4.8	0.78	1.7	0.69
		0.475	24.9	7.32	92.1	3.55	17.2	4.63	4.4	0.78	1.6	0.68
BA 205	9½ x 3½	0.600	28.8	8.47	93.0	3.32	17.9	4.30	5.3	0.79	1.9	0.73
		0.550	26.9	7.91	87.8	3.33	16.9	4.29	4.9	0.79	1.8	0.71
BA 206 (BSBA 17)	9½ x 3½	0.500	24.7	7.28	82.4	3.37	16.0	4.36	4.6	0.79	1.6	0.69
		0.450	22.8	6.72	77.1	3.39	15.1	4.36	4.2	0.79	1.5	0.68
BA 201	9 x 3½	0.675	30.4	8.95	86.3	3.11	17.2	4.00	5.8	0.81	2.1	0.76
		0.625	28.6	8.41	81.8	3.12	16.4	3.98	5.4	0.80	2.0	0.74
BA 202	9 x 3½	0.575	26.6	7.82	77.6	3.15	15.6	4.03	5.1	0.81	1.8	0.73
		0.525	24.8	7.29	73.1	3.17	14.8	4.03	4.7	0.80	1.7	0.71
BA 203 (BSBA 16)	9 x 3½	0.475	22.7	6.68	68.4	3.20	13.9	4.10	4.3	0.81	1.5	0.70
		0.425	20.9	6.14	63.8	3.22	13.1	4.10	3.9	0.80	1.4	0.68
BA 208	8½ x 3½	0.575	25.3	7.43	65.5	2.97	13.8	3.74	5.0	0.82	1.8	0.74
		0.525	23.5	6.92	61.7	2.98	13.0	3.73	4.6	0.82	1.7	0.72
BA 209 (BSBA 14)	8½ x 3½	0.475	21.6	6.34	57.7	3.02	12.3	3.80	4.3	0.82	1.5	0.71
		0.425	19.8	5.83	53.8	3.04	11.5	3.80	3.9	0.82	1.4	0.69
BA 211	8½ x 3	0.550	23.4	6.89	60.1	2.96	13.1	3.89	3.1	0.67	1.3	0.63
		0.500	21.7	6.39	56.4	2.97	12.3	3.89	2.8	0.66	1.2	0.61
BA 212 (BSBA 13)	8½ x 3	0.450	19.8	5.84	52.7	3.00	11.6	3.96	2.6	0.67	1.1	0.60
		0.400	18.1	5.34	48.9	3.03	10.8	3.96	2.3	0.66	0.99	0.58

Dimensions and properties of the British Standard Sections are indicated in bold type.

ELEMENTS OF SECTIONS

ELEMENTS OF SHIP BUILDING BULB ANGLES
American Standard Sections

Section Index	Size Inches	Thick- ness of Web In.	Wt. per Foot Lbs.	Area of Sec- tion In. ²	Axis 1-1				Axis 2-2			
					I	r	S	x	I	r	S	y
					In. ⁴	In.	In. ³	In.	In. ⁴	In.	In. ³	In.
BA 214	8 x 3½	0.550	23.2	6.83	53.7	2.81	11.9	3.49	4.8	0.84	1.7	0.75
		0.500	21.6	6.34	50.4	2.82	11.2	3.48	4.4	0.83	1.6	0.73
BA 215 (BSBA 12)	8 x 3½	0.450	19.6	5.78	47.1	2.85	10.6	3.54	4.0	0.84	1.4	0.71
		0.400	18.0	5.29	43.8	2.88	9.8	3.54	3.7	0.83	1.3	0.70
BA 217	8 x 3	0.575	23.1	6.78	52.4	2.78	12.0	3.64	3.2	0.69	1.3	0.65
		0.525	21.4	6.31	49.2	2.79	11.3	3.63	2.9	0.68	1.2	0.63
BA 218 (BSBA 11)	8 x 3	0.475	19.6	5.78	46.1	2.82	10.6	3.70	2.7	0.69	1.1	0.62
		0.425	18.0	5.30	42.9	2.84	10.0	3.70	2.4	0.68	1.0	0.60
BA 220	7½ x 3½	0.575	22.8	6.71	46.2	2.63	10.8	3.24	4.9	0.86	1.8	0.77
		0.525	21.2	6.24	43.4	2.64	10.2	3.23	4.5	0.85	1.7	0.75
BA 221 (BSBA 10)	7½ x 3½	0.475	19.4	5.70	40.6	2.67	9.6	3.29	4.2	0.85	1.5	0.73
		0.425	17.8	5.24	37.8	2.69	9.0	3.29	3.8	0.85	1.4	0.72
BA 223	7½ x 3	0.525	20.3	5.98	41.0	2.62	9.9	3.36	2.9	0.69	1.2	0.64
		0.475	18.8	5.53	38.4	2.63	9.3	3.35	2.6	0.69	1.1	0.62
BA 224 (BSBA 9)	7½ x 3	0.425	17.1	5.02	35.7	2.67	8.8	3.42	2.4	0.69	1.0	0.61
		0.375	15.6	4.57	33.1	2.69	8.2	3.42	2.2	0.69	0.92	0.60
BA 226	7 x 3½	0.525	20.0	5.90	35.5	2.45	8.8	2.95	4.5	0.87	1.6	0.77
		0.475	18.6	5.46	33.2	2.47	8.2	2.94	4.1	0.88	1.5	0.75
BA 227 (BSBA 8)	7 x 3½	0.425	16.8	4.94	30.9	2.50	7.7	3.00	3.7	0.87	1.4	0.74
		0.375	15.3	4.50	28.6	2.52	7.2	2.99	3.4	0.87	1.2	0.72
BA 229	7 x 3	0.500	18.4	5.41	32.5	2.45	8.3	3.09	2.7	0.71	1.3	0.65
		0.450	16.9	4.98	30.3	2.46	7.8	3.08	2.5	0.70	1.2	0.63
BA 230 (BSBA 7)	7 x 3	0.400	15.3	4.50	28.1	2.50	7.3	3.14	2.3	0.71	1.1	0.61
		0.350	13.9	4.07	25.9	2.52	6.7	3.14	2.0	0.70	1.0	0.60

Dimensions and properties of the British Standard Sections are indicated in bold type.

CARNEGIE STEEL COMPANY

ELEMENTS OF SHIP BUILDING BULB ANGLES

American Standard Sections

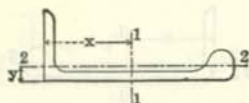

Section Index	Size	Thick-ness of Web	Wt. per Foot	Area of Section	Axis 1-1				Axis 2-2			
					I	r	S	x	I	r	S	y
					In. ⁴	In.	In. ³	In.	In. ⁴	In.	In. ³	In.
BA 233 (BSBA 6)	6½ x 3½	0.400	15.0	4.42	23.9	2.33	6.3	2.72	3.5	0.89	1.3	0.75
		0.350	13.6	4.01	22.1	2.35	5.9	2.71	3.1	0.89	1.2	0.73
BA 236 (BSBA 5)	6½ x 3	0.425	15.0	4.40	23.5	2.31	6.4	2.87	2.3	0.73	0.97	0.64
		0.375	13.6	4.00	21.7	2.33	6.0	2.87	2.1	0.72	0.88	0.62
*Lloyd	6 x 3½	0.350	12.9	3.80	20.8	2.34	5.7	2.86	2.0	0.72	0.84	0.61
		0.475	16.4	4.82	21.4	2.11	6.0	2.44	4.0	0.91	1.5	0.80
*Lloyd	6 x 3½	0.425	14.8	4.34	19.9	2.14	5.6	2.49	3.6	0.92	1.3	0.78
		0.375	13.4	3.95	18.4	2.16	5.2	2.49	3.3	0.91	1.2	0.76
BA 241	6 x 3	0.350	12.8	3.76	17.6	2.17	5.0	2.48	3.1	0.91	1.1	0.76
		0.475	16.8	4.95	21.7	2.09	6.3	2.56	2.8	0.75	1.2	0.69
BA 242 (BSBA 4)	6 x 3	0.475	15.6	4.58	20.2	2.10	5.9	2.55	2.5	0.74	1.1	0.67
		0.425	14.1	4.14	18.8	2.13	5.5	2.60	2.3	0.75	0.96	0.66
BA 244	5½ x 3	0.375	12.8	3.76	17.4	2.15	5.1	2.60	2.1	0.74	0.87	0.64
		0.350	12.2	3.58	16.6	2.16	4.9	2.59	1.9	0.74	0.83	0.63
BA 245 (BSBA 3)	5½ x 3	0.500	15.1	4.45	16.5	1.92	5.1	2.31	2.6	0.76	1.1	0.71
		0.450	13.9	4.10	15.3	1.93	4.8	2.30	2.4	0.76	1.0	0.69
BA 251 (BSBA 2)	5 x 2½	0.400	12.5	3.68	14.2	1.96	4.5	2.35	2.1	0.76	0.90	0.67
		0.350	11.3	3.33	13.0	1.98	4.1	2.35	1.9	0.76	0.81	0.65
BA 251 (BSBA 2)	5 x 2½	0.325	9.3	2.74	8.8	1.79	3.1	2.19	1.0	0.61	0.52	0.54
		0.300	8.8	2.59	8.4	1.80	3.0	2.19	0.95	0.61	0.49	0.53

*Lloyd section, rolled by Pencoyd Iron Works (Pencoyd 60A).

Dimensions and properties of the British Standard Sections are indicated in bold type.

ELEMENTS OF SHIP BUILDING BULB ANGLES

Miscellaneous Sections



Section Index	Sizes	Thick-ness of Web	Wt. per Foot	Area of Section	Axis 1-1				Axis 2-2			
					I	r	S	x	I	r	S	y
					In. ⁴	In.	In. ³	In.	In. ⁴	In.	In. ³	In.
BA 143	5 x 2½	0.240	8.3	2.44	8.6	1.89	3.4	2.41	0.91	0.61	0.47	0.55

ELEMENTS OF CAR BUILDING BULB ANGLES

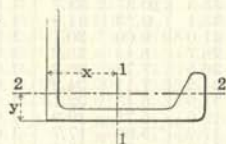

Section Index	Sizes	Thick-ness of Web	Wt. per Foot	Area of Section	Axis 1-1				Axis 2-2			
					I	r	S	x	I	r	S	y
					In. ⁴	In.	In. ³	In.	In. ⁴	In.	In. ³	In.
BA 125	5 x 4½	0.438	19.3	5.66	20.8	1.91	7.9	2.39	7.9	1.18	2.4	1.23
BA 124	5 x 3½	0.375	13.2	3.82	13.5	1.88	4.9	2.22	3.3	0.92	1.2	0.86
BA 122	4 x 3½	0.500	14.3	4.21	8.7	1.44	3.7	1.65	3.9	0.96	1.5	0.99
BA 123	4 x 3½	0.375	11.9	3.48	7.9	1.50	3.5	1.77	3.1	0.94	1.2	0.94

CARNEGIE STEEL COMPANY

ELEMENTS OF EQUAL ANGLES

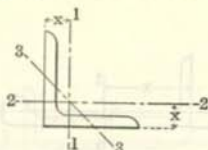

Section Index	Size	Thickness	Weight per Foot	Area of Section	Axis 1-1 and Axis 2-2				Axis 3-3
					I	r	S	x	r min.
	Inches	In.	Pounds	In. ²	In. ⁴	In.	In. ³	In.	In.
A 1	8 x 8	1 1/8	56.9	16.73	98.0	2.42	17.5	2.41	1.55
		1 1/16	54.0	15.87	93.5	2.43	16.7	2.39	1.56
		1	51.0	15.00	89.0	2.44	15.8	2.37	1.56
		15/16	48.1	14.12	84.3	2.44	14.9	2.34	1.56
		7/8	45.0	13.23	79.6	2.45	14.0	2.32	1.56
		13/16	42.0	12.34	74.7	2.46	13.1	2.30	1.57
		3/4	38.9	11.44	69.7	2.47	12.2	2.28	1.57
		11/16	35.8	10.53	64.6	2.48	11.2	2.25	1.58
		5/8	32.7	9.61	59.4	2.49	10.3	2.23	1.58
		9/16	29.6	8.68	54.1	2.50	9.3	2.21	1.58
		1/2	26.4	7.75	48.6	2.51	8.4	2.19	1.58
		A 2	6 x 6	1	37.4	11.00	35.5	1.80	8.6
15/16	35.3			10.37	33.7	1.80	8.1	1.84	1.16
7/8	33.1			9.73	31.9	1.81	7.6	1.82	1.17
13/16	31.0			9.09	30.1	1.82	7.2	1.80	1.17
3/4	28.7			8.44	28.2	1.83	6.7	1.78	1.17
11/16	26.5			7.78	26.2	1.83	6.2	1.75	1.17
5/8	24.2			7.11	24.2	1.84	5.7	1.73	1.17
9/16	21.9			6.43	22.1	1.85	5.1	1.71	1.18
1/2	19.6			5.75	19.9	1.86	4.6	1.68	1.18
7/16	17.2			5.06	17.7	1.87	4.1	1.66	1.19
3/8	14.9			4.36	15.4	1.88	3.5	1.64	1.19
A 3	5 x 5			1	30.6	9.00	19.6	1.48	5.8
		15/16	28.9	8.50	18.7	1.48	5.5	1.59	0.96
		7/8	27.2	7.98	17.8	1.49	5.2	1.57	0.96
		13/16	25.4	7.47	16.8	1.50	4.9	1.55	0.97
		3/4	23.6	6.94	15.7	1.50	4.5	1.52	0.97
		11/16	21.8	6.40	14.7	1.51	4.2	1.50	0.97
		5/8	20.0	5.86	13.6	1.52	3.9	1.48	0.97
		9/16	18.1	5.31	12.4	1.53	3.5	1.46	0.98
		1/2	16.2	4.75	11.3	1.54	3.2	1.43	0.98
		7/16	14.3	4.18	10.0	1.55	2.8	1.41	0.98
		3/8	12.3	3.61	8.7	1.56	2.4	1.39	0.99
		A 4	4 x 4	13/16	19.9	5.84	8.1	1.18	3.0
3/4	18.5			5.44	7.7	1.19	2.8	1.27	0.77
11/16	17.1			5.03	7.2	1.19	2.6	1.25	0.77
5/8	15.7			4.61	6.7	1.20	2.4	1.23	0.77
9/16	14.3			4.18	6.1	1.21	2.2	1.21	0.78
1/2	12.8			3.75	5.6	1.22	2.0	1.18	0.78
7/16	11.3			3.31	5.0	1.23	1.8	1.16	0.78
3/8	9.8			2.86	4.4	1.23	1.5	1.14	0.79
9/16	8.2			2.40	3.7	1.24	1.3	1.12	0.79
1/4	6.6			1.94	3.0	1.25	1.0	1.09	0.79

ELEMENTS OF SECTION

ELEMENTS OF EQUAL ANGLES—Concluded

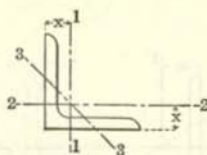

Section Index	Size	Thickness	Weight per Foot	Area of Section	Axis 1-1 and Axis 2-2				Axis 3-3
					I	r	S	x	r min.
					In. ⁴	In.	In. ³	In.	In.
A 5	3½ x 3½	1¾	17.1	5.03	5.3	1.02	2.3	1.17	0.67
		¾	16.0	4.69	5.0	1.03	2.1	1.15	0.67
		11/16	14.8	4.34	4.7	1.04	2.0	1.12	0.67
		5/8	13.6	3.98	4.3	1.04	1.8	1.10	0.68
		9/16	12.4	3.62	4.0	1.05	1.6	1.08	0.68
		1/2	11.1	3.25	3.6	1.06	1.5	1.06	0.68
		7/16	9.8	2.87	3.3	1.07	1.3	1.04	0.68
		3/8	8.5	2.48	2.9	1.07	1.2	1.01	0.69
		5/16	7.2	2.09	2.5	1.08	0.98	0.99	0.69
		1/4	5.8	1.69	2.0	1.09	0.79	0.97	0.69
A 7	3 x 3	5/8	11.5	3.36	2.6	0.88	1.3	0.98	0.57
		9/16	10.4	3.06	2.4	0.89	1.2	0.95	0.58
		1/2	9.4	2.75	2.2	0.90	1.1	0.93	0.58
		7/16	8.3	2.43	2.0	0.91	0.95	0.91	0.58
		3/8	7.2	2.11	1.8	0.91	0.83	0.89	0.58
		5/16	6.1	1.78	1.5	0.92	0.71	0.87	0.59
		1/4	4.9	1.44	1.2	0.93	0.58	0.84	0.59
		1/2	7.7	2.25	1.2	0.74	0.73	0.81	0.47
		7/16	6.8	2.00	1.1	0.75	0.65	0.78	0.48
		5/8	5.9	1.73	0.98	0.75	0.57	0.76	0.48
A 9	2½ x 2½	5/16	5.0	1.47	0.85	0.76	0.48	0.74	0.49
		1/4	4.1	1.19	0.70	0.77	0.39	0.72	0.49
		3/16	3.07	0.90	0.55	0.78	0.30	0.69	0.49
		1/8	2.08	0.61	0.38	0.79	0.20	0.67	0.50
		5/16	5.3	1.56	0.54	0.59	0.40	0.66	0.39
		3/8	4.7	1.36	0.48	0.59	0.35	0.64	0.39
		5/16	3.92	1.15	0.42	0.60	0.30	0.61	0.39
		1/4	3.19	0.94	0.35	0.61	0.25	0.59	0.39
		3/16	2.44	0.71	0.28	0.62	0.19	0.57	0.40
		1/8	1.65	0.48	0.19	0.63	0.13	0.55	0.40
A 11	2 x 2	7/16	4.6	1.34	0.35	0.51	0.30	0.59	0.33
		3/8	3.99	1.17	0.31	0.51	0.26	0.57	0.34
		5/16	3.39	1.00	0.27	0.52	0.23	0.55	0.34
		1/4	2.77	0.81	0.23	0.53	0.19	0.53	0.34
		3/16	2.12	0.62	0.18	0.54	0.14	0.51	0.35
		1/8	1.44	0.42	0.13	0.55	0.10	0.48	0.35
		5/8	3.35	0.98	0.19	0.44	0.19	0.51	0.29
		9/16	2.86	0.84	0.16	0.44	0.16	0.49	0.29
		1/4	2.34	0.69	0.14	0.45	0.13	0.47	0.29
		3/16	1.80	0.53	0.11	0.46	0.10	0.44	0.29
A 13	1½ x 1½	1/8	1.23	0.36	0.08	0.46	0.07	0.42	0.30
		5/16	2.33	0.68	0.09	0.36	0.11	0.42	0.24
		3/4	1.92	0.56	0.08	0.37	0.09	0.40	0.24
		9/16	1.48	0.43	0.06	0.38	0.07	0.38	0.24
		1/4	1.01	0.30	0.04	0.38	0.05	0.35	0.25
		1/4	1.49	0.44	0.04	0.29	0.06	0.34	0.19
		5/16	1.16	0.34	0.03	0.30	0.04	0.32	0.19
		1/8	0.80	0.23	0.02	0.31	0.03	0.30	0.19

ELEMENTS OF UNEQUAL ANGLES

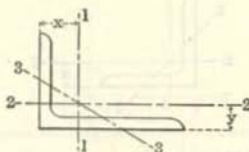

Section Index	Size	Thickness	Weight per Foot	Area of Section	Axis 1-1				Axis 2-2				Axis 3-3
					I		r		S		y		r min.
					In. ⁴	In.	In. ³	In.	In. ⁴	In.	In.	In.	In.
A 188 x 6	1	44.2	13.00	80.8	2.49	15.1	2.65	38.8	1.73	8.9	1.65	1.28	
	15/16	41.7	12.25	76.6	2.50	14.3	2.63	36.8	1.73	8.4	1.63	1.28	
	7/8	39.1	11.48	72.3	2.51	13.4	2.61	34.9	1.74	7.9	1.61	1.28	
	13/16	36.5	10.72	67.9	2.52	12.5	2.59	32.8	1.75	7.4	1.59	1.29	
	3/4	33.8	9.94	63.4	2.53	11.7	2.56	30.7	1.76	6.9	1.56	1.29	
	11/16	31.2	9.15	58.8	2.54	10.8	2.54	28.6	1.77	6.4	1.54	1.29	
	5/8	28.5	8.36	54.1	2.54	9.9	2.52	26.3	1.77	5.9	1.52	1.30	
	7/16	25.7	7.56	49.3	2.55	8.9	2.50	24.0	1.78	5.3	1.50	1.30	
	1/2	23.0	6.75	44.3	2.56	8.0	2.47	21.7	1.79	4.8	1.47	1.30	
	3/16	20.2	5.93	39.2	2.57	7.1	2.45	19.3	1.80	4.2	1.45	1.30	
A 538 x 3 1/2	1	35.7	10.50	66.2	2.51	13.7	3.17	7.8	0.86	3.0	0.92	0.73	
	15/16	33.7	9.90	62.9	2.52	12.9	3.14	7.4	0.87	2.9	0.89	0.73	
	7/8	31.7	9.30	59.4	2.53	12.2	3.12	7.1	0.87	2.7	0.87	0.73	
	13/16	29.6	8.68	55.9	2.54	11.4	3.10	6.7	0.88	2.5	0.85	0.73	
	3/4	27.5	8.06	52.3	2.55	10.6	3.07	6.3	0.88	2.3	0.82	0.73	
	11/16	25.3	7.43	48.5	2.56	9.8	3.05	5.9	0.89	2.2	0.80	0.73	
	5/8	23.2	6.80	44.7	2.57	9.0	3.03	5.4	0.90	2.0	0.78	0.74	
	7/16	21.0	6.15	40.8	2.57	8.2	3.00	5.0	0.90	1.8	0.75	0.74	
	1/2	18.7	5.50	36.7	2.58	7.3	2.98	4.5	0.91	1.6	0.73	0.74	
	3/16	16.5	4.84	32.5	2.59	6.4	2.95	4.1	0.92	1.5	0.70	0.74	
A 197 x 3 1/2	1	32.3	9.50	45.4	2.19	10.6	2.71	7.5	0.89	3.0	0.96	0.74	
	15/16	30.5	8.97	43.1	2.19	10.0	2.69	7.2	0.89	2.8	0.94	0.74	
	7/8	28.7	8.42	40.8	2.20	9.4	2.66	6.8	0.90	2.6	0.91	0.74	
	13/16	26.8	7.87	38.4	2.21	8.8	2.64	6.5	0.91	2.5	0.89	0.74	
	3/4	24.9	7.31	36.0	2.22	8.2	2.62	6.1	0.91	2.3	0.87	0.74	
	11/16	23.0	6.75	33.5	2.23	7.6	2.60	5.7	0.92	2.1	0.85	0.74	
	5/8	21.0	6.17	30.9	2.24	7.0	2.57	5.3	0.93	2.0	0.82	0.75	
	7/16	19.1	5.59	28.2	2.25	6.3	2.55	4.9	0.93	1.8	0.80	0.75	
	1/2	17.0	5.00	25.4	2.25	5.7	2.53	4.4	0.94	1.6	0.78	0.75	
	3/16	15.0	4.40	22.6	2.26	5.0	2.50	4.0	0.95	1.4	0.75	0.76	
1/8	13.0	3.80	19.6	2.27	4.3	2.48	3.5	0.96	1.3	0.73	0.76		
A 206 x 4	1	30.6	9.00	30.8	1.85	8.0	2.17	10.8	1.09	3.8	1.17	0.85	
	15/16	28.9	8.50	29.3	1.86	7.6	2.14	10.3	1.10	3.6	1.14	0.85	
	7/8	27.2	7.98	27.7	1.86	7.2	2.12	9.8	1.11	3.4	1.12	0.86	
	13/16	25.4	7.47	26.1	1.87	6.7	2.10	9.2	1.11	3.2	1.10	0.86	
	3/4	23.6	6.94	24.5	1.88	6.2	2.08	8.7	1.12	3.0	1.08	0.86	
	11/16	21.8	6.40	22.8	1.89	5.8	2.06	8.1	1.13	2.8	1.06	0.86	
	5/8	20.0	5.86	21.1	1.90	5.3	2.03	7.5	1.13	2.5	1.03	0.86	
	7/16	18.1	5.31	19.3	1.90	4.8	2.01	6.9	1.14	2.3	1.01	0.87	
	1/2	16.2	4.75	17.4	1.91	4.3	1.99	6.3	1.15	2.1	0.99	0.87	
	3/16	14.3	4.18	15.5	1.92	3.8	1.96	5.6	1.16	1.8	0.96	0.87	
1/8	12.3	3.61	13.5	1.93	3.3	1.94	4.9	1.17	1.6	0.94	0.88		

ELEMENTS OF SECTIONS

ELEMENTS OF UNEQUAL ANGLES—Continued

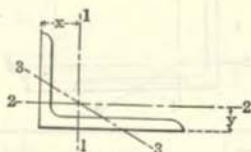

Section Index	Size	Thickness	Weight per Foot	Area of Section	Axis 1-1				Axis 2-2				Axis 3-3	
					I	r	S	x	I	r	S	y	rmin.	
					In. ⁴	In.	In. ³	In.	In. ⁴	In.	In. ³	In.	In.	
A 21	6 x 3½	1	28.9	8.50	29.2	1.85	7.8	2.26	7.2	0.92	2.9	1.01	0.74	
		15/16	27.3	8.03	27.8	1.86	7.4	2.24	6.9	0.93	2.7	0.99	0.74	
		7/8	25.7	7.55	26.4	1.87	7.0	2.22	6.6	0.93	2.6	0.97	0.75	
		13/16	24.0	7.06	24.9	1.88	6.6	2.20	6.2	0.94	2.4	0.95	0.75	
		3/4	22.4	6.56	23.3	1.89	6.1	2.18	5.8	0.94	2.3	0.93	0.75	
		11/16	20.6	6.06	21.7	1.89	5.6	2.15	5.5	0.95	2.1	0.90	0.75	
		5/8	18.9	5.55	20.1	1.90	5.2	2.13	5.1	0.96	1.9	0.88	0.75	
		9/16	17.1	5.03	18.4	1.91	4.7	2.11	4.7	0.96	1.8	0.86	0.75	
		1/2	15.3	4.50	16.6	1.92	4.2	2.08	4.3	0.97	1.6	0.83	0.76	
		7/16	13.5	3.97	14.8	1.93	3.7	2.06	3.8	0.98	1.4	0.81	0.76	
3/8	11.7	3.42	12.9	1.94	3.3	2.04	3.3	0.99	1.2	0.79	0.77			
5/16	9.8	2.87	10.9	1.95	2.7	2.01	2.9	1.00	1.0	0.76	0.77			
A 22	5 x 4	7/8	24.2	7.11	16.4	1.52	5.0	1.71	9.2	1.14	3.3	1.21	0.84	
		15/16	22.7	6.65	15.5	1.53	4.7	1.68	8.7	1.15	3.1	1.18	0.84	
		3/4	21.1	6.19	14.6	1.54	4.4	1.66	8.2	1.15	2.9	1.16	0.84	
		13/16	19.5	5.72	13.6	1.54	4.1	1.64	7.7	1.16	2.7	1.14	0.84	
		5/8	17.8	5.23	12.6	1.55	3.7	1.62	7.1	1.17	2.5	1.12	0.84	
		9/16	16.2	4.75	11.6	1.56	3.4	1.60	6.6	1.18	2.3	1.10	0.85	
		1/2	14.5	4.25	10.5	1.57	3.1	1.57	6.0	1.18	2.0	1.07	0.85	
		7/16	12.8	3.75	9.3	1.58	2.7	1.55	5.3	1.19	1.8	1.05	0.85	
3/8	11.0	3.23	8.1	1.59	2.3	1.53	4.7	1.20	1.6	1.03	0.86			
A 23	5 x 3½	7/8	22.7	6.67	15.7	1.53	4.9	1.79	6.2	0.96	2.5	1.04	0.75	
		15/16	21.3	6.25	14.8	1.54	4.6	1.77	5.9	0.97	2.4	1.02	0.75	
		3/4	19.8	5.81	13.9	1.55	4.3	1.75	5.6	0.98	2.2	1.00	0.75	
		13/16	18.3	5.37	13.0	1.56	4.0	1.72	5.2	0.98	2.1	0.97	0.75	
		5/8	16.8	4.92	12.0	1.56	3.7	1.70	4.8	0.99	1.9	0.95	0.75	
		9/16	15.2	4.47	11.0	1.57	3.3	1.68	4.4	1.00	1.7	0.93	0.75	
		1/2	13.6	4.00	10.0	1.58	3.0	1.66	4.0	1.01	1.6	0.91	0.75	
		7/16	12.0	3.53	8.9	1.59	2.6	1.63	3.6	1.01	1.4	0.88	0.76	
		3/8	10.4	3.05	7.8	1.60	2.3	1.61	3.2	1.02	1.2	0.86	0.76	
		5/16	8.7	2.56	6.6	1.61	1.9	1.59	2.7	1.03	1.0	0.84	0.76	
A 24	5 x 3	15/16	19.9	5.84	14.0	1.55	4.5	1.86	3.7	0.80	1.7	0.86	0.64	
		3/4	18.5	5.44	13.2	1.55	4.2	1.84	3.5	0.80	1.6	0.84	0.64	
		13/16	17.1	5.03	12.3	1.56	3.9	1.82	3.3	0.81	1.5	0.82	0.64	
		5/8	15.7	4.61	11.4	1.57	3.5	1.80	3.1	0.81	1.4	0.80	0.64	
		9/16	14.3	4.18	10.4	1.58	3.2	1.77	2.8	0.82	1.3	0.77	0.65	
		1/2	12.8	3.75	9.5	1.59	2.9	1.75	2.6	0.83	1.1	0.75	0.65	
		7/16	11.3	3.31	8.4	1.60	2.6	1.73	2.3	0.84	1.0	0.73	0.65	
		3/8	9.8	2.86	7.4	1.61	2.2	1.70	2.0	0.84	0.89	0.70	0.65	
		5/16	8.2	2.40	6.3	1.61	1.9	1.68	1.8	0.85	0.75	0.68	0.66	

ELEMENTS OF UNEQUAL ANGLES—Continued

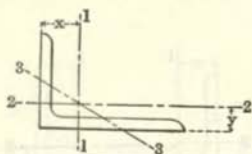

Section Index	Size	Thickness	Weight per Foot	Area of Section	Axis 1-1				Axis 2-2				Axis 3-3
					I	r	S	x	I	r	S	y	rmin.
					In. ⁴	In.	In. ³	In.	In. ⁴	In.	In. ³	In.	In.
A 25	4 1/2 x 3	1 3/16	18.5	5.43	10.3	1.38	3.6	1.65	3.6	0.81	1.7	0.90	0.64
		5/8	17.3	5.06	9.7	1.39	3.4	1.63	3.4	0.82	1.6	0.88	0.64
		1 1/16	16.0	4.68	9.1	1.39	3.1	1.60	3.2	0.83	1.5	0.85	0.64
		5/8	14.7	4.30	8.4	1.40	2.9	1.58	3.0	0.83	1.4	0.83	0.64
		9/16	13.3	3.90	7.8	1.41	2.6	1.56	2.8	0.85	1.3	0.81	0.64
		1/2	11.9	3.50	7.0	1.42	2.4	1.54	2.5	0.85	1.1	0.79	0.65
		7/16	10.6	3.09	6.3	1.43	2.1	1.51	2.3	0.85	1.0	0.76	0.65
		5/8	9.1	2.67	5.5	1.44	1.8	1.49	2.0	0.86	0.88	0.74	0.66
		9/16	7.7	2.25	4.7	1.44	1.5	1.47	1.7	0.87	0.75	0.72	0.66
A 26	4 x 3 1/2	1 3/16	18.5	5.43	7.8	1.19	2.9	1.36	5.5	1.01	2.3	1.11	0.72
		5/8	17.3	5.06	7.3	1.20	2.8	1.34	5.2	1.01	2.1	1.09	0.72
		1 1/16	16.0	4.68	6.9	1.21	2.6	1.32	4.9	1.02	2.0	1.07	0.72
		5/8	14.7	4.30	6.4	1.22	2.4	1.29	4.5	1.03	1.8	1.04	0.72
		9/16	13.3	3.90	5.9	1.23	2.1	1.27	4.2	1.03	1.7	1.02	0.72
		1/2	11.9	3.50	5.3	1.23	1.9	1.25	3.8	1.04	1.5	1.00	0.72
		7/16	10.6	3.09	4.8	1.24	1.7	1.23	3.4	1.05	1.3	0.98	0.72
		5/8	9.1	2.67	4.2	1.25	1.5	1.21	3.0	1.06	1.2	0.96	0.73
		9/16	7.7	2.25	3.6	1.26	1.3	1.18	2.6	1.07	1.0	0.93	0.73
A 27	4 x 3	1 3/16	17.1	5.03	7.3	1.21	2.9	1.44	3.5	0.83	1.7	0.94	0.64
		5/8	16.0	4.69	6.9	1.22	2.7	1.42	3.3	0.84	1.6	0.92	0.64
		1 1/16	14.8	4.34	6.5	1.22	2.5	1.39	3.1	0.84	1.5	0.89	0.64
		5/8	13.6	3.98	6.0	1.23	2.3	1.37	2.9	0.85	1.4	0.87	0.64
		9/16	12.4	3.62	5.6	1.24	2.1	1.35	2.7	0.86	1.2	0.85	0.64
		1/2	11.1	3.25	5.0	1.25	1.9	1.33	2.4	0.86	1.1	0.83	0.64
		7/16	9.8	2.87	4.5	1.25	1.7	1.30	2.2	0.87	1.0	0.80	0.64
		5/8	8.5	2.48	4.0	1.26	1.5	1.28	1.9	0.88	0.87	0.78	0.64
		9/16	7.2	2.09	3.4	1.27	1.2	1.26	1.7	0.89	0.74	0.76	0.65
A 28	3 1/2 x 3	1 3/16	15.8	4.62	5.0	1.04	2.2	1.23	3.3	0.85	1.7	0.98	0.62
		5/8	14.7	4.31	4.7	1.04	2.1	1.21	3.1	0.85	1.5	0.96	0.62
		1 1/16	13.6	4.00	4.4	1.05	1.9	1.19	3.0	0.86	1.4	0.94	0.62
		5/8	12.5	3.67	4.1	1.06	1.8	1.17	2.8	0.87	1.3	0.92	0.62
		9/16	11.4	3.34	3.8	1.07	1.6	1.15	2.5	0.87	1.2	0.90	0.62
		1/2	10.2	3.00	3.5	1.07	1.5	1.13	2.3	0.88	1.1	0.88	0.62
		7/16	9.1	2.65	3.1	1.08	1.3	1.10	2.1	0.89	0.98	0.85	0.62
		5/8	7.9	2.30	2.7	1.09	1.1	1.08	1.8	0.90	0.85	0.83	0.62
		9/16	6.6	1.93	2.3	1.10	0.96	1.06	1.6	0.90	0.72	0.81	0.63
A 29	3 1/2 x 2 1/2	1 3/16	5.4	1.56	1.9	1.11	0.78	1.04	1.3	0.91	0.58	0.79	0.63
		5/8	12.5	3.65	4.1	1.06	1.9	1.27	1.7	0.69	0.99	0.77	0.53
		1 1/16	11.5	3.36	3.8	1.07	1.7	1.25	1.6	0.69	0.92	0.75	0.53
		5/8	10.4	3.06	3.6	1.08	1.6	1.23	1.5	0.70	0.84	0.73	0.53
		9/16	9.4	2.75	3.2	1.09	1.4	1.20	1.4	0.70	0.76	0.70	0.53
		1/2	8.3	2.43	2.9	1.09	1.3	1.18	1.2	0.71	0.68	0.68	0.54
		7/16	7.2	2.11	2.6	1.10	1.1	1.16	1.1	0.72	0.59	0.66	0.54
		5/8	6.1	1.78	2.2	1.11	0.93	1.14	0.94	0.73	0.50	0.64	0.54
		9/16	4.9	1.44	1.8	1.12	0.75	1.11	0.78	0.74	0.41	0.61	0.54

ELEMENTS OF UNEQUAL ANGLES—Concluded

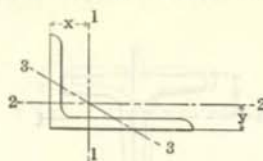

Section Index	Size	Thickness	Weight per Foot	Area of Section	Axis 1-1				Axis 2-2				Axis 3-3 r min.
					I		S		I		S		
					In.	In. ⁴	In.	In. ³	In.	In. ⁴	In.	In. ³	
A 32	3 x 2½	⅜	9.5	2.78	2.3	0.91	1.2	1.02	1.4	0.72	0.82	0.77	0.52
		½	8.5	2.50	2.1	0.91	1.0	1.00	1.3	0.72	0.74	0.75	0.52
		⅝	7.6	2.21	1.9	0.92	0.93	0.98	1.2	0.73	0.66	0.73	0.52
		¾	6.6	1.92	1.7	0.93	0.81	0.96	1.0	0.74	0.58	0.71	0.52
		⅞	5.6	1.62	1.4	0.94	0.69	0.93	0.90	0.74	0.49	0.68	0.53
		1	4.5	1.31	1.2	0.95	0.56	0.91	0.74	0.75	0.40	0.66	0.53
A 33	3 x 2	½	7.7	2.25	1.9	0.92	1.0	1.08	0.67	0.55	0.47	0.58	0.43
		⅝	6.8	2.00	1.7	0.93	0.89	1.06	0.61	0.55	0.42	0.56	0.43
		¾	5.9	1.73	1.5	0.94	0.78	1.04	0.54	0.56	0.37	0.54	0.43
		⅞	5.0	1.47	1.3	0.95	0.66	1.02	0.47	0.57	0.32	0.52	0.43
		1	4.1	1.19	1.1	0.95	0.54	0.99	0.39	0.57	0.26	0.49	0.43
A 35	2½ x 2	½	6.8	2.00	1.1	0.75	0.70	0.88	0.64	0.56	0.46	0.63	0.42
		⅝	6.1	1.78	1.0	0.76	0.62	0.85	0.58	0.57	0.41	0.60	0.42
		¾	5.3	1.55	0.91	0.77	0.55	0.83	0.51	0.58	0.36	0.58	0.42
		⅞	4.5	1.31	0.79	0.78	0.47	0.81	0.45	0.58	0.31	0.56	0.42
		1	3.62	1.06	0.65	0.78	0.38	0.79	0.37	0.59	0.25	0.54	0.42
		⅞	2.75	0.81	0.51	0.79	0.29	0.76	0.29	0.60	0.20	0.51	0.43
		¾	1.86	0.55	0.35	0.80	0.20	0.74	0.20	0.61	0.13	0.49	0.43
A 48	2½ x 1½	⅝	3.92	1.15	0.71	0.79	0.44	0.90	0.19	0.41	0.17	0.40	0.32
		¾	3.19	0.94	0.59	0.79	0.36	0.88	0.16	0.41	0.14	0.38	0.32
		⅞	2.44	0.72	0.46	0.80	0.28	0.85	0.13	0.42	0.11	0.35	0.33
A 27	2¼ x 1½	½	5.6	1.63	0.75	0.68	0.54	0.86	0.26	0.40	0.26	0.48	0.32
		⅝	5.0	1.45	0.68	0.69	0.48	0.83	0.24	0.41	0.23	0.46	0.32
		¾	4.4	1.27	0.61	0.69	0.42	0.81	0.21	0.41	0.20	0.44	0.32
		⅞	3.66	1.07	0.53	0.70	0.36	0.79	0.19	0.42	0.17	0.42	0.32
		1	2.98	0.88	0.44	0.71	0.30	0.77	0.16	0.42	0.14	0.39	0.32
		⅞	2.28	0.67	0.34	0.72	0.23	0.75	0.12	0.43	0.11	0.37	0.33
A 37	2 x 1½	¾	3.99	1.17	0.43	0.61	0.34	0.71	0.21	0.42	0.20	0.46	0.32
		⅞	3.39	1.00	0.38	0.62	0.29	0.69	0.18	0.42	0.17	0.44	0.32
		1	2.77	0.81	0.32	0.62	0.24	0.66	0.15	0.43	0.14	0.41	0.32
		⅞	2.12	0.62	0.25	0.63	0.18	0.64	0.12	0.44	0.11	0.39	0.32
		¾	1.44	0.42	0.17	0.64	0.13	0.62	0.09	0.45	0.08	0.37	0.33
A 64	2 x 1¼	¾	2.55	0.75	0.30	0.63	0.23	0.71	0.09	0.34	0.10	0.33	0.27
		⅞	1.96	0.57	0.23	0.64	0.18	0.69	0.07	0.35	0.08	0.31	0.27
A 39	1¾ x 1¼	¾	2.34	0.69	0.20	0.54	0.18	0.60	0.09	0.35	0.10	0.35	0.27
		⅞	1.80	0.53	0.16	0.55	0.14	0.58	0.07	0.36	0.08	0.33	0.27
		1	1.23	0.36	0.11	0.56	0.09	0.56	0.05	0.37	0.05	0.31	0.27
A 62	1½ x 1¼	⅞	2.59	0.76	0.16	0.45	0.16	0.52	0.10	0.35	0.11	0.40	0.26
		1	2.13	0.63	0.13	0.46	0.13	0.50	0.08	0.36	0.09	0.38	0.26
		⅞	1.64	0.48	0.10	0.46	0.10	0.48	0.07	0.37	0.07	0.35	0.26

CARNEGIE STEEL COMPANY

ELEMENTS OF EQUAL TEES

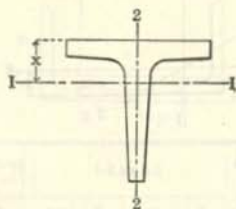

Section Index	Size				Weight per Foot	Area of Section	Axis 1-1				Axis 2-2		
	Flange	Stem	Minimum Thickness				I	r	S	x	I	r	S
			Flange	Stem									
	In.	In.	In.	In.			Lbs.	In. ²	In. ⁴	In.	In. ³	In.	In. ⁴
T 40	6½	6½	0.40	0.45	19.8	5.80	23.5	2.01	5.0	1.76	10.1	1.32	3.1
T 1	4	4	½	½	13.5	3.97	5.7	1.20	2.0	1.18	2.8	0.84	1.4
T 2	4	4	¾	¾	10.5	3.09	4.5	1.21	1.6	1.13	2.1	0.83	1.1
T 3	3½	3½	½	½	11.7	3.44	3.7	1.04	1.5	1.05	1.9	0.74	1.1
T 4	3½	3½	¾	¾	9.2	2.68	3.0	1.05	1.2	1.01	1.4	0.73	0.81
T 6	3	3	½	½	9.9	2.91	2.3	0.88	1.1	0.93	1.2	0.64	0.80
T 7	3	3	⅞	⅞	8.9	2.59	2.1	0.89	0.98	0.91	1.0	0.63	0.70
T 8	3	3	¾	¾	7.8	2.27	1.8	0.90	0.86	0.88	0.90	0.63	0.60
T 9	3	3	⅞	⅞	6.7	1.95	1.6	0.90	0.74	0.86	0.75	0.62	0.50
T 10	2½	2½	¾	¾	6.4	1.87	1.0	0.74	0.59	0.76	0.52	0.53	0.42
T 11	2½	2½	⅞	⅞	5.5	1.60	0.88	0.74	0.50	0.74	0.44	0.52	0.35
T 12	2¼	2¼	⅞	⅞	4.9	1.43	0.65	0.67	0.41	0.68	0.33	0.48	0.29
T 13	2¼	2¼	¾	¾	4.1	1.19	0.52	0.66	0.32	0.65	0.25	0.46	0.22
T 14	2	2	⅞	⅞	4.3	1.26	0.44	0.59	0.31	0.61	0.23	0.43	0.23
T 15	2	2	¾	¾	3.56	1.05	0.37	0.59	0.26	0.59	0.18	0.42	0.18
T 16	1¾	1¾	¾	¾	3.09	0.91	0.23	0.51	0.19	0.54	0.12	0.37	0.14
T 17	1½	1½	¾	¾	2.47	0.73	0.15	0.45	0.14	0.47	0.08	0.32	0.10
T 18	1½	1½	⅞	⅞	1.94	0.57	0.11	0.45	0.11	0.44	0.06	0.32	0.08
T 19	1¼	1¼	¾	¾	2.02	0.59	0.08	0.37	0.10	0.40	0.05	0.28	0.07
T 20	1¼	1¼	⅞	⅞	1.59	0.47	0.06	0.37	0.07	0.38	0.03	0.27	0.05
T 21	1	1	⅞	⅞	1.25	0.37	0.03	0.29	0.05	0.32	0.02	0.22	0.04
T 22	1	1	¾	¾	0.89	0.26	0.02	0.30	0.03	0.29	0.01	0.21	0.02

ELEMENTS OF SECTIONS

ELEMENTS OF UNEQUAL TEES

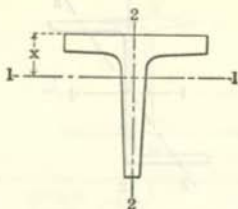

Section Index	Size				Weight per Foot	Area of Section	Axis 1-1				Axis 2-2		
	Flange	Stem	Minimum Thickness				I	r	S	x	I	r	S
			Flange	Stem									
	In.	In.	In.	In.			Lbs.	In. ²	In. ⁴	In.	In. ³	In.	In. ⁴
T 50	5	3	$\frac{3}{8}$	$1\frac{1}{2}$	11.5	3.37	2.4	0.84	1.1	0.76	3.9	1.10	1.6
T 51	5	$2\frac{1}{2}$	$\frac{3}{8}$	$\frac{3}{4}$	10.9	3.18	1.5	0.68	0.78	0.63	4.1	1.14	1.6
T 52	$4\frac{1}{2}$	$3\frac{1}{2}$	$\frac{7}{16}$	$1\frac{1}{2}$	15.7	4.60	5.1	1.05	2.1	1.11	3.7	0.90	1.7
T 54	$4\frac{1}{2}$	3	$\frac{3}{8}$	$\frac{3}{8}$	9.8	2.88	2.1	0.84	0.91	0.74	3.0	1.02	1.3
T 53	$4\frac{1}{2}$	3	$\frac{5}{16}$	$\frac{5}{16}$	8.4	2.46	1.8	0.85	0.78	0.71	2.5	1.01	1.1
T 56	$4\frac{1}{2}$	$2\frac{1}{2}$	$\frac{3}{8}$	$\frac{3}{8}$	9.2	2.68	1.2	0.67	0.63	0.59	3.0	1.05	1.3
T 55	$4\frac{1}{2}$	$2\frac{1}{2}$	$\frac{5}{16}$	$\frac{5}{16}$	7.8	2.29	1.0	0.68	0.54	0.57	2.5	1.05	1.1
T 57	4	5	$\frac{1}{2}$	$\frac{1}{2}$	15.3	4.50	10.8	1.55	3.1	1.56	2.8	0.79	1.4
T 58	4	5	$\frac{3}{8}$	$\frac{3}{8}$	11.9	3.49	8.5	1.56	2.4	1.51	2.1	0.78	1.1
T 59	4	$4\frac{1}{2}$	$\frac{1}{2}$	$\frac{1}{2}$	14.4	4.23	7.9	1.37	2.5	1.37	2.8	0.81	1.4
T 60	4	$4\frac{1}{2}$	$\frac{3}{8}$	$\frac{3}{8}$	11.2	3.29	6.3	1.39	2.0	1.31	2.1	0.80	1.1
T 61	4	3	$\frac{3}{8}$	$\frac{3}{8}$	9.2	2.68	2.0	0.86	0.90	0.78	2.1	0.89	1.1
T 44	4	3	$\frac{3}{8}$	$\frac{5}{16}$	7.8	2.29	1.7	0.87	0.77	0.75	1.8	0.88	0.88
T 62	4	$2\frac{1}{2}$	$\frac{3}{8}$	$\frac{3}{8}$	8.5	2.48	1.2	0.69	0.62	0.62	2.1	0.92	1.0
T 63	4	$2\frac{1}{2}$	$\frac{5}{16}$	$\frac{5}{16}$	7.2	2.12	1.0	0.69	0.53	0.60	1.8	0.91	0.88
T 64	4	2	$\frac{3}{8}$	$\frac{3}{8}$	7.8	2.27	0.60	0.52	0.40	0.48	2.1	0.96	1.1
T 65	4	2	$\frac{5}{16}$	$\frac{5}{16}$	6.7	1.95	0.53	0.52	0.34	0.46	1.8	0.95	0.88
T 66	$3\frac{1}{2}$	4	$\frac{1}{2}$	$\frac{1}{2}$	12.6	3.70	5.5	1.21	2.0	1.24	1.9	0.72	1.1
T 67	$3\frac{1}{2}$	4	$\frac{3}{8}$	$\frac{3}{8}$	9.8	2.88	4.3	1.23	1.5	1.19	1.4	0.70	0.81
T 69	$3\frac{1}{2}$	3	$\frac{1}{2}$	$\frac{1}{2}$	10.8	3.17	2.4	0.87	1.1	0.88	1.9	0.77	1.1
T 70	$3\frac{1}{2}$	3	$\frac{3}{8}$	$\frac{3}{8}$	8.5	2.48	1.9	0.88	0.89	0.83	1.4	0.75	0.81
T 71	$3\frac{1}{2}$	3	$\frac{5}{16}$	$\frac{3}{8}$	7.5	2.20	1.8	0.91	0.85	0.85	1.2	0.74	0.68
T 72	3	4	$\frac{1}{2}$	$\frac{1}{2}$	11.7	3.44	5.2	1.23	1.9	1.32	1.2	0.59	0.81
T 73	3	4	$\frac{5}{16}$	$\frac{5}{16}$	10.5	3.06	4.7	1.23	1.7	1.29	1.1	0.59	0.70
T 74	3	4	$\frac{3}{8}$	$\frac{3}{8}$	9.2	2.68	4.1	1.24	1.5	1.27	0.90	0.58	0.60
T 75	3	$3\frac{1}{2}$	$\frac{1}{2}$	$\frac{1}{2}$	10.8	3.17	3.5	1.06	1.5	1.12	1.2	0.62	0.80
T 76	3	$3\frac{1}{2}$	$\frac{5}{16}$	$\frac{5}{16}$	9.7	2.83	3.2	1.06	1.3	1.10	1.0	0.60	0.69
T 77	3	$3\frac{1}{2}$	$\frac{3}{8}$	$\frac{3}{8}$	8.5	2.48	2.8	1.07	1.2	1.07	0.93	0.61	0.62
T 78	3	$2\frac{1}{2}$	$\frac{3}{8}$	$\frac{3}{8}$	7.1	2.07	1.1	0.72	0.60	0.71	0.89	0.66	0.59
T 79	3	$2\frac{1}{2}$	$\frac{5}{16}$	$\frac{5}{16}$	6.1	1.77	0.94	0.73	0.52	0.68	0.75	0.65	0.50
T 82	$2\frac{1}{2}$	3	$\frac{3}{8}$	$\frac{3}{8}$	7.1	2.07	1.7	0.91	0.84	0.95	0.53	0.51	0.42
T 83	$2\frac{1}{2}$	3	$\frac{5}{16}$	$\frac{5}{16}$	6.1	1.77	1.5	0.92	0.72	0.92	0.44	0.50	0.35
T 86	$2\frac{1}{2}$	$1\frac{1}{4}$	$\frac{5}{16}$	$\frac{5}{16}$	2.87	0.84	0.08	0.31	0.09	0.32	0.29	0.58	0.23
T 87	2	$1\frac{1}{2}$	$\frac{3}{4}$	$\frac{3}{4}$	3.09	0.91	0.16	0.42	0.15	0.42	0.18	0.45	0.18
T 519	$1\frac{1}{2}$	2	$\frac{5}{16}$	$\frac{5}{16}$	2.45	0.72	0.27	0.61	0.19	0.63	0.06	0.92	0.08
T 605	$1\frac{1}{2}$	$1\frac{1}{4}$	$\frac{1}{8}$	$\frac{1}{8}$	1.25	0.37	0.05	0.37	0.05	0.33	0.04	0.32	0.05
T 603	$1\frac{1}{4}$	$\frac{3}{8}$	No. 0	$\frac{1}{8}$	0.88	0.26	0.01	0.16	0.01	0.16	0.02	0.31	0.04

CARNEGIE STEEL COMPANY

ELEMENTS OF ZEES

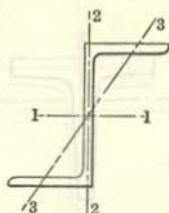

Section Index	Size			Weight per Foot	Area of Section	Axis 1-1			Axis 2-2			Axis 3-3
	Depth	Flanges	Thickness			I	r	S	I	r	S	r min.
	In.	In.	In.			Lbs.	In. ⁴	In.	In. ³	In. ⁴	In.	In. ³
Z 3	6½	3¾	¾	34.6	10.17	50.2	2.22	16.4	19.2	1.37	6.0	0.83
	6½ ₁₆	3¾ ₁₆	¾ ₁₆	32.0	9.40	46.1	2.22	15.2	17.3	1.36	5.5	0.82
	6	3½	¾	29.4	8.63	42.1	2.21	14.0	15.4	1.34	4.9	0.81
Z 2	6½	3¾	1¼ ₁₆	28.1	8.25	43.2	2.29	14.1	16.3	1.41	5.0	0.84
	6½ ₁₆	3¾ ₁₆	¾	25.4	7.46	38.9	2.28	12.8	14.4	1.39	4.4	0.82
	6	3½	¾ ₁₆	22.8	6.68	34.6	2.28	11.5	12.6	1.37	3.9	0.81
Z 1	6½	3¾	½	21.1	6.19	34.4	2.36	11.2	12.9	1.44	3.8	0.84
	6½ ₁₆	3¾ ₁₆	¾ ₁₆	18.4	5.39	29.8	2.35	9.8	11.0	1.43	3.3	0.83
	6	3½	¾	15.7	4.59	25.3	2.35	8.4	9.1	1.41	2.8	0.83
Z 6	5½	3¾	1¾ ₁₆	28.4	8.33	28.7	1.86	11.2	14.4	1.31	4.8	0.76
	5½ ₁₆	3¾ ₁₆	¾	26.0	7.64	26.2	1.85	10.3	12.8	1.30	4.4	0.74
	5	3¼	1¼ ₁₆	23.7	6.96	23.7	1.84	9.5	11.4	1.28	3.9	0.73
Z 5	5½	3¾	¾	22.6	6.64	24.5	1.92	9.6	12.1	1.35	3.9	0.76
	5½ ₁₆	3¾ ₁₆	¾ ₁₆	20.2	5.94	21.8	1.91	8.6	10.5	1.33	3.5	0.75
	5	3¼	½	17.9	5.25	19.2	1.91	7.7	9.1	1.31	3.0	0.74
Z 4	5½	3¾	¾ ₁₆	16.4	4.81	19.1	1.99	7.4	9.2	1.38	2.9	0.77
	5½ ₁₆	3¾ ₁₆	¾	14.0	4.10	16.2	1.99	6.4	7.7	1.37	2.5	0.76
	5	3¼	¾ ₁₆	11.6	3.40	13.4	1.98	5.3	6.2	1.35	2.0	0.75
Z 9	4½	3¾ ₁₆	¾	23.0	6.75	15.0	1.49	7.3	11.2	1.29	4.0	0.68
	4½ ₁₆	3¾ ₁₆	1¼ ₁₆	20.9	6.14	13.5	1.48	6.7	10.0	1.27	3.6	0.67
	4	3½ ₁₆	¾	18.9	5.55	12.1	1.48	6.1	8.7	1.25	3.2	0.66
Z 8	4½	3¾ ₁₆	¾ ₁₆	18.0	5.27	12.7	1.55	6.2	9.3	1.33	3.2	0.68
	4½ ₁₆	3¾ ₁₆	½	15.9	4.66	11.2	1.55	5.5	8.0	1.31	2.8	0.67
	4	3½ ₁₆	¾ ₁₆	13.8	4.05	9.7	1.55	4.8	6.7	1.29	2.4	0.66
Z 7	4½	3¾ ₁₆	¾	12.5	3.66	9.6	1.62	4.7	6.8	1.36	2.3	0.69
	4½ ₁₆	3¾ ₁₆	¾ ₁₆	10.3	3.03	7.9	1.62	3.9	5.5	1.34	1.8	0.68
	4	3½ ₁₆	¾	8.2	2.41	6.3	1.62	3.1	4.2	1.33	1.4	0.67
Z 12	3¾ ₁₆	2¾	¾ ₁₆	14.3	4.18	5.3	1.12	3.4	5.7	1.17	2.3	0.54
	3	2½ ₁₆	½	12.6	3.69	4.6	1.12	3.1	4.9	1.15	2.0	0.53
Z 11	3¾ ₁₆	2¾	¾ ₁₆	11.5	3.36	4.6	1.17	3.0	4.8	1.19	1.9	0.55
	3	2½ ₁₆	¾	9.8	2.86	3.9	1.16	2.6	3.9	1.17	1.6	0.54
Z 10	3¾ ₁₆	2¾	¾ ₁₆	8.5	2.48	3.6	1.21	2.4	3.6	1.21	1.4	0.56
	3	2½ ₁₆	¾	6.7	1.97	2.9	1.21	1.9	2.8	1.19	1.1	0.55

ELEMENTS OF SECTIONS

ELEMENTS OF CROSS TIES

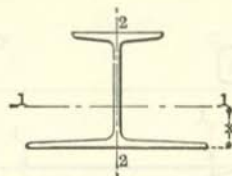

Section Index	Depth of Section	Wt. per Foot	Area of Section	Width of Flange		Thickness of Web	Axis 1-1				Axis 2-2		
				Top	Bottom		I	r	S	x	I	r	S
				In.	In.		In. ⁴	In.	In. ³	In.	In. ⁴	In.	In. ³
M 28A	6.50	29.8	8.76	5.0	10.0	.438	59.4	2.47	15.0	2.55	30.8	1.88	6.2
M 29	5.50	24.0	7.01	5.0	8.0	.375	35.4	2.25	11.3	2.38	16.8	1.55	4.2
M 21	5.50	20.0	5.71	4.5	8.0	.250	30.9	2.33	9.7	2.33	14.9	1.62	3.7
M 25	4.25	14.5	4.10	4.0	6.0	.250	13.0	1.78	5.5	1.88	6.1	1.22	2.0
M 24	3.00	9.5	2.80	3.0	5.0	.203	4.3	1.24	2.5	1.27	3.1	1.05	1.2

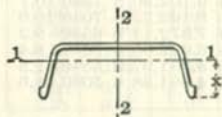

Section Index	Depth of Section	Wt. per Foot	Area of Section	Width of Section		Thickness	Axis 1-1				Axis 2-2		
				Top	Bottom		I	r	S	x	I	r	S
				In.	In.		In. ⁴	In.	In. ³	In.	In. ⁴	In.	In. ³
M 27	2.25	9.0	2.62	5.5	7.0	.250	1.28	0.70	0.79	1.62	16.8	2.53	4.8
M 20	2.00	6.0	1.72	4.5	6.0	.188	0.71	0.64	0.51	1.41	8.4	2.22	2.8
M 18	1.50	4.0	1.21	3.4	5.0	.156	0.31	0.50	0.31	1.00	3.6	1.73	1.5



Section Index	Depth of Section	Wt. per Foot	Area of Section	Width of Section	Thickness	Axis 1-1				Axis 2-2		
						I	r	S	x	I	r	S
						In. ⁴	In.	In. ³	In.	In. ⁴	In.	In. ³
M 26	1 $\frac{3}{16}$	3.20	0.97	4 $\frac{13}{16}$.125	0.059	0.25	0.110	0.54	2.44	1.58	0.99
M 19	1 $\frac{1}{16}$	2.51	0.74	4	.141	0.024	0.18	0.057	0.43	1.15	1.25	0.58

CARNEGIE STEEL COMPANY

ELEMENTS OF RAILS AND SPLICE BARS

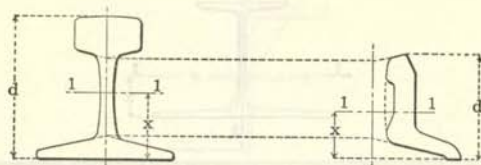

Section Index	Weight per Yard	Depth of Section	Area of Section	Axis 1-1			Section Index	Weight per Foot	Depth of Section	Area of Section	Axis 1-1		
				I	S	x					*I	*S	x
				In. ⁴	In. ³	In.					In. ⁴	In. ³	In.
A. S. C. E. RAILS						A. S. C. E. SPLICE BARS							
10040	100	5 $\frac{1}{8}$	9.84	43.97	14.55	2.73	S10040	15.8	4 $\frac{7}{32}$	4.65	13.43	5.82	1.91
9040	90	5 $\frac{3}{8}$	8.83	34.39	12.19	2.55	S 9040	13.5	3 $\frac{61}{64}$	3.97	10.30	4.79	1.81
8540	85	5 $\frac{1}{16}$	8.33	30.07	11.08	2.47	S 8540	12.4	3 $\frac{19}{16}$	3.65	8.43	4.02	1.71
8040	80	5	7.86	26.38	10.07	2.38	S 8040	11.5	3 $\frac{21}{32}$	3.38	7.39	3.75	1.68
7540	75	4 $\frac{31}{64}$	7.33	22.86	9.10	2.30	S 7540	10.7	3 $\frac{1}{8}$	3.15	6.02	3.28	1.65
7040	70	4 $\frac{1}{8}$	6.81	19.70	8.19	2.22	S 7040	10.0	3 $\frac{15}{32}$	2.95	5.82	3.15	1.61
6540	65	4 $\frac{1}{16}$	6.33	16.90	7.37	2.14	S 6540	9.2	3 $\frac{11}{32}$	2.71	4.85	2.73	1.56
6040	60	4 $\frac{1}{4}$	5.93	14.56	6.62	2.05	S 6040	8.4	3 $\frac{1}{8}$	2.47	4.04	2.38	1.51
5540	55	4 $\frac{1}{16}$	5.38	12.03	5.75	1.97	S 5540	7.5	3 $\frac{1}{16}$	2.21	3.41	2.07	1.41
5040	50	3 $\frac{7}{8}$	4.87	9.94	4.98	1.88	S 5040	6.6	2 $\frac{1}{16}$	1.95	2.72	1.74	1.37
A. R. A. RAILS—TYPE A						A. R. A. SPLICE BARS—TYPE A							
10020	100	6	9.84	48.94	15.04	2.75	S10020	19.0	4 $\frac{23}{32}$	5.60	21.30	7.88	2.02
9020	90	5 $\frac{5}{8}$	8.82	38.70	12.56	2.54	S 9020	16.6	4 $\frac{7}{16}$	4.90	16.10	6.36	1.91
8020	80	5 $\frac{1}{8}$	7.86	28.80	10.24	2.31	S 8020	13.4	3 $\frac{15}{16}$	3.95	10.13	4.57	1.72
7020	70	4 $\frac{3}{4}$	6.82	21.05	8.21	2.20	S 7020	11.6	3 $\frac{17}{32}$	3.43	7.42	3.63	1.48
6020	60	4 $\frac{1}{2}$	5.86	15.41	6.50	2.13	S 6020	10.6	3 $\frac{1}{2}$	3.13	6.22	3.16	1.52
A. R. A. RAILS—TYPE B						A. R. A. SPLICE BARS—TYPE B							
10030	100	5 $\frac{11}{64}$	9.85	41.30	13.70	2.63	S10030	16.9	4 $\frac{7}{64}$	4.98	14.34	6.30	1.83
9030	90	5 $\frac{17}{64}$	8.87	32.30	11.45	2.44	S 9030	14.4	3 $\frac{69}{64}$	4.24	10.16	4.71	1.67
8030	80	4 $\frac{15}{16}$	7.91	25.10	9.38	2.27	S 8030	12.6	3 $\frac{5}{8}$	3.72	7.70	3.79	1.59
LIGHT RAILS						LIGHT RAIL SPLICE BARS							
4540	45	3 $\frac{11}{16}$	4.40	8.13	4.25	1.78	S 4540	5.8	2 $\frac{25}{32}$	1.70			1.29
4040	40	3 $\frac{1}{2}$	3.94	6.57	3.62	1.68	S 4040	5.0	2 $\frac{5}{8}$	1.47			1.27
3540	35	3 $\frac{9}{16}$	3.44	5.17	3.02	1.60	S 3540	4.6	2 $\frac{21}{64}$	1.35			1.19
3040	30	3 $\frac{1}{8}$	3.00	4.06	2.53	1.52	S 3040	3.97	2 $\frac{13}{32}$	1.17			1.10
2540	25	2 $\frac{3}{4}$	2.39	2.50	1.77	1.33	S 2540	2.20	1 $\frac{51}{64}$	0.65			0.90
2040	20	2 $\frac{1}{8}$	2.00	1.94	1.43	1.27	S 2040	1.87	1 $\frac{23}{32}$	0.55			0.86
1640	16	2 $\frac{3}{8}$	1.55	1.24	1.01	1.15	S 1640	1.70	1 $\frac{37}{64}$	0.50			0.79
1440	14	2 $\frac{1}{16}$	1.34	0.76	0.73	1.02	S 1440	1.36	1 $\frac{19}{64}$	0.40			0.65
1240	12	2	1.18	0.66	0.63	0.96	S 1240	1.36	1 $\frac{19}{64}$	0.40			0.65
1040	10	1 $\frac{3}{4}$	0.96	0.40	0.46	0.87	S 1040	0.99	1 $\frac{7}{64}$	0.29			0.56
840	8	1 $\frac{1}{16}$	0.77	0.26	0.32	0.75	S 840	0.75	3 $\frac{1}{32}$	0.22			0.49

*Moment of Inertia and Section Modulus are given for pair of Splice Bars. *

RADIi OF GYRATION FOR TWO EQUAL ANGLES

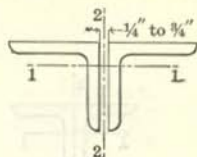
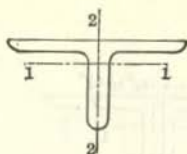

Single Angle		Weight, Pounds per Foot	Area of Two Angles, Inches ²	Radii of Gyration of Two Angles, Inches					
Size, Inches	Thick- ness, Inches			Axis 1-1	Axis 2-2				
				In Contact	1/4" Apart	3/8" Apart	1/2" Apart	3/4" Apart	
8 x 8	1 1/8	56.9	33.46	2.42	3.42	3.51	3.55	3.60	3.69
	1 3/16	42.0	24.68	2.46	3.37	3.46	3.50	3.55	3.64
	1 1/2	26.4	15.50	2.50	3.33	3.41	3.45	3.50	3.59
6 x 6	1	37.4	22.00	1.80	2.59	2.68	2.72	2.77	2.87
	1 1/16	26.5	15.56	1.83	2.54	2.63	2.67	2.71	2.81
	5/8	14.9	8.72	1.88	2.49	2.58	2.62	2.66	2.75
5 x 5	1	30.6	18.00	1.48	2.19	2.28	2.33	2.38	2.47
	1 1/16	21.8	12.80	1.51	2.13	2.22	2.26	2.31	2.40
	3/8	12.3	7.22	1.56	2.09	2.17	2.21	2.26	2.35
4 x 4	1 3/16	19.9	11.68	1.18	1.75	1.85	1.89	1.94	2.04
	1/4	6.6	3.88	1.25	1.66	1.75	1.79	1.84	1.93
	1 3/16	17.1	10.06	1.02	1.55	1.65	1.70	1.75	1.85
3 1/2 x 3 1/2	3/4	5.8	3.38	1.09	1.46	1.55	1.59	1.64	1.73
	5/8	11.5	6.72	0.88	1.32	1.41	1.46	1.51	1.61
	3/4	4.9	2.88	0.93	1.25	1.34	1.38	1.43	1.53
2 1/2 x 2 1/2	1/2	7.7	4.50	0.74	1.09	1.19	1.24	1.29	1.39
	3/4	4.1	2.38	0.77	1.05	1.14	1.19	1.24	1.34
	7/16	5.3	3.12	0.59	0.88	0.98	1.03	1.08	1.19
2 x 2	1/2	3.19	1.88	0.61	0.85	0.94	0.99	1.04	1.14

This table and the two following are employed in computing the safe resistance to compressive stress of two angles, back to back, used as a strut or as the compression chord of a roof truss, etc., as follows:

Obtain from the compression formula in use the allowed stress per square inch corresponding to the ratio of slenderness of the section, and multiply that value by the area. The result will be the allowable compressive stress.

Example 1. Section given. Required the safe load in compression as per formula $f=19000-100 l/r$ on a strut composed of two angles $4'' \times 4'' \times 1/4''$, back to back, with an unsupported length of 9 feet.

Area of Section, $A=3.88$ square inches; Least Radius, $r=1.25$.

Ratio of Slenderness, $l/r = 9 \times 12 \div 1.25=86.4$.

Allowed Unit Stress, $f=19000-100 \times 86.4=10360$ pounds per square inch.

Safe Load, $Af=3.88 \times 10360=40200$ pounds.

Example 2. Stress given. Required a section for a member in compression $12' 3''$ long, made of two angles separated by $1/2$ inch gusset plates, to resist a total stress of 35000 pounds; ratio of slenderness not to exceed 120.

Assume 2 angles, $5'' \times 3'' \times 5/16''$, long legs, back to back.

Area of Section, $A=4.80$ square inches; Least Radius, $r=1.26$ inches.

Ratio of Slenderness, $l/r = 12.25 \times 12 \div 1.26=116.7$.

Allowed Unit Stress, $f=19000-100 \times 116.7=7330$ pounds per square inch.

Safe Stress, $Af=4.80 \times 7330=35200$ pounds.

In the first case the least radius is that about axis 1-1; in the second case about axis 2-2; in all cases the least radius determines the ratio of slenderness and therewith the allowed safe compressive stress. In all cases also the two angles are to be secured together by stay rivets so spaced as to insure that the section acts as a unit. The ratio of slenderness of any single angle between rivets must always be less than that of the strut or compression chord.

CARNEGIE STEEL COMPANY

RADII OF GYRATION FOR TWO UNEQUAL ANGLES

Long Legs Vertical

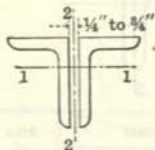
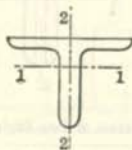

Single Angle			Area of Two Angles, Inches ²	Radii of Gyration of Two Angles, Inches					
Size, Inches	Thick-ness, Inches	Weight, Pounds per Foot		Axis 1-1	Axis 2-2				
					In Contact	$\frac{1}{4}$ " Apart	$\frac{3}{8}$ " Apart	$\frac{1}{2}$ " Apart	$\frac{3}{4}$ " Apart
8 x 6	1	44.2	26.00	2.49	2.39	2.48	2.52	2.57	2.66
	$\frac{3}{4}$	33.8	19.88	2.53	2.35	2.44	2.48	2.52	2.61
	$\frac{7}{16}$	20.2	11.86	2.57	2.31	2.39	2.43	2.48	2.56
8 x 3 $\frac{1}{2}$	1	35.7	21.00	2.51	1.26	1.35	1.40	1.45	1.55
	$\frac{3}{4}$	27.5	16.12	2.55	1.20	1.29	1.34	1.39	1.49
	$\frac{7}{16}$	16.5	9.68	2.59	1.15	1.23	1.28	1.32	1.41
7 x 3 $\frac{1}{2}$	1	32.3	19.00	2.19	1.31	1.40	1.45	1.50	1.60
	$\frac{11}{16}$	23.0	13.50	2.23	1.25	1.34	1.39	1.44	1.53
	$\frac{9}{8}$	13.0	7.60	2.27	1.20	1.28	1.33	1.37	1.46
6 x 4	1	30.6	18.00	1.85	1.60	1.69	1.74	1.79	1.89
	$\frac{11}{16}$	21.8	12.80	1.89	1.55	1.63	1.68	1.73	1.82
	$\frac{9}{8}$	12.3	7.22	1.93	1.50	1.58	1.62	1.67	1.76
6 x 3 $\frac{1}{2}$	1	28.9	17.00	1.85	1.37	1.47	1.51	1.56	1.66
	$\frac{11}{16}$	20.6	12.12	1.89	1.31	1.41	1.45	1.49	1.60
	$\frac{9}{16}$	9.8	5.74	1.95	1.25	1.33	1.37	1.42	1.50
5 x 4	$\frac{7}{8}$	24.2	14.22	1.52	1.66	1.76	1.80	1.85	1.95
	$\frac{9}{8}$	11.0	6.46	1.59	1.58	1.66	1.70	1.75	1.85
	$\frac{7}{8}$	22.7	13.34	1.53	1.42	1.51	1.56	1.61	1.71
5 x 3 $\frac{1}{2}$	$\frac{7}{8}$	8.7	5.12	1.61	1.33	1.41	1.45	1.50	1.59
	$\frac{13}{16}$	19.9	11.68	1.55	1.18	1.27	1.32	1.37	1.47
	$\frac{9}{16}$	8.2	4.80	1.61	1.09	1.17	1.22	1.26	1.35
4 $\frac{1}{2}$ x 3	$\frac{13}{16}$	18.5	10.86	1.38	1.21	1.31	1.36	1.41	1.51
	$\frac{9}{16}$	7.7	4.50	1.44	1.13	1.22	1.26	1.30	1.40
	$\frac{13}{16}$	18.5	10.86	1.19	1.50	1.59	1.64	1.69	1.79
4 x 3 $\frac{1}{2}$	$\frac{9}{16}$	7.7	4.50	1.26	1.42	1.51	1.55	1.60	1.69
	$\frac{13}{16}$	17.1	10.06	1.21	1.25	1.35	1.40	1.45	1.55
	$\frac{1}{4}$	5.8	3.38	1.28	1.16	1.24	1.28	1.33	1.43
3 $\frac{1}{2}$ x 3	$\frac{13}{16}$	15.8	9.24	1.04	1.30	1.40	1.45	1.50	1.60
	$\frac{1}{4}$	5.4	3.12	1.11	1.20	1.29	1.34	1.38	1.48
	$\frac{11}{16}$	12.5	7.30	1.06	1.03	1.13	1.18	1.23	1.33
3 $\frac{1}{2}$ x 2 $\frac{1}{2}$	$\frac{1}{4}$	4.9	2.88	1.12	0.95	1.04	1.09	1.13	1.23
	$\frac{9}{16}$	9.5	5.56	0.91	1.05	1.15	1.20	1.25	1.35
	$\frac{1}{4}$	4.5	2.64	0.95	1.00	1.09	1.13	1.18	1.28
3 x 2	$\frac{1}{2}$	7.7	4.50	0.92	0.80	0.89	0.94	1.00	1.10
	$\frac{1}{4}$	4.1	2.38	0.95	0.74	0.84	0.88	0.93	1.03
	$\frac{1}{4}$	6.8	4.00	0.75	0.84	0.94	0.99	1.04	1.15
2 $\frac{1}{2}$ x 2	$\frac{1}{4}$	3.62	2.12	0.78	0.80	0.89	0.93	0.98	1.08

ELEMENTS OF SECTIONS

RADI OF GYRATION FOR TWO UNEQUAL ANGLES

Short Legs Vertical

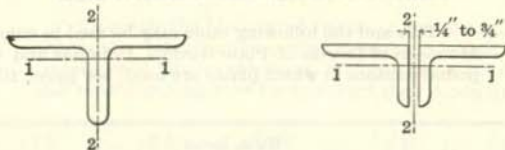

Single Angle			Area of Two Angles, Inches ²	Radii of Gyration of Two Angles, Inches				
Size, Inches	Thick- ness, Inches	Weight, Pounds per Foot		Axis 1-1	Axis 2-2			
				In Contact	1/4" Apart	3/8" Apart	1/2" Apart	3/4" Apart
8 x 6	1	44.2	26.00	1.73	3.64	3.73	3.78	3.83
	3/4	33.8	19.88	1.76	3.60	3.69	3.73	3.78
	5/16	20.2	11.86	1.80	3.55	3.64	3.68	3.73
8 x 3 1/2	1	35.7	21.00	0.86	4.04	4.14	4.19	4.24
	3/4	27.5	16.12	0.88	3.99	4.09	4.13	4.18
	5/16	16.5	9.68	0.92	3.93	4.02	4.07	4.12
7 x 3 1/2	1	32.3	19.00	0.89	3.48	3.58	3.63	3.68
	11/16	23.0	13.50	0.92	3.42	3.52	3.57	3.62
	3/8	13.0	7.60	0.96	3.36	3.46	3.50	3.55
6 x 4	1	30.6	18.00	1.09	2.85	2.95	2.99	3.04
	11/16	21.8	12.80	1.13	2.79	2.89	2.93	2.98
	3/8	12.3	7.22	1.17	2.74	2.83	2.87	2.92
6 x 3 1/2	1	28.9	17.00	0.92	2.92	3.02	3.07	3.12
	11/16	20.6	12.12	0.95	2.87	2.96	3.01	3.06
	5/16	9.8	5.74	1.00	2.81	2.90	2.95	3.00
5 x 4	7/8	24.2	14.22	1.14	2.29	2.38	2.43	2.48
	3/8	11.0	6.46	1.20	2.20	2.29	2.34	2.38
5 x 3 1/2	7/8	22.7	13.34	0.96	2.36	2.45	2.50	2.55
	5/16	8.7	5.12	1.03	2.26	2.35	2.39	2.44
5 x 3	13/16	19.9	11.68	0.80	2.42	2.52	2.57	2.62
	5/16	8.2	4.80	0.85	2.33	2.42	2.47	2.52
4 1/2 x 3	13/16	18.5	10.86	0.81	2.15	2.25	2.30	2.35
	5/16	7.7	4.50	0.87	2.06	2.15	2.20	2.25
4 x 3 1/2	13/16	18.5	10.86	1.01	1.81	1.91	1.96	2.01
	5/16	7.7	4.50	1.07	1.73	1.81	1.86	1.91
4 x 3	13/16	17.1	10.06	0.83	1.88	1.98	2.03	2.08
	1/4	5.8	3.38	0.89	1.78	1.87	1.92	1.96
3 1/2 x 3	13/16	15.8	9.24	0.85	1.61	1.71	1.76	1.81
	1/4	5.4	3.12	0.91	1.52	1.61	1.65	1.70
3 1/2 x 2 1/2	13/16	12.5	7.30	0.69	1.66	1.75	1.80	1.86
	1/4	4.9	2.88	0.74	1.58	1.67	1.71	1.76
3 x 2 1/2	9/16	9.5	5.56	0.72	1.37	1.46	1.51	1.56
	1/4	4.5	2.64	0.75	1.31	1.40	1.45	1.50
3 x 2	1/2	7.7	4.50	0.55	1.42	1.52	1.57	1.62
	1/4	4.1	2.38	0.57	1.38	1.47	1.52	1.57
2 1/2 x 2	1/2	6.8	4.00	0.56	1.15	1.25	1.30	1.35
	1/4	3.62	2.12	0.59	1.11	1.20	1.25	1.30

CARNEGIE STEEL COMPANY

MOMENTS OF INERTIA OF RECTANGLES

IN WIDTHS FROM 1/4 TO 3/8 INCH AND 1 INCH

Neutral Axis Through Center Normal to Depth

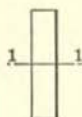

This and the following table may be used in computing the Moments of Inertia of Plate Girders, Columns and other compound sections in which plates are used; see pages 108 and 109.

Depth, Inches	Width, Inches							
	1/4	5/16	3/8	7/16	1/2	5/8	3/4	1
1	.021	.026	.031	.037	.042	.047	.052	.083
2	.167	.208	.250	.292	.333	.375	.417	.667
3	.563	.703	.844	.984	1.125	1.266	1.406	2.250
4	1.333	1.667	2.000	2.333	2.667	3.000	3.333	5.333
5	2.604	3.255	3.906	4.557	5.208	5.859	6.510	10.417
6	4.500	5.625	6.750	7.875	9.000	10.125	11.250	18.000
7	7.146	8.932	10.719	12.505	14.292	16.078	17.865	28.583
8	10.667	13.333	16.000	18.667	21.333	24.000	26.667	42.667
9	15.188	18.984	22.781	26.578	30.375	34.172	37.969	60.750
10	20.833	26.042	31.250	36.458	41.667	46.875	52.083	83.333
11	27.729	34.662	41.594	48.526	55.458	62.391	69.323	110.917
12	36.000	45.000	54.000	63.000	72.000	81.000	90.000	144.000
13	45.771	57.214	68.656	80.099	91.542	102.984	114.427	183.083
14	57.167	71.458	85.750	100.042	114.333	128.625	142.917	228.667
15	70.313	87.891	105.469	123.047	140.625	158.203	175.781	281.250
16	85.333	106.667	128.000	149.333	170.667	192.000	213.333	341.333
17	102.354	127.943	153.531	179.120	204.708	230.297	255.885	409.317
18	121.500	151.875	182.250	212.625	243.000	273.375	303.750	486.000
19	142.896	178.620	214.344	250.068	285.792	321.516	357.240	571.583
20	166.667	208.333	250.000	291.667	333.333	375.000	416.667	666.667
21	192.938	241.172	289.406	337.641	385.875	434.109	482.344	771.750
22	221.833	277.292	332.750	388.208	443.667	499.125	554.583	887.333
23	253.479	316.849	380.219	443.589	506.958	570.328	633.698	1013.917
24	288.000	360.000	432.000	504.000	576.000	648.000	720.000	1152.000
25	325.521	406.901	488.281	569.662	651.042	732.422	813.802	1302.083
26	366.167	457.708	549.250	640.792	732.333	823.875	915.417	1464.667
27	410.063	512.578	615.094	717.609	820.125	922.641	1025.156	1640.250
28	457.333	571.667	686.000	800.333	914.667	1029.000	1143.333	1829.333
29	508.104	635.130	762.156	889.182	1016.208	1143.234	1270.260	2032.417
30	562.500	703.125	843.750	984.375	1125.000	1265.625	1406.250	2250.000
32	682.667	853.333	1024.000	1194.667	1365.333	1536.000	1706.667	2730.667
34	818.833	1023.542	1228.250	1432.958	1637.667	1842.375	2047.083	3275.333
36	972.000	1215.000	1458.000	1701.000	1944.000	2187.000	2430.000	3888.000
38	1143.167	1428.958	1714.750	2000.542	2286.333	2572.125	2857.917	4572.667
40	1333.333	1666.667	2000.000	2333.333	2666.667	3000.000	3333.333	5333.333
42	1543.500	1929.375	2315.250	2701.125	3087.000	3472.875	3858.750	6174.000
44	1774.667	2218.333	2662.000	3105.667	3549.333	3993.000	4436.667	7098.667
46	2027.833	2534.792	3041.750	3548.708	4055.667	4562.625	5069.583	8111.333
48	2304.000	2880.000	3456.000	4032.000	4608.000	5184.000	5760.000	9216.000
50	2604.167	3255.208	3906.250	4557.292	5208.333	5859.375	6510.417	10416.667
52	2929.333	3661.667	4394.000	5126.333	5858.667	6591.000	7323.333	11717.333
54	3280.500	4100.625	4920.750	5740.875	6561.000	7381.125	8201.250	13122.000
56	3658.667	4573.333	5488.000	6402.667	7317.333	8232.000	9146.667	14634.667
58	4064.833	5081.042	6097.250	7113.458	8129.667	9145.875	10162.083	16259.333
60	4500.000	5625.000	6750.000	7875.000	9000.000	10125.000	11250.000	18000.000

ELEMENTS OF SECTIONS

MOMENTS OF INERTIA OF RECTANGLES

IN WIDTHS OF 1 INCH

Neutral Axis Through Center Normal to Depth

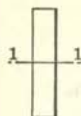

To obtain the Moment of Inertia of any rectangle, multiply the tabular value for its depth by its width in inches. For deeper rectangles of tabular thickness, multiply the tabular values for half their depth by 8; or for one-third their depth by 27, etc.

Depth, Inches	I_{1-1} Inches ⁴	Depth, Inches	I_{1-1} Inches ⁴	Depth, Inches	I_{1-1} Inches ⁴	Depth, Inches	I_{1-1} Inches ⁴	Depth, Inches	I_{1-1} Inches ⁴	Depth, Inches	I_{1-1} Inches ⁴
0	.000	6	18.000	12	144.000	18	486.000	24	1152.000	30	2250.000
$\frac{1}{8}$.000	$\frac{1}{8}$	19.149	$\frac{1}{8}$	148.547	$\frac{1}{8}$	496.195	$\frac{1}{8}$	1170.094	$\frac{1}{8}$	2278.243
$\frac{1}{4}$.001	$\frac{1}{4}$	20.345	$\frac{1}{4}$	153.189	$\frac{1}{4}$	506.533	$\frac{1}{4}$	1188.376	$\frac{1}{4}$	2306.721
$\frac{3}{8}$.004	$\frac{3}{8}$	21.590	$\frac{3}{8}$	157.926	$\frac{3}{8}$	517.012	$\frac{3}{8}$	1206.848	$\frac{3}{8}$	2335.434
$\frac{1}{2}$.010	$\frac{1}{2}$	22.885	$\frac{1}{2}$	162.760	$\frac{1}{2}$	527.635	$\frac{1}{2}$	1225.510	$\frac{1}{2}$	2364.385
$\frac{5}{8}$.020	$\frac{5}{8}$	24.231	$\frac{5}{8}$	167.692	$\frac{5}{8}$	538.403	$\frac{5}{8}$	1244.364	$\frac{5}{8}$	2393.575
$\frac{3}{4}$.035	$\frac{3}{4}$	25.629	$\frac{3}{4}$	172.723	$\frac{3}{4}$	549.317	$\frac{3}{4}$	1263.410	$\frac{3}{4}$	2423.004
$\frac{7}{8}$.056	$\frac{7}{8}$	27.079	$\frac{7}{8}$	177.853	$\frac{7}{8}$	560.376	$\frac{7}{8}$	1282.650	$\frac{7}{8}$	2452.674
1	.083	7	28.583	13	183.083	9	571.583	25	1302.083	31	2482.583
$\frac{1}{8}$.119	$\frac{1}{8}$	30.142	$\frac{1}{8}$	188.416	$\frac{1}{8}$	582.939	$\frac{1}{8}$	1321.713	$\frac{1}{8}$	2512.737
$\frac{1}{4}$.163	$\frac{1}{4}$	31.757	$\frac{1}{4}$	193.850	$\frac{1}{4}$	594.444	$\frac{1}{4}$	1341.538	$\frac{1}{4}$	2543.132
$\frac{3}{8}$.217	$\frac{3}{8}$	33.428	$\frac{3}{8}$	199.389	$\frac{3}{8}$	606.099	$\frac{3}{8}$	1361.561	$\frac{3}{8}$	2573.771
$\frac{1}{2}$.281	$\frac{1}{2}$	35.156	$\frac{1}{2}$	205.031	$\frac{1}{2}$	617.906	$\frac{1}{2}$	1381.781	$\frac{1}{2}$	2604.656
$\frac{5}{8}$.358	$\frac{5}{8}$	36.944	$\frac{5}{8}$	210.779	$\frac{5}{8}$	629.866	$\frac{5}{8}$	1402.202	$\frac{5}{8}$	2635.787
$\frac{3}{4}$.447	$\frac{3}{4}$	38.790	$\frac{3}{4}$	216.634	$\frac{3}{4}$	641.978	$\frac{3}{4}$	1422.821	$\frac{3}{4}$	2667.165
$\frac{7}{8}$.549	$\frac{7}{8}$	40.698	$\frac{7}{8}$	222.596	$\frac{7}{8}$	654.245	$\frac{7}{8}$	1443.644	$\frac{7}{8}$	2698.792
2	.667	8	42.667	14	228.667	20	666.667	26	1464.667	32	2730.667
$\frac{1}{8}$.800	$\frac{1}{8}$	44.698	$\frac{1}{8}$	234.847	$\frac{1}{8}$	679.245	$\frac{1}{8}$	1485.893	$\frac{1}{8}$	2762.792
$\frac{1}{4}$.949	$\frac{1}{4}$	46.793	$\frac{1}{4}$	241.137	$\frac{1}{4}$	691.840	$\frac{1}{4}$	1507.324	$\frac{1}{4}$	2795.168
$\frac{3}{8}$	1.116	$\frac{3}{8}$	48.952	$\frac{3}{8}$	247.538	$\frac{3}{8}$	704.874	$\frac{3}{8}$	1528.961	$\frac{3}{8}$	2827.797
$\frac{1}{2}$	1.302	$\frac{1}{2}$	51.177	$\frac{1}{2}$	254.052	$\frac{1}{2}$	717.927	$\frac{1}{2}$	1550.802	$\frac{1}{2}$	2860.677
$\frac{5}{8}$	1.507	$\frac{5}{8}$	53.468	$\frac{5}{8}$	260.679	$\frac{5}{8}$	731.141	$\frac{5}{8}$	1572.851	$\frac{5}{8}$	2893.812
$\frac{3}{4}$	1.733	$\frac{3}{4}$	55.827	$\frac{3}{4}$	267.421	$\frac{3}{4}$	744.514	$\frac{3}{4}$	1595.108	$\frac{3}{4}$	2927.202
$\frac{7}{8}$	1.980	$\frac{7}{8}$	58.254	$\frac{7}{8}$	274.277	$\frac{7}{8}$	758.051	$\frac{7}{8}$	1617.575	$\frac{7}{8}$	2960.849
3	2.250	9	60.750	15	281.250	21	771.750	27	1640.250	33	2994.750
$\frac{1}{8}$	2.543	$\frac{1}{8}$	63.317	$\frac{1}{8}$	288.340	$\frac{1}{8}$	785.613	$\frac{1}{8}$	1663.136	$\frac{1}{8}$	3028.911
$\frac{1}{4}$	2.861	$\frac{1}{4}$	65.954	$\frac{1}{4}$	295.548	$\frac{1}{4}$	799.652	$\frac{1}{4}$	1686.236	$\frac{1}{4}$	3063.329
$\frac{3}{8}$	3.204	$\frac{3}{8}$	68.665	$\frac{3}{8}$	302.875	$\frac{3}{8}$	813.836	$\frac{3}{8}$	1709.547	$\frac{3}{8}$	3098.009
$\frac{1}{2}$	3.573	$\frac{1}{2}$	71.448	$\frac{1}{2}$	310.323	$\frac{1}{2}$	828.198	$\frac{1}{2}$	1733.073	$\frac{1}{2}$	3132.948
$\frac{5}{8}$	3.970	$\frac{5}{8}$	74.305	$\frac{5}{8}$	317.891	$\frac{5}{8}$	842.727	$\frac{5}{8}$	1756.814	$\frac{5}{8}$	3168.150
$\frac{3}{4}$	4.395	$\frac{3}{4}$	77.238	$\frac{3}{4}$	325.582	$\frac{3}{4}$	857.426	$\frac{3}{4}$	1780.770	$\frac{3}{4}$	3203.614
$\frac{7}{8}$	4.849	$\frac{7}{8}$	80.247	$\frac{7}{8}$	333.396	$\frac{7}{8}$	872.294	$\frac{7}{8}$	1804.943	$\frac{7}{8}$	3239.341
4	5.333	10	83.333	16	341.333	22	887.333	28	1829.333	34	3275.333
$\frac{1}{8}$	5.849	$\frac{1}{8}$	86.498	$\frac{1}{8}$	349.396	$\frac{1}{8}$	902.545	$\frac{1}{8}$	1853.943	$\frac{1}{8}$	3311.592
$\frac{1}{4}$	6.397	$\frac{1}{4}$	89.741	$\frac{1}{4}$	357.585	$\frac{1}{4}$	917.928	$\frac{1}{4}$	1878.773	$\frac{1}{4}$	3348.117
$\frac{3}{8}$	6.978	$\frac{3}{8}$	93.064	$\frac{3}{8}$	365.900	$\frac{3}{8}$	933.486	$\frac{3}{8}$	1903.823	$\frac{3}{8}$	3384.909
$\frac{1}{2}$	7.594	$\frac{1}{2}$	96.469	$\frac{1}{2}$	374.344	$\frac{1}{2}$	949.219	$\frac{1}{2}$	1929.094	$\frac{1}{2}$	3421.969
$\frac{5}{8}$	8.244	$\frac{5}{8}$	99.955	$\frac{5}{8}$	382.916	$\frac{5}{8}$	965.127	$\frac{5}{8}$	1954.588	$\frac{5}{8}$	3459.300
$\frac{3}{4}$	8.931	$\frac{3}{4}$	103.525	$\frac{3}{4}$	391.618	$\frac{3}{4}$	981.212	$\frac{3}{4}$	1980.305	$\frac{3}{4}$	3496.900
$\frac{7}{8}$	9.655	$\frac{7}{8}$	107.178	$\frac{7}{8}$	400.452	$\frac{7}{8}$	997.475	$\frac{7}{8}$	2006.249	$\frac{7}{8}$	3534.772
5	10.417	11	110.917	17	409.417	23	1013.917	29	2032.417	35	3572.917
$\frac{1}{8}$	11.218	$\frac{1}{8}$	114.741	$\frac{1}{8}$	418.515	$\frac{1}{8}$	1030.538	$\frac{1}{8}$	2058.811	$\frac{1}{8}$	3611.334
$\frac{1}{4}$	12.059	$\frac{1}{4}$	118.652	$\frac{1}{4}$	427.746	$\frac{1}{4}$	1047.340	$\frac{1}{4}$	2085.434	$\frac{1}{4}$	3650.027
$\frac{3}{8}$	12.941	$\frac{3}{8}$	122.652	$\frac{3}{8}$	437.113	$\frac{3}{8}$	1064.323	$\frac{3}{8}$	2112.285	$\frac{3}{8}$	3688.994
$\frac{1}{2}$	13.865	$\frac{1}{2}$	126.740	$\frac{1}{2}$	446.615	$\frac{1}{2}$	1081.490	$\frac{1}{2}$	2139.365	$\frac{1}{2}$	3728.240
$\frac{5}{8}$	14.832	$\frac{5}{8}$	130.918	$\frac{5}{8}$	456.253	$\frac{5}{8}$	1098.839	$\frac{5}{8}$	2166.676	$\frac{5}{8}$	3767.763
$\frac{3}{4}$	15.843	$\frac{3}{4}$	135.186	$\frac{3}{4}$	466.030	$\frac{3}{4}$	1116.374	$\frac{3}{4}$	2194.218	$\frac{3}{4}$	3807.561
$\frac{7}{8}$	16.898	$\frac{7}{8}$	139.547	$\frac{7}{8}$	475.945	$\frac{7}{8}$	1134.094	$\frac{7}{8}$	2221.992	$\frac{7}{8}$	3847.641
6	18.000	12	144.000	18	486.000	24	1152.000	30	2250.000	36	3888.000

CARNEGIE STEEL COMPANY

HOLLOW ROUND SECTIONS

AREAS AND RADII OF GYRATION



$$\text{Area} = \frac{\pi(D^2 - d^2)}{4} = 0.7854 (D^2 - d^2) \text{ sq. in.}$$

$$\text{Radius of gyration} = \frac{\sqrt{D^2 + d^2}}{4} \text{ in.}$$

Dia. D, Inches	Elements	Thickness in Inches																	
		¼	⅜	½	⅝	¾	⅞	1	1⅛	1¼	1⅝	1¾	1⅞	2	2¼	2½	2¾	3	
2	A	1.37	1.66																
	r	0.63	0.61																
3	A	2.16	2.64																
	r	0.98	0.96																
4	A	2.95	3.62	4.27	5.50														
	r	1.33	1.31	1.29	1.25														
5	A	3.73	4.60	5.45	7.07	8.59	10.01												
	r	1.68	1.66	1.64	1.60	1.58	1.53												
6	A	4.52	5.58	6.63	8.64	10.55	12.37	14.09	15.71										
	r	2.03	2.01	1.99	1.95	1.91	1.88	1.84	1.80										
7	A	5.30	6.57	7.80	10.21	12.52	14.73	16.84	18.85	20.76	22.58								
	r	2.39	2.37	2.35	2.30	2.27	2.23	2.19	2.15	2.12	2.08								
8	A	6.09	7.55	8.98	11.78	14.48	17.08	19.59	21.99	24.30	26.51	28.62	30.63						
	r	2.74	2.72	2.70	2.66	2.62	2.58	2.54	2.50	2.46	2.43	2.39	2.36						
9	A	6.87	8.53	10.16	13.35	16.44	19.44	22.33	25.13	27.83	30.43	32.94	35.34	37.65	39.86				
	r	3.09	3.07	3.05	3.01	2.97	2.93	2.89	2.85	2.81	2.78	2.74	2.70	2.67	2.64				
10	A	7.66	9.51	11.34	14.92	18.41	21.79	25.08	28.27	31.37	34.36	37.26	40.06	42.76	45.36	47.86	50.27		
	r	3.45	3.43	3.41	3.36	3.32	3.28	3.24	3.20	3.16	3.13	3.09	3.05	3.02	2.98	2.95	2.92		
11	A	8.44	10.49	12.52	16.49	20.37	24.15	27.83	31.42	34.90	38.29	41.58	44.77	47.86	50.85	53.76	56.55		
	r	3.80	3.78	3.76	3.72	3.67	3.63	3.59	3.55	3.51	3.48	3.44	3.40	3.36	3.33	3.29	3.26		
12	A	9.23	11.47	13.70	18.06	22.33	26.51	30.58	34.56	38.44	42.22	45.90	49.48	52.97	56.35	59.64	62.83		
	r	4.16	4.13	4.11	4.07	4.03	3.99	3.95	3.91	3.87	3.83	3.79	3.75	3.71	3.68	3.64	3.61		
13	A	10.01	12.46	14.87	19.63	24.30	28.86	33.33	37.70	41.97	46.14	50.22	54.19	58.07	61.85	65.53	69.12		
	r	4.51	4.49	4.47	4.42	4.38	4.34	4.30	4.26	4.22	4.18	4.14	4.10	4.06	4.03	3.99	3.95		
14	A	10.80	13.44	16.05	21.21	26.26	31.22	36.08	40.84	45.50	50.07	54.54	58.91	63.18	67.35	71.42	75.40		
	r	4.86	4.84	4.82	4.78	4.73	4.69	4.65	4.61	4.57	4.53	4.49	4.45	4.41	4.38	4.34	4.30		
15	A	11.58	14.42	17.23	22.78	28.23	33.58	38.83	43.98	49.04	54.00	58.86	63.62	68.28	72.85	77.31	81.68		
	r	5.22	5.19	5.17	5.13	5.09	5.05	5.00	4.96	4.92	4.88	4.84	4.80	4.76	4.73	4.69	4.65		
16	A	12.37	15.40	18.41	24.35	30.19	35.93	41.58	47.12	52.57	57.92	63.18	68.33	73.39	78.34	83.20	87.97		
	r	5.57	5.55	5.53	5.48	5.44	5.40	5.36	5.32	5.27	5.23	5.19	5.15	5.11	5.08	5.04	5.00		
17	A	13.16	16.38	19.59	25.92	32.15	38.29	44.33	50.27	56.11	61.85	67.50	73.04	78.49	83.84	89.09	94.25		
	r	5.92	5.90	5.88	5.84	5.79	5.75	5.71	5.67	5.63	5.59	5.55	5.51	5.47	5.43	5.39	5.35		
18	A	13.94	17.36	20.76	27.49	34.12	40.64	47.07	53.41	59.64	65.78	71.82	77.75	83.60	89.34	94.96	100.53		
	r	6.28	6.25	6.23	6.19	6.15	6.10	6.06	6.02	5.98	5.94	5.90	5.86	5.82	5.78	5.74	5.70		
19	A	14.73	18.35	21.94	29.06	36.08	43.00	49.82	56.55	63.18	69.70	76.13	82.47	88.70	94.84	100.87	106.82		
	r	6.63	6.61	6.59	6.54	6.50	6.46	6.42	6.37	6.33	6.29	6.25	6.21	6.17	6.13	6.09	6.05		
20	A	15.51	19.33	23.12	30.63	38.04	45.36	52.57	59.69	66.71	73.63	80.45	87.18	93.81	100.33	106.77	113.10		
	r	6.98	6.96	6.94	6.90	6.85	6.81	6.77	6.73	6.69	6.64	6.60	6.56	6.52	6.48	6.44	6.40		

ELEMENTS OF SECTIONS

HOLLOW SQUARE SECTIONS

AREAS AND RADII OF GYRATION

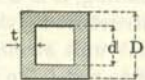

Area = $D^2 - d^2$ sq. in.

Radius of gyration = $\sqrt{\frac{D^2 + d^2}{12}}$ in.

Side D, Inches	Elements	Thickness, t, Inches																	
		¼	⅜	½	¾	1	1 ¼	1 ½	1 ¾	2	2 ¼	2 ½	2 ¾	3	3 ¼	3 ½	3 ¾	4	
2	A	1.75	2.11																
	r	.72	.70																
3	A	2.75	3.38																
	r	1.13	1.10																
4	A	3.75	4.61	5.44	7.00														
	r	1.53	1.51	1.49	1.44														
5	A	4.75	5.86	6.94	9.00	10.94	12.75												
	r	1.94	1.92	1.89	1.85	1.80	1.76												
6	A	5.75	7.11	8.44	11.00	13.44	15.75	17.94	20.00										
	r	2.35	2.33	2.30	2.25	2.21	2.17	2.12	2.08										
7	A	6.75	8.38	9.94	13.00	15.94	18.75	21.44	24.00	26.44	28.75								
	r	2.76	2.73	2.71	2.66	2.62	2.57	2.53	2.48	2.44	2.40								
8	A	7.75	9.61	11.44	15.00	18.44	21.75	24.94	28.00	30.94	33.75	36.44	39.00						
	r	3.17	3.14	3.12	3.07	3.02	2.98	2.93	2.89	2.84	2.80	2.76	2.72						
9	A	8.75	10.86	12.94	17.00	20.94	24.75	28.44	32.00	35.44	38.75	41.94	45.00	47.94	50.75				
	r	3.57	3.55	3.53	3.48	3.43	3.38	3.34	3.29	3.25	3.20	3.16	3.12	3.08	3.05				
10	A	9.75	12.11	14.44	19.00	23.44	27.75	31.94	36.00	39.94	43.75	47.44	51.00	54.44	57.75	60.94	64.00		
	r	3.98	3.96	3.93	3.88	3.84	3.79	3.74	3.70	3.65	3.61	3.57	3.52	3.48	3.44	3.40	3.37		
11	A	10.75	13.36	15.94	21.00	25.94	30.75	35.44	40.00	44.44	48.75	52.94	57.00	60.94	64.75	68.44	72.00		
	r	4.39	4.37	4.34	4.29	4.24	4.20	4.15	4.10	4.06	4.01	3.97	3.93	3.88	3.84	3.80	3.76		
12	A	11.75	14.61	17.44	23.00	28.44	33.75	38.94	44.00	48.94	53.75	58.44	63.00	67.44	71.75	75.94	80.00		
	r	4.80	4.77	4.75	4.70	4.65	4.60	4.56	4.51	4.46	4.42	4.37	4.33	4.29	4.25	4.20	4.16		
13	A	12.75	15.86	18.94	25.00	30.94	36.75	42.44	48.00	53.44	58.75	63.94	69.00	73.94	78.75	83.44	88.00		
	r	5.21	5.18	5.16	5.11	5.06	5.01	4.96	4.92	4.87	4.82	4.78	4.74	4.69	4.65	4.61	4.56		
14	A	13.75	17.11	20.44	27.00	33.44	39.75	45.94	52.00	57.94	63.75	69.44	75.00	80.44	85.75	90.94	96.00		
	r	5.61	5.59	5.56	5.51	5.47	5.42	5.37	5.32	5.28	5.23	5.18	5.14	5.10	5.05	5.01	4.97		
15	A	14.75	18.36	21.94	29.00	35.94	42.75	49.44	56.00	62.44	68.75	74.94	81.00	86.94	92.75	98.44	104.00		
	r	6.02	6.00	5.97	5.92	5.87	5.83	5.78	5.73	5.68	5.64	5.59	5.55	5.50	5.46	5.41	5.37		
16	A	15.75	19.61	23.44	31.00	38.44	45.75	52.94	60.00	66.94	73.75	80.44	87.00	93.44	99.75	105.94	112.00		
	r	6.43	6.41	6.38	6.33	6.28	6.23	6.19	6.14	6.09	6.04	6.00	5.95	5.91	5.86	5.82	5.77		
17	A	16.75	20.86	24.94	33.00	40.94	48.75	56.44	64.00	71.44	78.75	85.94	93.00	99.94	106.75	113.44	120.00		
	r	6.84	6.81	6.79	6.74	6.69	6.64	6.59	6.54	6.50	6.45	6.40	6.36	6.31	6.27	6.23	6.18		
18	A	17.75	22.11	26.44	35.00	43.44	51.75	59.94	68.00	75.94	83.75	91.44	99.00	106.44	113.75	120.94	128.00		
	r	7.25	7.22	7.20	7.15	7.10	7.05	7.00	6.95	6.90	6.86	6.81	6.76	6.72	6.67	6.63	6.58		
19	A	18.75	23.36	27.94	37.00	45.94	54.75	63.44	72.00	80.44	88.75	96.94	105.00	112.94	120.75	128.44	136.00		
	r	7.66	7.63	7.61	7.56	7.51	7.46	7.41	7.36	7.31	7.26	7.22	7.17	7.12	7.08	7.03	6.99		
20	A	19.75	24.61	29.44	39.00	48.44	57.75	66.94	76.00	84.94	93.75	102.44	111.00	119.44	127.75	135.94	144.00		
	r	8.06	8.04	8.01	7.96	7.91	7.87	7.82	7.77	7.72	7.67	7.62	7.58	7.53	7.49	7.44	7.39		

STRESSES IN BEAMS

In the application of the principles of structural mechanics to determine what sections should be used safely to sustain superimposed loads under specified conditions of loading, it is necessary to ascertain, first, the effects produced on the structure by the loads under those conditions; second, to decide what unit strength the material, the use of which is contemplated, has to resist the stresses produced within the structure by the loading; and, third, to select a section whose section modulus is equivalent to the ratio found to exist between the stresses tending to cause deformation within the structure and the unit strength of the material to resist them.

Reactions. In the simple case of a beam supported at both ends, each support reacts with an upward pressure called the reaction of the support. The sum of these two reactions is equal to the total load on the beam.

Shear. The loads and the reactions of the supports are vertical forces tending to shear or cut the beam across and the stresses they produce within the beam are, therefore, called shearing stresses. The shear at each support is equal to the reaction of the support; the shear at any point between the supports is equal to the reaction of a support less the total load between that support and the point; or, if the reaction acting upward is considered as positive and the loads, acting downwards, as negative, the shear at any point is the algebraic sum of the vertical forces acting on the beam between that point and either support.

If such a simple beam supported at both ends carries a load uniformly distributed over its entire length, the reaction and the shear at each support is equal to one-half the total load on the beam, but the shear decreases uniformly to zero at the center of the span; if the load is concentrated at the center of the span, the reaction and the shear at each support are also equal to one-half the total load, but the shear is uniform throughout the entire length of the beam.

Bending Moment. The loads on the beam and the reactions of the supports constitute external forces which produce bending stress in the beam. The summation of the moments of the external forces about any point is called the bending moment and varies from point to point. It attains a maximum value at a point where the shear is either zero or changes from positive to negative or vice versa. If the loads are concentrated at several points, the maximum bending moment always occurs at the point of application of

one of the loads so located that the sum of all the loads on the beam between one support up to and including that load is equal to or greater than the reaction of the support.

Vertical Deflection. Bending stress within a beam produces flexure, and the deflection, or the amount of its departure from a straight line, is the measure of the deformation which the beam has undergone in its resistance to bending stress. So long as the stress is within the safe limits allowed for the material, the deflection is negligible so far as concerns the beam itself; it may, however, be of sufficient magnitude to cause the disruption of other materials in contact with or supported by the beam but of less strength, such as plaster. In such cases the limit of allowable deflection may determine or at least influence the choice of a section.

Lateral Deflection. The stresses within a beam under transverse loading are compressive on one side of the neutral axis and tensile on the other. The tensile stresses tend to hold the beam in a straight line between the supports, while the compressive stresses tend to deflect it in a lateral direction, just as the bending stresses as a whole tend to deflect it in a vertical plane. On long spans unsupported against sidewise deflection, this consideration may influence the choice of sections.

Method of Computation. A complete investigation of the strength of beams under transverse loading must take into account all the elements, the bending moment, the vertical deflection, the lateral deflection and the shearing stress; though under the usual loading conditions the first alone determines the size and weight of section.

In the calculation of bending stresses, the loads are usually expressed in pounds, the span length and the distance between the loads in feet; the resulting bending moments are in terms of foot pounds, which necessitates conversion to inch pounds before the section can be selected from the tables. The section modulus of the required section is obtained by dividing the maximum bending moment in inch pounds by the allowed fiber stress in pounds per square inch. In such calculations it is assumed that the neutral axis of the section is normal to the line of action of the load. When this is not the case, correction must be made for the eccentricity of the loading.

In the pages which immediately follow are given general formulas for the bending moments and vertical deflections of beams under the usual conditions of loading, and also diagrams illustrative of those conditions. The general method for the computation of the maximum bending moment of a beam supported at its ends and loaded at various points is as follows:—

First. Find the reaction at the left (right) support by multiplying each load by its distance from the right (left) support and dividing the sum of these products by the length of the span.

Second. Starting from the left (right) end of the beam, add the successive loads until a point is reached where the sum of the loads equals or exceeds the reaction of the left (right) support; the point of maximum bending moment is located at this point.

Third. Multiply the reaction at the left (right) support by its distance from the point of maximum bending moment and subtract the sum of the products of all loads to the left (right) of this point by the corresponding distance from this point; the difference between these moments is then the maximum bending moment.

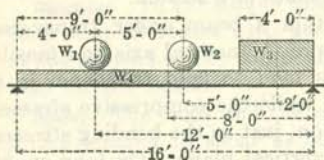

Example: Required the size of a steel beam to support the following quiescent loads over a clear span of 16 feet between supports, at a maximum fiber stress not to exceed 16000 pounds per square inch.

- $W_1 = 16000$ pounds, 4 feet from left support.
- $W_2 = 18000$ " " " " " "
- $W_3 = 2000$ " " per foot, uniform up to 4 feet from right support.
- $W_4 = 60$ " " " " assumed weight of beam uniformly distributed over entire span.

Left Reaction, $\frac{16000 \times 12 + (60 \times 16)8 + 18000 \times 7 + (2000 \times 4) \times 2}{16} = 21355$ lbs.

Right Reaction, $\frac{16000 \times 4 + (60 \times 16)8 + 18000 \times 9 + (2000 \times 4) \times 14}{16} = 21605$ lbs.

Sum of reactions = sum of loads = $W_1 + W_2 + W_3 + W_4 = 42960$ lbs.

Points of maximum moment $(60 \times 4) + 16000 = 16240 < 21355$

$(60 \times 9) + 16000 + 18000 = 34540 > 21355$

therefore the point of maximum bending moment is at point of load W_2 .

Maximum bending moment, $21355 \times 9 - 16000 \times 5 - (60 \times 9) \times 4.5 = 109765$ ft. lbs.

or, $21605 \times 7 - (2000 \times 4) \times 5 - (60 \times 7) \times 3.5 = 109765$ ft. lbs.

Required section modulus = $\frac{109765 \times 12}{16000} = \frac{1317180}{16000} = 82.4$

As the section modulus of the 15 inch 65 pound or the 18 inch 54.7 pound beam is greater than this, either of these sections may be used. If it is decided that the 18 inch 48.2 pound supplementary beam is strong enough for the purpose, the actual fiber stress on that section would be $\frac{1317180}{81.9} = 16082$ pounds per square inch. If the allowed fiber stress were 12500 pounds per square inch, the required section modulus would be $\frac{109765 \times 12}{12500} = \frac{1317180}{12500} = 105.38$ and the permissible minimum sections would be 20 inch 65.4 pound, 21 inch 60.4 pound beams, etc.

NOTATION USED IN FORMULAS

- A** =Area of section, in square inches.
n =Distance from center line of gravity to extreme fiber, in inches.
I =Moment of inertia about center line of gravity, in inches⁴.
M_s =Static moment, in inches³.
S =Section modulus= I/n , in inches³.
r =Radius of gyration= $\sqrt{I/A}$, in inches.
f =Bending stress in extreme fiber, in pounds per square inch.
f_b =Resistance of web, in pounds per square inch.
E =Modulus of elasticity, in pounds per square inch.
L =Length of section, in feet.
l =Length of section, in inches.
d =Depth of section, in inches.
b =Width of section, in inches.
t =Thickness of section, in inches.
W, W₁, W₂ =Superimposed loads supported by beam, in pounds.
w =Superimposed load, in pounds per unit length or area.
W max =Maximum safe load at point given, in pounds.
R, R₁ =Reactions at points of support, in pounds.
V =Vertical shear, in pounds.
M, M₁, M₂ =Bending moments at points given, in inch pounds.
M max =Maximum bending moment, in inch pounds.
M_r =Maximum resisting moment, in inch pounds= $f I/n = f S$.
D, D₁ =Deflections at points given, in inches.
D max =Maximum deflection at point given, in inches.

COMPARISON OF VARIOUS LOADING CONDITIONS

The formulas and diagrams on pages 143 to 146 give the various stresses in sections used as beams, resulting from usual conditions of loading.

Taking as a unit of comparison a uniformly distributed safe load on beams of equal length and section, supported at the extreme ends, the following table gives the relative maximum safe loads or bending moments and deflections.

As a check on the accuracy of a computation, the safe load obtained from the formula for any condition of loading may be multiplied by the reciprocal given in the table corresponding to such loading condition; the result should be the maximum allowable uniform load as taken from beam safe load tables.

Conditions of Loading	Case No.	Maximum Safe Load		Maximum Deflection
		Relative	Reciprocal	Relative
BEAM SUPPORTED AT ENDS				
Load uniformly distributed over span	IX	1	1	1
Load concentrated at center of span	V	$\frac{1}{2}$	2	.80
Two equal loads symmetrically concentrated	VII	$\frac{1}{4a}$	$\frac{4a}{1}$	
Load increasing uniformly to one end	X	.9743	1.0264	.976
Load increasing uniformly to center	XII	$\frac{3}{4}$	$1\frac{1}{2}$.96
Load decreasing uniformly to center	XI	$\frac{3}{8}$	$\frac{8}{3}$	1.08
BEAM FIXED AT ONE END, CANTILEVER				
Load uniformly distributed over span	II	$\frac{1}{4}$	4	2.40
Load concentrated at end	I	$\frac{1}{8}$	8	3.20
Load increasing uniformly to fixed end	III	$\frac{3}{8}$	$2\frac{2}{3}$	1.92
BEAM CONTINUOUS OVER TWO SUPPORTS EQUIDISTANT FROM ENDS				
Load uniformly distributed over span	XVI			
1. If distance $a > 0.2071 l$		$\frac{l^2}{4a^2}$	$\frac{4a^2}{l^2}$	
2. If distance $a < 0.2071 l$		$\frac{1}{1-4a}$	$\frac{1-4a}{1}$	
3. If distance $a = 0.2071 l$		5.8285	.1716	
Two equal loads concentrated at ends	XV	$\frac{1}{4a}$	$\frac{4a}{1}$	

BEAMS UNDER VARIOUS LOADING CONDITIONS
BENDING MOMENTS AND DEFLECTIONS

I. CANTILEVER BEAM—Concentrated load at free end

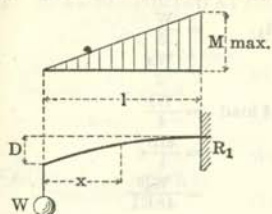

$$\begin{aligned}
 R_1(\text{max. shear}) &= W \\
 M, \text{ distance } x &= Wx \\
 M \text{ max. at } R_1 &= Wl \\
 W \text{ max.} &= \frac{fS}{l} \\
 D \text{ max.} &= \frac{Wl^3}{3EI}
 \end{aligned}$$

II. CANTILEVER BEAM—Uniformly distributed load

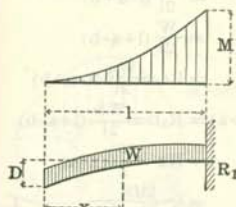

$$\begin{aligned}
 R_1(\text{max. shear}) &= W \\
 M, \text{ distance } x &= \frac{Wx^2}{2l} \\
 M \text{ max. at } R_1 &= \frac{Wl^2}{2} \\
 W \text{ max.} &= \frac{2fS}{l} \\
 D \text{ max.} &= \frac{Wl^3}{8EI}
 \end{aligned}$$

III. CANTILEVER BEAM—Load increasing uniformly to fixed end

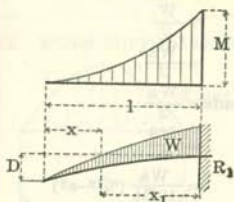

$$\begin{aligned}
 R_1(\text{max. shear}) &= W \\
 M, \text{ distance } x &= \frac{W}{3} \frac{x^3}{l^2} \\
 M \text{ max. at } R_1 &= \frac{Wl^3}{3} \\
 W \text{ max.} &= \frac{3fS}{l} \\
 D \text{ max.} &= \frac{Wl^3}{15EI}
 \end{aligned}$$

IV. BEAM SUPPORTED AT ENDS—Concentrated load near one end

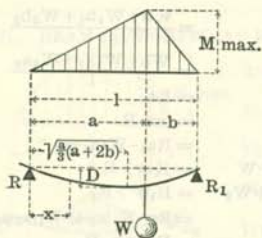

$$\begin{aligned}
 R(\text{max. shear if } b > a) &= \frac{Wb}{l} \\
 R_1(\text{max. shear if } a > b) &= \frac{Wa}{l} \\
 M, \text{ distance } x &= \frac{Wbx}{l} \\
 M \text{ max., at point of load} &= \frac{Wab}{l} \\
 W \text{ max.} &= \frac{fSl}{ab} \\
 D \text{ max.} &= \frac{Wab(a+2b)\sqrt{3a(a+2b)}}{27EI}
 \end{aligned}$$

BEAMS UNDER VARIOUS LOADING CONDITIONS
BENDING MOMENTS AND DEFLECTIONS

V. BEAM SUPPORTED AT ENDS—Concentrated load at center

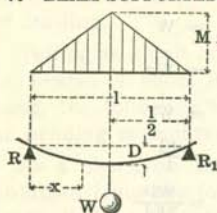

$$\begin{aligned}
 M_{\max.} \quad R \text{ (max. shear)} &= R_1 = \frac{W}{2} \\
 M, \text{ distance } x &= \frac{Wx}{2} \\
 M_{\max.}, \text{ at point of load} &= \frac{Wl}{4} \\
 W_{\max.} &= \frac{4fS}{l} \\
 D_{\max.} &= \frac{Wl^3}{48EI}
 \end{aligned}$$

VI. BEAM SUPPORTED AT ENDS—Two unsymmetrical concentrated loads

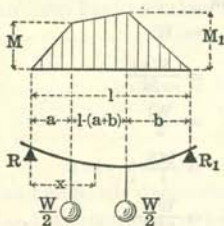

$$\begin{aligned}
 R \text{ (max. shear if } a < b) &= \frac{W}{2l}(l-a+b) \\
 R_1 &= \frac{W}{2l}(l+a-b) \\
 M, \text{ distance } a &= Ra = \frac{Wa}{2l}(l-a+b) \\
 M_1 \text{ max., distance } b \text{ (} b > a) &= R_1b = \frac{Wb}{2l}(l+a-b) \\
 M_2, \text{ distance } x &= Rx - \frac{W}{2}(x-a) \\
 W_{\max.} \text{ (} b > a) &= \frac{2fS}{b(l+a-b)}
 \end{aligned}$$

VII. BEAM SUPPORTED AT ENDS—Two symmetrical concentrated loads

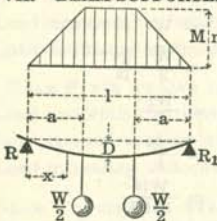

$$\begin{aligned}
 R \text{ (max. shear)} &= R_1 = \frac{W}{2} \\
 M, \text{ distance } x &= \frac{Wx}{2} \\
 M_{\max.} \text{ at and between loads} &= \frac{Wa}{2} \\
 W_{\max.} &= \frac{2fS}{a} \\
 D_{\max.} &= \frac{Wa}{12EI}(\%l^2 - a^2)
 \end{aligned}$$

VIII. BEAM SUPPORTED AT ENDS—Three concentrated loads

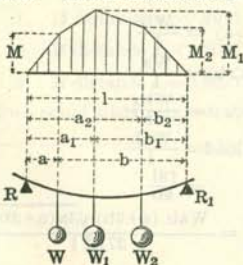

$$\begin{aligned}
 R &= \frac{Wb + W_1b_1 + W_2b_2}{l} \\
 R_1 &= \frac{Wa + W_1a_1 + W_2a_2}{l} \\
 M \text{ at } W &= Ra \\
 M_{\max.} \text{ if } W &= \text{or } > R \\
 M \text{ at } W_1 &= Ra_1 - W(a_1 - a) \\
 M_{\max.} \text{ if } W_1 + W &= R \text{ or } > R \\
 M_{\max.} \text{ if } W_1 + W_2 &= R_1 \text{ or } > R_1 \\
 M \text{ at } W_2 &= Ra_2 - W(a_2 - a) - W_1(a_2 - a_1) \\
 M_{\max.} \text{ if } W_2 &= R_1 \text{ or } > R_1
 \end{aligned}$$

BEAMS UNDER VARIOUS LOADING CONDITIONS

BENDING MOMENTS AND DEFLECTIONS

IX. BEAM SUPPORTED AT ENDS—Uniformly distributed load

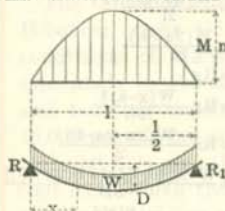

$$\begin{aligned}
 R(\text{max. shear}) &= R_1 = \frac{W}{2} \\
 M, \text{ distance } x &= \frac{Wx}{2} \left(1 - \frac{x}{l}\right) \\
 M \text{ max. at center} &= \frac{Wl^2}{8} \\
 W \text{ max.} &= \frac{8fs}{l} \\
 D \text{ max.} &= \frac{5Wl^3}{384EI}
 \end{aligned}$$

X. BEAM SUPPORTED AT ENDS—Load increasing uniformly to one end

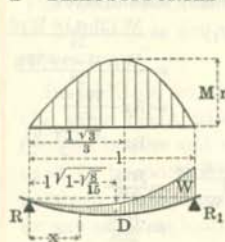

$$\begin{aligned}
 R &= \frac{W}{3} \\
 R_1(\text{max. shear}) &= \frac{2W}{3} \\
 M, \text{ distance } x &= \frac{Wx}{3} \left(1 - \frac{x^2}{l^2}\right) \\
 M \text{ max., distance } \frac{l\sqrt{3}}{3} &= \frac{2Wl}{9\sqrt{3}} \\
 W \text{ max.} &= \frac{27fs}{21\sqrt{3}} \\
 D \text{ max.} &= \frac{.013044 Wl^3}{EI}
 \end{aligned}$$

XI. BEAM SUPPORTED AT ENDS—Load decreasing uniformly to center

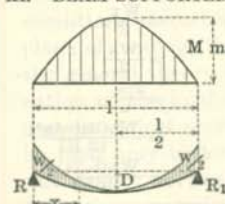

$$\begin{aligned}
 R(\text{max. shear}) &= R_1 = \frac{W}{2} \\
 M, \text{ distance } x &= Wx \left(\frac{1}{2} - \frac{x}{l} + \frac{2x^2}{3l^2}\right) \\
 M \text{ max., distance } \frac{l}{2} &= \frac{Wl}{12} \\
 W \text{ max.} &= \frac{12fs}{l} \\
 D \text{ max.} &= \frac{3Wl^3}{320EI}
 \end{aligned}$$

XII. BEAM SUPPORTED AT ENDS—Load increasing uniformly to center

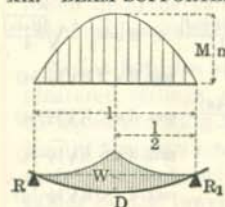

$$\begin{aligned}
 R(\text{max. shear}) &= R_1 = \frac{W}{2} \\
 M, \text{ distance } x &= Wx \left(\frac{1}{2} - \frac{2x^2}{3l^2}\right) \\
 M \text{ max., distance } \frac{l}{2} &= \frac{Wl}{6} \\
 W \text{ max.} &= \frac{6fs}{l} \\
 D \text{ max.} &= \frac{Wl^3}{60EI}
 \end{aligned}$$

BEAMS UNDER VARIOUS LOADING CONDITIONS

BENDING MOMENTS AND DEFLECTIONS—Concluded

XIII. BEAM SUPPORTED AT ENDS—Uniform load partially distributed

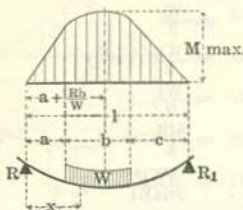

$$R \text{ (max. shear if } a < c) = \frac{W(2c+b)}{2l}$$

$$R_1 = \frac{W(2a+b)}{2l}$$

$$M, \text{ dist. } x = a \text{ or } < a, = Rx$$

$$M_1 \text{ dist. } x > a, = Rx - \frac{W(x-a)^2}{2b}$$

$$M_2, \text{ dist. } x > (a+b), = Rx - \frac{W(2x-2a-b)}{2}$$

$$M \text{ max., dist. } a + \frac{Rb}{W}, = \frac{W(2c+b)[4al+b(2c+b)]}{8l^2}$$

$$W \text{ max.} = \frac{8l^2 f S}{(2c+b)[4al+b(2c+b)]}$$

XIV. BEAM SUPPORTED AT ENDS—Uniform load partially discontinuous

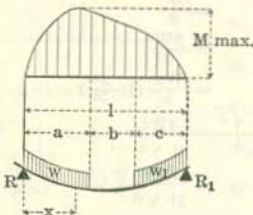

$$R \text{ (max. shear if } W > W_1) = \frac{W(2l-a) + W_1 c}{2l}$$

$$R_1 = \frac{W_1(2l-c) + Wa}{2l}$$

$$M, \text{ distance } x < a, = Rx - \frac{Wx^2}{2a}$$

$$M_1 \text{ distance } x > a, = Rx - \frac{W(2x-a)}{2}$$

$$M \text{ max. dist. } x = \frac{2Wal - Wa^2 + W_1 ca}{2Wl} \text{ \& } Wa > W_1 c = \frac{R^2 a}{2W}$$

$$W \text{ max.} = \frac{R^2 a}{2f S}$$

XV. BEAM CONTINUOUS OVER TWO SUPPORTS—Two exterior symmetrical loads

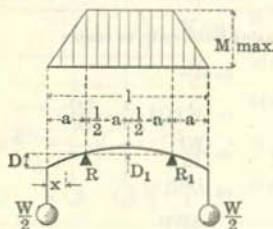

$$R \text{ (max. shear)} = R_1 = \frac{W}{2}$$

$$M, \text{ distance } x = \frac{Wx}{2}$$

$$M \text{ max., from } R \text{ to } R_1 = \frac{Wa}{2}$$

$$W \text{ max.} = \frac{2f S}{a}$$

$$D, \text{ distance } a = \frac{Wa(3al - 4a^2)}{12EI}$$

$$D_1, \text{ distance } \frac{1}{2}a = \frac{Wa(1-2a)^2}{16EI}$$

XVI. BEAM CONTINUOUS OVER TWO SUPPORTS—Uniformly distributed load

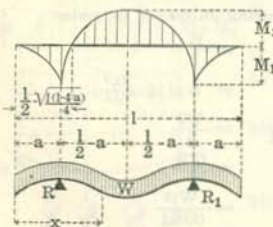

$$R = R_1 = \frac{W}{2}, \text{ max. shear } \frac{Wa}{l} \text{ or } \frac{W}{l} \left(\frac{1}{2} - a \right)$$

$$M, \text{ distance } x = \frac{W(x^2 - lx + al)}{2l} \text{ o, if } x = \frac{l}{2} + \sqrt{\frac{l(1-4a)}{4}}$$

$$M_1 \text{ at } R \text{ and } R_1 = \frac{Wa^2}{2l} \text{ max. if } a > l(\sqrt{\frac{1}{4}} - \frac{1}{2})$$

$$M_2 \text{ at center} = \frac{W(l-4a)}{8} \text{ max. if } a < l(\sqrt{\frac{1}{4}} - \frac{1}{2})$$

$$W_1 \text{ max.} = \frac{2f S}{a^2} \text{ max. if } a > l(\sqrt{\frac{1}{4}} - \frac{1}{2})$$

$$W_2 \text{ max.} = \frac{8f S}{1-4a} \text{ max. if } a < l(\sqrt{\frac{1}{4}} - \frac{1}{2})$$

SAFE LOADS FOR SECTIONS USED AS BEAMS

EXPLANATION OF TABLES

The tables of safe loads for structural and supplementary beams, H-beams, cross tie sections and channels, used as beams under conditions of transverse loading, give the uniformly distributed safe loads in thousands of pounds for spans customary in bridge and building construction based upon an extreme fiber stress of 16,000 pounds per square inch. The tables of safe loads for angles, tees and zees give the values at the same fiber stress on spans of one foot from which the safe load for any span length may be obtained by direct division and also the values for those spans at which the allowed safe load will produce a deflection of $\frac{1}{360}$ of the span length. The loads in all cases include the weight of the section, which should be deducted in order to arrive at the net load which the section will support.

In addition to these usual tables of safe loads, there follow, on the same basis, tables of the allowable uniform load in pounds per foot on beams and channels for various span lengths, which may be used in proportioning the floor systems of buildings. The choice between various weights and depths of sections for any given span or any uniform load per running foot may be made on inspection.

It is assumed in all cases that the loads are applied normal to the axis 1-1 as shown in the tables of elements of sections, and that the beam deflects vertically in the plane of bending only. If the conditions of loading involve the introduction of forces outside this plane of loading, the allowable safe loads must be determined from the general theory of flexure in accordance with the mode of application of the load and its character. This applies particularly to unsymmetrical sections, such as zee bars and angles, which should be used only under those conditions of loading where the section can deflect vertically only, being rigidly secured against lateral deflection or twisting throughout the entire span. In all such cases of eccentric loading, the actual safe loads would be considerably lower than the tabulated safe loads which have been based upon the most favorable conditions of loading.

Vertical Deflection of Beams. In the case of beams intended to carry plastered ceilings, experience indicates that the vertical deflection to avoid cracking the plaster should be limited to not more than $\frac{1}{360}$ of the span length. This span limit for steel beams is approximately in feet twice the depth in inches and is indicated in the tables by the lower zigzag line. Beams intended for such purposes

CARNEGIE STEEL COMPANY

should not be used for greater spans unless the allowable tabular safe loads exceeds the actual load to be supported. As the dead load of the floor is supported by the beams before the plaster is applied, only the deflection due to the live load really needs to be considered.

The coefficients given below may be used to obtain the deflection, in inches, of sections subjected to transverse stresses due to uniformly distributed loads at various fiber stresses and are based upon the following formulas, using the notation given on page 141,

$$\text{Deflection, } D = \frac{Wl^3}{76.8EI}, \text{ when } Wl = \frac{8fI}{n} \text{ or } D = \frac{8fI^2}{76.8En} = \frac{15fL^2}{E} \times \frac{1}{n}$$

$$\text{For symmetrical sections, } n = \frac{d}{2}, D = \frac{30fL^2}{E} \times \frac{1}{d} = \frac{\text{Coefficient}}{\text{depth in inches}}$$

COEFFICIENTS OF DEFLECTION UNIFORMLY DISTRIBUTED LOADS

Span, Feet	Fibre Stress, Pounds per Square Inch			Span, Feet	Fibre Stress, Pounds per Square Inch		
	16000	14000	12500		16000	14000	12500
1	0.017	0.014	0.013	26	11.189	9.790	8.741
2	0.066	0.058	0.052	27	12.066	10.558	9.427
3	0.149	0.130	0.116	28	12.977	11.354	10.138
4	0.265	0.232	0.207	29	13.920	12.180	10.875
5	0.414	0.362	0.323	30	14.897	13.034	11.638
6	0.596	0.521	0.466	31	15.906	13.918	12.427
7	0.811	0.710	0.634	32	16.949	14.830	13.241
8	1.059	0.927	0.828	33	18.025	15.772	14.082
9	1.341	1.173	1.047	34	19.134	16.742	14.948
10	1.655	1.448	1.293	35	20.276	17.741	15.841
11	2.003	1.752	1.565	36	21.451	18.770	16.759
12	2.383	2.086	1.862	37	22.659	19.827	17.703
13	2.797	2.448	2.185	38	23.901	20.913	18.672
14	3.244	2.839	2.534	39	25.175	22.028	19.668
15	3.724	3.259	2.909	40	26.483	23.172	20.690
16	4.237	3.708	3.310	41	27.823	24.346	21.737
17	4.783	4.186	3.737	42	29.197	25.548	22.810
18	5.363	4.692	4.190	43	30.604	26.779	23.909
19	5.975	5.228	4.668	44	32.044	28.039	25.034
20	6.621	5.793	5.172	45	33.517	29.328	26.185
21	7.299	6.387	5.703	46	35.023	30.646	27.362
22	8.011	7.010	6.259	47	36.562	31.992	28.565
23	8.756	7.661	6.841	48	38.135	33.368	29.793
24	9.534	8.342	7.448	49	39.741	34.773	31.047
25	10.345	9.052	8.082	50	41.379	36.207	32.328

To find the deflection in inches of a section symmetrical about the neutral axis, such as beams, channels, zeos, etc., divide the coefficient in the table corresponding to given span and fiber stress by the depth of the section in inches.

To find the deflection in inches of a section not symmetrical about the neutral axis, such as angles, tees, etc., divide the coefficient corresponding to given span and fiber stress by twice the distance of extreme fiber from neutral axis obtained from table of elements of sections, pages 110 to 130, inclusive.

To find the deflection in inches of a section for any other fiber stress than those given, multiply this fiber stress by any of the coefficients in the table for the given span and divide by the fiber stress corresponding to the coefficient used.

Lateral Deflection of Beams. The tabular safe loads are based on the assumption that the compression flanges of the various sections are secured against lateral deflection by the use of tie rods or by other means at proper intervals. According to the Construction Specifications, page 96, the lateral unbraced length of beams and girders should not exceed forty times the width of the compression flanges. Full tabular loads may be used up to a span length equal to ten times the flange width, but when the unbraced length exceeds ten times the width, the tabular safe loads should be reduced in accordance with the ratios given in the following table in order to insure that the stresses in the compression flanges should not exceed the allowed unit stresses, derived from formula: $19000 - 300 l/b$, as follows:—

Unbraced Span, l, inches	Percent of Tabular Load	Unbraced Span, l, inches	Percent of Tabular Load	Unbraced Span, l, inches	Percent of Tabular Load
15 x Flange, b	90.63 %	25 x Flange, b	71.87 %	35 x Flange, b	53.13 %
20 x " "	81.25 %	30 x " "	62.50 %	40 x " "	43.75 %

In addition to this lateral deflection which is induced within the beam by the action of pure bending stresses, lateral deflection may be induced by the thrust of floor arches or other loading acting on an axis perpendicular to the line of principal bending stress. The thrust of these arches should either be neutralized by tie rods, or the safe carrying capacity of the beam should be computed in accordance with the general formulas of flexure to provide for the combined stresses due to the action of both vertical and horizontal forces; that is to say, the safe loads should be figured around both the axes 1-1 and 2-2, and the unit stress computed so as not to exceed 16,000 pounds per square inch.

Effect of Impact on Stresses. The formulas upon which the tables of safe loads are based assume all loads to be quiescent or static. The effect of moving loads may be taken care of either by reducing the allowable unit stresses, or else by increasing the theoretical loads. See Construction Specifications, page 94, paragraph 2.

When a load is suddenly applied, the resultant stresses are twice as great than those due an equal quiescent load.

When an instantaneously applied load produces impact or percussion, the resultant stresses are dynamic and are measured by the laws governing the energy of bodies in motion. The following formulas give the fiber stress and deflection due to a load falling on center of a beam rigidly supported at both ends when the weight of beam is negligible as compared with that of falling load, and when no account is taken of the local distortion due to impact or percussion at point of application of load; but when the weight of the beam is a real factor, theoretical formulas do not agree even approximately with observed results and are far less than those indicated by theoretical formulas; this is notably true in proof drop-tests of axes:—Let

W =Weight of falling load, in pounds.

h =Height of fall, in inches.

f =Extreme fiber stress due to static effect of load, W, in pounds per square inch.

f_d =Extreme fiber stress due to impact of load, W, in pounds per square inch.

D =Deflection due to static effect of load, W, in inches.

D_d =Deflection due to impact of load, W, in inches.

$$f_d = f \left(1 + \sqrt{\frac{2h}{D} + 1} \right)$$

$$D_d = D \left(1 + \sqrt{\frac{2h}{D} + 1} \right)$$

Shearing Stresses. The safe load tables for beams and channels are computed solely with reference to safe unit stresses due to flexure, and the safe loads uniformly distributed on the spans given will not produce average shearing stresses in the web greater than the 10,000 pounds per square inch allowed by the Construction Specifications. When, however, beams are loaded with heavy loads concentrated near the supports, or when beams of short span are loaded with uniformly distributed loads to their full carrying capacity as regards flexure, the bending moments may be small in comparison with the reactions at the supports, and the beams may fail along the neutral plane as a result of longitudinal shearing stresses, or may buckle as a result of the combined longitudinal and vertical web stresses. On such spans the safe shearing or buckling strength of the web may limit the carrying capacity of the beam rather than the resistance of the flanges to bending stresses.

Longitudinal Shear. At any point in any section of a beam, the horizontal and vertical components of the web stress are equal to each other and proportional to the vertical shear; their intensities are dependent upon the distance of the point from the neutral axis. In order to determine the intensity of the vertical shearing stress at a given point in a vertical section of the beam, therefore, it is sufficient to find the equal intensity of the horizontal shearing stress at the same point in the horizontal plane.

The longitudinal unit shear is zero at the upper and lower flanges of the beam and a maximum at the neutral plane. It is greatest at the supports and zero where there is no vertical shear.

The intensity of the longitudinal shear at any point in any section is the product of the vertical shear, V , for that section and the statical moment, M_s of the section included between the horizontal plane of shear through that point and the extreme fibers on the same side of the neutral plane divided by the product of the moment of inertia of the beam around the proper axis and the thickness at the plane of shear; or

$$\text{Longitudinal shear per square inch} = \frac{V M_s}{t I}$$

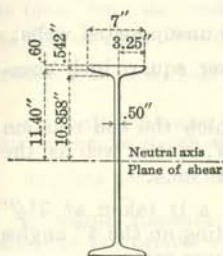

Example—Required the maximum longitudinal shear per square inch in a 24" 79.9 lb. beam loaded with two symmetrical loads of 100,000 pounds each, disregarding the weight of the beam.

M_s of Flange Rectangle	$= 7 \times .60 \times 11.7$	$= 49.14$
M_s of Flange Triangles	$= 3.25 \times .542 \times 11.219$	$= 19.76$
M_s of Web	$= 11.40 \times .50 \times 5.70$	$= 32.49$
Total Static Moment		101.39
Moment of Inertia of Beam I	$= 2087.2$	
Longitudinal Shear	$= \frac{100000 \times 101.39}{2087.2 \times .50}$	
		$= 9715$ pounds per square inch.

Under usual conditions of loading, the longitudinal shear need not be taken into consideration.

Buckling Values of Beam Webs. The vertical shearing stresses or the vertical compressive components of the web stress may under some conditions exceed the safe resistance of the beam to buckling, and there remains the possibility that a web or web plate which is amply secure as against the safe allowed shear of 10,000 pounds per square inch will not be of sufficient strength when considered as a column. In such cases provision must be made for security against buckling either in the way of stiffeners or by increasing the thickness of the web or web plate.

A series of experiments have been carried out on beams of various depths and web thicknesses to arrive at a basis for a simpler method of computation to use in the investigation of the safe buckling resistance of beams with unsupported webs, and from these experiments the following formulas have been deduced:

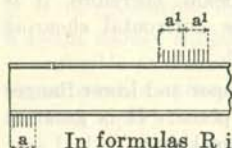

The diagram shows a horizontal beam. At the left end, there is a vertical line representing an end reaction, labeled 'a'. At the right end, there is a vertical line representing a concentrated load, labeled 'a'. Above the beam, there are two vertical lines representing the distribution of the load, each labeled 'a¹'. The distance between these two 'a¹' lines is also labeled 'a¹'.

Safe end reaction $R = f_b \times t \left(a + \frac{d}{4} \right)$

Safe interior load $W = 2 f_b \times t \left(a¹ + \frac{d}{4} \right)$

In formulas R is the end reaction, W the concentrated load, t the web thickness, d the depth of the beam, $a¹$ half the distance over which the concentrated load is applied and a the whole distance over which the end reaction is applied, while f_b is the safe resistance of the web to buckling in pounds per square inch by the formula $19000 - 100 d/2r$ ($d/2 = l$ in column formula) $= 19000 - 173 d/t$.

The first formula is general and applies to any condition of loading. The second formula covers the case of a single load concentrated at the center of a span; it can be extended to cover a system of concentrated loads provided the sum of the distances $a¹$ is not less than a .

The tables give for beams and channels with unsupported webs:

1. Allowed web resistance f_b , in pounds per square inch computed from this compression formula.
2. The distance a , or the distance over which the end reaction must be distributed when the shearing stress, V , in the web is the maximum allowable of 10,000 pounds per square inch.
3. The allowable end reaction (R) when a is taken at $3\frac{1}{2}$ " which is the usual length of beam actually resting on the 4" angles ordinarily used in building construction for beam seats.
4. The allowable shear V , on the gross area of beam or channel webs at 10,000 pounds per square inch.

In addition to these data which have to do with the maximum loads on beams and channels as computed from the web resistance, these tables also give the maximum bending moments in foot pounds, obtained by the multiplication of the section modulus of each section by the allowed fiber stress of 16,000 pounds and the division of the product by 12 in order to reduce to a foot pound basis. These maximum bending moments may be used on inspection instead of the table of properties to ascertain the proper size section to be used in any particular instance.

EXAMPLES OF THE USE OF BEAM SAFE LOAD TABLES

1. **Direct Bending.** Required the proper size of a beam laterally braced to support a superimposed or net load of 30,000 pounds uniformly distributed over a clear span of 20 feet.

From the table of safe loads on page 159, it is found that a 15 inch 42.9 pound beam will support a gross load of 31,400 pounds. The weight of a beam 20 feet long is 858 pounds. The net safe load is, therefore, $31,400 - 858 = 30,542$ pounds. A 15 inch 42.9 pound beam will, therefore, carry the net load specified.

2. **Shear.** Required the maximum load which a 20 inch 85 pound beam can support without exceeding the safe web resistance of the section.

From table on page 158, the maximum load for this section given in small figures above the upper zigzag line is found to be 261,200 pounds.

3. **Vertical Deflection.** Required the proper size and the deflection of a channel supporting a net load of 10,000 pounds concentrated in the middle of a 14-foot span, assuming that the channel is braced against lateral deflection.

The specified load is equivalent on the given span to a uniformly distributed load of $2 \times 10,000 = 20,000$ pounds.

In table on page 167, it is found that a 12 inch 30 pound channel will support a gross load of 20,500 pounds or a net load of $20,500 - 14 \times 30 = 20,080$ pounds. The net safe load concentrated at the middle of the span will be one-half this, or 10,040 pounds.

The deflection produced by a uniformly distributed load of 20,500 pounds is found from the coefficient given in the same table and page 148 to be $\frac{3.24}{12} = 0.270''$. The deflection for the specified load concentrated in the middle of the span, page 142, is approximately $\frac{0.270 \times 4}{5} = 0.216''$.

4. **Vertical Deflection.** Required the deflection of a riveted girder 37 inches deep for a span of 35 feet and a fiber stress of 14,000 pounds.

Required deflection, table on page 148, $= \frac{17.741}{37} = 0.479''$.

5. **Vertical Deflection.** Required the deflection of an angle $6 \times 4 \times \frac{7}{16}''$ about an axis parallel to the short leg for a span of 14 feet and a fiber stress of 16,000 pounds.

Required deflection, pages 148 and 149, is $\frac{3.244}{2 \times (6 - 1.96)} = 0.401''$.

6. **Vertical Deflection.** Required the deflection of a 10 inch beam for a span of 18 feet with a fiber stress of 11,000 pounds.

Required deflection, pages 148 and 149, $= \frac{11,000 \times 5.363}{16,000 \times 10} = 0.369''$.

7. **Lateral Deflection.** Required the reduced safe load on a 12 inch 31.8 pound beam for a span of 16 feet without any lateral support or bracing.

Tabular load, page 160, $= 24,000$ pounds.

Ratio $\frac{\text{Length of span}}{\text{Flange width}} = \frac{16 \times 12}{5} = 38.4$

Reduced safe load, page 149, $24,000 \times 0.468 = 11,232$ pounds.

CARNEGIE STEEL COMPANY

BEAMS

MAXIMUM BENDING MOMENTS AND WEB RESISTANCES

Depth of Beam	Weight per Foot	Thickness of Web	Maximum Bending Moment	Web Resistance			Minimum End Bearing	End Reaction, $a=3\frac{1}{2}''$
				Web Shear	Minimum Span	Web Buckling		
d		t	Mmax	V		f_b	a	R
Inches	Pounds	Inches	Foot Pounds	Pounds	Feet	Pounds per Sq. ft.	Inches	Pounds
27	90.0	.524	292180	141480	8.26	10080	20.04	51120
24	120.0	.798	334530	191520	6.99	13790	11.40	104560
	115.0	.737	326730	176880	7.39	13360	11.96	13550
	110.0	.675	318790	162000	7.87	12840	12.69	82350
	105.9	.625	312390	150000	8.33	12350	13.44	73320
24	100.0	.747	263530	179280	5.88	13430	11.87	15330
	95.0	.686	255720	164640	6.21	12940	12.55	84320
	90.0	.624	247790	149760	6.62	12340	13.45	73130
	85.0	.563	239980	135120	7.10	11620	14.66	62120
	79.9	.500	231920	120000	7.73	10680	16.46	50750
24	74.2	.476	216680	114240	7.59	10270	17.38	46420
21	60.4	.428	156890	89880	6.98	10510	14.74	39340
20	100.0	.873	219780	174600	5.04	15030	8.31	111550
	95.0	.800	213290	160000	5.33	14670	8.63	99750
	90.0	.726	206710	145200	5.69	14230	9.06	87810
	85.0	.653	200220	130600	6.13	13700	9.60	76010
	81.4	.600	195510	120000	6.52	13230	10.12	67450
20	75.0	.641	168470	128200	5.26	13590	9.71	74070
	70.0	.567	161890	113400	5.71	12890	10.52	62130
	65.4	.500	155930	100000	6.24	12070	11.57	51300
18	90.0	.796	186140	143280	5.20	15090	7.43	96080
	85.0	.714	180240	128520	5.61	14630	7.80	83580
	80.0	.632	174340	113760	6.13	14070	8.29	71140
	75.6	.560	169150	100800	6.71	13440	8.89	60210
18	70.0	.711	135930	127980	4.25	14620	7.81	83160
	65.0	.629	130030	113220	4.59	14050	8.31	70690
	60.0	.547	124120	98460	5.04	13310	9.03	58230
	54.7	.460	117860	82800	5.69	12230	10.22	45010
18	48.2	.380	109200	68400	6.39	10810	12.16	32850
15	75.0	.868	122170	130200	3.75	16010	5.62	100730
	70.0	.770	117270	115500	4.06	15630	5.85	87230
	65.0	.672	112370	100800	4.46	15130	6.16	73730
	60.8	.590	108270	88500	4.89	14600	6.53	62430
15	55.0	.648	90430	97200	3.72	14990	6.26	70430
	50.0	.550	85530	82500	4.15	14280	6.76	56930
	45.0	.452	80620	67800	4.76	13250	7.57	43430
	42.9	.410	78530	61500	5.11	12670	8.09	37650
15	37.3	.332	72090	49800	5.79	11170	9.68	26890

BEAM SAFE LOADS

BEAMS

MAXIMUM BENDING MOMENTS AND WEB RESISTANCES

Depth of Beam	Weight per Foot	Thickness of Web	Maximum Bending Moment	Web Resistance			Minimum End Bearing	End Reaction, $n=3\frac{1}{2}$ "
				Web Shear	Minimum Span	Web Buckling		
d		t	M _{max}	V		f _b	a	R
Inches	Pounds	Inches	Foot Pounds	Pounds	Feet	Pounds per Sq. In.	Inches	Pounds
12	55.0	.810	70970	97200	2.92	16430	4.30	86530
	50.0	.687	67030	82440	3.25	15970	4.51	71330
	45.0	.565	63130	67800	3.72	15320	4.83	56270
	40.8	.460	59770	55200	4.33	14480	5.29	43300
12	35.0	.428	50460	51360	3.93	14150	5.48	39350
	31.8	.350	47960	42000	4.57	13060	6.19	29710
12	27.9	.284	44310	34080	5.20	11680	7.27	21570
10	40.0	.741	42140	74100	2.27	16660	3.50	74080
	35.0	.594	38870	59400	2.62	16090	3.72	57330
	30.0	.447	35600	44700	3.19	15120	4.11	40560
	25.4	.310	32560	31000	4.20	13410	4.96	24950
10	22.4	.252	30300	25200	4.81	12120	5.75	18330
9	35.0	.724	32970	65160	2.02	16850	3.09	70130
	30.0	.561	30040	50490	2.38	16220	3.30	52320
	25.0	.397	27090	35730	3.03	15070	3.72	34410
	21.8	.290	25160	26100	3.86	13620	4.36	22720
8	25.5	.532	22680	42560	2.13	16400	2.88	47970
	23.0	.441	21390	35280	2.43	15860	3.05	38460
	20.5	.349	20080	27920	2.88	15030	3.32	28850
	18.4	.270	18960	21600	3.51	13870	3.77	20590
8	17.5	.220	19460	17600	4.42	12700	4.30	15370
7	20.0	.450	15980	31500	2.03	16310	2.54	38520
	17.5	.345	14840	24150	2.46	15490	2.77	28050
	15.3	.250	13800	17500	3.15	14150	3.20	18570
6	17.25	.465	11560	27900	1.66	16770	2.08	38980
	14.75	.343	10590	20580	2.06	15970	2.26	27390
	12.50	.230	9680	13800	2.81	14480	2.64	16650
5	14.75	.494	8030	24700	1.30	17250	1.65	40470
	12.25	.347	7210	17350	1.66	16510	1.78	27200
	10.0	.210	6450	10500	2.46	14880	2.11	14840
4	10.5	.400	4720	16000	1.18	17270	1.32	31080
	9.5	.326	4460	13040	1.37	16870	1.37	24750
	8.5	.253	4200	10120	1.66	16260	1.46	18510
	7.7	.190	3980	7600	2.09	15350	1.61	13120
3	7.5	.349	2560	10470	0.98	17510	0.96	25970
	6.5	.251	2370	7530	1.26	16930	1.02	18060
	5.7	.170	2210	5100	1.73	15950	1.13	11520

CARNEGIE STEEL COMPANY

CHANNELS

MAXIMUM BENDING MOMENTS AND WEB RESISTANCES

Depth of Channel	Weight per Foot	Thickness of Web	Maximum Bending Moment	Web Resistance			Minimum End Bearing	End Reaction, $a=3\frac{1}{2}''$	
				Web Shear	Minimum Span	Web Buckling			
d		t	M _{max}	V		f _b	a	R	
Inches	Pounds	Inches	Foot Pounds	Pounds	Feet	Pounds per Sq. In.	Inches	Pounds	
15	55.0	.814	76270	122100	2.50	15810	5.74	93290	
	50.0	.716	71420	107400	2.66	15370	6.01	79790	
	45.0	.618	66470	92700	2.87	14800	6.39	66290	
	40.0	.520	61570	78000	3.16	14000	6.96	52790	
	35.0	.422	56670	63300	3.58	12840	7.93	39290	
	33.9	.400	55570	60000	3.70	12510	8.24	36270	
13	50.0	.787	64190	102310	2.51	16140	4.81	85730	
	45.0	.673	59910	87490	2.74	15660	5.05	71120	
	40.0	.560	55660	72800	3.06	14980	5.43	56620	
	37.0	.492	53110	63960	3.32	14420	5.76	47900	
	35.0	.447	51420	58110	3.54	13960	6.06	42120	
	31.8	.375	48720	48750	4.00	13000	6.75	32900	
12	40.0	.755	43670	90600	1.93	16250	4.39	79740	
	35.0	.632	39730	75840	2.10	15710	4.64	64540	
	30.0	.510	35830	61200	2.34	14920	5.04	49470	
	25.0	.387	31890	46440	2.75	13630	5.81	34280	
	20.7	.280	28470	33600	3.39	11570	7.37	21060	
	10	35.0	.820	30720	82000	1.50	16890	3.42	83090
30.0		.673	27460	67300	1.63	16430	3.59	66330	
25.0		.526	24190	52600	1.84	15710	3.87	49570	
20.0		.379	20920	37900	2.21	14430	4.43	32810	
15.3		.240	17830	24000	2.97	11790	5.98	16970	
9		25.0	.612	20900	55080	1.52	16450	3.22	57900
	20.0	.448	17950	40320	1.78	15520	3.55	39980	
	15.0	.285	15010	25650	2.34	13530	4.40	22180	
	13.4	.230	14020	20700	2.71	12220	5.11	16160	
	8	21.25	.579	15870	46320	1.37	16610	2.82	52880
		18.75	.487	14570	38960	1.50	16160	2.95	43270
16.25		.395	13260	31600	1.68	15490	3.16	33650	
13.75		.303	11950	24240	1.97	14430	3.55	24040	
11.5		.220	10770	17600	2.45	12700	4.30	15370	
7		19.75	.629	12590	44030	1.14	17070	2.35	56380
	17.25	.524	11450	36680	1.25	16690	2.44	45910	
	14.75	.419	10310	29330	1.21	16110	2.60	35430	
	12.25	.314	9170	21980	1.67	15140	2.87	24950	
	9.8	.210	8030	14700	2.19	13220	3.54	14580	
	6	15.5	.550	8650	33540	1.03	17140	2.00	47910
13.0		.437	7670	26220	1.17	16620	2.11	36320	
10.5		.314	6690	18840	1.42	15690	2.32	24630	
8.2		.200	5780	12000	1.93	13800	2.85	13800	
5		11.5	.472	5520	23600	0.94	17170	1.66	38400
		9.0	.325	4710	16250	1.16	16340	1.81	25220
	6.7	.190	3950	9500	1.67	14440	2.21	13030	
	4	7.25	.320	3030	12800	0.95	16840	1.38	24240
		6.25	.247	2770	9880	1.12	16200	1.47	18000
		5.4	.180	2530	7200	1.40	15150	1.64	12270
3		6.0	.356	1830	10680	0.68	17540	0.96	26540
		5.0	.258	1630	7740	0.84	16990	1.02	18630
		4.1	.170	1450	5100	1.14	15950	1.13	11520

BEAM SAFE LOADS

BEAMS

ALLOWABLE UNIFORM LOAD IN THOUSANDS OF POUNDS

Maximum Bending Stress, 16,000 Pounds per Square Inch

Span in Feet	Depth and Weight of Sections											Coefficient of Deflection	
	27 In.	24 Inch									21 In.		
	90 lbs.	120 lbs.	115 lbs.	110 lbs.	105.9 lbs.	100 lbs.	95 lbs.	90 lbs.	85 lbs.	79.9 lbs.	74.2 lbs.		60.4 lbs.
6		888.0				358.6						179.8	0.60
7		382.3	363.8	824.0		351.4	829.5	299.5				179.3	0.81
8	283.0	334.5	326.7	318.8	300.0	263.5	255.7	247.8	240.0	231.9	216.7	156.9	1.06
9	259.7	297.4	290.4	283.4	277.7	234.2	227.3	220.2	213.3	206.1	192.6	139.5	1.34
10	233.7	267.6	261.4	255.0	249.9	210.8	204.6	198.2	192.0	185.5	173.3	125.5	1.66
11	212.5	243.3	237.6	231.9	227.2	191.6	186.0	180.2	174.5	168.7	157.6	114.1	2.00
12	194.8	223.0	217.8	212.5	208.3	175.7	170.5	165.2	160.0	154.6	144.5	104.6	2.38
13	179.8	205.9	201.1	196.2	192.2	162.1	157.4	152.5	147.7	142.7	133.3	96.5	2.80
14	167.0	191.2	186.7	182.2	178.5	150.6	146.1	141.6	137.1	132.5	123.8	89.7	3.24
15	155.8	178.4	174.3	170.0	166.6	140.6	136.4	132.2	128.0	123.7	115.6	83.7	3.72
16	146.1	167.3	163.4	159.4	156.2	131.8	127.8	123.9	120.0	116.0	108.3	78.4	4.24
17	137.5	157.4	153.8	150.0	147.0	124.0	120.3	116.6	112.9	109.1	102.0	73.8	4.78
18	129.9	148.7	145.2	141.7	138.8	117.1	113.7	110.1	106.7	103.1	96.3	69.7	5.36
19	123.0	140.9	137.6	134.2	131.5	110.9	107.7	104.3	101.0	97.6	91.2	66.1	5.98
20	116.9	133.8	130.7	127.5	125.0	105.4	102.3	99.1	96.0	92.8	86.7	62.8	6.62
21	111.3	127.4	124.5	121.4	119.0	100.4	97.4	94.4	91.4	88.3	82.5	59.8	7.30
22	106.2	121.6	118.8	115.9	113.6	95.8	93.0	90.0	87.3	84.3	78.8	57.1	8.01
23	101.6	116.4	113.6	110.9	108.7	91.7	89.0	86.2	83.5	80.7	75.4	54.6	8.76
24	97.4	111.5	108.9	106.2	104.1	87.8	85.3	82.6	80.0	77.3	72.2	52.3	9.53
25	93.5	107.1	104.6	102.0	100.0	84.3	81.8	79.3	76.8	74.2	69.3	50.2	10.35
26	89.9	102.9	100.5	98.1	96.1	81.1	78.7	76.2	73.8	71.4	66.7	48.3	11.19
27	86.6	99.1	96.8	94.5	92.6	78.1	75.8	73.4	71.1	68.7	64.2	46.5	12.07
28	83.5	95.6	93.4	91.1	89.2	75.3	73.1	70.8	68.6	66.3	61.9	44.8	12.98
29	80.6	92.3	90.1	87.9	86.2	72.7	70.6	68.4	66.2	64.0	59.8	43.3	13.92
30	77.9	89.2	87.1	85.0	83.3	70.3	68.2	66.1	64.0	61.8	57.8	41.8	14.90
31	75.4	86.3	84.3	82.3	80.6	68.0	66.0	63.9	61.9	59.8	55.9	40.5	15.91
32	73.0	83.6	81.7	79.7	78.1	65.9	63.9	62.0	60.0	58.0	54.2	39.2	16.95
33	70.8	81.1	79.2	77.3	75.7	63.9	62.0	60.1	58.2	56.2	52.5	38.0	18.03
34	68.7	78.7	76.9	75.0	73.5	62.0	60.2	58.3	56.5	54.6	51.0	36.9	19.13
35	66.8	76.5	74.7	72.9	71.4	60.2	58.4	56.6	54.9	53.0	49.5	35.9	20.28
36	64.9	74.3	72.6	70.8	69.4	58.6	56.8	55.1	53.3	51.5	48.2	34.9	21.45
37	63.2	72.3	70.6	68.9	67.5	57.0	55.3	53.6	51.9	50.1	46.8	33.9	22.66
38	61.5	70.4	68.8	67.1	65.8	55.5	53.8	52.2	50.5	48.8	45.6	33.0	23.90
39	59.9	68.6	67.0	65.4	64.1	54.1	52.5	50.8	49.2	47.6	44.4	32.2	25.18
40	58.4	66.9	65.3	63.8	62.5	52.7	51.1	49.6	48.0	46.4	43.3	31.4	26.48
41	57.0	65.3	63.8	62.2	61.0	51.4	49.9	48.4	46.8	45.3	42.3	30.6	27.82
42	55.7	63.7	62.2	60.7	59.5	50.2	48.7	47.2	45.7	44.2	41.3	29.9	29.20
43	54.4	62.2	60.8	59.3	58.1	49.0	47.6	46.1	44.6	43.1	40.3	29.2	30.60
44	53.1	60.8	59.4	58.0	56.8	47.9	46.5	45.1	43.6	42.2	39.4	28.5	32.04
45	52.0	59.5	58.1	56.7	55.5	46.8	45.5	44.1	42.7	41.2	38.5	28.5	33.52
46	50.8	58.2	56.8	55.4	54.3	45.8	44.5	43.1	41.7	40.3	37.7	28.5	35.02
47	49.7	56.9	55.6	54.3	53.2	44.9	43.5	42.2	40.8	39.5	36.9	28.5	36.56
48	48.7	55.8	54.5	53.1	52.1	43.9	42.6	41.3	40.0	38.7	36.1	28.5	38.14
49	47.7	54.6	53.3	52.1	51.0	43.0	41.8	40.5	39.2	37.9	35.4	28.5	39.74
50	46.7	53.5	52.3	51.0	50.0	42.2	40.9	39.6	38.4	37.1	34.7	28.5	41.38

Loads above upper horizontal lines will produce maximum allowable shear in webs.
 Loads below lower horizontal lines will produce excessive deflections.
 For maximum safe loads see tables of Maximum Bending Moments and Web Resistances.

CARNEGIE STEEL COMPANY

BEAMS

ALLOWABLE UNIFORM LOAD IN THOUSANDS OF POUNDS

Maximum Bending Stress, 16,000 Pounds per Square Inch

Span in Feet	Depth and Weight of Sections												Coefficient of Deflection		
	20 Inch						18 Inch								
	100 lbs.	95 lbs.	90 lbs.	85 lbs.	81.4 lbs.	75 lbs.	70 lbs.	65.4 lbs.	90 lbs.	85 lbs.	80 lbs.	75.6 lbs.			
6	349.2	320.0	290.4			256.4	226.8		286.6	257.0					0.60
7	293.0	284.4	275.6	261.2	249.0	224.6	215.9	200.0	248.2	240.3	227.5	201.6			0.81
8	251.2	243.8	236.2	228.8	223.4	192.5	185.0	178.2	212.7	205.9	199.2	193.3			1.06
9	219.8	213.3	206.7	200.2	195.5	168.5	161.9	155.9	186.2	180.2	174.3	169.2			1.34
10	195.4	189.6	183.8	178.0	173.8	149.7	143.9	138.6	165.5	160.2	155.0	150.4			1.66
11	175.8	170.6	165.4	160.2	156.4	134.8	129.5	124.7	148.9	144.2	139.5	135.3			2.00
12	159.9	155.1	150.3	145.6	142.2	122.5	117.7	113.4	135.4	131.1	126.7	123.0			2.38
13	146.5	142.2	137.8	133.5	130.3	112.3	107.9	104.0	124.1	120.2	116.2	112.8			2.80
14	135.2	131.2	127.2	123.2	120.3	103.7	99.6	96.0	114.5	110.9	107.3	104.1			3.24
15	125.6	121.9	118.1	114.4	111.7	96.3	92.5	89.1	106.4	103.0	99.6	96.7			3.72
16	117.2	113.7	110.3	106.8	104.3	89.9	86.3	83.2	99.3	96.1	93.0	90.2			4.24
17	109.9	106.6	103.4	100.1	97.8	84.2	81.0	78.0	93.1	90.1	87.2	84.6			4.78
18	103.4	100.4	97.3	94.2	92.0	79.3	76.2	73.4	87.6	84.8	82.0	79.6			5.36
19	97.7	94.8	91.9	89.0	86.9	74.9	72.0	69.3	82.7	80.1	77.5	75.2			5.98
20	92.5	89.8	87.0	84.3	82.3	70.9	68.2	65.7	78.4	75.9	73.4	71.2			6.62
21	87.9	85.3	82.7	80.1	78.2	67.4	64.8	62.4	74.5	72.1	69.7	67.7			7.30
22	83.7	81.3	78.8	76.3	74.5	64.2	61.7	59.4	70.9	68.7	66.4	64.4			8.01
23	79.9	77.6	75.2	72.8	71.1	61.3	58.9	56.7	67.7	65.5	63.4	61.5			8.76
24	76.4	74.2	71.9	69.7	68.0	58.6	56.3	54.2	64.7	62.7	60.6	58.8			9.53
25	73.3	71.1	68.9	66.7	65.2	56.2	54.0	52.0	62.1	60.1	58.1	56.4			10.35
26	70.3	68.3	66.2	64.1	62.6	53.9	51.8	49.9	59.6	57.7	55.8	54.1			11.19
27	67.6	65.6	63.6	61.6	60.2	51.8	49.8	48.0	57.3	55.4	53.6	52.0			12.07
28	65.1	63.2	61.2	59.3	57.9	49.9	48.0	46.2	55.2	53.4	51.6	50.1			12.98
29	62.8	60.9	59.0	57.2	55.9	48.1	46.3	44.6	53.2	51.5	49.8	48.3			13.92
30	60.6	58.8	57.0	55.2	53.9	46.5	44.7	43.0	51.4	49.7	48.1	46.7			14.90
31	58.6	56.9	55.1	53.4	52.1	44.9	43.2	41.6	49.6	48.1	46.5	45.1			15.91
32	56.7	55.0	53.4	51.7	50.5	43.5	41.8	40.2	48.5	46.5	45.0	43.7			16.95
33	54.9	53.3	51.7	50.1	48.9	42.1	40.5	39.0	46.5	45.1	43.6	42.3			18.03
34	53.3	51.7	50.1	48.5	47.4	40.8	39.2	37.8	45.1	43.7	42.3	41.0			19.13
35	51.7	50.2	48.6	47.1	46.0	39.6	38.1	36.7	43.8	42.4	41.0	39.8			20.28
36	50.2	48.8	47.2	45.8	44.7	38.5	37.0	35.6	42.5	41.2	39.9	38.7			21.45
37	48.8	47.4	45.9	44.5	43.4	37.4	36.0	34.7	41.4	40.0	38.7	37.6			22.66
38	47.5	46.1	44.7	43.3	42.3	36.4	35.0	33.7	40.2	39.0	37.7	36.6			23.90
39	46.3	44.9	43.5	42.1	41.2	35.5	34.1	32.8	39.2	37.9	36.7	35.6			25.18
40	45.1	43.8	42.4	41.1	40.1	34.6	33.2	32.0							26.48
41	44.0	42.7	41.3	40.0	39.1	33.7	32.4	31.2							27.82
42	42.9	41.6	40.3	39.1	38.1	32.9	31.6	30.4							29.20

Loads above upper horizontal lines will produce maximum allowable shear in webs.
 Loads below horizontal lines will produce excessive deflections.
 For maximum safe loads see tables of Maximum Bending Moments and Web Resistance

BEAM SAFE LOADS

BEAMS

ALLOWABLE UNIFORM LOAD IN THOUSANDS OF POUNDS

Maximum Bending Stress, 16,000 Pounds per Square Inch

Span in Feet	Depth and Weight of Sections												Coefficient of Deflection	
	18 Inch					15 Inch								
	70 lbs.	65 lbs.	60 lbs.	54.7 lbs.	48.2 lbs.	75 lbs.	70 lbs.	65 lbs.	60.8 lbs.	55 lbs.	50 lbs.	45 lbs.		42.9 lbs.
4	256.0	226.4				260.4				194.4				
5	217.5	208.0				244.3	231.0	201.6	177.0	180.9	165.0	136.6	129.0	
6	181.2	173.4	196.9	165.6		162.9	156.4	149.8	144.4	120.6	114.1	107.5	104.7	
7	155.3	148.5	141.8	134.7	124.8	139.7	134.0	128.4	123.7	103.3	97.7	92.1	89.7	
8	135.9	130.0	124.1	117.9	109.2	122.2	117.3	112.4	108.3	90.4	85.5	80.6	78.5	
9	120.8	115.6	110.3	104.8	97.1	108.6	104.2	99.9	96.2	80.4	76.0	71.7	69.8	
10	108.7	104.0	99.3	94.3	87.4	97.7	93.8	89.9	86.6	72.3	68.4	64.5	62.8	
11	98.9	94.6	90.3	85.7	79.4	88.9	85.3	81.7	78.7	65.8	62.3	58.6	57.1	
12	90.6	86.7	82.7	78.6	72.8	81.5	78.2	74.9	72.2	60.3	57.0	53.7	52.4	
13	83.7	80.0	76.4	72.5	67.2	75.2	72.2	69.1	66.6	55.6	52.6	49.4	48.3	
14	77.7	74.3	70.9	67.3	62.4	69.8	67.0	64.2	61.9	51.7	48.9	46.1	44.9	
15	72.5	69.4	66.2	62.9	58.2	65.2	62.5	59.9	57.7	48.2	45.6	43.0	41.9	
16	68.0	65.0	62.1	58.9	54.6	61.1	58.6	56.2	54.1	45.2	42.8	40.3	39.3	
17	64.0	61.2	58.4	55.5	51.4	57.5	55.2	52.9	50.9	42.6	40.3	37.7	37.0	
18	60.4	57.8	55.2	52.4	48.5	54.3	52.1	49.9	48.1	40.2	38.0	35.4	34.9	
19	57.2	54.8	52.3	49.6	46.0	51.4	49.4	47.3	45.6	38.1	36.0	33.3	33.1	
20	54.4	52.0	49.7	47.1	43.7	48.9	46.9	44.9	43.3	36.2	34.2	32.1	31.4	
21	51.8	49.5	47.3	44.9	41.6	46.5	44.7	42.8	41.2	34.5	32.6	30.7	29.9	
22	49.4	47.3	45.1	42.9	39.7	44.4	42.7	40.9	39.4	32.9	31.1	29.2	28.6	
23	47.3	45.2	43.2	41.0	38.0	42.5	40.8	39.1	37.7	31.5	29.8	28.0	27.3	
24	45.3	43.3	41.4	39.3	36.4	40.7	39.1	37.5	36.1	30.1	28.5	26.9	26.2	
25	43.5	41.6	39.7	37.7	34.9	39.1	37.5	36.0	34.6	28.9	27.4	25.8	25.1	
26	41.8	40.0	38.2	36.3	33.6	37.6	36.1	34.6	33.3	27.8	26.3	24.8	24.2	
27	40.3	38.5	36.8	34.9	32.3	36.2	34.7	33.3	32.1	26.8	25.3	23.8	23.3	
28	38.8	37.1	35.5	33.7	31.2	34.9	33.5	32.1	30.9	25.8	24.3	22.8	22.4	
29	37.5	35.9	34.2	32.5	30.1	33.7	32.3	31.0	29.9	24.9	23.4	21.9	21.7	
30	36.2	34.7	33.1	31.4	29.1	32.6	31.3	30.0	28.9	24.1	22.6	21.1	20.9	
31	35.1	33.6	32.0	30.4	28.2	31.5	30.3	29.0	27.9	23.3	21.9	20.5	20.3	
32	34.0	32.5	31.0	29.5	27.3	30.5	29.3	28.1	27.1	22.6	21.4	20.2	19.6	
33	33.0	31.5	30.1	28.6	26.5									
34	32.0	30.6	29.2	27.7	25.7									
35	31.0	29.7	28.4	26.9	25.0									
36	30.2	28.9	27.6	26.2	24.3									
37	29.4	28.1	26.8	25.5	23.6									
38	28.6	27.4	26.1	24.8	23.0									

Loads above upper horizontal lines will produce maximum allowable shear in webs.

Loads below lower horizontal lines will produce excessive deflections.

For maximum safe loads, see page 154.

CARNEGIE STEEL COMPANY

BEAMS

ALLOWABLE UNIFORM LOAD IN THOUSANDS OF POUNDS

Maximum Bending Stress, 16,000 Pounds per Square Inch

Span in Feet	Depth and Weight of Sections														Coefficient of Deflection
	15In.	12 Inch							10 Inch						
	37.3 lbs.	55 lbs.	50 lbs.	45 lbs.	40.8 lbs.	35 lbs.	31.8 lbs.	27.9 lbs.	40 lbs.	35 lbs.	30 lbs.	25.4 lbs.	22.4 lbs.		
3		194.4							148.2	118.8					0.15
4		180.2	164.9	135.6		102.7			112.4	103.7	89.4				0.27
5		141.9	134.1	126.3	110.4	100.9	84.0		84.3	77.7	71.2	62.0	50.4		0.41
		113.5	107.2	101.0	95.6	80.7	76.7		67.4	62.2	57.0	52.1	48.5		
6	99.6						68.2								
7	96.1	94.6	89.4	84.2	79.7	67.3	63.9	59.1	56.2	51.8	47.5	43.4	40.4		0.60
8	82.4	81.1	76.6	72.1	68.3	57.6	54.8	50.6	48.1	44.4	40.7	37.2	34.6		0.81
9	72.1	71.0	67.0	63.1	59.8	50.5	48.0	44.3	42.1	38.9	35.6	32.6	30.3		1.06
10	64.1	63.1	59.6	56.1	53.1	44.9	42.6	39.4	37.5	34.6	31.6	28.9	26.9		1.34
	57.7	56.8	53.6	50.5	47.8	40.4	38.4	35.5	33.7	31.1	28.5	26.0	24.2		1.66
11	52.4	51.6	48.7	45.9	43.5	36.7	34.9	32.2	30.6	28.3	25.9	23.7	22.0		2.00
12	48.1	47.3	44.7	42.1	39.8	33.6	32.0	29.5	28.1	25.9	23.7	21.7	20.2		2.38
13	44.4	43.7	41.2	38.8	36.8	31.0	29.5	27.3	25.9	23.9	21.9	20.0	18.6		2.80
14	41.2	40.6	38.3	36.1	34.2	28.8	27.4	25.3	24.1	22.2	20.3	18.6	17.3		3.24
15	38.4	37.8	35.7	33.7	31.9	26.9	25.6	23.6	22.5	20.7	19.0	17.4	16.2		3.72
16	36.0	35.5	33.5	31.6	29.9	25.2	24.0	22.2	21.1	19.4	17.8	16.3	15.1		4.24
17	33.9	33.4	31.5	29.7	28.1	23.7	22.6	20.9	19.8	18.3	16.8	15.3	14.3		4.78
18	32.0	31.5	29.8	28.1	26.6	22.4	21.3	19.7	18.7	17.3	15.8	14.5	13.5		5.36
19	30.4	29.9	28.2	26.6	25.2	21.2	20.2	18.7	17.7	16.4	15.0	13.7	12.8		5.98
20	28.8	28.4	26.8	25.3	23.9	20.2	19.2	17.7	16.9	15.5	14.2	13.0	12.1		6.62
21	27.5	27.0	25.5	24.0	22.8	19.2	18.3	16.9	16.1	14.8	13.6	12.4	11.5		7.30
22	26.2	25.8	24.4	23.0	21.7	18.3	17.4	16.1	15.3	14.1	12.9	11.8	11.0		8.01
23	25.1	24.7	23.3	22.0	20.8	17.5	16.7	15.4							8.76
24	24.0	23.7	22.3	21.0	19.9	16.8	16.0	14.8							9.53
25	23.1	22.7	21.4	20.2	19.1	16.1	15.3	14.2							10.35
26	22.2	21.8	20.6	19.4	18.4	15.5	14.8	13.6							11.19
27	21.4														12.07
28	20.6														12.98
29	19.9														13.92
30	19.2														14.90
31	18.6														15.91
32	18.0														16.95

Loads above upper horizontal lines will produce maximum allowable shear in webs.
 Loads below lower horizontal lines will produce excessive deflections.
 For maximum safe loads, see page 155.

BEAM SAFE LOADS

BEAMS

ALLOWABLE UNIFORM LOAD IN THOUSANDS OF POUNDS

Maximum Bending Stress, 16,000 Pounds per Square Inch

Span in Feet	Depth and Weight of Sections												Coefficient of Deflection
	9 Inch				8 Inch					7 Inch			
	35 lbs.	30 lbs.	25 lbs.	21.8 lbs.	25.5 lbs.	23 lbs.	20.5 lbs.	18.4 lbs.	17.5 lbs.	20 lbs.	17.5 lbs.	15.3 lbs.	
3	190.3	101.0			85.1	70.6	55.8			63.0	48.8		0.15
4	87.9	80.1			60.5	57.0	53.5	48.2		42.6	39.6	35.0	0.27
5	66.0	60.1	54.2	50.3	45.4	42.8	40.2	37.9	35.2	32.0	29.7	27.6	0.41
	52.8	48.1	43.3	40.3	36.3	34.2	32.1	30.3	31.1	25.6	23.7	22.1	
6	44.0	40.1	36.1	33.6	30.2	28.5	26.8	25.3	25.9	21.3	19.8	18.4	0.60
7	37.7	34.3	31.0	28.8	25.9	24.4	22.9	21.7	22.2	18.3	17.0	15.8	0.81
8	33.0	30.0	27.1	25.2	22.7	21.4	20.1	19.0	19.5	16.0	14.8	13.8	1.06
9	29.3	26.7	24.1	22.4	20.2	19.0	17.9	16.9	17.3	14.2	13.2	12.3	1.34
10	26.4	24.0	21.7	20.1	18.1	17.1	16.1	15.2	15.6	12.8	11.9	11.0	1.66
11	24.0	21.8	19.7	18.3	16.5	15.6	14.6	13.8	14.2	11.6	10.8	10.0	2.00
12	22.0	20.0	18.1	16.8	15.1	14.3	13.4	12.6	13.0	10.7	9.9	9.2	2.38
13	20.3	18.5	16.7	15.5	14.0	13.2	12.4	11.7	12.0	9.8	9.1	8.5	2.80
14	18.8	17.2	15.5	14.4	13.0	12.2	11.5	10.8	11.1	9.1	8.5	7.9	3.24
15	17.6	16.0	14.4	13.4	12.1	11.4	10.7	10.1	10.4	8.6	7.9	7.4	3.72
16	16.5	15.0	13.5	12.6	11.3	10.7	10.0	9.5	9.7	8.0	7.4	6.9	4.24
17	15.5	14.1	12.7	11.8	10.7	10.1	9.5	8.9	9.2				4.78
18	14.7	13.3	12.0	11.2	10.1	9.5	8.9	8.4	8.6				5.36
19	13.9	12.6	11.4	10.6									5.98
20	13.2	12.0	10.8	10.1									6.62

Span in Feet	Depth and Weight of Sections												Coefficient of Deflection	
	6 Inch			5 Inch			4 Inch				3 Inch			
	17.25 lbs.	14.75 lbs.	12.5 lbs.	14.75 lbs.	12.25 lbs.	10 lbs.	10.5 lbs.	9.5 lbs.	8.5 lbs.	7.7 lbs.	7.5 lbs.	6.5 lbs.		5.7 lbs.
1	55.8			49.4	34.7		32.0	26.1	20.2		20.9			0.02
2	46.3	41.2	37.6	32.1	28.8	21.0	18.9	17.8	16.8	15.2	20.5	15.1	10.2	0.07
3	30.8	28.2	25.8	21.4	19.2	17.2	12.6	11.9	11.2	10.6	6.8	6.3	5.9	0.15
4	23.1	21.2	19.4	16.1	14.4	12.9	9.4	8.9	8.4	8.0	5.1	4.7	4.4	0.27
5	18.5	16.9	15.5	12.8	11.5	10.3	7.6	7.1	6.7	6.4	4.1	3.8	3.5	0.41
6	15.4	14.1	12.9	10.7	9.6	8.6	6.3	6.0	5.6	5.3	3.4	3.2	2.9	0.60
7	13.2	12.1	11.1	9.2	8.2	7.4	5.4	5.1	4.8	4.5	2.9	2.7	2.5	0.81
8	11.6	10.6	9.7	8.0	7.2	6.4	4.7	4.5	4.2	4.0	2.6	2.4	2.2	1.06
9	10.3	9.4	8.6	7.1	6.4	5.7	4.2	4.0	3.7	3.5				1.34
10	9.3	8.5	7.7	6.4	5.8	5.2	3.8	3.6	3.4	3.2				1.66
11	8.4	7.7	7.0	5.8	5.2	4.7								2.00
12	7.7	7.1	6.5	5.4	4.8	4.3								2.38
13	7.1	6.5	6.0											2.80
14	6.6	6.1	5.5											3.24

Loads above upper horizontal lines will produce maximum allowable shear in webs.
 Loads below lower horizontal lines will produce excessive deflections.
 For maximum safe loads, see page 155.

CARNEGIE STEEL COMPANY

BEAMS—ALLOWABLE UNIFORM LOAD IN POUNDS PER FOOT

Depth, Inches	Pounds Per Foot	Span in Feet																			
		10	11	12	13	14	15	16	17	18	19	20	21	22	23	24	25	26	27	28	30
27	90	23370	19820	16230	13830	11930	10390	9130	8080	7210	6470	5840	5300	4830	4420	4060	3740	3460	3210	2980	2600
	120	26760	22120	18590	15840	13660	11890	10450	9260	8260	7410	6690	6070	5530	5060	4650	4280	3960	3670	3410	2970
	115	26140	21600	18150	15470	13330	11620	10210	9040	8070	7240	6530	5930	5400	4940	4540	4180	3870	3590	3330	2900
	110	25500	21080	17710	15090	13010	11340	9960	8820	7870	7060	6380	5780	5270	4820	4430	4080	3770	3500	3250	2830
	105	24900	20650	17360	14790	12750	11110	9760	8650	7710	6920	6250	5670	5160	4720	4340	4000	3700	3430	3190	2780
	100	21080	17420	14640	12470	10760	9370	8230	7290	6510	5840	5270	4780	4360	3980	3660	3370	3120	2890	2690	2340
24	90	20460	16910	14200	12110	10440	9090	7990	7080	6310	5670	5110	4640	4230	3870	3550	3270	3030	2810	2610	2270
	90	19820	16380	13760	11730	10110	8810	7740	6860	6120	5490	4960	4490	4100	3750	3440	3170	2930	2710	2530	2200
	85	19200	15870	13330	11360	9790	8530	7500	6640	5930	5320	4800	4350	3970	3630	3330	3070	2840	2630	2450	2130
	79	18550	15330	12880	10980	9470	8250	7250	6420	5730	5140	4640	4210	3830	3510	3220	2970	2740	2540	2370	2060
	74	17330	14330	12040	10260	8840	7700	6770	6000	5350	4800	4330	3930	3580	3280	3010	2770	2560	2380	2210	1930
21	60.4	12550	10370	8720	7430	6400	5580	4900	4340	3870	3480	3140	2850	2590	2370	2180	2010	1860	1730	1600	1390
	100	17580	14530	12210	10400	8970	7810	6870	6080	5430	4870	4400	3990	3630	3320	3050	2810	2600	2410	2240	1950
	95	17060	14100	11850	10100	8700	7580	6660	5900	5270	4730	4270	3870	3530	3230	2960	2730	2520	2340	2180	1900
	90	16540	13670	11480	9790	8400	7350	6460	5720	5100	4580	4130	3750	3420	3130	2870	2650	2450	2270	2110	1840
	85	16020	13240	11120	9480	8170	7120	6260	5540	4940	4430	4000	3630	3310	3030	2780	2560	2370	2200	2040	1780
20	81.4	15640	12930	10860	9260	7980	6950	6110	5410	4830	4330	3910	3550	3230	2960	2720	2500	2310	2150	2000	1740
	75	13480	11140	9360	7980	6880	5990	5260	4660	4160	3730	3370	3040	2780	2550	2340	2160	1990	1850	1720	1500
	70	12950	10700	8990	7690	6610	5760	5060	4480	4000	3590	3240	2940	2680	2450	2250	2070	1920	1780	1650	1440
	65.4	12470	10310	8660	7380	6370	5540	4870	4320	3850	3460	3120	2830	2580	2360	2170	2000	1850	1710	1590	1390
	90	14890	12310	10340	8810	7600	6620	5820	5150	4600	4120	3720	3380	3080	2810	2590	2380	2200	2040	1900	1650
	85	14420	11920	10010	8530	7360	6410	5630	4990	4450	3990	3610	3270	2980	2700	2500	2310	2130	1980	1840	1600
	80	13950	11530	9690	8250	7120	6200	5450	4830	4310	3860	3490	3160	2880	2640	2420	2230	2060	1910	1780	1550
	75.6	13530	11180	9400	8010	6900	6010	5280	4680	4180	3750	3380	3070	2800	2560	2350	2170	2000	1860	1730	1500
18	70	10870	8990	7550	6440	5550	4830	4250	3760	3360	3010	2720	2470	2250	2060	1890	1740	1610	1490	1330	1160
	65	10400	8600	7220	6160	5310	4620	4060	3600	3210	2880	2600	2360	2150	1970	1810	1660	1540	1430	1300	1160
	60	9930	8210	6900	5880	5070	4410	3880	3440	3060	2750	2480	2250	2050	1880	1720	1590	1470	1360	1230	1100
	54.7	9430	7790	6550	5580	4810	4190	3680	3260	2910	2610	2360	2140	1950	1780	1640	1510	1390	1290	1200	1050
	48.2	8740	7220	6070	5170	4460	3880	3410	3020	2700	2420	2180	1980	1800	1650	1520	1400	1290	1200	1110	970

BEAM SAFE LOADS

BEAMS—ALLOWABLE UNIFORM LOAD IN POUNDS PER FOOT

Depth, Inches	Pounds per Foot	Span in Feet																				
		6	7	8	9	10	11	12	13	14	15	16	17	18	19	20	21	22	23	24	25	26
15	75	27150	19950	15270	12070	9770	8080	6790	5780	4990	4340	3820	3380	3020	2710	2440	2220	2020	1850	1700	1560	1450
	70	26060	19150	14660	11580	9380	7750	6510	5550	4790	4170	3660	3250	2900	2600	2350	2130	1940	1770	1630	1500	1390
	65	24970	18350	14040	11100	8990	7430	6240	5320	4580	3990	3510	3110	2770	2490	2250	2040	1860	1700	1560	1440	1330
	60.8	24060	17680	13530	10690	8660	7160	6010	5130	4420	3850	3380	3000	2670	2400	2170	1960	1790	1640	1500	1390	1280
	55	20100	14760	11310	8930	7230	5980	5020	4280	3690	3220	2830	2500	2230	2000	1810	1640	1490	1370	1260	1160	1070
	50	19010	13960	10690	8450	6840	5650	4750	4050	3490	3040	2670	2370	2110	1900	1710	1550	1410	1290	1190	1090	1010
45	17910	13160	10080	7960	6450	5330	4480	3820	3290	2870	2520	2230	1990	1790	1610	1460	1330	1220	1120	1030	950	
42.9	17450	12820	9820	7760	6280	5190	4360	3720	3210	2790	2450	2170	1940	1740	1570	1420	1300	1190	1090	1010	930	
37.3	16020	11770	9010	7120	5770	4770	4010	3410	2940	2560	2250	2000	1780	1600	1440	1310	1190	1090	1000	920	850	
12	55	15770	11590	8870	7010	5680	4690	3940	3360	2900	2530	2220	1960	1750	1570	1420	1290	1170	1070	990	910	840
	50	14900	10940	8380	6620	5360	4430	3720	3170	2740	2380	2090	1860	1650	1490	1340	1220	1110	1010	930	860	790
	45	14030	10310	7890	6230	5050	4170	3510	2990	2580	2240	1970	1750	1560	1400	1260	1150	1040	950	880	810	750
	40.8	13280	9760	7470	5900	4780	3950	3320	2830	2440	2130	1870	1650	1480	1320	1200	1080	990	900	830	770	710
	35	11210	8240	6310	4980	4040	3340	2800	2390	2060	1790	1580	1400	1250	1120	1010	920	830	760	700	650	600
	31.8	10660	7830	6000	4740	3840	3170	2660	2260	1960	1710	1500	1330	1180	1060	960	870	790	730	670	610	570
27.9	9850	7240	5540	4380	3550	2930	2460	2100	1810	1580	1380	1230	1090	980	890	800	730	670	620	570	520	
10	40	9360	6880	5270	4160	3370	2790	2340	1990	1720	1500	1320	1170	1040	930	840	760	700	650	600	550	500
	35	8640	6350	4860	3840	3110	2570	2160	1840	1590	1380	1210	1080	960	860	780	710	640	590	540	500	450
	30	7910	5810	4450	3520	2850	2350	1980	1690	1450	1270	1110	990	880	790	710	650	590	540	500	450	400
	25.4	7240	5320	4070	3220	2600	2150	1810	1540	1330	1160	1020	900	800	720	650	590	540	500	450	400	350
22.4	6730	4950	3790	2990	2420	2000	1680	1430	1240	1080	950	840	750	670	610	550	500	450	400	350	300	
9	35	7350	5380	4120	3260	2640	2180	1830	1560	1350	1170	1030	910	810	730	660	600	550	500	450	400	350
	30	6680	4910	3750	2970	2400	1990	1670	1420	1230	1070	940	830	740	670	600	550	500	450	400	350	300
	25	6020	4420	3390	2680	2170	1790	1500	1280	1110	960	850	750	670	600	540	490	440	390	340	290	240
	21.8	5590	4110	3150	2490	2010	1660	1400	1190	1030	900	790	700	620	560	500	450	400	350	300	250	200

Loads within heavy horizontal lines are maximum loads for web shear.
Loads below dotted horizontal lines will produce excessive deflection.

CARNEGIE STEEL COMPANY

BEAMS—ALLOWABLE UNIFORM LOAD IN POUNDS PER FOOT

Depth, Inches	Pounds per Foot	Span in Feet																						
		2	2½	3	3½	4	4½	5	5½	6	6½	7	8	9	10	11	12	13	14	15	16	17	18	
8	25.5	42560	29040	20160	14810	11340	8960	7260	6000	5040	4300	3700	2830	2240	1810	1500	1260	1070	930	810	710	630	560	560
	23.	35280	27380	19010	13970	10990	8450	6840	5660	4750	4050	3490	2670	2110	1710	1410	1190	1010	870	760	670	590	530	530
	20.5	27920	22340	17850	13110	10040	7930	6430	5310	4460	3800	3280	2510	1980	1610	1330	1120	950	820	710	630	560	500	500
7	18.4	21600	17280	14400	12340	9480	7490	6070	5010	4210	3590	3100	2370	1870	1520	1250	1050	900	770	670	590	530	470	470
	17.5	17600	14080	11730	10060	8800	7690	6230	5150	4320	3680	3180	2430	1920	1560	1290	1080	920	790	690	610	540	480	480
5	20.	31500	20460	14200	104300	7990	6310	5110	4230	3550	3030	2610	2000	1580	1280	1060	890	760	650	570	500	500	500	500
	17.5	24150	18990	13190	9690	7420	5860	4750	3920	3300	2810	2420	1850	1470	1190	980	820	700	610	530	460	460	460	460
	15.3	17500	14000	11070	9010	6900	5450	4420	3650	3070	2610	2250	1730	1360	1100	910	770	650	560	490	430	430	430	430
4	17.25	23130	14800	10280	7550	5780	4570	3700	3060	2570	2190	1890	1450	1140	930	760	650	550	470	400	400	400	400	400
	14.75	20580	13550	9410	6910	5290	4180	3390	2800	2350	2000	1730	1320	1050	850	700	590	500	430	360	360	360	360	360
	12.5	13800	11040	8610	6320	4840	3830	3100	2560	2150	1830	1580	1210	960	770	640	540	460	400	400	400	400	400	400
3	14.75	16050	10250	7130	5240	4010	3170	2570	2120	1780	1520	1310	1000	790	640	530	450	380	320	320	320	320	320	320
	12.25	14420	9230	6410	4710	3600	2850	2310	1910	1600	1360	1180	900	710	580	480	400	340	340	340	340	340	340	340
	10.	10500	8250	5730	4210	3220	2550	2060	1710	1430	1230	1050	810	640	520	430	360	360	360	360	360	360	360	360
2	10.5	9450	6050	4200	3080	2360	1870	1510	1250	1050	890	770	590	470	380	320	320	320	320	320	320	320	320	320
	9.5	8920	5710	3960	2910	2230	1760	1430	1180	990	840	730	560	440	360	300	300	300	300	300	300	300	300	300
	8.5	8400	5380	3730	2740	2100	1660	1340	1110	930	800	690	530	420	340	340	340	340	340	340	340	340	340	340
1	7.7	7600	5090	3530	2600	1990	1570	1270	1050	880	750	650	500	390	320	320	320	320	320	320	320	320	320	320
	7.5	5130	3280	2280	1670	1280	1010	820	680	570	490	420	320	260	260	260	260	260	260	260	260	260	260	260
	6.5	4740	3030	2100	1550	1180	940	760	630	530	450	390	300	240	240	240	240	240	240	240	240	240	240	240
5.7	4410	2820	1960	1440	1100	870	710	580	490	420	360	280	220	220	220	220	220	220	220	220	220	220	220	

Lands within heavy horizontal lines are maximum loads for web shear.
Lands below dotted horizontal lines will produce excessive deflection.

MISCELLANEOUS BEAMS

ALLOWABLE UNIFORM LOAD IN THOUSANDS OF POUNDS

Maximum Bending Stress, 16,000 pounds per Square Inch

H BEAMS

Span in Feet	Depth and Weight of Sections								Coefficients of Deflection
	8 Inch		6 Inch			5 Inch	4 Inch		
	37.7 lb.	34.3 lb.	32.6 lb.	26.7 lb.	24.1 lb.	22.8 lb.	18.9 lb.	13.8 lb.	
3				52.5			81.3	25.0	0.15
4	80.0			42.1	37.5		25.4	19.0	0.27
5	64.4	60.0		33.7	32.1	80.0	20.3	14.3	0.41
6	53.7	51.4	50.0	28.1	26.7	26.1	16.9	9.5	0.60
7	46.0	44.0	43.0	24.1	22.9	22.3	14.5	8.1	0.81
8	40.3	38.5	37.6	21.1	20.1	19.6	12.7	7.1	1.06
9	35.8	34.2	33.4	18.7	17.8	17.4	11.3	6.3	1.34
10	32.2	30.8	30.1	16.8	16.0	15.6	10.1	5.7	1.66
11	29.3	28.0	27.3	15.3	14.6	14.2	9.2		2.00
12	26.8	25.7	25.1	14.0	13.4	13.0	8.5		2.38
13	24.8	23.7	23.1	13.0	12.3	12.0			2.80
14	23.0	22.0	21.5	12.0	11.5	11.2			3.24
15	21.5	20.5	20.1						3.72
16	20.1	19.3	18.8						4.24
17	18.9	18.1	17.7						4.78
18	17.9	17.1	16.7						5.36

CROSS TIE SECTIONS

Span in Feet	Depth and Weight of Sections					Coefficients of Deflection*
	6.5 Inch 29.8 Pounds	5.5 Inch 24.0 Pounds	5.5 Inch 20.0 Pounds	4.25 Inch 14.5 Pounds	3 Inch 9.5 Pounds	
3		41.8		21.3	12.2	
4	40.6	40.3	27.5	19.6	8.9	0.15
5	40.1	30.3	26.0	14.7	6.7	0.27
6	32.1	24.2	20.8	11.7	5.3	0.41
7	26.7	20.2	17.3	9.8	4.5	0.60
8	22.9	17.3	14.8	8.4	3.8	0.81
9	20.0	15.1	13.0	7.3	3.3	1.06
10	17.8	13.4	11.5	6.5	3.0	1.34
11	16.0	12.1	10.4	5.9	2.7	1.66
12	14.6	11.0	9.4	5.3		2.00
13	13.4	10.1	8.7			2.38
14	12.3	9.3	8.0			2.80
15	11.5	8.6	7.4			3.24
16	10.7					3.72

Loads above upper horizontal lines will produce maximum allowable shear in webs.

Loads below lower horizontal lines will produce excessive deflections.

*To obtain deflection divide coefficient by twice the distance of neutral axis from greatest distance of extreme fiber, obtained from table on page 129.

CARNEGIE STEEL COMPANY

CHANNELS

ALLOWABLE UNIFORM LOAD IN THOUSANDS OF POUNDS

Maximum Bending Stress, 16,000 Pounds per Square Inch

Span in Feet	Depth and Weight of Sections											Coefficient of Deflection	
	15 Inch						13 Inch						
	55 lbs.	50 lbs.	45 lbs.	40 lbs.	35 lbs.	33.9 lbs.	50 lbs.	45 lbs.	40 lbs.	37 lbs.	35 lbs.		31.8 lbs.
	244.2	214.8	185.4				204.6	175.0					
3	203.4	190.4	177.2	166.0	126.6	120.0	171.2	159.8	146.6	127.9	116.2	97.5	0.15
4	152.5	142.8	132.9	123.1	113.3	111.1	128.4	119.8	111.3	106.2	102.8	97.4	0.27
5	122.0	114.3	106.3	98.5	90.7	88.9	102.7	95.9	89.1	85.0	82.3	77.9	0.41
6	101.7	95.2	88.6	82.1	75.6	74.1	85.6	79.9	74.2	70.8	68.6	65.0	0.60
7	87.1	81.6	75.9	70.3	64.7	63.5	73.3	68.4	63.6	60.6	58.8	55.7	0.81
8	76.3	71.4	66.5	61.6	56.7	55.6	64.2	59.9	55.7	53.1	51.4	48.7	1.06
9	67.8	63.5	59.1	54.7	50.4	49.4	57.1	53.2	49.5	47.2	45.7	43.3	1.34
10	61.0	57.1	53.2	49.3	45.3	44.5	51.3	47.9	44.5	42.5	41.1	39.0	1.66
11	55.5	51.9	48.3	44.8	41.2	40.4	46.7	43.6	40.5	38.6	37.4	35.4	2.00
12	50.9	47.6	44.3	41.1	37.7	37.0	42.8	39.9	37.1	35.4	34.3	32.5	2.38
13	47.0	44.0	40.9	37.9	34.9	34.2	39.5	36.9	34.3	32.7	31.6	30.0	2.80
14	43.6	40.8	38.0	35.2	32.4	31.8	36.7	34.2	31.8	30.3	29.4	27.8	3.24
15	40.7	38.1	35.5	32.8	30.2	29.6	34.2	31.9	29.7	28.3	27.4	26.0	3.72
16	38.1	35.7	33.2	30.8	28.3	27.8	32.1	30.0	27.8	26.6	25.7	24.4	4.24
17	35.9	33.6	31.3	29.0	26.7	26.1	30.2	28.2	26.2	25.0	24.2	22.9	4.78
18	33.9	31.7	29.5	27.4	25.2	24.7	28.5	26.6	24.7	23.6	22.9	21.7	5.36
19	32.1	30.1	28.0	25.9	23.9	23.4	27.0	25.2	23.4	22.4	21.6	20.5	5.98
20	30.5	28.6	26.6	24.6	22.7	22.2	25.7	24.0	22.3	21.2	20.6	19.5	6.62
21	29.1	27.2	25.3	23.5	21.6	21.2	24.5	22.8	21.2	20.2	19.6	18.6	7.30
22	27.7	26.0	24.2	22.4	20.6	20.2	23.3	21.8	20.2	19.3	18.7	17.7	8.01
23	26.5	24.8	23.1	21.4	19.7	19.3	22.3	20.8	19.4	18.5	17.9	16.9	8.76
24	25.4	23.8	22.2	20.5	18.9	18.5	21.4	20.0	18.6	17.7	17.1	16.2	9.53
25	24.4	22.9	21.3	19.7	18.1	17.8	20.5	19.2	17.8	17.0	16.5	15.6	10.35
26	23.5	22.0	20.5	18.9	17.4	17.1	19.8	18.4	17.1	16.3	15.8	15.0	11.19
27	22.6	21.2	19.7	18.2	16.8	16.5	19.4	17.7	16.5	15.7	15.2	14.4	12.07
28	21.8	20.4	19.0	17.6	16.2	15.9	18.3	17.1	15.9	15.2	14.7	13.9	12.98
29	21.0	19.7	18.3	17.0	15.6	15.3							13.92
30	20.3	19.0	17.7	16.4	15.1	14.8							14.90
31	19.7	18.4	17.2	15.9	14.6	14.3							15.91
32	19.1	17.9	16.6	15.4	14.2	13.9							16.95

Loads above upper horizontal lines will produce maximum allowable shear in webs.

Loads below lower horizontal lines will produce excessive deflections.

For maximum safe loads, see page 156.

BEAM SAFE LOADS

CHANNELS

ALLOWABLE UNIFORM LOAD IN THOUSANDS OF POUNDS

Maximum Bending Stress, 16,000 Pounds per Square Inch

Span in Feet	Depth and Weight of Sections										Coefficient of Deflection	
	12 Inch					10 Inch						
	40 lbs.	35 lbs.	30 lbs.	25 lbs.	20.7 lbs.	35 lbs.	30 lbs.	25 lbs.	20 lbs.	15.3 lbs.		
2	181.2					164.0	184.6	105.2				
3	174.7	151.7	122.4	93.9		122.9	109.8	96.8	76.8	48.0	0.07	
4	116.4	105.9	95.5	85.0	67.2	81.9	73.2	64.5	55.8	47.6	0.15	
5	87.3	79.5	71.7	63.8	56.9	61.4	54.9	48.4	41.8	35.7	0.27	
6	69.9	63.6	57.3	51.0	45.5	49.2	43.9	38.7	33.5	28.5	0.41	
7	58.2	53.0	47.8	42.5	38.0	41.0	36.6	32.3	27.9	23.8	0.60	
8	49.9	45.4	40.9	36.4	32.5	35.1	31.4	27.6	23.9	20.4	0.81	
9	43.7	39.7	35.8	31.9	28.5	30.7	27.5	24.2	20.9	17.8	1.06	
10	38.8	35.3	31.8	28.3	25.3	27.3	24.4	21.5	18.6	15.9	1.34	
11	34.9	31.8	28.7	25.5	22.8	24.6	22.0	19.4	16.7	14.3	1.66	
12	31.7	28.9	26.1	23.2	20.7	22.3	20.0	17.6	15.2	13.0	2.00	
13	29.1	26.5	23.9	21.3	19.0	20.5	18.3	16.1	13.9	11.9	2.38	
14	26.9	24.5	22.0	19.6	17.5	18.9	16.9	14.9	12.9	11.0	2.80	
15	25.0	22.7	20.5	18.2	16.3	17.6	15.7	13.8	12.0	10.2	3.24	
16	23.3	21.2	19.1	17.0	15.2	16.4	14.6	12.9	11.2	9.5	3.72	
17	21.8	19.9	17.9	15.9	14.2	15.4	13.7	12.1	10.5	8.9	4.24	
18	20.6	18.7	16.9	15.0	13.4	14.5	12.9	11.4	9.9	8.4	4.78	
19	19.4	17.7	15.9	14.2	12.7	13.7	12.2	10.7	9.3	7.9	5.36	
20	18.4	16.7	15.1	13.4	12.0	12.9	11.6	10.2	8.8	7.5	5.98	
21	17.5	15.9	14.3	12.8	11.4	12.3	11.0	9.7	8.4	7.1	6.62	
22	16.6	15.1	13.6	12.1	10.8	11.7	10.5	9.2	8.0	6.8	7.30	
23	15.9	14.4	13.0	11.6	10.4	11.2	10.0	8.8	7.6	6.5	8.01	
24	15.2	13.8	12.5	11.1	9.9						8.76	
25	14.6	13.2	11.9	10.6	9.5						9.53	
26	14.0	12.7	11.5	10.2	9.1						10.35	
27	13.4	12.2	11.0	9.8	8.8						11.19	

Loads above upper horizontal lines will produce maximum allowable shear in webs.
 Loads below lower horizontal lines will produce excessive deflections.

For maximum safe loads, see page 156.

CARNEGIE STEEL COMPANY

CHANNELS

ALLOWABLE UNIFORM LOAD IN THOUSANDS OF POUNDS

Maximum Bending Stress, 16,000 Pounds per Square Inch

Span in Feet	Depth and Weight of Sections														Coefficient of Deflection	
	9 Inch				8 Inch					7 Inch						
	25 lbs.	20 lbs.	15 lbs.	13.4 lbs.	21.25 lbs.	18.75 lbs.	16.25 lbs.	13.75 lbs.	11.5 lbs.	19.75 lbs.	17.25 lbs.	14.75 lbs.	12.25 lbs.	9.8 lbs.		
2	110.2	80.6			92.6	77.9	63.2	48.5		88.1	73.4	58.7	44.0			
3	83.6	71.8	51.3	41.4	63.5	58.3	53.0	47.8	35.2	50.4	45.8	41.2	36.7	29.4		0.07
4	55.7	47.8	40.0	37.4	42.3	38.8	35.3	31.9	28.7	33.6	30.5	27.5	24.4	21.4		0.15
5	41.8	35.9	30.0	28.0	31.7	29.1	26.5	23.9	21.5	25.2	22.9	20.6	18.3	16.1		0.27
6	33.4	28.7	24.0	22.4	25.4	23.3	21.2	19.1	17.2	20.2	18.3	16.5	14.7	12.9		0.41
7	27.9	23.9	20.0	18.7	21.2	19.4	17.7	15.9	14.4	16.8	15.3	13.7	12.2	10.7		0.60
8	23.9	20.5	17.2	16.0	18.1	16.6	15.1	13.7	12.3	14.4	13.1	11.7	10.5	9.2		0.81
9	20.9	17.9	15.0	14.0	15.9	14.6	13.3	11.9	10.8	12.6	11.4	10.3	9.2	8.0		1.06
10	18.6	16.0	13.3	12.5	14.1	12.9	11.8	10.6	9.6	11.2	10.2	9.2	8.2	7.1		1.34
11	16.7	14.4	12.0	11.2	12.7	11.7	10.6	9.6	8.6	10.1	9.2	8.2	7.3	6.4		1.66
12	15.2	13.1	10.9	10.2	11.5	10.6	9.6	8.7	7.8	9.2	8.3	7.5	6.7	5.8		2.00
13	13.9	12.0	10.0	9.3	10.6	9.7	8.8	8.0	7.2	8.4	7.6	6.9	6.1	5.4		2.38
14	12.9	11.0	9.2	8.6	9.8	9.0	8.2	7.4	6.6	7.8	7.0	6.3	5.6	4.9		2.80
15	11.9	10.3	8.6	8.0	9.1	8.3	7.6	6.8	6.2	7.2	6.5	5.9	5.2	4.6		3.24
16	11.1	9.6	8.0	7.5	8.5	7.8	7.1	6.4	5.7	6.7	6.1	5.5	4.9	4.3		3.72
17	10.4	9.0	7.5	7.0	7.9	7.3	6.6	6.0	5.4	6.3	5.7	5.2	4.6	4.0		4.24
18	9.8	8.4	7.1	6.6	7.5	6.9	6.2	5.6	5.1							4.78
19	9.3	8.0	6.7	6.2	7.1	6.5	5.9	5.3	4.8							5.36
20	8.8	7.6	6.3	5.9												5.98
	8.4	7.2	6.0	5.6												6.62

Span in Feet	Depth and Weight of Sections												Coefficient of Deflection			
	6 Inch				5 Inch			4 Inch			3 Inch					
	15.5 lbs.	13 lbs.	10.5 lbs.	8.2 lbs.	11.5 lbs.	9 lbs.	6.7 lbs.	7.25 lbs.	6.25 lbs.	5.4 lbs.	6 lbs.	5 lbs.		4.1 lbs.		
1					47.2			25.6			21.4	15.5				
2	67.1	52.4	37.7	24.0	44.2	32.5	19.0	24.3	19.8	14.4	14.7	13.0	10.2			0.02
3	34.6	30.7	26.8	23.1	22.1	18.8	15.8	12.1	11.1	10.1	7.3	6.5	5.8			0.07
4	23.1	20.5	17.8	15.4	14.7	12.5	10.5	8.1	7.4	6.7	4.9	4.3	3.9			0.15
5	17.3	15.3	13.4	11.6	11.0	9.4	7.9	6.1	5.5	5.1	3.7	3.3	2.9			0.27
6	13.8	12.3	10.7	9.2	8.8	7.5	6.3	4.9	4.4	4.1	2.9	2.6	2.3			0.41
7	11.5	10.2	8.9	7.7	7.4	6.3	5.3	4.0	3.7	3.4	2.4	2.2	1.9			0.60
8	9.9	8.8	7.6	6.6	6.3	5.4	4.5	3.5	3.2	2.9	2.1	1.9	1.7			0.81
9	8.6	7.7	6.7	5.8	5.5	4.7	4.0	3.0	2.8	2.5	1.8	1.6	1.5			1.06
10	7.7	6.8	5.9	5.1	4.9	4.2	3.5	2.7	2.5	2.2						1.34
11	6.9	6.1	5.4	4.6	4.4	3.8	3.2	2.4	2.2	2.0						1.66
12					4.0	3.4	2.9									2.00
13	5.8	5.1	4.5	3.9	3.7	3.1	2.6									2.38
14	5.3	4.7	4.1	3.6												2.80
	4.9	4.4	3.8	3.3												3.24

Loads above upper horizontal lines will produce maximum allowable shear in webs.
 Loads below lower horizontal lines will produce excessive deflections.
 For maximum safe loads, see page 156.

BEAM SAFE LOADS

CHANNELS—ALLOWABLE UNIFORM LOAD IN POUNDS PER FOOT

Depth, Inches	Pounds per Foot	Span in Feet																				
		6	7	8	9	10	11	12	13	14	15	16	17	18	19	20	21	22	23	24	25	26
15	55	16950	12450	9540	7530	6100	5040	4240	3610	3110	2710	2380	2110	1880	1690	1530	1380	1260	1150	1060	980	900
	50	15870	11660	8920	7050	5710	4720	3970	3350	2910	2540	2230	1980	1760	1580	1430	1300	1180	1080	990	910	850
	45	14770	10850	8310	6560	5320	4390	3690	3150	2710	2360	2080	1840	1640	1470	1330	1210	1100	1000	920	850	790
	40	13680	10050	7700	6080	4930	4070	3420	2910	2510	2190	1920	1700	1520	1360	1230	1120	1020	930	860	790	730
	35	12590	9250	7080	5600	4530	3750	3150	2680	2310	2010	1770	1570	1400	1260	1130	1030	940	860	790	730	670
33.9	12350	9070	6950	5490	4450	3670	3090	2630	2270	1970	1740	1540	1370	1230	1110	1010	920	840	770	710	660	600
13	50	14260	10480	8020	6340	5130	4240	3570	3040	2620	2280	2010	1780	1580	1420	1280	1160	1060	970	890	820	760
	45	13310	9780	7490	5920	4790	3960	3330	2840	2450	2130	1870	1660	1480	1330	1200	1090	990	910	830	770	710
	40	12370	9090	6960	5500	4450	3680	3090	2630	2270	1980	1740	1540	1370	1230	1110	1010	920	840	770	710	660
	37	11800	8670	6640	5250	4250	3510	2950	2510	2170	1890	1660	1470	1310	1180	1060	960	880	800	740	680	630
	35	11430	8400	6430	5080	4110	3400	2860	2430	2100	1830	1610	1420	1270	1140	1030	930	850	780	710	660	610
31.8	10830	7950	6090	4810	3900	3220	2710	2310	1990	1730	1520	1350	1200	1080	970	880	810	740	680	620	580	540
12	40	9700	7130	5460	4310	3490	2890	2430	2070	1780	1550	1360	1210	1080	970	870	790	720	660	610	560	520
	35	8830	6490	4970	3920	3180	2630	2210	1880	1620	1410	1240	1100	980	880	800	720	660	600	550	510	470
	30	7960	5850	4480	3540	2870	2370	1990	1700	1460	1270	1120	990	880	790	720	650	590	540	500	460	420
	25	7090	5210	3990	3150	2550	2110	1770	1510	1300	1130	1000	880	790	710	640	580	530	480	440	410	380
	20.7	6330	4650	3560	2810	2280	1880	1580	1350	1160	1010	890	790	700	630	570	520	470	430	400	360	340
10	35	6830	5020	3840	3030	2460	2030	1710	1460	1250	1090	960	850	760	680	610	560	510	470	440	410	380
	30	6100	4480	3430	2710	2200	1820	1530	1300	1120	980	860	760	680	610	550	500	450	410	380	350	320
	25	5380	3950	3020	2390	1940	1600	1340	1150	990	860	760	670	600	540	480	440	400	370	340	310	280
	20	4650	3420	2620	2070	1670	1380	1160	990	850	740	650	580	520	460	420	380	350	320	290	260	230
	15.3	3960	2910	2230	1760	1430	1180	990	840	730	630	560	490	440	400	360	320	300	270	240	210	180
9	25	4640	3410	2610	2060	1670	1380	1160	990	850	740	650	580	520	460	420	380	350	320	290	260	230
	20	3990	2930	2240	1770	1440	1190	1000	850	730	640	560	500	440	400	360	330	300	270	240	210	180
	15	3340	2450	1880	1480	1200	990	830	710	610	530	470	420	370	330	300	270	240	210	180	150	130
	13.4	3120	2290	1750	1380	1120	930	780	660	570	500	440	390	350	310	280	250	220	190	160	130	110

Loads within heavy horizontal lines are maximum loads for web shear.
Loads below dotted horizontal lines will produce excessive deflection.

CARNEGIE STEEL COMPANY

CHANNELS—ALLOWABLE UNIFORM LOAD IN POUNDS PER FOOT

Depth, Inches	Span in Feet																						
	2	2½	3	3½	4	4½	5	5½	6	6½	7	8	9	10	11	12	13	14	15	16	17	18	
21.25	31750	20320	14110	10370	7940	6270	5080	4200	3530	3010	2590	1980	1570	1270	1050	880	750	650	560	500	440	390	360
18.75	29130	18640	12950	9510	7280	5750	4660	3850	3240	2760	2380	1820	1440	1170	960	810	690	590	520	460	400	360	330
16.25	26510	16970	11780	8660	6630	5240	4240	3510	2950	2510	2160	1660	1310	1060	880	740	630	540	470	410	370	330	300
13.75	23900	15290	10620	7800	5970	4720	3820	3160	2660	2260	1950	1490	1180	960	790	660	570	490	430	370	330	300	270
11.5	17600	13780	9570	7030	5380	4250	3450	2850	2390	2040	1760	1350	1060	860	710	600	510	440	380	340	300	270	240
19.75	25190	16120	11190	8220	6300	4980	4030	3330	2800	2380	2060	1570	1240	1010	830	700	590	510	450	390	350	320	290
17.25	22900	14650	10180	7480	5720	4520	3660	3030	2540	2170	1870	1430	1130	920	760	640	540	470	410	360	320	290	260
14.75	20620	13190	9160	6730	5150	4070	3300	2730	2290	1950	1680	1290	1020	820	680	570	490	420	370	320	280	250	220
12.25	18330	11730	8150	5990	4580	3620	2930	2420	2040	1740	1500	1150	910	730	610	510	430	370	330	290	260	230	200
9.8	14700	10280	7140	5250	4020	3170	2570	2120	1780	1520	1310	1000	790	640	530	450	380	330	290	250	220	190	160
15.5	17300	11070	7690	5650	4320	3420	2770	2290	1920	1640	1410	1080	850	690	570	480	410	350	310	270	240	210	180
13.0	15340	9820	6820	5010	3840	3000	2450	2030	1700	1450	1250	960	760	610	510	430	360	310	270	240	210	180	150
10.5	13380	8560	5950	4370	3340	2640	2140	1770	1490	1270	1090	840	660	540	440	370	320	270	240	210	180	150	120
8.2	11550	7390	5130	3770	2890	2280	1850	1530	1280	1090	940	720	570	460	380	320	270	240	210	180	150	120	90
11.5	11040	7070	4910	3610	2760	2180	1770	1460	1230	1050	900	690	550	440	370	310	260	220	190	160	130	100	70
9.0	9410	6020	4180	3070	2350	1860	1510	1240	1050	890	770	590	470	380	310	260	220	190	160	130	100	70	40
6.7	7910	5060	3520	2580	1980	1560	1270	1050	880	750	650	490	390	320	260	220	190	160	130	100	70	40	10
7.25	6060	3880	2700	1980	1520	1200	970	800	670	570	500	380	300	240	200	170	140	110	80	50	20	10	0
6.25	5530	3540	2460	1810	1380	1090	890	730	620	520	450	350	270	220	180	150	120	90	60	30	10	0	0
5.4	5060	3240	2250	1650	1260	1000	810	670	560	480	410	320	250	200	160	130	100	70	40	10	0	0	0
6.0	3660	2340	1630	1190	910	720	590	480	410	350	300	240	190	150	120	90	60	30	10	0	0	0	0
5.0	3260	2090	1450	1060	820	640	520	430	360	310	270	210	160	120	90	60	30	10	0	0	0	0	0
4.1	2910	1860	1290	950	730	580	470	390	320	280	240	180	140	100	70	40	10	0	0	0	0	0	0

Loads within heavy horizontal lines are maximum loads for web shear.
Loads below dotted horizontal lines will produce excessive deflection.

BEAM SAFE LOADS

EQUAL ANGLES

ALLOWABLE UNIFORM LOAD IN THOUSANDS OF POUNDS

Neutral Axis Parallel to Either Leg

Maximum Bending Stress, 16,000 Pounds per Square Inch

Size, Inches	Thick-ness, Inches	1 Foot Span		Maximum Span 360 x Deflection		Size, Inches	Thick-ness, Inches	1 Foot Span		Maximum Span 360 x Deflection	
		Safe Load	Safe Load	Safe Load	Length, Feet			Safe Load	Safe Load	Length, Feet	
8 x 8	1 1/8	186.99	8.31	22.5	3 1/2 x 3 1/2	3 1/2 x 3 1/2	1 3/16	24.00	2.55	9.4	
	1 1/16	177.81	7.87	22.6			3/4	22.51	2.37	9.5	
	1	168.53	7.43	22.7			11/16	20.91	2.18	9.6	
	15/16	159.15	6.98	22.8			5/8	19.31	2.00	9.7	
	7/8	149.55	6.53	22.9			9/16	17.60	1.81	9.7	
	13/16	139.84	6.08	23.0			1/2	15.89	1.62	9.8	
	3/4	130.03	5.63	23.1			7/16	14.08	1.42	9.9	
	11/16	120.00	5.18	23.2			5/8	12.27	1.23	10.0	
	5/8	109.87	4.73	23.2			9/16	10.45	1.04	10.1	
	1/2	99.63	4.28	23.3			1/4	8.43	0.83	10.2	
6 x 6	1/2	89.28	3.82	23.4	3 x 3	3 x 3	5/8	13.87	1.69	8.2	
	1	91.41	5.48	16.7			9/16	12.69	1.53	8.3	
	15/16	86.51	5.16	16.8			1/2	11.41	1.37	8.3	
	7/8	81.39	4.84	16.8			7/16	10.13	1.21	8.4	
	13/16	76.27	4.51	16.9			3/8	8.85	1.04	8.5	
	3/4	71.04	4.18	17.0			5/16	7.57	0.88	8.6	
	11/16	65.81	3.85	17.1			1/4	6.19	0.71	8.7	
	5/8	60.37	3.51	17.2			1/2	7.79	1.15	6.8	
	1/2	54.83	3.17	17.3			7/16	6.93	1.01	6.9	
	1/2	49.17	2.83	17.4			3/8	6.08	0.87	7.0	
5 x 5	1/2	43.41	2.48	17.5	2 1/2 x 2 1/2	2 1/2 x 2 1/2	5/16	5.12	0.72	7.1	
	3/8	37.65	2.14	17.6			1/4	4.16	0.58	7.2	
	1	61.87	4.55	13.6			9/16	3.20	0.44	7.3	
	15/16	58.56	4.28	13.7			1/8	2.13	0.29	7.4	
	7/8	55.15	4.00	13.8			7/16	4.27	0.79	5.4	
	13/16	51.73	3.73	13.9			3/8	3.73	0.68	5.5	
	3/4	48.32	3.45	14.0			1/2	3.20	0.57	5.6	
	11/16	44.80	3.18	14.1			3/4	2.67	0.46	5.7	
	5/8	41.17	2.90	14.2			5/16	2.03	0.35	5.8	
	1/2	37.44	2.62	14.3			1/8	1.39	0.24	5.8	
4 x 4	1/2	33.60	2.34	14.4	1 3/4 x 1 3/4	1 3/4 x 1 3/4	7/16	3.20	0.68	4.7	
	3/8	25.81	1.78	14.5			3/8	2.77	0.60	4.7	
	13/16	32.11	2.95	10.9			5/16	2.45	0.51	4.8	
	3/4	29.97	2.73	11.0			1/4	2.03	0.41	4.9	
	11/16	27.84	2.51	11.1			3/4	2.03	0.41	4.8	
	5/8	25.60	2.29	11.2			9/16	1.49	0.30	5.0	
	1/2	23.36	2.07	11.3			1/8	1.07	0.21	5.1	
	3/4	21.01	1.85	11.4			3/8	2.03	0.51	4.0	
	5/8	18.67	1.63	11.4			5/16	1.73	0.42	4.1	
	1/2	16.21	1.41	11.5			1/4	1.43	0.34	4.2	
1 x 1	3/8	13.76	1.19	11.6	1 1/2 x 1 1/2	1 1/2 x 1 1/2	9/16	1.11	0.26	4.3	
	1/4	11.20	0.96	11.7			1/8	0.77	0.18	4.4	
	1/4	13.76	1.19	11.6			5/16	1.19	0.36	3.3	
	1/4	11.20	0.96	11.7			1/4	0.97	0.29	3.4	
							3/8	0.76	0.22	3.5	
							1/2	0.52	0.14	3.6	
							1/4	0.60	0.22	2.6	
							9/16	0.47	0.17	2.7	
							1/8	0.33	0.12	2.8	

CARNEGIE STEEL COMPANY

UNEQUAL ANGLES

ALLOWABLE UNIFORM LOAD IN THOUSANDS OF POUNDS

Neutral Axis Parallel to Shorter Leg

Maximum Bending Stress, 16,000 Pounds per Square Inch

Size, Inches	Thick- ness, Inches	1 Foot Span			Size, Inches	Thick- ness, Inches	1 Foot Span		
		Safe Load	Safe Load	Length, Feet			Safe Load	Safe Load	Length, Feet
8 x 6	1	161.17	7.49	21.5	6 x 3½	1	83.52	5.57	15.0
	1½	152.21	7.04	21.6		1½	79.04	5.24	15.1
	¾	143.04	6.59	21.7		¾	74.45	4.90	15.2
	1¾	133.87	6.14	21.8		1¾	69.87	4.57	15.3
	½	124.48	5.68	21.9		½	65.07	4.23	15.4
	1½	114.88	5.22	22.0		1½	60.27	3.89	15.5
	⅝	105.28	4.76	22.1		⅝	55.36	3.55	15.6
	⅞	95.47	4.30	22.2		⅞	50.35	3.21	15.7
	½	85.55	3.84	22.3		½	45.23	2.86	15.8
	⅞	75.41	3.37	22.4		⅞	40.00	2.52	15.9
	1	146.03	7.53	19.4		¾	34.67	2.17	16.0
	1½	138.03	7.08	19.5		⅞	29.23	1.83	16.0
	¾	129.92	6.63	19.6		¾	53.23	4.00	13.3
	1¾	121.60	6.17	19.7		1¾	50.03	3.73	13.4
8 x 3½	¾	113.17	5.72	19.8	¾	46.61	3.46	13.5	
	1½	104.58	5.23	19.9	1½	43.20	3.19	13.5	
	⅝	95.79	4.78	20.0	⅝	39.79	2.92	13.6	
	⅞	86.93	4.32	20.1	⅞	36.16	2.64	13.7	
	½	77.97	3.86	20.2	½	32.53	2.36	13.8	
	⅞	68.80	3.39	20.3	⅞	28.80	2.07	13.9	
	1	112.85	6.52	17.3	¾	24.96	1.78	14.0	
	1½	106.67	6.13	17.4	¾	52.05	4.04	12.9	
	¾	100.48	5.75	17.5	1¾	48.85	3.76	13.0	
	1¾	94.08	5.36	17.6	¾	45.65	3.49	13.1	
7 x 3½	1½	87.68	4.97	17.6	1½	42.35	3.21	13.2	
	⅝	81.07	4.58	17.7	⅝	38.93	2.93	13.3	
	⅞	74.35	4.18	17.8	⅞	35.41	2.64	13.4	
	½	67.52	3.77	17.9	½	31.89	2.36	13.5	
	1½	60.59	3.37	18.0	1½	28.16	2.07	13.6	
	⅝	53.44	2.96	18.1	⅝	24.43	1.79	13.7	
	⅞	46.19	2.54	18.2	⅞	20.69	1.51	13.7	
	1	85.55	5.56	15.4	1¾	47.47	3.77	12.6	
	1½	80.96	5.22	15.5	¾	44.37	3.49	12.7	
	¾	76.27	4.89	15.6	1½	41.17	3.22	12.8	
6 x 4	1¾	71.47	4.55	15.7	¾	37.87	2.94	12.9	
	⅝	66.67	4.22	15.8	⅞	34.45	2.65	13.0	
	⅞	61.65	3.88	15.9	½	31.04	2.37	13.1	
	½	56.64	3.54	16.0	⅞	27.52	2.09	13.2	
	1½	51.52	3.20	16.1	¾	23.89	1.80	13.3	
	⅝	46.19	2.85	16.2	⅞	20.16	1.51	13.4	
	⅞	40.85	2.51	16.3					
	½	35.41	2.16	16.4					

BEAM SAFE LOADS

UNEQUAL ANGLES

ALLOWABLE UNIFORM LOAD IN THOUSANDS OF POUNDS

Neutral Axis Parallel to Shorter Leg

Maximum Bending Stress, 16,000 Pounds per Square Inch

Size, Inches	Thick-ness, Inches	1 Foot Span			Size, Inches	Thick-ness, Inches	1 Foot Span			
		Safe Load	Safe Load	Length, Feet			Safe Load	Safe Load	Length, Feet	
4½ x 3	1½	38.61	3.36	11.5	3 x 2½	¾	12.27	1.53	8.0	
	¾	36.05	3.11	11.6		½	11.09	1.37	8.1	
	11/16	33.49	2.87	11.7		⅜	9.92	1.22	8.1	
	5/8	30.83	2.62	11.8		3/8	8.64	1.06	8.2	
	9/16	28.16	2.38	11.8		5/16	7.36	0.89	8.3	
	½	25.28	2.13	11.9		¼	5.97	0.71	8.4	
	7/16	22.40	1.87	12.0		3 x 2	½	10.67	1.39	7.7
	3/8	19.52	1.61	12.1			7/16	9.49	1.22	7.8
	5/16	16.43	1.35	12.2			9/16	8.32	1.05	7.9
	4 x 3½	1½	31.15	2.94			10.6	5/16	7.04	0.88
¾		29.33	2.74	10.7	¼		5.76	0.71	8.1	
11/16		27.31	2.52	10.8	2½ x 2		½	7.47	1.15	6.5
5/8		25.07	2.30	10.9		7/16	6.72	1.02	6.6	
9/16		22.93	2.08	11.0		3/8	5.87	0.88	6.7	
½		20.59	1.86	11.1		5/16	5.01	0.74	6.8	
7/16		18.35	1.64	11.2		¼	4.05	0.59	6.9	
3/8		16.00	1.41	11.3		5/16	3.09	0.44	7.0	
4 x 3		5/16	13.44	1.18	11.4	1/8	2.13	0.30	7.1	
		1½	30.61	2.97	10.3	2½ x 1½	5/16	4.69	0.73	6.4
	¾	28.59	2.75	10.4	¼		3.84	0.59	6.5	
	11/16	26.56	2.53	10.5	5/16		2.99	0.45	6.6	
	5/8	24.53	2.31	10.6	2¼ x 1½		½	5.76	1.02	5.6
	9/16	22.40	2.09	10.7			7/16	5.12	0.90	5.7
	½	20.16	1.87	10.8			3/8	4.48	0.77	5.8
	7/16	17.92	1.64	10.9		5/16	3.84	0.65	5.9	
	3/8	15.57	1.42	11.0		¼	3.20	0.53	6.0	
	5/16	13.12	1.19	11.0		5/16	2.45	0.40	6.0	
3½ x 3	¾	10.67	0.96	11.1	2 x 1½	3/8	3.63	0.70	5.2	
	1½	23.47	2.57	9.1		5/16	3.09	0.58	5.3	
	¾	21.87	2.38	9.2		3/8	2.56	0.47	5.4	
	11/16	20.37	2.19	9.3		5/16	1.92	0.35	5.5	
	5/8	18.77	2.00	9.4		3/8	1.33	0.24	5.6	
	9/16	17.17	1.81	9.5		2 x 1¼	¼	2.44	0.47	5.2
	½	15.47	1.62	9.5	5/16		1.89	0.36	5.3	
	7/16	13.76	1.43	9.6	1½ x 1½		¼	1.88	0.41	4.6
	3/8	12.05	1.24	9.7			5/16	1.46	0.31	4.7
	5/16	10.24	1.05	9.8			3/8	1.00	0.21	4.8
3/8	8.32	0.84	9.9	1½ x 1¼			5/16	1.71	0.44	3.9
3½ x 2½	11/16	19.73	2.19			9.0	¼	1.39	0.35	4.0
	5/8	18.24	2.00			9.1	5/16	1.08	0.26	4.1
	9/16	16.64	1.82		9.1	1½ x 1¼	5/16	1.71	0.44	3.9
	7/16	15.04	1.63		9.2		¼	1.39	0.35	4.0
	½	13.44	1.44		9.3		5/16	1.08	0.26	4.1
	3/8	11.73	1.24	9.4	1½ x 1¼		5/16	1.71	0.44	3.9
5/16	9.92	1.04	9.5	¼			1.39	0.35	4.0	
¼	8.00	0.83	9.6	5/16			1.08	0.26	4.1	

CARNEGIE STEEL COMPANY

UNEQUAL ANGLES

ALLOWABLE UNIFORM LOAD IN THOUSANDS OF POUNDS

Neutral Axis Parallel to Longer Leg

Maximum Bending Stress, 16,000 Pounds per Square Inch

Size, Inches	Thick-ness, Inches	1 Foot Span		Maximum Span 360x Deflection		Size, Inches	Thick-ness, Inches	1 Foot Span		Maximum Span 360x Deflection	
		Safe Load	Safe Load	Length, Feet	Length, Feet			Safe Load	Safe Load	Length, Feet	Length, Feet
8 x 6	1	95.15	5.44	17.5	6 x 3½	1	30.93	3.09	10.0		
	15/16	89.92	5.11	17.6		15/16	29.23	2.90	10.1		
	7/8	84.69	4.79	17.7		7/8	27.63	2.71	10.2		
	13/16	79.36	4.45	17.8		13/16	25.92	2.52	10.3		
	3/4	73.92	4.13	17.9		3/4	24.21	2.33	10.4		
	11/16	68.37	3.80	18.0		11/16	22.51	2.14	10.5		
	5/8	62.72	3.48	18.0		5/8	20.69	1.95	10.6		
	9/16	56.96	3.15	18.1		9/16	18.88	1.76	10.7		
	1/2	51.09	2.81	18.2		1/2	16.96	1.57	10.8		
	7/16	45.12	2.47	18.3		7/16	15.04	1.38	10.9		
8 x 3½	1	32.21	3.10	10.4	5 x 4	5/8	13.12	1.19	11.0		
	15/16	30.40	2.90	10.5		15/16	11.09	1.00	11.1		
	7/8	28.69	2.71	10.6		7/8	35.31	3.15	11.2		
	13/16	26.88	2.52	10.7		13/16	33.17	2.93	11.3		
	3/4	25.07	2.33	10.8		3/4	30.93	2.71	11.4		
	11/16	23.15	2.13	10.9		11/16	28.69	2.50	11.5		
	5/8	21.33	1.94	11.0		5/8	26.45	2.28	11.6		
	9/16	19.41	1.74	11.1		9/16	24.11	2.16	11.7		
	1/2	17.49	1.57	11.2		1/2	21.76	1.84	11.8		
	7/16	15.57	1.38	11.3		7/16	19.31	1.62	11.9		
7 x 3½	1	31.57	3.10	10.2	5 x 3½	3/8	16.75	1.40	12.0		
	15/16	29.87	2.90	10.3		3/8	26.88	2.71	9.9		
	7/8	28.16	2.71	10.4		7/8	25.28	2.53	10.0		
	13/16	26.45	2.52	10.5		13/16	23.68	2.34	10.1		
	3/4	24.64	2.33	10.6		3/4	21.97	2.15	10.2		
	11/16	22.83	2.14	10.7		11/16	20.27	1.97	10.3		
	5/8	21.01	1.95	10.8		5/8	18.45	1.78	10.4		
	9/16	19.20	1.76	10.9		9/16	16.64	1.60	10.4		
	1/2	17.28	1.57	11.0		1/2	14.83	1.41	10.5		
	7/16	15.36	1.38	11.1		7/16	12.91	1.22	10.6		
6 x 4	3/8	13.44	1.19	11.2	5 x 3	5/16	10.88	1.02	10.7		
	1	40.43	3.55	11.4		15/16	18.56	2.16	8.6		
	15/16	38.29	3.33	11.5		3/4	17.39	2.00	8.7		
	7/8	36.16	3.12	11.6		11/16	16.11	1.83	8.8		
	13/16	33.92	2.90	11.7		5/8	14.83	1.67	8.9		
	3/4	31.68	2.69	11.8		9/16	13.55	1.51	9.0		
	11/16	29.44	2.47	11.9		1/2	12.27	1.35	9.1		
	5/8	27.09	2.26	12.0		7/16	10.88	1.18	9.2		
	9/16	24.64	2.05	12.0		3/8	9.49	1.02	9.3		
	1/2	22.19	1.84	12.1		5/16	8.00	0.85	9.4		
7/16	19.73	1.62	12.2								
3/8	17.07	1.39	12.3								

BEAM SAFE LOADS

UNEQUAL ANGLES

ALLOWABLE UNIFORM LOAD IN THOUSANDS OF POUNDS

Neutral Axis Parallel to Longer Leg

Maximum Bending Stress, 16,000 Pounds per Square Inch

Size, Inches	Thick-ness, Inches	1 Foot Span			Maximum Span 360x Deflection			Size, Inches	Thick-ness, Inches	1 Foot Span			Maximum Span 360x Deflection		
		Safe Load	Safe Load	Length, Feet	Safe Load	Safe Load	Length, Feet			Safe Load	Safe Load	Length, Feet	Safe Load	Safe Load	Length, Feet
4 1/2 x 3	1 9/16	18.24	2.15	8.5	3 x 2 1/2	9/16	8.75	1.25	7.0	3 x 2	1/2	5.01	0.88	5.7	
	3/4	17.07	1.99	8.6		5/8	7.89	1.12	7.0		7/16	4.48	0.77	5.8	
	1 1/16	15.89	1.83	8.7		3/8	7.04	0.99	7.1		9/16	3.95	0.67	5.9	
	5/8	14.61	1.67	8.8		5/16	6.19	0.85	7.2		3/4	3.41	0.57	6.0	
	9/16	13.33	1.51	8.8		1/4	5.23	0.72	7.3		1/2	2.77	0.46	6.1	
	1/2	12.05	1.35	8.9		2 1/2 x 2	1/2	4.91	0.89		5.5	5/8	4.37	0.78	5.6
	7/16	10.77	1.19	9.0			3/8	4.37	0.78		5.6	1/4	3.84	0.67	5.7
	3/8	9.39	1.03	9.1			5/16	3.31	0.57		5.8	3/8	3.84	0.67	5.7
	9/16	8.00	0.87	9.2			1/4	2.67	0.46		5.9	5/16	3.31	0.57	5.8
	4 x 3 1/2	1 9/16	24.53	2.56			9.6	3/8	2.67		0.46	5.9	1/2	2.13	0.35
3/4		22.93	2.37	9.7	5/16		2.13	0.35	6.0	3/8	1.44	0.24	6.1		
1 1/16		21.33	2.18	9.8	1/4		1.44	0.24	6.1	1/2	1.81	0.41	4.4		
5/8		19.63	1.98	9.9	2 3/4 x 1 1/2		5/16	1.81	0.41	4.4	1/4	1.49	0.33	4.5	
9/16		17.92	1.79	10.0			3/8	1.49	0.33	4.5	5/16	1.17	0.25	4.6	
1/2		16.21	1.60	10.1			1/2	1.17	0.25	4.6	1/2	2.77	0.67	4.1	
7/16		14.40	1.41	10.2		3/8	2.77	0.67	4.2	7/16	2.45	0.58	4.2		
3/8		12.59	1.22	10.3		5/16	2.13	0.50	4.3	3/8	2.13	0.50	4.3		
9/16		10.67	1.03	10.4		1/4	1.49	0.33	4.5	5/16	1.81	0.41	4.4		
4 x 3		1 9/16	17.92	2.15		8.3	3/8	1.49	0.33	4.5	1/2	2.77	0.67	4.1	
	3/4	16.75	1.99	8.4		5/16	1.17	0.25	4.6	7/16	2.45	0.58	4.2		
	1 1/16	15.57	1.83	8.5		1/4	1.17	0.25	4.6	3/8	2.13	0.50	4.3		
	5/8	14.40	1.67	8.6		5/16	1.81	0.41	4.4	1/4	1.49	0.33	4.5		
	9/16	13.12	1.51	8.7	3/8	1.49	0.33	4.5	5/16	1.17	0.25	4.6			
	1/2	11.84	1.35	8.8	2 1/4 x 1 1/2	1/4	1.49	0.33	4.5	1/2	2.77	0.67	4.1		
	7/16	10.56	1.19	8.9		3/8	1.17	0.25	4.6	7/16	2.45	0.58	4.2		
	3/8	9.28	1.03	8.9		5/16	1.81	0.41	4.4	3/8	2.13	0.50	4.3		
	9/16	7.89	0.87	9.0		1/4	1.49	0.33	4.5	5/16	1.81	0.41	4.4		
	1/4	6.40	0.70	9.1		3/8	1.17	0.25	4.6	1/4	1.49	0.33	4.5		
3 1/2 x 3	1 9/16	17.60	2.17	8.1		5/16	1.17	0.25	4.6	1/2	2.77	0.67	4.1		
	3/4	16.43	2.01	8.2		2 x 1 1/2	1/2	2.77	0.67	4.1	7/16	2.45	0.58	4.2	
	1 1/16	15.36	1.85	8.3			3/8	2.13	0.50	4.3	3/8	2.13	0.50	4.3	
	5/8	14.19	1.69	8.4			5/16	1.81	0.42	4.3	1/4	1.49	0.34	4.4	
	9/16	12.91	1.52	8.5			1/4	1.49	0.34	4.4	5/16	1.17	0.26	4.5	
	1/2	11.73	1.36	8.6	3/8		1.17	0.26	4.5	1/2	2.77	0.67	4.1		
	7/16	10.45	1.20	8.7	2 x 1 1/4		1/2	2.77	0.67	4.1	7/16	2.45	0.58	4.2	
	3/8	9.07	1.04	8.7			3/8	2.13	0.50	4.3	3/8	2.13	0.50	4.3	
	9/16	7.68	0.87	8.8			5/16	1.81	0.42	4.3	1/4	1.49	0.34	4.4	
	1/4	6.19	0.70	8.9			1/4	1.49	0.33	4.5	5/16	1.17	0.26	4.5	
3 1/2 x 2 1/2	1 1/16	10.56	1.51	7.0			3/8	1.17	0.25	4.6	1/2	2.77	0.67	4.1	
	5/8	9.81	1.39	7.1		1 3/4 x 1 1/4	1/2	2.77	0.67	4.1	7/16	2.45	0.58	4.2	
	9/16	8.96	1.26	7.1			3/8	2.13	0.50	4.3	3/8	2.13	0.50	4.3	
	1/2	8.11	1.13	7.2			5/16	1.81	0.42	4.3	1/4	1.49	0.34	4.4	
	7/16	7.25	0.99	7.3			1/4	1.49	0.33	4.5	5/16	1.17	0.26	4.5	
	3/8	6.29	0.85	7.4			1 1/2 x 1 1/4	1/2	2.77	0.67	4.1	7/16	2.45	0.58	4.2
	9/16	5.33	0.71	7.5	3/8			2.13	0.50	4.3	3/8	2.13	0.50	4.3	
	1/4	4.37	0.58	7.6	5/16			1.81	0.42	4.3	1/4	1.49	0.34	4.4	
	3 1/2 x 2 1/2	1 1/16	10.56	1.51	7.0			1/4	1.49	0.33	4.5	5/16	1.17	0.26	4.5
		5/8	9.81	1.39	7.1			1 1/2 x 1 1/4	1/2	2.77	0.67	4.1	7/16	2.45	0.58
9/16		8.96	1.26	7.1	3/8				2.13	0.50	4.3	3/8	2.13	0.50	4.3
1/2		8.11	1.13	7.2	5/16	1.81			0.42	4.3	1/4	1.49	0.34	4.4	
7/16		7.25	0.99	7.3	1/4	1.49			0.33	4.5	5/16	1.17	0.26	4.5	
3/8		6.29	0.85	7.4	1 1/2 x 1 1/4	1/2			2.77	0.67	4.1	7/16	2.45	0.58	4.2
9/16		5.33	0.71	7.5		3/8			2.13	0.50	4.3	3/8	2.13	0.50	4.3
1/4		4.37	0.58	7.6		5/16	1.81		0.42	4.3	1/4	1.49	0.34	4.4	

CARNEGIE STEEL COMPANY

TEES

ALLOWABLE UNIFORM LOAD IN THOUSANDS OF POUNDS

Neutral Axis Parallel to Flange

Maximum Bending Stress, 16,000 Pounds per Square Inch

EQUAL TEES

Size		Weight per Foot, Pounds	1 Foot Span			Size		Weight per Foot, Pounds	1 Foot Span		
Flange, Inches	Stem, Inches		Safe Load	Safe Load	Length, Feet	Flange, Inches	Stem, Inches		Safe Load	Safe Load	Length, Feet
		Maximum Span 360 x Deflection						Maximum Span 360 x Deflection			
6½	6½	19.8	52.80	2.77	19.1	2¼	2¼	4.9	4.37	0.69	6.3
4	4	13.5	21.55	1.90	11.4	2¼	2¼	4.1	3.41	0.53	6.4
4	4	10.5	16.85	1.46	11.6	2	2	4.3	3.31	0.59	5.6
3½	3½	11.7	16.32	1.65	9.9	2	2	3.56	2.77	0.49	5.7
3½	3½	9.2	12.69	1.27	10.0	1¾	1¾	3.09	2.03	0.42	4.9
3	3	9.9	11.73	1.41	8.3	1¾	1¾	2.47	1.53	0.37	4.1
3	3	8.9	10.45	1.24	8.4	1½	1½	1.94	1.15	0.27	4.3
3	3	7.8	9.17	1.07	8.5	1½	1½	2.02	1.01	0.30	3.4
3	3	6.7	7.89	0.92	8.6	1½	1½	1.59	0.78	0.22	3.5
2½	2½	6.4	6.29	0.90	7.0	1	1	1.25	0.49	0.18	2.7
2½	2½	5.5	5.33	0.75	7.1	1	1	0.89	0.35	0.12	2.9

UNEQUAL TEES

Size		Weight per Foot, Pounds	1 Foot Span			Size		Weight per Foot, Pounds	1 Foot Span		
Flange, Inches	Stem, Inches		Safe Load	Safe Load	Length, Feet	Flange, Inches	Stem, Inches		Safe Load	Safe Load	Length, Feet
		Maximum Span 360 x Deflection						Maximum Span 360 x Deflection			
5	3	11.5	11.33	1.25	9.0	3½	3	10.8	12.05	1.41	8.5
5	2½	10.9	8.96	1.11	7.5	3½	3	8.5	9.49	1.09	8.7
4½	3½	15.7	22.72	2.36	9.6	3½	3	7.5	9.07	1.05	8.7
4½	3	9.8	9.71	1.07	9.1	3	4	11.7	20.69	1.92	10.8
4½	3	8.4	8.32	0.90	9.2	3	4	10.5	18.35	1.68	10.9
4½	2½	9.2	6.72	0.87	7.7	3	4	9.2	16.11	1.47	11.0
4½	2½	7.8	5.76	0.74	7.8	3	3½	10.8	15.89	1.66	9.6
4	5	15.3	33.39	2.41	13.9	3	3½	9.7	14.19	1.47	9.7
4	5	11.9	25.92	1.84	14.1	3	3½	8.5	12.37	1.26	9.8
4	4½	14.4	27.09	2.15	12.6	3	2½	7.1	6.40	0.89	7.2
4	4½	11.2	21.12	1.64	12.8	3	2½	6.1	5.55	0.76	7.3
4	3	9.2	9.60	1.07	8.9	2½	3	7.1	8.96	1.09	8.3
4	3	7.8	8.21	0.91	9.1	2½	3	6.1	7.68	0.92	8.4
4	2½	8.5	6.61	0.87	7.6	2½	1½	2.87	0.93	0.25	3.7
4	2½	7.2	5.65	0.74	7.7	2	1½	3.09	1.58	0.36	4.4
4	2	7.8	4.27	0.70	6.1	1½	2	2.45	2.03	0.38	5.5
4	2	6.7	3.63	0.59	6.2	1½	1½	1.25	0.57	0.15	3.7
3½	4	12.6	21.12	1.90	11.1	1½	¾	0.88	0.14	0.08	1.9
3½	4	9.8	16.53	1.46	11.3						

BEAM SAFE LOADS

ZEES

ALLOWABLE UNIFORM LOAD IN THOUSANDS OF POUNDS

Neutral Axis Parallel to Flanges

Maximum Bending Stress, 16,000 Pounds per Square Inch

Depth, Inches	Size		Weight per Foot, Pounds	1 Foot Span	Maximum Span 360 x Deflection	
	Flanges, Inches	Thickness, Inches		Safe Load	Safe Load	Length, Feet
6½	3¾	¾	34.6	174.93	14.18	12.3
6½	3⅞	11/16	32.0	162.35	13.30	12.2
6	3½	¾	29.4	149.76	12.40	12.1
6½	3¾	11/16	28.1	150.40	12.19	12.3
6½	3⅞	¾	25.4	136.75	11.20	12.2
6	3½	11/16	22.8	123.20	10.20	12.1
6½	3¾	½	21.1	119.68	9.70	12.3
6½	3⅞	7/16	18.4	104.85	8.59	12.2
6	3½	¾	15.7	90.03	7.45	12.1
5½	3¾	11/16	28.4	119.47	11.58	10.3
5½	3⅞	¾	26.0	110.29	10.82	10.2
5	3¼	11/16	23.7	101.01	10.03	10.1
5½	3¾	¾	22.6	102.08	9.89	10.3
5½	3⅞	11/16	20.2	91.95	9.02	10.2
5	3¼	½	17.9	81.92	8.14	10.1
5½	3¾	7/16	16.4	79.36	7.69	10.3
5½	3⅞	¾	14.0	68.16	6.69	10.2
5	3¼	11/16	11.6	56.96	5.66	10.1
4½	3⅞	¾	23.0	77.44	9.32	8.3
4½	3¾	11/16	20.9	70.93	8.67	8.2
4	3⅞	¾	18.9	64.53	8.01	8.1
4½	3⅞	11/16	18.0	65.92	7.93	8.3
4½	3¾	½	15.9	58.67	7.17	8.2
4	3⅞	7/16	13.8	51.52	6.40	8.1
4½	3⅞	¾	12.5	49.81	6.00	8.3
4½	3¾	11/16	10.3	41.71	5.10	8.2
4	3⅞	½	8.2	33.49	4.16	8.1
3½	2¾	11/16	14.3	36.59	5.93	6.2
3	2½	½	12.6	32.64	5.40	6.1
3½	2¾	7/16	11.5	31.79	5.15	6.2
3	2½	¾	9.8	27.41	4.54	6.1
3½	2¾	11/16	8.5	25.39	4.12	6.2
3	2½	½	6.7	20.48	3.39	6.1

STANDARD GAGES AND DIMENSIONS FOR BEAMS

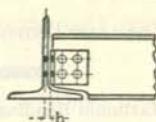
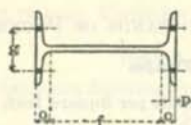

Nominal dimensions are:—flange width and "o" in eighths, web thickness in sixteenths. Gages for connection angles are determined by 1/2 web thickness. Standard gages may be varied if conditions require.

Depth of Beam	Weight per Foot	Flange Width	Web Thickness	1/2 Web Thickness	Gage g	Grip p	Distance			Max. Rivet in Flange
							f	o	h	
In.	Lbs.	In.	In.	In.	In.	In.	In.	In.	In.	
27	90.0	9	1/2	1/4	5	3/4	22 1/2	2 1/4	5/16	3/8
24	120.0	8	13/16	3/8	5	1 1/8	20 1/4	1 7/8	1/2	3/8
	115.0	8	3/4	3/8	5	1 1/8	20 1/4	1 7/8	7/16	
	110.0	7 7/8	11/16	5/16	5	1 1/8	20 1/4	1 7/8	7/16	
	105.9	7 7/8	3/4	5/16	5	1 1/8	20 1/4	1 7/8	3/8	
24	100.0	7 1/4	3/4	3/8	4	7/8	20 3/4	1 5/8	7/16	3/8
	95.0	7 3/8	11/16	5/16	4	7/8	20 3/4	1 5/8	7/16	
	90.0	7 3/8	5/8	5/16	4	7/8	20 3/4	1 5/8	3/8	
	85.0	7 3/8	9/16	5/16	4	7/8	20 3/4	1 5/8	3/8	
	79.9	7	1/2	1/4	4	7/8	20 3/4	1 5/8	5/16	
24	74.2	9	3/2	1/4	4	5/8	20	2	5/16	7/8
21	60.4	8 1/4	7/16	5/16	4	9/16	17 1/2	1 3/4	1/4	7/8
20	100.0	7 3/4	7/8	7/16	4	1	16 1/2	1 3/4	1/2	7/8
	95.0	7 3/4	13/16	3/8	4	1	16 1/2	1 3/4	1/2	
	90.0	7 3/8	3/4	3/8	4	1	16 1/2	1 3/4	7/16	
	85.0	7	5/8	5/16	4	1	16 1/2	1 3/4	3/8	
	81.4	7	5/8	5/16	4	1	16 1/2	1 3/4	3/8	
20	75.0	6 3/8	5/8	5/16	4	3/4	17	1 1/2	3/8	7/8
	70.0	6 3/8	9/16	5/16	4	3/4	17	1 1/2	5/8	
	65.4	6 1/4	1/2	1/4	4	3/4	17	1 1/2	5/16	
18	90.0	7 3/4	13/16	3/8	4	1	14 1/2	1 3/4	1/2	7/8
	85.0	7 3/8	11/16	3/8	4	1	14 1/2	1 3/4	7/16	
	80.0	7 3/8	3/4	5/16	4	1	14 1/2	1 3/4	3/8	
	75.6	7	5/16	1/4	4	1	14 1/2	1 3/4	3/8	
18	70.0	6 1/4	11/16	3/8	3 3/4	3/4	15 1/4	1 3/8	7/16	7/8
	65.0	6 1/8	5/8	5/16	3 3/4	3/4	15 1/4	1 3/8	3/8	
	60.0	6 3/8	9/16	1/4	3 3/4	3/4	15 1/4	1 3/8	3/8	
	54.7	6	7/16	1/4	3 3/4	3/4	15 1/4	1 3/8	5/16	
18	48.2	7 1/2	3/8	5/16	3 3/4	1/2	14 3/4	1 5/8	1/4	3/8
15	75.0	6 1/4	7/8	7/16	3 1/2	7/8	11 3/4	1 5/8	1/2	3/4
	70.0	6 1/8	3/4	3/8	3 1/2	7/8	11 3/4	1 5/8	7/16	
	65.0	6 3/8	11/16	5/16	3 1/2	7/8	11 3/4	1 5/8	7/16	
	60.8	6	5/16	5/16	3 1/2	7/8	11 3/4	1 5/8	3/8	
15	55.0	5 3/4	5/8	5/16	3 1/2	5/8	12 1/2	1 1/4	3/8	3/4
	50.0	5 5/8	9/16	1/4	3 1/2	5/8	12 1/2	1 1/4	3/8	
	45.0	5 1/2	7/16	1/4	3 1/2	5/8	12 1/2	1 1/4	5/16	
	42.9	5 1/2	7/16	5/16	3 1/2	5/8	12 1/2	1 1/4	1/4	
15	37.3	6 3/4	5/16	5/16	3 1/2	7/16	12 3/4	1 3/8	1/4	3/4

STRUCTURAL DETAILS

STANDARD GAGES AND DIMENSIONS FOR BEAMS

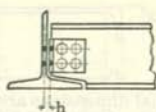
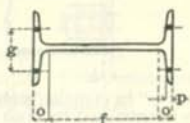

Nominal dimensions are:—flange width and "o" in eighths, web thickness in sixteenths. Gages for connection angles are determined by $\frac{1}{2}$ web thickness. Standard gages may be varied if conditions require.

Depth of Beam	Weight per Foot	Flange Width	Web Thickness	$\frac{1}{2}$ Web Thickness	Gage g	Grip p	Distance			Max. Rivet in Flange
							f	o	h	
In.	Lbs.	In.	In.	In.	In.	In.	In.	In.	In.	
12	55.0	5 $\frac{3}{8}$	1 $\frac{1}{16}$	$\frac{3}{8}$	3 $\frac{1}{2}$	$\frac{3}{4}$	9 $\frac{1}{4}$	1 $\frac{3}{8}$	$\frac{1}{2}$	
	50.0	5 $\frac{1}{2}$	1 $\frac{1}{16}$	$\frac{3}{16}$	3 $\frac{1}{2}$	$\frac{3}{4}$	9 $\frac{1}{4}$	1 $\frac{3}{8}$	$\frac{7}{16}$	
	45.0	5 $\frac{3}{8}$	$\frac{9}{16}$	$\frac{7}{16}$	3	$\frac{3}{4}$	9 $\frac{1}{4}$	1 $\frac{3}{8}$	$\frac{3}{8}$	$\frac{3}{4}$
	40.8	5 $\frac{1}{4}$	$\frac{7}{16}$	$\frac{1}{4}$	3	$\frac{3}{4}$	9 $\frac{1}{4}$	1 $\frac{3}{8}$	$\frac{5}{16}$	
12	35.0	5 $\frac{1}{8}$	$\frac{7}{16}$	$\frac{9}{16}$	3	$\frac{9}{16}$	9 $\frac{3}{4}$	1 $\frac{1}{8}$	$\frac{5}{16}$	$\frac{3}{4}$
	31.8	5	$\frac{5}{8}$	$\frac{9}{16}$	3	$\frac{9}{16}$	9 $\frac{3}{4}$	1 $\frac{1}{8}$	$\frac{1}{4}$	$\frac{3}{4}$
12	27.9	6	$\frac{9}{16}$	$\frac{1}{8}$	3	$\frac{7}{16}$	9 $\frac{1}{2}$	1 $\frac{1}{4}$	$\frac{9}{16}$	$\frac{3}{4}$
10	40.0	5 $\frac{1}{8}$	$\frac{3}{4}$	$\frac{3}{8}$	2 $\frac{3}{4}$	$\frac{1}{2}$	8	1	$\frac{7}{16}$	
	35.0	5	$\frac{5}{8}$	$\frac{7}{16}$	2 $\frac{3}{4}$	$\frac{1}{2}$	8	1	$\frac{5}{8}$	$\frac{3}{4}$
	30.0	4 $\frac{3}{4}$	$\frac{7}{16}$	$\frac{1}{4}$	2 $\frac{3}{4}$	$\frac{1}{2}$	8	1	$\frac{5}{16}$	
	25.4	4 $\frac{5}{8}$	$\frac{5}{16}$	$\frac{1}{8}$	2 $\frac{3}{4}$	$\frac{1}{2}$	8	1	$\frac{1}{4}$	
10	22.4	5 $\frac{1}{2}$	$\frac{1}{4}$	$\frac{1}{8}$	2 $\frac{3}{4}$	$\frac{3}{8}$	7 $\frac{3}{4}$	1 $\frac{1}{8}$	$\frac{9}{16}$	$\frac{3}{4}$
9	35.0	4 $\frac{3}{4}$	$\frac{3}{4}$	$\frac{3}{8}$	2 $\frac{1}{2}$	$\frac{1}{2}$	7	1	$\frac{7}{16}$	
	30.0	4 $\frac{5}{8}$	$\frac{9}{16}$	$\frac{1}{4}$	2 $\frac{1}{2}$	$\frac{1}{2}$	7	1	$\frac{3}{8}$	$\frac{3}{4}$
	25.0	4 $\frac{1}{2}$	$\frac{5}{8}$	$\frac{7}{16}$	2 $\frac{1}{2}$	$\frac{1}{2}$	7	1	$\frac{1}{4}$	
	21.8	4 $\frac{3}{8}$	$\frac{5}{16}$	$\frac{1}{8}$	2 $\frac{1}{2}$	$\frac{1}{2}$	7	1	$\frac{7}{16}$	
8	25.5	4 $\frac{1}{4}$	$\frac{9}{16}$	$\frac{1}{4}$	2 $\frac{1}{4}$	$\frac{1}{2}$	6 $\frac{1}{4}$	$\frac{7}{8}$	$\frac{5}{16}$	
	23.0	4 $\frac{3}{8}$	$\frac{7}{16}$	$\frac{1}{4}$	2 $\frac{1}{4}$	$\frac{7}{16}$	6 $\frac{1}{4}$	$\frac{3}{8}$	$\frac{7}{16}$	$\frac{3}{4}$
	20.5	4 $\frac{1}{8}$	$\frac{5}{8}$	$\frac{9}{16}$	2 $\frac{1}{4}$	$\frac{7}{16}$	6 $\frac{1}{4}$	$\frac{3}{8}$	$\frac{1}{4}$	
	18.4	4	$\frac{1}{4}$	$\frac{1}{8}$	2 $\frac{1}{4}$	$\frac{7}{16}$	6 $\frac{1}{4}$	$\frac{7}{8}$	$\frac{7}{16}$	
8	17.5	5	$\frac{1}{4}$	$\frac{1}{8}$	2 $\frac{1}{4}$	$\frac{3}{8}$	6	1	$\frac{9}{16}$	$\frac{3}{4}$
7	20.0	3 $\frac{7}{8}$	$\frac{7}{16}$	$\frac{1}{4}$	2 $\frac{1}{4}$	$\frac{3}{8}$	5 $\frac{1}{4}$	$\frac{7}{8}$	$\frac{5}{16}$	
	17.5	3 $\frac{5}{8}$	$\frac{5}{8}$	$\frac{9}{16}$	2 $\frac{1}{4}$	$\frac{3}{8}$	5 $\frac{1}{4}$	$\frac{3}{8}$	$\frac{1}{4}$	$\frac{5}{8}$
	15.3	3 $\frac{3}{8}$	$\frac{1}{4}$	$\frac{1}{8}$	2 $\frac{1}{4}$	$\frac{3}{8}$	5 $\frac{1}{4}$	$\frac{3}{8}$	$\frac{7}{16}$	
6	17.25	3 $\frac{3}{8}$	$\frac{7}{16}$	$\frac{1}{4}$	2	$\frac{3}{8}$	4 $\frac{1}{2}$	$\frac{3}{4}$	$\frac{5}{16}$	
	14.75	3 $\frac{1}{2}$	$\frac{3}{8}$	$\frac{9}{16}$	2	$\frac{3}{8}$	4 $\frac{1}{2}$	$\frac{3}{4}$	$\frac{1}{4}$	$\frac{5}{8}$
	12.5	3 $\frac{3}{8}$	$\frac{1}{4}$	$\frac{1}{8}$	2	$\frac{3}{8}$	4 $\frac{1}{2}$	$\frac{3}{4}$	$\frac{7}{16}$	
5	14.75	3 $\frac{3}{8}$	$\frac{1}{2}$	$\frac{1}{4}$	1 $\frac{3}{4}$	$\frac{3}{8}$	3 $\frac{1}{2}$	$\frac{3}{4}$	$\frac{5}{16}$	
	12.25	3 $\frac{1}{8}$	$\frac{5}{8}$	$\frac{9}{16}$	1 $\frac{3}{4}$	$\frac{3}{8}$	3 $\frac{1}{2}$	$\frac{3}{4}$	$\frac{1}{4}$	$\frac{1}{2}$
	10.0	3	$\frac{9}{16}$	$\frac{1}{8}$	1 $\frac{3}{4}$	$\frac{3}{8}$	3 $\frac{1}{2}$	$\frac{3}{4}$	$\frac{7}{16}$	
4	10.5	2 $\frac{7}{8}$	$\frac{5}{8}$	$\frac{9}{16}$	1 $\frac{1}{2}$	$\frac{5}{16}$	2 $\frac{3}{4}$	$\frac{5}{8}$	$\frac{1}{4}$	
	9.5	2 $\frac{3}{4}$	$\frac{9}{16}$	$\frac{7}{16}$	1 $\frac{1}{2}$	$\frac{5}{16}$	2 $\frac{3}{4}$	$\frac{5}{8}$	$\frac{1}{4}$	$\frac{1}{2}$
	8.5	2 $\frac{3}{4}$	$\frac{1}{4}$	$\frac{1}{8}$	1 $\frac{1}{2}$	$\frac{5}{16}$	2 $\frac{3}{4}$	$\frac{5}{8}$	$\frac{7}{16}$	
	7.7	2 $\frac{5}{8}$	$\frac{9}{16}$	$\frac{1}{8}$	1 $\frac{1}{2}$	$\frac{5}{16}$	2 $\frac{3}{4}$	$\frac{5}{8}$	$\frac{7}{16}$	
3	7.5	2 $\frac{1}{2}$	$\frac{3}{8}$	$\frac{9}{16}$	1 $\frac{1}{2}$	$\frac{5}{16}$	1 $\frac{3}{4}$	$\frac{5}{8}$	$\frac{1}{4}$	
	6.5	2 $\frac{3}{8}$	$\frac{1}{4}$	$\frac{1}{8}$	1 $\frac{1}{2}$	$\frac{5}{16}$	1 $\frac{3}{4}$	$\frac{5}{8}$	$\frac{7}{16}$	$\frac{3}{8}$
	5.7	2 $\frac{3}{8}$	$\frac{9}{16}$	$\frac{1}{16}$	1 $\frac{1}{2}$	$\frac{5}{16}$	1 $\frac{3}{4}$	$\frac{5}{8}$	$\frac{1}{8}$	

CARNEGIE STEEL COMPANY

STANDARD GAGES AND DIMENSIONS FOR CHANNELS

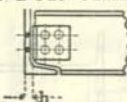
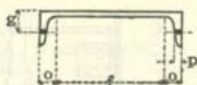

Nominal dimensions are:—flange width and "o" in eighths, web thickness in sixteenths. Gages for connection angles are determined by web thickness. Standard gages may be varied if conditions require. Gages for channels in riveted channel columns are given on pages 224 to 234

Depth of Channel	Weight per Foot	Flange Width	Web Thickness	1/2 Web Thickness	Gage g	Grip P	Distance			Max. Rivet in Flange
							f	o	h	
In.	Lbs.	In.	In.	In.	In.	In.	In.	In.	In.	
15	55.0	3 7/8	1 1/16	7/16	2 1/2	1 1/16	12 3/4	1 3/8	7/8	7/8
	50.0	3 3/4	1 1/16	3/8	2 1/2	1 1/16	12 3/4	1 3/8	1 3/16	
	45.0	3 3/8	5/8	5/16	2	5/8	12 3/4	1 3/8	1 3/16	
	40.0	3 1/2	1/2	1/4	2	5/8	12 3/4	1 3/8	9/16	
	35.0	3 7/16	7/16	5/16	2	5/8	12 3/4	1 3/8	1/2	
	33.9	3 3/8	3/8	9/16	2	5/8	12 3/4	1 3/8	1/2	
13	50.0	4 3/8	1 1/16	3/8	3	9/16	10 1/2	1 1/4	7/8	7/8
	45.0	4 1/4	1 1/16	5/16	2 3/4	9/16	10 1/2	1 1/4	3/4	
	40.0	4 1/8	9/16	1/4	2 3/4	9/16	10 1/2	1 1/4	5/8	
	37.0	4 1/8	1/2	1/4	2 1/2	9/16	10 1/2	1 1/4	9/16	
	35.0	4 1/8	7/16	1/4	2 1/2	9/16	10 1/2	1 1/4	1/2	
	31.8	4	3/8	9/16	2 1/2	9/16	10 1/2	1 1/4	7/16	
12	40.0	3 3/4	3/4	3/8	2	5/8	10	1	1 3/16	7/8
	35.0	3 3/4	5/8	5/16	2	5/8	10	1	1 1/16	
	30.0	3 3/8	1/2	1/4	1 3/4	1/2	10	1	9/16	
	25.0	3	3/8	9/16	1 3/4	1/2	10	1	7/16	
	20.7	3	1/4	3/8	1 3/4	1/2	10	1	3/8	
	35.0	3 3/8	1 1/16	7/16	1 3/4	1/2	8 1/4	7/8	7/8	
30.0	3	1 1/16	5/16	1 3/4	1/2	8 1/4	7/8	3/4		
25.0	2 7/8	1 1/2	1/4	1 3/4	1/2	8 1/4	7/8	9/16		
20.0	2 3/4	3/8	9/16	1 1/2	7/16	8 1/4	7/8	7/16		
15.3	2 1/8	1/4	3/8	1 1/2	7/16	8 1/4	7/8	5/16		
25.0	2 7/8	5/8	5/16	1 1/2	1/2	7 3/4	7/8	1 1/16	3/4	
20.0	2 5/8	7/16	1/4	1 1/2	1/2	7 3/4	7/8	1/2		
15.0	2 1/2	5/16	3/8	1 3/8	7/16	7 3/4	7/8	3/8		
13.4	2 3/8	1/4	3/8	1 3/8	7/16	7 3/4	7/8	5/16		
21.25	2 5/8	9/16	5/16	1 1/2	7/16	6 3/4	7/8	1 1/16		3/4
18.75	2 1/2	1 1/2	3/8	1 1/2	7/16	6 3/4	7/8	9/16		
16.25	2 3/8	3/8	5/16	1 1/2	7/16	6 3/4	7/8	1/2		
13.75	2 3/8	5/16	3/8	1 3/8	5/8	6 3/4	7/8	3/8		
11.5	2 1/4	1/4	3/8	1 3/8	5/8	6 3/4	7/8	5/16		
19.75	2 1/2	5/8	5/16	1 1/2	7/16	5 1/2	3/4	1 1/16	5/8	
17.25	2 3/8	1/2	1/4	1 1/2	7/16	5 1/2	3/4	9/16		
14.75	2 1/4	7/16	5/16	1 1/4	7/16	5 1/2	3/4	1/2		
12.25	2 1/4	5/16	9/16	1 1/4	5/8	5 1/2	3/4	3/8		
9.8	2 1/8	9/16	3/8	1 1/4	5/8	5 1/2	3/4	5/16		
15.5	2 1/4	9/16	1/4	1 3/8	3/8	4 1/2	3/4	5/8		5/8
13.0	2 3/8	7/16	1/4	1 3/8	3/8	4 1/2	3/4	1/2		
10.5	2	5/16	5/16	1 3/8	5/8	4 1/2	3/4	3/8		
8.2	1 7/8	5/16	3/8	1 3/8	5/16	4 1/2	3/4	3/4		
11.5	2	1/2	1/4	1 1/8	5/16	3 3/4	3/8	9/16	1/2	
9.0	1 7/8	5/16	5/16	1 1/8	5/16	3 3/4	3/8	3/8		
6.7	1 3/4	5/16	3/8	1 3/8	5/16	3 3/4	3/8	1/4		
7.25	1 3/4	5/16	5/16	1	5/16	2 3/4	3/8	3/8		
6.25	1 3/8	1/4	3/8	1	5/16	2 3/4	3/8	5/16		
5.4	1 3/8	9/16	1/16	1	5/16	2 3/4	3/8	1/4		
3	6.0	1 3/8	3/8	5/16	7/8	1/4	1 3/4	5/8	7/16	1/2
	5.0	1 1/2	1/4	3/8	7/8	1/4	1 3/4	5/8	5/16	
	4.1	1 1/8	5/16	1/16	7/8	1/4	1 3/4	5/8	1/4	

BEAM CONNECTIONS

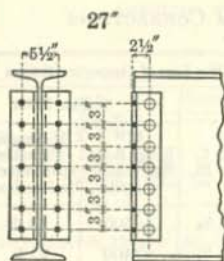

2 I₄ 4" x 4" x 1/2" x 1'-3 1/2"
Weight 46 lbs.

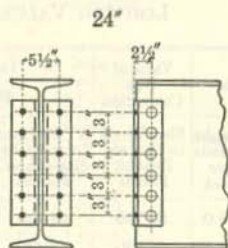

2 I₄ 4" x 4" x 1/2" x 1'-5 1/2"
Weight 39 lbs.

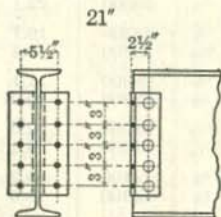

2 I₄ 4" x 4" x 1/2" x 1'-2 1/2"
Weight 33 lbs.

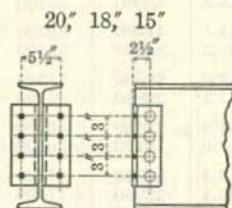

2 I₄ 4" x 4" x 1/4" x 0'-11 1/2"
Weight 23 lbs.

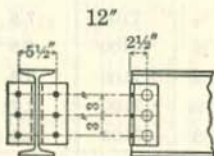

2 I₄ 4" x 4" x 1/8" x 0'-8 1/2"
Weight 17 lbs.

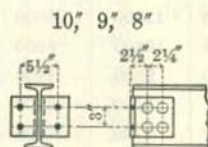

2 I₄ 6" x 4" x 3/8" x 0'-5 1/2"
Weight 13 lbs.

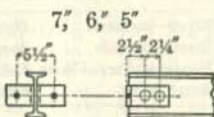

2 I₄ 6" x 4" x 3/8" x 0'-3"
Weight 7 lbs.

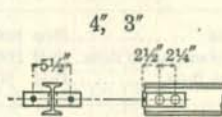

2 I₄ 6" x 4" x 3/8" x 0'-2"
Weight 5 lbs.

Rivets and bolts 3/4" diameter.

Weights given are for 3/4-inch shop rivets and angle connections; about 20 per cent should be added for field rivets or bolts.

BEAM CONNECTIONS—Concluded

LIMITING VALUES OF BEAM CONNECTIONS

I Beams		Value of Web Connection	Values of Outstanding Legs of Connection Angles					
Depth, Inches	Weight Pounds per Foot		Field Rivets			Field Bolts		
		Shop Rivets in Enclosed Bearing, Pounds	$\frac{3}{4}$ " Rivets or Turned Bolts, Single Shear, Pounds	Minimum Allowable Span in Feet, Uniform Load	t, In.	$\frac{3}{4}$ " Rough Bolts, Single Shear, Pounds	Minimum Allowable Span in Feet, Uniform Load	t, In.
27	90.0	82530	61900	18.9	$\frac{5}{8}$	49500	23.6	$\frac{5}{8}$
24	79.9	67500	53000	17.5	$\frac{5}{8}$	42400	21.9	$\frac{5}{8}$
	74.2	64260	53000	16.4	$\frac{5}{8}$	42400	20.4	$\frac{5}{8}$
21	60.4	48150	44200	14.2	$\frac{5}{8}$	35300	17.8	$\frac{5}{8}$
20	65.4	45000	35300	17.6	$\frac{5}{8}$	28300	22.1	$\frac{5}{8}$
18	54.7	41400	35300	13.3	$\frac{5}{8}$	28300	16.7	$\frac{5}{8}$
	48.2	34200	35300	12.8	$\frac{9}{16}$	28300	15.4	$\frac{5}{8}$
15	42.9	36900	35300	8.9	$\frac{5}{8}$	28300	11.1	$\frac{5}{8}$
	37.3	29880	35300	9.7	$\frac{1}{2}$	28300	10.2	$\frac{9}{16}$
12	31.8	23600	26500	8.1	$\frac{9}{16}$	21200	9.0	$\frac{5}{8}$
	27.9	19170	26500	9.2	$\frac{7}{16}$	21200	9.2	$\frac{1}{2}$
10	25.4	27900	17700	7.4	$\frac{5}{8}$	14100	9.2	$\frac{5}{8}$
	22.4	22680	17700	6.8	$\frac{5}{8}$	14100	8.6	$\frac{5}{8}$
9	21.8	26100	17700	5.7	$\frac{5}{8}$	14100	7.1	$\frac{5}{8}$
8	18.4	24300	17700	4.3	$\frac{5}{8}$	14100	5.4	$\frac{5}{8}$
	17.5	19800	17700	4.4	$\frac{5}{8}$	14100	5.5	$\frac{5}{8}$
7	15.3	11300	8800	6.2	$\frac{5}{8}$	7100	7.8	$\frac{5}{8}$
6	12.5	10400	8800	4.4	$\frac{5}{8}$	7100	5.5	$\frac{5}{8}$
5	10.0	9500	8800	2.9	$\frac{5}{8}$	7100	3.6	$\frac{5}{8}$
4	7.7	8600	8800	1.9	$\frac{9}{16}$	7100	2.7	$\frac{5}{8}$
3	5.7	7700	8800	1.2	$\frac{1}{2}$	7100	1.4	$\frac{5}{8}$

ALLOWABLE UNIT STRESS IN POUNDS PER SQUARE INCH

Single Shear	Rivets	Shop 12000	Bearing	Rivets—enclosed	Shop 30000
	Rivets and Turned Bolts	Field 10000		Rivets—one side	Shop 24000
	Rough Bolts	Field 8000		Rivets and Turned Bolts, Field	20000
				Rough Bolts	Field 16000

t=Web thickness, in bearing, to develop max. allowable reactions, when beams frame opposite. Connections are figured for bearing and shear (no moment considered).

The above values agree with tests made on beams under ordinary conditions of use.

Where web is enclosed between connection angles (enclosed bearing), values are greater because of the increased efficiency due to friction and grip.

Special connections shall be used when any of the limiting conditions given above are exceeded—such as end reaction from loaded beam being greater than value of connection; shorter span with beam fully loaded; or a less thickness of web when maximum allowable reactions are used.

STRUCTURAL DETAILS

BEAM SEPARATORS

AMERICAN BRIDGE COMPANY STANDARD

Depth, Inches	Beams		Separator						¾" Bolts			Diagrams	
	Weight per Foot, Pounds	Center to Center of Beams, Inches	Dimensions				Weight, Pounds	Increase in Weight for 1" Add. Width	Length, Inches	Weight, Pounds Hex. Head and Nut	Increase in Weight for 1" Add. Length		
			w In.	h In.	d In.	t In.							
24	120 to 105.9	8¾	16¾	8	20	12	¾	31	3.6	10½	3.4	0.25	<p>¾" Cored Holes</p>
	100	8	15½	7¼	20	12	¾	28	3.6	10	3.2	0.25	
24	95 and 90	8	15½	7¼	20	12	¾	28	3.6	10	3.2	0.25	
	85	8	15¾	7½	20	12	¾	29	3.6	9½	3.1	0.25	
	79.9	8	15	7½	20	12	¾	29	3.6	9½	3.1	0.25	
	100 and 95	8	15¾	7	16	12	¾	22	2.9	10	3.2	0.25	
20	90	7½	14¾	6¾	16	12	¾	22	2.9	9½	3.1	0.25	
	85 and 81.4	7½	14¾	6¾	16	12	¾	22	2.9	9	3.0	0.25	
	75	7½	14	6¾	16	12	¾	22	2.9	9	3.0	0.25	
20	70	7	13¾	6½	16	12	¾	21	2.9	9	3.0	0.25	
	65.4	7	13¾	6½	16	12	¾	21	2.9	8½	3.0	0.25	
	90	8	15¼	7	14	9	¾	20	2.5	10	3.2	0.25	
18	85 and 80	8	15¾	7¼	14	9	¾	21	2.5	10	3.2	0.25	
	75.6	8	15	7½	14	9	¾	21	2.5	10	3.2	0.25	
	70 and 65	7	13¾	6¼	14	9	¾	18	2.5	9	3.0	0.25	
18	60	7	13¾	6¼	14	9	¾	19	2.5	8½	3.0	0.25	
	54.7	7	13	6½	14	9	¾	19	2.5	8½	3.0	0.25	
	75	7	13¾	6	12	9	¾	12	1.6	9	3.0	0.25	
15	70 and 65	7	13¾	6¼	12	9	¾	12	1.6	9	3.0	0.25	
	60.8	6½	12½	5¾	12	9	¾	12	1.6	8	2.7	0.25	
	55	6½	12¾	5¾	12	9	¾	12	1.6	8	2.7	0.25	
15	50 and 45	6½	12¾	6	12	9	¾	12	1.6	8	2.7	0.25	
	42.9	6½	12	6	12	9	¾	12	1.6	8	2.7	0.25	
	55	6	11¾	5¼	9	6	¾	9	1.3	8	2.7	0.25	
	50	6	11¾	5¼	9	6	¾	9	1.3	8	2.7	0.25	
	45	6	11¼	5¼	9	6	¾	9	1.3	7½	2.6	0.25	
12	40.8 and 35	6	11¼	5¼	9	6	¾	9	1.3	7½	2.6	0.25	
	31.8	6	11	5¼	9	6	¾	9	1.3	7½	2.6	0.25	
	40	5½	10¾	4¾	7½	5	¾	6	1.1	7½	1.3	0.13	<p>¾" Cored Hole</p>
10	35	5½	10¾	4¾	7½	5	¾	6	1.1	7	1.3	0.13	
	30	5½	10¾	5	7½	5	¾	7	1.1	7	1.3	0.13	
	25.4	5½	10	5	7½	5	¾	7	1.1	7	1.3	0.13	
	35	5	10	4¼	6½	5	¾	5	0.9	7	1.3	0.13	
9	30	5	9½	4¼	6½	5	¾	5	0.9	6½	1.2	0.13	
	25	5	9½	4¼	6½	5	¾	5	0.9	6½	1.2	0.13	
	21.8	5	9¼	4½	6½	5	¾	5	0.9	6½	1.2	0.13	
	25.5	4½	9	4	5½	4	¾	4	0.8	6	1.1	0.13	
8	23	4½	8¾	4	5½	4	¾	4	0.8	6	1.1	0.13	
	20.5 and 18.4	4½	8½	4	5½	4	¾	4	0.8	6	1.1	0.13	
	20	4½	8½	4	5	4	¾	4	0.7	6	1.1	0.13	
7	17.5	4½	8¼	4	5	4	¾	4	0.7	6	1.1	0.13	
	15.3	4½	8¼	4¼	5	4	¾	4	0.7	6	1.1	0.13	
	17.25	4	7¾	3¼	4½	4	¾	4	0.6	5½	1.1	0.13	
6	14.75	4	7½	3½	4½	4	¾	4	0.6	5½	1.1	0.13	
	12.5	4	7½	3¼	4½	4	¾	4	0.6	5½	1.1	0.13	

For 5", 4" and 3" beams, use 1" gas pipe 3¼", 3" and 2¾" long respectively.

CARNEGIE STEEL COMPANY

TIE RODS AND ANCHORS

AMERICAN BRIDGE COMPANY STANDARD

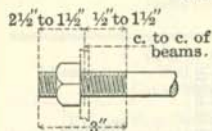

3/4 INCH TIE RODS

LENGTHS AND WEIGHTS FOR VARIOUS DISTANCES C. TO C. OF BEAMS

Weights include two Nuts

C. to C.	Length	Weight	C. to C.	Length	Weight	C. to C.	Length	Weight	C. to C.	Length	Weight
Ft.-In.	Ft.-In.	Pounds	Ft.-In.	Ft.-In.	Pounds	Ft.-In.	Ft.-In.	Pounds	Ft.-In.	Ft.-In.	Pounds
1-0	1-3	2.30	1-3	1-6	2.67	1-6	1-9	3.05	1-9	2-0	3.42
2-0	2-3	3.80	2-3	2-6	4.17	2-6	2-9	4.55	2-9	3-0	4.92
3-0	3-3	5.30	3-3	3-6	5.67	3-6	3-9	6.05	3-9	4-0	6.42
4-0	4-3	6.80	4-3	4-6	7.17	4-6	4-9	7.55	4-9	5-0	7.92
5-0	5-3	8.30	5-3	5-6	8.67	5-6	5-9	9.05	5-9	6-0	9.42
6-0	6-3	9.80	6-3	6-6	10.17	6-6	6-9	10.55	6-9	7-0	10.92
7-0	7-3	11.30	7-3	7-6	11.67	7-6	7-9	12.05	7-9	8-0	12.42
8-0	8-3	12.80	8-3	8-6	13.17	8-6	8-9	13.55	8-9	9-0	13.92

ANCHORS

SWEDGE BOLT

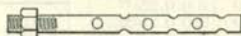

Weight includes Nut

Diameter	Length	Weight
Inches	Feet - Inches	Pounds
3/4	0-9	1.3
7/8	1-0	2.3
1	1-0	3.1
1 1/4	1-3	6.1

GOVERNMENT ANCHOR

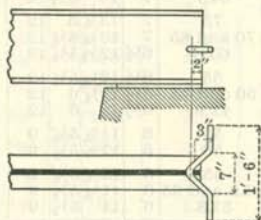

3/4" Rod 1' 9" long. Wt., 3 lbs.

BUILT-IN ANCHOR BOLTS

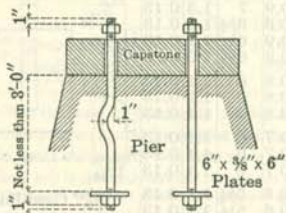

When center to center of anchors is less than width of washer, use washer with two holes.

ANGLE ANCHOR

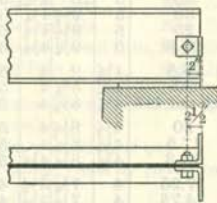

2 Angles 6" x 4" x 7/16" x 0' 2 1/2"
Weight with 3/4" bolts, 7 lbs.

STRUCTURAL DETAILS

BEARING PLATES

The size and thickness of steel bearing plates depend on the end reaction, length of bearing, and unit pressure. The following table gives sizes for beams of usual spans, the allowable safe loads in thousands of pounds and the span of beams giving equivalent end reactions.

STANDARD BEARING PLATES

Beam		Wall Bearing, Inches	Bearing Plate			Lim. Span of Beam, Ft.	Beam		Wall Bearing, Inches	Bearing Plate			Lim. Span of Beam, Ft.
Depth, In.	Wt., Lbs. per Ft.		Size, In.	Wt., Lbs.	Max. Safe Load		Depth, In.	Wt., Lbs. per Ft.		Size, In.	Wt., Lbs.	Max. Safe Load	
27	90.0	16	16x16x1	73	48.8	24.0	10	25.4	8	12x8x $\frac{3}{4}$	21	13.1	9.9
24	79.9	16	16x16x1	73	37.9	24.5	9	21.8	8	12x8x $\frac{3}{8}$	17	8.7	11.6
21	60.4	16	16x16x1	73	44.0	14.2	8	18.4	8	8x8x $\frac{3}{8}$	12	16.7	4.5
20	65.4	16	16x16x1	73	35.0	17.8	7	15.3	8	8x8x $\frac{3}{8}$	12	15.4	3.6
18	54.7	16	16x16x1	73	34.1	13.8	6	12.5	6	6x6x $\frac{1}{2}$	5	12.0	3.2
15	60.8	16	16x16x1	73	34.1	12.6	5	10.0	6	6x6x $\frac{1}{2}$	5	10.7	2.4
15	42.9	12	16x12x1	55	24.4	12.9	4	7.7	4	4x4x $\frac{3}{8}$	2	9.0	1.8
12	31.8	12	12x12x $\frac{3}{4}$	31	20.6	9.3	3	5.7	4	4x4x $\frac{3}{8}$	2	7.2	1.3

Allowable loads given for standard beams will apply also to supplementary and other beams of equal depth and end reactions.

Plates of special sizes may be taken from the table of projection coefficients given below, calculated from the following formula. Let

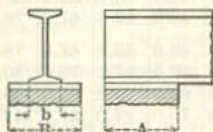

A = length of bearing plate, in inches.

B = width of bearing plate, in inches.

t = thickness of bearing plate, in inches.

b = flange width of beam, in inches.

R = reaction on bearing plate, in pounds.

w = $R \div Ax B$, allowable unit pressure on masonry.

$$M = \frac{R(B-b)}{8} = \frac{wAB(B-b)}{8} = fS = \frac{4ft^2}{6}; \quad B(B-b) = \frac{4ft^2}{3w}, \quad \text{or when } f = 16000,$$

$$B(B-b) = \frac{64000 t^2}{3w}, \quad \text{the same as the formula for rolled steel slabs, page 253.}$$

RULE:—Take from table on following page the proper size bearing plate for the reaction and unit pressure. Multiply the width of the plate by the width minus the width of the beam flange and select from the table below the thickness corresponding to the value for the given unit pressure.

PROJECTION COEFFICIENTS

Unit Pressure, Lbs. per Sq. In.	Thickness of Bearing Plates, in Inches													
	$\frac{3}{8}$	$\frac{1}{2}$	$\frac{5}{8}$	$\frac{3}{4}$	$\frac{7}{8}$	1	1 $\frac{1}{8}$	1 $\frac{1}{4}$	1 $\frac{3}{8}$	1 $\frac{1}{2}$	1 $\frac{5}{8}$	1 $\frac{3}{4}$	1 $\frac{7}{8}$	2
75	40.0	71.1	111.1	160	218	284	360	444	538	640	751	871	1000	1138
100	30.0	53.3	83.3	120	163	213	270	333	403	480	563	653	750	853
125	24.0	42.7	67.7	96	131	171	216	267	323	384	451	523	600	683
150	20.0	35.6	55.6	80	109	142	180	222	269	320	376	436	500	569
175	17.1	30.5	47.6	69	93	122	154	190	230	274	322	373	429	488
200	15.0	26.7	41.7	60	82	107	135	167	202	240	282	327	375	427
250	12.0	21.3	33.3	48	65	85	108	133	161	192	225	261	300	341
300	10.0	17.8	27.8	40	54	71	90	111	134	160	188	218	250	284
350	8.6	15.2	23.8	34	47	61	77	95	115	137	161	187	214	244
400	7.5	13.3	20.8	30	41	53	68	83	101	120	141	163	188	213

CARNEGIE STEEL COMPANY

BEARING PLATES

SAFE RESISTANCE IN THOUSANDS OF POUNDS

Wall Bear- ing, Inches	Bearing Plates		Pressure in Pounds per Square Inch									
	Length Inches	Width, Inches	75	100	125	150	175	200	250	300	350	400
4	4	4	1.2	1.6	2.0	2.4	2.8	3.2	4.0	4.8	5.6	6.4
4	4	6	1.8	2.4	3.0	3.6	4.2	4.8	6.0	7.2	8.4	9.6
4	4	8	2.4	3.2	4.0	4.8	5.6	6.4	8.0	9.6	11.2	12.8
6	6	6	2.7	3.6	4.5	5.4	6.3	7.2	9.0	10.8	12.6	14.4
6	6	8	3.6	4.8	6.0	7.2	8.4	9.6	12.0	14.4	16.8	19.2
6	6	10	4.5	6.0	7.5	9.0	10.5	12.0	15.0	18.0	21.0	24.0
8	8	8	4.8	6.4	8.0	9.6	11.2	12.8	16.0	19.2	22.4	25.6
8	8	10	6.0	8.0	10.0	12.0	14.0	16.0	20.0	24.0	28.0	32.0
8	8	12	7.2	9.6	12.0	14.4	16.8	19.2	24.0	28.8	33.6	38.4
10	10	10	7.5	10.0	12.5	15.0	17.5	20.0	25.0	30.0	35.0	40.0
10	10	12	9.0	12.0	15.0	18.0	21.0	24.0	30.0	36.0	42.0	48.0
10	10	14	10.5	14.0	17.5	21.0	24.5	28.0	35.0	42.0	49.0	56.0
12	12	12	10.8	14.4	18.0	21.6	25.2	28.8	36.0	43.2	50.4	57.6
12	12	14	12.6	16.8	21.0	25.2	29.4	33.6	42.0	50.4	58.8	67.2
12	12	16	14.4	19.2	24.0	28.8	33.6	38.4	48.0	57.6	67.2	76.8
14	14	14	14.7	19.6	24.5	29.4	34.3	39.2	49.0	58.8	68.6	78.4
14	14	16	16.8	22.4	28.0	33.6	39.2	44.8	56.0	67.2	78.4	89.6
14	14	18	18.9	25.2	31.5	37.8	44.1	50.4	63.0	75.6	88.2	100.8
14	14	20	21.0	28.0	35.0	42.0	49.0	56.0	70.0	84.0	98.0	112.0
16	16	16	19.2	25.6	32.0	38.4	44.8	51.2	64.0	76.8	89.6	102.4
16	16	18	21.6	28.8	36.0	43.2	50.4	57.6	72.0	86.4	100.8	115.2
16	16	20	24.0	32.0	40.0	48.0	56.0	64.0	80.0	96.0	112.0	128.0
16	16	22	26.4	35.2	44.0	52.8	61.6	70.4	88.0	105.6	123.2	140.8
18	18	18	24.3	32.4	40.5	48.6	56.7	64.8	81.0	97.2	113.4	129.6
18	18	20	27.0	36.0	45.0	54.0	63.0	72.0	90.0	108.0	126.0	144.0
18	18	22	29.7	39.6	49.5	59.4	69.3	79.2	99.0	118.8	138.6	158.4
18	18	24	32.4	43.2	54.0	64.8	75.6	86.4	108.0	129.6	151.2	172.8
20	20	20	30.0	40.0	50.0	60.0	70.0	80.0	100.0	120.0	140.0	160.0
20	20	22	33.0	44.0	55.0	66.0	77.0	88.0	110.0	132.0	154.0	176.0
20	20	24	36.0	48.0	60.0	72.0	84.0	96.0	120.0	144.0	168.0	192.0
20	20	26	39.0	52.0	65.0	78.0	91.0	104.0	130.0	156.0	182.0	208.0
22	22	22	36.3	48.4	60.5	72.6	84.7	96.8	121.0	145.2	169.4	193.6
22	22	24	39.6	52.8	66.0	79.2	92.4	105.6	132.0	158.4	184.8	211.2
22	22	26	42.9	57.2	71.5	85.8	100.1	114.4	143.0	171.6	200.2	228.8
22	22	28	46.2	61.6	77.0	92.4	107.8	123.2	154.0	184.8	215.6	246.4
24	24	24	43.2	57.6	72.0	86.4	100.8	115.2	144.0	172.8	201.6	230.4
24	24	26	46.8	62.4	78.0	93.6	109.2	124.8	156.0	187.2	218.4	249.6
24	24	28	50.4	67.2	84.0	100.8	117.6	134.4	168.0	201.6	235.2	268.8
24	24	30	54.0	72.0	90.0	108.0	126.0	144.0	180.0	216.0	252.0	288.0

DETAILS FOR PUNCHING AND RIVETING

AMERICAN BRIDGE COMPANY STANDARD

CONVENTIONAL SIGNS FOR RIVETING

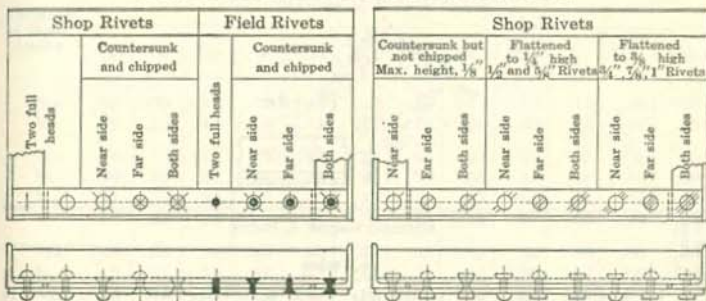

GAGES FOR ANGLES, INCHES

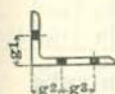

Leg	8	7	6	5	4	3 1/2	3	2 1/2	2	1 3/4	1 1/2	1 1/4	1 1/8	1	3/4
g1	4 1/2	4	3 1/2	3	2 3/4	2	1 3/4	1 1/2	1 1/4	1	3/4	3/4	3/4	3/4	3/4
g2	3	2 1/2	2 1/2	2											
g3	3	3	2 1/4	1 3/4											
Max. rivet	1 1/8	1	7/8	3/4	3/4	3/4	3/4	3/4	3/4	3/4	3/4	3/4	3/4	3/4	3/4

For column details, 6" leg (1/2 inch thick or less) against column shaft, g² = 1 1/2", g³ = 3".
 For diagonal angles, etc., gage in middle, where riveted leg equals or exceeds 3" for 3/4" rivets
 3 1/2" for 7/8" rivets.

Use special gages to adapt work to multiple punch, or to secure desirable details.

CLEARANCE FOR WEB RIVETING



RIVETS IN CRIMPED ANGLES

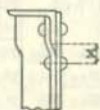

Distance x should be 1 1/2" plus thickness of chord angles, but never less than 2".

STANDARD RIVET DIES

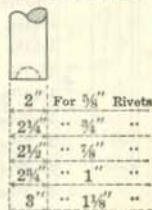

CLEARANCE FOR COVER PLATE RIVETING

Dimensions in Inches

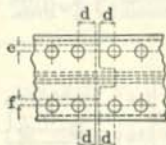

e	1/2	1	1 1/2	2	2 1/2	3	3 1/2	4	4 1/2	5	5 1/2	6
d	2 1/2	2 3/4	2 3/4	2 3/4	2 3/4	2 3/4	3	3 1/4	3 1/4	3 1/4	3 1/4	3 3/4
f	0	1/2	1	1 1/2	2	2 1/2						
d	2 1/2	2 1/4	2 1/4	2	1 1/2	0						

RIVET SPACING

AMERICAN BRIDGE COMPANY STANDARD
 MINIMUM STAGGER FOR RIVETS

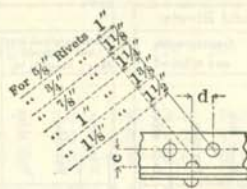

Diameter of Rivet, Inches	Minimum stagger, d, Inches																
	c, Inches																
5/8	1 1/8	1 1/16	1 1/4	1 5/16	1 3/8	1 7/16	1 1/2	1 9/16	1 5/8	1 11/16	1 3/4	1 13/16	1 7/8	1 15/16	2 1/16	2 3/16	2 5/16
3/4	1 1/4	1 3/16	1 1/2	1 5/16	1 3/8	1 7/16	1 1/2	1 9/16	1 5/8	1 11/16	1 3/4	1 13/16	1 7/8	1 15/16	2	2 1/16	2 3/16
1	1 1/2	1 3/8	1 1/2	1 5/8	1 3/4	1 7/8	1 1/2	1 9/8	1 11/8	1 13/8	1 15/8	1 1 1/8	1 1 1/4	1 1 1/2	1 1 3/4	1 1 5/8	1 1 3/4
1 1/8	1 5/8	1 3/4	1 1/2	1 5/8	1 3/4	1 7/8	1 1/2	1 9/8	1 11/8	1 13/8	1 15/8	1 1 1/8	1 1 1/4	1 1 1/2	1 1 3/4	1 1 5/8	1 1 3/4

DISTANCE CENTER TO CENTER OF STAGGERED RIVETS
 Values of x for varying values of a and b

b, In.	a, Inches																
	3/8	1	1 1/8	1 1/4	1 3/8	1 1/2	1 5/8	1 3/4	1 7/8	2	2 1/8	2 1/4	2 3/8	2 1/2	2 5/8	3	
1 1/8	1 7/16	1 1/2	1 9/16	1 11/16	1 3/4	1 7/8	2	2 1/16	2 3/16	2 5/16	2 7/16	2 9/16	2 11/16	2 13/16	2 15/16	3	3 1/16
1 1/4	1 9/16	1 5/8	1 11/16	1 3/4	1 7/8	1 15/16	2 1/16	2 3/16	2 5/16	2 7/16	2 9/16	2 11/16	2 13/16	2 15/16	3	3 1/16	3 1/8
1 3/8	1 5/8	1 11/16	1 3/4	1 7/8	1 15/16	2	2 1/16	2 3/16	2 5/16	2 7/16	2 9/16	2 11/16	2 13/16	2 15/16	3	3 1/16	3 1/8
1 1/2	1 3/4	1 9/16	1 7/8	1 15/16	2	2 1/16	2 3/16	2 5/16	2 7/16	2 9/16	2 11/16	2 13/16	2 15/16	3	3 1/16	3 1/8	3 1/4
1 5/8	1 7/8	1 7/8	2	2 1/16	2 3/16	2 5/16	2 7/16	2 9/16	2 11/16	2 13/16	2 15/16	3	3 1/16	3 1/8	3 1/4	3 3/8	3 1/2
1 3/4	1 15/16	2	2 1/16	2 3/16	2 5/16	2 7/16	2 9/16	2 11/16	2 13/16	2 15/16	3	3 1/16	3 1/8	3 1/4	3 3/8	3 1/2	3 5/8
1 7/8	2 1/16	2 3/16	2 5/16	2 7/16	2 9/16	2 11/16	2 13/16	2 15/16	3	3 1/16	3 1/8	3 1/4	3 3/8	3 1/2	3 5/8	3 3/4	3 7/8
2	2 3/16	2 5/16	2 7/16	2 9/16	2 11/16	2 13/16	2 15/16	3	3 1/16	3 1/8	3 1/4	3 3/8	3 1/2	3 5/8	3 3/4	3 7/8	4
2 1/8	2 5/16	2 7/16	2 9/16	2 11/16	2 13/16	2 15/16	3	3 1/16	3 1/8	3 1/4	3 3/8	3 1/2	3 5/8	3 3/4	3 7/8	4	4 1/8
2 1/4	2 7/16	2 9/16	2 11/16	2 13/16	2 15/16	3	3 1/16	3 1/8	3 1/4	3 3/8	3 1/2	3 5/8	3 3/4	3 7/8	4	4 1/8	4 1/4
2 3/8	2 9/16	2 11/16	2 13/16	2 15/16	3	3 1/16	3 1/8	3 1/4	3 3/8	3 1/2	3 5/8	3 3/4	3 7/8	4	4 1/8	4 1/4	4 1/2
2 1/2	2 11/16	2 13/16	2 15/16	3	3 1/16	3 1/8	3 1/4	3 3/8	3 1/2	3 5/8	3 3/4	3 7/8	4	4 1/8	4 1/4	4 1/2	4 3/4

Values below and to right of upper zigzag line are large enough for 3/4" rivets.
 Values below and to right of lower zigzag line are large enough for 1/2" rivets.

MINIMUM RIVET SPACING

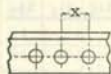

Dia. of Rivet, Inches	1/4	3/8	1/2	5/8	3/4	7/8	1	1 1/8
x, Minimum, Inches.	1	1 1/4	1 3/4	2	2 1/4	2 5/8	3	3 3/8

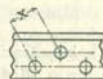

STRUCTURAL DETAILS

REDUCTION OF AREA FOR RIVET HOLES

Area in Square Inches=Diameter of Hole by Thickness of Metal

Thickness of Metal, Inches	Diameter of Hole in Inches											
	¼	½	⅝	¾	⅞	1	1 ⅛	1 ¼	1 ⅝	1 ¾	2	2 ¼
⅝	.05	.09	.11	.12	.13	.14	.15	.16	.18	.19	.20	.21
¾	.06	.13	.14	.16	.17	.19	.20	.22	.23	.25	.27	.28
⅞	.08	.16	.18	.20	.21	.23	.25	.27	.29	.31	.33	.35
1	.09	.19	.21	.23	.26	.28	.30	.33	.35	.38	.40	.42
1 ⅛	.11	.22	.25	.27	.30	.33	.36	.38	.41	.44	.46	.49
1 ¼	.13	.25	.28	.31	.34	.38	.41	.44	.47	.50	.53	.56
1 ⅝	.14	.28	.32	.35	.39	.42	.46	.49	.53	.56	.60	.63
1 ¾	.16	.31	.35	.39	.43	.47	.51	.55	.59	.63	.66	.70
2	.17	.34	.39	.43	.47	.52	.56	.60	.64	.69	.73	.77
2 ¼	.19	.38	.42	.47	.52	.56	.61	.66	.70	.75	.80	.84
2 ⅝	.20	.41	.46	.51	.56	.61	.66	.71	.76	.81	.86	.91
2 ¾	.22	.44	.49	.55	.60	.66	.71	.77	.82	.88	.93	.98
3	.23	.47	.53	.59	.64	.70	.76	.82	.88	.94	1.00	1.05
3 ¼	.25	.50	.56	.63	.69	.75	.81	.88	.94	1.00	1.06	1.13
3 ⅝	.27	.53	.60	.66	.73	.80	.86	.93	1.00	1.06	1.13	1.20
3 ¾	.28	.56	.63	.70	.77	.84	.91	.98	1.05	1.13	1.20	1.27
4	.30	.59	.67	.74	.82	.89	.96	1.04	1.11	1.19	1.26	1.34
4 ¼	.31	.63	.70	.78	.86	.94	1.02	1.09	1.17	1.25	1.33	1.41
4 ⅝	.33	.66	.74	.82	.90	.98	1.07	1.15	1.23	1.31	1.39	1.48
4 ¾	.34	.69	.77	.86	.95	1.03	1.12	1.20	1.29	1.38	1.46	1.55
5	.36	.72	.81	.90	.99	1.08	1.17	1.26	1.35	1.44	1.53	1.62
5 ¼	.38	.75	.84	.94	1.03	1.13	1.22	1.31	1.41	1.50	1.59	1.69

STAGGER OF RIVETS TO MAINTAIN NET SECTION

AMERICAN BRIDGE COMPANY STANDARD

1 Hole Out

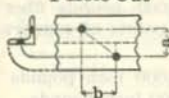

2 Holes Out

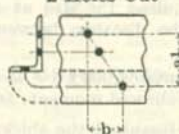

Dimensions in Inches

a	⅝"	¾"	a1	⅝"	¾"
	Rivet	Rivet		Rivet	Rivet
b	b	b	b	b	b
1	1 ⅝	1 ¾	5	3 ⅞	3 ⅞
1 ½	1 ⅞	2	5 ½	3 ¾	3 ½
2	2 ⅞	2 ¼	6	3 ¾	3 ¾
2 ½	2 ¼	2 ⅞	6 ½	3 ½	3 ¾
3	2 ⅞	2 ¾	7	3 ¾	3 ¾
3 ½	2 ⅞	2 ¾	7 ½	3 ¾	4
4	2 ¾	3	8	3 ¾	4 ¾
4 ½	2 ¾	3 ⅞	8 ½	4	4 ¾

y=diameter of rivet + ⅛"

$$a-y = \sqrt{a^2 + b^2} - 2y$$

$$b = \sqrt{2ay + y^2}$$

$$a1 - 2y = \sqrt{a^2 + b^2} - 3y$$

$$b = \sqrt{2ay + y^2}$$

a=sum of gages minus thickness of angle.

⅝" rivets, can be taken at ⅛" less than for ¾" rivets.

1" rivets, can be taken at ⅛" more than for ¾" rivets.

STRESSES IN RIVETS AND PINS

Rivets. In transmitting stresses between riveted pieces, it is customary to disregard friction and to proportion rivets to the entire stress to be transmitted. They must be of sufficient size and number to resist shear and to afford such bearing area as not to cause distortion of the metal at the rivet holes. In the case of beams which frame opposite and of single web girders, this latter condition often necessitates a greater thickness of web than required by the shearing stresses. In a plate girder with $\frac{5}{16}$ " web, $\frac{3}{4}$ " rivets connecting the web with the flange angles would have a bearing value at 24,000 pounds unit stress of 5,630 pounds per rivet, while their value in double shear at 12,000 pounds unit stress is 10,600 pounds per rivet; and it might be necessary to increase the web thickness to $\frac{3}{8}$ " or more in order that the pressure of the rivets upon the metal be not excessive.

Pins. Pins must be calculated for shearing, bending and bearing stresses, but one of the latter two will in most cases determine the size. When groups of bars are connected to the same pin, as in the lower chord of truss bridges, the size of the bars must be so chosen and the bars so placed that at no point on the pin will there be any excessive bending stress. When the size of pin has been determined from the bending stress, the thickness of the bars or web of the post should be investigated to provide sufficient bearing area, the bars being thickened or pin plates added if necessary.

The following is the formula for flexure applied to pins: $M = f \pi d^3 \div 32$ or $= f A d \div 8$, in which M = moment of forces for any section through pin, f = fiber stress per square inch in bending, A = the area of section, d = diameter, $\pi = 3.14159$. The forces are assumed to act in a plane passing through the axis of the pin.

EXAMPLE 1.—A pin, see figure, has to carry a load of 64,000 pounds; required the size at 24,000 pounds fiber stress, assuming the distance between points of support to be 5 inches.

Bending moment = $64,000 \times 5 \div 4 = 80,000$ inch pounds; use a $3\frac{1}{4}$ inch pin; allowed moment: 80,900 inch pounds.

EXAMPLE 2.—Required the thickness of metal in the top chord of a bridge to give sufficient bearing area to a $3\frac{3}{8}$ -inch pin, having to transmit a stress of 121,400 pounds at an allowed bearing pressure of 24,000 pounds per square inch.

The bearing value of a $3\frac{3}{8}$ -inch pin for 1 inch thickness of metal is 81,000 pounds; therefore, the thickness of metal required = $121,400 \div 81,000 = 1\frac{1}{2}$ inch, or each web of the chord must be $\frac{3}{4}$ inch thick, including pin plates.

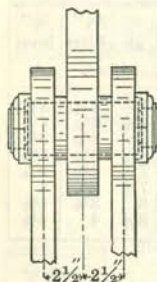

STRESSES IN RIVETS AND PINS

RIVETS

SHEARING AND BEARING VALUES

Values in Pounds, all Dimensions in Inches

 $\frac{3}{8}$ -INCH RIVETS—Area .1104 Square Inch

Shear	Unit, Lbs. per Sq. In.		7000	8000	9000	10000	11000	12000
	Single Shear per Rivet		770	880	990	1100	1210	1320
	Double Shear per Rivet		1540	1760	1980	2200	2420	2640
Bearing	Unit, Lbs. per Sq. In.		14000	16000	18000	20000	22000	24000
	Thickness in Inches	$\frac{1}{8}$	660	750	840	940	1030	1130
		$\frac{3}{16}$	980	1130	1270	1410	1550	1690
		$\frac{1}{4}$	1310	1500	1690	1880	2060	2250
		$\frac{5}{16}$	1640	1880	2110	2340	2580	2810
		$\frac{3}{8}$	1910	2250	2530	2810	3090	3380
.....							

 $\frac{1}{2}$ -INCH RIVETS—Area .1963 Square Inch

Shear	Unit, Lbs. per Sq. In.		7000	8000	9000	10000	11000	12000
	Single Shear per Rivet		1370	1570	1770	1960	2160	2360
	Double Shear per Rivet		2750	3140	3530	3930	4320	4710
Bearing	Unit, Lbs. per Sq. In.		14000	16000	18000	20000	22000	24000
	Thickness in Inches	$\frac{3}{16}$	1310	1500	1690	1880	2060	2250
		$\frac{1}{4}$	1750	2000	2250	2500	2750	3000
		$\frac{5}{16}$	2190	2500	2810	3130	3440	3750
		$\frac{3}{8}$	2630	3000	3380	3750	4130	4500
		$\frac{7}{16}$	3060	3500	3940	4380	4810	5250
		$\frac{1}{2}$	3500	4000	4500	5000	5500	6000
.....							

 $\frac{5}{8}$ -INCH RIVETS—Area .3068 Square Inch

Shear	Unit, Lbs. per Sq. In.		7000	8000	9000	10000	11000	12000
	Single Shear per Rivet		2150	2450	2760	3070	3370	3680
	Double Shear per Rivet		4300	4910	5520	6140	6750	7360
Bearing	Unit, Lbs. per Sq. In.		14000	16000	18000	20000	22000	24000
	Thickness in Inches	$\frac{3}{16}$	1640	1880	2110	2340	2580	2810
		$\frac{1}{4}$	2190	2500	2810	3130	3440	3750
		$\frac{5}{16}$	2730	3130	3520	3910	4300	4690
		$\frac{3}{8}$	3280	3750	4220	4690	5160	5630
		$\frac{7}{16}$	3830	4380	4920	5470	6020	6560
		$\frac{1}{2}$	4380	5000	5630	6250	6880	7500
		$\frac{9}{16}$	4920	5630	6330	7030	7730	8440
$\frac{5}{8}$		5470	6250	7040	7810	8590	9380	

Values below dotted lines are greater than double shear.

CARNEGIE STEEL COMPANY

RIVETS

SHEARING AND BEARING VALUES

Values in Pounds, Dimensions in Inches

3/4-INCH RIVETS—Area .4418 Square Inch

Shear		Unit, Lbs. per Sq. In.	7000	8000	9000	10000	11000	12000	
		Single Shear per Rivet	3090	3530	3980	4420	4860	5300	
Double Shear per Rivet		6190	7070	7950	8840	9720	10600		
Bearing		Unit, Lbs. per Sq. In.	14000	16000	18000	20000	22000	24000	
		Thickness in Inches	1/4	2630	3000	3380	3750	4130	4500
Bearing		Thickness in Inches	5/16	3280	3750	4220	4690	5160	5630
			3/8	3940	4500	5060	5630	6190	6750
			7/16	4590	5250	5910	6560	7220	7880
			1/2	5250	6000	6750	7500	8250	9000
			5/8	5910	6750	7590	8440	9280	10130
			3/4	6560	7500	8440	9380	10310	11250

7/8-INCH RIVETS—Area .6013 Square Inch

Shear		Unit, Lbs. per Sq. In.	7000	8000	9000	10000	11000	12000	
		Single Shear per Rivet	4210	4810	5410	6010	6610	7220	
Double Shear per Rivet		8420	9620	10820	12030	13230	14430		
Bearing		Unit, Lbs. per Sq. In.	14000	16000	18000	20000	22000	24000	
		Thickness in Inches	1/4	3060	3500	3940	4380	4810	5250
Bearing		Thickness in Inches	5/16	3830	4380	4920	5470	6020	6560
			3/8	4590	5250	5910	6560	7220	7880
			7/16	5360	6130	6890	7660	8420	9190
			1/2	6130	7000	7880	8750	9630	10500
			5/8	6890	7880	8860	9840	10830	11810
			3/4	7660	8750	9840	10940	12030	13130
			7/8	8420	9630	10830	12030	13230	14430
			1 1/8	8420	9630	10830	12030	13230	14430

1-INCH RIVETS—Area .7854 Square Inch

Shear		Unit, Lbs. per Sq. In.	7000	8000	9000	10000	11000	12000	
		Single Shear per Rivet	5500	6280	7070	7850	8640	9420	
Double Shear per Rivet		11000	12570	14140	15710	17280	18850		
Bearing		Unit, Lbs. per Sq. In.	14000	16000	18000	20000	22000	24000	
		Thickness in Inches	1/4	3500	4000	4500	5000	5500	6000
Bearing		Thickness in Inches	5/16	4380	5000	5630	6250	6880	7500
			3/8	5250	6000	6750	7500	8250	9000
			7/16	6130	7000	7880	8750	9630	10500
			1/2	7000	8000	9000	10000	11000	12000
			5/8	7880	9000	10130	11250	12380	13500
			3/4	8750	10000	11250	12500	13750	15000
			7/8	9630	11000	12380	13750	15130	16500
			1 1/8	10500	12000	13500	15000	16500	18000
			1 1/4	11380	13000	14630	16250	17880	19500
			1 3/8	11380	13000	14630	16250	17880	19500

Values above upper dotted lines are less than single shear.

Values below lower dotted lines are greater than double shear.

STRESSES IN RIVETS AND PINS

PINS

BEARING VALUES IN POUNDS ON METAL ONE INCH THICK

Bearing Value=Diameter of Pin x Bearing Stress per Square Inch

Pin		Bearing Stresses in Pounds per Square Inch				
Diameter, Inches	Area, Sq. In.	12000	15000	20000	22000	24000
1	.785	12000	15000	20000	22000	24000
1 1/4	1.227	15000	18800	25000	27500	30000
1 1/2	1.767	18000	22500	30000	33000	36000
1 3/4	2.405	21000	26300	35000	38500	42000
2	3.142	24000	30000	40000	44000	48000
2 1/4	3.976	27000	33800	45000	49500	54000
2 1/2	4.909	30000	37500	50000	55000	60000
2 3/4	5.940	33000	41300	55000	60500	66000
3	7.069	36000	45000	60000	66000	72000
3 1/4	8.296	39000	48800	65000	71500	78000
3 1/2	9.621	42000	52500	70000	77000	84000
3 3/4	11.045	45000	56300	75000	82500	90000
4	12.566	48000	60000	80000	88000	96000
4 1/4	14.186	51000	63800	85000	93500	102000
4 1/2	15.904	54000	67500	90000	99000	108000
4 3/4	17.721	57000	71300	95000	104500	114000
5	19.635	60000	75000	100000	110000	120000
5 1/4	21.648	63000	78800	105000	115500	126000
5 1/2	23.758	66000	82500	110000	121000	132000
5 3/4	25.967	69000	86300	115000	126500	138000
6	28.274	72000	90000	120000	132000	144000
6 1/4	30.680	75000	93800	125000	137500	150000
6 1/2	33.183	78000	97500	130000	143000	156000
6 3/4	35.785	81000	101300	135000	148500	162000
7	38.485	84000	105000	140000	154000	168000
7 1/4	41.282	87000	108800	145000	159500	174000
7 1/2	44.179	90000	112500	150000	165000	180000
7 3/4	47.173	93000	116300	155000	170500	186000
8	50.265	96000	120000	160000	176000	192000
8 1/4	53.456	99000	123800	165000	181500	198000
8 1/2	56.745	102000	127500	170000	187000	204000
8 3/4	60.132	105000	131300	175000	192500	210000
9	63.617	108000	135000	180000	198000	216000
9 1/4	67.201	111000	138800	185000	203500	222000
9 1/2	70.882	114000	142500	190000	209000	228000
9 3/4	74.662	117000	146300	195000	214500	234000
10	78.540	120000	150000	200000	220000	240000
10 1/4	82.516	123000	153800	205000	225500	246000
10 1/2	86.590	126000	157500	210000	231000	252000
10 3/4	90.763	129000	161300	215000	236500	258000
11	95.033	132000	165000	220000	242000	264000
11 1/4	99.402	135000	168800	225000	247500	270000
11 1/2	103.869	138000	172500	230000	253000	276000
11 3/4	108.434	141000	176300	235000	258500	282000
12	113.097	144000	180000	240000	264000	288000

CARNEGIE STEEL COMPANY

PINS

BENDING MOMENTS IN INCH POUNDS

Bending Moment=(Diameter of Pin)³ x 0.098175 x Stress per Square Inch

Pin		Fiber Stress in Pounds per Square Inch						
Diameter, Inches	Area, Sq. In.	15000	18000	20000	22000	22500	24000	25000
1	.785	1500	1800	2000	2200	2200	2400	2500
1 1/4	1.227	2900	3500	3800	4200	4300	4600	4800
1 1/2	1.767	5000	6000	6600	7300	7500	8000	8300
1 3/4	2.405	7900	9500	10500	11600	11800	12600	13200
2	3.142	11800	14100	15700	17300	17700	18800	19600
2 1/4	3.976	16800	20100	22400	24600	25200	26800	28000
2 1/2	4.909	23000	27600	30700	33700	34500	36800	38300
2 3/4	5.940	30600	36800	40800	44900	45900	49000	51000
3	7.069	39800	47700	53000	58300	59600	63600	66300
3 1/4	8.296	50600	60700	67400	74100	75800	80900	84300
3 1/2	9.621	63100	75800	84200	92600	94700	101000	105200
3 3/4	11.045	77700	93200	103500	113900	116500	124300	129400
4	12.566	94200	113100	125700	138200	141400	150800	157100
4 1/4	14.186	113000	135700	150700	165800	169600	180900	188400
4 1/2	15.904	134200	161000	178900	196800	201300	214700	223700
4 3/4	17.721	157800	189400	210400	231500	236700	252500	263000
5	19.635	184100	220900	245400	270000	276100	294500	306800
5 1/4	21.648	213100	255700	284100	312500	319600	340900	352500
5 1/2	23.758	245000	294000	326700	359300	367500	392000	408300
5 3/4	25.967	280000	336000	373300	410600	419900	447900	466600
6	28.274	318100	381700	424100	466500	477100	508900	530100
6 1/4	30.680	359500	431400	479400	527300	539300	575200	599200
6 1/2	33.183	404400	485300	539200	593100	606600	647100	674000
6 3/4	35.785	452900	543500	603900	664300	679400	724600	754800
7	38.485	505100	606100	673500	740800	757700	808200	841800
7 1/4	41.282	561200	673400	748200	823100	841800	897900	935300
7 1/2	44.179	621300	745500	828400	911200	931900	994000	1035400
7 3/4	47.173	685500	822600	914000	1005400	1028200	1096800	1142500
8	50.265	754000	904800	1005300	1105800	1131000	1206400	1256600
8 1/4	53.456	826900	992300	1102500	1212800	1240400	1323000	1378200
8 1/2	56.745	904400	1085300	1205800	1326400	1356600	1447000	1507300
8 3/4	60.132	986500	1183900	1315400	1446900	1479800	1578500	1644200
9	63.617	1073500	1288300	1431400	1574500	1610300	1717700	1789200
9 1/4	67.201	1165500	1398600	1554000	1709400	1748300	1864800	1942500
9 1/2	70.882	1262600	1515100	1683500	1851800	1893900	2020100	2104300
9 3/4	74.662	1364900	1637900	1819900	2001900	2047400	2183900	2274900
10	78.540	1472600	1767100	1963500	2159800	2208900	2356200	2454400
10 1/4	82.516	1585900	1903000	2114500	2325900	2378800	2537400	2643100
10 1/2	86.590	1704700	2045700	2273000	2500300	2557100	2727600	2841200
10 3/4	90.763	1829400	2195300	2439200	2683200	2744100	2927100	3049100
11	95.033	1960100	2352100	2613400	2874800	2940100	3136100	3266800
11 1/4	99.402	2096800	2516100	2795700	3075200	3145100	3354800	3494600
11 1/2	103.869	2239700	2687600	2986200	3284900	3359500	3583500	3732800
11 3/4	108.434	2388900	2866700	3185300	3503800	3583400	3822300	3981600
12	113.097	2544700	3053600	3392900	3732200	3817000	4071500	4241200

BEAM AND PLATE AND ANGLE GIRDERS

Where single rolled beams are insufficient to carry the loads, the required capacity may be obtained by various methods.

Two beams, connected with bolts and cast iron separators, or, for greater rigidity, with riveted plate and angle separators, can be used. The total strength of these is twice that of the single beam provided that the loads are applied equally on the two sections, otherwise their strength must be computed separately.

Single beam girders with plates riveted on top and bottom are often more economical than two beams connected with separators.

Box girders formed of two beams with plates riveted across the beam flanges are frequently used for supporting interior walls in buildings, but they are not as economical as single beams with flange plates or as plate girders. Box girders should not be used in exposed places, as their interior surfaces do not admit of repainting.

The most economical section is the single web plate girder; if not of sufficient strength, two single web plate girders may be used, with tie plates extending across the angles, or box girders may be made of four flange angles, two web plates and top and bottom flange plates. If the loads are not equally distributed, the two half-girders must be figured as separate units.

In the design of beam or plate girders the web must be of sufficient thickness to resist buckling stress and attention is called to the Construction Specifications and to the remarks made on page 151 as to shearing stresses in general.

At the ends of plate girders a sufficient number of rivets must be provided in each flange to properly transfer to both flanges the stresses due to total end shear, over a distance equal to the effective depth of girder, which is the distance between centers of rivets in upper and lower flange for angles with one line of rivets, and between centers of rivet lines for angles with two lines of rivets. In the following tables maximum allowable reactions have been based upon the maximum shearing or bearing values of $\frac{3}{4}$ -inch flange rivets.



The tables which follow give: first, a selected number of riveted beam girders of approximately twice the carrying capacity of corresponding single beams; second, a selected number of riveted plate girders of various depths and carrying capacities customary in building work; third, elements of riveted plate girders of various depths.

In accordance with the Construction Specifications, these girder tables are based upon the section modulus of the gross area of the section, with bending stress allowed at 16,000 pounds per square inch.

CARNEGIE STEEL COMPANY

RIVETED BEAM GIRDERS

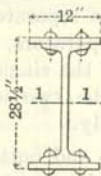
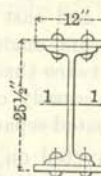
ALLOWABLE UNIFORM LOAD IN THOUSANDS OF POUNDS

Span in Feet									Coefficients of Deflection
	Safe Loads	Increase in Safe Loads for 1/16 Inch Increase in Thickness of Plates	Safe Loads	Increase in Safe Loads for 1/16 Inch Increase in Thickness of Plates	Safe Loads	Increase in Safe Loads for 1/16 Inch Increase in Thickness of Plates	Safe Loads	Increase in Safe Loads for 1/16 Inch Increase in Thickness of Plates	
	1-Beam 27"x90 lbs. 2-Plates 12"x3/4"		1-Beam 24"x79.9 lbs. 2-Plates 12"x3/4"		1-Beam 24"x79.9 lbs. 2-Plates 10"x5/8"		1-Beam 20"x81.4 lbs. 2-Plates 10"x3/4"		
20	283.0		240.0		240.0		240.0		
21	240.4	10.4	202.7	9.2	168.2	7.6	152.9	6.3	6.62
22	229.0	9.9	193.0	8.8	160.2	7.2	145.6	6.0	7.30
23	218.6	9.4	184.2	8.4	152.9	6.9	139.0	5.7	8.01
24	209.1	9.0	176.2	8.0	146.3	6.6	132.9	5.5	8.76
25	200.4	8.6	168.9	7.7	140.2	6.3	127.4	5.2	9.53
26	192.4	8.3	162.1	7.4	134.6	6.1	122.3	5.0	10.35
27	185.0	8.0	155.9	7.1	129.4	5.9	117.6	4.8	11.19
28	178.1	7.7	150.1	6.8	124.6	5.6	113.2	4.7	12.07
29	171.7	7.4	144.8	6.6	120.2	5.4	109.2	4.5	12.98
30	165.8	7.1	139.8	6.4	116.0	5.2	105.4	4.3	13.92
31	160.3	6.9	135.1	6.1	112.2	5.1	101.9	4.2	14.90
32	155.1	6.7	130.7	5.9	108.5	4.9	98.6	4.1	15.91
33	150.3	6.5	126.7	5.8	105.2	4.8	95.6	3.9	16.95
34	145.7	6.3	122.8	5.6	102.0	4.6	92.7	3.8	18.03
35	141.4	6.1	119.2	5.4	99.0	4.5	89.9	3.7	19.13
36	137.4	5.9	115.8	5.3	96.1	4.3	87.4	3.6	20.28
37	133.6	5.8	112.6	5.1	93.5	4.2	84.9	3.5	21.45
38	130.0	5.6	109.5	5.0	90.9	4.1	82.6	3.4	22.66
39	126.6	5.5	106.7	4.9	88.5	4.0	80.5	3.3	23.90
40	123.3	5.3	103.9	4.7	86.3	3.9	78.4	3.2	25.18
41	120.2	5.2	101.3	4.6	84.1	3.8	76.4	3.1	26.48
42	117.3	5.1	98.9	4.5	82.1	3.7	74.6	3.1	27.82
43	114.5	4.9	96.5	4.4	80.1	3.6	72.8	3.0	29.20
44	111.8	4.8	94.3	4.3	78.3	3.5	71.1	2.9	30.60
45	109.3	4.7	92.1	4.2	76.5	3.5	69.5	2.9	32.04
46	106.9	4.6	90.1	4.1	74.8	3.4	67.9	2.8	33.52
47	104.5	4.5	88.1	4.0	73.2	3.3	66.5	2.7	35.02
48	102.3	4.4	86.2	3.9	71.6	3.2	65.1	2.7	36.56
49	100.0	4.3	84.4	3.8	70.1	3.2			38.14
50	98.1	4.2	82.7	3.8	68.7	3.1			39.74
	96.2	4.1	81.1	3.7	67.3	3.0			41.38
Area	44.34 inches ²		41.33 inches ²		35.83 inches ²		38.74 inches ²		
S ₁₋₁	450.8 inches ³		380.0 inches ³		315.5 inches ³		286.7 inches ³		
Weight	151.2 lbs. per ft.		141.1 lbs. per ft.		122.4 lbs. per ft.		132.4 lbs. per ft.		

Loads exceeding those given above horizontal lines will produce maximum allowable shear in webs and stiffeners should be provided in accordance with Construction Specifications.

Weights given for girders do not include stiffeners, rivet heads or other details.

RIVETED BEAM GIRDERS—Concluded

ALLOWABLE UNIFORM LOAD IN THOUSANDS OF POUNDS

Span in Feet									Coefficients of Deflection
	Safe Loads	Increase in Safe Loads for 1/16 Inch Increase in Thickness of Plates	Safe Loads	Increase in Safe Loads for 1/16 Inch Increase in Thickness of Plates	Safe Loads	Increase in Safe Loads for 1/16 Inch Increase in Thickness of Plates	Safe Loads	Increase in Safe Loads for 1/16 Inch Increase in Thickness of Plates	
	1-Beam 20"x65.4 lbs. 2-Plates 10"x5/8"		1-Beam 18"x54.7 lbs. 2-Plates 9"x5/8"		1-Beam 15"x60.8 lbs. 2-Plates 9"x5/8"		1-Beam 15"x42.9 lbs. 2-Plates 8"x5/8"		
	200.0		165.6		177.0		123.0		
15	167.3	8.5	130.9	6.9	113.4	5.7	82.0	5.1	3.72
16	156.8	8.0	122.7	6.5	106.3	5.3	76.9	4.8	4.24
17	147.6	7.5	115.5	6.1	100.1	5.0	72.3	4.5	4.78
18	139.4	7.1	109.1	5.7	94.5	4.7	68.3	4.2	5.36
19	132.1	6.7	103.3	5.4	89.5	4.5	64.7	4.0	5.98
20	125.5	6.4	98.2	5.2	85.1	4.3	61.5	3.8	6.62
21	119.5	6.1	93.5	4.9	81.0	4.0	58.6	3.6	7.30
22	114.0	5.8	89.2	4.7	77.3	3.9	55.9	3.5	8.01
23	109.1	5.5	85.4	4.5	74.0	3.7	53.5	3.3	8.76
24	104.5	5.3	81.8	4.3	70.9	3.5	51.2	3.2	9.53
25	100.4	5.1	78.5	4.1	68.1	3.4	49.2	3.1	10.35
26	96.5	4.9	75.5	4.0	65.4	3.3	47.3	2.9	11.19
27	92.9	4.7	72.7	3.8	63.0	3.1	45.6	2.8	12.07
28	89.6	4.6	70.1	3.7	60.8	3.0	43.9	2.7	12.98
29	86.5	4.4	67.7	3.6	58.7	2.9	42.4	2.6	13.92
30	83.6	4.2	65.4	3.4	56.7	2.8	41.0	2.5	14.90
31	80.9	4.1	63.3	3.3	54.9	2.7	39.7	2.5	15.91
32	78.4	4.0	61.4	3.2	53.2	2.7	38.4	2.4	16.95
33	76.0	3.9	59.5	3.1	51.6	2.6	37.3	2.3	18.03
34	73.8	3.7	57.7	3.0	50.4	2.5	36.2	2.2	19.13
35	71.7	3.6	56.1	3.0	48.6	2.4	35.1	2.2	20.28
36	69.7	3.5	54.5	2.9	47.8	2.4	34.2	2.1	21.45
37	67.8	3.4	53.1	2.8					22.66
38	66.0	3.4	51.7	2.7					23.90
39	64.3	3.3	50.3	2.6					25.18
40	62.7	3.2	49.1	2.6					26.48
41	61.2	3.1	47.9	2.5					27.82
42	59.7	3.0	46.7	2.5					29.20
43	58.4	3.0							30.60
44	57.0	2.9							32.04
45	55.8	2.8							33.52
Area	31.58 inches ²		27.19 inches ²		28.93 inches ²		20.49 inches ²		
S 1-1	235.2 inches ³		184.1 inches ³		159.5 inches ³		115.3 inches ³		
Weight	107.9 lbs. per ft.		93.0 lbs. per ft.		99.1 lbs. per ft.		70.1 lbs. per ft.		

Loads exceeding those given above horizontal lines will produce maximum allowable shear in webs and stiffeners should be provided in accordance with Construction Specifications. Weights given for girders do not include stiffeners, rivet heads or other details.

CARNEGIE STEEL COMPANY

RIVETED PLATE GIRDERS

SAFE LOADS IN THOUSANDS OF POUNDS UNIFORMLY DISTRIBUTED







Span in Feet									Coefficients of Deflection
	Web Plate Flange Angles Flange Plates	Web Plate Flange Angles Flange Plates	Web Plate Flange Angles Flange Plates	Web Plate Flange Angles Flange Plates	Web Plate Flange Angles	Web Plate Flange Angles Flange Plates	Web Plate Flange Angles Flange Plates	Web Plate Flange Angles Flange Plates	
	1-30x1 1/2 4-6x4 1/2 2-14x 5/8	1-30x 3/4 4-6x4 1/2 2-14x 5/8	1-30x 5/8 4-6x4 1/2 2-14x 5/8	1-30x 3/4 4-6x4 1/2 2-14x 1/2	1-30x 3/4 4-6x4 5/8	1-28x 3/4 4-6x3 1/2 2-12x 1/2	1-28x 1/2 4-6x4 1/2 2-14x 5/8	1-28x 3/4 4-6x4 1/2 2-14x 5/8	
25	288.0						270.0		
26	260.1				145.5		239.2		10.35
27	250.1				145.4		230.0		11.19
28	240.9				140.2		221.5		12.07
29	232.3				135.4	185.0	213.6		12.98
30	224.3				130.9	134.9	206.2		13.92
31	216.8				126.7	126.2	199.4		14.90
32	209.8				122.7	122.2	192.9		15.91
33	203.2				119.0	118.5	186.9		16.95
34	197.1				115.5	115.1	181.2		18.03
35	191.3				112.2	111.8	175.9		19.13
36	185.8				109.1	108.7	170.9		20.28
37	180.6			148.5	106.1	105.7	166.1		21.45
38	175.8			148.2	103.3	102.9	161.6		22.66
39	171.1			144.3	100.7	100.3	157.4		23.90
40	166.8			140.6	98.2	97.8	153.3		25.18
41	162.6		148.5	137.1	95.8	95.4	149.5		26.48
42	158.6		147.0	133.7	93.1	92.9	145.9	185.0	27.82
43	154.8		143.5	130.6	90.5	90.1	142.4	132.6	29.20
44	151.3		140.2	127.5	88.2	87.8	139.1	129.5	30.60
45	147.8	148.5	137.0	124.6	85.4	85.0	135.9	126.5	32.04
46	144.5	147.1	134.0	121.8	83.2	82.8	132.9	123.7	33.52
47	141.4	143.9	131.0	119.2	81.1	80.7	130.0	121.0	35.02
48	138.4	140.9	128.3	116.7	79.1	78.7	127.3	118.5	36.56
49	135.5	137.9	125.6	114.2	77.2	76.8	124.6	116.0	38.14
50	132.7	135.1	123.0	111.9	75.4	75.0	122.1	113.6	39.74
51	130.1	132.4	120.6	109.7	73.7	73.3	119.6	111.3	41.38
52	127.5	129.8	118.2	107.5	72.1	71.7	117.3	109.2	43.05
53	125.1	127.3	115.9	105.4	70.6	70.2	115.0	107.1	44.76
54	122.7	124.9	113.7	103.5	69.1	68.7	112.6	105.0	46.49
55	120.4	122.6	111.6	101.5	67.7	67.3	110.8	103.1	48.26
55	118.2	120.4	109.6	99.7	66.4	66.0	108.7	101.2	50.07
Area	55.50	52.19	47.75	44.25	34.69	34.70	54.50	47.00	In. ²
S ₁₋₁	609.7	620.6	565.1	514.0	268.1	366.7	560.7	521.9	In. ³
Wt. per Ft.	188.9	177.8	162.6	150.7	118.3	118.1	185.5	160.0	Lbs.

Loads above horizontal lines correspond to end reactions based on maximum allowable stresses in flange rivets. Web stiffeners should be provided in accordance with Construction Specifications. Weights given for girders do not include stiffeners, rivet heads or other details.

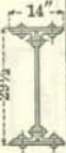
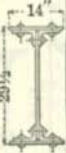
RIVETED GIRDERS

RIVETED PLATE GIRDERS—Continued

SAFE LOADS IN THOUSANDS OF POUNDS UNIFORMLY DISTRIBUTED

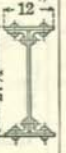







Span in Feet	14" 		14" 		12 3/4" 		10 3/4" 		14" 		14" 		14" 		12" 		Coefficients of Deflection
	Web Plate 1-28x 3/4 4-6x4x 1/2 2-14x 1/2	Flange Angles 4-6x4x 1/2 2-14x 1/2	Web Plate 1-28x 3/4 4-6x4x 1/2 2-14x 1/2	Flange Angles 4-6x4x 1/2 2-14x 1/2	Web Plate 1-28x 3/4 4-6x4x 1/2	Flange Angles 4-6x4x 1/2 2-14x 1/2	Web Plate 1-28x 3/4 4-6x4x 1/2 2-14x 1/2	Flange Angles 4-6x4x 1/2 2-14x 1/2	Web Plate 1-20x 3/4 4-6x4x 1/2 2-14x 1/2	Flange Angles 4-6x4x 1/2 2-14x 1/2	Web Plate 1-20x 3/4 4-6x4x 1/2 2-14x 1/2	Flange Angles 4-6x4x 1/2 2-14x 1/2	Web Plate 1-20x 3/4 4-6x4x 1/2 2-14x 1/2	Flange Angles 4-6x4x 1/2 2-14x 1/2	Web Plate 1-20x 3/4 4-6x4x 1/2 2-12x 3/4	Flange Angles 4-6x4x 1/2 2-12x 3/4	
25					185.0												
26					121.3			185.0									10.35
27					116.7			106.3									11.19
28					112.3			98.4									12.07
29					108.3			94.9									12.98
30					104.6			91.6									13.92
31					101.1			88.6									14.90
32					97.8			85.7									15.91
33					94.8			83.0									16.95
34					91.9			80.5									18.03
35					89.2			78.1									19.13
36					86.7			75.9									20.28
37					84.2			73.8									21.45
38					82.0			71.8									22.66
39					79.8			69.9									23.90
40					77.8			68.1									25.18
41					75.8			66.4									26.48
42					74.0			64.8									27.82
43					72.2			63.3									29.20
44					70.5			61.8									30.60
45					68.9			60.4									32.04
46					67.4			59.0									33.52
47					65.9			57.8									35.02
48					64.5			56.5									36.56
49					63.2			55.4									38.14
50					61.9			54.2									39.74
51					60.7			53.1									41.38
52					59.5			52.1									43.05
53					58.3			51.1									44.76
54					57.2			50.1									46.49
55					56.2			49.2									48.26
55					55.1			48.3									50.07
Area	43.50	38.94	29.50	26.50	42.75	38.19	34.69	30.95	In. ²								
S ₁₋₁	474.3	420.8	284.3	249.1	435.1	386.1	341.5	298.0	In. ³								
Wt. per Ft.	148.1	132.5	100.5	90.1	145.6	130.0	118.1	105.4	Lbs.								

Loads above horizontal lines correspond to end reactions based on maximum allowable stresses in flange rivets. Web stiffeners should be provided in accordance with Construction Specifications. Weights given for girders do not include stiffeners, rivet heads or other details.

CARNEGIE STEEL COMPANY

RIVETED PLATE GIRDERS—Concluded

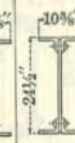
SAFE LOADS IN THOUSANDS OF POUNDS UNIFORMLY DISTRIBUTED

Span in Feet																	Coefficients of Deflection
	Web Plate Flange Angles	Web Plate Flange Angles	Web Plate Flange Angles	Web Plate Flange Angles	Web Plate Flange Angles	Web Plate Flange Angles	Web Plate Flange Angles	Web Plate Flange Angles	Web Plate Flange Angles	Web Plate Flange Angles	Web Plate Flange Angles	Web Plate Flange Angles	Web Plate Flange Angles	Web Plate Flange Angles			
20	185.0	185.0											121.5	121.5			
21	131.5	120.8											109.1	88.3			6.62
22	125.5	109.8											103.9	84.1			7.30
23	120.1	105.1											99.2	80.2			8.01
24	115.1	100.7											121.5	94.9			8.76
25	110.5	96.7											120.4	90.9			9.53
26	106.2	92.9											115.6	87.3			10.35
27	102.3	89.5											121.5	83.9			11.19
28	98.6	86.3											120.9	80.8			12.07
29	95.2	83.3											116.6	77.9			12.98
30	92.0	80.6											112.6	75.2			13.92
31	89.1	78.0											108.8	72.7			14.90
32	86.3	75.5											121.5	70.4			15.91
33	83.7	73.2											118.2	68.2			16.95
34	81.2	71.1											114.5	66.1			18.03
35	78.9	69.0											111.1	64.2			19.13
36	76.7	67.1											107.8	62.3			20.28
37	74.6	65.3											104.7	60.6			21.45
38	72.7	63.6											101.8	59.0			22.66
39	70.8	62.0											99.1	57.4			23.90
40	69.0	60.4											96.5	55.9			25.18
41	67.4	58.9											94.0	54.5			26.48
42	65.7	57.5											91.6	53.2			27.82
43	64.2	56.2											89.4	52.0			29.20
44	62.8	54.9											87.3	50.7			30.60
45	61.4	53.7											85.2	49.6			32.04
46	60.0	52.5											83.3	48.5			33.52
47	58.8	51.4											81.4	47.4			35.02
48	57.5	50.3											79.7	46.4			36.56
49	56.4	49.3											78.0	45.5			38.14
50	55.2	48.3											76.4	44.5			39.74
Area	28.75	25.75	40.00	37.00	33.20	30.20	25.00	21.20	In. ²								
S ₁ -1	258.9	226.6	378.5	343.6	306.1	270.9	204.6	165.5	In. ³								
Wt. per Ft.	98.0	87.6	136.0	125.8	113.0	102.8	85.0	72.2	Lbs.								

Loads above horizontal lines correspond to end reactions based on maximum allowable stresses in flange rivets. Web stiffeners should be provided in accordance with Construction Specifications. Weights given for girders do not include stiffeners, rivet heads or other details.

RIVETED PLATE GIRDERS

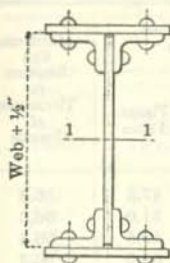

To obtain a girder suitable to carry any specified loading, determine the maximum end reaction in pounds and the maximum bending moment in inch-pounds.

Select from the table a girder having the desired depth, a thickness of web as determined by the maximum end reaction and a suitable section modulus as determined by dividing the bending moment by the permissible stress per square inch.

For limiting conditions see explanatory notes and Construction Specifications.

Weights given do not include stiffeners, rivet heads, or other details.

Section Modulus, Axis 1-1, Inches ³	Size in Inches			Weight per Foot, Pounds		Maximum End Reaction in Thousands of Pounds
	Web Plate	Flange Angles	Flange Plates	Web Plate and Flange Angles	Flange Plates	
136.6	24 x 5/16	4 x 3 x 3/8		59.5		50.6
168.6		4 x 3 x 1/2		69.9		50.6
198.7		5 x 3 1/2 x 1/2		79.9		50.6
236.1		5 x 3 1/2 x 5/8		92.7		50.6
338.0		5 x 3 1/2 x 1/2	12 x 1/2	79.9	40.8	50.6
372.9		5 x 3 1/2 x 1/2	12 x 3/4	79.9	51.0	50.6
408.5		5 x 3 1/2 x 5/8	12 x 5/8	92.7	51.0	50.6
142.5	24 x 3/8	4 x 3 x 3/8		64.6		60.8
165.5		5 x 3 1/2 x 3/8		72.2		60.8
174.5		4 x 3 x 1/2		75.0		60.8
204.5		4 x 3 x 5/8		85.0		60.8
204.6		5 x 3 1/2 x 1/2		85.0		60.8
242.0		5 x 3 1/2 x 5/8		97.8		60.8
270.9		5 x 3 1/2 x 3/8	12 x 3/8	72.2	30.6	60.8
306.1	5 x 3 1/2 x 3/8	12 x 1/2	72.2	40.8	60.8	
343.6	5 x 3 1/2 x 1/2	12 x 1/2	85.0	40.8	60.8	
378.5	5 x 3 1/2 x 1/2	12 x 5/8	85.0	51.0	60.8	
414.1	5 x 3 1/2 x 5/8	12 x 5/8	97.8	51.0	60.8	
151.5	26 x 5/16	4 x 3 x 3/8		61.6		56.3
176.8		5 x 3 1/2 x 3/8		69.2		56.3
186.6		4 x 3 x 1/2		72.0		56.3
201.2		6 x 4 x 3/8		76.8		56.3
219.6		5 x 3 1/2 x 1/2		82.0		56.3
252.0		6 x 4 x 1/2		92.4		56.3
260.7		5 x 3 1/2 x 5/8		94.8		56.3
291.3		5 x 3 1/2 x 3/8	12 x 3/8	69.2	30.6	56.3
301.0		6 x 4 x 5/8		107.6		56.3
329.5		5 x 3 1/2 x 3/8	12 x 1/2	69.2	40.8	56.3
334.8		6 x 4 x 3/8	14 x 3/8	76.8	35.7	56.3
370.7		5 x 3 1/2 x 1/2	12 x 1/2	82.0	40.8	56.3
379.4		6 x 4 x 3/8	14 x 1/2	76.8	47.6	56.3
408.6	5 x 3 1/2 x 1/2	12 x 5/8	82.0	51.0	56.3	

CARNEGIE STEEL COMPANY

RIVETED PLATE GIRDERS—Continued

Section Modulus, Axis 1-1, Inches ³	Size in Inches			Weight per Foot, Pounds		Maximum End Reaction in Thousands of Pounds	
	Web Plate	Flange Angles	Flange Plates	Web Plate and Flange Angles	Flange Plates		
428.4	26 x 5/16	6x 4 x 1/2	14 x 1/2	92.4	47.6	56.3	
447.9		5x 3 1/2 x 5/8	12 x 5/8	94.8	51.0	56.3	
472.7		6x 4 x 1/2	14 x 3/8	92.4	59.5	56.3	
519.5		6x 4 x 5/8	14 x 5/8	107.6	59.5	56.3	
563.4		6x 4 x 3/4	14 x 3/4	107.6	71.4	56.3	
158.5			4x 3 x 3/8		67.2		67.5
183.8		5x 3 1/2 x 3/8		74.8		67.5	
193.5		4x 3 x 1/2		77.6		67.5	
208.1		6x 4 x 3/8		82.4		67.5	
226.5		4x 3 x 5/8		87.6		67.5	
226.6		5x 3 1/2 x 1/2		87.6		67.5	
258.9		6x 4 x 1/2		98.0		67.5	
267.6		5x 3 1/2 x 5/8		100.4		67.5	
298.0		5x 3 1/2 x 3/8	12 x 3/8	74.8	30.6	67.5	
307.9		6x 4 x 5/8		113.2		67.5	
336.2	26 x 3/4	5x 3 1/2 x 3/8	12 x 1/2	74.8	40.8	67.5	
341.5		6x 4 x 3/8	14 x 3/8	82.4	35.7	67.5	
354.4		6x 4 x 3/4		127.6		67.5	
377.4		5x 3 1/2 x 1/2	12 x 1/2	87.6	40.8	67.5	
386.1		6x 4 x 3/8	14 x 1/2	82.4	47.6	67.5	
415.2		5x 3 1/2 x 1/2	12 x 5/8	87.6	51.0	67.5	
435.1		6x 4 x 1/2	14 x 1/2	98.0	47.6	67.5	
454.5		5x 3 1/2 x 5/8	12 x 5/8	100.4	51.0	67.5	
479.3		6x 4 x 1/2	14 x 5/8	98.0	59.5	67.5	
526.1		6x 4 x 5/8	14 x 3/8	113.2	59.5	67.5	
569.9		6x 4 x 3/8	14 x 3/4	113.2	71.4	67.5	
613.9		6x 4 x 3/4	14 x 3/4	127.6	71.4	67.5	
200.4			4x 3 x 1/2		83.1		78.8
233.4			4x 3 x 5/8		93.1		78.8
233.5		5x 3 1/2 x 1/2		93.1		78.8	
265.8		6x 4 x 1/2		103.5		78.8	
274.5		5x 3 1/2 x 5/8		105.9		78.8	
314.8		6x 4 x 5/8		118.7		78.8	
361.3		6x 4 x 3/4		133.1		78.8	
384.0	26 x 1/2	5x 3 1/2 x 1/2	12 x 1/2	93.1	40.8	78.8	
421.8		5x 3 1/2 x 1/2	12 x 5/8	93.1	51.0	78.8	
441.7		6x 4 x 1/2	14 x 1/2	103.5	47.6	78.8	
461.1		5x 3 1/2 x 5/8	12 x 5/8	105.9	51.0	78.8	
485.9		6x 4 x 1/2	14 x 5/8	103.5	59.5	78.8	
532.7		6x 4 x 5/8	14 x 5/8	118.7	59.5	78.8	
576.5		6x 4 x 3/8	14 x 3/4	118.7	71.4	78.8	
620.5		6x 4 x 3/4	14 x 3/4	133.1	71.4	78.8	

RIVETED GIRDERS

RIVETED PLATE GIRDERS—Continued

Section Modulus, Axis 1-1, Inches ³	Size in Inches			Weight per Foot, Pounds		Maximum End Reaction in Thousands of Pounds
	Web Plate	Flange Angles	Flange Plates	Web Plate and Flange Angles	Flange Plates	
185.6		5 x 3½ x ¾		70.3		56.3
211.0		6 x 4 x ¾		77.9		56.3
230.3		5 x 3½ x ½		83.1		56.3
264.1		6 x 4 x ½		93.5		56.3
273.2		5 x 3½ x ¾		95.9		56.3
304.5		5 x 3½ x ¾	12 x ¾	70.3	30.6	56.3
315.3		6 x 4 x ¾		108.7		56.3
344.2		5 x 3½ x ¾	12 x ½	70.3	40.8	56.3
349.8	27 x ¾	6 x 4 x ¾	14 x ¾	77.9	35.7	56.3
387.3		5 x 3½ x ½	12 x ½	83.1	40.8	56.3
396.2		6 x 4 x ¾	14 x ½	77.9	47.6	56.3
426.7		5 x 3½ x ½	12 x ¾	83.1	51.0	56.3
447.4		6 x 4 x ½	14 x ½	93.5	47.6	56.3
467.7		5 x 3½ x ¾	12 x ¾	95.9	51.0	56.3
493.4		6 x 4 x ½	14 x ¾	93.5	59.5	56.3
542.4		6 x 4 x ¾	14 x ¾	108.7	59.5	56.3
588.0		6 x 4 x ¾	14 x ¾	108.7	71.4	56.3
193.1		5 x 3½ x ¾		76.0		67.5
218.5		6 x 4 x ¾		83.6		67.5
237.8		5 x 3½ x ½		88.8		67.5
271.5		6 x 4 x ½		99.2		67.5
280.6		5 x 3½ x ¾		101.6		67.5
311.7		5 x 3½ x ¾	12 x ¾	76.0	30.6	67.5
322.7		6 x 4 x ¾		114.4		67.5
351.4		5 x 3½ x ¾	12 x ½	76.0	40.8	67.5
357.1		6 x 4 x ¾	14 x ¾	83.6	35.7	67.5
371.4	27 x ¾	6 x 4 x ¾		128.8		67.5
394.5		5 x 3½ x ½	12 x ½	88.8	40.8	67.5
403.4		6 x 4 x ¾	14 x ½	83.6	47.6	67.5
417.9		6 x 4 x ¾		143.2		67.5
433.8		5 x 3½ x ½	12 x ¾	88.8	51.0	67.5
454.6		6 x 4 x ½	14 x ½	99.2	47.6	67.5
474.8		5 x 3½ x ¾	12 x ¾	101.6	51.0	67.5
500.5		6 x 4 x ½	14 x ¾	99.2	59.5	67.5
549.5		6 x 4 x ¾	14 x ¾	114.4	59.5	67.5
595.1		6 x 4 x ¾	14 x ¾	114.4	71.4	67.5
641.2		6 x 4 x ¾	14 x ¾	128.8	71.4	67.5
245.2		5 x 3½ x ½		94.6		78.8
279.0	27 x ¾	6 x 4 x ½		105.0		78.8
288.1		5 x 3½ x ¾		107.4		78.8
330.2		6 x 4 x ¾		120.2		78.8

CARNEGIE STEEL COMPANY

RIVETED PLATE GIRDERS—Continued

Section Modulus, Axis 1-1, Inches ³	Size in Inches			Weight per Foot, Pounds		Maximum End Reaction in Thousands of Pounds
	Web Plate	Flange Angles	Flange Plates	Web Plate and Flange Angles	Flange Plates	
378.8		6 x 4 x 3/4		134.6		78.8
401.7		5 x 3 1/2 x 1/2	12 x 1/2	94.6	40.8	78.8
425.3		6 x 4 x 7/8		149.0		78.8
440.9		5 x 3 1/2 x 1/2	12 x 5/8	94.6	51.0	78.8
461.8	27 x 7/16	6 x 4 x 1/2	14 x 1/2	105.0	47.6	78.8
482.0		5 x 3 1/2 x 5/8	12 x 5/8	107.4	51.0	78.8
507.7		6 x 4 x 1/2	14 x 5/8	105.0	59.5	78.8
556.6		6 x 4 x 5/8	14 x 5/8	120.2	59.5	78.8
602.4		6 x 4 x 5/8	14 x 3/4	120.2	71.4	78.8
648.2		6 x 4 x 3/4	14 x 3/4	134.6	71.4	78.8
194.5		5 x 3 1/2 x 5/8		71.4		56.3
221.0		6 x 4 x 5/8		79.0		56.3
241.1		5 x 3 1/2 x 1/2		84.2		56.3
276.3		6 x 4 x 1/2		94.6		56.3
285.8		5 x 3 1/2 x 5/8		97.0		56.3
317.8		5 x 3 1/2 x 5/8	12 x 3/8	71.4	30.6	56.3
329.7		6 x 4 x 5/8		109.8		56.3
359.0		5 x 3 1/2 x 5/8	12 x 1/2	71.4	40.8	56.3
365.0	28 x 5/16	6 x 4 x 3/4	14 x 3/8	79.0	35.7	56.3
404.0		5 x 3 1/2 x 1/2	12 x 1/2	84.2	40.8	56.3
413.1		6 x 4 x 3/4	14 x 1/2	79.0	47.6	56.3
444.8		5 x 3 1/2 x 1/2	12 x 5/8	84.2	51.0	56.3
466.5		6 x 4 x 1/2	14 x 1/2	94.6	47.6	56.3
487.6		5 x 3 1/2 x 5/8	12 x 5/8	97.0	51.0	56.3
514.2		6 x 4 x 1/2	14 x 5/8	94.6	59.5	56.3
565.4		6 x 4 x 5/8	14 x 5/8	109.8	59.5	56.3
612.7		6 x 4 x 5/8	14 x 3/4	109.8	71.4	56.3
202.5		5 x 3 1/2 x 5/8		77.3		67.5
229.0		6 x 4 x 5/8		84.9		67.5
249.1		5 x 3 1/2 x 1/2		90.1		67.5
284.3		6 x 4 x 1/2		100.5		67.5
293.8		5 x 3 1/2 x 5/8		102.9		67.5
325.6		5 x 3 1/2 x 5/8	12 x 3/8	77.3	30.6	67.5
337.7	28 x 3/8	6 x 4 x 5/8		115.7		67.5
366.7		5 x 3 1/2 x 5/8	12 x 1/2	77.3	40.8	67.5
372.8		6 x 4 x 3/4	14 x 3/8	84.9	35.7	67.5
388.5		6 x 4 x 3/4		130.1		67.5
411.7		5 x 3 1/2 x 1/2	12 x 1/2	90.1	40.8	67.5
420.8		6 x 4 x 5/8	14 x 1/2	84.9	47.6	67.5
437.0		6 x 4 x 3/4		144.5		67.5
452.5		5 x 3 1/2 x 1/2	12 x 5/8	90.1	51.0	67.5

RIVETED GIRDERS

RIVETED PLATE GIRDERS—Continued

Section Modulus, Axis 1-1, Inches ³	Size in Inches			Weight per Foot, Pounds		Maximum End Reaction in Thousands of Pounds	
	Web Plates	Flange Angles	Flange Plates	Web Plate and Flange Angles	Flange Plates		
474.3	28 x 3/8	6 x 4 x 1/2	14 x 1/2	100.5	47.6	67.5	
495.3		5 x 3 1/2 x 5/8	12 x 5/8	102.9	51.0	67.5	
521.9		6 x 4 x 1/2	14 x 5/8	100.5	59.5	67.5	
573.1		6 x 4 x 5/8	14 x 5/8	115.7	59.5	67.5	
620.4		6 x 4 x 3/4	14 x 3/4	115.7	71.4	67.5	
668.6		6 x 4 x 3/4	14 x 3/4	130.1	71.4	67.5	
257.1	28 x 7/16	5 x 3 1/2 x 1/2		96.1		78.8	
292.4		6 x 4 x 1/2		106.5		78.8	
301.8		5 x 3 1/2 x 5/8		108.9		78.8	
345.8		6 x 4 x 5/8		121.7		78.8	
396.5		6 x 4 x 3/4		136.1		78.8	
419.5		5 x 3 1/2 x 1/2	12 x 1/2	96.1	40.8	78.8	
445.1		6 x 4 x 7/8		150.5		78.8	
460.2		5 x 3 1/2 x 1/2	12 x 5/8	96.1	51.0	78.8	
482.0		6 x 4 x 1/2	14 x 1/2	106.5	47.6	78.8	
503.0		5 x 3 1/2 x 5/8	12 x 5/8	108.9	51.0	78.8	
529.6		6 x 4 x 1/2	14 x 5/8	106.5	59.5	78.8	
580.8		6 x 4 x 5/8	14 x 5/8	121.7	59.5	78.8	
628.0		6 x 4 x 3/4	14 x 3/4	121.7	71.4	78.8	
676.2		6 x 4 x 3/4	14 x 3/4	136.1	71.4	78.8	
221.8		30 x 5/8	5 x 3 1/2 x 3/8		79.9		74.3
250.5			6 x 4 x 3/8		87.5		74.3
272.1			5 x 3 1/2 x 1/2		92.7		74.3
310.3			6 x 4 x 1/2		103.1		74.3
320.5	5 x 3 1/2 x 5/8			105.5		74.3	
353.8	5 x 3 1/2 x 3/8		12 x 3/8	79.9	30.6	74.3	
366.2	5 x 3 1/2 x 3/4			117.5		74.3	
368.1	6 x 4 x 3/8			118.3		74.3	
397.8	5 x 3 1/2 x 3/8		12 x 1/2	79.9	40.8	74.3	
404.7	6 x 4 x 3/8		14 x 3/8	87.5	35.7	74.3	
423.1	6 x 4 x 3/4			132.7		74.3	
446.6	5 x 3 1/2 x 1/2		12 x 1/2	92.7	40.8	74.3	
456.1	6 x 4 x 3/8		14 x 1/2	87.5	47.6	74.3	
475.8	6 x 4 x 7/8			147.1		74.3	
490.3	5 x 3 1/2 x 1/2		12 x 5/8	92.7	51.0	74.3	
514.0	6 x 4 x 1/2		14 x 1/2	103.1	47.6	74.3	
536.7	5 x 3 1/2 x 5/8		12 x 5/8	105.5	51.0	74.3	
565.1	6 x 4 x 1/2		14 x 5/8	103.1	59.5	74.3	
620.6	6 x 4 x 5/8		14 x 5/8	118.3	59.5	74.3	
671.3	6 x 4 x 3/4		14 x 3/4	118.3	71.4	74.3	
723.8	6 x 4 x 3/4	14 x 3/4	132.7	71.4	74.3		

CARNEGIE STEEL COMPANY

RIVETED PLATE GIRDERS—Continued

Section Modulus, Axis 1-1, Inches ³	Size in Inches			Weight per Foot, Pounds		Maximum End Reaction in Thousands of Pounds
	Web Plates	Flange Angles	Flange Plates	Web Plate and Flange Angles	Flange Plates	
281.4		5x3 1/2x 1/2		99.0		86.6
319.5		6x 4 x 1/2		109.4		86.6
329.7		5x3 1/2x 5/8		111.8		86.6
375.5		5x3 1/2x 3/4		123.8		86.6
377.3		6x 4 x 5/8		124.6		86.6
432.3		6x 4 x 3/4		139.0		86.6
455.5		5x3 1/2x 1/2	12 x 1/2	99.0	40.8	86.6
485.0	30 x 7/16	6x 4 x 3/4		153.4		86.6
499.2		5x3 1/2x 1/2	12 x 5/8	99.0	51.0	86.6
523.0		6x 4 x 1/2	14 x 1/2	109.4	47.6	86.6
545.6		5x3 1/2x 5/8	12 x 5/8	111.8	51.0	86.6
574.0		6x 4 x 1/2	14 x 5/8	109.4	59.5	86.6
629.5		6x 4 x 5/8	14 x 5/8	124.6	59.5	86.6
680.1		6x 4 x 3/4	14 x 3/4	124.6	71.4	86.6
732.6		6x 4 x 3/4	14 x 3/4	139.0	71.4	86.6
290.6		5x3 1/2x 1/2		105.4		99.0
328.8		6x 4 x 1/2		115.8		99.0
338.9		5x3 1/2x 5/8		118.2		99.0
384.7		5x3 1/2x 3/4		130.2		99.0
386.5		6x 4 x 5/8		131.0		99.0
441.5		6x 4 x 3/4		145.4		99.0
464.4		5x3 1/2x 1/2	12 x 1/2	105.4	40.8	99.0
494.2	30 x 1/2	6x 4 x 3/4		159.8		99.0
508.0		5x3 1/2x 1/2	12 x 5/8	105.4	51.0	99.0
531.9		6x 4 x 1/2	14 x 1/2	115.8	47.6	99.0
554.5		5x3 1/2x 5/8	12 x 5/8	118.2	51.0	99.0
582.8		6x 4 x 1/2	14 x 5/8	115.8	59.5	99.0
638.3		6x 4 x 5/8	14 x 5/8	131.0	59.5	99.0
688.9		6x 4 x 3/4	14 x 3/4	131.0	71.4	99.0
741.3		6x 4 x 3/4	14 x 3/4	145.4	71.4	99.0
251.7		5x3 1/2x 3/8		83.7		81.0
283.7		6x 4 x 3/8		91.3		81.0
307.7		5x3 1/2x 1/2		96.5		81.0
308.4		6x 6 x 3/8		101.7		121.5
350.3		6x 4 x 1/2		106.9		81.0
361.5	33 x 3/4	5x3 1/2x 5/8		109.3		81.0
383.6		6x 6 x 1/2		120.5		121.5
396.9		5x3 1/2x 3/8	12 x 3/8	83.7	30.6	81.0
412.5		5x3 1/2x 3/4		121.3		81.0
414.7		6x 4 x 5/8		122.1		81.0
445.5		5x3 1/2x 5/8	12 x 1/2	83.7	40.8	81.0
453.4		6x 4 x 3/8	14 x 3/8	91.3	35.7	81.0

RIVETED PLATE GIRDERS—Continued

Section Modulus, Axis 1-1, Inches ³	Size in Inches			Weight per Foot, Pounds		Maximum End Reaction in Thousands of Pounds
	Web Plate	Flange Angles	Flange Plates	Web Plate and Flange Angles	Flange Plates	
455.9		6x 6 x 3/4		138.9		121.5
476.1		6x 4 x 3/4		136.5		81.0
477.6		6x 6 x 3/4	14 x 3/4	101.7	35.7	121.5
499.8		5x3 1/2 x 1/2	12 x 1/2	96.5	40.8	81.0
510.0		6x 4 x 3/4	14 x 1/2	91.3	47.6	81.0
525.4		6x 6 x 3/4		156.9		121.5
534.1		6x 6 x 3/4	14 x 1/2	101.7	47.6	121.5
548.0		5x3 1/2 x 1/2	12 x 3/4	96.5	51.0	81.0
574.7		6x 4 x 1/2	14 x 3/4	106.9	47.6	81.0
590.6		6x 6 x 3/4	14 x 3/4	101.7	59.5	121.5
592.6	33 x 3/4	6x 6 x 3/4		174.5		121.5
599.9		5x3 1/2 x 3/4	12 x 3/4	109.3	51.0	81.0
607.1		6x 6 x 1/2	14 x 1/2	120.5	47.6	121.5
630.9		6x 4 x 1/2	14 x 3/4	106.9	59.5	81.0
663.1		6x 6 x 1/2	14 x 3/4	120.5	59.5	121.5
693.0		6x 4 x 3/4	14 x 3/4	122.1	59.5	81.0
719.2		6x 6 x 1/2	14 x 3/4	120.5	71.4	121.5
732.7		6x 6 x 3/4	14 x 3/4	138.9	59.5	121.5
748.9		6x 4 x 3/4	14 x 3/4	122.1	71.4	81.0
788.3		6x 6 x 3/4	14 x 3/4	138.9	71.4	121.5
807.6		6x 4 x 3/4	14 x 3/4	136.5	71.4	81.0
854.9		6x 6 x 3/4	14 x 3/4	156.9	71.4	121.5
318.9		5x3 1/2 x 1/2		103.5		94.5
361.5		6x 4 x 1/2		113.9		94.5
372.7		5x3 1/2 x 3/4		116.3		94.5
394.8		6x 6 x 1/2		127.5		141.8
423.7		5x3 1/2 x 3/4		128.3		94.5
425.8		6x 4 x 3/4		129.1		94.5
467.0		6x 6 x 3/4		145.9		141.8
487.2		6x 4 x 3/4		143.5		94.5
510.7	33 x 3/4	5x3 1/2 x 1/2	12 x 1/2	103.5	40.8	94.5
536.6		6x 6 x 3/4		163.9		141.8
558.8		5x3 1/2 x 1/2	12 x 3/4	103.5	51.0	94.5
585.6		6x 4 x 1/2	14 x 1/2	113.9	47.6	94.5
603.8		6x 6 x 3/4		181.5		141.8
610.6		5x3 1/2 x 3/4	12 x 3/4	116.3	51.0	94.5
617.9		6x 6 x 1/2	14 x 1/2	127.5	47.6	141.8
641.7		6x 4 x 1/2	14 x 3/4	113.9	59.5	94.5
673.9		6x 6 x 1/2	14 x 3/4	127.5	59.5	141.8
703.8		6x 4 x 3/4	14 x 3/4	129.1	59.5	94.5

CARNEGIE STEEL COMPANY

RIVETED PLATE GIRDERS—Continued

Section Modulus, Axis 1-1, Inches ²	Size in Inches			Weight per Foot, Pounds		Maximum End Reaction in Thousands of Pounds
	Web Plates	Flange Angles	Flange Plates	Web Plate and Flange Angles	Flange Plates	
729.9	33 x 3/4	6x 6 x 1/2	14 x 3/4	127.5	71.4	141.8
743.5		6x 6 x 5/8	14 x 5/8	145.9	59.5	141.8
759.6		6x 4 x 5/8	14 x 3/4	129.1	71.4	94.5
799.0		6x 6 x 5/8	14 x 3/4	145.9	71.4	141.8
818.3		6x 4 x 3/4	14 x 3/4	143.5	71.4	94.5
865.6		6x 6 x 3/4	14 x 3/4	163.9	71.4	141.8
330.0	33 x 1/2	5x 3 1/2 x 1/2		110.5		108.0
372.6		6x 4 x 1/2		120.9		108.0
383.9		5x 3 1/2 x 5/8		123.3		108.0
406.0		6x 6 x 1/2		134.5		162.0
434.9		5x 3 1/2 x 3/4		135.3		108.0
437.0		6x 4 x 5/8		136.1		108.0
478.2		6x 6 x 5/8		152.9		162.0
498.4		6x 4 x 3/4		150.5		108.0
521.5		5x 3 1/2 x 1/2	12 x 1/2	110.5	40.8	108.0
547.8		6x 6 x 3/4		170.9		162.0
569.5		5x 3 1/2 x 1/2	12 x 5/8	110.5	51.0	108.0
596.4		6x 4 x 1/2	14 x 1/2	120.9	47.6	108.0
615.0	6x 6 x 3/8		188.5		162.0	
621.4	5x 3 1/2 x 5/8	12 x 5/8	123.3	51.0	108.0	
628.8	6x 6 x 1/2	14 x 1/2	134.5	47.6	162.0	
652.5	6x 4 x 1/2	14 x 5/8	120.9	59.5	108.0	
684.6	6x 6 x 1/2	14 x 5/8	134.5	59.5	162.0	
714.5	6x 4 x 5/8	14 x 5/8	136.1	59.5	108.0	
740.6	6x 6 x 1/2	14 x 3/4	134.5	71.4	162.0	
754.3	6x 6 x 5/8	14 x 5/8	152.9	59.5	162.0	
770.3	6x 4 x 5/8	14 x 3/4	136.1	71.4	108.0	
809.7	6x 6 x 5/8	14 x 3/4	152.9	71.4	162.0	
829.0	6x 4 x 3/4	14 x 3/4	150.5	71.4	108.0	
876.3	6x 6 x 3/4	14 x 3/4	170.9	71.4	162.0	
318.0	36 x 3/4	6x 4 x 3/8		95.1		87.8
344.4		5x 3 1/2 x 1/2		100.3		87.8
346.9		6x 6 x 3/8		105.5		135.0
391.4		6x 4 x 1/2		110.7		87.8
403.7		5x 3 1/2 x 5/8		113.1		87.8
430.3		6x 6 x 1/2		124.3		135.0
460.0		5x 3 1/2 x 3/4		125.1		87.8
462.4		6x 4 x 5/8		125.9		87.8
503.3		6x 4 x 3/8	14 x 3/8	95.1	35.7	87.8
510.5		6x 6 x 5/8		142.7		135.0
530.2		6x 4 x 3/4		140.3		87.8
531.6		6x 6 x 3/8	14 x 3/8	105.5	35.7	135.0

RIVETED GIRDERS

RIVETED PLATE GIRDERS—Continued

Section Modulus, Axis I-I, Inches ³	Size in Inches			Weight per Foot, Pounds		Maximum End Reaction in Thousands of Pounds
	Web Plates	Flange Angles	Flange Plates	Web Plate and Flange Angles	Flange Plates	
554.3		5x3½x½	12 x ½	100.3	40.8	87.8
565.1		6x 4 x ¾	14 x ½	95.1	47.6	87.8
593.2		6x 6 x ¾	14 x ½	105.5	47.6	135.0
595.3		6x 4 x ¾		154.7		87.8
606.8		5x3½x½	12 x ¾	100.3	51.0	87.8
636.5		6x 4 x ¾	14 x ½	110.7	47.6	87.8
654.9		6x 6 x ¾	14 x ¾	105.5	59.5	135.0
664.2	36 x ¾	5x3½x¾	12 x ¾	113.1	51.0	87.8
674.4		6x 6 x ¾	14 x ½	124.3	47.6	135.0
698.0		6x 4 x ¾	14 x ¾	110.7	59.5	87.8
735.5		6x 6 x ¾	14 x ¾	124.3	59.5	135.0
766.6		6x 4 x ¾	14 x ¾	125.9	59.5	87.8
796.8		6x 6 x ¾	14 x ¾	124.3	71.4	135.0
813.1		6x 6 x ¾	14 x ¾	142.7	59.5	135.0
827.6		6x 4 x ¾	14 x ¾	125.9	71.4	87.8
873.8		6x 6 x ¾	14 x ¾	142.7	71.4	135.0
892.8		6x 4 x ¾	14 x ¾	140.3	71.4	87.8
357.7		5x3½x½		108.0		102.4
404.7		6x 4 x ¾		118.4		102.4
417.0		5x3½x¾		120.8		102.4
443.6		6x 6 x ¾		132.0		157.5
473.3		5x3½x¾		132.8		102.4
475.7		6x 4 x ¾		133.6		102.4
523.8		6x 6 x ¾		150.4		157.5
543.5		6x 4 x ¾		148.0		102.4
567.2		5x3½x½	12 x ½	108.0	40.8	102.4
608.6	36 x ⅞	6x 4 x ¾		162.4		102.4
619.7		5x3½x½	12 x ¾	108.0	51.0	102.4
649.5		6x 4 x ¾	14 x ½	118.4	47.6	102.4
677.1		5x3½x¾	12 x ¾	120.8	51.0	102.4
687.3		6x 6 x ¾	14 x ½	132.0	47.6	157.5
710.8		6x 4 x ¾	14 x ¾	118.4	59.5	102.4
748.4		6x 6 x ¾	14 x ¾	132.0	59.5	157.5
779.5		6x 4 x ¾	14 x ¾	133.6	59.5	102.4
809.5		6x 6 x ¾	14 x ¾	132.0	71.4	157.5
825.9		6x 6 x ¾	14 x ¾	150.4	59.5	157.5
840.4		6x 4 x ¾	14 x ¾	133.6	71.4	102.4
886.6		6x 6 x ¾	14 x ¾	150.4	71.4	157.5
905.5		6x 4 x ¾	14 x ¾	148.0	71.4	102.4

CARNEGIE STEEL COMPANY

RIVETED PLATE GIRDERS—Continued

Section Modulus, Axis 1-1, Inches ²	Size in Inches			Weight per Foot, Pounds		Maximum End Reaction in Thousands of Pounds
	Web Plates	Flange Angles	Flange Plates	Web Plate and Flange Angles	Flange Plates	
418.0		6 x 4 x 1/2		126.0		117.0
456.9		6 x 6 x 1/2		139.6		180.0
489.0		6 x 4 x 5/8		141.2		117.0
537.1		6 x 6 x 5/8		158.0		180.0
556.9		6 x 4 x 3/4		155.6		117.0
614.5		6 x 6 x 3/4		176.0		180.0
621.9		6 x 4 x 3/4		170.0		117.0
662.5		6 x 4 x 1/2	14 x 1/2	126.0	47.6	117.0
689.2		6 x 6 x 3/4		193.6		180.0
700.3		6 x 6 x 1/2	14 x 1/2	139.6	47.6	180.0
723.7		6 x 4 x 1/2	14 x 5/8	126.0	59.5	117.0
761.3	36 x 1/2	6 x 6 x 1/2	14 x 5/8	139.6	59.5	180.0
792.3		6 x 4 x 5/8	14 x 5/8	141.2	59.5	117.0
822.3		6 x 6 x 1/2	14 x 3/4	139.6	71.4	180.0
838.8		6 x 6 x 5/8	14 x 5/8	158.0	59.5	180.0
853.2		6 x 4 x 5/8	14 x 3/4	141.2	71.4	117.0
899.4		6 x 6 x 5/8	14 x 3/4	158.0	71.4	180.0
918.3		6 x 4 x 3/4	14 x 3/4	155.6	71.4	117.0
973.7		6 x 6 x 3/4	14 x 3/4	176.0	71.4	180.0
1039.4		6 x 4 x 3/4	14 x 1	155.6	95.2	117.0
1094.1		6 x 6 x 3/4	14 x 1	176.0	95.2	180.0
1101.1		6 x 4 x 3/4	14 x 1	170.0	95.2	117.0
1164.9		6 x 6 x 3/4	14 x 1	193.6	95.2	180.0
444.7		6 x 4 x 1/2		141.3		146.3
483.5		6 x 6 x 1/2		154.9		225.0
515.7		6 x 4 x 5/8		156.5		146.3
563.7		6 x 6 x 5/8		173.3		225.0
583.5		6 x 4 x 3/4		170.9		146.3
641.2		6 x 6 x 3/4		191.3		225.0
648.5		6 x 4 x 3/4		185.3		146.3
688.4	36 x 5/8	6 x 4 x 1/2	14 x 1/2	141.3	47.6	146.3
715.8		6 x 6 x 3/4		208.9		225.0
726.2		6 x 6 x 1/2	14 x 1/2	154.9	47.6	
749.4		6 x 4 x 1/2	14 x 5/8	141.3	59.5	146.3
787.0		6 x 6 x 1/2	14 x 5/8	154.9	59.5	225.0
818.1		6 x 4 x 5/8	14 x 5/8	156.5	59.5	146.3
847.9		6 x 6 x 1/2	14 x 3/4	154.9	71.4	225.0
864.6		6 x 6 x 5/8	14 x 5/8	173.3	59.5	225.0
878.8		6 x 4 x 5/8	14 x 3/4	156.5	71.4	146.3
924.9		6 x 6 x 5/8	14 x 3/4	173.3	71.4	225.0

RIVETED GIRDERS

RIVETED PLATE GIRDERS—Continued

Section Modulus, Axis 1-1, Inches ³	Size in Inches			Weight per Foot, Pounds		Maximum End Reaction in Thousands of Pounds
	Web Plates	Flange Angles	Flange Plates	Web Plate and Flange Angles	Flange Plates	
943.9		6 x 4 x 3/4	14 x 3/4	170.9	71.4	146.3
999.3		6 x 6 x 3/4	14 x 3/4	191.3	71.4	225.0
1045.9		6 x 6 x 3/8	14 x 1	173.3	95.2	225.0
1064.7	36 x 3/8	6 x 4 x 3/4	14 x 1	170.9	95.2	146.3
1119.3		6 x 6 x 3/4	14 x 1	191.3	95.2	225.0
1126.3		6 x 4 x 3/8	14 x 1	185.3	95.2	146.3
1190.1		6 x 6 x 3/8	14 x 1	208.9	95.2	225.0
390.2		6 x 4 x 3/8		102.8		101.3
427.5		6 x 6 x 3/8		113.2		157.5
477.2		6 x 4 x 1/2		118.4		101.3
527.2		6 x 6 x 1/2		132.0		157.5
561.4		6 x 4 x 3/8		133.6		101.3
606.6		6 x 4 x 3/8	14 x 3/8	102.8	35.7	101.3
623.5		6 x 6 x 3/8		150.4		157.5
638.3		6 x 4 x 3/8	16 x 3/8	102.8	40.8	101.3
642.1		6 x 4 x 3/4		148.0		101.3
643.2		6 x 6 x 3/8	14 x 3/8	113.2	35.7	157.5
675.1		6 x 6 x 3/8	16 x 3/8	113.2	40.8	157.5
678.6		6 x 4 x 3/8	14 x 1/2	102.8	47.6	101.3
715.2		6 x 6 x 3/8	14 x 1/2	113.2	47.6	157.5
716.5		6 x 6 x 3/4		168.4		157.5
719.5		6 x 4 x 3/8		162.4		101.3
757.7		6 x 6 x 3/8	16 x 1/2	113.2	54.4	157.5
763.7	42 x 3/8	6 x 4 x 1/2	14 x 1/2	118.4	47.6	101.3
787.2		6 x 6 x 3/8	14 x 3/8	113.2	59.5	157.5
806.2		6 x 4 x 1/2	16 x 1/2	118.4	54.4	101.3
806.4		6 x 6 x 3/8		186.0		157.5
812.7		6 x 6 x 1/2	14 x 1/2	132.0	47.6	157.5
835.5		6 x 4 x 1/2	14 x 3/8	118.4	59.5	101.3
855.2		6 x 6 x 1/2	16 x 1/2	132.0	54.4	157.5
884.2		6 x 6 x 1/2	14 x 3/8	132.0	59.5	157.5
917.3		6 x 4 x 3/8	14 x 3/8	133.6	59.5	101.3
937.3		6 x 6 x 1/2	16 x 3/8	132.0	68.0	157.5
955.7		6 x 6 x 1/2	14 x 3/4	132.0	71.4	157.5
970.4		6 x 4 x 3/8	16 x 3/8	133.6	68.0	101.3
977.6		6 x 6 x 3/8	14 x 3/8	150.4	59.5	157.5
988.7		6 x 4 x 3/8	14 x 3/4	133.6	71.4	101.3
1030.8		6 x 6 x 3/8	16 x 3/8	150.4	68.0	157.5
1048.6		6 x 6 x 3/8	14 x 3/4	150.4	71.4	157.5
1066.6		6 x 4 x 3/4	14 x 3/4	148.0	71.4	101.3
1112.4		6 x 6 x 3/8	16 x 3/4	150.4	81.6	157.5

CARNEGIE STEEL COMPANY

RIVETED PLATE GIRDERS—Continued

Section Modulus, Axis 1-1, Inches ³	Size in Inches			Weight per Foot, Pounds		Maximum End Reaction in Thousands of Pounds
	Web Plates	Flange Angles	Flange Plates	Web Plate and Flange Angles	Flange Plates	
1130.4		6 x 4 x 3/4	16 x 3/4	148.0	81.6	101.3
1138.5		6 x 6 x 3/4	14 x 3/4	168.4	71.4	157.5
1194.1		6 x 6 x 5/8	16 x 3/8	150.4	95.2	157.5
1202.3	42 x 3/8	6 x 6 x 3/4	16 x 3/4	168.4	81.6	157.5
1283.5		6 x 6 x 3/4	16 x 3/4	168.4	95.2	157.5
1286.4		6 x 4 x 7/8	16 x 7/8	162.4	95.2	101.3
1369.9		6 x 6 x 7/8	16 x 7/8	186.0	95.2	157.5
495.3		6 x 4 x 1/2		127.3		118.1
545.4		6 x 6 x 1/2		140.9		183.8
579.5		6 x 4 x 5/8		142.5		118.1
641.6		6 x 6 x 5/8		159.3		183.8
660.2		6 x 4 x 3/4		156.9		118.1
734.7		6 x 6 x 3/4		177.3		183.8
737.6		6 x 4 x 7/8		171.3		118.1
781.5		6 x 4 x 1/2	14 x 1/2	127.3	47.6	118.1
824.0		6 x 4 x 1/2	16 x 1/2	127.3	54.4	118.1
824.6		6 x 6 x 7/8		194.9		183.8
830.4		6 x 6 x 1/2	14 x 1/2	140.9	47.6	183.8
853.1		6 x 4 x 1/2	14 x 5/8	127.3	59.5	118.1
872.9		6 x 6 x 1/2	16 x 1/2	140.9	54.4	183.8
901.8		6 x 6 x 1/2	14 x 5/8	140.9	59.5	183.8
934.9	42 x 7/16	6 x 4 x 5/8	14 x 5/8	142.5	59.5	118.1
954.9		6 x 6 x 1/2	16 x 5/8	140.9	68.0	183.8
973.2		6 x 6 x 1/2	14 x 3/4	140.9	71.4	183.8
988.1		6 x 4 x 5/8	16 x 5/8	142.5	68.0	118.1
995.3		6 x 6 x 5/8	14 x 5/8	159.3	59.5	183.8
1006.2		6 x 4 x 5/8	14 x 3/4	142.5	71.4	118.1
1048.4		6 x 6 x 5/8	16 x 5/8	159.3	68.0	183.8
1066.2		6 x 6 x 5/8	14 x 3/4	150.3	71.4	183.8
1084.1		6 x 4 x 3/4	14 x 3/4	156.9	71.4	118.1
1129.9		6 x 6 x 5/8	16 x 3/4	159.3	81.6	183.8
1147.9		6 x 4 x 3/4	16 x 3/4	156.9	81.6	118.1
1156.0		6 x 6 x 3/4	14 x 3/4	177.3	71.4	183.8
1211.6		6 x 6 x 5/8	16 x 7/8	159.3	95.2	183.8
1219.8		6 x 6 x 3/4	16 x 3/4	177.3	81.6	183.8
1300.9		6 x 6 x 3/4	16 x 7/8	177.3	95.2	183.8
1387.3		6 x 6 x 7/8	16 x 7/8	194.9	95.2	183.8
513.5		6 x 4 x 1/2		136.2		135.0
563.5		6 x 6 x 1/2		149.8		210.0
597.7	42 x 1/2	6 x 4 x 5/8		151.4		135.0
659.8		6 x 6 x 5/8		168.2		210.0
678.4		6 x 4 x 3/4		165.8		135.0

RIVETED GIRDERS

RIVETED PLATE GIRDERS—Continued

Section Modulus, Axis 1-1, Inches ³ ,	Size in Inches			Weight per Foot, Pounds		Maximum End Reaction in Thousands of Pounds
	Web Plates	Flange Angles	Flange Plates	Web Plate and Flange Angles	Flange Plates	
752.8		6 x 6 x 3/4		186.2		210.0
755.8		6 x 4 x 3/8		180.2		135.0
799.2		6 x 4 x 1/2	14 x 1/2	136.2	47.6	135.0
841.7		6 x 4 x 3/4	16 x 1/2	136.2	54.4	135.0
842.7		6 x 6 x 3/8		203.8		210.0
848.1		6 x 6 x 1/2	14 x 1/2	149.8	47.6	210.0
870.8		6 x 4 x 1/2	14 x 5/8	136.2	59.5	135.0
890.6		6 x 6 x 1/2	16 x 1/2	149.8	54.4	210.0
919.4		6 x 6 x 1/2	14 x 5/8	149.8	59.5	210.0
952.6		6 x 4 x 5/8	14 x 5/8	151.4	59.5	135.0
972.6		6 x 6 x 1/2	16 x 5/8	149.8	68.0	210.0
990.8		6 x 6 x 1/2	14 x 3/4	149.8	71.4	210.0
1005.7		6 x 4 x 5/8	16 x 5/8	151.4	68.0	135.0
1012.9	42 x 1/2	6 x 6 x 5/8	14 x 5/8	168.2	59.5	210.0
1023.7		6 x 4 x 5/8	14 x 3/4	151.4	71.4	135.0
1066.0		6 x 6 x 5/8	16 x 5/8	168.2	68.0	210.0
1083.7		6 x 6 x 5/8	14 x 3/4	168.2	71.4	210.0
1101.7		6 x 4 x 3/4	14 x 3/4	165.8	71.4	135.0
1147.5		6 x 6 x 5/8	16 x 3/4	168.2	81.6	210.0
1165.4		6 x 4 x 3/4	16 x 3/4	165.8	81.6	135.0
1173.6		6 x 6 x 3/4	14 x 3/4	186.2	71.4	210.0
1229.0		6 x 6 x 5/8	16 x 3/8	168.2	95.2	210.0
1237.4		6 x 6 x 3/4	16 x 3/4	186.2	81.6	210.0
1318.4		6 x 6 x 3/4	16 x 3/8	186.2	95.2	210.0
1321.2		6 x 4 x 3/8	16 x 3/8	180.2	95.2	135.0
1404.7		6 x 6 x 3/8	16 x 3/8	203.8	95.2	210.0
466.9		6 x 4 x 3/8		110.4		121.5
512.7		6 x 6 x 3/8		120.8		180.0
567.4		6 x 4 x 1/2		126.0		121.5
628.9		6 x 6 x 1/2		139.6		180.0
664.9		6 x 4 x 5/8		141.2		121.5
714.4		6 x 4 x 3/4	14 x 3/4	110.4	35.7	121.5
741.3		6 x 6 x 5/8		158.0		180.0
750.8		6 x 4 x 3/4	16 x 3/4	110.4	40.8	121.5
758.5	48 x 3/4	6 x 4 x 3/4		155.6		121.5
759.5		6 x 6 x 3/4	14 x 3/4	120.8	35.7	180.0
795.9		6 x 6 x 3/8	16 x 3/8	120.8	40.8	180.0
797.0		6 x 4 x 3/8	14 x 1/2	110.4	47.6	121.5
841.9		6 x 6 x 3/8	14 x 1/2	120.8	47.6	180.0
848.3		6 x 4 x 3/8		170.0		121.5
850.1		6 x 6 x 3/4		176.0		180.0
890.4		6 x 6 x 3/4	16 x 1/2	120.8	54.4	180.0
895.5		6 x 4 x 1/2	14 x 1/2	126.0	47.6	121.5

CARNEGIE STEEL COMPANY

RIVETED PLATE GIRDERS—Continued

Section Modulus, Axis 1-1, Inches ²	Size in Inches			Weight per Foot, Pounds		Maximum End Reaction in Thousands of Pounds
	Web Plates	Flange Angles	Flange Plates	Web Plate and Flange Angles	Flange Plates	
924.3		6 x 6 x 3/8	14 x 3/8	120.8	59.5	180.0
944.0		6 x 4 x 1/2	16 x 1/2	126.0	54.4	121.5
955.2		6 x 6 x 3/8		193.6		180.0
955.8		6 x 6 x 1/2	14 x 1/2	139.6	47.6	180.0
977.7		6 x 4 x 1/2	14 x 3/8	126.0	59.5	121.5
1004.3		6 x 6 x 1/2	16 x 1/2	139.6	54.4	180.0
1037.6		6 x 6 x 1/2	14 x 3/8	139.6	59.5	180.0
1072.7		6 x 4 x 3/8	14 x 3/8	141.2	59.5	121.5
1098.2		6 x 6 x 1/2	16 x 3/8	139.6	68.0	180.0
1119.5		6 x 6 x 1/2	14 x 3/4	139.6	71.4	180.0
1133.3		6 x 4 x 3/8	16 x 3/8	141.2	68.0	121.5
1147.1	48 x 3/8	6 x 6 x 3/8	14 x 3/8	158.0	59.5	180.0
1154.4		6 x 4 x 3/8	14 x 3/4	141.2	71.4	121.5
1207.8		6 x 6 x 3/8	16 x 3/8	158.0	68.0	180.0
1228.4		6 x 6 x 3/8	14 x 3/4	158.0	71.4	180.0
1245.2		6 x 4 x 3/4	14 x 3/4	155.6	71.4	121.5
1301.2		6 x 6 x 3/8	16 x 3/4	158.0	81.6	180.0
1317.9		6 x 4 x 3/4	16 x 3/4	155.6	81.6	121.5
1334.0		6 x 6 x 3/8	14 x 3/4	176.0	71.4	180.0
1394.7		6 x 6 x 3/8	16 x 3/8	158.0	95.2	180.0
1406.7		6 x 6 x 3/4	16 x 3/4	176.0	81.6	180.0
1498.1		6 x 4 x 3/8	16 x 3/8	170.0	95.2	121.5
1499.7		6 x 6 x 3/8	16 x 3/8	176.0	95.2	180.0
1601.3		6 x 6 x 3/8	16 x 3/8	193.6	95.2	180.0
591.2		6 x 4 x 1/2		136.2		141.8
652.7		6 x 6 x 1/2		149.8		210.0
688.7		6 x 4 x 3/8		151.4		141.8
765.0		6 x 6 x 3/8		168.2		210.0
782.3		6 x 4 x 3/4		165.8		141.8
872.1		6 x 4 x 3/8		180.2		141.8
873.8		6 x 6 x 3/4		186.2		210.0
918.8		6 x 4 x 1/2	14 x 1/2	136.2	47.6	141.8
967.3	48 x 7/16	6 x 4 x 1/2	16 x 1/2	136.2	54.4	141.8
979.0		6 x 6 x 3/8		203.8		210.0
979.0		6 x 6 x 1/2	14 x 1/2	149.8	47.6	210.0
1000.8		6 x 4 x 1/2	14 x 3/8	136.2	59.5	141.8
1027.6		6 x 6 x 1/2	16 x 1/2	149.8	54.4	210.0
1060.8		6 x 6 x 1/2	14 x 3/8	149.8	59.5	210.0
1095.8		6 x 4 x 3/8	14 x 3/8	151.4	59.5	141.8
1121.4		6 x 6 x 1/2	16 x 3/8	149.8	68.0	210.0
1142.5		6 x 6 x 1/2	14 x 3/4	149.8	71.4	210.0
1156.5		6 x 4 x 3/8	16 x 3/8	151.4	68.0	141.8

RIVETED GIRDERS

RIVETED PLATE GIRDERS—Continued

Section Modulus, Axis 1-1, Inches ³	Size in Inches			Weight per Foot, Pounds		Maximum End Reaction in Thousands of Pounds	
	Web Plates	Flange Angles	Flange Plates	Web Plate and Flange Angles	Flange Plates		
1170.3	48 x 7/16	6 x 6 x 3/8	14 x 3/8	168.2	59.5	210.0	
1177.4		6 x 4 x 3/8	14 x 3/8	151.4	71.4	141.8	
1230.9		6 x 6 x 3/8	16 x 3/8	168.2	68.0	210.0	
1251.5		6 x 6 x 3/8	14 x 3/8	168.2	71.4	210.0	
1268.2		6 x 4 x 3/8	14 x 3/8	165.8	71.4	141.8	
1324.3		6 x 6 x 3/8	16 x 3/8	168.2	81.6	210.0	
1341.0		6 x 4 x 3/8	16 x 3/8	165.8	81.6	141.8	
1357.0		6 x 6 x 3/8	14 x 3/8	180.2	71.4	210.0	
1417.7		6 x 6 x 3/8	16 x 3/8	168.2	95.2	210.0	
1429.8		6 x 6 x 3/8	16 x 3/8	186.2	81.6	210.0	
1521.0		6 x 4 x 3/8	16 x 3/8	180.2	95.2	141.8	
1522.7		6 x 6 x 3/8	16 x 3/8	186.2	95.2	210.0	
1624.2		6 x 6 x 3/8	16 x 3/8	203.8	95.2	210.0	
615.0		48 x 1/2	6 x 4 x 1/2		146.4		162.0
676.4			6 x 6 x 1/2		160.0		240.0
712.4			6 x 4 x 3/8		161.6		162.0
788.8			6 x 6 x 3/8		178.4		240.0
806.0	6 x 4 x 3/8			176.0		162.0	
895.8	6 x 4 x 3/8			190.4		162.0	
897.6	6 x 6 x 3/8			196.4		240.0	
942.1	6 x 4 x 1/2		14 x 1/2	146.4	47.6	162.0	
990.6	6 x 4 x 1/2		16 x 1/2	146.4	54.4	162.0	
1002.3	6 x 6 x 1/2		14 x 1/2	160.0	47.6	240.0	
1002.7	6 x 6 x 3/8			214.0		240.0	
1024.0	6 x 4 x 1/2		14 x 3/8	146.4	59.5	162.0	
1050.8	6 x 6 x 1/2		16 x 1/2	160.0	54.4	240.0	
1083.9	6 x 6 x 3/8		14 x 3/8	160.0	59.5	240.0	
1119.0	6 x 4 x 3/8		14 x 3/8	161.6	59.5	162.0	
1144.5	6 x 6 x 1/2		16 x 3/8	160.0	68.0	240.0	
1165.6	6 x 6 x 1/2		14 x 3/8	160.0	71.4	240.0	
1179.6	6 x 4 x 3/8		16 x 3/8	161.6	68.0	162.0	
1193.4	6 x 6 x 3/8		14 x 3/8	178.4	59.5	240.0	
1200.5	6 x 4 x 3/8		14 x 3/8	161.6	71.4	162.0	
1254.1	6 x 6 x 3/8		16 x 3/8	178.4	68.0	240.0	
1274.5	6 x 6 x 3/8		14 x 3/8	178.4	71.4	240.0	
1291.2	6 x 4 x 3/8		14 x 3/8	176.0	71.4	162.0	
1347.3	6 x 6 x 3/8		16 x 3/8	178.4	81.6	240.0	
1364.0	6 x 4 x 3/8		16 x 3/8	176.0	81.6	162.0	
1380.0	6 x 6 x 3/8		14 x 3/8	196.4	71.4	240.0	
1440.6	6 x 6 x 3/8		16 x 3/8	178.4	95.2	240.0	
1452.8	6 x 6 x 3/8		16 x 3/8	196.4	81.6	240.0	
1543.9	6 x 4 x 3/8		16 x 3/8	190.4	95.2	162.0	
1545.6	6 x 6 x 3/8		16 x 3/8	196.4	95.2	240.0	
1647.1	6 x 6 x 3/8		16 x 3/8	214.0	95.2	240.0	

CARNEGIE STEEL COMPANY

RIVETED PLATE GIRDERS—Concluded

Section Modulus, Axis 1-1, Inches ³	Size in Inches			Weight per Foot, Pounds		Maximum End Reaction in Thousands of Pounds
	Web Plates	Flange Angles	Flange Plates	Web Plate and Flange Angles	Flange Plates	
194.7	24 x 5/16	6 x 6 x 3/8		85.1		67.5
245.7		6 x 6 x 1/2		103.9		67.5
294.2		6 x 6 x 5/8		122.3		67.5
340.7		6 x 6 x 3/4		140.3		67.5
200.6	24 x 3/8	6 x 6 x 3/8		90.2		81.0
251.5		6 x 6 x 1/2		109.0		81.0
300.1		6 x 6 x 5/8		127.4		81.0
346.6		6 x 6 x 3/4		145.4		81.0
216.6	26 x 5/16	6 x 6 x 3/8		87.2		78.8
272.9		6 x 6 x 1/2		106.0		78.8
326.7		6 x 6 x 5/8		124.4		78.8
378.2		6 x 6 x 3/4		142.4		78.8
223.5	26 x 3/8	6 x 6 x 3/8		92.8		94.5
279.8		6 x 6 x 1/2		111.6		94.5
333.6		6 x 6 x 5/8		130.0		94.5
385.2		6 x 6 x 3/4		148.0		94.5
230.4	26 x 7/16	6 x 6 x 3/8		98.3		110.3
286.7		6 x 6 x 1/2		117.1		110.3
340.5		6 x 6 x 5/8		135.5		110.3
392.1		6 x 6 x 3/4		153.5		110.3
227.8	27 x 5/16	6 x 6 x 3/8		88.3		78.8
286.8		6 x 6 x 1/2		107.1		78.8
343.1		6 x 6 x 5/8		125.5		78.8
397.3		6 x 6 x 3/4		143.5		78.8
235.2	27 x 3/8	6 x 6 x 3/8		94.0		94.5
294.2		6 x 6 x 1/2		112.8		94.5
350.6		6 x 6 x 5/8		131.2		94.5
404.7		6 x 6 x 3/4		149.2		94.5
242.7	27 x 7/16	6 x 6 x 3/8		99.8		110.3
301.7		6 x 6 x 1/2		118.6		110.3
358.1		6 x 6 x 5/8		137.0		110.3
412.2		6 x 6 x 3/4		155.0		110.3
271.2	30 x 3/8	6 x 6 x 3/8		97.9		108.0
338.3		6 x 6 x 1/2		116.7		108.0
402.6		6 x 6 x 5/8		135.1		108.0
464.4		6 x 6 x 3/4		153.1		108.0
280.4	30 x 7/16	6 x 6 x 3/8		104.2		126.0
347.5		6 x 6 x 1/2		123.0		126.0
411.8		6 x 6 x 5/8		141.4		126.0
473.6		6 x 6 x 3/4		159.4		126.0
289.6	30 x 1/2	6 x 6 x 3/8		110.6		144.0
356.7		6 x 6 x 1/2		129.4		144.0
421.0		6 x 6 x 5/8		147.8		144.0
482.8		6 x 6 x 3/4		165.8		144.0

STRESSES IN COLUMNS AND STRUTS

Compression members in structures are called posts, struts or columns. No exact theoretical formula has been found which will give the strength of such members under various conditions of loading. The formulas in current use are based on the assumption that the members under stress may fail by direct compression, by compression and bending combined, or by bending alone. The empirical formulas based on these assumptions practically agree with results obtained by experiment on full size members. These experiments show that steel columns of ordinary sizes and lengths fail at nearly a constant stress which corresponds to the yield point of that material, and that the load which will cause a column to fail decreases in the ratio of its length to its least lateral dimension.

Radius of Gyration. As the strength of a column depends on its ability to resist flexural stress, the moment of inertia of its cross section is an important factor in the determination of its carrying capacity. For the purpose of computation, however, it is much more convenient to use the radius of gyration which depends on the moment of inertia.

Ratio of Slenderness. The ratio of slenderness is ratio of the unsupported length of a compression member to its radius of gyration, generally the least radius, excepting when the unsupported length of a column is rigidly braced in such a manner as to prevent deflection of the column in the direction which corresponds to the least radius of gyration. Columns, excepting those of square or circular section, have two principal radii of gyration. It is, therefore, necessary to determine the radii of gyration of such columns and to use the proper ratio of slenderness in any particular case.

The unit stresses for different ratios of slenderness, given in the Construction Specifications and on page 220, are consistent with present practice in column construction, and their use does not involve the refinements of the more complicated formulas, which refinements are often vitiated by uncertainties in the application of loads or other practical features.

The Construction Specifications limit the maximum ratio of slenderness to 120 for main members under steady stresses. For secondary members under temporary stress, such as those used in wind bracing, higher ratios may be used, but in no case should the ratio exceed 200.

Form and Size of Section. Important as it may be to have the metal in the column section distributed as far as possible from the neutral axis, that is, with as large a radius of gyration as possible, considerations of ease in fabrication and simplicity in connections are of greater weight. The economical column section is not that which affords the least weight of metal in the shaft, but that which, with a reasonable radius of gyration, provides the least weight of member, shaft and details with the minimum amount of riveting. Modern practice, therefore, eliminates earlier forms of construction which represented the minimum amount of metal for the maximum radius of gyration, such, for example, as the column composed of three I-beams or one I-beam and two channels placed either with the flanges in or the flanges out. The Z-bar column has also fallen into disuse, likewise a number of patented sections and other sections shown in earlier editions of this publication.

The most practical column is one the surfaces of which are readily accessible for painting and, therefore, it is desirable to use open angle and plate columns rather than closed channel and plate columns.

The column sections should be of such size as to permit ready framing of beams and girders thereto and so placed in the construction as to permit the simplest details. Experience indicates that eight inches is the smallest desirable dimension in ordinary building work. For struts and light loads, smaller angle columns are still in use, while the H-beams are excellent for such purposes. I-beams and single angles may be used with economy where the conditions of lengths and loading permit.

Explanation of Tables. The tables which immediately follow give the safe loads in thousands of pounds on H-beam and I-beam columns and on a selected line of channel and angle columns which, in the light of experience, seem to be desirable for use in ordinary building and bridge construction. In addition to the safe loads, they give moments of inertia and radii of gyration about both axes of symmetry, areas of sections, and weights in pounds per foot without allowance for rivet heads or other details.

These tables have been computed for the least radius of gyration in accordance with the formula given in the construction specifications. The values may be adjusted to other formulas or to different values of the ratio of slenderness by use of the comparative tables on pages 220 and 221. These tables are also suitable for use in figuring columns so braced against flexure, that their safe strength may be computed for the greater radius of gyration.

Combined Bending and Compression Stresses. It is assumed in the tables that the loads are direct and equally distributed over the cross section of the column or balanced on opposite sides thereof. In the case of beams carried on brackets or other forms of eccentric loading, bending stresses are produced which should be taken into consideration and the column sections so proportioned that the combined fiber stresses do not exceed the allowable axial compressive stresses. There is no direct simple solution of this problem; the following trial method is suited to the tables:—

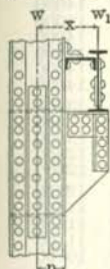

Let

W = Direct load, in pounds.

W_1 = Eccentric load, in pounds.

M = Bending moment due to eccentric load, in inch pounds = W_1x

I = Moment of inertia of column in direction of bending.

n = Extreme fiber distance in direction of bending.

A = Area of column section, in square inches.

f = Allowable axial unit compression, in pounds per square inch; then f should be equal to or greater than $\frac{W+W_1}{A} + \frac{Mn}{I}$ the fiber stresses due to compression and bending respectively.

RULE:—Assume a section in excess of that required for the direct compression $W + W_1$ and compute the combined fiber stress. If it works out too large or too small, try again.

EXAMPLE:—Required to select a plate and angle column 20 feet long to sustain a balanced load of 210,000 pounds and an eccentric load of 40,000 pounds applied 15 inches from the column center on axis 1-1.

Assume a section made up of 14"x $\frac{3}{8}$ " web plate, four angles 6"x4"x $\frac{7}{16}$ " and two flange plates 14"x $\frac{3}{8}$ ", page 240.

$A = 32.47$, $I_{1-1} = 1351$, $r_{2-2} = 3.09$, ratio of slenderness = $20 \times 12 + 3.09 = 77$.

Allowable fiber stress, $19,000 - 100 \text{ l/r} = 11,300$ pounds per square inch.

Actual fiber stress = $\frac{210,000 + 40,000}{32.47} + \frac{40,000 \times 15 \times 7.625}{1351} = 7,700 + 3,390 =$

11,090 pounds per square inch.

CARNEGIE STEEL COMPANY

COMPARISON OF COMPRESSION FORMULAS
ALLOWABLE UNIT STRESSES IN POUNDS PER SQUARE INCH

Ratio	American Bridge Co.	A. R. E. Association	New York, 1917	Chicago, 1919	Philadelphia, 1919	St. Louis 1917
$\frac{1}{r}$	Construction Specification, Page 95	$16000-70\frac{1}{r}$	$16000-70\frac{1}{r}$	$16000-70\frac{1}{r}$	$\frac{16250}{1+\frac{1}{11000r^2}}$	$16000-70\frac{1}{r}$
0	13000	14000	16000	14000	16250	14000
5	13000	14000	15650	14000	16213	14000
10	13000	14000	15300	14000	16104	14000
15	13000	14000	14950	14000	15924	14000
20	13000	14000	14600	14000	15680	14000
25	13000	14000	14250	14000	15376	14000
30	13000	13900	13900	13900	15020	13900
35	13000	13550	13550	13550	14622	13550
40	13000	13200	13200	13200	14186	13200
45	13000	12850	12850	12850	13724	12850
50	13000	12500	12500	12500	13241	12500
55	13000	12150	12150	12150	12745	12150
60	13000	11800	11800	11800	12243	11800
65	12500	11450	11450	11450	11741	11450
70	12000	11100	11100	11100	11242	11100
75	11500	10750	10750	10750	10752	10750
80	11000	10400	10400	10400	10272	10400
85	10500	10050	10050	10050	9808	10050
90	10000	9700	9700	9700	9359	9700
95	9500	9350	9350	9350	8926	9350
100	9000	9000	9000	9000	8512	9000
105	8500	8650	8650	8650	8116	8650
110	8000	8300	8300	8300	7738	8300
115	7500	7950	7950	7950	7378	7950
120	7000	7600	7600	7600	7037	7600
125	6750			7250	6714	7250
130	6500			6900	6407	6900
135	6250			6550	6116	6550
140	6000			6200	5842	6200
145	5750			5850		5850
150	5500			5500		5500
155	5250					5150
160	5000					4800
165	4750					4450
170	4500					4100
175	4250					3750
180	4000					3400
185	3750					3050
190	3500					2700
195	3250					2350
200	3000					2000

MAXIMUM RATIO OF $\frac{1}{r}$

Compression Formula	Main Members	Secondary Members	Compression Formula	Main Members	Secondary Members
American Bridge Company.	120	200	Chicago Bldg. Law, 1919..	120	150
American R'y Engrg. Ass'n.	100	120	Phila. Bldg. Law, 1919....	140	140
New York Bldg. Law, 1917.	120	120	St. Louis Bldg. Law, 1917.	120	200

COLUMN SAFE LOADS

COMPARISON OF COMPRESSION FORMULAS

ALLOWABLE UNIT STRESSES IN POUNDS PER SQUARE INCH

Ratio	Boston, 1919	Cleveland, 1920	Baltimore, 1908	Pittsburgh, 1914	Cincinnati, 1917	Rankine
$\frac{1}{r}$	$20000-100\frac{1}{r}$	Cleveland Building Code Part 2	$1 + \frac{15000}{13500r^2}$	$19000-100\frac{1}{r}$ and $13000-50\frac{1}{r}$	$17100-57\frac{1}{r}$	$1 + \frac{12500}{36000r^2}$
0	12000	15000	15000	13000	13000	12500
5	12000	14910	14972	13000	13000	12492
10	12000	14930	14890	13000	13000	12465
15	12000	14870	14754	13000	13000	12422
20	12000	14770	14568	13000	13000	12363
25	12000	14630	14336	13000	13000	12287
30	12000	14460	14062	13000	13000	12195
35	12000	14250	13752	13000	13000	12088
40	12000	14000	13411	13000	13000	11968
45	12000	13700	13043	13000	13000	11834
50	12000	13350	12657	13000	13000	11688
55	12000	12950	12254	13000	13000	11531
60	12000	12500	11842	13000	13000	11364
65	12000	12030	11425	12500	13000	11187
70	12000	11540	11005	12000	13000	11002
75	12000	11000	10588	11500	12825	10811
80	12000	10440	10176	11000	12540	10313
85	11500	9850	9771	10500	12255	10410
90	11000	9290	9375	10000	11970	10204
95	10500	8750	8990	9500	11685	9995
100	10000	8220	8617	9000	11400	9784
105	9500	7720	8257	8500	11115	9571
110	9000	7240	7910	8000	10830	9356
115	8500	6800	7577	7500	10545	9142
120	8000	6380	7258	7000	10260	8929
125	7500	5980	6953	6750	9975	8717
130	7000	5600	6661	6500	9690	8507
135	6500	5260	6383	6250	9405	8299
140	6000	4950	6118	6000	9120	8094
145	5500	4660	5865	5750	8835	7892
150	5000	4390	5625	5500	8550	7692
155	4500	4140	5396		8265	7495
160	4000	3900	5179		7980	7305
165		3690	4972		7695	7118
170		3520	4776		7410	6934
175		3340	4589		7125	6754
180		3170	4412		6840	6579
185		3010	4243			6408
190		2870	4083			6242
195		2740	3930			6080
200		2620	3785			5921

MAXIMUM RATIOS OF $\frac{1}{r}$

Compression Formula	Main Members	Secondary Members	Compression Formula	Main Members	Secondary Members
Boston Bldg. Law, 1919...	160	160	Pittsburgh Bldg. Law, 1914	120	150
Cleveland Bldg. Law, 1920.	120	200	Cincinnati Bldg. Law, 1917	180	180
Baltimore Bldg. Law, 1908.	120	...	Rankine.....	200	200

CARNEGIE STEEL COMPANY

BEAM COLUMNS

SAFE LOAD IN THOUSANDS OF POUNDS

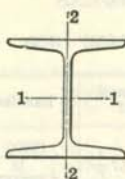

Allowable Fiber Stress per square inch, 13,000 pounds for lengths of 60 radii or under, reduced for lengths over 60 radii; see Construction Specifications.

Weights do not include details.

Effective Length in Feet	I-Beams											
	24 in.		20 in.		18 in.		15 in.		12 in.		10 in.	9 in.
	105.9 lb.	79.9 lb.	81.4 lb.	65.4 lb.	75.6 lb.	54.7 lb.	60.8 lb.	42.9 lb.	40.8 lb.	31.8 lb.	25.4 lb.	21.8 lb.
3	402.7	303.2	308.5	248.0	286.5	207.1	229.7	162.3	153.9	120.3	95.9	82.1
4	402.7	303.2	308.5	248.0	286.5	207.1	229.7	162.3	153.9	120.3	95.9	82.1
5	402.7	303.2	308.5	248.0	286.5	207.1	229.7	162.3	153.9	120.3	94.3	78.0
6	402.7	303.2	308.5	248.0	286.5	207.1	229.7	154.1	146.0	110.1	85.1	69.7
7	402.7	298.6	307.4	229.8	286.5	186.7	213.3	140.3	132.9	99.1	76.0	61.3
8	402.3	278.0	286.9	210.9	272.7	170.1	195.8	126.4	119.7	88.2	66.8	52.9
9	379.0	257.4	266.4	192.0	254.5	153.5	178.3	112.6	106.6	77.2	57.7	44.5
10	355.7	236.7	245.9	173.0	236.2	136.9	160.8	98.7	93.4	66.2	50.1	40.2
11	332.4	216.1	223.4	154.0	218.0	120.3	142.3	86.1	81.6	60.0	45.5	36.0
12	309.1	195.4	204.9	135.1	199.7	107.6	125.8	79.2	75.0	54.5	40.9	31.8
13	285.8	174.8	184.4	124.8	181.5	99.3	116.0	72.3	68.4	49.1	36.3	27.6
14	262.5	158.7	165.0	115.4	163.2	91.1	107.3	65.4	61.8	43.6	31.7	23.4
15	239.2	148.4	154.8	105.9	149.6	82.8	98.5	58.4	55.3	38.1	27.2	19.2
16	215.9	138.1	144.5	96.4	140.5	74.5	89.8	51.5	48.7	32.6	22.6	
17	204.7	127.8	134.3	86.9	131.4	66.2	81.0	44.6	42.1	27.1		
18	193.1	117.4	124.0	77.5	122.2	57.9	72.3	37.7	35.5			
19	181.4	107.1	113.8	68.0	113.1	49.6	63.5					
20	169.8	96.8	103.5	58.5	104.0		54.8					
21	158.2	86.5	93.3		94.9							
22	146.5	76.2	83.0		85.7							
23	134.9	65.8	72.7		76.6							
24	123.2				67.5							
25	111.6											
26	99.9											
27	88.3											
28												
29												
30												
Area, in. ²	30.98	23.33	23.74	19.08	22.04	15.94	17.68	12.49	11.84	9.26	7.38	6.32
I ₁₋₁ , in. ⁴	2811.5	2087.2	1466.3	1169.5	1141.8	795.5	609.0	441.8	268.9	215.8	122.1	84.9
I ₁₋₁ , in.	9.53	9.46	7.86	7.83	7.20	7.07	5.87	5.95	4.77	4.83	4.07	3.67
I ₂₋₂ , in. ⁴	78.9	42.9	45.8	27.9	46.3	21.2	26.0	14.6	13.8	9.5	6.9	5.2
I ₂₋₂ , in.	1.60	1.36	1.39	1.21	1.45	1.15	1.21	1.08	1.08	1.01	0.97	0.90
Weight, Lbs. per Foot	105.9	79.9	81.4	65.4	75.6	54.7	60.8	42.9	40.8	31.8	25.4	21.8

Safe load values above upper zigzag line are for ratios of l/r not over 60, those between the zigzag line are for ratios up to 120 l/r and those below lower zigzag line are for ratios not over 200 l/r.

BEAM COLUMNS

BEAM COLUMNS

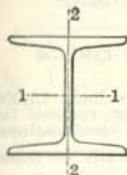

SAFE LOADS IN THOUSANDS OF POUNDS

Allowable Fiber Stress per square inch, 13,000 pounds for lengths of 60 radii or under, reduced for lengths over 60 radii; see Construction Specifications.

Weights do not include details.

Effective Length in Feet	I-Beams					H Beams							
	8 in.	7 in.	6 in.	5 in.	4 in.	8 in.			6 in.			5 in.	4 in.
	18.4 lb.	15.3 lb.	12.5 lb.	10.0 lb.	7.7 lb.	37.7 lb.	34.3 lb.	32.6 lb.	26.7 lb.	24.1 lb.	22.8 lb.	18.9 lb.	13.8 lb.
3	69.3	57.5	46.9	37.3	28.5	143.0	130.0	123.6	100.9	91.1	86.2	71.1	51.9
4	69.3	56.7	44.4	33.5	24.0	143.0	130.0	123.6	100.9	91.1	86.2	71.1	51.9
5	63.3	49.9	38.3	28.2	19.5	143.0	130.0	123.6	100.9	91.1	86.2	71.1	50.5
6	55.7	43.1	32.3	22.9	15.2	143.0	130.0	123.6	100.9	91.1	86.2	71.1	45.5
7	48.1	36.2	26.2	18.9	13.0	143.0	130.0	123.6	100.9	91.1	86.2	65.6	40.4
8	40.5	30.2	22.7	16.3	10.8	143.0	130.0	123.6	95.1	86.7	82.5	60.1	35.3
9	35.1	26.8	19.7	13.6	8.5	143.0	130.0	123.6	88.5	80.9	77.1	54.6	30.3
10	31.3	23.4	16.7	11.0	6.3	136.9	126.0	120.5	82.0	75.1	71.7	49.1	26.6
11	27.5	19.9	13.6	8.3		129.7	119.6	114.5	75.4	69.3	66.2	43.7	24.0
12	23.7	16.5	10.6			122.5	113.2	108.5	68.9	63.5	60.8	38.2	21.5
13	19.9	13.1				115.3	106.8	102.5	62.4	57.6	55.4	35.5	19.0
14	16.1					108.1	100.4	96.5	55.8	51.8	49.9	32.7	16.4
15						100.9	93.9	90.4	51.8	47.5	45.5	30.0	13.9
16						93.7	87.5	84.4	48.5	44.6	42.7	27.3	
17						86.4	81.1	78.4	45.2	41.7	40.0	24.5	
18						79.2	74.7	72.4	42.0	38.8	37.3	21.8	
19						74.5	69.2	66.5	38.7	35.9	34.6	19.1	
20						70.9	66.0	63.5	35.4	33.0	31.9	16.3	
21						67.3	62.8	60.5	32.2	30.1	29.2		
22						63.7	59.6	57.5	28.9	27.2	26.5		
23						60.1	56.4	54.4	25.6	24.3	23.7		
24						56.5	53.2	51.4	22.3	21.4	21.0		
25						52.9	50.0	48.4					
26						49.3	46.8	45.4					
27						45.7	43.6	42.4					
28						42.1	40.4	39.4					
29						38.5	37.2	36.4					
30						34.9	33.9	33.4					
Area, in. ²	5.34	4.43	3.61	2.87	2.21	11.00	10.00	9.50	7.76	7.01	6.63	5.47	3.99
I ₁₋₁ , in. ⁴	56.9	36.2	21.8	12.1	6.0	120.8	115.5	112.8	47.4	45.1	44.0	23.8	10.7
I ₂₋₂ , in. ⁴	3.26	2.86	2.46	2.05	1.64	3.31	3.40	3.45	2.47	2.54	2.58	2.08	1.64
I ₃₋₃ , in. ⁴	3.8	2.7	1.8	1.2	0.77	36.9	35.1	34.2	15.7	14.7	14.2	7.8	3.6
I ₄₋₄ , in. ⁴	0.84	0.78	0.72	0.65	0.59	1.83	1.87	1.90	1.42	1.45	1.46	1.20	0.95
Weight, Lbs. per Foot	18.4	15.3	12.5	10.0	7.7	37.7	34.3	32.6	26.7	24.1	22.8	18.9	13.8

Safe load values above upper zigzag line are for ratios of l/r not over 60, those between the zigzag lines are for ratios up to 120 l/r and those below lower zigzag line are for ratios not over 200 l/r .

10-INCH CHANNEL COLUMNS

SAFE LOADS IN THOUSANDS OF POUNDS

Allowable Fiber Stress per square inch, 13,000 pounds for lengths of 60 radii or under, reduced for lengths over 60 radii; see Construction Specifications.

Weights do not include rivet heads or other details.

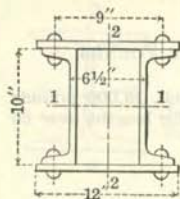

Effective Length in Feet	2-10 in. Chan. Latticed			2-10 in. Channels, 2-12 in. Plates													
	16.3 lb. Channels, Single Lattice	20 lb. Channels, Single Lattice	25 lb. Channels, Single Lattice	15.3 lb. Channels, 5/16 in. Plates	15.3 lb. Channels, 3/8 in. Plates	15.3 lb. Channels, 1/2 in. Plates	15.3 lb. Channels, 5/8 in. Plates	20 lb. Channels, 1/2 in. Plates	20 lb. Channels, 3/4 in. Plates	20 lb. Channels, 1/2 in. Plates	20 lb. Channels, 5/8 in. Plates	25 lb. Channels, 5/8 in. Plates	25 lb. Channels, 3/4 in. Plates	30 lb. Channels, 3/4 in. Plates	30 lb. Channels, 5/8 in. Plates	35 lb. Channels, 5/8 in. Plates	35 lb. Channels, 3/4 in. Plates
11	116	152	191	214	233	253	272	289	308	328	347	366	386	404	424	443	462
12	116	152	191	214	233	253	272	289	308	328	347	366	386	404	424	443	462
13	116	152	191	214	233	253	272	289	308	328	347	366	386	404	424	443	462
14	116	152	191	214	233	253	272	289	308	328	347	366	386	404	424	443	462
15	116	152	191	214	233	253	272	289	308	328	347	366	386	404	424	443	462
16	116	152	191	214	233	253	272	289	308	328	347	366	386	404	424	443	462
17	116	152	191	214	233	253	272	289	308	328	347	366	386	403	423	436	456
18	116	151	186	214	233	252	272	285	305	323	343	358	377	392	411	424	443
19	115	147	181	208	227	246	265	278	297	315	334	348	367	380	399	412	430
20	112	143	175	203	221	239	257	270	288	307	324	339	357	369	388	399	418
21	109	139	170	197	215	233	250	263	280	298	315	329	346	358	376	387	405
22	106	136	165	192	209	226	243	255	272	289	306	319	336	347	365	374	392
23	104	132	160	186	203	219	236	247	264	281	297	309	326	336	353	362	379
24	101	128	155	181	197	213	229	240	256	272	288	299	315	325	342	350	366
25	98	124	150	175	191	206	222	232	248	264	279	289	305	314	330	337	353
26	95	120	144	170	185	200	215	225	240	255	269	280	295	303	318	325	340
27	92	116	139	164	179	193	208	217	232	246	260	270	284	292	307	313	327
28	89	112	134	159	173	187	201	209	224	238	251	260	274	281	295	300	314
29	86	108	129	153	167	180	194	202	216	229	242	250	263	270	284	288	302
30	83	104	124	148	161	174	187	194	207	221	233	240	253	259	272	275	289
31	80	100	119	142	155	167	180	187	199	212	224	231	243	248	261	263	276
32	78	96	113	137	149	161	173	179	191	203	215	221	232	237	249	251	263
33	75	92	108	132	143	154	166	171	183	195	205	211	222	225	237	238	250
34	72	88	103	126	137	148	159	164	175	186	196	201	212	216	227	232	243
35	69	84	101	121	131	141	152	156	167	177	187	194	205	211	221	226	237
Area, in. ²	8.94	11.72	14.66	16.44	17.94	19.44	20.94	22.22	23.72	25.22	26.72	28.16	29.66	31.10	32.60	34.04	35.54
I ₁₋₁ , in. ⁴	134	157	181	333	376	420	465	443	488	534	581	558	605	583	630	607	654
r ₁₋₁ , in.	3.87	3.66	3.52	4.50	4.58	4.65	4.71	4.47	4.54	4.60	4.66	4.45	4.52	4.33	4.40	4.22	4.29
I ₂₋₂ , in. ⁴	124	148	171	214	232	250	268	274	292	310	328	333	351	353	371	372	390
r ₂₋₂ , in.	3.72	3.55	3.41	3.60	3.59	3.58	3.58	3.51	3.51	3.51	3.50	3.44	3.44	3.37	3.38	3.30	3.31
Weight, Lbs. per Foot	38.4	47.8	57.8	56.1	61.2	66.3	71.4	75.7	80.8	85.9	91.0	95.9	101.0	105.9	111.0	115.9	121.0

Safe load values above upper zigzag line are for ratios of l/r not over 60, those between the zigzag lines are for ratios up to 120 l/r, and those below lower zigzag line are for ratios not over 200 l/r.

RIVETED COLUMNS

10-INCH CHANNEL COLUMNS—Continued

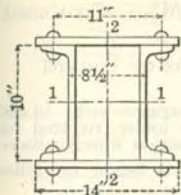

SAFE LOADS IN THOUSANDS OF POUNDS

Allowable Fiber Stress per square inch, 13,000 pounds for lengths of 60 radii or under, reduced for lengths over 60 radii; see Construction Specifications.

Weights do not include rivet heads or other details.

Effective Length in Feet	2-10 in. Channels Latticed				2-10 in. Channels, 2.14 in. Plates											
	15.3 lb. Channels, Single Lattice	20 lb. Channels, Single Lattice	25 lb. Channels, Single Lattice	30 lb. Channels, Single Lattice	2-10 in. Channels, 2.14 in. Plates											
					15.3 lb. Channels, 3/8 in. Plates	15.3 lb. Channels, 7/16 in. Plates	15.3 lb. Channels, 1/2 in. Plates	20 lb. Channels, 7/16 in. Plates	20 lb. Channels, 1/2 in. Plates	20 lb. Channels, 9/16 in. Plates	20 lb. Channels, 5/8 in. Plates	25 lb. Channels, 9/16 in. Plates	25 lb. Channels, 5/8 in. Plates	25 lb. Channels, 11/16 in. Plates	25 lb. Channels, 3/4 in. Plates	
11	116	152	191	229	253	275	298	312	334	357	380	395	418	441	464	
12	116	152	191	229	253	275	298	312	334	357	380	395	418	441	464	
13	116	152	191	229	253	275	298	312	334	357	380	395	418	441	464	
14	116	152	191	229	253	275	298	312	334	357	380	395	418	441	464	
15	116	152	191	229	253	275	298	312	334	357	380	395	418	441	464	
16	116	152	191	229	253	275	298	312	334	357	380	395	418	441	464	
17	116	152	191	229	253	275	298	312	334	357	380	395	418	441	464	
18	116	152	189	223	253	275	298	312	334	357	380	395	418	441	464	
19	116	150	184	217	253	275	298	312	334	357	380	395	418	441	464	
20	114	146	179	211	253	275	298	312	334	357	380	395	418	441	464	
21	112	142	174	205	253	275	298	312	334	357	380	395	418	441	463	
22	109	138	169	199	252	273	295	308	330	352	374	388	409	431	453	
23	106	134	164	192	246	268	289	301	322	344	365	379	400	421	443	
24	103	130	159	186	241	262	283	295	315	336	357	370	391	412	432	
25	101	127	154	180	236	256	276	288	308	328	349	362	382	402	422	
26	98	123	149	174	230	250	270	281	301	321	341	353	373	392	412	
27	95	119	144	168	225	244	263	274	294	313	332	344	364	383	402	
28	92	115	139	161	220	238	257	268	286	305	324	336	354	373	392	
29	89	111	134	155	214	232	251	261	279	298	316	327	345	363	381	
30	87	107	129	149	209	226	244	254	272	290	308	318	336	354	371	
31	84	104	124	143	203	221	238	248	265	282	299	310	327	344	361	
32	81	100	119	137	198	215	231	241	257	274	291	301	318	334	351	
33	78	96	114	131	193	209	225	234	250	267	283	292	309	325	341	
34	76	92	109	124	187	203	219	227	243	259	275	284	299	315	330	
35	73	88	104	121	182	197	212	221	236	251	266	275	290	305	320	
Area, in. ²	8.94	11.72	14.66	17.60	19.44	21.19	22.94	23.97	25.72	27.47	29.22	30.41	32.16	33.91	35.66	
I ₁₋₁ , in. ⁴	134	157	181	206	416	468	520	491	543	597	651	621	676	732	789	
r ₁₋₁ , in.	3.87	3.66	3.52	3.42	4.63	4.70	4.76	4.52	4.60	4.66	4.72	4.52	4.58	4.65	4.70	
I ₂₋₂ , in. ⁴	198	241	284	323	369	398	426	441	470	498	527	541	569	598	627	
r ₂₋₂ , in.	4.70	4.53	4.40	4.28	4.36	4.33	4.31	4.29	4.27	4.26	4.25	4.22	4.21	4.20	4.19	
Weight, Lbs. per Foot	40.0	49.4	59.4	69.4	66.3	72.3	78.2	81.7	87.6	93.6	99.5	103.6	109.5	115.5	121.4	

Safe load values above upper zigzag line are for ratios of l/r not over 60, those between the zigzag lines are for ratios up to 120 l/r, and those below lower zigzag line are for ratios not over 200 l/r.

10-INCH CHANNEL COLUMNS—Continued

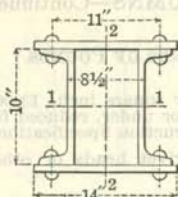

SAFE LOADS IN THOUSANDS OF POUNDS

Allowable Fiber Stress per square inch, 13,000 pounds for lengths of 60 radii or under, reduced for lengths over 60 radii; see Construction Specifications.

Weights do not include rivet heads or other details.

Effective Length in Feet	2-10 in. Channels, 2-14 in. Plates											
	30 lb. Channels, 1 1/10 in. Plates	30 lb. Channels, 3/4 in. Plates	30 lb. Channels, 1 1/10 in. Plates	30 lb. Channels, 7/8 in. Plates	30 lb. Channels, 1 1/10 in. Plates	30 lb. Channels, 1 in. Plates	35 lb. Channels, 1 1/10 in. Plates	35 lb. Channels, 1 in. Plates	35 lb. Channels, 1 1/10 in. Plates	35 lb. Channels, 1 1/8 in. Plates	35 lb. Channels, 1 1/10 in. Plates	35 lb. Channels, 1 1/4 in. Plates
11	479	502	525	547	570	593	608	631	654	677	699	722
12	479	502	525	547	570	593	608	631	654	677	699	722
13	479	502	525	547	570	593	608	631	654	677	699	722
14	479	502	525	547	570	593	608	631	654	677	699	722
15	479	502	525	547	570	593	608	631	654	677	699	722
16	479	502	525	547	570	593	608	631	654	677	699	722
17	479	502	525	547	570	593	608	631	654	677	699	722
18	479	502	525	547	570	593	608	631	654	677	699	722
19	479	502	525	547	570	593	608	631	654	677	699	722
20	479	502	525	547	570	593	608	631	654	677	699	722
21	477	499	522	544	566	589	601	624	646	669	691	713
22	466	488	510	531	554	576	588	610	632	654	675	697
23	456	477	498	519	541	562	574	596	617	638	659	680
24	445	466	487	507	528	549	560	581	602	623	643	664
25	434	454	475	495	515	536	547	567	588	608	627	648
26	424	443	463	483	503	523	533	553	573	593	612	632
27	413	432	452	470	490	510	519	539	558	578	596	615
28	403	421	440	458	477	496	506	524	543	562	580	599
29	392	410	428	446	465	483	492	510	529	547	564	583
30	381	399	417	434	452	470	478	496	514	532	549	566
31	371	387	405	422	439	457	464	482	499	517	533	550
32	360	376	393	409	426	443	451	468	485	501	517	534
33	349	365	382	397	414	430	437	453	470	486	501	518
34	339	354	370	385	401	417	423	439	455	471	485	501
35	328	343	358	373	388	404	410	425	440	456	470	485
Area, in. ²	36.85	38.60	40.35	42.10	43.85	45.60	46.79	48.54	50.29	52.04	53.79	55.54
I ₁₋₁ , in. ⁴	756	814	872	932	993	1055	1017	1080	1143	1208	1275	1342
I ₁₋₁ , in.	4.53	4.59	4.65	4.70	4.76	4.81	4.66	4.72	4.77	4.82	4.87	4.92
I ₂₋₂ , in. ⁴	637	666	694	723	751	780	787	816	845	873	911	920
I ₂₋₂ , in.	4.16	4.15	4.15	4.14	4.14	4.14	4.10	4.10	4.10	4.10	4.09	4.03
Weight, Lbs. per Foot	125.5	131.4	137.4	143.3	149.3	155.2	159.3	165.2	171.2	177.1	183.1	189.0

Safe load values above heavy line are for ratios of l/r not over 60, those below heavy line are for ratios not over 120 l/r.

RIVETED COLUMNS

12-INCH CHANNEL COLUMNS—Continued

SAFE LOADS IN THOUSANDS OF POUNDS

Allowable Fiber Stress per square inch, 13,000 pounds for lengths of 60 radii or under, reduced for lengths over 60 radii; see Construction Specifications.

Weights do not include rivet heads or other details.

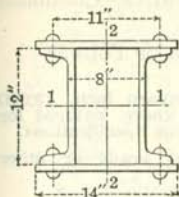

Effective Length in Feet	2-12 in. Channels Latticed				2-12 in. Channels, 2-14 in. Plates									
	20.7 lb. Channels, Single Lattice	25 lb. Channels, Single Lattice	30 lb. Channels, Single Lattice	35 lb. Channels, Single Lattice	20.7 lb. Channels, 3/8 in. Plates	20.7 lb. Channels, 7/16 in. Plates	20.7 lb. Channels, 1/2 in. Plates	20.7 lb. Channels, 9/16 in. Plates	20.7 lb. Channels, 5/8 in. Plates	25 lb. Channels, 9/16 in. Plates	25 lb. Channels, 5/8 in. Plates	25 lb. Channels, 1 1/16 in. Plates	25 lb. Channels, 3/4 in. Plates	25 lb. Channels, 1 1/16 in. Plates
11	157	190	229	267	293	316	339	362	384	395	418	441	463	486
12	157	190	229	267	293	316	339	362	384	395	418	441	463	486
13	157	190	229	267	293	316	339	362	384	395	418	441	463	486
14	157	190	229	267	293	316	339	362	384	395	418	441	463	486
15	157	190	229	267	293	316	339	362	384	395	418	441	463	486
16	157	190	229	267	293	316	339	362	384	395	418	441	463	486
17	157	190	229	267	293	316	339	362	384	395	418	441	463	486
18	157	190	229	267	293	316	339	362	384	395	418	441	463	486
19	157	190	229	267	293	316	339	362	384	395	418	441	463	486
20	157	190	229	267	293	316	339	362	384	395	418	441	463	486
21	157	190	229	267	293	316	339	362	384	395	417	440	462	484
22	157	190	225	259	290	312	334	355	377	386	408	430	452	474
23	155	185	220	253	283	305	326	347	369	378	399	420	442	463
24	152	181	215	247	277	298	319	339	360	369	390	410	432	452
25	149	177	210	241	271	291	312	332	352	360	381	401	421	441
26	146	173	205	235	265	284	304	324	344	352	371	391	411	431
27	142	169	200	229	258	277	297	316	335	343	362	381	401	420
28	139	165	195	223	252	271	290	308	327	334	353	371	391	409
29	136	161	190	217	246	264	282	300	318	326	344	362	380	398
30	133	157	185	211	239	257	275	292	310	317	335	352	370	388
31	129	153	180	205	233	250	268	284	302	308	325	342	360	377
32	126	149	175	199	227	243	260	277	293	300	316	333	350	366
33	123	145	170	193	220	236	253	269	285	291	307	323	340	355
34	120	141	165	187	214	230	246	261	277	282	298	313	329	345
35	117	137	160	181	208	223	238	253	268	274	288	303	319	334
Area, in. ²	12.06	14.64	17.58	20.52	22.56	24.31	26.06	27.81	29.56	30.39	32.14	33.89	35.64	37.39
I ₁₋₁ , in. ⁴	256	287	322	358	658	730	803	878	954	909	985	1062	1141	1222
r ₁₋₁ , in.	4.61	4.43	4.28	4.18	5.40	5.48	5.55	5.62	5.68	5.47	5.54	5.60	5.66	5.72
I ₂₋₂ , in. ⁴	244	279	316	350	415	444	473	501	530	536	564	593	622	650
r ₂₋₂ , in.	4.50	4.36	4.24	4.13	4.29	4.27	4.26	4.25	4.23	4.20	4.19	4.18	4.18	4.17
Weight, Lbs. per Foot	50.8	59.4	69.4	79.4	77.1	83.1	89.0	95.0	100.9	103.6	109.5	115.5	121.4	127.4

Safe load values above zigzag line are for ratios of l/r not over 60, those below zigzag line are for ratios not over 120 l/r.

CARNEGIE STEEL COMPANY

12-INCH CHANNEL COLUMNS—Continued

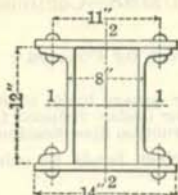

SAFE LOADS IN THOUSANDS OF POUNDS

Allowable Fiber Stress per square inch, 13,000 pounds for lengths of 60 radii or under, reduced for lengths over 60 radii; see Construction Specifications.

Weights do not include rivet heads or other details.

Effective Length in Feet	2-12 in. Channels, 2-14 in. Plates															
	30 lb. Channels, 3/4 in. Plates	30 lb. Channels, 5/16 in. Plates	30 lb. Channels, 3/8 in. Plates	30 lb. Channels, 5/16 in. Plates	30 lb. Channels, 1 in. Plates	35 lb. Channels, 1 1/16 in. Plates	35 lb. Channels, 1 in. Plates	35 lb. Channels, 1 1/16 in. Plates	35 lb. Channels, 1 1/8 in. Plates	35 lb. Channels, 1 1/16 in. Plates	35 lb. Channels, 1 1/4 in. Plates	35 lb. Channels, 1 1/8 in. Plates	35 lb. Channels, 1 1/16 in. Plates	35 lb. Channels, 1 1/8 in. Plates	35 lb. Channels, 1 1/16 in. Plates	35 lb. Channels, 1 1/4 in. Plates
11	502	524	547	570	593	608	631	654	676	699	722	745	767	790	813	
12	502	524	547	570	593	608	631	654	676	699	722	745	767	790	813	
13	502	524	547	570	593	608	631	654	676	699	722	745	767	790	813	
14	502	524	547	570	593	608	631	654	676	699	722	745	767	790	813	
15	502	524	547	570	593	608	631	654	676	699	722	745	767	790	813	
16	502	524	547	570	593	608	631	654	676	699	722	745	767	790	813	
17	502	524	547	570	593	608	631	654	676	699	722	745	767	790	813	
18	502	524	547	570	593	608	631	654	676	699	722	745	767	790	813	
19	502	524	547	570	593	608	631	654	676	699	722	745	767	790	813	
20	502	524	547	570	593	608	631	654	676	699	722	745	767	790	813	
21	498	520	542	565	587	600	622	645	667	690	712	734	756	778	801	
22	486	508	530	552	574	586	608	630	652	674	696	717	739	760	782	
23	475	497	518	539	561	572	594	615	636	658	679	700	721	743	764	
24	464	485	505	526	547	558	579	600	621	642	663	683	704	725	745	
25	453	473	493	514	534	545	565	585	606	626	647	666	686	707	727	
26	442	462	481	501	521	531	551	571	591	610	630	649	669	689	709	
27	430	450	469	488	508	517	537	556	575	595	614	632	652	671	690	
28	419	438	456	475	494	503	522	541	560	579	598	615	634	653	672	
29	408	426	444	463	481	490	508	526	545	563	581	598	617	635	653	
30	397	415	432	450	468	476	494	512	529	547	565	582	599	617	635	
31	386	403	420	437	454	462	479	497	514	531	549	565	582	599	616	
32	374	391	407	424	441	448	465	482	499	516	532	548	565	581	598	
33	363	380	395	411	428	435	451	467	483	500	516	531	547	563	580	
34	352	368	383	399	415	421	437	452	468	484	500	514	530	545	561	
35	341	356	371	386	401	407	422	438	453	468	483	497	512	528	543	
Area, in. ²	38.58	40.33	42.08	43.83	45.58	46.77	48.52	50.27	52.02	53.77	55.52	57.27	59.02	60.77	62.52	
I ₁₋₁ , in. ⁴	1177	1257	1339	1423	1508	1458	1543	1629	1717	1807	1898	1991	2085	2181	2279	
r ₁₋₁ , in.	5.52	5.58	5.64	5.70	5.75	5.58	5.64	5.69	5.75	5.80	5.85	5.90	5.94	5.99	6.04	
I ₂₋₂ , in. ⁴	659	687	716	744	773	779	807	836	865	893	922	950	979	1008	1036	
r ₂₋₂ , in.	4.13	4.13	4.12	4.12	4.12	4.08	4.08	4.08	4.08	4.08	4.08	4.07	4.07	4.07	4.07	
Weight, Lbs. per Foot	131.4	137.4	143.3	149.3	155.2	159.3	165.2	171.2	177.1	183.1	189.0	195.0	200.9	206.9	212.8	

Safe load values above heavy line are for ratios of l/r not over 60, those below heavy line are for ratios not over 120 l/r.

RIVETED COLUMNS

12-INCH CHANNEL COLUMNS—Continued

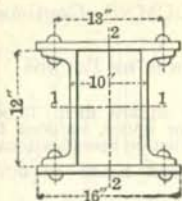

SAFE LOADS IN THOUSANDS OF POUNDS

Allowable Fiber Stress per square inch, 13,000 pounds for lengths of 60 radii or under, reduced for lengths over 60 radii; see Construction Specifications.

Weights do not include rivet heads or other details.

Effective Length in Feet	2-12 in. Channels, 2-16 in. Plates									
	30 lb. Channels, 1 1/16 in. Plates	30 lb. Channels, 1 in. Plates	30 lb. Channels, 1 1/16 in. Plates	30 lb. Channels, 1 1/8 in. Plates	30 lb. Channels, 1 1/16 in. Plates	30 lb. Channels, 1 1/4 in. Plates	35 lb. Channels, 1 1/16 in. Plates	35 lb. Channels, 1 1/4 in. Plates	35 lb. Channels, 1 1/16 in. Plates	35 lb. Channels, 1 1/8 in. Plates
11	619	645	671	697	723	749	761	787	813	839
12	619	645	671	697	723	749	761	787	813	839
13	619	645	671	697	723	749	761	787	813	839
14	619	645	671	697	723	749	761	787	813	839
15	619	645	671	697	723	749	761	787	813	839
16	619	645	671	697	723	749	761	787	813	839
17	619	645	671	697	723	749	761	787	813	839
18	619	645	671	697	723	749	761	787	813	839
19	619	645	671	697	723	749	761	787	813	839
20	619	645	671	697	723	749	761	787	813	839
21	619	645	671	697	723	749	761	787	813	839
22	619	645	671	697	723	749	761	787	813	839
23	619	645	671	697	723	749	761	787	813	839
24	619	645	671	697	723	749	761	786	812	837
25	610	635	660	685	710	735	746	771	796	821
26	598	622	647	672	696	721	732	756	781	805
27	586	610	634	659	682	706	717	741	765	789
28	574	598	621	645	669	692	702	725	749	772
29	563	586	608	632	655	677	688	710	734	756
30	551	573	596	619	641	663	673	695	718	740
31	539	561	583	605	627	649	658	680	702	724
32	527	549	570	592	613	634	644	665	687	708
33	516	536	557	579	599	620	629	650	671	691
34	504	524	544	565	586	606	614	634	655	675
35	492	512	532	552	572	591	600	619	640	659
Area, in. ²	47.58	49.58	51.58	53.58	55.58	57.58	58.52	60.52	62.52	64.52
I ₁₋₁ , in. ⁴	1580	1677	1776	1877	1979	2083	2014	2118	2224	2332
r ₁₋₁ , in.	5.76	5.82	5.87	5.92	5.97	6.02	5.87	5.92	5.96	6.01
I ₂₋₂ , in. ⁴	1120	1162	1205	1248	1290	1333	1348	1391	1433	1476
r ₂₋₂ , in.	4.85	4.84	4.83	4.83	4.82	4.81	4.80	4.79	4.79	4.78
Weight, Lbs. per Foot	162.0	168.8	175.6	182.4	189.2	196.0	199.2	206.0	212.8	219.6

Safe load values above heavy line are for ratios of l/r not over 60, those below heavy line are for ratios not over 120 l/r.

CARNEGIE STEEL COMPANY

12-INCH CHANNEL COLUMNS—Continued

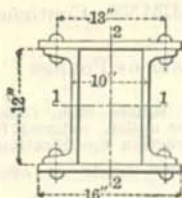

SAFE LOADS IN THOUSANDS OF POUNDS

Allowable Fiber Stress per square inch, 13,000 pounds for lengths of 60 radii or under, reduced for lengths over 60 radii; see Construction Specifications.

Weights do not include rivet heads or other details.

Effective Length in Feet	2-12 in. Channels, 2-16 in. Plates									
	35 lb. Channels, 1 $\frac{1}{16}$ in. Plates	35 lb. Channels, 1 $\frac{1}{2}$ in. Plates	35 lb. Channels, 1 $\frac{9}{16}$ in. Plates	35 lb. Channels, 1 $\frac{5}{8}$ in. Plates	35 lb. Channels, 1 $\frac{1}{4}$ in. Plates	35 lb. Channels, 1 $\frac{3}{8}$ in. Plates	35 lb. Channels, 1 $\frac{1}{2}$ in. Plates	35 lb. Channels, 1 $\frac{5}{8}$ in. Plates	35 lb. Channels, 1 $\frac{3}{4}$ in. Plates	35 lb. Channels, 2 in. Plates
11	865	891	917	943	969	995	1021	1047	1073	1099
12	865	891	917	943	969	995	1021	1047	1073	1099
13	865	891	917	943	969	995	1021	1047	1073	1099
14	865	891	917	943	969	995	1021	1047	1073	1099
15	865	891	917	943	969	995	1021	1047	1073	1099
16	865	891	917	943	969	995	1021	1047	1073	1099
17	865	891	917	943	969	995	1021	1047	1073	1099
18	865	891	917	943	969	995	1021	1047	1073	1099
19	865	891	917	943	969	995	1021	1047	1073	1099
20	865	891	917	943	969	995	1021	1047	1073	1099
21	865	891	917	943	969	995	1021	1047	1073	1099
22	865	891	917	943	969	995	1021	1047	1073	1099
23	865	891	917	943	969	995	1021	1047	1073	1099
24	863	888	914	940	965	991	1016	1042	1068	1092
25	846	871	896	922	946	972	996	1021	1047	1071
26	830	854	879	904	927	952	976	1001	1026	1050
27	813	836	861	885	909	933	956	981	1005	1028
28	796	819	843	867	890	914	936	960	984	1007
29	780	802	825	849	871	894	917	940	963	985
30	763	785	808	831	852	875	897	920	942	964
31	746	768	790	812	833	856	877	899	922	943
32	730	750	772	794	815	837	857	879	901	921
33	713	733	754	776	796	817	837	859	880	900
34	696	716	737	758	777	798	817	838	859	878
35	679	699	719	739	758	779	798	818	838	857
Ares. in. ²	66.52	68.52	70.52	72.52	74.52	76.52	78.52	80.52	82.52	84.52
I ₁₋₁ , in. ⁴	2442	2554	2667	2782	2900	3019	3140	3263	3388	3515
r ₁₋₁ , in.	6.06	6.10	6.15	6.19	6.24	6.28	6.32	6.37	6.41	6.45
I ₂₋₂ , in. ⁴	1519	1561	1604	1647	1689	1732	1775	1817	1860	1903
r ₂₋₂ , in.	4.78	4.77	4.77	4.77	4.76	4.76	4.75	4.75	4.75	4.74
Weight, Lbs. per Foot	226.4	233.2	240.0	246.8	253.6	260.4	267.2	274.0	280.8	287.6

Safe load values above heavy line are for ratios of l/r not over 60, those below heavy line are for ratios over 120 l/r.

RIVETED COLUMNS

15-INCH CHANNEL COLUMNS—Continued

SAFE LOADS IN THOUSANDS OF POUNDS

Allowable Fiber Stress per square inch, 13,000 pounds for lengths of 60 radii or under, reduced for lengths over 60 radii; see Construction Specifications.

Weights do not include rivet heads or other details.

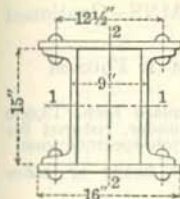

Effective Length in Feet	2-15 in. Channels Latticed				2-15 in. Channels, 2-16 in. Plates									
	33.9 lb. Channels, Single Lattice	35 lb. Channels, Single Lattice	40 lb. Channels, Single Lattice	45 lb. Channels, Single Lattice	33.9 lb. Channels, 7/8 in. Plates	33.9 lb. Channels, 1/2 in. Plates	33.9 lb. Channels, 1/2 in. Plates	33.9 lb. Channels, 1/2 in. Plates	33.9 lb. Channels, 1/2 in. Plates	35 lb. Channels, 1/2 in. Plates	35 lb. Channels, 1 1/16 in. Plates	35 lb. Channels, 3/4 in. Plates	35 lb. Channels, 1 1/16 in. Plates	35 lb. Channels, 3/4 in. Plates
11	257	266	304	342	413	439	465	491	517	526	552	578	604	630
12	257	266	304	342	413	439	465	491	517	526	552	578	604	630
13	257	266	304	342	413	439	465	491	517	526	552	578	604	630
14	257	266	304	342	413	439	465	491	517	526	552	578	604	630
15	257	266	304	342	413	439	465	491	517	526	552	578	604	630
16	257	266	304	342	413	439	465	491	517	526	552	578	604	630
17	257	266	304	342	413	439	465	491	517	526	552	578	604	630
18	257	266	304	342	413	439	465	491	517	526	552	578	604	630
19	257	266	304	342	413	439	465	491	517	526	552	578	604	630
20	257	266	304	342	413	439	465	491	517	526	552	578	604	630
21	257	266	304	342	413	439	465	491	517	526	552	578	604	630
22	257	266	304	342	413	439	465	491	517	526	552	578	604	630
23	257	266	304	342	413	439	465	491	517	526	552	578	604	630
24	257	266	304	342	413	439	465	491	517	525	551	577	602	628
25	257	265	300	334	407	432	457	482	507	515	540	566	591	615
26	252	260	294	327	400	424	448	473	498	505	530	555	579	603
27	247	255	288	321	392	415	440	464	488	495	519	543	567	591
28	243	250	282	314	384	407	431	454	478	485	508	532	555	579
29	238	245	277	307	376	399	422	445	468	475	498	521	544	566
30	233	240	271	301	368	390	413	435	458	465	487	510	532	554
31	228	235	265	294	360	382	404	426	448	455	476	499	520	542
32	224	230	259	288	352	373	395	416	438	444	466	488	509	530
33	219	225	254	281	345	365	386	407	428	434	455	476	497	518
34	214	220	248	274	337	357	377	398	418	424	444	465	486	505
35	209	215	242	268	329	348	368	388	408	414	434	454	474	493
Area, in. ²	19.80	20.46	23.40	26.34	31.80	33.80	35.80	37.80	39.80	40.46	42.46	44.46	46.46	48.46
I ₁₋₁ , in. ⁴	625	637	693	748	1334	1459	1586	1715	1846	1859	1992	2127	2264	2403
r ₁₋₁ , in.	5.62	5.58	5.44	5.33	6.48	6.57	6.66	6.74	6.81	6.78	6.85	6.92	6.98	7.04
I ₂₋₂ , in. ⁴	491	502	550	595	747	789	832	875	917	928	971	1014	1056	1099
r ₂₋₂ , in.	4.98	4.95	4.85	4.75	4.85	4.83	4.82	4.81	4.80	4.79	4.78	4.78	4.77	4.76
Weight, Lbs. per Foot	82.0	84.2	92.1	102.2	108.6	115.4	122.2	129.0	135.8	138.0	144.8	151.6	158.4	165.2

Safe load values above zigzag line are for ratios of l/r not over 60, those below zigzag line are for ratios not over 120 l/r .

15-INCH CHANNEL COLUMNS—Continued

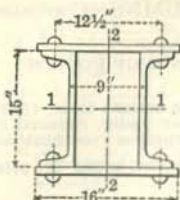

SAFE LOADS IN THOUSANDS OF POUNDS

Allowable Fiber Stress per square inch, 13,000 pounds for lengths of 60 radii or under, reduced for lengths over 60 radii; see Construction Specifications.

Weights do not include rivet heads or other details.

Effective Length in Feet	2-15 Channels, 2-16 in. Plates													
	40 lb. Channels, 1 1/16 in. Plates	40 lb. Channels, 5/8 in. Plates	40 lb. Channels, 1 1/16 in. Plates	40 lb. Channels, 1 in. Plates	40 in. Channels, 1 1/16 in. Plates	40 lb. Channels, 1 1/8 in. Plates	45 lb. Channels, 1 1/16 in. Plates	45 lb. Channels, 1 1/8 in. Plates	45 lb. Channels, 1 1/16 in. Plates	45 lb. Channels, 1 1/8 in. Plates	45 lb. Channels, 1 1/16 in. Plates	45 lb. Channels, 1 1/8 in. Plates	45 lb. Channels, 1 1/16 in. Plates	
11	642	668	694	720	746	772	784	810	836	862	888	914	940	966
12	642	668	694	720	746	772	784	810	836	862	888	914	940	966
13	642	668	694	720	746	772	784	810	836	862	888	914	940	966
14	642	668	694	720	746	772	784	810	836	862	888	914	940	966
15	642	668	694	720	746	772	784	810	836	862	888	914	940	966
16	642	668	694	720	746	772	784	810	836	862	888	914	940	966
17	642	668	694	720	746	772	784	810	836	862	888	914	940	966
18	642	668	694	720	746	772	784	810	836	862	888	914	940	966
19	642	668	694	720	746	772	784	810	836	862	888	914	940	966
20	642	668	694	720	746	772	784	810	836	862	888	914	940	966
21	642	668	694	720	746	772	784	810	836	862	888	914	940	966
22	642	668	694	720	746	772	784	810	836	862	888	914	940	966
23	642	668	694	720	746	772	784	810	836	862	888	914	940	966
24	638	663	689	715	740	765	775	801	826	851	877	903	928	954
25	625	650	675	700	725	750	760	785	809	834	859	885	910	935
26	613	637	662	686	710	735	744	769	793	817	842	867	891	916
27	600	624	648	672	696	720	729	753	776	800	824	848	873	897
28	588	611	634	658	681	705	713	737	760	783	807	830	854	878
29	575	598	621	644	667	690	698	721	743	766	789	812	835	858
30	563	585	607	630	652	675	682	705	726	749	772	794	817	839
31	550	571	594	616	637	659	667	689	710	732	754	776	798	820
32	538	558	580	602	623	644	651	673	693	715	737	758	780	801
33	525	545	567	588	608	629	636	657	677	698	719	740	761	782
34	512	532	553	574	593	614	620	641	660	681	701	722	742	763
35	500	519	539	560	579	599	605	625	644	664	684	704	724	744
Area, in. ²	49.40	51.40	53.40	55.40	57.40	59.40	60.34	62.34	64.34	66.34	68.34	70.34	72.34	74.34
I ₁₋₁ , in. ⁴	2319	2459	2600	2743	2889	3037	2944	3092	3242	3394	3548	3704	3863	4024
r ₁₋₁ , in.	6.85	6.92	6.98	7.04	7.09	7.15	6.99	7.04	7.10	7.15	7.21	7.26	7.30	7.36
I ₂₋₂ , in. ⁴	1104	1147	1190	1232	1275	1318	1320	1363	1406	1448	1491	1534	1576	1619
r ₂₋₂ , in.	4.73	4.72	4.72	4.72	4.71	4.71	4.68	4.68	4.67	4.67	4.67	4.67	4.67	4.67
Weight, Lbs. per Foot	168.4	175.2	182.0	188.8	195.6	202.4	205.6	212.4	219.2	226.0	232.8	239.6	246.4	253.2

Safe load values above heavy line are for ratios of l/r not over 60, those below heavy line are for ratios not over 120 l/r.

RIVETED COLUMNS

15-INCH CHANNEL COLUMNS—Continued

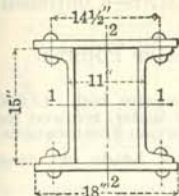

SAFE LOADS IN THOUSANDS OF POUNDS

Allowable Fiber Stress per square inch, 13,000 pounds for lengths of 60 radii or under, reduced for lengths over 60 radii; see Construction Specifications.

Weights do not include rivet heads or other details.

Effective Length in Feet	2-15 in. Channels, 2-18 in. Plates															
	33.9 lb. Channels, 3/8 in. Plates	33.9 lb. Channels, 7/16 in. Plates	33.9 lb. Channels, 1/2 in. Plates	33.9 lb. Channels, 9/16 in. Plates	33.9 lb. Channels, 5/8 in. Plates	35 lb. Channels, 3/8 in. Plates	35 lb. Channels, 1/2 in. Plates	35 lb. Channels, 5/8 in. Plates	35 lb. Channels, 3/4 in. Plates	35 lb. Channels, 13/16 in. Plates	35 lb. Channels, 7/8 in. Plates	40 lb. Channels, 13/16 in. Plates	40 lb. Channels, 7/8 in. Plates	40 lb. Channels, 15/16 in. Plates	40 lb. Channels, 1 in. Plates	40 lb. Channels, 1 1/16 in. Plates
11	433	462	491	521	550	558	588	617	646	676	684	714	743	772	801	831
12	433	462	491	521	550	558	588	617	646	676	684	714	743	772	801	831
13	433	462	491	521	550	558	588	617	646	676	684	714	743	772	801	831
14	433	462	491	521	550	558	588	617	646	676	684	714	743	772	801	831
15	433	462	491	521	550	558	588	617	646	676	684	714	743	772	801	831
16	433	462	491	521	550	558	588	617	646	676	684	714	743	772	801	831
17	433	462	491	521	550	558	588	617	646	676	684	714	743	772	801	831
18	433	462	491	521	550	558	588	617	646	676	684	714	743	772	801	831
19	433	462	491	521	550	558	588	617	646	676	684	714	743	772	801	831
20	433	462	491	521	550	558	588	617	646	676	684	714	743	772	801	831
21	433	462	491	521	550	558	588	617	646	676	684	714	743	772	801	831
22	433	462	491	521	550	558	588	617	646	676	684	714	743	772	801	831
23	433	462	491	521	550	558	588	617	646	676	684	714	743	772	801	831
24	433	462	491	521	550	558	588	617	646	676	684	714	743	772	801	831
25	433	462	491	521	550	558	588	617	646	676	684	714	743	772	801	831
26	433	462	491	521	550	558	588	617	646	676	684	714	743	772	801	831
27	433	462	491	521	550	558	588	617	646	676	684	714	743	772	801	831
28	433	462	491	520	549	557	585	613	641	670	678	706	735	763	791	819
29	428	456	484	512	539	547	575	603	631	658	667	694	722	750	778	805
30	421	449	476	503	530	538	565	593	620	647	655	682	710	737	764	791
31	414	441	468	494	521	529	555	582	609	636	644	670	697	724	751	777
32	407	433	459	486	512	520	546	572	598	624	632	658	685	711	737	763
33	400	426	451	477	503	510	536	562	587	613	621	646	672	698	723	749
34	393	418	443	469	494	501	526	552	576	602	609	634	660	685	710	735
35	386	411	435	460	485	492	516	541	566	590	598	622	647	672	696	721
Area, in. ²	33.30	35.55	37.80	40.05	42.30	42.96	45.21	47.46	49.71	51.96	52.65	54.90	57.15	59.40	61.65	63.90
I ₁₋₁ , in. ⁴	1423	1564	1707	1852	1999	2012	2161	2313	2467	2624	2523	2679	2838	3000	3163	3330
r ₁₋₁ , in.	6.54	6.63	6.72	6.80	6.87	6.84	6.91	6.98	7.05	7.11	6.92	6.99	7.05	7.11	7.16	7.22
I ₂₋₂ , in. ⁴	1069	1130	1190	1251	1312	1329	1390	1450	1511	1572	1586	1646	1707	1768	1829	1889
r ₂₋₂ , in.	5.67	5.64	5.61	5.59	5.57	5.56	5.54	5.53	5.51	5.50	5.49	5.48	5.47	5.46	5.45	5.44
Weight, Lbs. per Foot	113.7	121.4	129.0	137.6	144.3	146.5	154.2	161.8	169.5	177.1	179.5	187.1	194.8	202.4	210.1	217.7

Safe load values above zigzag line are for ratios of l/r not over 60, those below zigzag line are for ratios not over 120 l/r.

15-INCH CHANNEL COLUMNS—Continued

SAFE LOADS IN THOUSANDS OF POUNDS

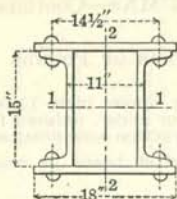

Allowable Fiber Stress per square inch, 13,000 pounds for lengths of 60 radii or under, reduced for lengths over 60 radii; see Construction Specifications.

Weights do not include rivet heads or other details.

Effective Length in Feet	2-15 in. Channels, 2-18 in. Plates															
	45 lb. Channels, 1 1/16 in. Plates	45 lb. Channels, 1 1/8 in. Plates	45 lb. Channels, 1 3/8 in. Plates	45 lb. Channels, 1 1/2 in. Plates	45 lb. Channels, 1 5/8 in. Plates	45 lb. Channels, 1 3/4 in. Plates	45 lb. Channels, 1 7/8 in. Plates	45 lb. Channels, 1 15/16 in. Plates	45 lb. Channels, 1 1/2 in. Plates	45 lb. Channels, 1 5/8 in. Plates	45 lb. Channels, 1 3/4 in. Plates	45 lb. Channels, 1 7/8 in. Plates	45 lb. Channels, 1 15/16 in. Plates	45 lb. Channels, 1 1/2 in. Plates	45 lb. Channels, 1 5/8 in. Plates	45 lb. Channels, 1 3/4 in. Plates
11	840	869	898	927	957	986	1015	1044	1074	1103	1132	1161	1220	1278		
12	840	869	898	927	957	986	1015	1044	1074	1103	1132	1161	1220	1278		
13	840	869	898	927	957	986	1015	1044	1074	1103	1132	1161	1220	1278		
14	840	869	898	927	957	986	1015	1044	1074	1103	1132	1161	1220	1278		
15	840	869	898	927	957	986	1015	1044	1074	1103	1132	1161	1220	1278		
16	840	869	898	927	957	986	1015	1044	1074	1103	1132	1161	1220	1278		
17	840	869	898	927	957	986	1015	1044	1074	1103	1132	1161	1220	1278		
18	840	869	898	927	957	986	1015	1044	1074	1103	1132	1161	1220	1278		
19	840	869	898	927	957	986	1015	1044	1074	1103	1132	1161	1220	1278		
20	840	869	898	927	957	986	1015	1044	1074	1103	1132	1161	1220	1278		
21	840	869	898	927	957	986	1015	1044	1074	1103	1132	1161	1220	1278		
22	840	869	898	927	957	986	1015	1044	1074	1103	1132	1161	1220	1278		
23	840	869	898	927	957	986	1015	1044	1074	1103	1132	1161	1220	1278		
24	840	869	898	927	957	986	1015	1044	1074	1103	1132	1161	1220	1278		
25	840	869	898	927	957	986	1015	1044	1074	1103	1132	1161	1220	1278		
26	840	869	898	927	957	986	1015	1044	1074	1103	1132	1161	1220	1278		
27	840	869	898	927	957	985	1014	1043	1072	1100	1129	1157	1215	1273		
28	827	856	884	912	940	968	997	1025	1053	1081	1110	1137	1194	1251		
29	813	841	868	896	924	951	980	1007	1035	1062	1090	1117	1173	1229		
30	798	826	853	880	908	934	962	989	1017	1043	1071	1097	1152	1207		
31	784	811	838	864	891	918	945	971	998	1024	1051	1077	1130	1185		
32	770	796	822	848	875	901	927	953	980	1005	1032	1057	1109	1163		
33	755	782	807	832	859	884	910	935	961	986	1012	1037	1088	1141		
34	741	767	792	816	842	867	893	917	943	967	993	1017	1067	1119		
35	727	752	776	801	826	850	875	899	924	948	974	997	1046	1096		
Area, in. ²	64.59	66.84	69.09	71.34	73.59	75.84	78.09	80.34	82.59	84.84	87.09	89.34	93.84	98.34		
I ₁₋₁ , in. ⁴	3219	3385	3553	3724	3898	4074	4252	4433	4617	4803	4991	5183	5573	5974		
r ₁₋₁ , in.	7.06	7.12	7.17	7.23	7.28	7.33	7.38	7.43	7.48	7.52	7.57	7.62	7.71	7.79		
I ₂₋₂ , in. ⁴	1900	1961	2022	2082	2143	2204	2265	2325	2386	2447	2508	2568	2690	2811		
r ₂₋₂ , in.	5.42	5.42	5.41	5.40	5.40	5.39	5.39	5.38	5.38	5.38	5.37	5.36	5.35	5.35		
Weight Lbs. per Foot	220.1	227.7	235.4	243.0	250.7	258.3	266.0	273.6	281.3	288.9	296.6	304.2	319.5	334.8		

Safe load values above zigzag line are for ratios of l/r not over 60, those below zigzag line are for ratios not over 120 l/r.

15-INCH CHANNEL COLUMNS—Concluded

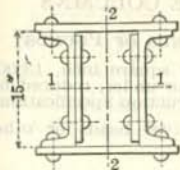

SAFE LOADS IN THOUSANDS OF POUNDS

Allowable Fiber Stress per square inch, 13,000 pounds for lengths of 60 radii or under, reduced for lengths over 60 radii; see Construction Specifications.

Weights do not include rivet heads or other details.

Effective Length in Feet	2-15 in. Channels				2-15 in. 45 lb. Channels											
	35 lb.		45 lb.		2-20 x 17½ Flange Plates 2-14 x 5% Web Plates		2-20 x 2 Flange Plates 2-14 x 5% Web Plates		2-20 x 2¼ Flange Plates 2-14 x 5% Web Plates		2-20 x 2½ Flange Plates 2-14 x 5% Web Plates		2-20 x 2¾ Flange Plates 2-14 x 5% Web Plates		2-20 x 3 Flange Plates 2-14 x 5% Web Plates	
	2-18 x 2 Flange Plates 2-14 x 5% Web Plates	2-18 x 2 Flange Plates 2-14 x 5% Web Plates	2-18 x 2 Flange Plates 2-14 x 5% Web Plates	2-18 x 2 Flange Plates 2-14 x 5% Web Plates	2-20 x 17½ Flange Plates 2-14 x 5% Web Plates	2-20 x 2 Flange Plates 2-14 x 5% Web Plates	2-20 x 2¼ Flange Plates 2-14 x 5% Web Plates	2-20 x 2½ Flange Plates 2-14 x 5% Web Plates	2-20 x 2¾ Flange Plates 2-14 x 5% Web Plates	2-20 x 3 Flange Plates 2-14 x 5% Web Plates	2-20 x 3 Flange Plates 2-14 x 5% Web Plates	2-20 x 3 Flange Plates 2-14 x 5% Web Plates	2-20 x 3 Flange Plates 2-14 x 5% Web Plates	2-20 x 3 Flange Plates 2-14 x 5% Web Plates	2-20 x 3 Flange Plates 2-14 x 5% Web Plates	2-20 x 3 Flange Plates 2-14 x 5% Web Plates
11	1338	1407	1483	1545	1610	1675	1740	1805	1870	1935	2000	2065	2130			
12	1338	1407	1483	1545	1610	1675	1740	1805	1870	1935	2000	2065	2130			
13	1338	1407	1483	1545	1610	1675	1740	1805	1870	1935	2000	2065	2130			
14	1338	1407	1483	1545	1610	1675	1740	1805	1870	1935	2000	2065	2130			
15	1338	1407	1483	1545	1610	1675	1740	1805	1870	1935	2000	2065	2130			
16	1338	1407	1483	1545	1610	1675	1740	1805	1870	1935	2000	2065	2130			
17	1338	1407	1483	1545	1610	1675	1740	1805	1870	1935	2000	2065	2130			
18	1338	1407	1483	1545	1610	1675	1740	1805	1870	1935	2000	2065	2130			
19	1338	1407	1483	1545	1610	1675	1740	1805	1870	1935	2000	2065	2130			
20	1338	1407	1483	1545	1610	1675	1740	1805	1870	1935	2000	2065	2130			
21	1338	1407	1483	1545	1610	1675	1740	1805	1870	1935	2000	2065	2130			
22	1338	1407	1483	1545	1610	1675	1740	1805	1870	1935	2000	2065	2130			
23	1338	1407	1483	1545	1610	1675	1740	1805	1870	1935	2000	2065	2130			
24	1338	1407	1483	1545	1610	1675	1740	1805	1870	1935	2000	2065	2130			
25	1338	1407	1483	1545	1610	1675	1740	1805	1870	1935	2000	2065	2130			
26	1338	1407	1483	1545	1610	1675	1740	1805	1870	1935	2000	2065	2130			
27	1329	1393	1464	1545	1610	1675	1740	1805	1870	1935	2000	2065	2130			
28	1306	1369	1438	1545	1610	1675	1740	1805	1870	1935	2000	2065	2130			
29	1283	1344	1411	1545	1610	1675	1740	1805	1870	1935	2000	2065	2130			
30	1260	1320	1385	1541	1605	1670	1733	1797	1861	1924	1989	2052	2117			
31	1236	1295	1359	1517	1580	1644	1706	1768	1832	1894	1958	2020	2083			
32	1213	1271	1333	1494	1555	1618	1679	1740	1803	1864	1927	1988	2050			
33	1190	1246	1307	1470	1530	1592	1652	1712	1774	1834	1896	1955	2017			
34	1167	1221	1281	1446	1505	1566	1625	1684	1745	1804	1865	1923	1984			
35	1143	1197	1255	1422	1480	1540	1598	1656	1716	1773	1833	1891	1951			
Area, in. ²	102.96	108.21	114.09	118.84	123.84	128.84	133.84	138.84	143.84	148.84	153.84	158.84	163.84			
I ₁₋₁ , in. ⁴	6035	6121	6231	6395	6840	7297	7767	8248	8742	9248	9767	10290	10844			
I ₁₋₁ , in.	7.66	7.52	7.39	7.34	7.43	7.53	7.62	7.71	7.80	7.88	7.97	8.05	8.14			
I ₂₋₂ , in. ⁴	2917	3028	3145	4236	4402	4569	4736	4902	5069	5236	5402	5569	5736			
I ₂₋₂ , in.	5.32	5.29	5.25	5.25	5.96	5.96	5.95	5.94	5.94	5.93	5.93	5.92	5.92			
Weight Lbs. per Foot	350.5	368.4	388.4	404.5	421.5	438.5	455.5	472.5	489.5	506.5	523.5	540.5	557.5			

Safe load values above zigzag line are for ratios of l/r not over 60, those below zigzag line are for ratios not over 120 l/r .

PLATE AND ANGLE COLUMNS

SAFE LOADS IN THOUSANDS OF POUNDS

Allowable Fiber Stress per square inch, 13,000 pounds for lengths of 60 radii or under, reduced for lengths over 60 radii; see Construction Specifications.

Weights do not include rivet heads or other details.

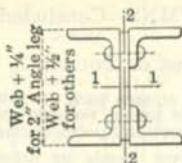

Effective Length in Feet	Web Plate 6 x 1/4			Web Plate 8 x 1/4				Web Plate 8 x 5/16				Web Plate 8 x 3/8		
	4 Angles 2 1/2 x 2 x 1/4	4 Angles 3 x 2 x 1/4	4 Angles 3 x 2 1/2 x 1/4	4 Angles 3 x 2 1/2 x 1/4	4 Angles 3 x 2 1/2 x 5/16	4 Angles 3 1/2 x 2 1/2 x 1/4	4 Angles 3 1/2 x 2 1/2 x 5/16	4 Angles 3 1/2 x 2 1/2 x 5/16	4 Angles 4 x 3 x 5/16	4 Angles 4 x 3 x 3/8	4 Angles 4 x 3 x 1/2	4 Angles 4 x 3 x 5/16	4 Angles 4 x 3 x 1/2	
6	69	81	88	94	110	101	119	125	142	141	161	168	188	208
7	63	78	82	86	103	101	119	125	142	141	161	168	188	208
8	56	72	76	79	95	96	115	120	138	141	161	168	188	208
9	49	66	69	72	87	89	107	112	130	136	158	163	185	206
10	43	60	63	65	78	83	100	104	121	128	149	154	175	196
11	38	54	56	57	70	76	92	96	112	121	140	145	165	185
12	35	49	50	50	62	70	85	89	104	113	131	136	155	174
13	32	43	45	47	56	63	78	81	95	105	123	127	145	163
14	28	40	42	43	52	57	70	73	86	97	114	118	135	152
15	25	37	39	39	48	52	63	66	77	89	105	109	124	141
16	22	34	35	36	44	49	60	62	73	81	97	100	114	130
17	18	32	32	32	40	46	56	58	68	75	88	90	104	120
18	29	29	28	28	36	43	52	54	64	71	83	86	98	110
19	26	26	25	25	32	39	49	50	60	67	79	81	93	105
20	23	22	22	22	28	36	45	47	55	63	74	77	88	100
21		20				33	41	43	51	59	70	72	83	94
22						30	38	39	47	55	66	68	78	89
23						27	34	35	42	51	61	63	73	83
24						23	30	31	38	48	57	59	68	78
25									34	44	53	54	63	72
26										40	48	49	58	67
27										36	44	45	53	62
28											39	40	48	56
29														51
30														
Area, in. ²	5.74	6.26	6.74	7.24	8.48	7.76	9.12	9.62	10.94	10.86	12.42	12.92	14.48	16.00
I ₁₋₁ , in. ⁴	34.3	39.1	42.6	81.2	96.9	90.1	107	110	127	122	141	143	161	178
r ₁₋₁ , in.	2.45	2.50	2.51	3.35	3.38	3.41	3.43	3.38	3.40	3.35	3.36	3.33	3.34	3.33
I ₂₋₂ , in. ⁴	6.2	10.3	10.3	10.3	12.9	16.0	20.2	20.7	24.9	30.3	36.3	37.2	43.5	50.2
r ₂₋₂ , in.	1.04	1.28	1.24	1.19	1.23	1.44	1.49	1.47	1.51	1.67	1.71	1.70	1.73	1.77
Weight, Lbs. per Foot	19.6	21.5	23.1	24.8	29.2	26.4	31.2	32.9	37.3	37.3	42.5	44.2	49.4	54.6

Safe load values above and to right of upper zigzag line are for ratios of l/r not over 60, those between zigzag lines are for ratios up to 120 l/r, and those below lower zigzag line are for ratios not over 200 l/r.

RIVETED COLUMNS

PLATE AND ANGLE COLUMNS—Continued

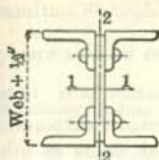

SAFE LOADS IN THOUSANDS OF POUNDS

Allowable Fiber Stress per square inch, 13,000 pounds for lengths of 60 radii or under, reduced for lengths over 60 radii; see Construction Specifications.

Weights do not include rivet heads or other details.

Effective Length in Feet	Web Plate 10 x 1/4		Web Plate 10 x 5/16		Web Plate 10 x 3/8						Web Plate 10 x 1/2		Web Pl 10x3/8				
	4 Angles 3 x 2 1/2 x 1/4	4 Angles 3 1/2 x 2 1/2 x 1/4	4 Angles 3 1/2 x 2 1/2 x 5/16	4 Angles 3 1/2 x 2 1/2 x 5/16	4 Angles 4 x 3 x 5/16	4 Angles 4 x 3 x 3/8	4 Angles 4 x 3 x 3/8	4 Angles 4 x 3 x 5/16	4 Angles 5 x 3 1/2 x 3/8	4 Angles 5 x 3 1/2 x 5/16	4 Angles 6 x 4 x 3/8	4 Angles 6 x 4 x 1/2	4 Angles 6 x 4 x 1/2	4 Angles 6 x 4 x 3/8	4 Angles 6 x 4 x 3/8		
6	99	107	125	133	149	170	178	198	207	232	236	266	296	312	341	370	386
7	91	107	125	133	149	170	178	198	207	232	236	266	296	312	341	370	386
8	82	100	119	125	149	170	178	198	207	232	236	266	296	312	341	370	386
9	74	93	111	117	142	164	170	192	207	232	236	266	296	312	341	370	386
10	66	86	103	108	133	154	160	181	207	232	236	266	296	312	341	370	386
11	58	79	95	99	125	145	150	170	203	230	236	266	296	312	341	370	386
12	52	71	87	91	116	135	140	160	194	220	236	266	296	312	341	370	386
13	48	64	79	82	108	126	130	149	185	210	235	266	296	312	341	370	386
14	44	57	71	73	99	117	121	138	175	200	226	257	288	302	333	363	378
15	40	54	65	68	91	107	111	127	166	190	218	248	278	291	321	350	365
16	36	50	61	64	82	98	101	116	157	180	209	238	267	280	309	337	351
17	32	47	57	60	77	90	93	106	148	170	201	229	257	269	297	325	338
18	28	43	53	55	73	85	88	101	139	160	192	220	247	258	285	312	325
19	24	40	49	51	69	81	83	95	130	150	184	210	237	247	274	299	312
20		36	45	47	64	76	78	90	121	140	175	201	226	236	262	287	298
21		33	41	42	60	71	73	84	112	130	167	191	216	225	250	274	285
22		29	37	38	56	67	68	79	107	123	158	182	206	214	238	261	272
23		25	34	34	51	62	63	74	103	118	150	172	195	203	226	249	258
24			30		47	57	58	68	98	113	141	163	185	192	214	236	245
25					43	52	53	63	93	108	132	154	175	181	203	223	232
26					39	48	48	57	89	103	126	144	164	170	191	210	218
27					34	43	43	52	84	98	121	139	157	164	181	198	207
28								47	80	93	117	134	152	158	175	192	200
29									75	88	113	130	146	153	169	186	193
30									71	83	109	125	141	147	164	179	187
Area, in. ²	7.74	8.26	9.62	10.25	11.49	13.05	13.67	15.23	15.96	17.87	18.19	20.47	22.75	24.00	26.24	28.44	29.69
I ₁₋₁ , in. ⁴	134	148	176	181	201	232	237	267	279	315	319	361	401	412	451	489	500
r ₁₋₁ , in.	4.16	4.23	4.28	4.20	4.18	4.22	4.17	4.19	4.18	4.20	4.19	4.20	4.20	4.14	4.15	4.15	4.10
I ₂₋₂ , in. ⁴	10.3	16.0	20.2	20.7	30.3	36.3	37.2	43.5	70.6	82.3	119	139	160	165	186	205	213
r ₂₋₂ , in.	1.15	1.39	1.45	1.42	1.62	1.67	1.65	1.69	2.10	2.15	2.56	2.61	2.65	2.62	2.66	2.69	2.68
Weight, Lbs. per Foot	26.5	28.1	32.9	35.0	39.4	44.6	46.8	52.0	54.4	60.8	62.0	70.0	77.6	81.8	89.4	97.0	101.3

Safe load values above and to right of upper zigzag line are for ratios of l/r not over 120, those between zigzag lines are for ratios up to 120 l/r , and those below lower zigzag line are for ratios not over 200 l/r .

PLATE AND ANGLE COLUMNS—Continued

SAFE LOADS IN THOUSANDS OF POUNDS

Allowable Fiber Stress per square inch, 13,000 pounds for lengths of 60 radii or under, reduced for lengths over 60 radii; see Construction Specifications.

Weights do not include rivet heads or other details.

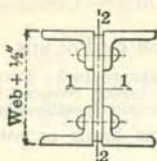

Effective Length in Feet	Web Plate 12 x 1/4			Web Pl. 12 x 5/16		Web Plate 12 x 3/8						Web Plate 12 x 1/2				Web Plate 12 x 3/4		Web Plate 12 x 1	
	4 Angles 3 1/2 x 3 1/2 x 3/8			4 Angles 4 x 3 x 3/8		4 Angles 4 x 3 x 3/8		4 Angles 4 x 3 x 3/8		4 Angles 5 x 3 1/2 x 5/16		4 Angles 5 x 3 1/2 x 5/16		4 Angles 6 x 4 x 1/2		4 Angles 6 x 4 x 1/2		4 Angles 6 x 4 x 3/4	
	114	132	148	157	178	187	217	242	266	276	305	325	354	383	411	439	458	478	
6	114	132	148	157	178	187	217	242	266	276	305	325	354	383	411	439	458	478	
7	112	132	148	157	178	187	217	242	266	276	305	325	354	383	411	439	458	478	
8	104	123	148	157	178	187	217	242	266	276	305	325	354	383	411	439	458	478	
9	96	115	140	147	169	177	217	242	266	276	305	325	354	383	411	439	458	478	
10	89	106	131	138	159	167	217	242	266	276	305	325	354	383	411	439	458	478	
11	81	98	123	129	149	156	210	237	264	276	305	325	354	383	411	439	458	478	
12	73	89	114	120	139	145	201	226	252	276	305	325	354	383	411	439	458	478	
13	65	80	106	111	129	134	191	215	241	274	305	323	354	383	411	439	458	478	
14	59	72	97	101	119	124	181	205	229	264	295	312	342	373	403	433	451	469	
15	55	67	89	92	109	113	171	194	218	254	284	300	330	359	389	418	435	452	
16	52	63	80	84	99	102	162	184	206	244	274	288	317	346	375	403	419	436	
17	48	58	76	79	92	96	152	173	195	234	263	277	305	333	361	388	404	420	
18	44	54	71	75	87	91	142	162	184	224	252	265	292	319	347	373	388	403	
19	40	50	67	70	82	85	132	152	172	214	241	253	280	306	333	358	372	387	
20	36	45	63	65	77	80	123	141	161	204	230	242	267	293	318	344	357	370	
21	32	41	59	61	72	75	115	130	149	194	220	230	255	279	304	329	341	354	
22	28	37	55	56	67	69	110	125	141	184	209	218	242	266	290	314	325	338	
23		33	50	52	62	64	105	120	135	174	198	207	230	253	276	299	310	321	
24			46	47	57	58	100	114	129	164	187	195	217	239	262	284	294	305	
25			42	42	52	53	95	109	123	155	176	183	204	226	248	269	278	288	
26				38	38	47	48	91	104	118	147	166	173	192	213	234	254	262	272
27					42	48	86	98	112	142	160	167	185	203	220	239	247	256	
28						81	93	106	137	154	162	179	196	213	230	239	248		
29						76	88	101	132	149	156	173	189	206	223	231	240		
30						71	82	95	127	143	150	166	183	199	215	223	232		
Area, in. ²	8.76	10.12	11.36	12.11	13.67	14.42	16.70	18.62	20.50	21.22	23.50	25.00	27.24	29.44	31.60	33.76	35.26	36.76	
I ₁₋₁ , in. ⁴	222	264	295	304	350	359	421	476	526	544	605	623	683	741	794	849	867	885	
r ₁₋₁ , in.	5.04	5.11	5.09	5.01	5.06	4.99	5.02	5.05	5.07	5.06	5.07	4.99	5.01	5.02	5.01	5.01	4.96	4.91	
I ₂₋₂ , in. ⁴	16.0	20.2	29.6	30.3	36.3	37.3	70.6	82.3	94.8	139	160	165	186	206	228	249	257	266	
r ₂₋₂ , in.	1.35	1.41	1.61	1.58	1.63	1.61	2.06	2.10	2.15	2.56	2.61	2.57	2.61	2.65	2.69	2.72	2.70	2.69	
Weight, Lbs. per Foot	29.8	34.6	39.0	41.6	46.8	49.3	56.9	63.3	69.7	72.5	80.1	85.2	92.8	100.4	107.6	114.8	119.9	125.0	

Safe load values above and to right of upper zigzag line are for ratios of l/r not over 60, those between zigzag lines are for ratios up to 120 l/r and those below lower zigzag line are for ratios not over 200 l/r.

RIVETED COLUMNS

PLATE AND ANGLE COLUMNS—Continued

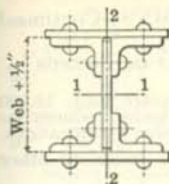

SAFE LOADS IN THOUSANDS OF POUNDS

Allowable Fiber Stress per square inch, 13,000 pounds for lengths of 60 radii or under, reduced for lengths over 60 radii; see Construction Specifications.

Weights do not include rivet heads or other details.

Effective Length in Feet	Web Plate 12 x 3/8				Web Plate 12 x 1/2				Web Plate 12 x 5/8			
	4 Angles 6 x 4 x 3/8 2 Plates 14 x 3/8	4 Angles 6 x 4 x 3/8 2 Plates 14 x 1/2	4 Angles 6 x 4 x 7/16 2 Plates 14 x 1/2	4 Angles 6 x 4 x 1/2 2 Plates 14 x 1/2	4 Angles 6 x 4 x 1/2 2 Plates 14 x 1/2	4 Angles 6 x 4 x 3/4 2 Plates 14 x 5/8	4 Angles 6 x 4 x 9/16 2 Plates 14 x 5/8	4 Angles 6 x 4 x 5/8 2 Plates 14 x 5/8	4 Angles 6 x 4 x 5/8 2 Plates 14 x 5/8	4 Angles 6 x 4 x 5/8 2 Plates 14 x 3/4	4 Angles 6 x 4 x 5/8 2 Plates 14 x 7/8	4 Angles 6 x 4 x 5/8 2 Plates 14 x 1
11	383	428	458	487	507	553	582	610	630	675	721	766
12	383	428	458	487	507	553	582	610	630	675	721	766
13	383	428	458	487	507	553	582	610	630	675	721	766
14	383	428	458	487	507	553	582	610	630	675	721	766
15	383	428	458	487	507	553	582	610	630	675	721	766
16	379	428	458	487	506	553	582	610	630	675	721	766
17	368	419	447	475	491	542	569	596	613	663	714	763
18	357	407	434	461	476	526	553	579	594	644	694	742
19	346	395	421	447	461	510	536	562	576	625	674	721
20	334	383	407	433	447	495	520	544	558	606	654	700
21	323	370	394	419	432	479	503	527	540	587	634	679
22	312	358	381	405	417	463	487	509	522	568	614	658
23	301	346	368	391	403	448	470	492	504	548	594	637
24	289	334	355	377	388	432	454	475	486	529	574	616
25	278	322	342	363	373	416	437	457	468	510	554	595
26	267	310	329	349	358	401	421	440	450	491	534	574
27	256	297	316	335	344	385	404	422	431	472	514	553
28	244	285	303	321	329	369	388	405	413	453	494	532
29	233	273	290	307	314	354	371	388	395	434	474	511
30	222	261	277	293	299	338	354	370	377	415	454	490
31	211	249	264	279	285	323	338	353	359	396	434	469
32	203	237	250	265	272	307	321	336	341	377	414	448
33	197	228	242	257	264	294	309	323	331	361	394	427
34	191	221	235	250	257	287	301	315	322	351	381	409
35	186	215	229	243	249	279	293	306	313	342	371	399
Area, in. ²	29.44	32.94	35.22	37.50	39.00	42.50	44.74	46.94	48.44	51.94	55.44	58.94
I ₁₋₁ , in. ⁴	916	1073	1136	1197	1215	1377	1457	1495	1513	1682	1856	2037
r ₁₋₁ , in.	5.58	5.71	5.68	5.65	5.58	5.69	5.67	5.64	5.59	5.69	5.79	5.88
I ₂₋₂ , in. ⁴	291	348	368	388	394	451	472	492	499	556	613	671
r ₂₋₂ , in.	3.14	3.25	3.23	3.22	3.18	3.26	3.25	3.24	3.21	3.27	3.33	3.37
Weight, Lbs. per Foot	100.2	112.1	120.1	127.7	132.8	144.7	152.3	159.9	165.0	176.9	188.8	200.7

Safe load values above and to right of upper zigzag line are for ratios of l/r not over 60, those between zigzag lines are for ratios up to 120 l/r , and those below lower zigzag line are for ratios not over 200 l/r .

PLATE AND ANGLE COLUMNS—Continued

SAFE LOADS IN THOUSANDS OF POUNDS

Allowable Fiber Stress per square inch, 13,000 pounds for lengths of 60 radii or under, reduced for lengths over 60 radii; see Construction Specifications.

Weights do not include rivet heads or other details.

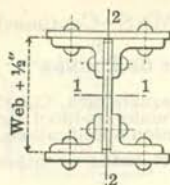

Effective Length in Feet	Web Plate 12 x 5/8								Web Plate 14 x 3/8							
	4 Angles 6 x 4 x 5/8 2 Plates 14 x 1 1/8	4 Angles 6 x 4 x 5/8 2 Plates 14 x 1 1/4	4 Angles 6 x 4 x 5/8 2 Plates 14 x 1 3/8	4 Angles 6 x 4 x 5/8 2 Plates 14 x 1 1/2	4 Angles 6 x 4 x 5/8 2 Plates 14 x 1 5/8	4 Angles 6 x 4 x 5/8 2 Plates 14 x 1 3/4	4 Angles 6 x 4 x 5/8 2 Plates 14 x 1 7/8	4 Angles 6 x 4 x 5/8 2 Plates 14 x 2	4 Angles 6 x 4 x 5/8 2 Plates 14 x 3/8	4 Angles 6 x 4 x 5/8 2 Plates 14 x 3/8	4 Angles 6 x 4 x 5/8 2 Plates 14 x 3/8	4 Angles 6 x 4 x 5/8 2 Plates 14 x 3/8	4 Angles 6 x 4 x 5/8 2 Plates 14 x 3/8	4 Angles 6 x 4 x 5/8 2 Plates 14 x 3/8		
11	812	857	903	948	994	1039	1085	1130	392	422	452	474	497			
12	812	857	903	948	994	1039	1085	1130	392	422	452	474	497			
13	812	857	903	948	994	1039	1085	1130	392	422	452	474	497			
14	812	857	903	948	994	1039	1085	1130	392	422	452	474	497			
15	812	857	903	948	994	1039	1085	1130	392	422	452	474	497			
16	812	857	903	948	994	1039	1085	1130	387	415	444	470	497			
17	812	857	903	948	994	1039	1085	1130	375	403	431	456	482			
18	791	840	888	937	986	1034	1082	1130	363	390	417	442	468			
19	769	817	864	912	960	1007	1054	1101	352	377	404	428	453			
20	747	794	840	887	934	980	1026	1072	340	365	390	415	439			
21	725	771	817	862	908	953	998	1043	328	352	377	401	425			
22	703	748	793	837	882	926	970	1014	317	340	363	387	410			
23	681	725	769	812	856	899	942	985	305	327	350	373	396			
24	659	702	745	787	830	872	914	956	293	314	336	359	381			
25	637	679	721	762	805	845	886	927	281	302	323	345	367			
26	615	657	697	738	779	818	858	898	270	289	309	331	353			
27	593	634	673	713	753	791	830	869	258	276	296	317	338			
28	571	611	649	688	727	764	802	840	246	264	282	303	324			
29	549	588	625	663	701	737	774	811	235	251	269	289	309			
30	527	565	601	638	675	710	746	782	223	239	255	275	295			
31	505	542	577	613	649	684	718	753	211	227	243	261	281			
32	483	519	553	588	623	657	690	725	205	220	236	251	267			
33	461	496	529	563	597	630	662	696	200	214	229	244	260			
34	439	473	505	538	571	603	634	667	194	208	222	237	253			
35	427	456	484	513	545	576	606	638	188	201	216	230	245			
Area, in. ²	62.44	65.94	69.44	72.94	76.44	79.94	83.44	86.94	30.19	32.47	34.75	36.50	38.25			
I ₁₋₁ , in. ⁴	2224	2418	2618	2825	3038	3259	3486	3721	1261	1351	1436	1539	1643			
r ₁₋₁ , in.	5.97	6.06	6.14	6.22	6.30	6.38	6.46	6.54	6.46	6.45	6.43	6.49	6.55			
I ₂₋₂ , in. ⁴	728	785	842	899	956	1014	1071	1128	291	311	331	360	388			
r ₂₋₂ , in.	3.41	3.45	3.48	3.51	3.54	3.56	3.58	3.60	3.10	3.09	3.09	3.14	3.19			
Weight, Lbs. per Foot	212.6	224.5	236.4	248.3	260.2	272.1	284.0	295.9	102.8	110.8	118.4	124.3	130.3			

Safe load values above and to right of upper zigzag line are for ratios of l/r not over 80, those between zigzag lines are for ratios up to 120 l/r, and those below lower zigzag line are for ratios not over 200 l/r.

RIVETED COLUMNS

PLATE AND ANGLE COLUMNS—Continued

SAFE LOADS IN THOUSANDS OF POUNDS

Allowable Fiber Stress per square inch, 13,000 pounds for lengths of 60 radii or under, reduced for lengths over 60 radii; see Construction Specifications.

Weights do not include rivet heads or other details.

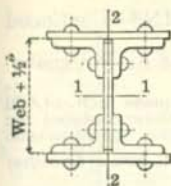

Effective Length in Feet	Web Plate 14 x 3/8		Web Plate 14 x 1/2		Web Plate 14 x 5/8							
	4 Angles 6 x 4 x 1/2 2 Plates 14 x 5/8	4 Angles 6 x 4 x 1/2 2 Plates 14 x 5/8	4 Angles 6 x 4 x 1/2 2 Plates 14 x 5/8	4 Angles 6 x 4 x 1/2 2 Plates 14 x 5/8	4 Angles 6 x 4 x 5/8 2 Plates 14 x 5/8	4 Angles 6 x 4 x 5/8 2 Plates 14 x 5/8	4 Angles 6 x 4 x 5/8 2 Plates 14 x 5/8	4 Angles 6 x 4 x 5/8 2 Plates 14 x 5/8	4 Angles 6 x 4 x 5/8 2 Plates 14 x 5/8	4 Angles 6 x 4 x 5/8 2 Plates 14 x 5/8	4 Angles 6 x 4 x 5/8 2 Plates 14 x 5/8	4 Angles 6 x 4 x 5/8 2 Plates 14 x 5/8
11	520	543	566	595	623	646	691	737	782	828	873	919
12	520	543	566	595	623	646	691	737	782	828	873	919
13	520	543	566	595	623	646	691	737	782	828	873	919
14	520	543	566	595	623	646	691	737	782	828	873	919
15	520	543	566	595	623	646	691	737	782	828	873	919
16	520	543	566	595	623	643	691	737	782	828	873	919
17	507	533	551	578	605	624	675	726	776	826	873	919
18	493	517	535	561	587	606	655	705	754	803	852	901
19	478	502	518	544	569	587	635	684	733	780	829	876
20	463	487	502	527	551	568	615	664	711	758	805	851
21	448	472	486	510	533	549	596	643	689	735	782	827
22	433	456	470	493	515	530	576	622	668	713	758	802
23	418	441	454	476	497	511	556	602	646	690	734	778
24	403	426	437	459	479	493	536	581	625	667	711	753
25	388	410	421	442	461	474	517	560	603	645	687	728
26	374	395	405	424	443	455	497	540	581	622	664	704
27	359	380	389	407	425	436	477	519	560	600	640	679
28	344	364	373	390	407	417	457	498	538	577	617	655
29	329	349	356	373	390	399	438	477	516	554	593	630
30	314	334	340	356	372	380	418	457	495	532	569	605
31	299	318	324	339	354	361	398	436	473	509	546	581
32	284	303	308	322	336	345	378	415	452	487	522	556
33	275	290	298	312	327	336	365	396	430	464	499	532
34	267	282	290	304	318	326	356	385	415	444	475	507
35	260	275	282	295	309	317	346	375	404	432	461	489
Area, in. ²	40.00	41.75	43.50	45.74	47.94	49.69	53.19	56.69	60.19	63.69	67.19	70.69
I ₁₋₁ , in. ⁴	1749	1857	1885	1970	2053	2081	2302	2529	2764	3006	3255	3512
r ₁₋₁ , in.	6.61	6.67	6.58	6.56	6.54	6.47	6.58	6.68	6.78	6.87	6.96	7.05
I ₂₋₂ , in. ⁴	417	446	451	472	492	499	556	613	671	728	785	842
r ₂₋₂ , in.	3.23	3.27	3.22	3.21	3.20	3.17	3.23	3.29	3.34	3.38	3.42	3.45
Weight, Lbs. per Foot	136.2	142.2	148.1	155.7	163.3	169.3	181.2	193.1	205.0	216.9	228.8	240.7

Safe load values above and to right of upper zigzag line are for ratios of l/r not over 60, those between the zigzag lines are for ratios up to 120 l/r , and those below lower zigzag line are for ratios not over 200 l/r .

PLATE AND ANGLE COLUMNS—Continued

SAFE LOADS IN THOUSANDS OF POUNDS

Allowable Fiber Stress per square inch, 13,000 pounds for lengths of 60 radii or under, reduced for lengths over 60 radii; see Construction Specifications.

Weights do not include rivet heads or other details.

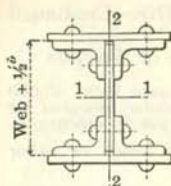

Effective Length in Feet	Web Plate 14 x 5/8											
	4 Angles 6 x 4 x 5/8 2 Plates 14 x 1 1/2	4 Angles 6 x 4 x 5/8 2 Plates 14 x 1 3/4	4 Angles 6 x 4 x 5/8 2 Plates 14 x 1 3/4	4 Angles 6 x 4 x 5/8 2 Plates 14 x 1 7/8	4 Angles 6 x 4 x 5/8 2 Plates 14 x 2	4 Angles 6 x 4 x 5/8 2 Plates 16 x 1 1/2	4 Angles 6 x 4 x 5/8 2 Plates 16 x 2	4 Angles 6 x 6 x 5/8 2 Plates 16 x 2	4 Angles 6 x 6 x 5/8 2 Plates 16 x 2 1/4	4 Angles 6 x 6 x 5/8 2 Plates 16 x 2 1/4	4 Angles 6 x 6 x 5/8 2 Plates 16 x 2 1/2	4 Angles 6 x 6 x 5/8 2 Plates 16 x 2 1/2
11	964	1010	1055	1101	1146	1198	1250	1315	1367	1419	1471	1523
12	964	1010	1055	1101	1146	1198	1250	1315	1367	1419	1471	1523
13	964	1010	1055	1101	1146	1198	1250	1315	1367	1419	1471	1523
14	964	1010	1055	1101	1146	1198	1250	1315	1367	1419	1471	1523
15	964	1010	1055	1101	1146	1198	1250	1315	1367	1419	1471	1523
16	964	1010	1055	1101	1146	1198	1250	1315	1367	1419	1471	1523
17	964	1010	1055	1101	1146	1198	1250	1315	1367	1419	1471	1523
18	949	998	1046	1095	1144	1198	1250	1315	1367	1419	1471	1523
19	924	971	1018	1067	1114	1198	1250	1315	1367	1419	1471	1523
20	898	945	991	1038	1084	1198	1250	1308	1364	1419	1471	1523
21	872	918	963	1010	1055	1174	1229	1277	1333	1388	1443	1497
22	847	892	935	981	1025	1146	1201	1246	1301	1356	1409	1463
23	821	865	908	953	996	1119	1172	1216	1269	1323	1375	1428
24	796	839	880	924	966	1091	1144	1185	1237	1290	1342	1393
25	770	812	853	895	937	1064	1115	1154	1206	1258	1308	1359
26	744	786	825	867	907	1036	1087	1123	1174	1225	1274	1324
27	719	759	797	838	877	1009	1058	1093	1142	1192	1241	1289
28	693	732	770	810	848	981	1030	1062	1111	1160	1207	1254
29	668	706	742	781	818	954	1001	1031	1079	1127	1173	1220
30	642	679	715	753	789	926	973	1000	1047	1094	1139	1185
31	617	653	687	724	759	899	944	970	1015	1062	1106	1150
32	591	626	659	696	730	871	916	939	984	1029	1072	1115
33	565	600	632	667	700	843	887	908	952	996	1038	1081
34	540	573	604	639	671	816	859	877	920	964	1005	1046
35	517	546	577	610	641	788	830	847	889	931	971	1011
Area, in. ²	74.19	77.69	81.19	84.69	88.19	92.19	96.19	101.19	105.19	109.19	113.19	117.19
I ₁₋₁ , in. ⁴	3776	4048	4327	4615	4910	5120	5457	5484	5830	6187	6552	6928
r ₁₋₁ , in.	7.13	7.22	7.30	7.38	7.46	7.45	7.53	7.36	7.44	7.53	7.61	7.69
I ₂₋₂ , in. ⁴	899	956	1014	1071	1128	1493	1579	1581	1666	1752	1837	1922
r ₂₋₂ , in.	3.48	3.51	3.53	3.56	3.58	4.02	4.05	3.95	3.98	4.01	4.03	4.05
Weight, Lbs. per Foot	252.6	264.5	276.4	288.3	300.2	313.8	327.4	344.2	357.8	371.4	385.0	398.6

Safe load values above and to right of upper zigzag line are for ratios of l/r not over 60, those between the zigzag lines are for ratios up to 120 l/r and those below lower zigzag line are for ratios not over 200 l/r.

RIVETED COLUMNS

PLATE AND ANGLE COLUMNS—Concluded

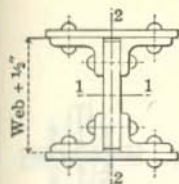

SAFE LOADS IN THOUSANDS OF POUNDS

Allowable Fiber Stress per square inch, 13,000 pounds for lengths of 60 radii or under, reduced for lengths over 60 radii; see Construction Specifications.

Weights do not include rivet heads or other details.

Effective Length in Feet	Two Web Plates 14 x 1/2						Two Web Plates 14 x 5/8					
	4 Angles 6 x 6 x 5/8 2 Plates 16 x 2 1/2	4 Angles 8 x 6 x 5/8 2 Plates 16 x 2 1/2	4 Angles 8 x 6 x 5/8 2 Plates 18 x 2 3/8	4 Angles 8 x 6 x 5/8 2 Plates 18 x 2 3/2	4 Angles 8 x 6 x 5/8 2 Plates 18 x 2 3/4	4 Angles 8 x 6 x 5/8 2 Plates 18 x 2 3/4	4 Angles 8 x 6 x 5/8 2 Plates 20 x 2 3/4	4 Angles 8 x 6 x 5/8 2 Plates 20 x 2 3/4	4 Angles 8 x 6 x 5/8 2 Plates 20 x 3	4 Angles 8 x 6 x 5/8 2 Plates 20 x 3 3/8		
11	1592	1657	1728	1787	1845	1904	1949	2027	2092	2157	2222	2287
12	1592	1657	1728	1787	1845	1904	1949	2027	2092	2157	2222	2287
13	1592	1657	1728	1787	1845	1904	1949	2027	2092	2157	2222	2287
14	1592	1657	1728	1787	1845	1904	1949	2027	2092	2157	2222	2287
15	1592	1657	1728	1787	1845	1904	1949	2027	2092	2157	2222	2287
16	1592	1657	1728	1787	1845	1904	1949	2027	2092	2157	2222	2287
17	1592	1657	1728	1787	1845	1904	1949	2027	2092	2157	2222	2287
18	1592	1657	1728	1787	1845	1904	1949	2027	2092	2157	2222	2287
19	1592	1657	1728	1787	1845	1904	1949	2027	2092	2157	2222	2287
20	1590	1657	1728	1787	1845	1904	1949	2027	2092	2157	2222	2287
21	1553	1653	1728	1787	1845	1904	1949	2027	2092	2157	2222	2287
22	1516	1616	1728	1787	1845	1904	1949	2027	2092	2157	2222	2287
23	1479	1580	1728	1787	1845	1904	1949	2027	2092	2157	2222	2287
24	1443	1543	1695	1756	1818	1879	1918	2027	2092	2157	2222	2287
25	1406	1507	1661	1721	1781	1842	1879	2027	2092	2157	2222	2287
26	1369	1470	1626	1685	1744	1804	1841	2009	2077	2146	2214	2283
27	1332	1434	1592	1650	1708	1766	1802	1972	2039	2107	2175	2242
28	1295	1397	1557	1614	1671	1729	1763	1935	2002	2068	2135	2202
29	1258	1360	1522	1578	1635	1691	1724	1899	1964	2029	2095	2161
30	1222	1324	1488	1543	1598	1653	1686	1862	1926	1991	2055	2120
31	1185	1287	1453	1507	1561	1616	1647	1825	1889	1952	2016	2079
32	1148	1251	1419	1471	1525	1578	1608	1789	1851	1913	1976	2039
33	1111	1214	1384	1436	1488	1541	1569	1752	1813	1874	1936	1998
34	1074	1177	1349	1400	1451	1503	1530	1715	1775	1836	1896	1957
35	1038	1141	1315	1365	1415	1465	1492	1679	1738	1797	1857	1916
Area, in. ²	122.44	127.44	132.94	137.44	141.94	146.44	149.94	155.94	160.94	165.94	170.94	175.94
I ₁₋₁ , in. ⁴	7014	7254	7559	7981	8415	8859	8916	9248	9741	10248	10767	11298
r ₁₋₁ , in.	7.57	7.54	7.54	7.62	7.70	7.78	7.71	7.70	7.78	7.86	7.94	8.01
I ₂₋₂ , in. ⁴	1946	2229	2831	2953	3074	3196	3222	4049	4216	4383	4549	4716
r ₂₋₂ , in.	3.99	4.18	4.61	4.63	4.65	4.67	4.64	5.10	5.12	5.14	5.16	5.18
Weight, Lbs. per Foot	416.4	433.6	452.3	467.6	482.9	498.2	510.1	530.5	547.5	564.5	581.5	598.5

Safe load values above and to right of zigzag line are for ratios of l/r not over 60, those below zigzag line are for ratios not over 120 l/r.

TYPICAL COLUMN DETAILS

OFFICE BUILDING CONSTRUCTION

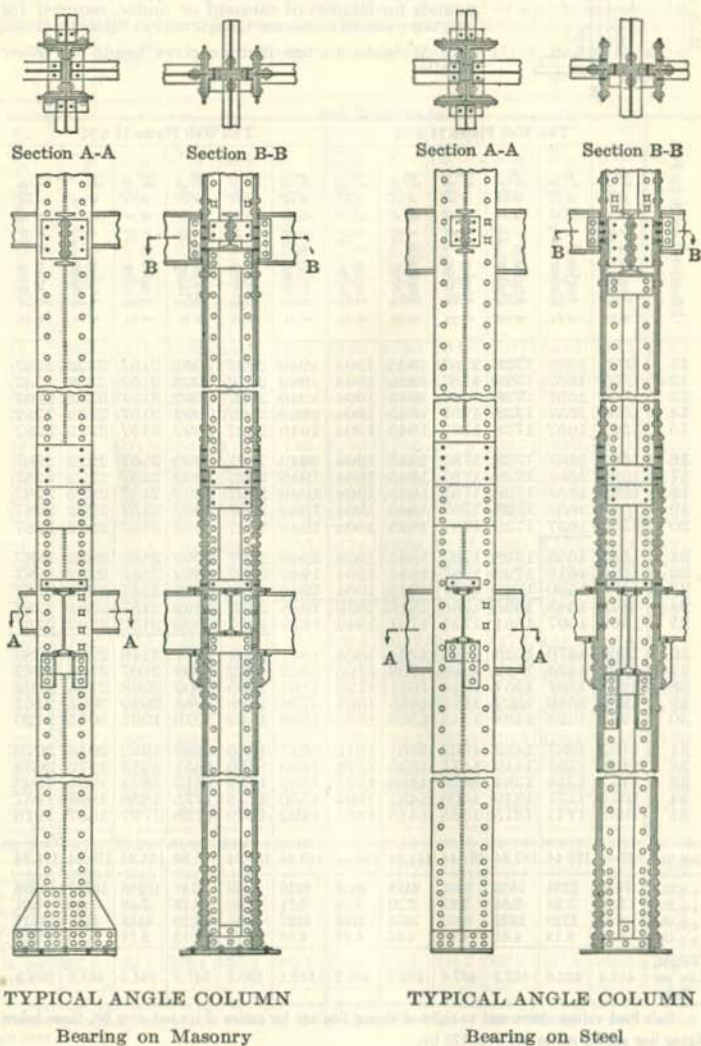

TYPICAL ANGLE COLUMN

Bearing on Masonry

TYPICAL ANGLE COLUMN

Bearing on Steel

TYPICAL COLUMN DETAILS

OFFICE BUILDING CONSTRUCTION

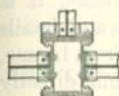

Section A-A

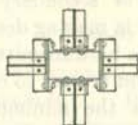

Section B-B

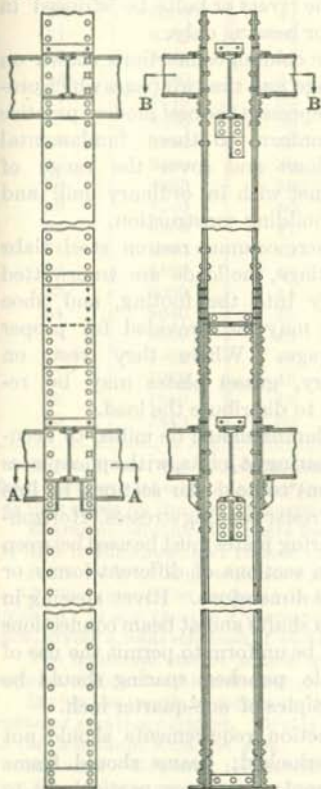

TYPICAL CHANNEL COLUMN

Bearing on Steel

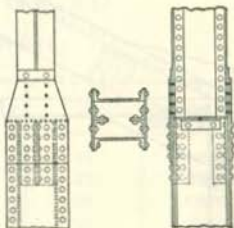

TYPICAL SPLICE

Angle Column to Channel Column

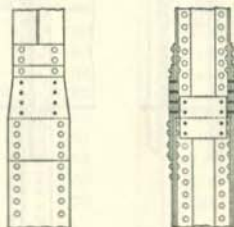

TYPICAL SPLICE

Angle Columns, different sizes

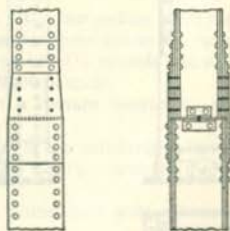

TYPICAL SPLICE

Channel Columns, different sizes

TYPICAL COLUMN DETAILS

Simplicity in details is essential to economical construction. To eliminate bending or secondary stresses, it is desirable in making designs and details that loads be transmitted from beams, girders and trusses to columns directly and with the minimum number of connecting pieces, rivets, or bolts, and that the rivets or bolts be stressed in shear or bearing only.

The column connections shown on this page and the two pages which precede, represent the best modern practice and conform to these fundamental conditions and cover the range of cases met with in ordinary mill and office building construction.

Where columns rest on steel slabs or castings, the loads are transmitted directly into the footing, and shoe angles may be provided for proper anchorage. Where they rest on masonry, gusset plates may be required to distribute the load.

Columns should be milled to accurate bearing at joints, with splice plates sufficient to hold the sections in line and to resist bending stresses. Horizontal bearing plates must be used between column sections of different forms or general dimensions. Rivet spacing in column shafts and at beam connections should be uniform to permit the use of multiple punches; spacing should be in multiples of one-quarter inch.

Erection requirements should not be overlooked; beams should frame with ample clearances, particularly to column webs, and rivets should be countersunk or flattened where necessary to swing beams into position.

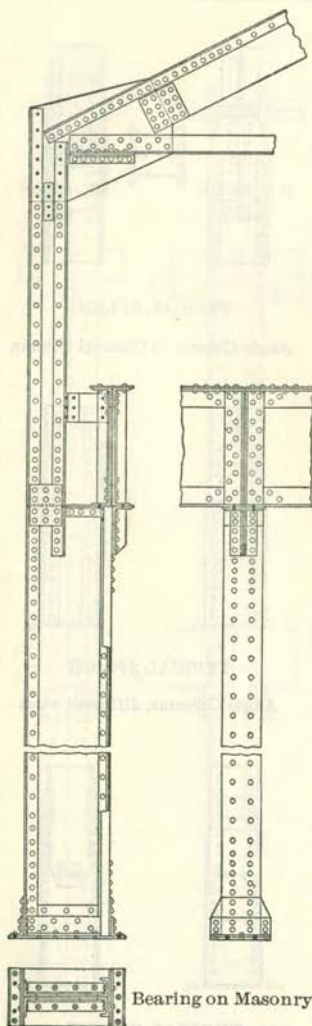

MILL BUILDING COLUMN

CAST IRON COLUMNS

CAST IRON COLUMNS

ALLOWABLE UNIT STRESSES IN POUNDS PER SQUARE INCH

By NEW YORK BUILDING LAW, 1917

9000-40 l/r lbs. per square inch

l/r	Lbs. per Sq. In.	l/r	Lbs. per Sq. In.	l/r	Lbs. per Sq. In.
0	9000	30	7800	51	6960
10	8600	31	7760	52	6920
11	8560	32	7720	53	6880
12	8520	33	7680	54	6840
13	8480	34	7640	55	6800
14	8440	35	7600	56	6760
15	8400	36	7560	57	6720
16	8360	37	7520	58	6680
17	8320	38	7480	59	6640
18	8280	39	7440	60	6600
19	8240	40	7400	61	6560
20	8200	41	7360	62	6520
21	8160	42	7320	63	6480
22	8120	43	7280	64	6440
23	8080	44	7240	65	6400
24	8040	45	7200	66	6360
25	8000	46	7160	67	6320
26	7960	47	7120	68	6280
27	7920	48	7080	69	6240
28	7880	49	7040	70	6200
29	7840	50	7000		

The safe load for a cast iron column of given dimensions is determined from the above table by obtaining the ratio of l/r and multiplying the corresponding unit stress by the sectional area of column.

Example:—Required the safe load of a cast iron column, 15 inches square, $\frac{3}{8}$ inch in thickness, and 16 feet long.

From table of Hollow Square Sections, page 137, the radius of gyration is 5.78 inches and the sectional area is 49.44 square inches; hence the ratio of $l/r = 16 \times 12 \div 5.78 = 33.2$, corresponding to a stress of 7672 pounds per square inch, giving a total safe load of $49.44 \times 7672 = 379300$ pounds.

The minimum size of a cast iron column of a certain length to safely support a given load is determined as follows:

Divide the length in inches by 70; the quotient is the minimum allowable radius of gyration required. Divide the total load by 6200 pounds; the quotient is the minimum sectional area.

Example:—Required the minimum size of a round cast iron column, 20 feet long, to support a load of 235000 pounds.

The minimum radius of gyration is $20 \times 12 \div 70 = 3.43$ inches; the minimum area is $235000 \div 6200 = 37.90$ square inches. From table of Hollow Round Sections, page 136, the nearest minimum size for this radius of gyration and this area is found to be a column 11 inches in diameter and $1\frac{1}{4}$ inches in thickness.

CARNEGIE STEEL COMPANY

ROUND CAST IRON COLUMNS

ALLOWABLE LOADS IN THOUSANDS OF POUNDS

By New York Building Law, 1917

Weights do not include details

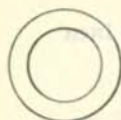

Outer Dia., Inches	Thick-ness, Inches	Area, Inches ²	Weight per Foot, Pounds	Least Radius, Inches	Effective Length of Column in Feet																		
					8	10	12	14	16	18	20	22	24	26	28								
6	1/2	8.64	27.0	1.95	61	56																	
	5/8	10.55	33.0	1.91	74	68																	
	3/4	12.37	38.7	1.88	86	80																	
	7/8	14.09	44.0	1.84	97	90																	
7	5/8	12.52	39.1	2.27	92	86	81																
	3/4	14.73	46.0	2.23	107	101	95																
	7/8	16.84	52.6	2.19	122	115	107																
	1	18.85	58.9	2.15	136	128	119																
8	3/4	17.08	53.4	2.58	128	122	116	109															
	7/8	19.59	61.2	2.54	147	139	132	124															
	1	21.99	68.7	2.50	164	156	147	139															
	1 1/8	24.30	75.9	2.46	181	171	162	152															
9	7/8	22.34	69.8	2.89	171	164	157	149	142														
	1	25.13	78.5	2.85	192	184	175	167	158														
	1 1/8	27.83	87.0	2.81	212	203	193	184	174														
	1 1/4	30.43	95.1	2.78	232	221	211	200	190														
10	1	28.28	88.4	3.20	221	212	204	195	187	178													
	1 1/8	31.37	98.0	3.16	244	235	225	216	206	197													
	1 1/4	34.36	107.4	3.13	267	257	246	235	225	214													
	1 3/8	37.26	116.4	3.09	289	277	266	254	243	231													
11	1 1/8	34.90	109.1	3.51	276	266	257	247	238	228	219												
	1 1/4	38.29	119.7	3.48	302	292	281	271	260	250	239												
	1 3/8	41.58	129.9	3.44	328	316	305	293	281	270	258												
	1 1/2	44.77	139.9	3.40	352	340	327	314	302	289	277												
12	1 1/4	42.22	131.9	3.83	338	327	316	306	295	285	274	264											
	1 3/8	45.90	143.4	3.79	367	355	343	332	320	308	297	285											
	1 1/2	49.48	154.6	3.75	395	382	369	357	344	331	319	306											
	1 5/8	52.97	165.5	3.71	422	408	394	381	367	353	340	326											
13	1 3/8	50.22	156.9	4.14	405	394	382	370	359	347	336	324	312										
	1 1/2	54.19	169.4	4.10	437	424	412	399	386	374	361	348	335										
	1 5/8	58.07	181.5	4.06	468	454	440	427	413	399	385	372	358										
	1 3/4	61.85	193.3	4.03	498	483	468	454	439	424	409	395	380										
14	1 3/8	58.91	184.1	4.45	479	467	454	441	429	416	403	390	378										
	1 1/2	63.18	197.4	4.41	514	500	486	472	459	445	431	417	404										
	1 3/4	67.35	210.5	4.38	547	532	518	503	488	473	459	444	429										
	1 5/8	71.42	223.2	4.34	580	564	548	532	516	501	485	469	453										
15	1 5/8	68.29	213.4	4.76	560	546	532	518	504	491	477	463	449	436									
	1 3/4	72.85	227.6	4.73	597	582	567	552	537	523	508	493	478	463									
	1 7/8	77.31	241.6	4.69	632	617	601	585	569	553	538	522	506	490									
	2	81.68	255.3	4.65	668	651	634	617	600	583	566	550	533	516									
16	1 3/4	78.34	244.8	5.08	646	631	616	601	587	572	557	542	527	513	498								
	1 5/8	83.20	260.0	5.04	685	670	654	638	622	606	590	574	559	543	527								
	2	87.97	274.9	5.00	724	707	690	673	657	640	623	606	589	572	555								
	2 1/4	92.63	289.5	4.96	762	744	726	708	690	672	654	636	619	601	583								

CAST IRON COLUMNS

SQUARE CAST IRON COLUMNS

ALLOWABLE LOADS IN THOUSANDS OF POUNDS

By New York Building Law, 1917

Weights do not include details

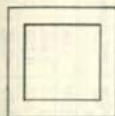

Outer Width, Inches	Thick-ness, Inches	Area, Inches ²	Weight per Foot Pounds	Least Radius, Inches	Effective Length of Column in Feet																			
					8	10	12	14	16	18	20	22	24	26	28									
6	1/2	11.00	34.4	2.26	80	76	71																	
	3/8	13.44	42.0	2.21	98	92	86																	
	1/2	15.75	49.2	2.17	114	107	100																	
	5/8	17.94	56.1	2.12	129	121	113																	
7	3/8	15.94	49.8	2.62	120	114	108	103																
	1/2	18.75	58.6	2.57	141	134	127	120																
	5/8	21.44	63.9	2.53	153	145	137	130																
	1	24.00	75.0	2.48	179	170	160	151																
8	3/4	21.75	68.0	2.98	168	161	154	147	140															
	1	24.94	77.9	2.93	192	184	175	167	159															
	1 1/8	28.00	87.5	2.89	215	205	196	187	178															
	1 1/4	30.94	96.7	2.84	237	226	216	205	195															
9	3/4	27.44	85.8	3.34	215	208	200	192	184	176														
	1	32.00	100.0	3.29	251	241	232	223	213	204														
	1 1/8	35.44	110.8	3.25	277	267	256	246	235	225														
	1 1/4	38.75	121.1	3.21	302	291	279	268	256	244														
10	1	36.00	112.5	3.70	287	277	268	259	249	240	231													
	1 1/8	39.94	124.8	3.65	317	307	296	286	275	265	254													
	1 1/4	43.75	136.7	3.61	347	336	324	312	301	289	277													
	1 3/8	47.44	148.3	3.57	376	363	350	338	325	312	299													
11	1 1/8	44.44	138.9	4.06	358	347	337	326	316	305	295	284												
	1 1/4	48.75	152.3	4.01	392	380	369	357	345	334	322	310												
	1 3/8	52.94	165.4	3.97	425	412	400	387	374	361	348	336												
	1 1/2	57.00	178.1	3.93	457	443	429	416	402	388	374	360												
12	1 1/4	53.78	168.1	4.42	437	426	414	402	391	379	367	356	344											
	1 3/8	58.44	182.6	4.37	475	462	449	436	423	410	398	385	372											
	1 1/2	63.00	196.9	4.33	511	497	483	469	455	441	427	413	399											
	1 5/8	67.44	210.8	4.29	547	532	516	501	486	471	456	441	426											
13	1 3/8	63.94	199.8	4.78	524	511	498	486	473	460	447	434	421	409										
	1 1/2	69.00	215.6	4.74	565	551	537	523	509	495	481	467	453	439										
	1 5/8	73.94	231.1	4.69	605	590	575	560	544	529	514	499	484	469										
	1 3/4	78.75	246.1	4.65	644	627	611	595	579	562	546	530	514	497										
14	1 1/2	75.00	234.4	5.14	619	605	591	577	563	549	535	521	507	493	479									
	1 3/4	80.44	251.4	5.10	663	648	633	618	603	588	572	557	542	527	512									
	1 5/8	85.75	267.9	5.05	707	690	674	658	641	625	609	593	576	560	544									
	1 3/8	90.94	284.2	5.01	749	731	714	696	679	662	644	627	609	592	574									
15	1 3/8	86.94	271.7	5.50	722	707	691	676	661	646	631	616	600	585	570									
	1 1/2	92.75	289.8	5.46	769	753	737	721	704	688	672	655	639	623	606									
	1 3/4	98.44	307.6	5.41	816	799	782	764	746	729	711	694	676	659	642									
	2	104.00	325.0	5.37	862	843	824	806	787	769	750	731	713	694	676									
16	1 3/4	99.75	311.7	5.86	832	816	800	783	767	751	734	718	702	685	669									
	1 5/8	105.94	331.1	5.82	884	866	849	831	814	796	779	761	744	726	709									
	2	112.00	350.0	5.77	934	915	896	878	859	840	822	803	785	766	747									
	2 1/8	117.94	368.6	5.73	982	963	943	923	903	883	864	844	824	804	785									

CARNEGIE STEEL COMPANY

STEEL PIPE COLUMNS—STANDARD PIPE

Safe Loads in Thousands of Pounds

Nominal Size, In.	15	14	13	12	11	10	9	8	7	6	5	4½	4	3½	3	2½	2	1½
External Dia., In.	16.000	15.000	14.000	12.750	11.750	10.750	9.625	8.625	7.625	6.625	5.563	5.000	4.500	4.000	3.500	2.875	2.375	1.900
Thickness, In.	.375	.375	.375	.375	.375	.365	.342	.322	.301	.280	.268	.247	.237	.226	.216	.203	.154	.145
5	239.3	224.0	208.7	189.5	174.2	154.8	129.6	109.2	90.1	72.5	55.9	48.0	41.2	34.8	29.0	21.6	12.2	7.5
6	239.3	224.0	208.7	189.5	174.2	154.8	129.6	109.2	90.1	72.5	55.9	48.0	41.2	34.8	28.6	19.4	10.6	6.0
7	239.3	224.0	208.7	189.5	174.2	154.8	129.6	109.2	90.1	72.5	55.9	48.0	41.2	34.1	26.3	17.3	9.0	5.0
8	239.3	224.0	208.7	189.5	174.2	154.8	129.6	109.2	90.1	72.5	55.9	48.0	40.1	31.7	24.0	15.1	7.4	4.2
9	239.3	224.0	208.7	189.5	174.2	154.8	129.6	109.2	90.1	72.5	55.9	40.4	37.6	29.3	21.7	12.9	6.6	3.5
10	239.3	224.0	208.7	189.5	174.2	154.8	129.6	109.2	90.1	72.5	54.2	43.8	35.1	26.9	19.4	11.4	5.8	2.7
11	239.3	224.0	208.7	189.5	174.2	154.8	129.6	109.2	90.1	72.5	51.5	41.2	32.6	24.5	17.1	10.3	5.0	
12	239.3	224.0	208.7	189.5	174.2	154.8	129.6	109.2	90.1	70.2	48.7	38.5	30.0	22.1	15.2	9.2	4.1	
13	239.3	224.0	208.7	189.5	174.2	154.8	129.6	109.2	89.9	67.3	46.0	35.9	27.5	19.7	14.0	8.1	3.3	
14	239.3	224.0	208.7	189.5	174.2	154.8	129.6	109.2	86.7	64.3	43.2	33.3	25.0	18.0	12.9	7.0		
15	239.3	224.0	208.7	189.5	174.2	154.8	129.6	108.1	83.5	61.3	40.5	30.6	22.5	16.8	11.7	6.0		
16	239.3	224.0	208.7	189.5	174.2	154.8	129.6	104.7	80.3	58.3	37.7	28.0	21.1	15.6	10.6			
17	239.3	224.0	208.7	189.5	174.2	154.8	127.5	101.3	77.1	55.3	35.0	25.6	19.8	14.4	9.4			
18	239.3	224.0	208.7	189.5	174.2	154.8	123.9	97.8	73.9	52.3	32.2	24.3	18.6	13.2	8.3			
19	239.3	224.0	208.7	189.5	174.2	152.4	120.3	94.4	70.7	49.4	29.8	23.0	17.3	12.0	7.1			
20	239.3	224.0	208.7	189.5	174.2	148.5	116.6	91.0	67.5	46.4	28.4	21.7	16.0	10.8				
21	239.3	224.0	208.7	189.5	170.7	144.6	113.0	87.6	64.3	43.4	27.0	20.3	14.8	9.6				
22	239.3	224.0	208.7	189.1	166.7	140.7	109.3	84.1	61.1	40.4	25.7	19.0	13.5	8.4				
23	239.3	224.0	208.7	185.1	162.7	136.8	105.7	80.7	57.8	38.3	24.3	17.7	12.3					
24	239.3	224.0	208.7	181.1	158.7	132.9	102.0	77.3	54.6	36.8	22.9	16.4	11.0					
25	239.3	224.0	205.0	177.1	154.7	129.0	98.4	73.8	51.4	35.3	21.6	15.1	9.7					
26	239.3	223.4	201.0	173.1	150.7	125.1	94.7	70.4	48.4	33.8	20.2	13.8						
27	239.3	215.4	193.0	169.1	146.7	121.3	91.1	67.0	46.7	32.3	18.8	12.4						
28	237.9	215.4	193.0	165.1	142.7	117.4	87.5	63.5	45.1	30.8	17.4	11.1						
29	233.9	211.4	189.0	161.1	138.7	113.5	83.8	60.1	43.5	29.3	16.1							
30	229.9	207.4	185.0	157.1	134.7	109.6	80.2	57.7	41.9	27.8	14.7							

Effective Length in Feet

Allowable Fiber Stress per square inch, 13,000 pounds for lengths of 60 radii or under, reduced for length over 60 radii; see construction Specifications.
Weights do not include details.
Safe loads above upper zigzag line are for ratios of l/r not over 60, between zigzag lines for ratios up to 120 l/r , below lower zigzag line for ratios not over 200 l/r .

Area, in. ²	18.41	17.23	16.05	14.68	13.40	11.91	9.97	8.40	6.93	5.58	4.30	3.69	3.17	2.68	2.23	1.70	1.08	0.80
I, in. ⁴	562.1	461.0	372.8	279.3	217.0	160.7	107.6	72.5	46.5	28.1	15.2	10.4	7.23	4.79	3.02	1.53	0.666	0.310
r, in.	5.526	5.172	4.819	4.377	4.024	3.674	3.284	2.938	2.592	2.245	1.878	1.583	1.510	1.337	1.164	0.947	0.787	0.623
Weight, lb./ft.	62.58	58.57	54.57	49.56	45.56	40.48	33.91	28.55	23.54	18.97	14.62	12.54	10.79	9.11	7.58	5.79	3.65	2.72

STEEL PIPE COLUMNS

STEEL PIPE COLUMNS—EXTRA STRONG PIPE

Safe Loads in Thousands of Pounds

Nominal Size, in.	15	14	13	12	11	10	9	8	7	6	5	4½	4	3½	3	2½	2	1½
External Dia., in.	16.000	15.000	14.000	12.750	11.750	10.750	9.625	8.625	7.625	6.625	5.563	5.000	4.500	4.000	3.500	2.875	2.375	1.900
Thickness, in.	.500	.500	.500	.500	.500	.500	.500	.500	.500	.432	.375	.355	.337	.318	.300	.276	.218	.200
Effective Length in Feet	5	6	7	8	9	10	11	12	13	14	15	16	17	18	19	20	21	22
Area, in. ²	24.35	22.78	21.21	19.24	17.67	16.10	14.83	12.76	11.19	8.40	6.11	5.18	4.41	3.68	3.02	2.25	1.48	1.07
I, in. ⁴	731.9	599.3	483.8	361.5	280.1	212.0	149.6	105.7	71.4	40.5	20.7	14.0	9.61	6.28	3.89	1.92	0.868	0.391
r, in.	5.483	5.130	4.776	4.335	3.981	3.628	3.281	2.878	2.525	2.195	1.839	1.647	1.477	1.307	1.136	0.924	0.767	0.605
Weight, lb./ft.	82.77	77.43	72.09	65.42	60.08	54.74	48.73	43.39	38.05	28.57	20.78	17.61	14.98	12.51	10.25	7.66	5.02	3.63

Allowable Fiber Stress per square inch, 13,000 pounds for lengths of 60 radii or under; reduced for lengths over 60 radii; see Construction Specifications.

Weights do not include details. Safe loads above upper zigzag line are for ratios of 1/r not over 60, between zigzag lines for ratios up to 130 1/r, below zigzag line for ratios not over 200 1/r.

GRILLAGE FOUNDATIONS

Grillage Beams. In the design of foundations for columns, piers and walls, provision must be made for the uniform distribution of the load over the footing. This is best done by the use of a grillage of steel beams and concrete. This method of construction eliminates deep excavations and large masses of masonry and is, therefore, truly economical. For heavy loads on soils of small bearing capacity, three tiers of beams may be necessary; while for lighter loads or better soils two tiers, or even one, may suffice.

The lower tier should rest upon a solid bed of concrete of sufficient thickness to distribute the load to the soil. Good practice requires the spaces between the beams in all the tiers to be filled with, and the beams enclosed in, concrete not less than four inches thick.

The clear distance between the flanges of the beams in each tier should not be less than $2\frac{1}{2}$ inches, nor more than three times the flange width. The first requirement is necessary to permit the introduction and proper tamping of the concrete, the second, to insure uniform distribution of the load. When separators are used to hold the beams in position, they should be of gas pipe, as cast iron separators tend to break the continuity of the concrete. Grillage beams should not be painted, as concrete does not adhere well to painted surfaces but is itself an excellent preservative of steel.

To determine the area in square feet required for the foundation, divide the total load on the column, pier or wall by the allowable pressure per square foot on the soil. This gives the area of the footing, the shape of which is determined by local conditions. On the assumption that the loads on the soil are uniformly distributed, the number, size and weight of the beams required are determined from the maximum bending moment, the maximum shear, or the maximum web resistance to buckling, as follows:—Let

W = Total load on the foundation, in pounds.
 L = Length of beam, in feet.
 a = Length of loaded portion, in feet.
 d = Depth of beam, in inches.
 t = Thickness of beam web, in inches.
 n = Number of beams in a tier.
 f_b = Allowable unit web buckling resistance.

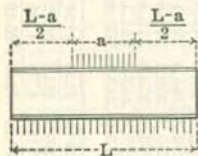

The maximum bending moment occurs at the center of the beam and is equal in foot pounds to $W(L-a) \div 8$; this formula is identical with the formula of maximum bending moment for a beam of length $(L-a)$ under a uniformly distributed load, W .

The proper size of beam in any tier as regards flexure at a fiber stress of 16,000 pounds per square inch may be found in the beam

GRILLAGE FOUNDATIONS

safe load table for the length corresponding to $(L-a)$, by dividing the total load by the number of beams.

Or may be found from the table of maximum bending moments, by dividing the total bending moment by the number of beams;

Or from the table of properties, by dividing by the number of beams in the tier the total section modulus required, which is equal to $\frac{3W(L-a)}{32,000}$

Note, however, that the load on the beam for any span must not exceed the maximum tabular safe load for shear.

The maximum vertical shear occurs at the edge of the column base or at a distance in feet of $\frac{L-a}{2}$ from each end of the beam and is equal to $\frac{W}{L} \times \frac{L-a}{2}$

Web thickness, t , to resist average shear = $\frac{W}{L} \times \frac{L-a}{2} \times \frac{1}{n \times d \times 10,000}$

Or, the average vertical shear = $\frac{W}{L} \times \frac{L-a}{2} \times \frac{1}{n \times d \times t}$, which must not exceed 10,000 pounds per square inch.

The maximum buckling stress occurs on a length in inches of $12a + d/2$ and is equal in total per lineal inch of web to $\frac{W}{12a + d/2}$.

The required thickness of web, t , to resist buckling = $\frac{W}{n \times (12a + d/2) \times fb}$.

Or the average web resistance per square inch to buckling = $\frac{W}{n \times (12a + d/2) \times t}$ which must not exceed the tabular values for the allowable buckling resistance on beam webs.

Rolled Steel Slabs. To distribute the loads from columns over girders, grillage beams, etc., solid slabs of rolled steel may be advantageously used in the place of cast iron or riveted steel bases, etc. The size of the slab is usually fixed by the dimensions of the column and its thickness is determined from the maximum bending moment, on the assumption of uniform loading, as follows:—Let

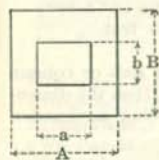

W = Total load, in pounds.

A = Width of slab, in inches.

B = Length of slab, in inches.

t = Thickness of slab, in inches.

a = Outside dimension of column, in inches.

b = Outside dimension of column, in inches.

The maximum bending moment will occur at the center of the slab and equals, in inch pounds, $\frac{W(A-a)}{8}$ or $\frac{W(B-b)}{8}$, and at a fiber stress of 16,000 pounds per square inch, the required thickness

of slab, t , = $\sqrt{\frac{3W(A-a)}{64,000B}}$ or = $\sqrt{\frac{3W(B-b)}{64,000A}}$

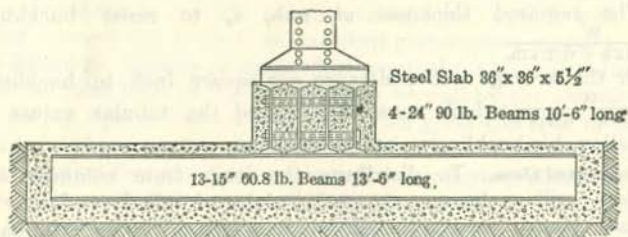
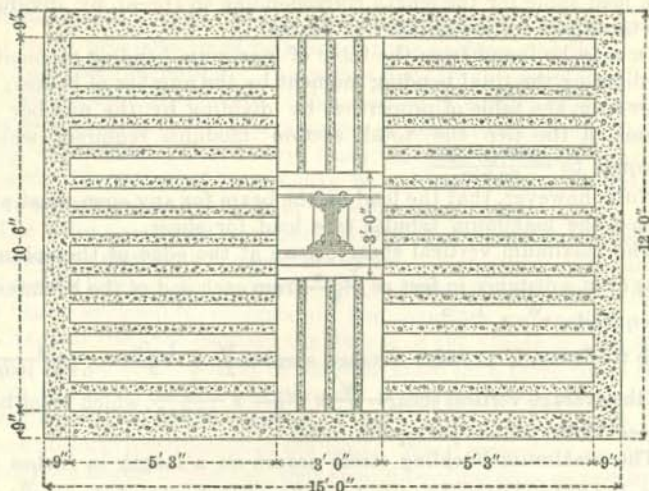

EXAMPLE: Required to design a grillage foundation for a column load of 1,040,000 pounds on soil with an allowable bearing capacity of 6,000 pounds per square foot. Column composed of 1 web plate, 14" x 5/8", 4 flange angles, 6" x 4" x 5/8" and 4 flange plates, 14" x 7/8", outside dimensions 14" x 18".

Required area of footing = $1,040,000 \div 6,000 = 173.33$ square feet.

Use area 12'-0" x 15'-0" = 180 square feet.

Assume 3'-0" square as the dimensions of the rolled steel slab or column base and allow 9" for concrete on the sides and ends of beams, then the dimensions of the steel grillage will be 10'-6" x 13'-6", concrete being assumed of sufficient thickness and strength to distribute to the edges.

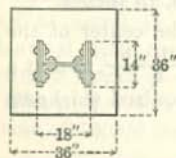

Rolled Steel Slab

Thickness required, $t = \sqrt{\frac{3 \times 1,040,000 \times 22}{64,000 \times 36}} = 5.46$ in.

Use 5 1/2".

GRILLAGE FOUNDATIONS

Beams—Section Modulus Method.

Bottom tier— $L=13.5$ feet; $a=3.0$ feet.

Required total section modulus, $S_r = \frac{3 \times 1,040,000 \times 10.5}{32,000} = 1,023.75 \text{ in.}^3$

Use 13—15" 60.8 lb. beams—Total section modulus=1,055.6 in.³

Average shear = $\frac{1,040,000}{13.5} \times \frac{10.5}{2} \times \frac{1}{13 \times 15 \times .59} = 3,515 \text{ lbs. per sq. in.}$

Average buckling stress = $\frac{1,040,000}{13 \times 43.5 \times .59} = 3,120 \text{ lbs. per sq. in.}$

Top tier— $L=10.5$ feet; $a=3.0$ feet.

Required total section modulus, $S_r = \frac{3 \times 1,040,000 \times 7.5}{32,000} = 731.25 \text{ in.}^3$

Use 4—24" 90 lb. beams—Total section modulus=743.2 in.³

Average shear = $\frac{1,040,000}{10.5} \times \frac{7.5}{2} \times \frac{1}{4 \times 24 \times .624} = 6,200 \text{ lbs. per sq. in.}$

Average buckling stress = $\frac{1,040,000}{4 \times 48 \times .624} = 8,680 \text{ lbs. per sq. in.}$

Plate Girder Grillage Foundations. In those cases where columns carry very heavy loads, plate girders are used for the top tier of the grillage rather than beams. In the case of symmetrical foundations, the method of computation is the same as has already been illustrated in the case of beams. The following example indicates the procedure in the quite frequent case of unsymmetrical loading conditions:

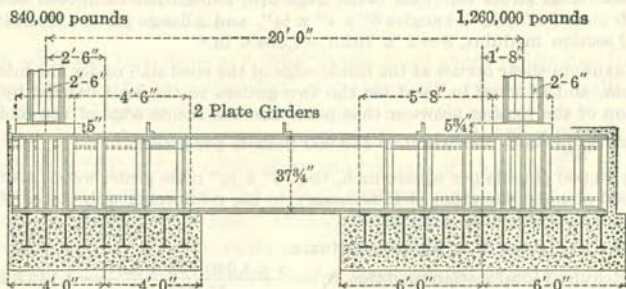

Make up of 1 Plate Girder
 4 Flange Angles $6 \times 4 \times \frac{5}{8}$
 2 Flange Plates $14 \times \frac{5}{8}$
 1 Web Plate $36 \times \frac{1}{2}$
 2 Web Reinf. Plates $\frac{5}{8}$ thick, each end between Flange Angles
 2 Web Reinf. Plates $\frac{3}{8}$ thick, each end over Flange Angles
 Stiffener Angles $5 \times 3 \frac{1}{2} \times \frac{1}{2}$
 Tie Angles $5 \times 3 \frac{1}{2} \times \frac{1}{2}$

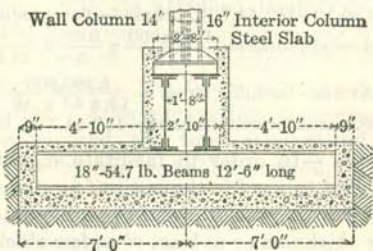

CARNEGIE STEEL COMPANY

EXAMPLE:—Required to design a grillage foundation under an exterior or wall column carrying a load of 840,000 pounds, and an interior column with a load of 1,260,000 pounds, on soil with an allowable bearing capacity of 8,000 pounds per square foot.

$$\text{Required footing area of wall column} = \frac{840,000}{8,000} = 105 \text{ square feet.}$$

Use area 8'-0" x 14'-0" = 112 square feet.

$$\text{Required area of interior column footing} = \frac{1,260,000}{8,000} = 157.5 \text{ square feet.}$$

Use area 12'-0" x 14'-0" = 168 square feet.

With these dimensions and areas, the load on the soil will be uniform at 7,500 pounds per square foot, and the footings the same width, both of which are desirable from the standpoint of uniform settlement.

Rolled Steel Slabs for Column Footings: Assume a width of 30" and a length of 32", then the required thickness will be as follows:—

$$\text{Wall column, } t = \sqrt{\frac{3 \times 840,000 \times (32 - 14)}{64,000 \times 30}} = 4.86 \text{ in.; use } 5''.$$

$$\text{Interior column, } t = \sqrt{\frac{3 \times 1,260,000 \times (32 - 16)}{64,000 \times 30}} = 5.61 \text{ in.; use } 5\frac{3}{4}''.$$

Plate Girders: Maximum bending moment occurs at the inner beams of the respective footings, and is equal to the load on the column multiplied by the distance of its center from the center of moments.

$$M \text{ max. from wall column} = 840,000 \times 2'-6'' = 2,100,000 \text{ foot pounds.}$$

$$M \text{ max. from interior column} = 1,260,000 \times 1'-8'' = 2,100,000 \text{ foot pounds.}$$

$$\text{Required section modulus of two girders} = \frac{2,100,000 \times 12}{16,000} = 1,575.0 \text{ in.}^3$$

Select from girder safe load table, page 210, two girders composed each of 1 web plate 36" x $\frac{1}{2}$ ", 4 angles 6" x 4" x $\frac{3}{8}$ ", and 2 flange plates 14" x $\frac{5}{8}$ ";—
Total section modulus, $S = 2 \times 792.3 = 1,584.6 \text{ in.}^3$

Maximum shear occurs at the inside edge of the steel slab under the interior column, and is equal in total for the two girders to the load carried by the portion of the footing between that point and the inside edge of the footing, or $\frac{1,260,000 \times 68}{126} = 680,000$ or 340,000 pounds per girder.

At 10,000 pounds per square inch, the 36" x $\frac{1}{2}$ " plate girder web is good for 180,000 pounds; therefore, it is necessary to use reinforcing web plates where the shear exceeds that amount.

Beams, Lower Tier, Interior Column:

$$\text{Required total section modulus, } S = \frac{3 \times 1,260,000 \times 9.67}{32,000} = 1,142.3 \text{ in.}^3$$

Use 13-18" 54.7 lb. beams—Total section modulus = 1,149.2 in.³

$$\text{Average shear} = \frac{1,260,000}{12.5} \times \frac{9.67}{2} \times \frac{1}{13 \times 18 \times .46} = 4,520 \text{ lbs. per sq. in.}$$

$$\text{Average buckling stress} = \frac{1,260,000}{13 \times 43 \times .46} = 4,900 \text{ lbs. per sq. in.}$$

For exterior column use 9-18" 54.7 lb. beams.

NOTE.—In order to facilitate manufacture and shipment, it is desirable to use for the entire foundation as few sizes and weights of beams as possible, and the rolled steel slabs should be of the same thickness or at least of as few thicknesses as really convenient.

STEEL SHEET PILING

The introduction of steel sheet piling in substitution for wood has made possible the extension of the cofferdam method of making excavations. Its use has led to greater economies, greater safety in working and to the extension in size and depth of open excavations to limits which otherwise were regarded as impossible of attainment.

Steel sheet piling in the construction of cellular cofferdams, first used in the Black Rock Lock, Buffalo, affords a very successful method for the elimination of the expensive, slow and not always reliable, pneumatic caisson on work of large magnitude. It is also used in the construction of curtain walls, sea walls and loading slips, foundations for cylinder piers, sewers, trenches, etc.

Steel sheet piling by its positive interlock enables the sub-surface cut-off walls of diaphragm dams to be made with a certainty not possible with wooden sheet piling, and with an economy not possible with ordinary puddle core, concrete core or masonry core walls. A diaphragm made of such imperishable materials fulfills all the requirements of the ordinary core wall, with the additional advantage of accommodating itself, by its flexibility, to slight irregularities of settlement in the dam.

In addition to temporary cofferdams, steel sheet piling has found large use in the construction of permanent retaining walls for buildings. Driven before excavation in soils containing quicksand or water-bearing strata, its use prevents the undermining of adjacent building foundations by movement of the strata. It also prevents in many cases the delay, expense and danger of underpinning adjacent buildings. It may be employed in this way alone or reinforced by steel buckstays as shown in the illustration, which represents a method followed in the construction of retaining walls for a building, where sheeting with its attached buckstays was driven its full depth and the basement and sub-basement floors placed as the excavation went forward. The rigidity of the buckstays with the bracing supported by the floors eliminated the necessity and expense of shoring. After excavation, concrete was filled in between the buckstays, and the total expense did not exceed 60 per cent of its cost by the ordinary method.

Type. Carnegie Steel Company manufactures United States Steel Sheet Piling, in three sizes and weights.

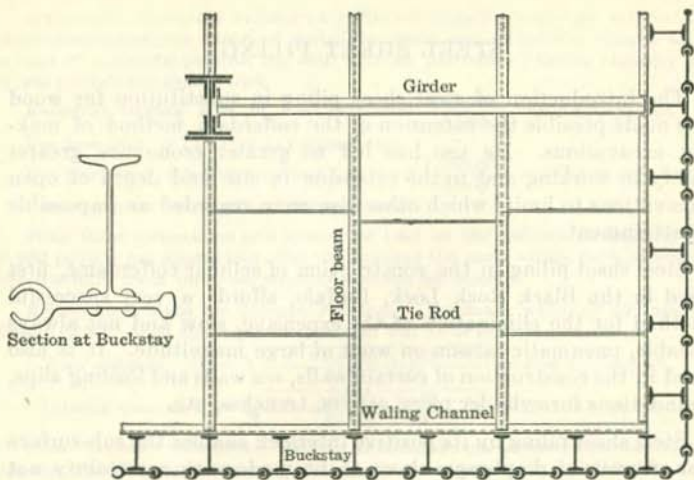

United States Steel Sheet Piling is a simple, plain, rolled section ready for use as it comes from the mill without further fabrication. Each piece is complete in itself and all pieces of the same width are interchangeable. Its profile incorporates the advantages of the ball and socket joint, with sufficient clearance in the interlock for ease in driving and sufficient space for the use of a packing substance between its adjacent edges to insure watertightness. United States Steel Sheet Piling is more easily driven and pulled than any other section hitherto placed on the market. The reason for this is believed to be the absence of a leading groove combined with the line contact obtained in the joints.

The sections have positive interlocks continuous throughout the entire length in both lateral and horizontal directions, affording maximum strength against sidewise deflection, distortion or separation of the pieces due to pressures and deformation in driving.

Strength of Sections. When driven and under pressure, steel sheet piling must have strength similar to that possessed by a beam subjected to earth or water pressure, and the resistance of the piling to transverse bending can be calculated in accordance with laws of flexure from the properties of the sections given in the following table. In the case of United States Steel Sheet Piling, the properties of the individual pieces are the same as the properties of the sections interlocked in place.

SHEET PILING CONSTRUCTION

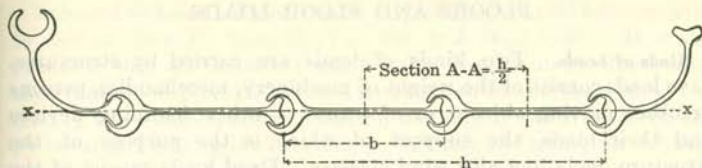

ELEMENTS OF SECTIONS, AXIS X-X

Section Index	Description				Interlocked or Single Section					Regular Corner, Weight, Pounds per Lineal Foot
	Width b, Inches	Single Section		Weight, Lbs. per Sq. Ft.	I In. ⁴	r In.	S In. ³	S* In. ³	$\frac{h}{2}$ In.	
		Lbs. per Lin. Ft.	Area, Sq. In.							
M 105	13 $\frac{1}{4}$	42.5	12.51	38	8.56	0.83	4.35	3.93	13 $\frac{1}{4}$	42.5
M 104	13 $\frac{1}{4}$	38	11.30	35	8.50	0.87	4.32	3.91	13 $\frac{1}{4}$	38
M 103	9 $\frac{1}{4}$	16	4.71	21	1.45	0.56	1.13	1.47	9 $\frac{1}{4}$	16

S* is the average section modulus per horizontal foot of wall interlocked in place.

During driving, the sections are forced to act as columns, and the tables, therefore, show the radius of gyration of the sections for computing their compressive resistance under load or the blow of the pile driving hammer. The radius of gyration of the section, however, need not bear any definite proportion to its length, if blocks of wood are bolted to the leads of the pile driver in case the piling shows a tendency to spring. As the piling actually enters the earth, it is supported laterally and stiffened by the adjacent soil, and the blows of the hammer need but overcome the friction. In an ordinary cofferdam braced in the usual manner, strength in the interlock to resist the tearing apart of the sections by direct tension in a longitudinal direction is not often required, but if it is, as in the case of a cellular cofferdam, United States Steel Sheet Piling is recommended on account of its great longitudinal strength. This interlock strength in a longitudinal direction depends on the type of section, the opening of the jaw, the character of the soil, etc., and can only be determined by tests. The average longitudinal strength per lineal inch of medium steel sections is as follows:

- 13 $\frac{1}{4}$ " United States Steel Sheet Piling..... 9,800 pounds.
- 9 $\frac{1}{4}$ " United States Steel Sheet Piling..... 5,600 "

Steel sheet piling is usually made of medium open-hearth steel manufactured to standard specifications.

Full information is given in a separate pamphlet entitled "Steel Sheet Piling," copies of which can be had on request.

FLOORS AND FLOOR LOADS

Kinds of Loads. Two kinds of loads are carried by structures. Live loads consist of the weight of machinery, merchandise, persons or other moving objects, or of cranes or other handling devices and their loads, the support of which is the purpose of the structure, including also wind stresses. Dead loads consist of the actual weight of the structure itself with the walls, floors, partitions, roofs, and all other permanent construction and fixtures. The dead loads stress the structure at all times and it must, therefore, be proportioned to sustain them at all times without reduction. The live loads may be taken at their full values or reduced in accordance with the probabilities that the structure as a whole or its principal members will not be subject at all times to the full theoretical live loading.

Dead Loads. The permanent load should be calculated from known weights per unit of the material composing floors, partitions, walls, or other permanent construction. The weight assumed for the steel frame itself should be checked after the sections are determined and then the sizes readjusted if necessary.

Live Loads. Live loads vary with the character of the structures. In buildings they consist of uniform loads per square foot of floor area, concentrated loads, such as heavy safes, which may be applied at any point of the floor, and uniform loads per lineal foot of beams or girders. The load which produces the maximum bending moment or reaction is to be used in proportioning sections. The floor system between beams must of course be of sufficient strength to transmit any concentrated load to the beam.

In cities the minimum live loads to be used on the various classes of buildings are fixed by public ordinances, and are given on page 265 for the principal cities of the United States in accordance with the most recent building laws, which are intended to cover general conditions and do not include machinery or other concentrations. If such concentrations, like safes, armatures, generators, or printing presses, occur on floors, special provision should be made for them in the floor framing. Flat roofs of buildings which may be loaded with people, should be treated the same as floors and the same uniform live loads used as given in the table for dwellings, hotels or assembly rooms.

Reduced Live Loads. Floor beams in buildings should be computed to sustain floor by floor the full live and dead loads. It is not probable that all the floors will be fully loaded at all times, and, therefore, good practice permits a reduction of the theoretical live load in the computations of column sections. The New York and Pittsburgh building laws do not permit any reduction on columns supporting the roof and top floor. These building laws permit for buildings more than five stories in height on columns supporting each succeeding floor a reduction of 5 per cent of the total live floor load until 50 per cent is reached, which reduced load is to be used for the columns supporting the remaining floors. The Chicago building law requires columns to sustain the full live load on roofs, 85 per cent of the full live floor load on the top floor with a 5 per cent reduction on each succeeding floor down to 50 per cent.

When the character of the loading will permit, the live load on the main girders to which the primary supporting beams are framed, may be reduced. The amount of the reduction will depend on the probable distribution of the loads.

Foundation Loads. Footings should be so designed that the loads they sustain per unit of area shall be as nearly uniform as possible, and the dead loads carried by the footings should include the actual weight of the superstructure and foundations down to the bottom of the footing. The live load should be assumed to be the same as the live load in the lowest tier of columns or in the footings under walls. The area of the footing is determined by dividing the total load by the unit resistance of the soil. From the area thus calculated all the other footings of the building are proportioned according to the ratios of their respective dead loads only. In no case should the load per square foot under any portion of any footing due to the combined dead, live and wind loads, exceed the safe sustaining power of the soil upon which the footing rests.

Fireproof Floor Systems. A modern office or mercantile building is essentially a steel framed structure which supports the dead load of the building and its contents, and is itself protected on all sides by refractory materials. The floors are made fireproof by the use of terra cotta tiles or arches or of a composite flooring made of concrete or reinforced concrete. While brick arches may still be used in special locations where great floor strength is needed, and concrete arches are sometimes thrown between the beams, modern practice is limited substantially to the hollow tile arch sprung between the beams and the reinforced concrete slab laid on their tops, the ceiling construction being modified to suit. Each system has advantages of its own.

Terra Cotta Arches. Hollow tile arches fill the total depth of the floor beams, and, therefore, tend to stiffen and brace the building; their weight per square foot is light as compared with other forms of fireproof floor construction of equal strength. Hollow terra cotta floor arches are made either flat or segmental. The segmental arch will develop much greater strength than the flat arch of the same width and depth, and may be designed to carry a given load with tile of less depth than flat arches. They are, therefore, more economical, though not always acceptable from the standpoint of architectural appearance. In office buildings the ceilings under such arches are usually suspended. A correctly designed and constructed flat arch will always develop the full strength of the steel beam which supports it.

When arch blocks are the same depth as the beams, they are usually laid to project $1\frac{1}{2}$ inches below the bottom of the beams, and the space above the arch is filled in either with cinder concrete, in which can be laid pipes, conduits, and wooden nailing strips supporting wood flooring, or with thin terra cotta blocks made for this purpose, or with a layer of plastic composition of cement, which forms the wearing surface for the floor.

Thrust of Floor Arches. All forms of terra cotta arches produce side thrust on the floor beams. In the flat arch the blocks have tapered faces and the central block or key wedges the others together; in the segmental arch the thrust is that due to all arch action. These thrusts it is found necessary to counterbalance by means of tie rods which connect the floor beams and relieve them from the tendency to deflect sidewise. In the central bays, owing to the action of adjacent arches, the tie rods are sometimes omitted, but it is necessary to investigate outer beams and channels around openings for additional thrust stresses so that the combined fiber stresses produced by vertical loading and horizontal thrusts may not be excessive. With flat arches $\frac{3}{4}$ inch tie rods spaced apart not over fifteen times the width of the beam flanges will usually be sufficient. The total thrust of arch, the net area of tie rods required, the maximum distance between tie rods and the section of outer beams for any condition, may be found as follows:

FLOOR CONSTRUCTION

Let

- w = unit load on arch, in pounds per square foot.
- D = distance of arch span, in feet.
- L = length of floor beam supporting the arch, in feet.
- R = effective rise of arch, in inches.
- p = thrust of arch per lineal foot, in pounds.
- P = total thrust of arch per panel, in pounds.
- A = total net area of tie rods per panel, in square inches.
- a = net area of one tie rod, in square inches.
- T = spacing of tie rods, center to center, in feet.
- f = allowable combined fiber stress, in pounds per sq. inch.
- S₁₋₁ = Section Modulus of beam, axis 1-1, in inches³.
- S₂₋₂ = Section Modulus of beam, axis 2-2, in inches³.
- M₁₋₁ = Bending Moment for vertical loading, in inch pounds.
- M₂₋₂ = Bending Moment for arch thrust, in inch pounds; then—

$$P = \frac{3wD^2}{2R} \quad P = pL$$

$$A = \frac{3wD^2L}{2fR} = \frac{P}{f}$$

$$T = \frac{2afR}{3wD^2} = \frac{af}{p}$$

$$M_{1-1} = \frac{12L (\frac{1}{2}wDL)}{8} = \frac{3wD L^2}{4}$$

$$M_{2-2} = \frac{12T(pT)}{12} = pT^2$$

$$f = \frac{M_{1-1}}{S_{1-1}} + \frac{M_{2-2}}{S_{2-2}}$$

In formula given for M₂₋₂, the beam is considered continuous, supported at intervals by the tie rods. In segmental arches the effective rise is equal to the vertical distance between highest point of concave surface and springing line or chord; the effective rise of a flat arch may be taken at 2.4 inches less than the arch depth.

The allowable combined fiber stress in tie rods should not exceed 16,000 pounds, and tie rods should be placed in line of thrust, usually 3 inches above the bottom of the beam.

The net areas of usual sizes of tie rods are as follows:—

Diameter of Rod, Inches	¾	¾	¾	1
Net area, a, square inches	0.202	0.302	0.420	0.550

CARNEGIE STEEL COMPANY

EXAMPLE.—A floor panel 18 feet by 6 feet, of 12 inch flat terra cotta blocks, is to support a uniform live and dead load of 150 pounds per square foot. Required the total thrust, total area of rods per panel, maximum spacing of rods, and the proper size beam to carry one-half of the panel without other lateral support than the tie rods.

Entire panel load is 18x6x150=16,200 pounds. Assuming a beam, 12 inch 31.8 pounds, and 3/4-inch tie rods, then—

Thrust of arch per lineal foot, $P = \frac{3 \times 150 \times 6^2}{2(12-2.4)} = 844$ pounds.

Total thrust of arch, $P = 844 \times 18 = 15,200$ pounds.

Total area of tie rods, $A = \frac{15,200}{16,000} = 0.95$ sq. inches.

Maximum spacing of tie rods, $T = \frac{0.302 \times 16,000}{844} = 5.75$ feet.

Bending Moment, vertical loading, $M_{1-1} = \frac{3 \times 150 \times 6 \times 18^2}{4} = 218,700$ in. lbs.

Bending Moment, horizontal thrust, $M_{2-2} = 844 \times 5.75^2 = 27,900$ in. lbs.

Combined fiber stress in tie rods, $f = \frac{218,700}{36.0} + \frac{27,900}{3.8} = 13,420$ lbs./in.²

If tie rods are spaced 6'-0" centers, then —

Bending Moment, horizontal thrust, $M_{2-2} = 844 \times 6^2 = 30,400$ in. lbs.

Combined fiber stress in tie rods $f = \frac{218,700}{36.0} + \frac{30,400}{3.8} = 14,080$ lbs./in.²

**MAXIMUM SPACING OF 3/4 INCH TIE RODS,
LOADS OF 100 POUNDS PER SQUARE FOOT**

Span, Feet	Effective Rise of Arch, R, in Inches											
	4	5	6	7	8	9	10	11	12	13	14	15
3	14.3											
4	8.1	10.1	12.1	14.1								
5	5.2	6.4	7.7	9.0	10.3	11.6	12.9	14.2				
6	3.6	4.5	5.4	6.3	7.2	8.1	8.9	9.8	10.7	11.6	12.5	13.4
7		3.3	3.9	4.6	5.3	5.9	6.6	7.2	7.9	8.5	9.2	9.9
8			3.0	3.5	4.0	4.5	5.0	5.5	6.0	6.5	7.0	7.6
9					3.2	3.6	4.0	4.4	4.8	5.2	5.6	6.0
10							3.2	3.5	3.9	4.2	4.5	4.8

For any other loading, multiply tabular values by 100 and divide by total new load per square foot.

The tables which follow give the weights per square foot for terra cotta arches, both flat and segmental, of various depths, their area in square inches, and the safe loads they will sustain on various spans. These tables should be used as a general guide only, as conditions may make it possible to design more economical arches for a given load than indicated by the tables. Where a paneled ceiling is not objectionable, for example, a shallow arch may be used on raised skewbacks with a considerable economy in material.

FLOOR CONSTRUCTION

FLOORS AND ROOFS

MINIMUM LIVE LOADS, POUNDS PER SQUARE FOOT

By Building Laws of Various Cities

Description of Building	New York, 1917	Chicago, 1919	Philadelphia, 1910	St. Louis, 1917	Boston, 1919	Cleveland, 1920	Baltimore, 1908	Pittsburgh, 1914	Cincinnati, 1917
Floors for Rooms									
Apartments and Dwellings...	40	40	70	50	50	70a	60	50	40
Asylums, Hospitals, etc...	100	50	70	50	50c			70	40
Detention Buildings, etc...	100	50			50c	80			60
Factories:									
Light manufacture.....	120d	100d	120d	100d	125d		125d	125d	100d
Heavier manufacture...			150d	150d	250d		175d		150d
Hotels, Lodging Houses...	40	50	70	50	50c	70	60	70	40b
Office Buildings, etc.....	60	50	100	60b	75b	70b	75b	70	50b
Public Buildings:									
Municipal Buildings....	100				75c	100			100
Churches.....	100	100	120	75	100	80	75	125	100
Libraries, Museums....	100				100	125		200	
Theaters.....	100	100	120	100	100	80	75	125	100
Schools, Colleges, etc....	75	75		75	50	70	75	70	60
Stores, light goods.....	120	100	120	100	125	100b	125	125	100
" heavier goods.....			150	150	250		175		150
Warehouses.....			150	150	250		250	200	150
Floors for Assembly Halls, etc.									
Auditoriums, fixed seats..	100	100	120	100	100	80	75	125	100
" movable seats.....	100	100	120	100	100	125	125	125	100
Armories, Dance Halls, etc.	100	100			100	150		150	150
Miscellaneous									
Garages, Stables.....	120	100e		100	150e	150e	100		75
Corridors, Hallways.....	100	100		100	75f	70g			80g
Stairways, Fire Escapes..	100	100		100	75f	100h			80g
Sidewalks.....	300				250	200	200		300
Roofs:									
Flat, slope up to 20° (¼)	40	25	30i	30	40	35i	40	50k	25
Steep, slope over 20° (¼)	30	25	30i		25j	30i	20	50k	25
Wind Pressure.....	30l	20	30m	30	10-20n	20o	30	25	20p

a Dwellings, Cleveland, 60.

b First floors: St. Louis, 100; Boston, 125; Cleveland, 125; Baltimore, 150; Cincinnati, 100.

c Public floors of Hospitals, Hotels, Public Buildings, etc.: Boston, 100.

d Floor loads do not include the weight or the impact load of machinery.

e Garages, private: Chicago, 40; Boston, 75; Garages; public, upper floors: Cleveland, 100; Stables: Cleveland, 80.

f Corridors, stairways, etc., for Assembly Halls, Armories, etc.: Boston, 100.

g Except in Dwellings where floor loads are less.

h Stairways, etc., for Apartment Houses, 80; Dwellings, 60.

i Loads per square foot of superficial roof area; other roof loads are for the projected area.

j Loads include Wind Pressure: 10 pounds up to 2½ slope, 15 up to ¼ slope, 20 over ¼ slope.

k Dead and live load; snow load 25 pounds, reduced 1 pound each degree between 20° and 45°.

l For buildings over 150 feet high, or where height is over 4 times least horizontal dimension.

m Wind pressure for high buildings in built-up districts: 25 pounds at tenth story, 2½ pounds

less for each story below and 2½ pounds more for each story above, up to 35 pounds.

n For buildings 40 feet high, 10 pounds; up to 80 feet, 15 pounds; over 80 feet, 20 pounds.

o Wind pressure on curtain walls, 30 pounds.

p For buildings over 100 feet high, or where height is over 3 times the average width of base.

CARNEGIE STEEL COMPANY

FLAT TERRA COTTA ARCHES
 MANUFACTURERS' STANDARD
 SAFE LOADS IN POUNDS PER SQUARE FOOT
 Factor of Safety = 7

Span of Arch, Ft.-In.	Depth of Arch Blocks, Inches						
	6	7	8	9	10	12	15
	Area of Arch Blocks, Square Inches						
	31	34	37	40	43	49	58
3-0	458	588	735	901	1084	1487	2210
3-3	386	496	622	763	916	1262	1877
3-6	330	424	531	653	785	1083	1612
3-9	284	365	459	565	679	938	1398
4-0	247	318	399	493	593	820	1223
4-3	216	278	350	433	521	722	1079
4-6	190	245	309	382	461	640	951
4-9	168	217	274	340	410	571	855
5-0	149	193	244	304	367	511	767
5-3		172	218	272	330	460	691
5-6		154	196	245	297	416	626
5-9		139	176	222	269	378	569
6-0			159	201	244	344	518
6-3			144	183	222	314	474
6-6			131	166	203	287	435
6-9				152	186	264	400
7-0				139	170	243	369
7-6					144	206	315
8-0						177	272
8-6						153	236
9-0						132	205
9-6							180
10-0							158

This table and the two following are employed in computing the safe loads of floor arches of hollow terra cotta blocks. The area given is that of a cross section at right angles to the webs, and, generally, end-construction blocks of various shapes but of the same depth and cross-sectional area have equal strength.

The weight of the terra cotta arch has been deducted from the safe load given in the tables, so that only the dead load of the concrete fill, plastering, etc., must be deducted to obtain the net safe live load for any arch and span; blocks of different areas and for other factors of safety are calculated as follows:

EXAMPLE.—Required the load per square foot for a 5'-6" span and 8 inch arch blocks with three horizontal and four vertical webs, $\frac{3}{4}$ inch thick, set in end construction, cross-section through webs of blocks parallel to webs of beams.

Sectional area of the blocks is $8'' \times \frac{3}{4}'' \times 4 + (12'' - 4 \times \frac{3}{4}'') \times \frac{3}{4}'' \times 3 = 44.25$ sq. in. at 0.06 pounds per cu. in., the weight is $44.25 \times 12 \times 0.06 = 32$ pounds.

The net safe load of the 8 inch block given in the table is 196 pounds. Adding the weight of the block, $37 \times 12 \times 0.06 = 26$ pounds, the total safe load is 222 pounds. The net safe load for blocks with an area of 44.25 sq. in. and a safety factor of 5 is $(44.25 \div 37 \times 222 \times 7/5) - 32 = 340$ pounds per sq. ft.

FLOOR CONSTRUCTION

SEGMENTAL TERRA COTTA ARCHES MANUFACTURERS' STANDARD SAFE LOADS IN POUNDS PER SQUARE FOOT

Factor of Safety = 7.

Span of Arch, Ft.-In.	Depth of Arch Blocks, In.			Rise of Arch, In.	Span of Arch, Ft.-In.	Depth of Arch Blocks, In.			Rise of Arch, In.	Span of Arch, Ft.-In.	Depth of Arch Blocks, In.			Rise of Arch, In.	Span of Arch, Ft.-In.	Depth of Arch Blocks, In.			Rise of Arch, In.			
	Area of Arch Blocks, Sq. In.					Area of Arch Blocks, Sq. In.					Area of Arch Blocks, Sq. In.					Area of Arch Blocks, Sq. In.				Area of Arch Blocks, Sq. In.		
	6	8	10			6	8	10			6	8	10			6	8	10		6	8	10
4-0	3/4	902	1078	1178	3/4	568	606	662	3/4	10-0	36	43	47	3/4	36	43	47	3/4	225	293		
	1	1184	1414	1545	1	669	709	807	1	10-0	36	43	47	1	36	43	47	1	285	361		
4-6	3/4	1485	1774	1939	3/4	834	996	1089	3/4	7-6	36	43	47	3/4	36	43	47	3/4	377	450		
	1	1740	2079	2272	1	981	1171	1290	1	7-6	36	43	47	1	36	43	47	1	447	534		
	1 1/2	1986	2373	2593	1 1/2	1127	1346	1471	1 1/2	7-6	36	43	47	1 1/2	36	43	47	1 1/2	515	616		
	2	2233	2667	2915	2	1264	1510	1650	2	7-6	36	43	47	2	36	43	47	2	577	690		
5-0	3/4	792	946	1034	3/4	471	563	615	3/4	10-6	36	43	47	3/4	36	43	47	3/4	209	249		
	1	1044	1247	1363	1	621	741	810	1	10-6	36	43	47	1	36	43	47	1	281	336		
	1 1/2	1313	1568	1713	1 1/2	774	925	1011	1 1/2	10-6	36	43	47	1 1/2	36	43	47	1 1/2	353	421		
	2	1539	1838	2009	2	920	1099	1201	2	10-6	36	43	47	2	36	43	47	2	419	500		
5-6	3/4	1775	2121	2318	3/4	1049	1253	1369	3/4	8-0	36	43	47	3/4	36	43	47	3/4	481	575		
	1	1975	2359	2578	1	1176	1405	1536	1	8-0	36	43	47	1	36	43	47	1	541	645		
	1 1/2	2097	2517	2758	1 1/2	1259	1505	1656	1 1/2	8-0	36	43	47	1 1/2	36	43	47	1 1/2	594	705		
	2	2288	2753	2999	2	1359	1625	1794	2	8-0	36	43	47	2	36	43	47	2	650	768		
6-0	3/4	641	766	837	3/4	411	491	536	3/4	12-0	36	43	47	3/4	36	43	47	3/4	182	218		
	1	864	1032	1128	1	551	658	719	1	12-0	36	43	47	1	36	43	47	1	248	296		
	1 1/2	1092	1299	1387	1 1/2	724	894	944	1 1/2	12-0	36	43	47	1 1/2	36	43	47	1 1/2	310	370		
	2	1266	1512	1652	2	859	1026	1122	2	12-0	36	43	47	2	36	43	47	2	370	442		
6-6	3/4	1439	1719	1879	3/4	929	1106	1208	3/4	14-0	36	43	47	3/4	36	43	47	3/4	432	507		
	1	1619	1933	2113	1	1037	1239	1354	1	14-0	36	43	47	1	36	43	47	1	477	570		
	1 1/2	1788	2141	2328	1 1/2	1128	1351	1483	1 1/2	14-0	36	43	47	1 1/2	36	43	47	1 1/2	507	602		
	2	1975	2373	2578	2	1239	1483	1625	2	14-0	36	43	47	2	36	43	47	2	541	645		
6-6	3/4	551	658	719	3/4	364	435	475	3/4	14-0	36	43	47	3/4	36	43	47	3/4	163	194		
	1	724	864	944	1	489	584	638	1	14-0	36	43	47	1	36	43	47	1	227	277		
	1 1/2	902	1077	1177	1 1/2	608	726	785	1 1/2	14-0	36	43	47	1 1/2	36	43	47	1 1/2	277	331		
	2	1038	1247	1363	2	726	864	944	2	14-0	36	43	47	2	36	43	47	2	331	395		
6-6	3/4	1338	1622	1772	3/4	823	983	1074	3/4	14-0	36	43	47	3/4	36	43	47	3/4	431	497		
	1	1588	1922	2099	1	923	1102	1204	1	14-0	36	43	47	1	36	43	47	1	497	588		
	1 1/2	1772	2147	2347	1 1/2	1024	1224	1336	1 1/2	14-0	36	43	47	1 1/2	36	43	47	1 1/2	545	645		
	2	1972	2387	2607	2	1102	1322	1444	2	14-0	36	43	47	2	36	43	47	2	602	712		

CARNEGIE STEEL COMPANY

TERRA COTTA ARCHES

FOR

Floor Load of 150 Pounds per Square Foot

FLAT ARCH	Typical Construction Bottom of arch below bottom of beam	Depth of Beam, Inches	Depth of Arch Blocks, Inches	Depth of Floor, Inches	Span of Arch, Feet	Approx. Weight, Lbs. per Sq. Ft.					
						Steel	Terra Cotta	Concrete	Flooring	Ceiling	Total
						6	6	11	5 1/4	6	22
7	6	12	5 1/4	7	22	38	4	5	76		
8	6	13	5 1/4	8	22	45	4	5	84		
7	7	12	6	8	24	30	4	5	71		
8	7	13	6	8	24	38	4	5	79		
9	7	14	6	8	24	45	4	5	86		
8	8	13	6 1/2	8	27	30	4	5	74		
9	8	14	6 1/2	8	27	38	4	5	82		
10	8	15	6 1/2	8	27	45	4	5	89		
9	9	14	7 1/2	8	29	30	4	5	76		
10	9	15	7 1/2	9	29	38	4	5	85		
12	9	17	7 1/2	9	29	53	4	5	100		
10	10	15	8	9	31	30	4	5	79		
12	10	17	8	9	31	45	4	5	94		
12	12	17	9 1/2	10	35	30	4	5	84		
15	12	20	9 1/2	10	35	53	4	5	107		
15	15	20	11	12	42	30	4	5	93		

For flat arches on raised skeys, where the top of the arch is level with the top of the floor beam, deduct about 7 pounds per inch of difference between the height of the floor beam and the arch.

SEGMENTAL ARCH	Typical Construction Top of arch level with top of beam	Depth of Beam, Inches	Depth of Arch Blocks, Inches	Rise of Arch, Inches	Span of Arch, Feet	Approx. Weight, Lbs. per Sq. Ft.					
						Steel	Terra Cotta	Concrete	Flooring	Ceiling	Total
						6	4	3/4	4 1/2	7	20
7	4	1	5	7	20	28	4	5	64		
8	4	1 1/4	5 1/2	7	20	29	4	5	65		
9	4	1 1/2	6	8	20	30	4	5	67		
8	6	3/4	5	8	26	27	4	5	70		
9	6	1	5 1/2	8	26	28	4	5	71		
10	6	1 1/4	6	9	26	29	4	5	73		
12	6	1 1/2	6 1/2	9	26	30	4	5	74		
10	8	3/4	5 1/2	9	31	27	4	5	76		
12	8	1	6	9	31	28	4	5	77		
12	8	1 1/4	6 1/2	10	31	29	4	5	79		
15	8	1 1/2	7	10	31	30	4	5	80		
12	10	3/4	5 3/4	10	34	27	4	5	80		
12	10	1	6 1/2	11	34	28	4	5	82		
15	10	1 1/4	7	11	34	29	4	5	83		
15	10	1 1/2	7 1/2	12	34	30	4	5	85		

TERRA COTTA PARTITION, CEILING, ROOFING AND FURRING BLOCKS

Thick-ness, Inches	Approx. Weight, Pounds per Sq. Foot				Thick-ness, Inches	Approx. Weight, Pounds per Sq. Foot			
	Partition	Ceiling	Roofing	Furring		Partition	Ceiling	Roofing	Furring
1 1/2				9	4	16-18		22	
2	12-14	12		10	5	18-20			
3	15-17	20	20		6	24-26			

REINFORCED CONCRETE BEAMS AND FLOOR SLABS

For a complete mathematical analysis of the stresses occurring in reinforced concrete structures, reference may be made to standard text books on the theory and practice of reinforced concrete.

Girders and Floor Beams. The arrangement of girders and floor beams follows the same principles as in structural steel construction. On short spans floor cross beams may be omitted or used only at columns to secure lateral stiffness. Beams are usually designed as tee beams, and thereby a part of the floor slab is utilized as a part of the beam. The width of the slab thus considered to act as part of the beam should not exceed one-fourth of the span length, and the overhanging width on either side of the web should not be over six times the thickness of the slab.

Floor Slabs. Reinforcement may be of small rods, wires or metal fabric, the latter especially on short spans. Cross reinforcement of small rods or wires about two feet apart laid parallel to the beam supporting the slab should be used to prevent cracks, shrinkage, etc. If the length of the slab exceeds $1\frac{1}{2}$ times its width, the entire load should be carried by transverse reinforcement. For rectangular slabs, the length of which does not exceed $1\frac{1}{2}$ times the width and which are supported on four sides and reinforced in both directions, the proportion of the load is determined by the formula: $R=l/b-0.5$, where R is the ratio of the load, l the length and b the width of the slab. An effective bond should be provided at the junction of beam and slab, and if the principal reinforcement of the slab is parallel to the beam, transverse reinforcement should be used extending over the beam and well into the slab.

Spacing of Reinforcing Bars. The lateral spacing of parallel bars should not be less than 3 diameters, nor should the clear vertical space between layers of bars be less than 1 inch; distance from edge or side of beam or slab should not be less than 2 diameters.

Shear or Web Reinforcement. In the calculation of web reinforcement, concrete may be assumed to carry $\frac{1}{3}$ of the total shear; the remaining $\frac{2}{3}$ to be taken by additional reinforcement arranged in intervals equal to the depth of the beam. The usual method of reinforcing beams against failure by diagonal tension or shear is to use bent rods or stirrups in either vertical or inclined position. The longitudinal spacing of such rods or stirrups should not exceed $\frac{3}{4}$ of depth of beam if inclined, and $\frac{1}{2}$ of depth if vertical.

Formulas. The following formulas are those given by the Committee of the American Society of Civil Engineers on Concrete and Reinforced Concrete (Transactions, Vol. LXXXI—No. 1398, December, 1917.)

REINFORCED CONCRETE BEAMS—NOTATION

Rectangular Beams, Reinforcement for Tension only.

- f_s = Tensile unit stress in steel, in pounds per sq. inch.
 f_c = Compressive unit stress in concrete, in pounds per sq. inch.
 E_s = Modulus of elasticity of steel, in pounds per sq. inch.
 E_c = Modulus of elasticity of concrete, in pounds per sq. inch.
 n = Elasticity ratio, $E_s \div E_c$.
 M = Bending moment or Moment of Resistance, in inch pounds.
 M_s = Moment of resistance of steel, in inch pounds.
 M_c = Moment of resistance of concrete, in inch pounds.
 A_s = Area of steel in tension, in square inches.
 b = Width of beam, in inches.
 d = Depth of beam to center of steel in tension, in inches.
 k = Ratio of depth of neutral axis to effective depth, d .
 j = Ratio of lever arm of resisting couple to depth, d .
 z = Distance, from top to resultant of compression, in inches.
 jd = Arm of resisting couple, in inches = $d - z$.
 p = Ratio of areas, steel in tension to rectangle, bd , = $A_s \div bd$.
 kd = Distance from top of beam to neutral axis, in inches.

Tee Beams, Reinforced for Tension only.

- b = Width of flange, in inches.
 b' = Width of stem, in inches.
 t = Thickness of flange, in inches.

Rectangular Beams, Reinforced for Tension and Compression.

- A' = Area of steel in compression, in square inches.
 p' = Ratio of areas, steel in compression to rectangle, bd , = $A' \div bd$.
 f'_s = Compressive unit stress in steel, in pounds per sq. inch.
 C = Total compressive stress in concrete, in pounds per sq. inch.
 C' = Total compressive stress in steel, in pounds per sq. inch.
 d' = Depth to center of steel in compression, in inches.
 z = Depth to resultant of $C + C'$, in inches.

Shear and Bond.

- V = Total shear, in pounds.
 V' = Total Shear producing stress in reinforcement, in pounds, = $\frac{2}{3}V$.
 v = Shearing unit stress, in pounds per sq. inch.
 u = Bond stress per unit surface of bar, in pounds per sq. inch.
 Σ_0 = Sum of perimeters of tension bars, in inches.
 T = Total stress in single reinforcing member, in pounds.
 s = Horizontal spacing of reinforcing members, in inches.

REINFORCED CONCRETE BEAMS—FORMULAS

Rectangular Beams, Reinforced for Tension only.

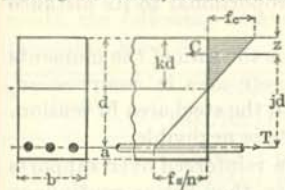

$$kd = d(\sqrt{2pn + (pn)^2} - pn)$$

$$z = jkd \quad jd = d(1 - \frac{1}{2}k)$$

$$M = f_s A_s jd = f_s p j b d^2$$

$$M = \frac{1}{2} f_c k j b d^2$$

$$f_s = \frac{M}{A_s jd} = \frac{M}{p j b d^2}$$

$$f_c = \frac{2M}{k b d^2} = \frac{2p f_s}{k}$$

Balanced Reinforcement:

$$\text{Steel ratio, } p = 2 \frac{f_s}{f_c} \left[\frac{f_s}{n f_c} + 1 \right]$$

$$b d^2 = \frac{M}{f_s p j} = \frac{M}{\frac{1}{2} f_c k j}$$

Tee Beams, Reinforced for Tension only.

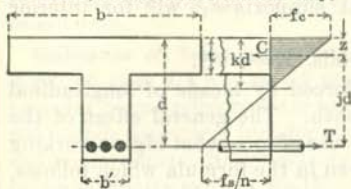

$$kd = \frac{2nd A_s + b t^2}{2n A_s + 2b t}$$

Neutral axis in flange—
(use formulas for rectangular beams.)

Neutral axis in stem—

$$z = \frac{t(3kd - 2t)}{3(2kd - t)} \quad jd = (d - z)$$

$$f_s = \frac{M}{A_s jd} = \frac{f_c n (1 - k)}{k}$$

$$f_c = \frac{M k d}{b t (k d - \frac{1}{2} t) jd} = \frac{f_s k}{n (1 - k)}$$

$$M = f_s A_s jd$$

$$M = \frac{f_c b t (k d - \frac{1}{2} t) jd}{k d}$$

Rectangular Beams, Reinforced for Tension and Compression.

$$kd = d \left[\sqrt{2n(p + p') \frac{d'}{d} + n^2 (p + p')^2} - n(p + p') \right]$$

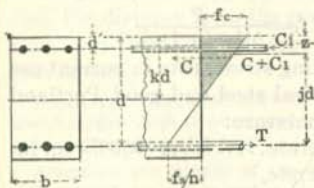

$$z = \frac{\frac{1}{2} k^2 d + 2p' n d' (k - \frac{d'}{d})}{k^2 + 2p' n (k - \frac{d'}{d})} \quad jd = (d - z)$$

$$f_s = \frac{M}{p j b d^2} = \frac{n f_c (1 - k)}{k}$$

$$f'_s = \frac{n f_c (k - \frac{d'}{d})}{k}$$

$$f_c = \frac{6M}{b d^2 \left[3k - k^2 + \frac{6p' n}{k} (k - \frac{d'}{d}) (1 - \frac{d'}{d}) \right]}$$

Shear and Bond.

Rectangular Beams

$$v = \frac{V}{b jd} \quad T = \frac{V' s}{j d} \quad u = \frac{V}{j d \Sigma o}$$

T Beams

$$v = \frac{V}{b' j d} \quad T = \frac{V' s}{j d} \quad u = \frac{V}{j d \Sigma o}$$

If reinforcing bars are bent up at angles between 20° and 45°, and web members inclined at 45°,

$$T = \frac{2V' s}{4 j d}$$

The formulas are based upon the following assumptions:

1. The applied forces are perpendicular to the neutral plane.
2. The deformation of any fiber is proportional to its distance from the neutral axis.
3. The resisting moment of the beam is the sum of the moments above the neutral axis, due to the concrete area in compression, and of those below the neutral axis, due to the steel area in tension.
4. The tensile strength of the concrete is negligible.

Bending Moments. If slabs and girders are reinforced over supports to take care of negative bending moments, they act as continuous beams, and the bending moment at the center of the span will be reduced. It is considered good practice to use the following values:

Floor slabs, M at center and at supports $= \frac{1}{12} wl^2$.

Beams, M at center and at supports $= \frac{1}{12} wl^2$ for interior spans, and $\frac{1}{10} wl^2$ for end spans.

If beams are freely supported at ends, $M = \frac{1}{8} wl^2$.

Columns. Columns may be reinforced by means of longitudinal bars, by bands or hoops, or by both. The general effect of the banding or hooping is to permit the use of somewhat higher working stresses; the values of A_s and p given in the formula which follows, refer to longitudinal steel reinforcement only:

P = total load on columns, in pounds.

A = total area of column section, in square inches.

A_c = area of concrete, in square inches.

A_s = area of steel, in square inches.

p = ratio of steel area to total section, $A_s \div A$.

f_c = unit compressive stress in concrete, in pounds per sq. inch:

$$P = f_c(A_c + nA_s) = f_cA[1 + (n-1)p]. \quad f_c = \frac{P}{A[1 + (n-1)p]}$$

Working Stresses. The following working stresses are in current use for reinforcing bars of medium structural steel and good Portland cement and gravel concrete of a 1:2:4 mixture:

f_c = unit compressive stress of concrete..... 650 lb. sq. in.

f_v = unit shearing stress of concrete,

 straight horizontal reinforcement... 40 " " "

 special shear reinforcement..... 90 to 120 " " "

f_u = unit bond stress of concrete, smooth

 rods and deformed bars..... 80 to 100 " " "

f_s = unit tensile stress of steel..... 16,000 " " "

 rod reinforcement..... 16,000 " " "

 wire reinforcement..... 20,000 " " "

f_k = unit compressive stress of steel..... 16,000 " " "

$n = E_s \div E_c = 15$.

FLOOR CONSTRUCTION

Substituting in the formulas given for rectangular beams, reinforced for tension only, the values for $f_c=650$, $f_s=16,000$ and $20,000$, and $n=15$, the following constants are obtained for equal moments of resistance $M_c=M_s$.

Notation	$f_c=650$		Notation	$f_c=650$	
	$f_s=16,000$	$f_s=20,000$		$f_s=16,000$	$f_s=20,000$
p	0.00769	0.00533	pj	0.00672	0.00474
k	0.37864	0.32773	kj	0.33085	0.29193
j	0.87379	0.89076	$f_s p j = \frac{1}{2} f_c k j$	107.526	94.877

For approximate calculations, the arm of the resisting couple, jd , may be taken at $0.9d$, and ordinarily accepted working stresses of $16,000$ for steel and 650 for concrete will not be exceeded if the steel ratio, p , does not exceed 0.008 .

Explanation of Tables. Reinforced Concrete Slabs: The tables given on page 274 are based upon the preceding formulas for rectangular beams reinforced for tension only, and upon fiber stresses of 650 pounds per square inch for concrete, $16,000$ pounds for steel bar or rod reinforcement, $20,000$ pounds for steel wire reinforcement, and for an elasticity ratio of $n=15$.

The bending moments are given in foot pounds per foot of width; below and to the left of the zigzag lines the values are determined by the maximum allowable fiber stress on steel; above and to the right they are determined by the maximum allowable stresses in concrete.

The first column gives the total thickness of the slab, the second, the distance from the center of the steel to the bottom of the slab, and the third the approximate weight of concrete slabs one foot square.

EXAMPLE.—Required the reinforcement for a slab continuous at four sides and 5 inches thick to carry a superimposed load of 150 pounds per square foot over a clear span of 8 feet.

Assuming the weight of the concrete slab in pounds at twelve times the thickness of the slab in inches, then the weight of the slab per foot is $12 \times 5 = 60$ pounds, and the total weight, W , for a span of 8 feet is $(60 + 150) \times 8 = 1680$ pounds.

$$M = WL \div 12 = 1680 \times 8 \div 12 = 1120 \text{ foot-pounds.}$$

If medium structural steel bars or rods are used, the required area, by the upper table, page 274, is, by interpolation, 0.235 square inches, and the sizes may be taken from page 66.

If triangle mesh is used, the steel area required by lower table, page 274, computed for a 5 inch slab, is, by interpolation, 0.188 square inches, requiring by table, page 275, triangle mesh style number 208.

CARNEGIE STEEL COMPANY

REINFORCED CONCRETE SLABS

BENDING MOMENTS IN FOOT POUNDS PER FOOT OF WIDTH

Allowable Fiber Stress: Steel, 16,000 and Concrete .650 Pounds per Sq. Inch

Slab			Area of Steel Reinforcement in Square Inches per Foot of Width																						
Thickness, Inches	Distance, a, Inches	Weight, Lb./Sq. Ft.																							
			.10	.20	.30	.40	.50	.60	.70	.80	.90	1.00	1.10	1.25	1.50										
2½	¾	30	209	353																					
3	¾	36	272	525	599																				
3½	¾	42	335	650	858																				
4	¾	48	398	775	1135	1245																			
4½	¾	54	461	900	1235	1584																			
5	1	60	497	961	1412	1766	1894																		
5½	1	66	558	1087	1600	2101	2312																		
6	1	72	621	1213	1787	2349	2760	2922																	
6½	1	78	686	1340	1975	2596	3205	3431																	
7	1	84	751	1466	2162	2844	3515	3974	4173																
7½	1¼	90	783	1531	2257	2969	3669	4254	4465																
8	1¼	96		1658	2446	3218	3977	4728	5097	5309	5494	5674													
8½	1¼	102		1785	2634	3467	4288	5099	5734	5982	6206	6410													
9	1½	108		1849	2730	3594	4444	5283	6069	6338	6574	6790													
9½	1½	114		1977	2919	3845	4757	5656	6543	7063	7330	7575													
10	1½	120		2104	3109	4096	5068	6027	6974	7826	8120	8302													
10½	1¾	126			3205	4222	5224	6213	7192	8163	8525	8817	9079	9432	9939										
11	1¾	132			3395	4475	5537	6588	7625	8652	9359	9681	9972	10369	10936										
11½	1¾	138			3586	4726	5850	6960	8058	9145	10224	10575	10898	11337	11969										
12	2	144			3681	4852	6007	7148	8276	9393	10500	11037	11376	11858	12494										

Allowable Fiber Stress: Steel, 20,000 and Concrete, 650 Pounds per Sq. Inch

Slab			Area of Steel Reinforcement in Square Inches per Foot of Width																							
Thickness, Inches	Distance, a, Inches	Weight, Lb./Sq. Ft.																								
			.04	.06	.08	.10	.12	.14	.16	.18	.20	.25	.30	.35	.40	.45	.50									
2½	¾	30	108	160	211	261	295	311	325	342	353	377														
3	¾	36	140	207	273	338	404	468	499	520	538	574	599													
3½	¾	42	173	256	338	419	499	578	656	724	750	808	858	900												
4	¾	48	205	304	401	498	594	689	783	876	969	1068	1135	1194	1245											
4½	¾	54	237	352	465	577	688	798	907	1015	1123	1354	1439	1516	1584	1644										
5	1	60		377	500	621	740	857	972	1087	1201	1486	1605	1690	1766	1834	1894									
5½	1	66		421	560	697	832	965	1097	1228	1359	1682	1950	2056	2151	2236	2312									
6	1	72			624	777	928	1076	1222	1367	1512	1875	2234	2449	2563	2666	2760									
6½	1	78			691	859	1025	1189	1352	1514	1675	2075	2469	2858	3002	3124	3235									
7	1	84				939	1120	1300	1479	1657	1833	2271	2703	3131	3466	3609	3741									
7½	1¼	90				978	1168	1356	1543	1729	1913	2370	2821	3268	3711	3863	4005									
8	1¼	96					1260	1466	1670	1872	2072	2568	3057	3542	4023	4387	4556									
8½	1¼	102					1358	1578	1797	2015	2231	2765	3292	3815	4334	4850	5122									
9	1½	108						1637	1863	2088	2311	2864	3412	3955	4493	5026	5416									
9½	1½	114						1749	1990	2231	2471	3063	3649	4230	4806	5378	5945									
10	1½	120							2119	2375	2630	3261	3886	4506	5120	5730	6335									

FLOOR CONSTRUCTION

TRIANGLE MESH CONCRETE REINFORCEMENT

AMERICAN STEEL AND WIRE COMPANY STANDARD

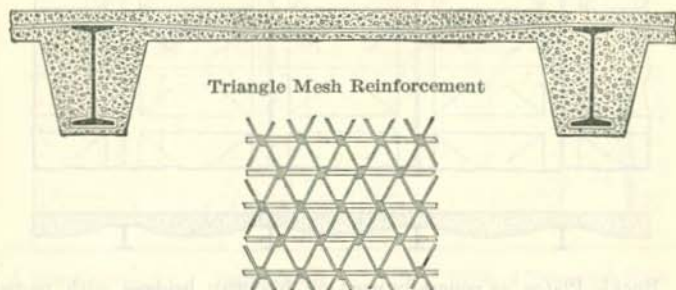

Triangle Mesh is a woven fabric of cold drawn steel wire, providing a continuous reinforcement, an even distribution of metal, and a perfect bond. Made with both single and stranded tension members in lengths up to 300 feet and in widths up to 56 inches.

TRIANGLE MESH—STYLES, AREAS, AND WEIGHTS

Longitudinal and Cross Wires (No. 14 A. S. & W. Co. Gage), Spaced 4 Inches.

Triangle Mesh Style Number	Longitudinal Wire			Triangle Mesh	
	Number of Strands	Thickness, A. S. & W. Co. Wire Gage	Net Area per Foot Width, Sq. Inches	Total Area per Foot Width, Sq. Inches	Approx. Weight per 100 Sq. Ft., Pounds
032	1	No. 12	.026	.032	22
040	1	" 11	.034	.040	25
049	1	" 10	.043	.049	28
058	1	" 9	.052	.058	32
068	1	" 8	.062	.068	35
080	1	" 7	.074	.080	40
093	1	" 6	.087	.093	45
107	1	" 5	.101	.107	50
126	1	" 4	.120	.126	57
146	1	" 3	.140	.146	65
153	1	" 3 1/4"	.147	.153	68
168	1	" 2	.162	.168	74
180	2	" 6	.174	.180	78
208	2	" 5	.202	.208	89
245	2	" 4	.239	.245	103
267	3	" 6	.261	.267	111
287	3	" 5 1/2	.281	.287	119
309	3	" 5	.303	.309	128
336	3	" 4 1/2	.330	.336	138
365	3	" 4	.359	.365	149
395	3	" 3 1/2	.389	.395	160

Length of Rolls: 150, 200 and 300 feet.

Width of Rolls: 16, 20, 24, 28, 32, 36, 40, 44, 48, 52 and 56 inches, approximately.

Triangle Mesh is furnished either with or without galvanizing; unless otherwise specified material will be shipped not galvanised.

BUCKLE PLATES

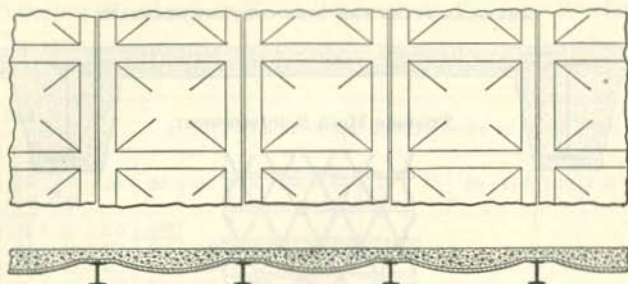

Buckle Plates, as generally used on highway bridges with paved floors, are subjected to a concentrated live load due to the weight of a wagon or truck wheel and to a uniform dead load due to the weight of the roadway paving.

Buckle Plates should be placed with the buckle turned down; then the live load which can be placed on a buckle in addition to the uniform dead load can be obtained from the following formula. Let:

P = Total allowable concentrated load on buckle plate, in pounds.

w = Uniform load, in pounds per square foot.

d = Rise of buckle, in inches.

l = Length of buckle, in inches.

b = Width of buckle, in inches.

t = Thickness of buckle plate, in inches,

$$P = t \left(\frac{300 \text{ fdt} - 0.525 \text{ wlb}}{6 \text{ d} + 15 \text{ t}} \right) \text{ pounds, per buckle.}$$

The following table gives, for a fiber stress of 9000 pounds, the maximum concentrated live load in pounds allowed on buckles (turned down), in addition to a uniform load assumed to be the average weight of paving, etc., of 120 pounds per square foot.

Thickness of Buckle Plate, Inches	Rise, d, in Inches			
	2	2½	3	3½
¼	20000	22000	22000	22500
⅜	30000	33000	34000	34000
½	41000	45000	47000	47500
⅝	53000	58000	61000	63000

The total allowable uniformly distributed load which a buckle plate will safely support may be obtained from the formula:

$$W = 12 \text{ fdt pounds, per buckle.}$$

When the buckles are turned up, use one-third of above values.

FLOOR CONSTRUCTION

BUCKLE PLATES

AMERICAN BRIDGE COMPANY STANDARD

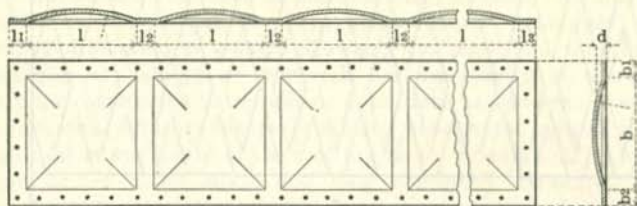

Die Number	Size of Buckle		Rise d, In.	Radii of Buckle		Number of Buckles in One Plate	Widths of Flanges and Fillets		
	Side l, Ft.-In.	Side b, Ft.-In.		Side l, Ft.-In.	Side b, Ft.-In.		End Flanges l ₁ , l ₂	Fillets l ₂	Side Flanges b ₁ , b ₂
1	3-11	4-6	3 1/2	6-8 5/8	8-9 7/8	1 to 8	Minimum = 2" Maximum = 1'-6" If wider than 1'-6" use angles riveted across the plate for stiffeners	Minimum = 2" Maximum = 6" 4" or less preferred	Minimum = 6 1/2" Norm:—When the side flanges b ₁ and b ₂ are of unequal width, the material should be ordered wide enough to make two flanges of the greater width, the narrower flange to be sheared to required width after buckling.
2	4-6	3-11	3 1/2	8-9 7/8	6-8 9/8	1 to 7			
3	3-11	3-6	3 1/2	7-9 1/2	6-3	1 to 8			
4	3-6	3-11	3	6-3	7-9 1/2	1 to 9			
5	3-9	3-9	3	7-1 7/8	7-1 7/8	1 to 8			
6	3-1	3-9	3	4-10 3/4	7-1 7/8	1 to 10			
7	3-9	3-1	3	7-1 7/8	4-10 3/8	1 to 8			
8	3-8	3-8	2	10-2	10-2	1 to 8			
9	2-8	3-8	2	5-5	10-2	1 to 11			
10	3-8	2-8	2	10-2	5-5	1 to 8			
11	2-2	3-8	2	3-7 3/4	10-2	1 to 14			
12	3-8	2-2	2	10-2	3-7 3/4	1 to 8			
13	3-0	3-0	2	6-10	6-10	1 to 10			
14	2-9	2-9	2	3-10 7/8	3-10 7/8	1 to 11			
19	2-6	2-9	2 1/2	3-10 3/4	4-7 7/8	1 to 12			
20	2-9	2-6	2 1/2	4-7 7/8	3-10 3/4	1 to 11			
21	2-6	2-6	2 1/2	3-10 3/4	3-10 3/4	1 to 12			
22	3-5	3-6	3	5-11 1/10	6-3	1 to 9			
23	3-6	3-5	3	6-3	5-11 1/10	1 to 9			
24	3-6	3-9	3	6-3	7-1 7/8	1 to 9			
25	3-9	3-6	3	7-1 7/8	6-3	1 to 8			
26	3-2	3-1	3	5-12 1/32	4-10 3/8	1 to 9			
27	3-1	3-2	3	4-10 3/8	5-12 1/32	1 to 10			
28	3-0	3-1	3	4-7 1/2	4-10 3/8	1 to 10			
29	3-1	3-0	3	4-10 3/8	4-7 1/2	1 to 10			
30	2-6	2-0	2 1/4	3-10 3/4	2-6 1/10	1 to 12			
31	2-0	2-6	2 1/4	2-6 1/10	3-10 3/4	1 to 15			
32	5-6	3-6	3 1/2	13-12 1/64	5-4 3/4	1 to 5			
33	3-6	5-6	3 1/2	5-4 3/4	13-12 1/64	1 to 9			
34	4-0	4-0	3	8-1 1/2	8-1 1/2	1 to 7			

Thickness of Plates, 1/4", 5/16", 3/8" or 7/16".

Plates of greater length than given in table may be made by splicing with bars, angles, or tees.

All plates are made with buckles up, unless otherwise ordered. When buckles are turned down, a drain hole should be punched in the center of each buckle and should be shown on sketch.

Buckles of different sizes should not be used as it increases the cost of the plate.

Connection holes are generally for 5/8", 3/4" or 7/8" rivets or bolts. Holes of different sizes in same plate will increase the cost of the plate.

Spacing for holes lengthwise of plate should be in multiples of 3" and should not exceed 12". Odd spaces to be at end of plate and in even 1/4". Minimum spacing crosswise 4 1/2", usually 6".

Die number must be shown on drawings.

Sketches for Buckle Plates should indicate allowable overrun in length and width.

CARNEGIE STEEL COMPANY

CHECKERED PLATES

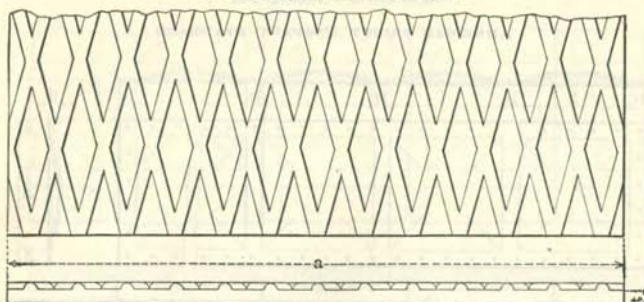

ELEMENTS OF CHECKERED PLATES

Section Index	Width, a		Thickness, t, Inches	Weight per Square Foot, Pounds	Section Modulus for One Foot Width, Inches ³
	Minimum, Inches	Maximum, Inches			
M 56	Over 12	66	$\frac{3}{4}$	31.6	1.125
M 55	Over 12	66	$\frac{5}{8}$	26.5	0.781
M 54	Over 6	66	$\frac{1}{2}$	21.4	0.500
M 53	Over 6	66	$\frac{7}{16}$	18.9	0.383
M 52	Over 6	66	$\frac{5}{8}$	16.3	0.281
M 51	Over 6	66	$\frac{5}{16}$	13.8	0.195
M 50	Over 6	66	$\frac{1}{4}$	11.2	0.125
M 49	Over 6	66	$\frac{3}{16}$	8.7	0.070

ALLOWABLE UNIFORM LOAD IN POUNDS PER SQUARE FOOT

Span in Feet	Fiber Stress, 16000 Pounds per Square Inch								Fiber Stress, 12000 Pounds per Square Inch							
	$\frac{3}{4}$	$\frac{5}{8}$	$\frac{1}{2}$	$\frac{7}{16}$	$\frac{5}{8}$	$\frac{7}{16}$	$\frac{1}{4}$	$\frac{3}{16}$	$\frac{3}{4}$	$\frac{5}{8}$	$\frac{1}{2}$	$\frac{7}{16}$	$\frac{5}{8}$	$\frac{1}{4}$	$\frac{3}{16}$	
1	12000	8333	5333	4083	3000	2083	1333	750	9000	6250	4000	3063	2250	1563	1000	563
2	3000	2083	1333	1021	750	521	333	188	2250	1563	1000	766	563	391	250	141
3	1333	926	593	454	333	232	148	83	1000	694	444	340	250	174	111	63
4	750	521	333	259	188	130	83	47	563	391	250	191	141	98	63	35
5	480	333	213	163	120	83	53	30	360	250	160	123	90	63	40	23
6	333	232	148	113	83	58	37	21	250	174	111	85	63	43	28	
7	245	170	109	83	61	43	27		184	128	82	63	46	32		
8	188	130	83	64	47	33			141	98	63	48	35			
9	148	103	66	50	37				112	77	49	38				
10	120	83	53	41					90	63	40					
11	99	69	44						74	52						
12	83	58							63	43						

The values given in above table are the safe loads per square foot of plates supported on two sides only and are based upon the resistance of rectangular sections, 12 inches by the net thickness, t.

The weight of the plate is included in the safe loads and must be deducted to obtain the net superimposed safe load.

Safe loads for other fiber stresses than those given in table may be obtained from the values given by direct proportion of the fiber stresses.

ROOFS AND ROOF LOADS

The design of roofs and the selection of suitable roofing materials depend on the character of the building, whether monumental, public, residence, mill or shop; permanent or temporary; geographical location as regards allowance for snow and wind loads, and also availability of materials and familiarity of workmen with the construction; atmospheric conditions as concerns presence of industrial or other plants producing deleterious gases; watertightness or resistance of the roof layers to penetration of water, snow or ice under storm and long continued exposure; wind resistance or the strength of materials to resist displacement of the entire surface or disruption between points of support; type and pitch of roof, whether self-supporting on wide spans or requiring the use of sheathing, and whether materials can be laid safely on steep surfaces.

A good roof on a permanent structure should be fireproof from within as well as without, made of refractory materials supported by equally refractory framing. It should last without repair as long as the building stands without repair. Its maintenance cost should be low and its materials purchased on the probable life and service of the structure.

Snow Loads. The snow loads on roofs vary with the geographical location, the altitude and humidity of the place, and with the slope of the roof. Where snow is likely to occur, the minimum load per horizontal square foot of roof should be taken at 25 pounds for all slopes up to 20 degrees; this load to be reduced one pound for each degree of increase in slope up to 45 degrees, above which no snow load need be considered. In severe climates these loads should be increased in accordance with actual conditions. Regard should also be taken to the possibility of partial snow load with local concentration.

Wind Loads. These vary also with the geographical location and the slope of the roof, and, when not fixed by building laws, are usually taken as acting horizontally at 40 pounds per square foot on vertical surfaces of the most exposed structures, and 30 pounds on less exposed structures. On inclined surfaces only the normal components of the wind pressure need be considered. The following normal pressures are based on the formula given by Duchemin: $P = P_1 \frac{2 \sin \alpha}{1 + \sin^2 \alpha}$, where P_1 is the direct horizontal pressure assumed at 30 pounds per square foot on the vertical surface and P the normal pressure on a unit of surface, sloping at angle α with the horizontal.

CARNEGIE STEEL COMPANY

NORMAL WIND PRESSURE, IN POUNDS PER SQUARE FOOT

Slope α°	Pressure per Square Foot, Pounds	Slope α°	Pressure per Square Foot, Pounds	Slope α°	Pressure per Square Foot, Pounds	Slope α°	Pressure per Square Foot, Pounds
5	5.19	20	18.37	35	25.90	50	28.97
10	10.11	25	21.51	40	27.29	55	29.41
15	14.55	30	24.00	45	28.28	60	29.69

For other pressures than 30 pounds per square foot, the values given above change in proportion. For slopes over 60° the values assumed for horizontal pressure are applied.

Combined Roof Loads. In climates corresponding to that of Pittsburgh, and where the roof loads are not fixed by building laws, ordinary roofs up to 80 feet span should carry the following minimum loads per square foot of exposed surface, applied vertically, to provide for dead, wind and snow loads combined.

Roof Covering	Roof Load per Square Foot, Pounds
Gravel or Composition Roofing	50
{ on boards, flat slope, 1 to 6 or less	45
{ on boards, steep slope, more than 1 to 6	60
{ on 3 inch flat tile or cinder concrete	40
Corrugated sheeting on boards or purlins	50
Slate	65
{ on boards or purlins	55
{ on 3 inch flat tile or cinder concrete	45
Tile on steel purlins	
Glass	

For roofs in climates where no snow is likely to occur, reduce these loads by 10 pounds per square foot, but no roof or any part thereof should be designed for a total live and dead load less than 40 pounds per square foot.

Roof Covering. As stated above, suitable protection of a building against rain, snow, etc., depends on the character and location of the building, and the slope or pitch of the roof. Tin, tar, gravel, asphalt roofings and similar compositions are used for flat roofs; slate, tiles, and tin are used for slant roofs of public buildings and residences, shingles for smaller dwelling houses, and corrugated sheeting for shops and warehouses. Slate, tile, tin, and shingles are usually attached to a layer of planking, called sheathing, which in turn is supported by rafters, often called jack rafters, resting upon the roof purlins, or placed directly upon the purlins of the roof.

ROOF CONSTRUCTION

APPROXIMATE WEIGHT OF ROOFING MATERIAL

Roofing Material	Weight per Sq. Foot, Pounds
Copper, No. 22 B. W. G	1 1/4
Corrugated galvanized iron, No. 20 B. W. G.	2 1/4
Corrugated galvanized iron, No. 26 B. W. G.	1 1/4
Felt, 2 layers	1/2
Felt and asphalt or coal-tar.	2
Glass, 1/8 inch thick	1 1/4
Lath and plaster ceiling.	6-8
Lead, 1/8 inch thick	7 1/2
Sheathing, hemlock, 1 inch thick	2
Sheathing, white pine, spruce, 1 inch thick	2 1/4-2 1/2
Sheathing, yellow pine, 1 inch thick	3 1/2
Shingles, 6x18 inches, 6 inches to weather	2
Skylight, glass 3/16 to 1/2 inch, including frame	4-10
Slag roof, 4-ply, with cement and sand.	4
Slate, 1/2 inch thick, 3 inch double lap	4 1/2
Slate, 3/8 inch thick, 3 inch double lap	6 1/4
Terneplate, IC	1/2
Terneplate, IX	1/2
Tiles (plain), 10 1/2x6 1/4x3/4 inches, 5 1/4 inches to weather	18
Tiles (Spanish), 14 1/2x10 1/2 inches, 7 1/4 inches to weather.	8 1/2
Zinc, No. 20 B. W. G	1 1/4

Roof Trusses. Trusses are used where wide roof openings are to be spanned; they form a structure of compression and tension members and produce vertical reactions under vertical loads; the total load of the roof, that is, the weight of the truss, purlins, roof covering, ceiling, and often also the snow and wind load, is usually considered a uniformly distributed load, equally divided between the two supports and producing equal and vertical end reactions.

The purlins usually rest on the upper chord of the truss, transmitting to the latter the load of the roof covering, the wind and snow load, that of the jack rafters and their own, and are often so arranged as to carry the dead load directly to the truss joints or panel points to avoid transverse stresses. The distance between two consecutive joints of the top chord is the panel length, the distance between two adjacent trusses the bay length.

The transverse strength of the sheathing or of the corrugated iron used for the roof covering generally determines the spaces between the jack rafters or the purlins. These purlins or rafters are small steel shapes, such as beams, channels and angles, or wooden beams, if the roof is not of fireproof construction.

TRUSSES—FORMULA FOR STRESSES AND LENGTHS

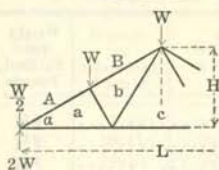

$$n = L/H = 2 \cot \alpha$$

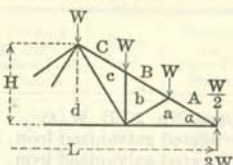

SIMPLE FINK TRUSS

Member	Stress	Length
Aa	$+\frac{1}{2}\sqrt{n^2+4}$ x W	$\frac{1}{2}L \sec \alpha$
Bb	$+\frac{1}{\sqrt{n^2+4}}(n^2+1)$ x W	$\frac{1}{2}L \sec \alpha$
La	$-\frac{1}{2}n$ x W	$\frac{1}{2}L \sec^2 \alpha$
Lc	$-\frac{1}{2}n$ x W	$L(1-\frac{1}{2}\sec^2 \alpha)$
ab	$+\frac{n}{\sqrt{n^2+4}}$ x W	$\frac{1}{2}L \sec \alpha \tan \alpha$
bc	$-\frac{1}{2}n$ x W	$\frac{1}{2}L \sec^2 \alpha$

SIMPLE FAN TRUSS

Member	Stress	Length
Aa	$+\frac{\sqrt{n^2+4}}{2}(n^2+5)$ x W	$\frac{1}{2}L \sec \alpha$
Bb	$+\frac{2}{\sqrt{n^2+4}}(n^2+6)$ x W	$\frac{1}{2}L \sec \alpha$
Cc	$+\frac{1}{\sqrt{n^2+4}}(n^2+1)$ x W	$\frac{1}{2}L \sec \alpha$
La	$-\frac{1}{2}n$ x W	$\frac{1}{2}L \sec^2 \alpha$
Ld	$-\frac{1}{2}n$ x W	$L(1-\frac{1}{2}\sec^2 \alpha)$
ab, bc	$+\frac{n}{\sqrt{n^2+4}}(n^2+14)$ x W	$\frac{1}{2}L\sqrt{\frac{\sec^2 \alpha}{9} + \sec^2 \alpha \tan^2 \alpha}$
cd	$-\frac{1}{2}n$ x W	$\frac{1}{2}L \sec^2 \alpha$

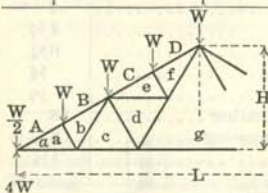

$$n = L/H = 2 \cot \alpha$$

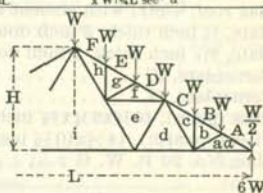

COMPOUND FINK TRUSS

Member	Stress	Length
Aa	$+\frac{1}{2}\sqrt{n^2+4}$ x W	$\frac{1}{2}L \sec \alpha$
Bb	$+\frac{1}{\sqrt{n^2+4}}(n^2+5)$ x W	$\frac{1}{2}L \sec \alpha$
Cc	$+\frac{1}{\sqrt{n^2+4}}(n^2+3)$ x W	$\frac{1}{2}L \sec \alpha$
Dd	$+\frac{1}{\sqrt{n^2+4}}(n^2+1)$ x W	$\frac{1}{2}L \sec \alpha$
La	$-\frac{1}{2}n$ x W	$\frac{1}{2}L \sec^2 \alpha$
Lc	$-\frac{1}{2}n$ x W	$\frac{1}{2}L \sec^2 \alpha$
Lg	$-n$ x W	$L(1-\frac{1}{2}\sec^2 \alpha)$
ab, ef	$+\frac{n}{\sqrt{n^2+4}}$ x W	$\frac{1}{2}L \sec \alpha \tan \alpha$
cd	$+\frac{2n}{\sqrt{n^2+4}}$ x W	$\frac{1}{2}L \sec \alpha \tan \alpha$
bc, de	$-\frac{1}{2}n$ x W	$\frac{1}{2}L \sec^2 \alpha$
dg	$-\frac{1}{2}n$ x W	$\frac{1}{2}L \sec^2 \alpha$
fg	$-\frac{1}{2}n$ x W	$\frac{1}{2}L \sec^2 \alpha$

COMPOUND FAN TRUSS

Member	Stress	Length
Aa	$+\frac{\sqrt{n^2+4}}{2}(n^2+11)$ x W	$\frac{1}{2}L \sec \alpha$
Bb	$+\frac{2}{\sqrt{n^2+4}}(n^2+9)$ x W	$\frac{1}{2}L \sec \alpha$
Cc	$+\frac{1}{\sqrt{n^2+4}}(n^2+7)$ x W	$\frac{1}{2}L \sec \alpha$
Dd	$+\frac{1}{\sqrt{n^2+4}}(n^2+5)$ x W	$\frac{1}{2}L \sec \alpha$
Eg	$+\frac{1}{\sqrt{n^2+4}}(n^2+3)$ x W	$\frac{1}{2}L \sec \alpha$
Fh	$+\frac{1}{\sqrt{n^2+4}}(n^2+1)$ x W	$\frac{1}{2}L \sec \alpha$
La	$-\frac{1}{2}n$ x W	$\frac{1}{2}L \sec^2 \alpha$
Ld	$-\frac{1}{2}n$ x W	$\frac{1}{2}L \sec^2 \alpha$
Li	$-\frac{1}{2}n$ x W	$L(1-\frac{1}{2}\sec^2 \alpha)$
ab, bc, fg, gh	$+\frac{n}{\sqrt{n^2+4}}(n^2+14)$ x W	$\frac{1}{2}L\sqrt{\frac{\sec^2 \alpha}{9} + \sec^2 \alpha \tan^2 \alpha}$
de	$+\frac{2n}{\sqrt{n^2+4}}$ x W	$\frac{1}{2}L \sec \alpha \tan \alpha$
cd, ef	$-\frac{1}{2}n$ x W	$\frac{1}{2}L \sec^2 \alpha$
ei	$-\frac{1}{2}n$ x W	$\frac{1}{2}L \sec^2 \alpha$
hi	$-\frac{1}{2}n$ x W	$\frac{1}{2}L \sec^2 \alpha$

Coefficients for Calculating Lengths of Truss Members

Values of n	3	2 2/3	2 cot 30°	4	2 1/2	5	6
Values of alpha	33°41'24"	30°15'23"	30°	26°33'54"	22°37'12"	21°48'5"	18°26'6"
sec alpha	1.2018	1.1577	1.1547	1.1180	1.0833	1.0770	1.0541
sec² alpha	1.4444	1.3403	1.3333	1.2500	1.1736	1.1600	1.1111
sec alpha tan alpha	0.8012	0.6753	0.6667	0.5590	0.4514	0.4308	0.3514
$\sqrt{\frac{\sec^2 \alpha}{9} + \sec^2 \alpha \tan^2 \alpha}$	0.8958	0.7778	0.7698	0.6718	0.5781	0.5608	0.4969

ROOF CONSTRUCTION

TRUSSES—COEFFICIENTS OF STRESSES

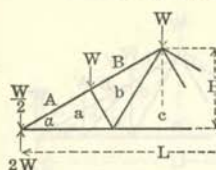

$$n = L/H = 2 \cot \alpha$$

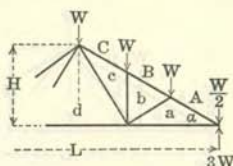

Member	n = Span ÷ Height = 2 cot α						Member	n = Span ÷ Height = 2 cot α							
	3	24/7	2 cot 30°	4	24/5	5		6	3	24/7	2 cot 30°	4	24/5	5	6
Aa	2.70	2.98	3.00	3.35	3.90	4.04	4.74	Aa	4.51	4.98	5.00	5.59	6.50	6.73	7.91
Bb	2.15	2.47	2.50	2.91	3.52	3.67	4.43	Bb	3.54	3.96	4.00	4.55	5.38	5.59	6.64
La	2.25	2.57	2.60	3.00	3.60	3.75	4.50	Cc	3.40	3.95	4.00	4.70	5.73	5.99	7.27
Lc	1.50	1.71	1.73	2.00	2.40	2.50	3.00	La	3.75	4.30	4.33	5.00	6.00	6.25	7.50
ab	0.83	0.86	0.87	0.89	0.92	0.93	0.95	Ld	2.25	2.57	2.60	3.00	3.60	3.75	4.50
bc	0.75	0.86	0.87	1.00	1.20	1.25	1.50	ab, bc	0.93	0.99	1.00	1.08	1.18	1.21	1.34
								cd	1.50	1.71	1.73	2.00	2.40	2.50	3.00

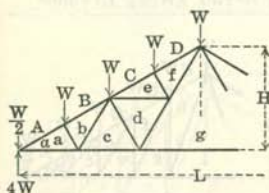

$$n = L/H = 2 \cot \alpha$$

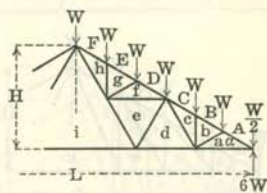

Member	n = Span ÷ Height = 2 cot α						Member	n = Span ÷ Height = 2 cot α							
	3	24/7	2 cot 30°	4	24/5	5		6	3	24/7	2 cot 30°	4	24/5	5	6
Aa	6.31	6.95	7.00	7.83	9.10	9.42	11.07	Aa	9.92	10.91	11.00	12.30	14.30	14.81	17.39
Bb	5.76	6.44	6.50	7.38	8.72	9.05	10.75	Bb	8.95	9.91	10.00	11.25	13.18	13.66	16.13
Cc	5.20	5.94	6.00	6.93	8.33	8.68	10.43	Cc	8.81	9.91	10.00	11.40	13.53	14.07	16.76
Df	4.65	5.43	5.50	6.48	7.95	8.31	10.12	Df	8.25	9.40	9.50	10.96	13.15	13.70	16.44
La	5.25	6.00	6.07	7.00	8.40	8.75	10.50	Eg	7.28	8.41	8.50	9.91	12.02	12.55	15.18
Lc	4.50	5.14	5.20	6.00	7.20	7.50	9.00	Fh	7.14	8.40	8.50	10.06	12.38	12.95	15.93
Lg	3.00	3.43	3.46	4.00	4.80	5.00	6.00	La	8.25	9.43	9.53	11.00	13.20	13.75	16.50
ab, ef	0.83	0.86	0.87	0.89	0.92	0.93	0.95	Ld	6.75	7.71	7.79	9.00	10.80	11.25	13.50
cd	1.66	1.73	1.73	1.79	1.85	1.86	1.90	Li	4.50	5.14	5.20	6.00	7.20	7.50	9.00
bc, de	0.75	0.86	0.87	1.00	1.20	1.25	1.50	ab, bc, fg, gh	0.93	0.99	1.00	1.08	1.18	1.21	1.34
dg	1.50	1.71	1.73	2.00	2.40	2.50	3.00	de	2.50	2.59	2.60	2.68	2.77	2.79	2.85
fg	2.25	2.57	2.60	3.00	3.60	3.75	4.50	cd, ef	1.50	1.71	1.73	2.00	2.40	2.50	3.00
								ei	2.25	2.57	2.60	3.00	3.60	3.75	4.50
								hi	3.75	4.29	4.33	5.00	6.00	6.25	7.50

The pitch of a truss is the ratio of the rise or height to the span length of the truss.
 Pitch = $H/L = 1/n$. $n = L/H = 1/\text{pitch}$.

To obtain the stress in any member of a given truss, multiply the corresponding coefficient by the panel load W .

Compression members are designated by + and tension members by -

TRUSSES—FORMULAS FOR STRESSES AND LENGTHS

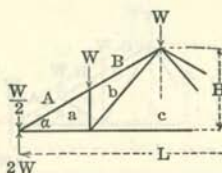

$$n = L/H = 2 \cot \alpha$$

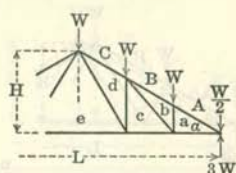

PRATT TRUSS—4 PANELS			PRATT TRUSS—6 PANELS		
Member	Stress	Length	Member	Stress	Length
Aa, Bb	$+\frac{3}{4}\sqrt{n^2+4} xW$	$\frac{1}{4} L \sec \alpha$	Aa, Bb	$+\frac{5}{6}\sqrt{n^2+4} xW$	$\frac{1}{6} L \sec \alpha$
La	$-\frac{1}{4} n xW$	$\frac{1}{4} L$	Cd	$+\sqrt{n^2+4} xW$	$\frac{1}{6} L \sec \alpha$
Lc	$-\frac{1}{2} n xW$	$\frac{1}{2} L$	La	$-\frac{5}{6} n xW$	$\frac{1}{6} L$
ab	$+1 xW$	$\frac{1}{4} h$	Lc	$-n xW$	$\frac{1}{6} L$
bc	$-\frac{1}{4}\sqrt{n^2+16} xW$	$\frac{1}{4}\sqrt{L^2+16h^2}$	Le	$-\frac{3}{4} n xW$	$\frac{1}{6} L$
			ab	$+1 xW$	$\frac{1}{6} h$
			cd	$+\frac{3}{2} xW$	$\frac{1}{6} h$
			bc	$-\frac{1}{4}\sqrt{n^2+16} xW$	$\frac{1}{6}\sqrt{L^2+16h^2}$
			de	$-\frac{1}{4}\sqrt{n^2+36} xW$	$\frac{1}{6}\sqrt{L^2+36h^2}$

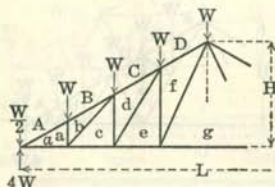

$$n = L/H = 2 \cot \alpha$$

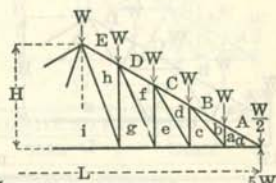

PRATT TRUSS—8 PANELS			PRATT TRUSS—10 PANELS		
Member	Stress	Length	Member	Stress	Length
Aa, Bb	$+\frac{7}{8}\sqrt{n^2+4} xW$	$\frac{1}{8} L \sec \alpha$	Aa, Bb	$+\frac{9}{10}\sqrt{n^2+4} xW$	$\frac{1}{10} L \sec \alpha$
Cd	$+\frac{3}{2}\sqrt{n^2+4} xW$	$\frac{1}{8} L \sec \alpha$	Cd	$+2\sqrt{n^2+4} xW$	$\frac{1}{10} L \sec \alpha$
Df	$+\frac{5}{8}\sqrt{n^2+4} xW$	$\frac{1}{8} L \sec \alpha$	Df	$+\frac{7}{10}\sqrt{n^2+4} xW$	$\frac{1}{10} L \sec \alpha$
La	$-\frac{7}{8} n xW$	$\frac{1}{8} L$	Eh	$+\frac{9}{10}\sqrt{n^2+4} xW$	$\frac{1}{10} L \sec \alpha$
Lc	$-\frac{3}{2} n xW$	$\frac{1}{8} L$	La	$-\frac{9}{10} n xW$	$\frac{1}{10} L$
Le	$-\frac{5}{8} n xW$	$\frac{1}{8} L$	Lc	$-2 n xW$	$\frac{1}{10} L$
Lg	$-n xW$	$\frac{1}{8} L$	Le	$-\frac{7}{10} n xW$	$\frac{1}{10} L$
ab	$+1 xW$	$\frac{1}{8} h$	Lg	$-\frac{3}{2} n xW$	$\frac{1}{10} L$
cd	$-\frac{3}{2} xW$	$\frac{1}{8} h$	Li	$-\frac{5}{10} n xW$	$\frac{1}{10} L$
ef	$+2 xW$	$\frac{1}{8} h$	ab	$+1 xW$	$\frac{1}{8} h$
bc	$-\frac{1}{8}\sqrt{n^2+16} xW$	$\frac{1}{8}\sqrt{L^2+16h^2}$	cd	$+\frac{3}{2} xW$	$\frac{1}{8} h$
de	$-\frac{1}{8}\sqrt{n^2+36} xW$	$\frac{1}{8}\sqrt{L^2+36h^2}$	ef	$+2 xW$	$\frac{1}{8} h$
fg	$-\frac{1}{8}\sqrt{n^2+64} xW$	$\frac{1}{8}\sqrt{L^2+64h^2}$	gh	$+\frac{5}{2} xW$	$\frac{1}{8} h$
			bc	$-\frac{1}{8}\sqrt{n^2+16} xW$	$\frac{1}{10}\sqrt{L^2+16h^2}$
			de	$-\frac{1}{8}\sqrt{n^2+36} xW$	$\frac{1}{10}\sqrt{L^2+36h^2}$
			fg	$-\frac{1}{8}\sqrt{n^2+64} xW$	$\frac{1}{10}\sqrt{L^2+64h^2}$
			hi	$-\frac{1}{8}\sqrt{n^2+100} xW$	$\frac{1}{10}\sqrt{L^2+100h^2}$

ROOF CONSTRUCTION

TRUSSES—COEFFICIENTS OF STRESSES

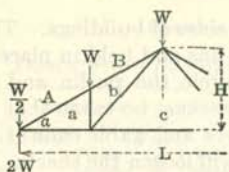

$$n = L/H = 2 \cot \alpha$$

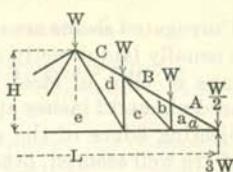

Member	n = Span ÷ Height = 2 cot α						Member	n = Span ÷ Height = 2 cot α							
	3	24/7	2 cot 30°	4	24/5	5		6	3	24/7	2 cot 30°	4	24/5	5	6
Aa, Bb	2.70	2.98	3.00	3.35	3.90	4.04	4.74	Aa, Bb	4.51	4.96	5.00	5.59	6.50	6.73	7.91
La	2.25	2.57	2.60	3.00	3.60	3.75	4.50	Cd	3.61	3.97	4.00	4.47	5.20	5.39	6.32
Lc	1.50	1.71	1.73	2.00	2.40	2.50	3.00	La	3.75	4.29	4.33	5.00	6.00	6.25	7.50
ab	1.00	1.00	1.00	1.00	1.00	1.00	1.00	Lc	3.00	3.43	3.46	4.00	4.80	5.00	6.00
bc	1.25	1.32	1.32	1.41	1.56	1.60	1.80	Le	2.25	2.57	2.60	3.00	3.60	3.75	4.50
								ab	1.00	1.00	1.00	1.00	1.00	1.00	1.00
								cd	1.50	1.50	1.50	1.50	1.50	1.50	1.50
								bc	1.25	1.32	1.32	1.41	1.56	1.60	1.80
								de	1.68	1.73	1.73	1.80	1.92	1.95	2.12

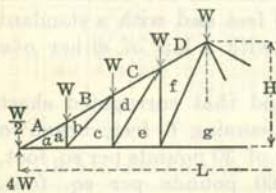

$$n = L/H = 2 \cot \alpha$$

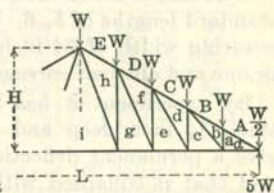

Member	n = Span ÷ Height = 2 cot α						Member	n = Span ÷ Height = 2 cot α							
	3	24/7	2 cot 30°	4	24/5	5		6	3	24/7	2 cot 30°	4	24/5	5	6
Aa, Bb	6.31	6.95	7.00	7.83	9.10	9.42	11.07	Aa, Bb	8.11	8.93	9.00	10.06	11.70	12.12	14.23
Cd	5.41	5.95	6.00	6.71	7.80	8.08	9.49	Cd	7.21	7.94	8.00	8.94	10.40	10.77	12.65
Df	4.51	4.97	5.00	5.59	6.50	6.73	7.91	Df	6.31	6.95	7.00	7.83	9.10	9.42	11.07
La	5.25	6.00	6.06	7.00	8.40	8.75	10.50	Eh	5.41	5.95	6.00	6.71	7.80	8.08	9.49
Lc	4.50	5.14	5.20	6.00	7.20	7.50	9.00	La	6.75	7.71	7.79	9.00	10.80	11.25	13.50
Le	3.75	4.29	4.33	5.00	6.00	6.25	7.50	Lc	6.00	6.86	6.93	8.00	9.60	10.00	12.00
Lg	3.00	3.43	3.46	4.00	4.80	5.00	6.00	Le	5.25	6.00	6.06	7.00	8.40	8.75	10.50
ab	1.00	1.00	1.00	1.00	1.00	1.00	1.00	Lg	4.50	5.14	5.20	6.00	7.20	7.50	9.00
cd	1.50	1.50	1.50	1.50	1.50	1.50	1.50	Li	3.75	4.29	4.33	5.00	6.00	6.25	7.50
ef	2.00	2.00	2.00	2.00	2.00	2.00	2.00	ab	1.00	1.00	1.00	1.00	1.00	1.00	1.00
bc	1.25	1.32	1.32	1.41	1.56	1.60	1.80	cd	1.50	1.50	1.50	1.50	1.50	1.50	1.50
de	1.68	1.73	1.73	1.80	1.92	1.95	2.12	ef	2.00	2.00	2.00	2.00	2.00	2.00	2.00
fg	2.14	2.18	2.18	2.24	2.33	2.36	2.50	gh	2.50	2.50	2.50	2.50	2.50	2.50	2.50
								bc	1.25	1.32	1.32	1.41	1.56	1.60	1.80
								de	1.68	1.73	1.73	1.80	1.92	1.95	2.12
								fg	2.14	2.18	2.18	2.24	2.33	2.36	2.50
								hi	2.61	2.64	2.65	2.69	2.77	2.80	2.92

CORRUGATED SHEETS

Corrugated sheets are used for roofs and sides of buildings. They are usually laid directly upon the roof purlins and held in place by means of clips of steel hoops which encircle the purlin and are placed about 12 inches apart. Special care must be taken that the projecting edges of the sheets at the eaves and gable ends of the roof are well secured, otherwise the wind will loosen the sheets.

Corrugated sheets are made in the sizes given on opposite page, the size most generally used has nominally 2½-inch corrugations, actual width 2¾ inches, about ½ inch in depth. The gages frequently used for roofing are Nos. 20 and 22, U. S. Standard Gage.

By one corrugation is meant the double curve between corresponding points, and by depth of corrugation the greatest deviation of the curved surfaces from the straight line.

One and one-half corrugations are allowed for lap in the width of the sheet and 6 inches in the length for the usual quarter pitch roof; one corrugation in width and 4 inches in the length of the sheet is usually allowed for sidings.

Corrugated sheets of 2, 2½ and 3 corrugations are furnished in standard lengths of 5, 6, 7, 8, 9 and 10 feet and with a standard covering width of 24 inches, when laid with a lap of either one or one and one-half corrugations.

By experiment it has been determined that corrugated sheet steel, ⅝ inch deep and No. 20 gage spanning 6 feet, began to give a permanent deflection with a load of 30 pounds per sq. foot, and that it collapsed with a load of 60 pounds per sq. foot. The distance between centers of purlins should, therefore, not exceed 6 feet and should preferably be less than this.

Approximately the uniformly distributed safe load of corrugated sheets may be obtained from the formulas given below, using the following notations:—

W=Total allowable uniform load, in pounds.

b=Curvilinear width of sheet, in inches (b=1.075 x covering width).

l=Unsupported length of sheet, in inches.

t=Thickness of sheet, in inches.

d=Depth of corrugations, in inches.

f=Allowable fiber stress, in pounds per sq. inch.

$$\text{Then: } W = \frac{8fS}{l} = \frac{8f}{l} \times \frac{4bdt}{15} = \frac{32fbd}{15l}$$

$$\text{for } f = 12000, \quad W = \frac{25,600 bdt}{l}$$

ROOF CONSTRUCTION

CORRUGATED SHEETS

AMERICAN SHEET AND TIN PLATE COMPANY

DESCRIPTION OF SHEETS

AREAS OF SHEETS

Corrugations				Width, Inches		Length of Sheet, Inches	Sq. Ft. in 1 Sheet			Sheets in 100 Sq. Ft.		
Width, Inches	Depth, Inches	Number per Sheet	Full Sheet	Covering	Corrugations			Corrugations				
Nominal					Actual		5"	3" ² / ₂ " ² / ₂ "	1 ¹ / ₈ "	5"	3" ² / ₂ " ² / ₂ "	1 ¹ / ₈ "
5	5	⁷ / ₈	6	28	25	60	11.67	10.83	10.42	8.57	9.23	9.60
3	3	⁹ / ₁₆	9	26	24	72	14.00	13.00	12.50	7.14	7.69	8.00
*2 ¹ / ₂	2 ³ / ₈	¹ / ₂	10 ¹ / ₂	27 ¹ / ₂	24	84	16.33	15.17	14.58	6.12	6.59	6.86
2 ¹ / ₂	2 ³ / ₈	¹ / ₂	10	26	24	96	18.67	17.33	16.67	5.36	5.77	6.00
2	2	⁷ / ₁₆	13	26	24	108	21.00	19.50	18.75	4.76	5.13	5.33
1 ¹ / ₄	1 ¹ / ₄	³ / ₈	20	25	23 ³ / ₄	120	23.33	21.67	20.83	4.29	4.62	4.80
⁵ / ₈	⁵ / ₈	⁹ / ₁₆	40	25	24 ³ / ₈	144	28.00	26.00	25.00	3.57	3.85	4.00

Standard lengths 5, 6, 7, 8, 9 and 10 ft. Maximum length, 12 ft. except for ⁵/₈" corrugation. Sizes denoted *2¹/₂ are for the 27¹/₂" width.

PAINTED SHEETS—Weights in Pounds per 100 Square Feet.

Corrug., In.	Thickness, United States Standard Gage														
	10	12	14	16	18	20	21	22	23	24	25	26	27	28	29
5		470	336	269	215	162	148	135	122	108	95	81	75	68	..
3		472	338	270	216	163	149	136	122	109	95	82	75	68	..
*2 ¹ / ₂	615	478	342	274	219	165	151	137	124	110	97	83	76	69	..
2 ¹ / ₂	607	472	338	270	216	163	149	136	122	109	95	82	75	68	..
2				270	216	163	149	136	122	109	95	82	75	68	..
1 ¹ / ₄				270	216	163	149	136	122	109	95	82	75	68	..
⁵ / ₈				270	216	163	149	136	122	109	95	82	75	68	..

GALVANIZED SHEETS—Weights in Pounds per 100 Square Feet.

Corrug., In.	Thickness, United States Standard Gage														
	10	12	14	16	18	20	21	22	23	24	25	26	27	28	29
5		486	352	285	231	178	164	151	137	124	111	97	90	84	77
3		488	353	286	232	178	165	151	138	125	111	98	91	84	77
*2 ¹ / ₂	631	494	358	290	235	181	167	153	140	126	113	99	92	85	78
2 ¹ / ₂	623	488	353	286	232	178	165	151	138	125	111	98	91	84	77
2				286	232	178	165	151	138	125	111	98	91	84	77
1 ¹ / ₄					186	172	158	144	130	116	102	95	88	81	..
⁵ / ₈						186	172	158	144	130	116	102	95	88	81

The weights per 100 square feet given in preceding tables do not include allowances for end or side laps. The following table gives the approximate number of square feet of sheeting necessary to cover an area of 100 square feet and is based on sheets of standard width, 96 inches long. If longer or shorter sheets are used, the number of square feet required will vary accordingly.

SQ. FEET OF 2¹/₂ IN. STANDARD SHEETS TO COVER AREA OF 100 SQ. FT.

Side Lap	Corrugation	End Lap, Inches					
		1	2	3	4	5	6
1	Corrugation	109	111	112	113	114	116
1 ¹ / ₂	"	116	117	118	120	121	122
2	"	123	124	126	127	129	130

STRUCTURAL TIMBER

The strength of structural timbers depends upon a number of factors; the kind of wood, the age of the tree, the time of the year in which it was felled, the method of sawing, the character of the seasoning and therewith its moisture content, the proportion of heartwood to sapwood and the proportion of knots to clear wood.

In consequence of these variable factors, the working unit stresses approved by the building laws of different cities vary widely, as well also as the unit stresses given in the proceedings of the various engineering associations. They go back in some cases to the studies made in 1895 by the Association of Railway Superintendents of Bridges and Buildings.

The most recent studies in this direction have been made by the American Railway Engineering Association, and the tables for wooden beams and columns which follow are based on the working unit stresses for structural timbers adopted by that Association. The table of working unit stresses has been reprinted, by permission, from the Manual, edition of 1911.

These unit stresses vary with the class of construction. They are intended, as noted, for railway bridges and trestles. For highway bridges and trestles and for buildings and similar structures, the unit stresses may be increased in accordance with the more quiescent character of the loading and freedom from deleterious weather conditions. The values are based on carefully selected timber purchased in accordance with the standard specifications of the Association and subject to careful inspection.

The commercial timbers which are in common use in building construction will not meet these specifications, and, therefore, the unit stresses approved by good building practice as evidenced in the building laws of various cities are rightly lower. The tables as they stand are in accord with the average practice as represented by these building laws, and may, therefore, be used as they stand for ordinary building work executed with the commercial grades of timber, such as can be purchased in the open market.

The allowable loads may be adjusted to other species of wood than those stated in the headings of the tables and to other unit stresses by the direct proportion which such unit stresses bear to those for which the tables are computed. In the case of columns the values may be adjusted to any working unit stress by direct proportion based on the relations of l/d .

TIMBER SAFE LOADS

WORKING UNIT STRESSES FOR STRUCTURAL TIMBER

ADOPTED BY THE AMERICAN RAILWAY ENGINEERING ASSOCIATION

The working unit stresses given in the table are intended for railroad bridges and trestles. For highway bridges and trestles, the unit stresses may be increased 25 per cent. For buildings and similar structures, in which the timber is protected from the weather and practically free from impact, the unit stresses may be increased 50 per cent. To compute the deflection of a beam under long continued loading instead of that when the load is first applied, only 50 per cent. of the corresponding modulus of elasticity given in the table is to be employed.

Kind of Timber	Bending			Shearing			Compression						
	Extreme Fiber Stress	Modulus of Elasticity	Average	Parallel to the Grain		Longitudinal Shear in Beams	Perpendicular to the Grain		Parallel to the Grain		Working Stresses for Columns		
				Average	Ultimate		Working	Limit	Average	Ultimate			
Douglas Fir	6100	1200	1510000	690	170	270	110	630	310	3600	1200	900	1200(1-1/60d)
Longleaf Pine	6500	1300	1610000	720	180	300	120	520	260	3800	1300	975	1300(1-1/60d)
Shortleaf Pine	5600	1100	1480000	710	170	330	130	340	170	3400	1100	825	1100(1-1/60d)
White Pine	4400	900	1130000	400	100	180	70	290	150	3000	1000	750	1000(1-1/60d)
Spruce	4800	1000	1310000	600	150	170	70	370	180	3200	1100	825	1100(1-1/60d)
Norway Pine	4200	800	1190000	590*	130	250	100		150	2600*	800	600	800(1-1/60d)
Tamarack	4600	900	1220000	670	170	260	100		220	3200*	1000	750	1000(1-1/60d)
Western Hemlock	5800	1100	1480000	630	160	270*	100	440	220	3500	1200	900	1200(1-1/60d)
Redwood	5000	900	800000	300	80			400	150	3300	900	675	900(1-1/60d)
Bald Cypress	4800	900	1150000	500	120			340	170	3800	1100	825	1100(1-1/60d)
Red Cedar	4200	800	800000					470	230	2800	900	675	900(1-1/60d)
White Oak	5700	1100	1150000	840	210	270	110	920	450	3500	1300	975	1300(1-1/60d)

Unit stresses are for green timber and are to be used without increasing the live load stresses for impact. Value noted * are for partially air dry timbers.

In the formulas given for columns, l=length of column, in inches, and d=least side or diameter, in inches.

WOODEN BEAMS

The safe load tables of wooden beams which follow, based upon the working unit stresses adopted by the American Railway Engineering Association, give the uniformly distributed safe loads for rectangular sections one inch thick; the safe load for a beam of any thickness is found by multiplying the tabular value by the thickness of the beam in inches. The safe loads include the weight of the beams and are computed on the assumption that the beams are braced against lateral deflection. These tables also give minimum and maximum spans and coefficients of deflection.

The maximum safe loads as limited by the allowable shearing stresses along horizontal axes of beams have been calculated from the formula: Maximum safe load = $\frac{1}{3}$ x area of section x safe unit stress for longitudinal shear. These limits, indicated also by horizontal lines in the tables, should not be exceeded to avoid failure of the beam in horizontal direction of the grain of the wood.

The theoretical deflection in the center of the span for uniformly distributed and permanently applied loads is obtained from the coefficients of deflection by dividing the depth of the beam, in inches, into the corresponding coefficient; the result obtained only approximates the actual deflection, as the modulus of elasticity varies with the moisture content of the wood.

The deflection of beams intended to carry plastered ceilings should not exceed $\frac{1}{360}$ of the span; the table gives the maximum spans for this limit, for uniformly distributed and permanently applied loads.

For loads concentrated in the center of the span, use one-half the values for the tabular loads and four-fifths of the coefficients of deflection. For special cases of loading, see pages 141 to 146.

EXAMPLE 1.—Required the thickness and the approximate deflection of a beam of white oak, 14 inches deep, supporting a uniformly distributed and permanent dead and live load of 10,000 pounds over a span of 19 feet.

The tabular value for a beam one inch thick and for a span of 19 feet is 1,261 pounds; the required thickness is therefore $10,000 \div 1,261 = 8$ inches, and the deflection is $20.72 \div 14 = 1.48$ inches.

EXAMPLE 2.—Required the safe load of a beam of white pine, 8 inches deep and 6 inches thick, without exceeding the longitudinal shearing stress.

The table gives for a corresponding beam 1 inch thick a safe load of 747 pounds; the total safe load is therefore $6 \times 747 = 4,482$ pounds, or the safe load which can be safely supported over a span of 8.6 feet.

EXAMPLE 3.—Required the safe load, concentrated in the center of a span 26 feet long, and the deflection of a beam of longleaf pine, 18 inches deep and 12 inches thick.

The table gives for a corresponding beam 1 inch thick a uniformly distributed safe load of 1,800 pounds, or for a load in center of span $1,800 \div 2 = 900$ pounds; for a beam 12 inches wide the safe load is therefore $900 \times 12 = 10,800$ pounds, and the deflection is approximately $\frac{1}{5} \times 32.75 \div 18 = 1.46$ inches.

TIMBER SAFE LOADS

RECTANGULAR WOODEN BEAMS—ONE INCH THICK

MAXIMUM SAFE LOADS AND LIMITING SPANS

Depth of Beam, Inches	White Oak		Longleaf Pine		Shortleaf Pine		White Pine		Douglas Fir		Western Hemlock		Spruce	
	Max. Load, Lbs.	Min. Span, Ft.	Max. Load, Lbs.	Min. Span, Ft.	Max. Load, Lbs.	Min. Span, Ft.	Max. Load, Lbs.	Min. Span, Ft.	Max. Load, Lbs.	Min. Span, Ft.	Max. Load, Lbs.	Min. Span, Ft.	Max. Load, Lbs.	Min. Span, Ft.
2	293	1.7	320	1.8	347	1.4	187	2.1	293	1.8	267	1.8	187	2.4
4	587	3.3	640	3.6	693	2.8	373	4.3	587	3.6	533	3.7	373	4.8
6	880	5.0	960	5.4	1040	4.2	560	6.4	880	5.5	800	5.5	560	7.1
8	1173	6.7	1280	7.2	1387	5.6	747	8.6	1173	7.3	1067	7.3	747	9.5
10	1467	8.4	1600	9.0	1733	7.1	933	10.7	1467	9.1	1333	9.2	933	11.9
12	1760	10.0	1920	10.8	2080	8.5	1120	12.9	1760	10.9	1600	11.0	1120	14.3
14	2053	11.7	2240	12.6	2427	9.9	1307	15.0	2053	12.8	1867	12.8	1307	16.7
16	2347	13.4	2560	14.4	2773	11.3	1493	17.1	2347	14.6	2133	14.7	1493	19.0
18	2640	15.0	2880	16.3	3120	12.7	1680	19.3	2640	16.4	2400	16.5	1680	21.4
20	2933	16.7	3200	18.1	3467	14.1	1867	21.4	2933	18.2	2667	18.3	1867	23.8
22	3227	18.4	3520	19.9	3813	15.5	2053	23.6	3227	20.0	2933	20.2	2053	26.2
24	3520	20.0	3840	21.7	4160	16.9	2240	25.7	3520	21.9	3200	22.0	2240	28.6

COEFFICIENTS OF DEFLECTION FOR PERMANENT LOADS

Span in Feet	White Oak	Long-leaf Pine	Short-leaf Pine, Western Hemlock	White Pine, Douglas Fir	Spruce	Span in Feet	White Oak	Long-leaf Pine	Short-leaf Pine, Western Hemlock	White Pine, Douglas Fir	Spruce
2	0.23	0.19	0.18	0.19	0.18	22	27.78	23.44	21.59	23.10	22.17
3	0.52	0.44	0.40	0.43	0.41	23	30.37	25.63	23.59	25.25	24.23
4	0.92	0.78	0.71	0.76	0.73	24	33.06	27.91	25.69	27.49	26.38
5	1.44	1.21	1.12	1.19	1.15	25	35.88	30.28	27.88	29.83	28.63
6	2.07	1.74	1.61	1.72	1.65	26	38.80	32.75	30.15	32.27	30.96
7	2.81	2.37	2.19	2.34	2.24	27	41.85	35.32	32.51	34.80	33.39
8	3.67	3.10	2.85	3.06	2.93	28	45.00	37.99	34.97	37.42	35.91
9	4.65	3.92	3.61	3.87	3.71	29	48.27	40.75	37.51	40.14	38.52
10	5.74	4.85	4.46	4.77	4.58	30	51.66	43.61	40.14	42.96	41.22
11	6.95	5.86	5.40	5.78	5.54	31	55.16	46.56	42.86	45.87	44.01
12	8.27	6.98	6.42	6.87	6.60	32	58.78	49.61	45.67	48.88	46.90
13	9.70	8.19	7.54	8.07	7.74	33	62.51	52.76	48.57	51.98	49.88
14	11.25	9.50	8.74	9.36	8.98	34	66.35	56.01	51.56	55.18	52.95
15	12.92	10.90	10.04	10.74	10.31	35	70.32	59.35	54.64	58.47	56.11
16	14.69	12.40	11.42	12.22	11.73	36	74.39	62.79	57.80	61.86	59.36
17	16.59	14.00	12.89	13.79	13.24	37	78.58	66.33	61.06	65.34	62.70
18	18.60	15.70	14.45	15.47	14.84	38	82.89	69.96	64.40	68.92	66.14
19	20.72	17.49	16.10	17.23	16.53	39	87.31	73.69	67.84	72.60	69.66
20	22.96	19.38	17.84	19.09	18.32	40	91.84	77.52	71.36	76.37	73.28

MAXIMUM SPANS IN FEET FOR DEFLECTIONS = 1/360 SPAN

Species of Timber	Depth of Beam in Inches											
	2	4	6	8	10	12	14	16	18	20	22	24
White Oak	1.2	2.3	3.5	4.6	5.8	7.0	8.1	9.3	10.5	11.6	12.8	13.9
Longleaf Pine	1.4	2.8	4.1	5.5	6.9	8.3	9.6	11.0	12.4	13.8	15.1	16.5
Shortleaf Pine, Hemlock	1.5	3.0	4.5	6.0	7.5	9.0	10.5	12.0	13.5	15.0	16.4	17.9
White Pine, Douglas Fir	1.4	2.8	4.2	5.6	7.0	8.4	9.8	11.2	12.6	14.0	15.4	16.7
Spruce	1.5	2.9	4.4	5.8	7.3	8.7	10.2	11.6	13.1	14.6	16.0	17.5

CARNEGIE STEEL COMPANY

RECTANGULAR WOODEN BEAMS—ONE INCH THICK

DOUGLAS FIR

ALLOWABLE UNIFORM LOAD IN POUNDS

Maximum Bending Stress, 1200 Pounds per Square Inch

Span in Feet	Depth of Beam in Inches											
	2	4	6	8	10	12	14	16	18	20	22	24
2	267											
3	178											
4	133	533										
5	107	427										
6	89	356	800									
7	76	305	686	1178								
8	67	267	600	1067								
9		237	533	948	1407							
10		213	480	853	1333							
11		194	436	776	1212	1760						
12		178	400	711	1111	1600	2058					
13			369	656	1026	1477	2010					
14			343	610	952	1371	1867	2847				
15			320	569	889	1280	1742	2276				
16			300	533	833	1200	1633	2133	2840			
17				502	784	1129	1537	2008	2541			
18				474	741	1067	1452	1896	2400	2933		
19				449	702	1011	1375	1796	2274	2807	3227	
20				427	667	960	1307	1707	2160	2667	3227	
21					635	914	1244	1625	2057	2540	3073	3620
22					606	873	1188	1552	1964	2424	2933	3491
23					580	835	1136	1484	1878	2319	2806	3339
24					556	800	1089	1422	1800	2222	2689	3200
25						768	1045	1365	1728	2133	2581	3072
26						738	1005	1313	1662	2051	2482	2954
27						711	968	1264	1600	1975	2390	2844
28						686	933	1219	1543	1905	2305	2743
29							901	1177	1490	1839	2225	2648
30							871	1138	1440	1778	2151	2560
31							843	1101	1394	1720	2082	2477
32							817	1067	1350	1667	2017	2400
33								1034	1309	1616	1956	2327
34								1004	1271	1569	1898	2259
35								975	1234	1524	1844	2194
36								948	1200	1481	1793	2133
37									1168	1441	1744	2076
38									1137	1404	1698	2021
39									1108	1368	1655	1969
40									1080	1333	1613	1920

Horizontal lines indicate the limit for resistance to shear in the horizontal direction of the grain.

TIMBER SAFE LOADS

RECTANGULAR WOODEN BEAMS—ONE INCH THICK

LONGLEAF PINE

ALLOWABLE UNIFORM LOAD IN POUNDS

Maximum Bending Stress, 1300 Pounds per Square Inch

Span in Feet	Depth of Beam in Inches											
	2	4	6	8	10	12	14	16	18	20	22	24
2	820											
3	289											
4	193	640										
5	144	578										
6	116	462										
7			960									
8	96	385	867									
9	83	330	743	1280								
10	72	289	650	1156	1600							
11				1027	1444							
12						1920						
13		210	473	840	1313	1891						
14		193	433	770	1204	1733	2240					
15			400	711	1111	1600	2178	2560				
16			371	660	1032	1486	2022	2465				
17			347	616	963	1387	1887					
18								2311	2880			
19			325	578	903	1300	1769	2175	2753			
20				544	850	1224	1665	2175	2753			
21				514	802	1156	1573	2054	2600	3200		
22				487	760	1095	1490	1946	2463	3041	3620	
23				462	722	1040	1416	1849	2340	2889	3496	
24												
25					688	991	1348	1761	2229	2751	3329	3840
26					657	945	1287	1681	2127	2626	3178	3782
27					628	904	1231	1608	2035	2512	3040	3617
28					602	867	1180	1541	1950	2407	2913	3467
29						832	1132	1479	1872	2311	2796	3328
30												
31						800	1089	1422	1800	2222	2689	3200
32						770	1049	1370	1733	2140	2589	3082
33						743	1011	1321	1671	2064	2497	2971
34							976	1275	1614	1992	2411	2869
35							944	1233	1560	1926	2330	2773
36												
37							913	1193	1510	1864	2255	2684
38							885	1156	1463	1806	2185	2600
39								1121	1418	1751	2119	2521
40								1088	1377	1699	2056	2447
								1057	1337	1651	1998	2377
									1027	1300	1605	1942
										1265	1562	1890
										1232	1521	1840
										1200	1482	1793
										1170	1444	1748

Horizontal lines indicate the limit for resistance to shear in the horizontal direction of the grain.

CARNEGIE STEEL COMPANY

RECTANGULAR WOODEN BEAMS—ONE INCH THICK
 SHORLEAF PINE, WESTERN HEMLOCK AND WHITE OAK
 ALLOWABLE UNIFORM LOAD IN POUNDS
 Maximum Bending Stress, 1100 Pounds per Square Inch

Span in Feet	Depth of Beam in Inches											
	2	4	6	8	10	12	14	16	18	20	22	24
2	347											
3	245	698										
4	163	652										
5	122	489	1040									
6	98	391	880	1387								
7	82	326	733	1304								
8	70	279	629	1117	1733							
9	61	245	550	978	1528	2080						
10		217	489	869	1358	1956	2427					
11		196	440	782	1222	1760	2396					
12		178	400	711	1111	1600	2178	2773				
13		163	367	652	1019	1467	1996	2607	3120			
14			338	602	940	1354	1843	2407	3046			
15			314	559	873	1257	1711	2235	2829	3467		
16			293	522	816	1173	1597	2086	2640	3259		
17			275	489	764	1100	1497	1956	2475	3055	3697	4100
18				460	719	1035	1409	1841	2329	2876	3480	4141
19				435	679	978	1331	1738	2200	2716	3287	3911
20				412	643	926	1261	1647	2084	2573	3113	3705
21				391	611	880	1198	1564	1980	2444	2958	3520
22					583	838	1141	1490	1886	2328	2817	3352
23					556	800	1089	1422	1800	2222	2689	3200
24					531	765	1042	1361	1722	2126	2572	3061
25					509	733	998	1304	1650	2037	2465	2933
26						704	958	1252	1584	1956	2366	2816
27						677	921	1203	1523	1880	2275	2708
28						652	887	1159	1467	1811	2191	2608
29						629	856	1118	1414	1746	2113	2514
30							826	1079	1366	1686	2040	2428
31							799	1043	1320	1630	1973	2348
32							773	1009	1278	1577	1908	2271
33							749	978	1238	1528	1849	2200
34								948	1200	1482	1793	2133
35								920	1165	1438	1740	2071
36								894	1131	1397	1690	2011
37								869	1100	1358	1643	1956
38									1070	1321	1599	1903
39									1042	1287	1557	1853
40									1015	1254	1517	1805
									990	1222	1479	1760

Upper, middle, and lower horizontal lines indicate the limits for resistance to shear in the horizontal direction of the grain of Shortleaf Pine, White Oak, and Hemlock respectively.

TIMBER SAFE LOADS

RECTANGULAR WOODEN BEAMS—ONE INCH THICK

WHITE PINE

ALLOWABLE UNIFORM LOAD IN POUNDS

Maximum Bending Stress, 900 Pounds per Square Inch

Span in Feet	Depth of Beam in Inches												
	2	4	6	8	10	12	14	16	18	20	22	24	
2	187												
3	133												
4	100	873											
5	80	320											
6	67	267	500										
7	57	229	514										
8	50	200	450	747									
9		178	400	711									
10		160	360	640									
					933								
11		145	327	582	909								
12		133	300	533	833	1120							
13			277	492	769	1108							
14			257	457	714	1029	1307						
15			240	427	667	960	1307						
16			225	400	625	900	1225						
17				377	588	847	1153	1403					
18				356	556	800	1089	1422					
19				337	526	758	1032	1347	1680				
20				320	500	720	980	1280	1620				
21					476	686	933	1219	1543	1807			
22					455	655	891	1164	1473	1818			
23					435	626	852	1113	1409	1739	2063		
24					417	600	817	1067	1350	1667	2017		
25						576	784	1024	1296	1600	1936		
												2240	
26						554	754	985	1246	1538	1862	2215	
27						533	726	948	1200	1481	1793	2133	
28						514	700	914	1157	1429	1729	2057	
29							676	883	1117	1379	1669	1986	
30							653	853	1080	1333	1613	1920	
31								632	826	1045	1290	1561	1858
32								613	800	1013	1250	1513	1800
33									776	982	1212	1467	1746
34									753	953	1176	1424	1694
35									731	926	1143	1383	1646
36									711	900	1111	1344	1600
37										876	1081	1308	1557
38										853	1053	1274	1516
39										831	1026	1241	1477
40										810	1000	1210	1440

Horizontal lines indicate the limit for resistance to shear in the horizontal direction of the grain.

CARNEGIE STEEL COMPANY

RECTANGULAR WOODEN BEAMS—ONE INCH THICK

SPRUCE

ALLOWABLE UNIFORM LOAD IN POUNDS

Maximum Bending Stress, 1000 Pounds per Square Inch

Span in Feet	Depth of Beam in Inches											
	2	4	6	8	10	12	14	16	18	20	22	24
2	187											
3	148											
4	111	378										
5	89	356										
6	74	296										
7	63	254	560									
8	56	222	500									
9		198	444	747								
10		178	400	711								
11		162	364	646	903							
12		148	333	593	926							
13			308	547	855							
14			286	508	794	1120						
15			267	474	741	1067						
16			250	444	694	1000	1307					
17				418	654	941	1281					
18				395	617	889	1210					
19				374	585	842	1146	1498				
20				356	556	800	1089	1422				
21					529	762	1037	1354	1680			
22					505	727	990	1293	1636			
23					483	696	947	1237	1565	1867		
24					463	667	907	1185	1500	1852		
25						640	871	1138	1440	1778		
26						615	838	1094	1385	1709	2063	
27						593	807	1053	1333	1646	1992	
28						571	778	1016	1286	1587	1921	2240
29							751	981	1241	1533	1854	2207
30							726	948	1200	1481	1793	2133
31							703	918	1161	1434	1735	2065
32							681	889	1125	1389	1681	2000
33								862	1091	1347	1630	1939
34								837	1059	1307	1582	1882
35								813	1029	1270	1537	1829
36								790	1000	1235	1494	1778
37									973	1201	1453	1730
38									947	1169	1415	1684
39									923	1140	1379	1641
40									900	1111	1344	1600

Horizontal lines indicate the limit for resistance to shear in the horizontal direction of the grain.

WOODEN COLUMNS

The safe load tables of wooden columns which follow, based upon the working unit stresses adopted by the American Railway Engineering Association, give the allowable direct compressive loads for square and round columns.

The safe loads of rectangular columns may be found from the safe loads of square columns by direct proportion of areas, using the safe load unit stress of the square column whose side is equal to the least side of the rectangular section.

The following table gives the safe load in pounds per square inch of sectional area for ratios of

$$\frac{l}{d} = \frac{\text{effective length of column, in inches}}{\text{least side or diameter, in inches}},$$

ranging between limits of 15 and 30.

UNIT WORKING STRESSES IN POUNDS PER SQUARE INCH

$\frac{l}{d}$	Longleaf Pine, White Oak	Douglas Fir, Western Hemlock	Shortleaf Pine, Spruce, Bald Cypress	White Pine, Tamarack	Red Cedar, Redwood	Norway Pine
	1300 (1-l/d60)	1200 (1-l/d60)	1100 (1-l/d60)	1000 (1-l/d60)	900 (1-l/d60)	800 (1-l/d60)
15	975	900	825	750	675	600
16	953	880	807	733	660	587
17	931	860	788	717	645	573
18	910	840	770	700	630	560
19	888	820	752	683	615	547
20	867	800	733	667	600	533
21	845	780	715	650	585	520
22	823	760	697	633	570	507
23	802	740	678	617	555	493
24	780	720	660	600	540	480
25	758	700	642	583	525	467
26	737	680	623	567	510	453
27	715	660	605	550	495	440
28	693	640	587	533	480	427
29	672	620	568	517	465	413
30	650	600	550	500	450	400

EXAMPLE 1.—Required the allowable load for a column of white oak 10" x 8", 14 feet long.

The safe load given in the table for a square white oak column 8" x 8", 14 feet long, is 54,100 pounds. The load for the 10" x 8" section is 10 x 54,100 ÷ 8 = 67,600 pounds.

EXAMPLE 2.—Required the allowable load for a spruce pile, 9" diameter and 18 feet long.

The unit stress given in the above table for the corresponding ratio of l/d, 18 x 12 ÷ 9 = 24 is 660 pounds, and the sectional area for a 9" round is 63.62 square inches. The safe load, therefore, is 63.62 x 660 = 42,000 pounds.

CARNEGIE STEEL COMPANY

SQUARE WOODEN COLUMNS

SAFE LOADS IN THOUSANDS OF POUNDS

American Railway Engineering Association Formulas

	Length, Feet	Side of Square, Inches										
		4	6	8	10	12	14	16	18	20		
LONGLEAF PINE WHITE OAK 1300 (1—1/60d)	5	15.6										
	6	15.6										
	7	14.6										
	8	13.5	35.1									
	9	12.5	34.3									
	10	11.4	32.8	62.4								
	11	10.4	31.2	62.4								
	12		29.6	60.3								
	14		28.1	58.2	97.5							
	16		25.0	54.1	93.6	140.4						
	18			49.9	88.4	137.3	191.1					
	20			45.8	83.2	131.0	189.3	249.6				
				41.6	78.0	124.8	182.0	249.6	315.9		390.0	
DOUGLAS FIR WESTERN HEMLOCK 1200 (1—1/60d)	5	14.4										
	6	14.4										
	7	13.4										
	8	12.5	32.4									
	9	11.5	31.7									
	10	10.6	30.2	57.5								
	11	9.6	28.8	57.6								
	12		27.4	55.7								
	14		25.9	53.8	90.0							
	16		23.0	49.9	86.4	129.6						
	18			46.1	81.6	126.7	176.4					
	20			42.2	76.8	121.0	174.7	230.4				
				38.4	72.0	115.2	168.0	230.4	291.6		360.0	
SHORTLEAF PINE SPRUCE 1100 (1—1/60d)	5	13.2										
	6	13.2										
	7	12.3										
	8	11.4	29.7									
	9	10.6	29.0									
	10	9.7	27.7	52.8								
	11	8.8	26.4	52.8								
	12		25.1	51.0								
	14		23.8	49.3	82.5							
	16		21.1	45.8	79.2	118.8						
	18			42.2	74.8	116.2	161.7					
	20			38.7	70.4	110.9	160.2	211.2				
				35.2	66.0	105.6	154.0	211.2	267.3		330.0	
WHITE PINE TAMARACK 1000 (1—1/60d)	5	12.0										
	6	12.0										
	7	11.2										
	8	10.4	27.0									
	9	9.6	26.4									
	10	8.8	25.2	48.0								
	11	8.0	24.0	48.0								
	12		22.8	46.4								
	14		21.6	44.8	75.0							
	16		19.2	41.6	72.0	108.0						
	18			38.4	68.0	105.6	147.0					
	20			35.2	64.0	100.8	145.6	192.0				
				32.0	60.0	96.0	140.0	192.0	248.0		300.0	

Loads in small figures above horizontal lines are the maximum allowable safe loads.

TIMBER SAFE LOADS

ROUND WOODEN COLUMNS

SAFE LOADS IN THOUSANDS OF POUNDS

American Railway Engineering Association Formulas

	Length, Feet	Diameter, Inches								
		4	6	8	10	12	14	16	18	20
LONGLEAF PINE, WHITE OAK 1300 (1—1/60d)	5	<u>12.3</u>								
	6	12.3								
	7	11.4								
	8	10.6	<u>37.6</u>							
	9	9.8	27.0							
	10	9.0	25.7	<u>49.0</u>						
	11	8.2	24.5	49.0						
	12		23.3	47.4						
	14		22.1	45.7	<u>76.5</u>					
	16		19.6	42.5	73.5	<u>110.3</u>				
	18			39.2	69.4	107.8	<u>150.1</u>			
	20			35.9	65.3	102.9	148.7	<u>196.0</u>		
			32.7	61.3	98.0	142.9	196.0	248.1	306.3	
DOUGLAS FIR, WESTERN HEMLOCK 1200 (1—1/60d)	5	<u>11.3</u>								
	6	11.3								
	7	10.6								
	8	9.8	<u>35.4</u>							
	9	9.1	24.9							
	10	8.3	23.7	<u>45.2</u>						
	11	7.5	22.6	45.2						
	12		21.5	43.7						
	14		20.4	42.2	<u>79.7</u>					
	16		18.1	39.2	67.9	<u>101.8</u>				
	18			36.2	64.1	99.5	<u>138.5</u>			
	20			33.2	60.3	95.0	137.2	<u>181.0</u>	*	
			30.2	56.5	90.5	132.0	181.0	229.0	282.7	
SHORTLEAF PINE, SPRUCE 1100 (1—1/60d)	5	<u>10.4</u>								
	6	10.4								
	7	9.7								
	8	9.0	<u>29.3</u>							
	9	8.3	22.8							
	10	7.6	21.8	<u>41.5</u>						
	11	6.9	20.7	41.5						
	12		19.7	40.1						
	14		18.7	38.7	<u>64.8</u>					
	16		16.6	35.9	62.2	<u>93.3</u>				
	18			33.2	58.7	91.2	<u>127.0</u>			
	20			30.4	55.3	87.1	125.8	<u>165.9</u>		
			27.6	51.8	82.9	121.0	165.9	200.9	259.2	
WHITE PINE, TAMARACK 1000 (1—1/60d)	5	<u>9.4</u>								
	6	9.4								
	7	8.8								
	8	8.2	<u>31.2</u>							
	9	7.5	20.7							
	10	6.9	19.8	<u>37.7</u>						
	11	6.3	18.9	37.7						
	12		17.9	36.4						
	14		17.0	35.2	<u>58.9</u>					
	16		15.1	32.7	56.5	<u>84.8</u>				
	18			30.2	53.4	82.9	<u>115.5</u>			
	20			27.6	50.3	79.2	114.4	<u>150.8</u>		
			25.1	47.1	75.4	110.0	150.8	190.9	235.6	

Loads in small figures above horizontal lines are the maximum allowable safe loads.

PHYSICAL PROPERTIES OF SUBSTANCES

SPECIFIC GRAVITIES AND WEIGHTS

Substance	Specific Gravity	Weight, Pounds per Cu. Ft.	Substance	Specific Gravity	Weight, Pounds per Cu. Ft.
Minerals			Ashlar Masonry		
Asbestos	2.1-2.8	153	Granite, syenite, gneiss	2.3-3.0	165
Barytes	4.50	281	Limestone, marble	2.3-2.8	160
Basalt	2.7-3.2	184	Sandstone, bluestone	2.1-2.4	140
Bauxite	2.55	159	Mortar Rubble Masonry		
Borax	1.7-1.8	109	Granite, syenite, gneiss	2.2-2.8	155
Chalk	1.8-2.6	137	Limestone, marble	2.2-2.6	150
Clay, marl	1.8-2.6	137	Sandstone, bluestone	2.0-2.2	130
Dolomite	2.9	181	Dry Rubble Masonry		
Feldspar, orthoclase	2.5-2.6	159	Granite, syenite, gneiss	1.9-2.3	130
Gneiss, serpentine	2.4-2.7	159	Limestone, marble	1.9-2.1	125
Granite	2.5-2.7	162	Sandstone, bluestone	1.8-1.9	110
Greenstone, trap	2.8-3.2	187	Brick Masonry		
Gypsum, alabaster	2.3-2.8	159	Pressed brick	2.2-2.3	140
Hornblende	3.0	187	Common brick	1.8-2.0	120
Limestone	2.3-2.7	156	Soft brick	1.5-1.7	100
Magnesite	3.0	187	Concrete Masonry		
Marble	2.7-2.85	173	Cement, stone, sand	2.2-2.4	144
Phosphate rock, apatite	3.2	200	" slag, etc	1.9-2.3	130
Porphyry	2.6-2.9	172	" cinder, etc	1.5-1.7	100
Pumice, natural	0.37-0.90	40	Various Building Mat'l		
Quartz, flint	2.5-2.8	165	Ashes, cinders		40-45
Sandstone, bluestone	2.2-2.5	147	Cement, portland, loose		90
Slate, shale	2.7-2.8	172	" " set	2.7-3.2	183
Soapstone, talc	2.6-2.8	169	Lime, gypsum, loose		65-75
Stone, Quarried, Piled			Mortar, set	1.4-1.9	103
Basalt, granite, gneiss		96	Slags, bank slag		67-72
Limestone, marble, quartz		95	" " screenings		98-117
Sandstone		82	" machine slag		96
Shale		92	" slag sand		49-55
Greenstone, hornblende		107	Earth, etc., Excavated		
Bituminous Substances			Clay, dry		63
Asphaltum	1.1-1.5	81	" damp, plastic		110
Coal, anthracite	1.4-1.7	97	Clay and gravel, dry		100
" bituminous	1.2-1.5	84	Earth, dry, loose		76
" lignite	1.1-1.4	78	" " packed		75
" peat, turf, dry	0.65-0.85	47	" moist, loose		98
" charcoal, pine	0.28-0.44	23	" " packed		96
" " oak	0.47-0.57	33	" mud, flowing		108
" coke	1.0-1.4	75	" " packed		115
Graphite	1.9-2.3	131	Riprap, limestone		80-85
Paraffine	0.87-0.91	56	" sandstone		90
Petroleum, crude	0.88	55	" shale		105
" refined	0.79-0.82	50	Sand, gravel, dry, loose		90-105
" benzine	0.73-0.75	46	" " " packed		100-120
" gasolene	0.66-0.69	42	" " " wet		118-120
Pitch	1.07-1.15	69	Excavations in Water		
Tar, bituminous	1.20	75	Sand or gravel		60
Coal and Coke, Piled			" " and clay		65
Coal, anthracite		47-58	Clay		80
" bituminous, lignite		40-54	River mud		90
" peat, turf		20-26	Soil		70
" charcoal		10-14	Stone riprap		85
" coke		23-32			

The specific gravities of solids and liquids refer to water at 4°C., those of gases to air at 0°C. and 760 mm pressure. The weights per cubic foot are derived from average specific gravities, except where stated that weights are for bulk, heaped or loose material, etc.

CONTENTS OF STORAGE WAREHOUSES

Material	Pounds per Cubic Foot of Space,	Height of Pile, Feet	Pounds per Square Foot of Floor	Recommended Live Loads, Pounds per Square Foot
Produce, Grain, Fruit, Etc.				
Grain, in bulk				} 250 to 300
Barley and Corn.....	37	8	296	
Oats.....	26	8	208	
Rye and Wheat.....	48	8	384	
Fruit and Vegetables, in bulk				
Apples, Pears, etc.....	38	8	304	
Potatoes, Turnips, etc.....	44	8	352	
Miscellaneous Produce, packed				
Beans, in bags.....	40	8	320	
Corn, in bags.....	31	8	248	
Cornmeal, in barrels.....	37	6½	240	
Oats, in bags.....	26	9	234	
Rice, in bags.....	58	5	290	
Wheat, in bags.....	39	8	312	
Wheat Flour, in barrels.....	40	7	280	
Hay, in bales, not compressed.....	14	9	126	
Hay, in bales, compressed.....	24	9	216	
Straw, in bales, compressed.....	19	9	171	
Groceries				
Miscellaneous Articles, packed				} 250 to 300
Butter, Lard, etc., in barrels.....	32	6	192	
Canned Goods, Preserves, etc., in cases	58	6	348	
Cheese.....	30	8	240	
Coffee, green, in bags.....	39	8	312	
Coffee, roasted, in bags.....	33	8	264	
Dates and Figs, in cases, average.....	65	5	325	
Meat, Beef, Pork, etc., in barrels.....	37	5	185	
Molasses, in barrels.....	48	5	240	
Salt, finely ground, in sacks.....	60	5	300	
Soap Powder, in cases.....	38	8	288	
Starch, in barrels.....	25	7	175	
Sugar, in barrels.....	43	5	215	
Tea, in chests.....	25	8	200	
Wines, Liquors, etc., in barrels.....	48	5	240	
Dry Goods, Cotton, Wool, Etc.				
Cotton, in bales, compressed, average.....	25	9	225	} 200 to 250
" unbleached goods, in bales.....	24	9	216	
" tickings and duck, in bales.....	35	8	280	
" printed goods, in bales.....	19	9	171	
" printed goods, in cases.....	31	8	248	
" quilts and flannels, in cases.....	16	9	144	
" yarn, in cases.....	25	8	200	
Hemp, in bales, compressed.....	22	8	176	
" Manila, in bales, compressed.....	26	9	234	
" Sisal, in bales, compressed.....	24	9	216	
" Tow, in bales, compressed.....	29	9	261	
" Burlaps, in bales, compressed.....	43	6	258	
Jute, in bales, compressed.....	41	6	246	
Linen, bleached goods, in cases.....	35	7	245	
" damask goods, in cases.....	50	5	250	
Wool, in bales, not compressed.....	13	9	117	
" in bales, compressed.....	48	5	240	
" dress goods, flannels, in cases.....	18	9	162	
" worsted goods, in cases.....	27	9	243	
Rags, in bales, compressed.....	19	9	171	
Excelsior, in bales, compressed.....	19	9	171	

PHYSICAL PROPERTIES OF SUBSTANCES

CONTENTS OF STORAGE WAREHOUSES

Material	Pounds per Cubic Foot of Space,	Height of Pile, Feet	Pounds per Square Foot of Floor	Recommended Live Loads, Pounds per Square Foot	
Drugs, Oils, Paints, Etc.					
Chemicals:					
Acids, Muriatic and Nitric, in carboys	45	1½	75	} 200 to 250	
“ Sulphuric, in carboys	60	1½	100		
Ammonia, in carboys	30	1½	50		
Alum, Pearl Alum, in barrels	33	7	231		
Bleaching Powder, in hogsheads	31	3½	103		
Copper Sulphate, Blue Vitriol, in bbls.	45	5	225		
Soda, Caustic Soda, in iron drums	88	3½	294		
Soda, Soda Ash, in hogsheads	62	2¾	170		
Soda Crystals, Sal Soda, in barrels	30	5	150		
Soda Nitrate, Niter, in barrels	45	5	225		
Soda Silicate, in barrels	53	5	265		
Zinc Sulphate, White Vitriol, in barrels	40	5	200		
Oils, Fats, Resins, etc.:					
Glycerine, in cases	52	6	312		
Oils, Animal, Lard, etc., in barrels	34	6	204		
“ Vegetable, Linseed, in barrels	36	6	216		
“ Mineral, Lubricants, in barrels	35	6	210		
“ Petroleum, Kerosene, in barrels	33	6	198		
“ Naphtha, Gasolene, in barrels	28	6	168		
Rosin, in barrels	48	6	288		
Shellac Gum, in boxes	38	6	228		
Tallow, in barrels	37	6	222		
Dye Stuffs, Paints, etc.:					
Indigo, in boxes	43	6	258		
Logwood Extract, in boxes	70	4½	315		
Sumac, in boxes	39	5	195		
Red Lead, Litharge, dry, in barrels	132	3¾	495		
White Lead, dry, in barrels	86	4¾	409		
White Lead, paste, in cans	174	3½	609		
Building Materials					
Cement, Natural, in barrels	59	6	354	} 300 to 400	
“ Portland, in barrels	73	6	438		
Lime, Quick Lime, ground, in barrels	50	5	250		
Plaster of Paris, ground, in barrels	53	5	265		
Sheet Metal and Wire					
Sheet Tin, in boxes	278	1½	417	} 300 to 400	
Wire, insulated copper, in coils	63	5	315		
“ galvanized iron, in coils	74	4½	333		
“ magnet wire, on spools	75	6	450		
Miscellaneous					
China ware, Glassware, in crates	40	8	320	} 300 to 400	
“ “ in casks	14	9	126		
Glass, in boxes	60	6	360		
Hardware, door and sash checks, in cases	46	6	276		
“ hinges, in cases	64	6	384		
“ locks, in cases	31	6	186		
“ screws, in boxes	101	4	404		
Hides, raw, not compressed, in bales	13	10	130		
“ raw, compressed, in bales	23	10	230		
Leather, in bales	16	10	160		
Paper, calendered paper	50	6	300		
“ newspaper, manila, strawboards	35	6	210		
“ writing paper	64	6	384		
Rope in Coils	42	6	252		

STRENGTH OF MATERIALS

STRESSES PER SQUARE INCH

Metals and Alloys	Stresses in Thousands of Pounds					Modulus of Elasticity, Pounds	Elongation, %
	Tension, Ultimate	Elastic Limit	Compression, Ultimate	Bending, Ultimate	Shearing, Ultimate		
Aluminum, cast.....	15	6.5	12		12	11,000,000	
" bars, sheets.....	24-28	12-14					
" wire, hard.....	30-65	16-30					
" " annealed.....	20-35	14					
" 2-7% Ni, Cu, Fe, etc.....	40-50	25					
Aluminum Bronze, 5% to 7½% Al.....	75	40	120				
" " 10% Al.....	85-100	60					
Copper, cast.....	25	6	40	22	30	10,000,000	
" plates, rods, bolts.....	32-35	10	32			18,000,000	
" wire, hard.....	55-65					15,000,000	
" wire, annealed.....	36	10					
Brass, 17% Zn.....	32.6	8.2		23.2			26.7
" 23% ".....		7.6	42	22.3			35.8
" 30% ".....	28.1	8.6		26.9			20.7
" 39% ".....	41.1	17.4	75	39			20.7
" 50% ".....	31	17.9	117	33.5			5.0
" cast, common.....	18-24	6	30	20	36	9,000,000	
" wire, hard.....	80						
" " annealed.....	50	16				14,000,000	
Bronze 8% Sn.....	28.5	19	42	43.7		10,000,000	5.5
" 13% ".....	29.4	20	53	34.5			3.3
" 20% ".....	33	22	78	56.7			0.04
" 24% ".....	22	22	114	32			0
" 30% ".....	5.6	5.6	147	12.1			0
" gun metal, 9 Cu, 1 Sn.....	25-55	10		52		10,000,000	
" Manganese, cast } 10% Sn.....	60	30	125				
" " rolled } 2% Mn.....	100	80					
" Phosphorus, cast } 9% Sn.....	50	24					
" " wire } 1% P.....	100						
" Silicon, cast, 3% Si.....	55						
" " " 5% Si.....	75						
" " wire.....	108						
" Tobin, cast } 38% Zn.....	66						
" " rolled } 1½% Sn.....	80	40					
" " cold rolled } ¼% Pb.....	100						
Delta Metal, cast } 55-60% Cu.....	45						
" " plates } 38-40% Zn.....	68						
" " bars } 2-4% Fe.....	85						
" " wire } 1-2% Sn.....	100						
German Silver, 25% Zn, 20% Ni.....							
Iron, see next page.....							
Gold, cast.....	20	4				8,000,000	
" wire.....	30						
" copper, 5 Au, 1 Cu.....	50						
Lead, cast.....	1.8					1,000,000	
" pipe, wire.....	2.2-2.5					1,000,000	
" rolled sheets.....	3.3					720,000	
Platinum, wire, unannealed.....	53						
" " annealed.....	32						
Silver, cast.....	40						
Steel, see next page.....							
Tin, cast.....	3.5-4.6	1.5-1.8	6	4		4,000,000	
" antimony, 10 Sn, 1 Sb.....	11						
Zinc, cast.....	4-6	4	18	7		13,000,000	
" rolled sheets.....	7-16						

PHYSICAL PROPERTIES OF SUBSTANCES

STRENGTH OF MATERIALS

STRESSES PER SQUARE INCH

Metal and Alloys	Stresses in Thousands of Pounds					Modulus of Elasticity, Pounds	Elongation, %
	Tension, Ultimate	Elastic Limit	Compression, Ultimate	Bending, Ultimate	Shearing, Ultimate		
Steel							
Shapes, Plates, Bars*							
" bridges.....	55-65	½ tens.	tensile	tensile	¾ tens.	29,000,000	27.3-23.0
" buildings.....	55-65	"	"	"	"	29,000,000	25.4-21.5
" cars.....	50-65	"	"	"	"	29,000,000	30.0-23.0
" locomotives.....	55-65	"	"	"	"	29,000,000	27.3-23.0
" ships.....	58-68	"	"	"	"	29,000,000	25.9-22.1
Boiler Plates*							
" " fire box.....	55-65	½ tens.	tensile	tensile	¾ tens.	29,000,000	27.3-23.0
" " flange plates.....	52-62	"	"	"	"	29,000,000	28.8-24.2
Rivets*							
" boilers.....	45-55	½ tens.	tensile	tensile	¾ tens.	29,000,000	33.3-27.3
" bridges.....	46-56	"	"	"	"	29,000,000	32.6-26.8
" buildings.....	46-56	"	"	"	"	29,000,000	30.4-25.0
" cars.....	48-58	"	"	"	"	29,000,000	31.3-25.9
" ships.....	55-65	"	"	"	"	29,000,000	27.3-23.0
Concrete Bars*							
" plain, structural grade.....	55-70	33	tensile	tensile	¾ tens.	29,000,000	25.4-20.0
" " intermediate.....	70-85	40	"	"	"	29,000,000	18.6-15.3
" " hard.....	80	50	"	"	"	29,000,000	15.0
" deformed, struct'l grade.....	55-70	33	"	"	"	29,000,000	22.7-17.9
" " intermediate.....	70-85	40	"	"	"	29,000,000	16.1-13.2
" " hard.....	80	50	"	"	"	29,000,000	12.5
" cold twisted.....		55	"	"	"	29,000,000	5.0
Castings*							
" soft.....	60	27	tensile	tensile	¾ tens.	29,000,000	22.0
" medium.....	70	31.5	"	"	"	29,000,000	18.0
" hard.....	80	36	"	"	"	29,000,000	15.0
Forgings*							
Steel Alloys							
Nickel Steel, * 3.25% Ni.							
" shapes, plates, bars.....	85-100	50	tensile	tensile	¾ tens.	29,000,000	17.6-15.0
" rivets.....	70-80	45	"	"	"	29,000,000	21.4-18.8
" eye bars, unannealed.....	95-110	55	"	"	"	29,000,000	15.8-13.6
" " annealed.....	90-105	52	"	"	"	29,000,000	20.0
Copper Steel, 0.50% Cu.....	60-68	37-38	"	"	"	29,000,000	29.0-23.0
Steel Springs and Wire							
Springs, untempered.....	65-110	40-70					
Wire, unannealed.....	120	60					
" annealed.....	80	40					
" bridge cable.....	200	95					
Wrought Iron							
Shapes.....	48	26	tensile	tensile	¾ tens.	28,000,000	
Bars.....	50	27	"	"	"	28,000,000	
Wire, unannealed.....	80					15,000,000	
" annealed.....	60	27				25,000,000	
Cast Iron							
Common.....	15-18	6	80	30	18-20	12,000,000	
Gray.....	18-24			25-33			
Malleable.....	27-35	15-20	46	30	40		

* See Specifications of the Society of Testing Materials.

CARNEGIE STEEL COMPANY

STRENGTH OF MATERIALS
STRESSES IN POUNDS PER SQUARE INCH

Building Materials	Ultimate Average Stresses			Modulus of Elasticity	Safe Working Stresses		
	Compress.	Tension	Bending		Compress.	Bearing	Shearing
Stone							
Granite, gneiss, bluestone....	12,000	1,200	1,600	7,000,000	1,200	1,200	200
Limestone, marble.....	8,000	800	1,500	7,000,000	800	800	150
Sandstone.....	5,000	150	1,200	3,000,000	500	500	150
Slate.....	10,000	3,000	5,000	14,000,000	1,000	1,000	175
Masonry							
Granite.....					420	600	
Limestone, bluestone.....					350	500	
Sandstone.....					280	400	
Rubble.....					140	250	
" coursed.....					170	250	
Brick, medium burned.....	10,000				170	300	
" hard burned.....	15,000				210	300	
" pressed, paving brick.....	6,000						
Terra Cotta.....	5,000						
Cement, Portland							
Neat, 28 days.....	7,040	740					
" 90 days.....	7,350	740					
1:3 sand, 28 days.....	1,290	320					
" 90 days.....	1,490	340					
Concrete, P. C.							
1:1:2 { Granite, trap rock.....	3,300						
1:1:2 { Furnace Slag.....	3,000						
1:1:2 { Lime and Sandstone, hard	3,000			Modulus of Elasticity {	3,000,000 for ult. compression over 2,900. 2,500,000 for ult. compression up to 2,900. 2,000,000 for ult. compression up to 2,200. 750,000 for ult. compression under 800.		
1:1:2 { Lime and Sandstone, soft	2,200						
1:1:2 { Cinders.....	800						
1:1:3 { Granite, trap rock.....	2,800						
1:1:3 { Furnace Slag.....	2,500						
1:1:3 { Lime and Sandstone, hard	2,500						
1:1:3 { Lime and Sandstone, soft	1,800						
1:1:3 { Cinders.....	700						
1:2:4 { Granite, trap rock.....	2,200						
1:2:4 { Furnace Slag.....	2,000						
1:2:4 { Lime and Sandstone, hard	2,000						
1:2:4 { Lime and Sandstone, soft	1,500						
1:2:4 { Cinders.....	600						
1:3:5 { Granite, trap rock.....	1,800						
1:3:5 { Furnace Slag.....	1,600						
1:3:5 { Lime and Sandstone, hard	1,600						
1:3:5 { Lime and Sandstone, soft	1,200						
1:3:5 { Cinders.....	500						
1:3:6 { Granite, trap rock.....	1,400						
1:3:6 { Furnace Slag.....	1,300						
1:3:6 { Lime and Sandstone, hard	1,300						
1:3:6 { Lime and Sandstone, soft	1,000						
1:3:6 { Cinders.....	400						
Miscellaneous							
Glass, common.....	30,000	3,000					
Plaster.....	700	70	3,000	8,000,000			

Reinforced Concrete

Modulus of Elasticity { 3,000,000 for ult. compression over 2,900.
2,500,000 for ult. compression up to 2,900.
2,000,000 for ult. compression up to 2,200.
750,000 for ult. compression under 800.

Safe Working Stresses
in Percent of Ultimate Compression

Compression { Plain Concrete Piers, length 4 dia. 22.5%
Reinforced Columns, " 12 " 22.5%
Reinforced Beams, 32.5%

Bearing Surface twice the loaded area..... 35.0%

Shear and Diag. Tension { Horizontal Bars, no web reinforcement 2.0%
" " vertical stirrups... 4.5%
Bent Bars and vertical stirrups.... 5.0%
Same, securely attached..... 6.0%

Bond Stress { Drawn Wire..... 2.0%
Plain reinforcing bars..... 4.0%
Deformed Bars, best type..... 5.0%

For complete data see Transactions of the American Society of Civil Engineers, Vol. LXXXI-No. 1398, Dec. 1917

For ultimate and working stresses of Structural Timber, see page 289.

PHYSICAL PROPERTIES OF SUBSTANCES

EXPANSION OF BODIES BY HEAT

The linear coefficient of expansion of a body is the rate at which the unit of length changes, under constant pressure, with an increase of unit or one degree of temperature; the square surface coefficient of expansion is, approximately, two times, and the cubical or volumetric coefficient three times the linear coefficient of expansion. A bar, if not fixed, undergoes a change in length= ltn , where l is the length of the bar in inches, t the number of degrees, n the corresponding linear coefficient; if fixed at both ends, the internal stress per unit of area= tnE , pounds per square inch, where E is the modulus of elasticity, and the total temperature stress= $AtnE$, pounds, where A is the cross section of the bar in square inches.

To find the increase of a bar due to an increase in temperature, from the table, multiply the length of the bar by the increase in degrees and by the coefficient for 100 degrees, and divide by 100.

COEFFICIENTS OF EXPANSION FOR 100 DEGREES= $100n$

Substance	Linear Expansion		Substance	Linear Expansion	
	Centigrade	Fahrenheit		Centigrade	Fahrenheit
Metals and Alloys			Stone and Masonry		
Aluminum, wrought00231	.00128	Ashlar masonry00063	.00035
Brass00188	.00104	Brick masonry00055	.00031
" wire00193	.00107	Cement, portland00107	.00059
Bronze00181	.00101	Concrete00143	.00079
Copper00168	.00093	" masonry00120	.00067
German Silver00183	.00102	Granite00084	.00047
Gold00150	.00083	Limestone00080	.00044
Iron, cast, gray00106	.00059	Marble00100	.00056
" wrought00120	.00067	Plaster00166	.00092
" wire00124	.00069	Rubble masonry00063	.00035
Lead00286	.00159	Sandstone00110	.00061
Nickel00126	.00070	Slate00104	.00058
Platinum00090	.00050	Timber		
Platinum-Iridium, 15% Ir	.00081	.00045	Fir	} parallel to fiber	.00037 .00021
Silver00192	.00107	Maple		
Steel, cast00110	.00061	Oak		
" hard00132	.00073	Pine	} perpendicular to fiber00054 .00030
" medium00120	.00067	Fir		
" soft00110	.00061	Maple		
Tin00210	.00117	Oak	} to fiber0054 .0030
Zinc, rolled00311	.00173	Pine		
Miscellaneous Solids			Liquid Substances Volumetric Expansion		
Glass00085	.00047	Alcohol104	.058
Graphite00079	.00044	Acid, nitric110	.061
Gutta-percha05980	.03322	" sulphuric063	.035
Paraffin02785	.01547	Mercury018	.010
Porcelain00036	.00020	Oil, turpentine090	.050

EXPANSION OF WATER, MAXIMUM DENSITY=1

C°	Volume	C°	Volume	C°	Volume	C°	Volume	C°	Volume	C°	Volume
0	1.000126	10	1.000257	30	1.004234	50	1.011877	70	1.022384	90	1.035829
4	1.000000	20	1.001732	40	1.007627	60	1.016954	80	1.029003	100	1.043116

CARNEGIE STEEL COMPANY

EQUIVALENTS OF MEASURE

LENGTHS

1 meter, m = 10 decimeters, dm = 100 centimeters, cm = 1000 millimeters, mm.
 1 meter, m = 0.1 decameter, dkm = 0.01 hectometer, hm = 0.001 kilometer, km.
 1 meter, m = 39.37 inches, U. S. Standard = 39.370113 inches, British Standard.
 1 millimeter, mm = 1000 microns, μ = 0.03937 inch = 39.37 mils.

Meters, m	Inches, in.	Feet, ft.	Yard, yd.	Rods, r.	Chains, ch.	Miles, U. S.		Kilo- meters, km.
						Statute	Nautical	
1	39.37	3.28083	1.09361	0.19884	0.04971	0. ³ / ₁₆ 6214	0. ⁸ / ₁₇ 5396	0.001
0.02540	1	0.08333	0.02778	0. ⁵ / ₁₆ 5051	0. ² / ₅ 1263	0. ⁴ / ₁₅ 1578	0. ⁴ / ₁₃ 171	0. ² / ₅ 2540
0.30480	12	1	0.33333	0.06061	0.01515	0. ³ / ₁₆ 1894	0. ³ / ₁₆ 1645	0. ³ / ₁₆ 3048
0.91440	36	3	1	0.18182	0.04545	0. ³ / ₁₆ 5682	0. ³ / ₁₆ 4934	0. ³ / ₁₆ 9144
5.02921	198	16.5	5.5	1	0.25	0. ⁶ / ₃₂ 3125	0. ² / ₅ 2714	0. ⁵ / ₂₅ 5029
20.1168	792	66	22	4	1	0.01250	0.01085	0.02012
1609.35	63360	5280	1760	320	80	1	0.86839	1.60935
1853.25	72962.5	6080.20	2026.73	368.497	92.1243	1.15155	1	1.85325
1000	39370	3280.83	1093.61	198.838	49.7096	0.62137	0.53959	1

1 yard, U. S. = 1.000029 yards British 1 yard British = 0.999971 yard U. S.
 1 chain, Gunter's = 100 links 1 link = 7.92 inches.
 1 cable length, U. S. = 120 fathoms = 960 spans = 720 feet = 219.457 meters.
 1 league, U. S. = 3 statute miles = 24 furlongs.
 1 international geographical mile = $\frac{1}{45}^{\circ}$ at equator = 7422 m
 = 4.611808 U. S. statute miles.
 1 international nautical mile = $\frac{1}{60}^{\circ}$ at meridian = 1852 m
 = 0.999326 U. S. nautical miles.
 1 U. S. nautical mile = $\frac{1}{60}^{\circ}$ of circumference of sphere whose surface equals
 that of the earth = 6080.27 feet = 1.15155 statute miles = 1853.27 meters.
 1 British nautical mile = 6080.00 feet = 1.15152 statute miles = 1853.19 meters.

SURFACES AND AREAS

1 sq. meter, m² = 100 sq. decimeters, dm² = 10000 sq. centimeters, cm².
 1 sq. meter, m² = 0.01 are, a = 0.0001 hectare, ha.
 1 sq. millimeter, mm² = 0.01 cm² = 0.00155 sq. inch = 1973.5 circular mils.
 1 are, a = 1 sq. decameter, dkm = 0.0247104 acre.

Sq. Meters, m ²	Sq. Inches, sq. in.	Sq. Feet, sq. ft.	Sq. Yards, sq. yd.	Sq. Rods, sq. r.	Acres, A	Hectares, ha.	Sq. Miles, Statute	Sq. Kilo- meters, km ²
1	1550.00	10.7639	1.19599	0.03954	0. ³ / ₁₆ 2471	0.0001	0. ⁶ / ₃₂ 3861	0. ⁵ / ₁ 1
0. ³ / ₁₆ 6452	1	0. ⁵ / ₁₆ 6944	0. ³ / ₁₆ 7716	0. ⁴ / ₁₅ 2551	0. ⁶ / ₁₅ 1594	0. ⁵ / ₁₆ 6452	0. ² / ₅ 2491	0. ³ / ₁₆ 6452
0.09290	144	1	0.11111	0. ³ / ₁₆ 3673	0. ⁴ / ₁₅ 2296	0. ⁵ / ₁₆ 9290	0. ³ / ₁₆ 3587	0. ⁵ / ₁₆ 9290
0.83613	1296	9	1	0.03306	0. ³ / ₁₆ 2066	0. ⁴ / ₁₅ 8361	0. ³ / ₁₆ 3228	0. ⁶ / ₁₆ 8361
25.2930	39204	272.25	30.25	1	0.00625	0. ⁵ / ₁₆ 2529	0. ³ / ₁₆ 9766	0. ⁴ / ₁₅ 2529
4046.87	6272640	43560	4840	160	1	0.40469	0. ² / ₅ 1563	0. ² / ₅ 4047
10000	15499969	107639	11959.9	395.366	2.47104	1	0. ⁶ / ₃₂ 3861	0.01
2589999		27878400	3097600	102400	640	259.000	1	2.59000
1000000		10763867	1195985	39536.6	247.104	100	0.38610	1

1 sq. rod, sq. pole, or sq. perch = 625 sq. links = $\frac{1}{160}$ acre.
 1 sq. chain, Gunter's = 16 sq. rods = $\frac{1}{10}$ acre.
 1 acre = 4 sq. rods = 160 sq. rods. Square of 1 acre = 208.7103 feet square.

Notations $\frac{2}{5}$, $\frac{3}{16}$, $\frac{4}{15}$, etc., indicate that the $\frac{2}{5}$, $\frac{3}{16}$, $\frac{4}{15}$, etc., are to be replaced by 2, 3, 4, etc., ciphers.

EXAMPLE—1 sq. rod = 0.⁵/₁₆9766 = 0.00009766 sq. miles.

MEASURES AND WEIGHTS

EQUIVALENTS OF MEASURE

VOLUME AND CAPACITY

1 cu. meter, m³ = 1000 cu. decimeter, dm³ = 1000000 cu. centimeters, cm³.
 1 liter, l = 10 deciliters, dl = 100 centiliters, cl = 1000 milliliters, ml
 = 1000 cu. centimeters, cm³, or cc.
 1 liter, l = 0.1 decaliter, dkl = 0.01 hectoliter, hl = 1 cu. decimeter, dm³.

Cubic Decimeter, dm ³ , l	Cubic Inches, cu. in.	Cubic Feet, cu. ft.	Cubic Yards, cu. yd.	U. S. Quarts		U. S. Gallons		U. S. Bushels, bu.
				Liquid, l. qt.	Dry, d. qt.	Liquid, l. gal.	Dry, d. gal.	
1	61.0234	0.03531	0. ² / ₂₇ 1308	1.05668	0.90808	0.26417	0.22702	0.02838
0.01639	1	0. ³ / ₅₇₈₇	0. ⁴ / ₂₁₄₃	0.01732	0.01488	0. ² / ₄₃₂₉	0. ³ / ₃₇₂₀	0. ³ / ₄₆₅₀
28.3170	1728	1	0.03704	29.9221	25.7140	7.48055	6.42851	0.80356
764.559	46656	27	1	807.896	694.279	201.974	173.570	21.6962
0.94636	57.75	0.03342	0. ² / ₁₂₃₈	1	0.85937	0.25	0.21484	0.02686
1.10123	67.2006	0.03889	0. ² / ₁₄₄₀	1.16365	1	0.29091	0.25	0.03125
3.78543	231	0.13368	0. ² / ₄₉₅₁	4	3.43747	1	0.85937	0.10742
4.40492	268.803	0.15556	0. ² / ₅₇₆₁	4.65460	4	1.16365	1	0.125
35.2393	2150.42	1.24446	0.04609	37.2368	32	9.30920	8	1

U. S. Dry Measure: 1 bushel = 4 pecks = 8 gallons = 32 quarts = 64 pints.
 U. S. Liquid Measure: 1 gallon = 4 quarts = 8 pints = 32 gills = 128 fluid ounces.
 U. S. Apoth. Measure: 1 fl. ounce, f³/₅ = 8 fl. drams, f³/₅ = 480 minims, m³
 = 29.574 cu. cm³.
 British Imperial gallon dry and liquid measure = 1.03202 U. S. dry gal.
 = 1.20091 U. S. liquid gal.
 British Imperial gallon = 277.410 cu. in. = 4545.9631 cm³.
 Weight of water at maximum density, 4°C, 45° Lat., and sea level.
 1 cu. ft. = 62.4283 lbs. av. = 28.3170 kg. 1 cu. in. = 0.57804 oz. av. = 16.3872 g.
 1 gal., U. S. liquid = 8.34545 lbs. av. = 3.78543 kg.
 1 gal., British Imperial = 10.0221 lbs. av. = 4.5459631 kg.

MASSES AND WEIGHTS

1 gram, g = 10 decigrams, dg = 100 centigrams, cg = 1000 milligrams, mg.
 1 gram, g = 0.1 decagram, dkg = 0.01 hectogram, hg = 0.001 kilogram, kg.
 1 kilogram, kg = 1 cu. decimeter of water or liter, 4°C, 45° Lat. and sea level
 = 15432.35639 grains, U. S. and British Standard.

Kilo- grams, kg.	Grains, gr.	Ounces		Pounds		Tons		
		Troy, oz. t.	Avoir., oz. av.	Troy, lb. t.	Avoir., lb. av.	Net, Short, 2000 lbs.	Gross, Long, 2240 lbs.	Metric, 1000 kg.
1	15432.4	32.1507	35.2740	2.67923	2.20462	0. ² / ₉ 1102	0. ² / ₉ 9842	0.001
0. ⁴ / ₆₄₈₀	1	0. ² / ₂₀₈₃	0. ² / ₂₂₈₆	0. ³ / ₁₇₃₆	0. ³ / ₁₄₂₉	0. ⁷ / ₇₁₄₃	0. ⁷ / ₆₃₇₈	0. ⁷ / ₆₄₈₀
0.03110	480	1	1.09714	0.08333	0.06857	0. ³ / ₃₄₂₉	0. ⁴ / ₃₀₆₁	0. ⁴ / ₃₁₁₀
0.02835	437.5	0.91146	1	0.07595	0.06250	0. ⁴ / ₃₁₂₅	0. ⁴ / ₂₇₉₀	0. ⁴ / ₂₈₃₅
0.37324	5760	12	13.1657	1	0.82286	0. ³ / ₄₁₁₄	0. ³ / ₃₆₇₄	0. ³ / ₃₇₃₂
0.45359	7000	14.5833	16	1.21528	1	0.00050	0. ³ / ₄₄₆₄	0. ³ / ₄₅₃₆
907.185	14000000	29166.7	32000	2430.56	2000	1	0.89286	0.90719
1016.05	15680000	32666.7	35840	2722.22	2240	1.12	1	1.01605
1000	15432356	32150.7	35274.0	2679.23	2204.62	1.10231	0.98421	1

1 ounce avoirdupois = 16 drams, avoirdupois. 1 ounce troy = 20 pennyweight, dwt.
 1 ounce apothecary, ³/₅ = 8 drams, ³/₅ = 24 scruples, ³/₅ = 480 grains, gr = 31.1035 g.
 1 hundredweight = 1/20 long ton = 4 quarters = 8 stone = 112 lbs. = 50.8024 kg.

Notations ²/₉, ³/₅, ⁴/₆, etc., indicate that the ²/₉, ³/₅, ⁴/₆, etc., are to be replaced by 2, 3, 4, etc., ciphers.

EXAMPLE—1 grain = 0.²/₂₀₈₃ = 0.002083 oz. t. 1 grain = 0.⁴/₆₄₈₀ = 0.0006480 kg.

CARNEGIE STEEL COMPANY

EQUIVALENTS OF MEASURE

FORCES OR WEIGHTS PER UNITS OF LENGTH, LINEAR WEIGHTS

1 dyne per centimeter = 0.00101979 g/cm = 0.000183719 poundal/in.
 1 gram per centimeter = 980.5966 dynes/cm = 0.180154 poundal/in.
 1 poundal per inch = 5443.11 dynes/cm = 5.55081 g/cm = 0.0310832 pound/in.

Grams per Centimeter g/cm	Grains per Inch, gr./in.	Pounds per Inch, lb./in.	Pounds per Foot, lb./ft.	Pounds per Yard, lb./yd.	Kilograms per Meter, kg/m	Net Tons, 2000 lbs., per Mile	Gross Tons, 2240 lbs., per Mile	Metric Tons, 1000 kg, per Kilometer
1	39.1983	0.55600	0.06720	0.20159	0.10	0.17740	0.15839	0.10
0.02551	1	0.51429	0.07174	0.5143	0.52551	0.54526	0.54041	0.52551
178.579	7000	1	12	36	17.8579	31.6800	28.2857	17.8579
14.8816	583.333	0.08333	1	3	1.48816	2.64000	2.35714	1.48816
4.96054	194.444	0.02778	0.33333	1	0.49605	0.88000	0.78571	0.49605
10	391.983	0.05600	0.67197	2.01591	1	1.77400	1.58393	1
5.63698	220.960	0.03157	0.37879	1.13636	0.56370	1	0.89286	0.56370
6.31342	247.475	0.03535	0.42424	1.27273	0.63134	1.12	1	0.63134
10	391.983	0.05600	0.67197	2.01591	1	1.77400	1.58393	1

FORCES OR WEIGHTS PER UNITS OF AREA, PRESSURE

1 dyne per sq. centimeter = 0.00101979 g/cm² = 0.000466646 poundals/in.².
 1 gram per sq. centimeter = 980.5966 dynes/cm² = 0.457592 poundals/in.².
 1 poundal per sq. inch = 2142.95 dynes/cm² = 2.18536 g/cm² = 0.0310832 pound/in.².

Kilograms per Sq. Centimeter, kg/cm ²	Pounds per Sq. Inch, lb./in. ²	Pounds per Sq. Foot, lb./ft. ²	Net Tons, 2000 lbs., per Sq. Foot	Atmospheres, Standard, 760 mm	Columns of Mercury, Hg. 13.59593 Sp. G.		Columns of Water, Max. Density 4° C	
					Milli-meters	Inches	Meters	Feet
1	14.2234	2048.17	1.02408	0.96778	735.514	28.9572	10	32.8083
0.07031	1	144	0.07200	0.06804	51.7116	2.03588	0.70307	2.30665
0.54882	0.56944	1	0.00050	0.54725	0.35911	0.01414	0.54882	0.01602
0.97648	13.8889	2000	1	0.94502	718.216	28.2762	9.76482	32.0367
1.03329	14.6969	2116.35	1.05818	1	760	29.9212	10.3329	33.9006
0.51360	0.01934	2.78468	1.51392	0.51316	1	0.03937	0.01360	0.04461
0.03453	0.49119	70.7310	0.03537	0.03342	25.4001	1	0.34534	1.13299
0.10	1.42234	204.817	0.10241	0.09678	73.5514	2.89572	1	3.28083
0.03048	0.43353	62.4283	0.03121	0.02950	22.4185	0.88262	0.30480	1

FORCES OR WEIGHTS PER UNITS OF VOLUME, DENSITY

1 dyne per cu. centimeter = 0.00101979 gram/cm³ = 0.00118528 poundals/in.³.
 1 gram per cu. centimeter = 980.5966 dynes/cm³ = 1.162283 poundals/in.³.
 1 poundal per cu. inch = 843.683 dynes/cm³ = 0.860378 g/cm³ = 0.0310832 pound/in.³.

Grams per Cu. Centimeter, g/cm ³	Pounds per Cu. Inch, lb./in. ³	Pounds per Cu. Foot, lb./ft. ³	Pounds per Cu. Yard, lb./yd. ³	Kilograms per Cu. Meter, kg/m ³	Pounds per Bushel, U. S.	Pounds per Gallon, Dry, U. S.	Pounds per Gallon, Liquid, U. S.	Kilograms per Hectoliter, kg/hl
1	0.03613	62.4283	1685.56	1000	77.6893	9.71116	8.34545	100
27.6797	1	1728	46656	27679.7	2150.42	268.803	231	2767.97
0.01602	0.55787	1	27	16.0184	1.24446	0.15556	0.13368	1.60184
0.55933	0.52143	0.03704	1	0.59327	0.04609	0.55762	0.54951	0.05933
0.001	0.53613	0.06243	1.68556	1	0.07769	0.59711	0.58345	0.10
0.01287	0.54650	0.80356	21.6962	12.8718	1	0.125	0.10742	1.28718
0.10297	0.53720	6.42851	173.570	102.974	8	1	0.85937	10.2974
0.11983	0.54329	7.48052	201.974	119.826	9.30920	1.16365	1	11.9826
0.01	0.53613	0.62428	16.8557	10	0.77689	0.09711	0.08345	1

Notations $\frac{2}{0}, \frac{3}{0}, \frac{4}{0}$, etc., indicate that the $\frac{2}{0}, \frac{3}{0}, \frac{4}{0}$, etc., are to be replaced by 2, 3, 4, etc. ciphers. EXAMPLE—1 kg/m³ = 0.53613 = 0.00003613 lb./in.³.

MEASURES AND WEIGHTS

EQUIVALENTS OF MEASURE

ENERGY, WORK, HEAT

1 dyne-centimeter=1 erg=0.00101979 gram-centimeter=0.⁷37612 foot-pound.

1 gram-centimeter=980.5966 ergs=0.⁴7233 foot-pound.

1 foot-pound=13557300 ergs=13825.5 gram-centimeters.

Kilogram-meters, kg-m	Foot-pounds, ft.-lbs.	Horsepower-hour		Poncelet-hours, 100 kg-m-h	Kilowatt-hours, kw-h	Joules, 10 ⁷ ergs, j-s	Thermal Units	
		U. S., H. P.-h	Metric, 75 kg-m-h				B. T. U. b. t. u.	Calorie, kg-cal
1	7.23300	0. ⁵ 3653	0. ⁵ 3704	0. ⁵ 2778	0. ⁵ 2724	9.80597	0. ² 9296	0. ² 2342
0.13826	1	0. ⁵ 5051	0. ⁵ 5121	0. ⁵ 3840	0. ⁵ 3766	1.35573	0. ² 1285	0. ² 3239
273745	1980000	1	1.01387	0.76040	0.74565	2684340	2544.65	641.240
270000	1952910	0.98632	1	0.75	0.73545	2647610	2509.83	632.467
360000	2603880	1.31509	1.33333	1	0.98060	3530147	3346.44	843.289
367123	2655403	1.34111	1.35972	1.01979	1	3600000	3412.66	859.975
0.10198	0.73761	0. ⁵ 3725	0. ⁵ 3777	0. ⁵ 2833	0. ⁵ 2778	1	0. ² 9480	0. ² 2389
107.577	778.104	0. ⁵ 3930	0. ⁵ 3984	0. ⁵ 2988	0. ⁵ 2930	1054.90	1	0.25200
426.900	3087.77	0. ⁵ 1559	0. ⁵ 1581	0. ⁵ 1186	0. ⁵ 1163	4186.17	3.96832	1

POWER, RATE OF ENERGY AND HEAT

1 erg per sec.=1 dyne-cm./sec.=0.00101979 gram-cm./sec.=0.⁷37612 foot-pounds/sec.

1 gram-centimeter per second=980.5966 ergs/sec.=0.⁴7233 foot-pounds/sec.

1 foot-pound per second=13557300 ergs/sec=13825.5 gram-cm./sec.

Kilogram-meters per Second, kg-m/s	Foot-pounds per Second, ft.-lbs./s	Horsepower		Poncelet, 100 kg-m/s	Kilowatt, kw.	Watts, 10 ⁷ ergs/s	Thermal Units per Sec.	
		U. S., 550 ft.-lbs./s	Metric, 75 kg-m/s				B. T. U. btu/s	Calorie kg-cal/s
1	7.23300	0.01315	0.01333	0.01	0. ² 9806	9.80597	0. ² 9296	0. ² 2342
0.13826	1	0. ² 1818	0. ² 1843	0. ⁵ 1383	0. ² 1356	1.35573	0. ² 1285	0. ² 3237
76.0404	550	1	1.01387	0.76040	0.74565	745.650	0.70685	0.17812
75	542.475	0.98632	1	0.75	0.73545	735.448	0.69718	0.17569
100	723.300	1.31509	1.33333	1	0.98060	980.597	0.92957	0.23425
101.979	737.612	1.34111	1.35972	1.01979	1	1000	0.94796	0.23888
0.10198	0.73761	0. ² 1341	0. ² 1360	0. ⁵ 1020	0.001	1	0. ² 9480	0. ² 2389
107.577	778.104	1.41474	1.43436	1.07577	1.05490	1054.90	1	0.25200
426.900	3087.77	5.61412	5.69200	4.26900	4.18617	4186.17	3.96832	1

VELOCITIES AND ACCELERATIONS

1 kine=1 centimeter per second=0.0328083 foot per second.

1 radian per second=57.2958 degrees per sec.=0.159155 revolutions per sec.

1 gravity=980.5966 centimeters per sec. per sec.=32.1717 feet per sec. per sec.

Meters per Second, m/s	Feet per Second, ft./s	Miles per Hour, M/h	Knots per Hour, U. S.	Kilometers Hour, km/h	Meter per sec/sec m/s ²	Feet per sec/sec ft./s ²	Miles per hour/sec M/h-s	Kilometer per hour/sec km/h-s
1	3.28083	2.23693	1.94254	3.6				
0.30480	1	0.68182	0.59209	1.09728				
0.44704	1.46667	1	0.86839	1.60935				
0.51479	1.68894	1.15155	1	1.85325				
0.27778	0.91134	0.62137	0.53959	1				
					1	3.28083	2.23693	3.6
					0.30480	1	0.68182	1.09728
					0.44704	1.46667	1	1.60935
					0.27778	0.91134	0.62137	1

Notations $\frac{2}{0}$, $\frac{3}{0}$, $\frac{4}{0}$, etc., indicate that the $\frac{2}{0}$, $\frac{3}{0}$, $\frac{4}{0}$, etc., are to be replaced by 2, 3, 4, etc., ciphers. EXAMPLE—1 Calorie=0.²1163=0.001163 kilowatt-hours.

CARNEGIE STEEL COMPANY

METRIC CONVERSION TABLES
INCHES TO CENTIMETERS—1 in.=2.540005 cm

Units Tens	0	1	2	3	4	5	6	7	8	9
0		2.540	5.080	7.620	10.160	12.700	15.240	17.780	20.320	22.860
1	25.400	27.940	30.480	33.020	35.560	38.100	40.640	43.180	45.720	48.260
2	50.800	53.340	55.880	58.420	60.960	63.500	66.040	68.580	71.120	73.660
3	76.200	78.740	81.280	83.820	86.360	88.900	91.440	93.980	96.520	99.060
4	101.600	104.140	106.680	109.220	111.760	114.300	116.840	119.380	121.920	124.460
5	127.000	129.540	132.080	134.620	137.160	139.700	142.240	144.780	147.320	149.860
6	152.400	154.940	157.480	160.020	162.560	165.100	167.640	170.180	172.720	175.260
7	177.800	180.340	182.880	185.420	187.960	190.500	193.040	195.580	198.120	200.660
8	203.200	205.740	208.280	210.820	213.360	215.900	218.440	220.980	223.520	226.060
9	228.600	231.140	233.680	236.220	238.760	241.300	243.840	246.380	248.920	251.460

INCHES² TO CENTIMETERS²—1 in.²=6.451625 cm²

Units Tens	0	1	2	3	4	5	6	7	8	9
0		6.452	12.903	19.355	25.807	32.258	38.710	45.161	51.613	58.065
1	64.516	70.968	77.420	83.871	90.323	96.774	103.226	109.678	116.129	122.581
2	129.033	135.484	141.936	148.387	154.839	161.291	167.742	174.194	180.646	187.097
3	193.549	200.000	206.452	212.904	219.355	225.807	232.259	238.710	245.162	251.613
4	258.065	264.517	270.968	277.420	283.872	290.323	296.775	303.226	309.678	316.130
5	322.581	329.033	335.485	341.936	348.388	354.839	361.291	367.743	374.194	380.646
6	387.098	393.549	400.001	406.452	412.904	419.356	425.807	432.259	438.711	445.162
7	451.614	458.065	464.517	470.969	477.420	483.872	490.324	496.775	503.227	509.678
8	516.130	522.582	529.033	535.485	541.937	548.388	554.840	561.291	567.743	574.195
9	580.646	587.098	593.550	600.001	606.453	612.904	619.356	625.808	632.259	638.711

INCHES³ TO CENTIMETERS³—1 in.³=16.38716 cm³

Units Tens	0	1	2	3	4	5	6	7	8	9
0		16.39	32.77	49.16	65.55	81.94	98.32	114.71	131.10	147.48
1	163.87	180.26	196.65	213.03	229.42	245.81	262.19	278.58	294.97	311.36
2	327.74	344.13	360.52	376.90	393.29	409.68	426.07	442.45	458.84	475.23
3	491.61	508.00	524.39	540.78	557.16	573.55	589.94	606.32	622.71	639.10
4	655.49	671.87	688.26	704.65	721.04	737.42	753.81	770.20	786.58	802.97
5	819.36	835.75	852.13	868.52	884.91	901.29	917.68	934.07	950.46	966.84
6	983.23	999.62	1016.00	1032.39	1048.78	1065.17	1081.55	1097.94	1114.33	1130.71
7	1147.10	1163.49	1179.88	1196.26	1212.65	1229.04	1245.42	1261.81	1278.20	1294.59
8	1310.97	1327.36	1343.75	1360.13	1376.52	1392.91	1409.30	1425.68	1442.07	1458.46
9	1474.84	1491.23	1507.62	1524.01	1540.39	1556.78	1573.17	1589.55	1605.94	1622.33

INCHES⁴ TO CENTIMETERS⁴—1 in.⁴=41.62347 cm⁴

Units Tens	0	1	2	3	4	5	6	7	8	9
0		41.62	83.25	124.87	166.49	208.12	249.74	291.36	332.99	374.61
1	416.23	457.86	499.48	541.11	582.73	624.35	665.98	707.60	749.22	790.85
2	832.47	874.09	915.72	957.34	998.96	1040.59	1082.21	1123.83	1165.46	1207.08
3	1248.70	1290.33	1331.95	1373.57	1415.20	1456.82	1498.44	1540.07	1581.69	1623.32
4	1664.94	1706.56	1748.19	1789.81	1831.43	1873.06	1914.68	1956.30	1997.93	2039.55
5	2081.17	2122.80	2164.42	2206.04	2247.67	2289.29	2330.91	2372.54	2414.16	2455.78
6	2497.41	2539.03	2580.66	2622.28	2663.90	2705.53	2747.15	2788.77	2830.40	2872.02
7	2913.64	2955.27	2996.89	3038.51	3080.14	3121.76	3163.38	3205.01	3246.63	3288.25
8	3329.88	3371.50	3413.12	3454.75	3496.37	3537.99	3579.62	3621.24	3662.87	3704.49
9	3746.11	3787.74	3829.36	3870.98	3912.61	3954.23	3995.85	4037.48	4079.10	4120.72

MEASURES AND WEIGHTS

METRIC CONVERSION TABLES
CENTIMETERS TO INCHES—1 cm=0.3937 in.

Units Tens	0	1	2	3	4	5	6	7	8	9
0		0.3937	0.7874	1.1811	1.5748	1.9685	2.3622	2.7559	3.1496	3.5433
1	3.9370	4.3307	4.7244	5.1181	5.5118	5.9055	6.2992	6.6929	7.0866	7.4803
2	7.8740	8.2677	8.6614	9.0551	9.4488	9.8425	10.2362	10.6299	11.0236	11.4173
3	11.8110	12.2047	12.5984	12.9921	13.3858	13.7795	14.1732	14.5669	14.9606	15.3543
4	15.7480	16.1417	16.5354	16.9291	17.3228	17.7165	18.1102	18.5039	18.8976	19.2913
5	19.6850	20.0787	20.4724	20.8661	21.2598	21.6535	22.0472	22.4409	22.8346	23.2283
6	23.6220	24.0157	24.4094	24.8031	25.1968	25.5905	25.9842	26.3779	26.7716	27.1653
7	27.5590	27.9527	28.3464	28.7401	29.1338	29.5275	29.9212	30.3149	30.7086	31.1023
8	31.4960	31.8897	32.2834	32.6771	33.0708	33.4645	33.8582	34.2519	34.6456	35.0393
9	35.4330	35.8267	36.2204	36.6141	37.0078	37.4015	37.7952	38.1889	38.5826	38.9763

CENTIMETERS² TO INCHES²—1 cm²=0.15499969 in.².

Units Tens	0	1	2	3	4	5	6	7	8	9
0		0.1550	0.3100	0.4650	0.6200	0.7750	0.9300	1.0850	1.2400	1.3950
1	1.5500	1.7050	1.8600	2.0150	2.1700	2.3250	2.4800	2.6350	2.7900	2.9450
2	3.1000	3.2550	3.4100	3.5650	3.7200	3.8750	4.0300	4.1850	4.3400	4.4950
3	4.6500	4.8050	4.9600	5.1150	5.2700	5.4250	5.5800	5.7350	5.8900	6.0450
4	6.2000	6.3550	6.5100	6.6650	6.8200	6.9750	7.1300	7.2850	7.4400	7.5950
5	7.7500	7.9050	8.0600	8.2150	8.3700	8.5250	8.6800	8.8350	8.9900	9.1450
6	9.3000	9.4550	9.6100	9.7650	9.9200	10.0750	10.2300	10.3850	10.5400	10.6950
7	10.8500	11.0050	11.1600	11.3150	11.4700	11.6250	11.7800	11.9350	12.0900	12.2450
8	12.4000	12.5550	12.7100	12.8650	13.0200	13.1750	13.3300	13.4850	13.6400	13.7950
9	13.9500	14.1050	14.2600	14.4150	14.5700	14.7250	14.8800	15.0350	15.1900	15.3450

CENTIMETERS³ TO INCHES³—1 cm³=0.0610234 in.³.

Units Tens	0	1	2	3	4	5	6	7	8	9
0		0.06102	0.12205	0.18307	0.24409	0.30512	0.36614	0.42716	0.48819	0.54921
1	0.61023	0.67126	0.73228	0.79330	0.85433	0.91535	0.97637	1.03740	1.09842	1.15944
2	1.22047	1.28149	1.34251	1.40354	1.46456	1.52559	1.58661	1.64763	1.70866	1.76968
3	1.83070	1.89173	1.95275	2.01377	2.07480	2.13582	2.19684	2.25787	2.31889	2.37991
4	2.44094	2.50196	2.56298	2.62401	2.68503	2.74605	2.80708	2.86810	2.92912	2.99015
5	3.05117	3.11219	3.17322	3.23424	3.29526	3.35629	3.41731	3.47833	3.53936	3.60038
6	3.66140	3.72243	3.78345	3.84447	3.90550	3.96652	4.02754	4.08857	4.14959	4.21061
7	4.27164	4.33266	4.39368	4.45471	4.51573	4.57675	4.63778	4.69880	4.75983	4.82085
8	4.88187	4.94290	5.00392	5.06494	5.12597	5.18699	5.24801	5.30904	5.37006	5.43108
9	5.49211	5.55313	5.61415	5.67518	5.73620	5.79722	5.85825	5.91927	5.98029	6.04132

CENTIMETERS⁴ TO INCHES⁴—1 cm⁴=0.0240249 in.⁴.

Units Tens	0	1	2	3	4	5	6	7	8	9
0		0.02402	0.04805	0.07207	0.09610	0.12012	0.14415	0.16817	0.19220	0.21622
1	0.24025	0.26427	0.28830	0.31233	0.33635	0.36037	0.38440	0.40842	0.43245	0.45647
2	0.48050	0.50452	0.52855	0.55257	0.57660	0.60062	0.62465	0.64867	0.67270	0.69672
3	0.72075	0.74477	0.76880	0.79282	0.81685	0.84087	0.86490	0.88892	0.91295	0.93697
4	0.96100	0.98502	1.00905	1.03307	1.05710	1.08112	1.10515	1.12917	1.15320	1.17722
5	1.20125	1.22527	1.24930	1.27332	1.29734	1.32137	1.34539	1.36942	1.39344	1.41747
6	1.44149	1.46552	1.48954	1.51357	1.53759	1.56162	1.58564	1.60967	1.63369	1.65772
7	1.68174	1.70577	1.72979	1.75382	1.77784	1.80187	1.82589	1.84992	1.87394	1.89797
8	1.92199	1.94602	1.97004	1.99407	2.01809	2.04212	2.06614	2.09017	2.11419	2.13822
9	2.16224	2.18627	2.21029	2.23432	2.25834	2.28237	2.30639	2.33042	2.35444	2.37847

CARNEGIE STEEL COMPANY

METRIC CONVERSION TABLES
FEET TO METERS—1 ft.=0.3048006 m

Units Tens	0	1	2	3	4	5	6	7	8	9
0		0.3048	0.6096	0.9144	1.2192	1.5240	1.8288	2.1336	2.4384	2.7432
1	3.0480	3.3528	3.6576	3.9624	4.2672	4.5720	4.8768	5.1816	5.4864	5.7912
2	6.0960	6.4008	6.7056	7.0104	7.3152	7.6200	7.9248	8.2296	8.5344	8.8392
3	9.1440	9.4488	9.7536	10.0584	10.3632	10.6680	10.9728	11.2776	11.5824	11.8872
4	12.1920	12.4968	12.8016	13.1064	13.4112	13.7160	14.0208	14.3256	14.6304	14.9352
5	15.2400	15.5448	15.8496	16.1544	16.4592	16.7640	17.0688	17.3736	17.6784	17.9832
6	18.2880	18.5928	18.8976	19.2024	19.5072	19.8120	20.1168	20.4216	20.7264	21.0312
7	21.3360	21.6408	21.9456	22.2504	22.5552	22.8600	23.1648	23.4696	23.7744	24.0792
8	24.3840	24.6888	24.9936	25.2984	25.6032	25.9080	26.2128	26.5176	26.8224	27.1272
9	27.4320	27.7368	28.0416	28.3464	28.6512	28.9560	29.2608	29.5656	29.8704	30.1752

POUNDS PER FOOT TO KILOGRAMS PER METER—1 lb./ft.=1.488161 kg/m

Units Tens	0	1	2	3	4	5	6	7	8	9
0		1.488	2.976	4.464	5.953	7.441	8.929	10.417	11.905	13.393
1	14.882	16.370	17.858	19.346	20.834	22.322	23.811	25.299	26.787	28.275
2	29.763	31.251	32.740	34.228	35.716	37.204	38.692	40.180	41.669	43.157
3	44.645	46.133	47.621	49.109	50.597	52.086	53.574	55.062	56.550	58.038
4	59.526	61.015	62.503	63.991	65.479	66.967	68.455	69.944	71.432	72.920
5	74.408	75.896	77.384	78.873	80.361	81.849	83.337	84.825	86.313	87.801
6	89.290	90.778	92.266	93.754	95.242	96.730	98.219	99.707	101.195	102.683
7	104.171	105.659	107.148	108.636	110.124	111.612	113.100	114.588	116.077	117.565
8	119.053	120.541	122.029	123.517	125.006	126.494	127.982	129.470	130.958	132.446
9	133.934	135.423	136.911	138.399	139.887	141.375	142.863	144.352	145.840	147.328

POUNDS PER SQ. INCH TO KG. PER SQ. CM.—1 lb./in.²=0.0703067 kg/cm²

Units Tens	0	1	2	3	4	5	6	7	8	9
0		0.07031	0.14061	0.21092	0.28123	0.35153	0.42184	0.49215	0.56245	0.63276
1	0.70307	0.77337	0.84368	0.91399	0.98429	1.05460	1.12491	1.19521	1.26552	1.33583
2	1.40613	1.47644	1.54675	1.61705	1.68736	1.75767	1.82797	1.89828	1.96859	2.03889
3	2.10920	2.17951	2.24981	2.32012	2.39043	2.46073	2.53104	2.60135	2.67165	2.74196
4	2.81227	2.88257	2.95288	3.02319	3.09349	3.16380	3.23411	3.30441	3.37472	3.44503
5	3.51534	3.58564	3.65595	3.72626	3.79656	3.86687	3.93718	4.00748	4.07779	4.14810
6	4.21840	4.28871	4.35902	4.42932	4.49963	4.56994	4.64024	4.71055	4.78086	4.85116
7	4.92147	4.99178	5.06208	5.13239	5.20270	5.27300	5.34331	5.41362	5.48392	5.55423
8	5.62454	5.69484	5.76515	5.83546	5.90576	5.97607	6.04638	6.11668	6.18699	6.25730
9	6.32760	6.39791	6.46822	6.53852	6.60883	6.67914	6.74944	6.81975	6.89006	6.96036

INCH-POUNDS TO KILOGRAM-CENTIMETERS—1 in.-lb.=1.152127 kg-cm

Units Tens	0	1	2	3	4	5	6	7	8	9
0		1.152	2.304	3.456	4.609	5.761	6.913	8.065	9.217	10.369
1	11.521	12.673	13.826	14.978	16.130	17.282	18.434	19.586	20.738	21.890
2	23.043	24.195	25.347	26.499	27.651	28.803	29.955	31.107	32.260	33.412
3	34.564	35.716	36.868	38.020	39.172	40.324	41.477	42.629	43.781	44.933
4	46.085	47.237	48.389	49.541	50.694	51.846	52.998	54.150	55.302	56.454
5	57.606	58.758	59.911	61.063	62.215	63.367	64.519	65.671	66.823	67.975
6	69.128	70.280	71.432	72.584	73.736	74.888	76.040	77.193	78.345	79.497
7	80.649	81.801	82.953	84.105	85.257	86.410	87.562	88.714	89.866	91.018
8	92.170	93.322	94.474	95.627	96.779	97.931	99.083	100.235	101.387	102.539
9	103.691	104.844	105.996	107.148	108.300	109.452	110.604	111.756	112.908	114.061

MEASURES AND WEIGHTS

METRIC CONVERSION TABLES

METERS TO FEET—1 m=3.2808333 ft.

Units Tens	0	1	2	3	4	5	6	7	8	9
0		3.281	6.562	9.843	13.123	16.404	19.685	22.966	26.247	29.528
1	32.808	36.089	39.370	42.651	45.932	49.213	52.493	55.774	59.055	62.336
2	65.617	68.898	72.178	75.459	78.740	82.021	85.302	88.583	91.863	95.144
3	98.425	101.706	104.987	108.268	111.548	114.829	118.110	121.391	124.672	127.953
4	131.233	134.514	137.795	141.076	144.357	147.638	150.918	154.199	157.480	160.761
5	164.042	167.323	170.603	173.884	177.165	180.446	183.727	187.008	190.288	193.569
6	196.850	200.131	203.412	206.693	209.973	213.254	216.535	219.816	223.097	226.378
7	229.658	232.939	236.220	239.501	242.782	246.063	249.343	252.624	255.905	259.186
8	262.467	265.748	269.028	272.309	275.590	278.871	282.152	285.433	288.713	291.994
9	295.275	298.556	301.837	305.118	308.398	311.679	314.960	318.241	321.522	324.803

KILOGRAMS PER METER TO POUNDS PER FOOT—1 kg/m=0.67197 lb./ft.

Units Tens	0	1	2	3	4	5	6	7	8	9
0		0.6720	1.3439	2.0159	2.6879	3.3599	4.0318	4.7038	5.3758	6.0477
1	6.7197	7.3917	8.0636	8.7356	9.4076	10.0796	10.7515	11.4235	12.0955	12.7674
2	13.4394	14.1114	14.7833	15.4553	16.1273	16.7993	17.4712	18.1432	18.8152	19.4871
3	20.1591	20.8311	21.5030	22.1750	22.8470	23.5190	24.1909	24.8629	25.5349	26.2068
4	26.8788	27.5508	28.2227	28.8947	29.5667	30.2387	30.9106	31.5826	32.2546	32.9265
5	33.5985	34.2705	34.9424	35.6144	36.2864	36.9584	37.6303	38.3022	38.9743	39.6462
6	40.3182	40.9902	41.6621	42.3341	43.0061	43.6781	44.3500	45.0220	45.6940	46.3659
7	47.0379	47.7099	48.3818	49.0538	49.7258	50.3978	51.0697	51.7417	52.4137	53.0856
8	53.7576	54.4296	55.1015	55.7735	56.4455	57.1175	57.7894	58.4614	59.1334	59.8053
9	60.4773	61.1493	61.8212	62.4932	63.1652	63.8372	64.5091	65.1811	65.8531	66.5250

KG. PER SQ. CM. TO POUNDS PER SQ. INCH—1 kg/cm²=14.2234 lbs./in.²

Units Tens	0	1	2	3	4	5	6	7	8	9
0		14.22	28.45	42.67	56.89	71.12	85.34	99.56	113.79	128.01
1	142.23	156.46	170.68	184.90	199.13	213.35	227.57	241.80	256.02	270.24
2	284.47	298.69	312.91	327.14	341.36	355.59	369.81	384.03	398.26	412.48
3	426.70	440.93	455.15	469.37	483.60	497.82	512.04	526.27	540.49	554.71
4	568.94	583.16	597.38	611.61	625.83	640.05	654.28	668.50	682.72	696.95
5	711.17	725.39	739.62	753.84	768.06	782.29	796.51	810.73	824.96	839.18
6	853.40	867.63	881.85	896.07	910.30	924.52	938.74	952.97	967.19	981.41
7	995.64	1009.86	1024.08	1038.31	1052.53	1066.76	1080.98	1095.20	1109.43	1123.65
8	1137.87	1152.10	1166.32	1180.54	1194.77	1208.99	1223.21	1237.44	1251.66	1265.88
9	1280.11	1294.33	1308.55	1322.78	1337.00	1351.22	1365.45	1379.67	1393.89	1408.12

KILOGRAM-CENTIMETERS TO INCH-POUNDS—1 kg/cm=0.86796 in./lb.

Units Tens	0	1	2	3	4	5	6	7	8	9
0		0.8680	1.7359	2.6039	3.4718	4.3398	5.2078	6.0757	6.9437	7.8116
1	8.6796	9.5476	10.4155	11.2835	12.1514	13.0194	13.8874	14.7553	15.6233	16.4912
2	17.3592	18.2272	19.0951	19.9631	20.8310	21.6990	22.5670	23.4349	24.3029	25.1708
3	26.0388	26.9068	27.7747	28.6427	29.5106	30.3786	31.2466	32.1145	32.9825	33.8504
4	34.7184	35.5864	36.4543	37.3223	38.1902	39.0582	39.9262	40.7941	41.6621	42.5300
5	43.3980	44.2660	45.1339	46.0019	46.8698	47.7378	48.6058	49.4737	50.3417	51.2096
6	52.0776	52.9456	53.8135	54.6815	55.5494	56.4174	57.2854	58.1533	59.0213	59.8892
7	60.7572	61.6252	62.4931	63.3611	64.2290	65.0970	65.9650	66.8329	67.7009	68.5688
8	69.4368	70.3048	71.1727	72.0407	72.9086	73.7766	74.6446	75.5125	76.3805	77.2484
9	78.1164	78.9844	79.8523	80.7203	81.5882	82.4562	83.3242	84.1921	85.0601	85.9280

CARNEGIE STEEL COMPANY

METRIC CONVERSION TABLE

INCHES TO MILLIMETERS

39.37 inches, U. S. Standard=1 meter=100 centimeters=1000 millimeters.

Inches	0	$\frac{1}{16}$	$\frac{1}{8}$	$\frac{3}{16}$	$\frac{1}{4}$	$\frac{5}{16}$	$\frac{3}{8}$	$\frac{7}{16}$
0	0.00	1.59	3.18	4.76	6.35	7.94	9.53	11.11
1	25.40	26.99	28.58	30.16	31.75	33.34	34.93	36.51
2	50.80	52.39	53.98	55.56	57.15	58.74	60.33	61.91
3	76.20	77.79	79.38	80.96	82.55	84.14	85.73	87.31
4	101.60	103.19	104.78	106.36	107.95	109.54	111.13	112.71
5	127.00	128.59	130.18	131.76	133.35	134.94	136.53	138.11
6	152.40	153.99	155.58	157.16	158.75	160.34	161.93	163.51
7	177.80	179.39	180.98	182.56	184.15	185.74	187.33	188.91
8	203.20	204.79	206.38	207.96	209.55	211.14	212.73	214.31
9	228.60	230.19	231.78	233.36	234.95	236.54	238.13	239.71
10	254.00	255.59	257.18	258.76	260.35	261.94	263.53	265.11
11	279.40	280.99	282.58	284.16	285.75	287.34	288.93	290.51
12	304.80	306.39	307.98	309.56	311.15	312.74	314.33	315.91
13	330.20	331.79	333.38	334.96	336.55	338.14	339.73	341.31
14	355.60	357.19	358.78	360.36	361.95	363.54	365.13	366.71
15	381.00	382.59	384.18	385.76	387.35	388.94	390.53	392.11
16	406.40	407.99	409.58	411.16	412.75	414.34	415.93	417.51
17	431.80	433.39	434.98	436.56	438.15	439.74	441.33	442.91
18	457.20	458.79	460.38	461.96	463.55	465.14	466.73	468.31
19	482.60	484.19	485.78	487.36	488.95	490.54	492.13	493.71
20	508.00	509.59	511.18	512.76	514.35	515.94	517.53	519.11
21	533.40	534.99	536.58	538.16	539.75	541.34	542.93	544.51
22	558.80	560.39	561.98	563.56	565.15	566.74	568.33	569.91
23	584.20	585.79	587.38	588.96	590.55	592.14	593.73	595.31
24	609.60	611.19	612.78	614.36	615.95	617.54	619.13	620.71
25	635.00	636.59	638.18	639.76	641.35	642.94	644.53	646.11
26	660.40	661.99	663.58	665.16	666.75	668.34	669.93	671.51
27	685.80	687.39	688.98	690.56	692.15	693.74	695.33	696.91
28	711.20	712.79	714.38	715.96	717.55	719.14	720.73	722.31
29	736.60	738.19	739.78	741.36	742.95	744.54	746.13	747.71
30	762.00	763.59	765.18	766.76	768.35	769.94	771.53	773.11
31	787.40	788.99	790.58	792.16	793.75	795.34	796.93	798.51
32	812.80	814.39	815.98	817.56	819.15	820.74	822.33	823.91
33	838.20	839.79	841.38	842.96	844.55	846.14	847.73	849.31
34	863.60	865.19	866.78	868.36	869.95	871.54	873.13	874.71
35	889.00	890.59	892.18	893.76	895.35	896.94	898.53	900.11
36	914.40	915.99	917.58	919.16	920.75	922.34	923.93	925.51
37	939.80	941.39	942.98	944.56	946.15	947.74	949.33	950.91
38	965.20	966.79	968.38	969.96	971.55	973.14	974.73	976.31
39	990.60	992.19	993.78	995.36	996.95	998.54	1000.13	1001.71
40	1016.00	1017.59	1019.18	1020.76	1022.35	1023.94	1025.53	1027.11
41	1041.40	1042.99	1044.58	1046.16	1047.75	1049.34	1050.93	1052.51
42	1066.80	1068.39	1069.98	1071.56	1073.15	1074.74	1076.33	1077.91
43	1092.20	1093.79	1095.38	1096.96	1098.55	1100.14	1101.73	1103.31
44	1117.60	1119.19	1120.78	1122.36	1123.95	1125.54	1127.13	1128.71
45	1143.00	1144.59	1146.18	1147.76	1149.35	1150.94	1152.53	1154.11
46	1168.40	1169.99	1171.58	1173.16	1174.75	1176.34	1177.93	1179.51
47	1193.80	1195.39	1196.98	1198.56	1200.15	1201.74	1203.33	1204.91
48	1219.20	1220.79	1222.38	1223.96	1225.55	1227.14	1228.73	1230.31
49	1244.60	1246.19	1247.78	1249.36	1250.95	1252.54	1254.13	1255.71
50	1270.00	1271.59	1273.18	1274.76	1276.35	1277.94	1279.53	1281.11

MEASURES AND WEIGHTS

METRIC CONVERSION TABLE

INCHES TO MILLIMETERS

39.37 inches, U. S. Standard=1 meter=100 centimeters=1000 millimeters

Inches	$\frac{1}{2}$	$\frac{3}{16}$	$\frac{1}{8}$	$\frac{1}{16}$	$\frac{3}{32}$	$\frac{1}{4}$	$\frac{5}{16}$	$\frac{3}{8}$	$\frac{1}{2}$
0	12.70	14.29	15.88	17.46	19.05	20.64	22.23	23.81	
1	38.10	39.69	41.28	42.86	44.45	46.04	47.63	49.21	
2	63.50	65.09	66.68	68.26	69.85	71.44	73.03	74.61	
3	88.90	90.49	92.08	93.66	95.25	96.84	98.43	100.01	
4	114.30	115.89	117.48	119.06	120.65	122.24	123.83	125.41	
5	139.70	141.29	142.88	144.46	146.05	147.64	149.23	150.81	
6	165.10	166.69	168.28	169.86	171.45	173.04	174.63	176.21	
7	190.50	192.09	193.68	195.26	196.85	198.44	200.03	201.61	
8	215.90	217.49	219.08	220.66	222.25	223.84	225.43	227.01	
9	241.30	242.89	244.48	246.06	247.65	249.24	250.83	252.41	
10	266.70	268.29	269.88	271.46	273.05	274.64	276.23	277.81	
11	292.10	293.69	295.28	296.86	298.45	300.04	301.63	303.21	
12	317.50	319.09	320.68	322.26	323.85	325.44	327.03	328.61	
13	342.90	344.49	346.08	347.66	349.25	350.84	352.43	354.01	
14	368.30	369.89	371.48	373.06	374.65	376.24	377.83	379.41	
15	393.70	395.29	396.88	398.46	400.05	401.64	403.23	404.81	
16	419.10	420.69	422.28	423.86	425.45	427.04	428.63	430.21	
17	444.50	446.09	447.68	449.26	450.85	452.44	454.03	455.61	
18	469.90	471.49	473.08	474.66	476.25	477.84	479.43	481.01	
19	495.30	496.89	498.48	500.06	501.65	503.24	504.83	506.41	
20	520.70	522.29	523.88	525.46	527.05	528.64	530.23	531.81	
21	546.10	547.69	549.28	550.86	552.45	554.04	555.63	557.21	
22	571.50	573.09	574.68	576.26	577.85	579.44	581.03	582.61	
23	596.90	598.49	600.08	601.66	603.25	604.84	606.43	608.01	
24	622.30	623.89	625.48	627.06	628.65	630.24	631.83	633.41	
25	647.70	649.29	650.88	652.46	654.05	655.64	657.23	658.81	
26	673.10	674.69	676.28	677.86	679.45	681.04	682.63	684.21	
27	698.50	700.09	701.68	703.26	704.85	706.44	708.03	709.61	
28	723.90	725.49	727.08	728.66	730.25	731.84	733.43	735.01	
29	749.30	750.89	752.48	754.06	755.65	757.24	758.83	760.41	
30	774.70	776.29	777.88	779.46	781.05	782.64	784.23	785.81	
31	800.10	801.69	803.28	804.86	806.45	808.04	809.63	811.21	
32	825.50	827.09	828.68	830.26	831.85	833.44	835.03	836.61	
33	850.90	852.49	854.08	855.66	857.25	858.84	860.43	862.01	
34	876.30	877.89	879.48	881.06	882.65	884.24	885.83	887.41	
35	901.70	903.29	904.88	906.46	908.05	909.64	911.23	912.81	
36	927.10	928.69	930.28	931.86	933.45	935.04	936.63	938.21	
37	952.50	954.09	955.68	957.26	958.85	960.44	962.03	963.61	
38	977.90	979.49	981.08	982.66	984.25	985.84	987.43	989.01	
39	1003.30	1004.89	1006.48	1008.06	1009.65	1011.24	1012.83	1014.41	
40	1028.70	1030.29	1031.88	1033.46	1035.05	1036.64	1038.23	1039.81	
41	1054.10	1055.69	1057.28	1058.86	1060.45	1062.04	1063.63	1065.21	
42	1079.50	1081.09	1082.68	1084.26	1085.85	1087.44	1089.03	1090.61	
43	1104.90	1106.49	1108.08	1109.66	1111.25	1112.84	1114.43	1116.01	
44	1130.30	1131.89	1133.48	1135.06	1136.65	1138.24	1139.83	1141.41	
45	1155.70	1157.29	1158.88	1160.46	1162.05	1163.64	1165.23	1166.81	
46	1181.10	1182.69	1184.28	1185.86	1187.45	1189.04	1190.63	1192.21	
47	1206.50	1208.09	1209.68	1211.26	1212.85	1214.44	1216.03	1217.61	
48	1231.90	1233.49	1235.08	1236.66	1238.25	1239.84	1241.43	1243.01	
49	1257.30	1258.89	1260.48	1262.06	1263.65	1265.24	1266.83	1268.41	
50	1282.70	1284.29	1285.88	1287.46	1289.05	1290.64	1292.23	1293.81	

CARNEGIE STEEL COMPANY

METRIC CONVERSION TABLE

POUNDS AVOIRDUPOIS TO KILOGRAMS

1 Pound=0.45359 Kilograms

Units Tens	0	1	2	3	4	5	6	7	8	9
0		0.45	0.91	1.36	1.81	2.27	2.72	3.18	3.63	4.08
1	4.54	4.99	5.44	5.90	6.35	6.80	7.26	7.71	8.16	8.62
2	9.07	9.53	9.98	10.43	10.89	11.34	11.79	12.25	12.70	13.15
3	13.61	14.06	14.51	14.97	15.42	15.88	16.33	16.78	17.24	17.69
4	18.14	18.60	19.05	19.50	19.96	20.41	20.87	21.32	21.77	22.23
5	22.68	23.13	23.59	24.04	24.49	24.95	25.40	25.85	26.31	26.76
6	27.22	27.67	28.12	28.58	29.03	29.48	29.94	30.39	30.84	31.30
7	31.75	32.21	32.66	33.11	33.57	34.02	34.47	34.93	35.38	35.83
8	36.29	36.74	37.19	37.65	38.10	38.56	39.01	39.46	39.92	40.37
9	40.82	41.28	41.73	42.18	42.64	43.09	43.54	44.00	44.45	44.91
10	45.36	45.81	46.27	46.72	47.17	47.63	48.08	48.53	48.99	49.44
11	49.90	50.35	50.80	51.26	51.71	52.16	52.62	53.07	53.52	53.98
12	54.43	54.88	55.34	55.79	56.25	56.70	57.15	57.61	58.06	58.51
13	58.97	59.42	59.87	60.33	60.78	61.23	61.69	62.14	62.60	63.05
14	63.50	63.96	64.41	64.86	65.32	65.77	66.22	66.68	67.13	67.59
15	68.04	68.49	68.95	69.40	69.85	70.31	70.76	71.21	71.67	72.12
16	72.57	73.03	73.48	73.94	74.39	74.84	75.30	75.75	76.20	76.66
17	77.11	77.56	78.02	78.47	78.93	79.38	79.83	80.29	80.74	81.19
18	81.65	82.10	82.55	83.01	83.46	83.91	84.37	84.82	85.28	85.73
19	86.18	86.64	87.09	87.54	88.00	88.45	88.90	89.36	89.81	90.26
20	90.72	91.17	91.63	92.08	92.53	92.99	93.44	93.89	94.35	94.80
21	95.25	95.71	96.16	96.62	97.07	97.52	97.98	98.43	98.88	99.34
22	99.79	100.24	100.70	101.15	101.60	102.06	102.51	102.97	103.42	103.87
23	104.33	104.78	105.23	105.69	106.14	106.59	107.05	107.50	107.96	108.41
24	108.86	109.32	109.77	110.22	110.68	111.13	111.58	112.04	112.49	112.94
25	113.40	113.85	114.31	114.76	115.21	115.67	116.12	116.57	117.03	117.48
26	117.93	118.39	118.84	119.29	119.75	120.20	120.66	121.11	121.56	122.02
27	122.47	122.92	123.38	123.83	124.28	124.74	125.19	125.65	126.10	126.55
28	127.01	127.46	127.91	128.37	128.82	129.27	129.73	130.18	130.63	131.09
29	131.54	132.00	132.45	132.90	133.36	133.81	134.26	134.72	135.17	135.62
30	136.08	136.53	136.98	137.44	137.89	138.35	138.80	139.25	139.71	140.16
31	140.61	141.07	141.52	141.97	142.43	142.88	143.34	143.79	144.24	144.70
32	145.15	145.60	146.06	146.51	146.96	147.42	147.87	148.32	148.78	149.23
33	149.69	150.14	150.59	151.05	151.50	151.95	152.41	152.86	153.31	153.77
34	154.22	154.68	155.13	155.58	156.04	156.49	156.94	157.40	157.85	158.30
35	158.76	159.21	159.66	160.12	160.57	161.03	161.48	161.93	162.39	162.84
36	163.29	163.75	164.20	164.65	165.11	165.56	166.01	166.47	166.92	167.38
37	167.83	168.28	168.74	169.19	169.64	170.10	170.55	171.00	171.46	171.91
38	172.37	172.82	173.27	173.73	174.18	174.63	175.09	175.54	175.99	176.45
39	176.90	177.35	177.81	178.26	178.72	179.17	179.62	180.08	180.53	180.98
40	181.44	181.89	182.34	182.80	183.25	183.70	184.16	184.61	185.07	185.52
41	185.97	186.43	186.88	187.33	187.79	188.24	188.69	189.15	189.60	190.06
42	190.51	190.96	191.42	191.87	192.32	192.78	193.23	193.68	194.14	194.59
43	195.04	195.50	195.95	196.41	196.86	197.31	197.77	198.22	198.67	199.13
44	199.58	200.03	200.49	200.94	201.40	201.85	202.30	202.76	203.21	203.66
45	204.12	204.57	205.02	205.48	205.93	206.38	206.84	207.29	207.75	208.20
46	208.65	209.11	209.56	210.01	210.47	210.92	211.37	211.83	212.28	212.73
47	213.19	213.64	214.10	214.55	215.00	215.46	215.91	216.36	216.82	217.27
48	217.72	218.18	218.63	219.09	219.54	219.99	220.45	220.90	221.35	221.81
49	222.26	222.71	223.17	223.62	224.07	224.53	224.98	225.44	225.89	226.34

MEASURES AND WEIGHTS

METRIC CONVERSION TABLE

POUNDS AVOIRDUPOIS TO KILOGRAMS

1 Pound=0.45359 Kilograms

Units Tens	0	1	2	3	4	5	6	7	8	9
50	226.80	227.25	227.70	228.16	228.61	229.06	229.52	229.97	230.42	230.88
51	231.33	231.79	232.24	232.69	233.15	233.60	234.05	234.51	234.96	235.41
52	235.87	236.32	236.78	237.23	237.68	238.14	238.59	239.04	239.50	239.95
53	240.40	240.86	241.31	241.76	242.22	242.67	243.13	243.58	244.03	244.49
54	244.94	245.39	245.85	246.30	246.75	247.21	247.66	248.12	248.57	249.02
55	249.48	249.93	250.38	250.84	251.29	251.74	252.20	252.65	253.10	253.56
56	254.01	254.47	254.92	255.37	255.83	256.28	256.73	257.19	257.64	258.09
57	258.55	259.00	259.45	259.91	260.36	260.82	261.27	261.72	262.18	262.63
58	263.08	263.54	263.99	264.44	264.90	265.35	265.81	266.26	266.71	267.17
59	267.62	268.07	268.53	268.98	269.43	269.89	270.34	270.79	271.25	271.70
60	272.16	272.61	273.06	273.52	273.97	274.42	274.88	275.33	275.78	276.24
61	276.69	277.14	277.60	278.05	278.51	278.96	279.41	279.87	280.32	280.77
62	281.23	281.68	282.13	282.59	283.04	283.50	283.95	284.40	284.86	285.31
63	285.76	286.22	286.67	287.12	287.58	288.03	288.48	288.94	289.39	289.85
64	290.30	290.75	291.21	291.66	292.11	292.57	293.02	293.47	293.93	294.38
65	294.84	295.29	295.74	296.20	296.65	297.10	297.56	298.01	298.46	298.92
66	299.37	299.82	300.28	300.73	301.19	301.64	302.09	302.55	303.00	303.45
67	303.91	304.36	304.81	305.27	305.72	306.17	306.63	307.08	307.54	307.99
68	308.44	308.90	309.35	309.80	310.26	310.71	311.16	311.62	312.07	312.52
69	312.98	313.43	313.89	314.34	314.79	315.25	315.70	316.15	316.61	317.06
70	317.51	317.97	318.42	318.88	319.33	319.78	320.24	320.69	321.14	321.60
71	322.05	322.50	322.96	323.41	323.86	324.32	324.77	325.23	325.68	326.13
72	326.59	327.04	327.49	327.95	328.40	328.85	329.31	329.76	330.22	330.67
73	331.12	331.58	332.03	332.48	332.94	333.39	333.84	334.30	334.75	335.20
74	335.66	336.11	336.57	337.02	337.47	337.93	338.38	338.83	339.29	339.74
75	340.19	340.65	341.10	341.56	342.01	342.46	342.92	343.37	343.82	344.28
76	344.73	345.18	345.64	346.09	346.54	347.00	347.45	347.91	348.36	348.81
77	349.27	349.72	350.17	350.63	351.08	351.53	351.99	352.44	352.89	353.35
78	353.80	354.26	354.71	355.16	355.62	356.07	356.52	356.98	357.43	357.88
79	358.34	358.79	359.25	359.70	360.15	360.61	361.06	361.51	361.97	362.42
80	362.87	363.33	363.78	364.23	364.69	365.14	365.60	366.05	366.50	366.96
81	367.41	367.86	368.32	368.77	369.22	369.68	370.13	370.59	371.04	371.49
82	371.95	372.40	372.85	373.31	373.76	374.21	374.67	375.12	375.57	376.03
83	376.48	376.94	377.39	377.84	378.30	378.75	379.20	379.66	380.11	380.56
84	381.02	381.47	381.92	382.38	382.83	383.29	383.74	384.19	384.65	385.10
85	385.55	386.01	386.46	386.91	387.37	387.82	388.28	388.73	389.18	389.64
86	390.09	390.54	391.00	391.45	391.90	392.36	392.81	393.26	393.72	394.17
87	394.63	395.08	395.53	395.99	396.44	396.89	397.35	397.80	398.25	398.71
88	399.16	399.61	400.07	400.52	400.98	401.43	401.88	402.34	402.79	403.24
89	403.78	404.15	404.60	405.06	405.51	405.97	406.42	406.87	407.33	407.78
90	408.23	408.69	409.14	409.59	410.05	410.50	410.95	411.41	411.86	412.32
91	412.77	413.22	413.68	414.13	414.58	415.14	415.49	415.94	416.40	416.85
92	417.31	417.76	418.21	418.67	419.12	419.57	420.03	420.48	420.93	421.39
93	421.84	422.29	422.75	423.20	423.66	424.11	424.56	425.02	425.47	425.92
94	426.38	426.83	427.28	427.74	428.19	428.64	429.10	429.55	430.01	430.46
95	430.91	431.37	431.82	432.27	432.73	433.18	433.63	434.09	434.54	435.00
96	435.45	435.90	436.36	436.81	437.26	437.72	438.17	438.62	439.08	439.53
97	439.98	440.44	440.89	441.35	441.80	442.25	442.71	443.16	443.61	444.07
98	444.52	444.97	445.43	445.88	446.33	446.79	447.24	447.70	448.15	448.60
99	449.06	449.51	449.96	450.42	450.87	451.32	451.78	452.23	452.69	453.14

PROPERTIES OF THE CIRCLE

Circumference of Circle of Dia. 1 = $\pi = 3.14159265$

Circumference of Circle = $2 \pi r$

Dia. of Circle = Circumference $\times 0.31831$

Diameter of Circle of equal periphery as square = side $\times 1.27324$

Side of Square of equal periphery as circle = diameter $\times 0.78540$

Diameter of Circle circumscribed about square = side $\times 1.41421$

Side of Square inscribed in Circle = diameter $\times 0.70711$

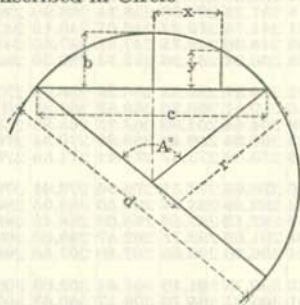

$$\text{Arc, } a = \frac{\pi r A^\circ}{180} = 0.017453 r A^\circ$$

$$\text{Angle, } A = \frac{180^\circ a}{\pi r} = 57.29578 \frac{a}{r}$$

$$\text{Radius, } r = \frac{4 b^2 + c^2}{8 b} \quad \text{Diameter, } d = \frac{4 b^2 + c^2}{4 b}$$

$$\text{Chord, } c = 2\sqrt{2 b r - b^2} = 2 r \sin \frac{A^\circ}{2}$$

$$\text{Rise, } b = r - \frac{1}{2} \sqrt{4 r^2 - c^2} = \frac{c}{2} \tan \frac{A^\circ}{4} = 2 r \sin^2 \frac{A}{4}$$

$$\text{Rise, } b = r + y - \sqrt{r^2 - x^2} \quad y = b - r + \sqrt{r^2 - x^2} \quad x = \sqrt{r^2 - (r + y - b)^2}$$

$$\pi = 3.14159265, \log = 0.4971499$$

$$\frac{1}{\pi} = 0.3183099, \log = \bar{1}.5028501$$

$$\pi^2 = 9.8696044, \log = 0.9942997$$

$$\frac{1}{\pi^2} = 0.1013212, \log = \bar{1}.0057003$$

$$\sqrt{\pi} = 1.7724539, \log = 0.2485749$$

$$\sqrt{\frac{1}{\pi}} = 0.5641896, \log = \bar{1}.7514251$$

$$\frac{\pi}{180} = 0.0174533, \log = \bar{2}.2418774$$

$$\frac{180}{\pi} = 57.2957795, \log = 1.7581226$$

AREA OF PLANE FIGURES

- Triangle: Base x $\frac{1}{2}$ perpendicular height.
 $\sqrt{s(s-a)(s-b)(s-c)}$,
 $s = \frac{1}{2}$ sum of the three sides a, b and c.
- Trapezium: Sum of area of the two triangles.
- Trapezoid: $\frac{1}{2}$ sum of parallel sides x perpendicular height.
- Parallelogram: Base x perpendicular height.
- Regular Polygon: $\frac{1}{2}$ sum of sides x inside radius.
- Circle: $\pi r^2 = 0.78540 \times \text{dia.}^2 = 0.07958 \times \text{circumference}^2$.
- Sector of Circle: $\frac{\pi r^2 A^\circ}{360} = 0.0087266 r^2 A^\circ = \text{arc} \times \frac{1}{2}$ radius.
- Segment of Circle: $\frac{r^2}{2} \left(\frac{\pi A^\circ}{180} - \sin A^\circ \right)$
- Circle of same area as square: diameter = side x 1.12838
- Square of same area as circle: side = diameter x 0.88623
- Ellipse: Long diameter x short diameter x 0.78540
- Parabola: Base x $\frac{2}{3}$ perpendicular height.

Irregular plane surface.

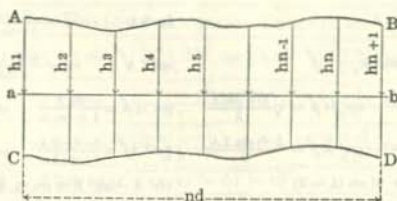

Divide any plane surface A, B, C, D, along a line a-b into an even number, n, of parallel and sufficiently small strips, d, whose ordinates are $h_1, h_2, h_3, h_4, h_5, \dots, h_{n-1}, h_n, h_{n+1}$, and considering contours between three ordinates as parabolic curves, then for section ABCD,

$$\text{Area} = \frac{d}{3} [h_1 + h_{n+1} + 4(h_2 + h_4 + h_6 \dots + h_n) + 2(h_3 + h_5 + h_7 \dots + h_{n-1})]$$

or, approximately, Area = Sum of ordinates x width, d.

TRIGONOMETRIC FORMULAS

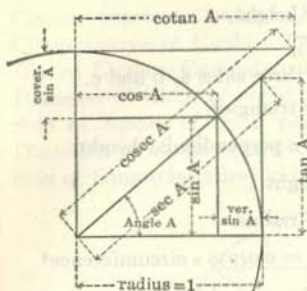

Radius, $1 = \sin^2 A + \cos^2 A$

$= \sin A \operatorname{cosec} A = \cos A \sec A = \tan A \cot A$

Sine $A = \frac{\cos A}{\cot A} = \frac{1}{\operatorname{cosec} A} = \cos A \tan A = \sqrt{1 - \cos^2 A}$

Cosine $A = \frac{\sin A}{\tan A} = \frac{1}{\sec A} = \sin A \cot A = \sqrt{1 - \sin^2 A}$

Tangent $A = \frac{\sin A}{\cos A} = \frac{1}{\cot A} = \sin A \sec A$

Cotangent $A = \frac{\cos A}{\sin A} = \frac{1}{\tan A} = \cos A \operatorname{cosec} A$

Secant $A = \frac{\tan A}{\sin A} = \frac{1}{\cos A}$

Cosecant $A = \frac{\cot A}{\cos A} = \frac{1}{\sin A}$

$\sin(A \pm B) = \sin A \cos B \pm \cos A \sin B$

$\tan(A \pm B) = \frac{\tan A \pm \tan B}{1 \mp \tan A \tan B}$

$\cos(A \pm B) = \cos A \cos B \mp \sin A \sin B$

$\cot(A \pm B) = \frac{\cot A \cot B \mp 1}{\cot B \pm \cot A}$

$\sin A + \sin B = 2 \sin \frac{1}{2}(A+B) \cos \frac{1}{2}(A-B)$

$\tan A + \tan B = \frac{\sin(A+B)}{\cos A \cos B}$

$\sin A - \sin B = 2 \cos \frac{1}{2}(A+B) \sin \frac{1}{2}(A-B)$

$\tan A - \tan B = \frac{\sin(A-B)}{\cos A \cos B}$

$\cos A + \cos B = 2 \cos \frac{1}{2}(A+B) \cos \frac{1}{2}(A-B)$

$\cot A + \cot B = \frac{\sin(B+A)}{\sin A \sin B}$

$\cos B - \cos A = 2 \sin \frac{1}{2}(A+B) \sin \frac{1}{2}(A-B)$

$\cot A - \cot B = \frac{\sin(B-A)}{\sin A \sin B}$

$\sin 2A = 2 \sin A \cos A$

$\tan 2A = \frac{2 \tan A}{1 - \tan^2 A}$

$\cos 2A = \cos^2 A - \sin^2 A$

$\cot 2A = \frac{\cot^2 A - 1}{2 \cot A}$

$\sin \frac{1}{2} A = \sqrt{\frac{1 - \cos A}{2}}$

$\cos \frac{1}{2} A = \sqrt{\frac{1 + \cos A}{2}}$

$\tan \frac{1}{2} A = \frac{\sin A}{1 + \cos A}$

$\cot \frac{1}{2} A = \frac{\sin A}{1 - \cos A}$

$\sin^2 A = \frac{1 - \cos 2A}{2}$

$\cos^2 A = \frac{1 + \cos 2A}{2}$

$\tan^2 A = \frac{1 - \cos 2A}{1 + \cos 2A}$

$\cot^2 A = \frac{1 + \cos 2A}{1 - \cos 2A}$

$\sin^2 A - \sin^2 B = \sin(A+B) \sin(A-B)$

$\cos^2 A - \sin^2 B = \cos(A+B) \cos(A-B)$

$\frac{\sin A \pm \sin B}{\cos A \pm \cos B} = \tan \frac{1}{2}(A \pm B)$

$\frac{\sin A \pm \sin B}{\cos B - \cos A} = \cot \frac{1}{2}(A \mp B)$

Quadrant	I	II	III	IV	Angle		
Angles	0° to 90°	90° to 180°	180° to 270°	270° to 360°	30°	45°	60°
Functions	Values vary from				Equivalent values		
sin	+0 to +1	+1 to +0	-0 to -1	-1 to -0	$\frac{1}{2}$	$\frac{1}{2}\sqrt{2}$	$\frac{1}{2}\sqrt{3}$
cos	+1 to +0	-0 to -1	-1 to -0	+0 to +1	$\frac{1}{2}\sqrt{3}$	$\frac{1}{2}\sqrt{2}$	$\frac{1}{2}$
tan	+0 to +∞	-∞ to -0	+0 to +∞	-∞ to -0	$\frac{1}{2}\sqrt{3}$	1	$\sqrt{3}$
cot	+∞ to +0	-0 to -∞	+∞ to +0	-0 to -∞	$\sqrt{3}$	1	$\frac{1}{2}\sqrt{3}$

Angle $a < 90^\circ$				
Angle	sin	cos	tan	cot
ϕ°	ϕ°	ϕ°	ϕ°	ϕ°
$0^\circ \pm a$	$\pm \sin a$	$+\cos a$	$\pm \tan a$	$\pm \cot a$
$90^\circ \pm a$	$+\cos a$	$\mp \sin a$	$\mp \cot a$	$\mp \tan a$
$180^\circ \pm a$	$\mp \sin a$	$-\cos a$	$\pm \tan a$	$\pm \cot a$
$270^\circ \pm a$	$-\cos a$	$\pm \sin a$	$\mp \cot a$	$\mp \tan a$

TRIGONOMETRIC SOLUTION OF TRIANGLES

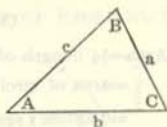
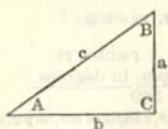

$$S = \frac{a+b+c}{2}$$

Given	Sought	Formulae		
RIGHT-ANGLED TRIANGLES				
a, c	A, B, b	$\sin A = \frac{a}{c}$,	$\cos B = \frac{a}{c}$,	$b = \sqrt{c^2 - a^2}$
	Area	$\text{Area} = \frac{a}{2} \sqrt{c^2 - a^2}$		
a, b	A, B, c	$\tan A = \frac{a}{b}$,	$\tan B = \frac{b}{a}$,	$c = \sqrt{a^2 + b^2}$
	Area	$\text{Area} = \frac{a b}{2}$		
A, a	B, b, c	$B = 90^\circ - A$,	$b = a \cot A$,	$c = \frac{a}{\sin A}$
	Area	$\text{Area} = \frac{a^2 \cot A}{2}$		
A, b	B, a, c	$B = 90^\circ - A$,	$a = b \tan A$,	$c = \frac{b}{\cos A}$
	Area	$\text{Area} = \frac{b^2 \tan A}{2}$		
A, c	B, a, b	$B = 90^\circ - A$,	$a = c \sin A$,	$b = c \cos A$
	Area	$\text{Area} = \frac{c^2 \sin A \cos A}{2}$ or $\frac{c^2 \sin 2A}{4}$		
OBLIQUE-ANGLED TRIANGLES				
a, b, c	A	$\sin \frac{1}{2} A = \sqrt{\frac{(s-b)(s-c)}{bc}}$,	$\cos \frac{1}{2} A = \sqrt{\frac{s(s-a)}{bc}}$,	$\tan \frac{1}{2} A = \sqrt{\frac{(s-b)(s-c)}{s(s-a)}}$
	B	$\sin \frac{1}{2} B = \sqrt{\frac{(s-a)(s-c)}{ac}}$,	$\cos \frac{1}{2} B = \sqrt{\frac{s(s-b)}{ac}}$,	$\tan \frac{1}{2} B = \sqrt{\frac{(s-a)(s-c)}{s(s-b)}}$
	C	$\sin \frac{1}{2} C = \sqrt{\frac{(s-a)(s-b)}{ab}}$,	$\cos \frac{1}{2} C = \sqrt{\frac{s(s-c)}{ab}}$,	$\tan \frac{1}{2} C = \sqrt{\frac{(s-a)(s-b)}{s(s-c)}}$
	Area	$\text{Area} = \sqrt{s(s-a)(s-b)(s-c)}$		
a, A, B	b, c	$b = \frac{a \sin B}{\sin A}$	$c = \frac{a \sin C}{\sin A} = \frac{a \sin(A+B)}{\sin A}$	
	Area	$\text{Area} = \frac{1}{2} a b \sin C = \frac{a^2 \sin B \sin C}{2 \sin A}$		
a, b, A	B	$\sin B = \frac{b \sin A}{a}$		
	c	$c = \frac{a \sin C}{\sin A} = \frac{b \sin C}{\sin B} = \sqrt{a^2 + b^2 - 2ab \cos C}$		
	Area	$\text{Area} = \frac{1}{2} a b \sin C$		
a, b, C	A	$\tan A = \frac{a \sin C}{b - a \cos C}$,	$\tan \frac{1}{2}(A-B) = \frac{a-b}{a+b} \cot \frac{1}{2} C$	
	c	$c = \sqrt{a^2 + b^2 - 2ab \cos C} = \frac{a \sin C}{\sin A}$		
	Area	$\text{Area} = \frac{1}{2} ab \sin C$		

$$a^2 = b^2 + c^2 - 2bc \cos A, \quad b^2 = a^2 + c^2 - 2ac \cos B, \quad c^2 = a^2 + b^2 - 2ab \cos C$$

AREA OF CIRCULAR SECTIONS

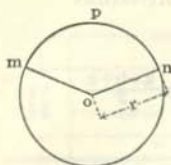

Circular Sector, m o n p

$$\begin{aligned} \text{Area} &= \frac{1}{2} (\text{length of arc, } m p n \times \text{radius, } r) \\ &= \text{area of circle} \times \frac{\text{arc, } m p n, \text{ in degrees}}{360} \\ &= 0.0087266 \times \text{square of radius, } r^2, \times \text{angle of arc, } m p n, \text{ in degrees.} \end{aligned}$$

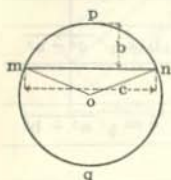

Circular Segment, m p n, less than half circle.

$$\begin{aligned} \text{Area} &= \text{area of sector, } m o n p - \text{area of triangle, } m o n \\ &= \frac{(\text{length of arc, } m p n, \times \text{radius, } r) - (\text{radius, } r, \times \text{rise, } b) \times \text{chord, } c}{2} \end{aligned}$$

Circular Segment, m q n, greater than half circle.

$$\text{Area} = \text{area of circle} - \text{area of segment, } m n p$$

Circular Segment, from Table I, page 325.

Given: rise, b, and chord, c.

$$\text{Area} = \text{product of rise and chord, } b \times c, \text{ multiplied by the coefficient given opposite the quotient of } \frac{b}{c}:$$

Intermediate coefficients for values of $\frac{b}{c}$ not given in tables are obtained by interpolation.

Example - Given: rise = 1.49 and chord = 3.52.

$$\frac{b}{c} = \frac{1.49}{3.52} = 0.4233. \text{ Coefficient} = 0.7542.$$

$$\text{Area} = b \times c \times \text{coeff.} = 1.49 \times 3.52 \times 0.7542 = 3.9556.$$

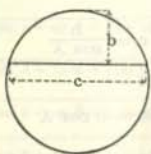

Circular Segment, from Table II, pages 326 and 327.

Given: rise, b, and diameter, $d = 2r$.

$$\text{Area} = \text{square of diameter, } d^2, \text{ multiplied by the coefficient given opposite the quotient of } \frac{b}{d}.$$

Intermediate coefficients for values of $\frac{b}{d}$ not given in tables are obtained by interpolation.

Example - Given: rise = $2\frac{1}{16}$ and diameter = $5\frac{3}{32}$.

$$\frac{b}{d} = 2\frac{1}{16} \div 5\frac{3}{32} = 0.478528.$$

$$\text{Coefficient by interpolation} = 0.371233.$$

$$\text{Area} = d^2 \times \text{coeff.} = 25.94629 \times 0.371233 = 9.6321.$$

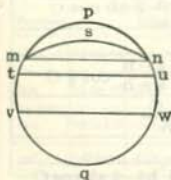
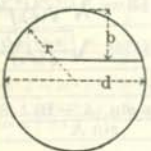

Circular Zone, t u v w

$$\text{Area} = \text{area of circle} - (\text{area of segment, } t p u + \text{area of segment, } v q w).$$

Circular Lune, m p n s

$$\text{Area} = \text{segment, } m p n - \text{segment, } m s n.$$

MENSURATION TABLES

AREAS OF CIRCULAR SEGMENTS

TABLE 1—FOR RATIOS OF RISE AND CHORD

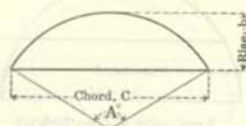

Area=C x b x coefficient

A°	Coefficient	b/C	A°	Coefficient	b/C	A°	Coefficient	b/C	A°	Coefficient	b/C
1	.6667	.0022	46	.6722	.1017	91	.6895	.2097	136	.7239	.3373
2	.6667	.0044	47	.6724	.1040	92	.6901	.2122	137	.7249	.3404
3	.6667	.0066	48	.6727	.1063	93	.6906	.2148	138	.7260	.3436
4	.6667	.0087	49	.6729	.1086	94	.6912	.2174	139	.7270	.3469
5	.6667	.0109	50	.6732	.1109	95	.6918	.2200	140	.7281	.3501
6	.6667	.0131	51	.6734	.1131	96	.6924	.2226	141	.7292	.3534
7	.6668	.0153	52	.6737	.1154	97	.6930	.2252	142	.7303	.3567
8	.6668	.0175	53	.6740	.1177	98	.6936	.2279	143	.7314	.3600
9	.6669	.0197	54	.6743	.1200	99	.6942	.2305	144	.7325	.3633
10	.6670	.0218	55	.6746	.1224	100	.6948	.2332	145	.7336	.3666
11	.6670	.0240	56	.6749	.1247	101	.6954	.2358	146	.7348	.3700
12	.6671	.0262	57	.6752	.1270	102	.6961	.2385	147	.7360	.3734
13	.6672	.0284	58	.6755	.1293	103	.6967	.2412	148	.7372	.3768
14	.6672	.0306	59	.6758	.1316	104	.6974	.2439	149	.7384	.3802
15	.6673	.0328	60	.6761	.1340	105	.6980	.2466	150	.7396	.3837
16	.6674	.0350	61	.6764	.1363	106	.6987	.2493	151	.7408	.3871
17	.6674	.0372	62	.6768	.1387	107	.6994	.2520	152	.7421	.3906
18	.6675	.0394	63	.6771	.1410	108	.7001	.2548	153	.7434	.3942
19	.6676	.0416	64	.6775	.1434	109	.7008	.2575	154	.7447	.3977
20	.6677	.0437	65	.6779	.1457	110	.7015	.2603	155	.7460	.4013
21	.6678	.0459	66	.6782	.1481	111	.7022	.2631	156	.7473	.4049
22	.6679	.0481	67	.6786	.1505	112	.7030	.2659	157	.7486	.4085
23	.6680	.0504	68	.6790	.1529	113	.7037	.2687	158	.7500	.4122
24	.6681	.0526	69	.6794	.1553	114	.7045	.2715	159	.7514	.4159
25	.6682	.0548	70	.6797	.1577	115	.7052	.2743	160	.7528	.4196
26	.6684	.0570	71	.6801	.1601	116	.7060	.2772	161	.7542	.4233
27	.6685	.0592	72	.6805	.1625	117	.7068	.2800	162	.7557	.4270
28	.6687	.0614	73	.6809	.1649	118	.7076	.2829	163	.7571	.4308
29	.6688	.0636	74	.6814	.1673	119	.7084	.2858	164	.7586	.4346
30	.6690	.0658	75	.6818	.1697	120	.7092	.2887	165	.7601	.4385
31	.6691	.0681	76	.6822	.1722	121	.7100	.2916	166	.7616	.4424
32	.6693	.0703	77	.6826	.1746	122	.7109	.2945	167	.7632	.4463
33	.6694	.0725	78	.6831	.1771	123	.7117	.2975	168	.7648	.4502
34	.6696	.0747	79	.6835	.1795	124	.7126	.3004	169	.7664	.4542
35	.6698	.0770	80	.6840	.1820	125	.7134	.3034	170	.7680	.4582
36	.6700	.0792	81	.6844	.1845	126	.7143	.3064	171	.7696	.4622
37	.6702	.0814	82	.6849	.1869	127	.7152	.3094	172	.7712	.4663
38	.6704	.0837	83	.6854	.1894	128	.7161	.3124	173	.7729	.4704
39	.6706	.0859	84	.6859	.1919	129	.7170	.3155	174	.7746	.4745
40	.6708	.0882	85	.6864	.1944	130	.7180	.3185	175	.7763	.4787
41	.6710	.0904	86	.6869	.1970	131	.7189	.3216	176	.7781	.4828
42	.6712	.0927	87	.6874	.1995	132	.7199	.3247	177	.7799	.4871
43	.6714	.0949	88	.6879	.2020	133	.7209	.3278	178	.7817	.4914
44	.6717	.0972	89	.6884	.2046	134	.7219	.3309	179	.7835	.4957
45	.6719	.0995	90	.6890	.2071	135	.7229	.3341	180	.7854	.5000

CARNEGIE STEEL COMPANY

AREAS OF CIRCULAR SEGMENTS
TABLE II, FOR RATIOS OF RISE AND DIAMETER

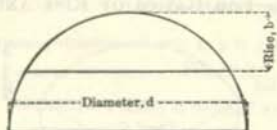

Area = $d^2 \times$ Coefficient

$\frac{b}{d}$	Coefficient	$\frac{b}{d}$	Coefficient	$\frac{b}{d}$	Coefficient	$\frac{b}{d}$	Coefficient	$\frac{b}{d}$	Coefficient
.001	.000042	.051	.015119	.101	.041477	.151	.074590	.201	.112625
.002	.000119	.052	.015561	.102	.042081	.152	.075307	.202	.113427
.003	.000219	.053	.016008	.103	.042687	.153	.076026	.203	.114231
.004	.000337	.054	.016458	.104	.043296	.154	.076747	.204	.115036
.005	.000471	.055	.016912	.105	.043908	.155	.077470	.205	.115842
.006	.000619	.056	.017369	.106	.044523	.156	.078194	.206	.116651
.007	.000779	.057	.017831	.107	.045140	.157	.078921	.207	.117460
.008	.000952	.058	.018297	.108	.045759	.158	.079650	.208	.118271
.009	.001135	.059	.018766	.109	.046381	.159	.080380	.209	.119084
.010	.001329	.060	.019239	.110	.047006	.160	.081112	.210	.119898
.011	.001533	.061	.019716	.111	.047633	.161	.081847	.211	.120713
.012	.001746	.062	.020197	.112	.048262	.162	.082582	.212	.121530
.013	.001969	.063	.020681	.113	.048894	.163	.083320	.213	.122348
.014	.002199	.064	.021168	.114	.049529	.164	.084060	.214	.123167
.015	.002438	.065	.021660	.115	.050165	.165	.084801	.215	.123988
.016	.002685	.066	.022155	.116	.050805	.166	.085545	.216	.124811
.017	.002940	.067	.022653	.117	.051446	.167	.086290	.217	.125634
.018	.003202	.068	.023155	.118	.052090	.168	.087037	.218	.126459
.019	.003472	.069	.023660	.119	.052737	.169	.087785	.219	.127286
.020	.003749	.070	.024168	.120	.053385	.170	.088536	.220	.128114
.021	.004032	.071	.024680	.121	.054037	.171	.089288	.221	.128943
.022	.004322	.072	.025196	.122	.054690	.172	.090042	.222	.129773
.023	.004619	.073	.025714	.123	.055346	.173	.090797	.223	.130605
.024	.004922	.074	.026236	.124	.056004	.174	.091555	.224	.131438
.025	.005231	.075	.026761	.125	.056664	.175	.092314	.225	.132273
.026	.005546	.076	.027290	.126	.057327	.176	.093074	.226	.133109
.027	.005867	.077	.027821	.127	.057991	.177	.093837	.227	.133946
.028	.006194	.078	.028356	.128	.058658	.178	.094601	.228	.134784
.029	.006527	.079	.028894	.129	.059328	.179	.095367	.229	.135624
.030	.006866	.080	.029435	.130	.059999	.180	.096135	.230	.136465
.031	.007209	.081	.029979	.131	.060673	.181	.096904	.231	.137307
.032	.007559	.082	.030526	.132	.061349	.182	.097675	.232	.138151
.033	.007913	.083	.031077	.133	.062027	.183	.098447	.233	.138996
.034	.008273	.084	.031630	.134	.062707	.184	.099221	.234	.139842
.035	.008638	.085	.032186	.135	.063389	.185	.099997	.235	.140689
.036	.009008	.086	.032746	.136	.064074	.186	.100774	.236	.141538
.037	.009383	.087	.033308	.137	.064761	.187	.101553	.237	.142388
.038	.009764	.088	.033873	.138	.065449	.188	.102334	.238	.143239
.039	.010148	.089	.034441	.139	.066140	.189	.103116	.239	.144091
.040	.010538	.090	.035012	.140	.066833	.190	.103900	.240	.144945
.041	.010932	.091	.035586	.141	.067528	.191	.104686	.241	.145800
.042	.011331	.092	.036162	.142	.068225	.192	.105472	.242	.146656
.043	.011734	.093	.036742	.143	.068924	.193	.106261	.243	.147513
.044	.012142	.094	.037324	.144	.069626	.194	.107051	.244	.148371
.045	.012555	.095	.037909	.145	.070329	.195	.107843	.245	.149231
.046	.012971	.096	.038497	.146	.071034	.196	.108636	.246	.150091
.047	.013393	.097	.039087	.147	.071741	.197	.109431	.247	.150953
.048	.013818	.098	.039681	.148	.072450	.198	.110227	.248	.151816
.049	.014248	.099	.040277	.149	.073162	.199	.111025	.249	.152681
.050	.014681	.100	.040875	.150	.073875	.200	.111824	.250	.153546

MENSURATION TABLES

AREAS OF CIRCULAR SEGMENTS

TABLE II, FOR RATIOS OF RISE AND DIAMETER—Concluded

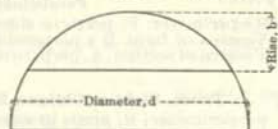

Area = d^2 x coefficient

$\frac{b}{d}$	Coefficient	$\frac{b}{d}$	Coefficient	$\frac{b}{d}$	Coefficient	$\frac{b}{d}$	Coefficient	$\frac{b}{d}$	Coefficient
.251	.154413	.301	.199085	.351	.245935	.401	.294350	.451	.343778
.252	.155281	.302	.200003	.352	.246890	.402	.295330	.452	.344773
.253	.156149	.303	.200922	.353	.247845	.403	.296311	.453	.345768
.254	.157019	.304	.201841	.354	.248801	.404	.297292	.454	.346764
.255	.157891	.305	.202762	.355	.249758	.405	.298274	.455	.347760
.256	.158763	.306	.203683	.356	.250715	.406	.299256	.456	.348756
.257	.159636	.307	.204605	.357	.251673	.407	.300238	.457	.349752
.258	.160511	.308	.205528	.358	.252632	.408	.301221	.458	.350749
.259	.161386	.309	.206452	.359	.253591	.409	.302204	.459	.351745
.260	.162263	.310	.207376	.360	.254551	.410	.303187	.460	.352742
.261	.163141	.311	.208302	.361	.255511	.411	.304171	.461	.353739
.262	.164020	.312	.209228	.362	.256472	.412	.305156	.462	.354736
.263	.164900	.313	.210155	.363	.257433	.413	.306140	.463	.355733
.264	.165781	.314	.211083	.364	.258395	.414	.307125	.464	.356730
.265	.166663	.315	.212011	.365	.259358	.415	.308110	.465	.357728
.266	.167546	.316	.212941	.366	.260321	.416	.309096	.466	.358725
.267	.168431	.317	.213871	.367	.261285	.417	.310082	.467	.359723
.268	.169316	.318	.214802	.368	.262249	.418	.311068	.468	.360721
.269	.170202	.319	.215734	.369	.263214	.419	.312055	.469	.361719
.270	.171090	.320	.216666	.370	.264179	.420	.313042	.470	.362717
.271	.171978	.321	.217600	.371	.265145	.421	.314029	.471	.363715
.272	.172868	.322	.218534	.372	.266111	.422	.315017	.472	.364714
.273	.173758	.323	.219469	.373	.267078	.423	.316005	.473	.365712
.274	.174650	.324	.220404	.374	.268046	.424	.316993	.474	.366711
.275	.175542	.325	.221341	.375	.269014	.425	.317981	.475	.367710
.276	.176436	.326	.222278	.376	.269982	.426	.318970	.476	.368708
.277	.177330	.327	.223216	.377	.270951	.427	.319959	.477	.369707
.278	.178226	.328	.224154	.378	.271921	.428	.320949	.478	.370706
.279	.179122	.329	.225094	.379	.272891	.429	.321938	.479	.371705
.280	.180020	.330	.226034	.380	.273861	.430	.322928	.480	.372704
.281	.180918	.331	.226974	.381	.274832	.431	.323919	.481	.373704
.282	.181818	.332	.227916	.382	.275804	.432	.324909	.482	.374703
.283	.182718	.333	.228858	.383	.276776	.433	.325900	.483	.375702
.284	.183619	.334	.229801	.384	.277748	.434	.326891	.484	.376702
.285	.184522	.335	.230745	.385	.278721	.435	.327883	.485	.377701
.286	.185425	.336	.231689	.386	.279695	.436	.328874	.486	.378701
.287	.186329	.337	.232634	.387	.280669	.437	.329866	.487	.379701
.288	.187235	.338	.233580	.388	.281643	.438	.330858	.488	.380700
.289	.188141	.339	.234526	.389	.282618	.439	.331851	.489	.381700
.290	.189048	.340	.235473	.390	.283593	.440	.332843	.490	.382700
.291	.189956	.341	.236421	.391	.284569	.441	.333836	.491	.383700
.292	.190865	.342	.237369	.392	.285545	.442	.334829	.492	.384699
.293	.191774	.343	.238319	.393	.286521	.443	.335823	.493	.385699
.294	.192685	.344	.239268	.394	.287499	.444	.336816	.494	.386699
.295	.193597	.345	.240219	.395	.288476	.445	.337810	.495	.387699
.296	.194509	.346	.241170	.396	.289454	.446	.338804	.496	.388699
.297	.195423	.347	.242122	.397	.290432	.447	.339799	.497	.389699
.298	.196337	.348	.243074	.398	.291411	.448	.340793	.498	.390699
.299	.197252	.349	.244027	.399	.292390	.449	.341788	.499	.391699
.300	.198168	.350	.244980	.400	.293370	.450	.342783	.500	.392699

SURFACE AND VOLUME OF SOLIDS

S=LATERAL OR CONVEX SURFACE. V=VOLUME

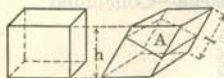

Parallelepiped

S=perimeter, P, perp. to sides x lat. length, l: $P l$
 V=area of base, B x perpendicular height, h: $B h$
 V=area of section, A, perp. to sides x lat. length, l: $A l$

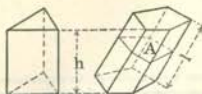

Prism, Right or Oblique, Regular or Irregular

S=perimeter, P, perp. to sides x lat. length, l: $P l$
 V=area of base, B x perpendicular height, h: $B h$
 V=area of section, A, perp. to sides x lat. length, l: $A l$



Cylinder, Right or Oblique, Circular or Elliptic, etc.

S=perimeter of base, P x perp. height, h: $P h$
 S=perimeter, P_1 , perp. to sides x lat. length, l: $P_1 l$
 V=area of base, B x perpendicular height, h: $B h$
 V=area of section, A, perp. to sides x lat. length, l: $A l$

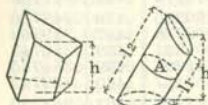

Frustum of any Prism or Cylinder

V=area of base, B x perp. distance, h, from base to center of gravity of opposite face: $B h$
 For cylinder: $\frac{1}{2} A (l_1 + l_2)$

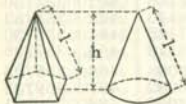

Pyramid or Cone, Right and Regular

S=perimeter of base, P x $\frac{1}{2}$ slant height, l: $\frac{1}{2} P l$
 V=area of base, B x $\frac{1}{3}$ perp. height, h: $\frac{1}{3} B h$

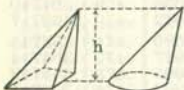

Pyramid or Cone, Right or Oblique, Regular or Irregular
 V=area of base, B x $\frac{1}{3}$ perp. height, h: $\frac{1}{3} B h$
 V= $\frac{1}{3}$ volume of prism or cylinder of same base and perpendicular height
 V= $\frac{1}{2}$ volume of hemisphere of same base and perpendicular height

Frustum of Pyramid or Cone, Right and Regular, Parallel Ends



S=(sum of perimeter of base, P, and top, p) x $\frac{1}{2}$ slant height, l: $\frac{1}{2} l (P + p)$
 V=(sum of areas of base, B, and top, b + square root of their products) x $\frac{1}{3}$ perp. height, h: $\frac{1}{3} h (B + b + \sqrt{B b})$

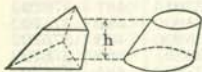

Frustum of any Pyramid or Cone, Parallel Ends
 V=(sum of areas of base, B, and top, b + square root of their products) x $\frac{1}{3}$ perp. height, h: $\frac{1}{3} h (B + b + \sqrt{B b})$

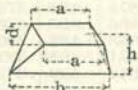

Wedge, Parallelogram Face

V= $\frac{1}{6}$ (sum of three edges, a b a x perpendicular height, h x perpendicular width, d): $\frac{1}{6} d h (2a + b)$

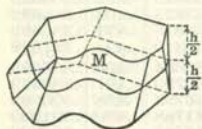

Prismaticoid

V= $\frac{1}{6}$ perp. height, h (sum of areas of base, B, and top b, + 4 x area of section, M, parallel to bases and midway between them): $\frac{1}{6} h (B + b + 4 M)$

The Prismaticoid formula applies also to any of the foregoing solids with parallel bases, to pyramids, cones, spherical sections, and to many solids with irregular surfaces.

SURFACE AND VOLUME OF SOLIDS—Concluded

S=LATERAL OR CONVEX SURFACE. V=VOLUME



Sphere

$$S = 4 \pi r^2 = \pi d^2 = 3.14159265 d^2$$

$$V = \frac{4}{3} \pi r^3 = \frac{1}{6} \pi d^3 = 0.52359878 d^3$$



Spherical Sector

$$S = \frac{1}{2} \pi r (4b + c)$$

$$V = \frac{2}{3} \pi r^2 b$$

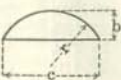

Spherical Segment

$$S = 2 \pi r b = \frac{1}{4} \pi (4b^2 + c^2)$$

$$V = \frac{1}{6} \pi b^2 (3r - b) = \frac{1}{24} \pi b (3c^2 + 4b^2)$$

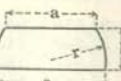

Spherical Zone

$$S = 2 \pi r b$$

$$V = \frac{1}{24} \pi b (3a^2 + 3c^2 + 4b^2)$$

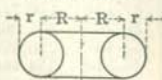

Circular Ring

$$S = 4 \pi^2 R r$$

$$V = 2 \pi^2 R r^2$$

Ungula of Right, Regular Cylinder

Base=Segment, b a b

Base=Half Circle

$$S = (2 r m - o \times \text{arc, } b a b) \frac{h}{r - o}$$

$$S = 2 r h$$

$$V = (\frac{2}{3} m^3 - o \times \text{area, } b a b) \frac{h}{r - o}$$

$$V = \frac{2}{3} r^2 h$$

Base=Segment, c a c

Base=Circle

$$S = (2 r n + p \times \text{arc, } c a c) \frac{h}{r + p}$$

$$S = r \pi h$$

$$V = (\frac{2}{3} n^3 + p \times \text{area, } c a c) \frac{h}{r + p}$$

$$V = \frac{1}{2} r^2 \pi h$$

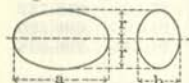
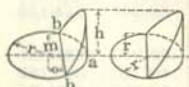

Ellipsoid

$$V = \frac{4}{3} \pi r a b$$

Paraboloid

$$V = \frac{1}{2} \pi r^2 h$$

Ratio of corresponding volumes of a Cone, Paraboloid, Sphere, and Cylinder of equal height: $\frac{1}{6} : \frac{1}{2} : \frac{2}{3} : 1$

Bodies Generated by Partial or Complete Revolution

l=length of a curve } rotating about an axis 1-1
 A=area of a plane } on one side and in plane of axis
 r=distance of center of gravity of line or plane from axis 1-1 and for any angle of revolution, a° ,

$$\frac{2 r \pi a^\circ}{360} = \text{length of arc described by center of gravity.}$$

S=length of curve x length of arc about axis

$$= l \frac{2 r \pi a^\circ}{360} \quad \text{For complete revolution } S = 2 r \pi l$$

V=area of plane x length of arc about axis

$$= A \frac{2 r \pi a^\circ}{360} \quad \text{For complete revolution } V = 2 r \pi A$$

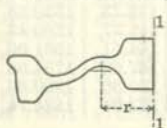
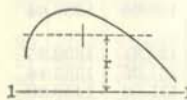

CARNEGIE STEEL COMPANY

FUNCTIONS OF NUMBERS, 1 TO 49

No.	Square	Cube	Square Root	Cubic Root	Logarithm	1000 x Reciprocal	No. = Diameter	
							Circum.	Area
1	1	1	1.0000	1.0000	0.00000	1000.000	3.142	0.7854
2	4	8	1.4142	1.2599	0.30103	500.000	6.283	3.1416
3	9	27	1.7321	1.4422	0.47712	333.333	9.425	7.0686
4	16	64	2.0000	1.5874	0.60206	250.000	12.566	12.5664
5	25	125	2.2361	1.7100	0.69897	200.000	15.708	19.6350
6	36	216	2.4495	1.8171	0.77815	166.667	18.850	28.2743
7	49	343	2.6458	1.9129	0.84510	142.857	21.991	38.4845
8	64	512	2.8284	2.0000	0.90309	125.000	25.133	50.2655
9	81	729	3.0000	2.0801	0.95424	111.111	28.274	63.6173
10	100	1000	3.1623	2.1544	1.00000	100.000	31.416	78.5398
11	121	1331	3.3166	2.2240	1.04139	90.9091	34.558	95.0332
12	144	1728	3.4641	2.2894	1.07918	83.3333	37.699	113.097
13	169	2197	3.6056	2.3513	1.11394	76.9231	40.841	132.732
14	196	2744	3.7417	2.4101	1.14613	71.4286	43.982	153.938
15	225	3375	3.8730	2.4662	1.17609	66.6667	47.124	176.715
16	256	4096	4.0000	2.5198	1.20412	62.5000	50.265	201.062
17	289	4913	4.1231	2.5713	1.23045	58.8235	53.407	226.980
18	324	5832	4.2426	2.6207	1.25527	55.5556	56.549	254.469
19	361	6859	4.3589	2.6684	1.27875	52.6316	59.690	283.529
20	400	8000	4.4721	2.7144	1.30103	50.0000	62.832	314.159
21	441	9261	4.5826	2.7589	1.32222	47.6190	65.973	346.361
22	484	10648	4.6904	2.8020	1.34242	45.4545	69.115	380.133
23	529	12167	4.7958	2.8439	1.36173	43.4783	72.257	415.476
24	576	13824	4.8990	2.8845	1.38021	41.6667	75.398	452.389
25	625	15625	5.0000	2.9240	1.39794	40.0000	78.540	490.874
26	676	17576	5.0990	2.9625	1.41497	38.4615	81.681	530.929
27	729	19683	5.1962	3.0000	1.43136	37.0370	84.823	572.555
28	784	21952	5.2915	3.0366	1.44716	35.7143	87.965	615.752
29	841	24389	5.3852	3.0723	1.46240	34.4828	91.106	660.520
30	900	27000	5.4772	3.1072	1.47712	33.3333	94.248	706.858
31	961	29791	5.5678	3.1414	1.49136	32.2581	97.389	754.768
32	1024	32768	5.6569	3.1748	1.50515	31.2500	100.531	804.248
33	1089	35937	5.7446	3.2075	1.51851	30.3030	103.673	855.299
34	1156	39304	5.8310	3.2396	1.53148	29.4118	106.814	907.920
35	1225	42875	5.9161	3.2711	1.54407	28.5714	109.956	962.113
36	1296	46656	6.0000	3.3019	1.55630	27.7778	113.097	1017.88
37	1369	50653	6.0828	3.3322	1.56820	27.0270	116.239	1075.21
38	1444	54872	6.1644	3.3620	1.57978	26.3158	119.381	1134.11
39	1521	59319	6.2450	3.3912	1.59106	25.6410	122.522	1194.59
40	1600	64000	6.3246	3.4200	1.60206	25.0000	125.66	1256.64
41	1681	68921	6.4031	3.4482	1.61278	24.3902	128.81	1320.25
42	1764	74088	6.4807	3.4760	1.62325	23.8095	131.95	1385.44
43	1849	79507	6.5574	3.5034	1.63347	23.2558	135.09	1452.20
44	1936	85184	6.6332	3.5303	1.64345	22.7273	138.23	1520.53
45	2025	91125	6.7082	3.5569	1.65321	22.2222	141.37	1590.43
46	2116	97336	6.7823	3.5830	1.66276	21.7391	144.51	1661.90
47	2209	103823	6.8557	3.6088	1.67210	21.2766	147.65	1734.94
48	2304	110592	6.9282	3.6342	1.68124	20.8333	150.80	1809.56
49	2401	117649	7.0000	3.6593	1.69020	20.4082	153.94	1885.74

MATHEMATICAL TABLES

FUNCTIONS OF NUMBERS, 50 TO 99

No.	Square	Cube	Square Root	Cubic Root	Logarithm	1000 x Reciprocal	No.—Diameter	
							Circum.	Area
50	2500	125000	7.0711	3.6840	1.69897	20.0000	157.08	1963.50
51	2601	132651	7.1414	3.7084	1.70757	19.6078	160.22	2042.82
52	2704	140608	7.2111	3.7325	1.71600	19.2308	163.36	2123.72
53	2809	148877	7.2801	3.7563	1.72428	18.8679	166.50	2206.18
54	2916	157464	7.3485	3.7798	1.73239	18.5185	169.65	2290.22
55	3025	166375	7.4162	3.8030	1.74036	18.1818	172.79	2375.83
56	3136	175616	7.4833	3.8259	1.74819	17.8571	175.93	2463.01
57	3249	185193	7.5498	3.8485	1.75587	17.5439	179.07	2551.76
58	3364	195112	7.6158	3.8709	1.76343	17.2414	182.21	2642.08
59	3481	205379	7.6811	3.8930	1.77085	16.9492	185.35	2733.97
60	3600	216000	7.7460	3.9149	1.77815	16.6667	188.50	2827.43
61	3721	226981	7.8102	3.9365	1.78533	16.3934	191.64	2922.47
62	3844	238328	7.8740	3.9579	1.79239	16.1290	194.78	3019.07
63	3969	250047	7.9373	3.9791	1.79934	15.8730	197.92	3117.25
64	4096	262144	8.0000	4.0000	1.80618	15.6250	201.06	3216.99
65	4225	274625	8.0623	4.0207	1.81291	15.3846	204.20	3318.31
66	4356	287496	8.1240	4.0412	1.81954	15.1515	207.35	3421.19
67	4489	300763	8.1854	4.0615	1.82607	14.9254	210.49	3525.65
68	4624	314432	8.2462	4.0817	1.83251	14.7059	213.63	3631.68
69	4761	328509	8.3066	4.1016	1.83885	14.4928	216.77	3739.28
70	4900	343000	8.3666	4.1213	1.84510	14.2857	219.91	3848.45
71	5041	357911	8.4261	4.1408	1.85126	14.0845	223.05	3959.19
72	5184	373248	8.4853	4.1602	1.85733	13.8889	226.19	4071.50
73	5329	389017	8.5440	4.1793	1.86332	13.6986	229.34	4185.39
74	5476	405224	8.6023	4.1983	1.86923	13.5135	232.48	4300.84
75	5625	421875	8.6603	4.2172	1.87506	13.3333	235.62	4417.86
76	5776	438976	8.7178	4.2358	1.88081	13.1579	238.76	4536.46
77	5929	456533	8.7750	4.2543	1.88649	12.9870	241.90	4656.63
78	6084	474552	8.8318	4.2727	1.89209	12.8205	245.04	4778.36
79	6241	493039	8.8882	4.2908	1.89763	12.6582	248.19	4901.67
80	6400	512000	8.9443	4.3089	1.90309	12.5000	251.33	5026.55
81	6561	531441	9.0000	4.3267	1.90849	12.3457	254.47	5153.00
82	6724	551368	9.0554	4.3445	1.91381	12.1951	257.61	5281.02
83	6889	571787	9.1104	4.3621	1.91908	12.0482	260.75	5410.61
84	7056	592704	9.1652	4.3795	1.92428	11.9048	263.89	5541.77
85	7225	614125	9.2195	4.3968	1.92942	11.7647	267.04	5674.50
86	7396	636056	9.2736	4.4140	1.93450	11.6279	270.18	5808.80
87	7569	658503	9.3274	4.4310	1.93952	11.4943	273.32	5944.68
88	7744	681472	9.3808	4.4480	1.94448	11.3636	276.46	6082.12
89	7921	704969	9.4340	4.4647	1.94939	11.2360	279.60	6221.14
90	8100	729000	9.4868	4.4814	1.95424	11.1111	282.74	6361.73
91	8281	753571	9.5394	4.4979	1.95904	10.9890	285.88	6503.88
92	8464	778688	9.5917	4.5144	1.96379	10.8696	289.03	6647.61
93	8649	804357	9.6437	4.5307	1.96848	10.7527	292.17	6792.91
94	8836	830584	9.6954	4.5468	1.97313	10.6383	295.31	6939.78
95	9025	857375	9.7468	4.5629	1.97772	10.5263	298.45	7088.22
96	9216	884736	9.7980	4.5789	1.98227	10.4167	301.59	7238.23
97	9409	912673	9.8489	4.5947	1.98677	10.3093	304.73	7389.81
98	9604	941192	9.8995	4.6104	1.99123	10.2041	307.88	7542.96
99	9801	970299	9.9499	4.6261	1.99564	10.1010	311.02	7697.69

CARNEGIE STEEL COMPANY

FUNCTIONS OF NUMBERS, 100 TO 149

No.	Square	Cube	Square Root	Cubic Root	Logarithm	1000 x Reciprocal	No.—Diameter	
							Circum.	Area
100	10000	1000000	10.0000	4.6416	2.00000	10.0000	314.16	7853.98
101	10201	1030301	10.0499	4.6570	2.00432	9.90099	317.30	8011.85
102	10404	1061208	10.0995	4.6723	2.00860	9.80392	320.44	8171.28
103	10609	1092727	10.1489	4.6875	2.01284	9.70874	323.58	8332.29
104	10816	1124864	10.1980	4.7027	2.01703	9.61538	326.73	8494.87
105	11025	1157625	10.2470	4.7177	2.02119	9.52381	329.87	8659.01
106	11236	1191016	10.2956	4.7326	2.02531	9.43396	333.01	8824.73
107	11449	1225043	10.3441	4.7475	2.02938	9.34579	336.15	8992.02
108	11664	1259712	10.3923	4.7622	2.03342	9.25926	339.29	9160.88
109	11881	1295029	10.4403	4.7769	2.03743	9.17431	342.43	9331.32
110	12100	1331000	10.4881	4.7914	2.04139	9.09091	345.58	9503.32
111	12321	1367631	10.5357	4.8059	2.04532	9.00901	348.72	9676.89
112	12544	1404928	10.5830	4.8203	2.04922	8.92857	351.86	9852.03
113	12769	1442897	10.6301	4.8346	2.05308	8.84956	355.00	10028.7
114	12996	1481544	10.6771	4.8488	2.05690	8.77193	358.14	10207.0
115	13225	1520875	10.7238	4.8629	2.06070	8.69565	361.28	10386.9
116	13456	1560896	10.7703	4.8770	2.06446	8.62069	364.42	10568.3
117	13689	1601613	10.8167	4.8910	2.06819	8.54701	367.57	10751.3
118	13924	1643032	10.8628	4.9049	2.07188	8.47458	370.71	10935.9
119	14161	1685159	10.9087	4.9187	2.07555	8.40336	373.85	11122.0
120	14400	1728000	10.9545	4.9324	2.07918	8.33333	376.99	11309.7
121	14641	1771561	11.0000	4.9461	2.08279	8.26446	380.13	11499.0
122	14884	1815848	11.0454	4.9597	2.08636	8.19672	383.27	11689.9
123	15129	1860867	11.0905	4.9732	2.08991	8.13008	386.42	11882.3
124	15376	1906624	11.1355	4.9866	2.09342	8.06452	389.56	12076.3
125	15625	1953125	11.1803	5.0000	2.09691	8.00000	392.70	12271.8
126	15876	2000376	11.2250	5.0133	2.10037	7.93651	395.84	12469.0
127	16129	2048383	11.2694	5.0265	2.10380	7.87402	398.98	12667.7
128	16384	2097152	11.3137	5.0397	2.10721	7.81250	402.12	12868.0
129	16641	2146689	11.3578	5.0528	2.11059	7.75194	405.27	13069.8
130	16900	2197000	11.4018	5.0658	2.11394	7.69231	408.41	13273.2
131	17161	2248091	11.4455	5.0788	2.11727	7.63359	411.55	13478.2
132	17424	2299968	11.4891	5.0916	2.12057	7.57576	414.69	13684.8
133	17689	2352637	11.5326	5.1045	2.12385	7.51880	417.83	13892.9
134	17956	2406104	11.5758	5.1172	2.12710	7.46269	420.97	14102.6
135	18225	2460375	11.6190	5.1299	2.13033	7.40741	424.12	14313.9
136	18496	2515456	11.6619	5.1426	2.13354	7.35294	427.26	14526.7
137	18769	2571353	11.7047	5.1551	2.13672	7.29927	430.40	14741.1
138	19044	2628072	11.7473	5.1676	2.13988	7.24638	433.54	14957.1
139	19321	2685619	11.7898	5.1801	2.14301	7.19424	436.68	15174.7
140	19600	2744000	11.8322	5.1925	2.14613	7.14286	439.82	15393.8
141	19881	2803221	11.8743	5.2048	2.14922	7.09220	442.96	15614.5
142	20164	2863288	11.9164	5.2171	2.15229	7.04225	446.11	15836.8
143	20449	2924207	11.9583	5.2293	2.15534	6.99301	449.25	16060.6
144	20736	2985984	12.0000	5.2415	2.15836	6.94444	452.39	16286.0
145	21025	3048625	12.0416	5.2536	2.16137	6.89655	455.53	16513.0
146	21316	3112136	12.0830	5.2656	2.16435	6.84932	458.67	16741.5
147	21609	3176523	12.1244	5.2776	2.16732	6.80272	461.81	16971.7
148	21904	3241792	12.1655	5.2896	2.17026	6.75676	464.96	17203.4
149	22201	3307949	12.2066	5.3015	2.17319	6.71141	468.10	17436.6

MATHEMATICAL TABLES

FUNCTIONS OF NUMBERS, 150 TO 199

No.	Square	Cube	Square Root	Cubic Root	Logarithm	1000 x Reciprocal	No.—Diameter	
							Circum.	Area
150	22500	3375000	12.2474	5.3133	2.17609	6.66667	471.24	17671.5
151	22801	3442951	12.2882	5.3251	2.17898	6.62252	474.38	17907.9
152	23104	3511808	12.3288	5.3368	2.18184	6.57895	477.52	18145.8
153	23409	3581577	12.3693	5.3485	2.18469	6.53595	480.66	18385.4
154	23716	3652264	12.4097	5.3601	2.18752	6.49351	483.81	18626.5
155	24025	3723875	12.4499	5.3717	2.19033	6.45161	486.95	18869.2
156	24336	3796416	12.4900	5.3832	2.19312	6.41026	490.09	19113.4
157	24649	3869893	12.5300	5.3947	2.19590	6.36943	493.23	19359.3
158	24964	3944312	12.5698	5.4061	2.19866	6.32911	496.37	19606.7
159	25281	4019679	12.6095	5.4175	2.20140	6.28931	499.51	19855.7
160	25600	4096000	12.6491	5.4288	2.20412	6.25000	502.65	20106.2
161	25921	4173281	12.6886	5.4401	2.20683	6.21118	505.80	20358.3
162	26244	4251528	12.7279	5.4514	2.20952	6.17284	508.94	20612.0
163	26569	4330747	12.7671	5.4626	2.21219	6.13497	512.08	20867.2
164	26896	4410944	12.8062	5.4737	2.21484	6.09756	515.22	21124.1
165	27225	4492125	12.8452	5.4848	2.21748	6.06061	518.36	21382.5
166	27556	4574296	12.8841	5.4959	2.22011	6.02410	521.50	21642.4
167	27889	4657463	12.9228	5.5069	2.22272	5.98802	524.65	21904.0
168	28224	4741632	12.9615	5.5178	2.22531	5.95238	527.79	22167.1
169	28561	4826809	13.0000	5.5288	2.22789	5.91716	530.93	22431.8
170	28900	4913000	13.0384	5.5397	2.23045	5.88235	534.07	22698.0
171	29241	5000211	13.0767	5.5505	2.23300	5.84795	537.21	22965.8
172	29584	5088448	13.1149	5.5613	2.23553	5.81395	540.35	23235.2
173	29929	5177717	13.1529	5.5721	2.23805	5.78035	543.50	23506.2
174	30276	5268024	13.1909	5.5828	2.24055	5.74713	546.64	23778.7
175	30625	5359375	13.2288	5.5934	2.24304	5.71429	549.78	24052.8
176	30976	5451776	13.2665	5.6041	2.24551	5.68182	552.92	24328.5
177	31329	5545233	13.3041	5.6147	2.24797	5.64972	556.06	24605.7
178	31684	5639752	13.3417	5.6252	2.25042	5.61798	559.20	24884.6
179	32041	5735339	13.3791	5.6357	2.25285	5.58659	562.35	25164.9
180	32400	5832000	13.4164	5.6462	2.25527	5.55556	565.49	25446.9
181	32761	5929741	13.4536	5.6567	2.25768	5.52486	568.63	25730.4
182	33124	6028568	13.4907	5.6671	2.26007	5.49451	571.77	26015.5
183	33489	6128487	13.5277	5.6774	2.26245	5.46448	574.91	26302.2
184	33856	6229504	13.5647	5.6877	2.26482	5.43478	578.05	26590.4
185	34225	6331625	13.6015	5.6980	2.26717	5.40541	581.19	26880.3
186	34596	6434856	13.6382	5.7083	2.26951	5.37634	584.34	27171.6
187	34969	6539203	13.6748	5.7185	2.27184	5.34759	587.48	27464.6
188	35344	6644672	13.7113	5.7287	2.27416	5.31915	590.62	27759.1
189	35721	6751269	13.7477	5.7388	2.27646	5.29101	593.76	28055.2
190	36100	6859000	13.7840	5.7489	2.27875	5.26316	596.90	28352.9
191	36481	6967871	13.8203	5.7590	2.28103	5.23560	600.04	28652.1
192	36864	7077888	13.8564	5.7690	2.28330	5.20833	603.19	28952.9
193	37249	7189057	13.8924	5.7790	2.28556	5.18135	606.33	29255.3
194	37636	7301384	13.9284	5.7890	2.28780	5.15464	609.47	29559.2
195	38025	7414875	13.9642	5.7989	2.29003	5.12821	612.61	29864.8
196	38416	7529536	14.0000	5.8088	2.29226	5.10204	615.75	30171.9
197	38809	7645373	14.0357	5.8186	2.29447	5.07614	618.89	30480.5
198	39204	7762392	14.0712	5.8285	2.29667	5.05051	622.04	30790.7
199	39601	7880599	14.1067	5.8383	2.29885	5.02513	625.18	31102.6

CARNEGIE STEEL COMPANY

FUNCTIONS OF NUMBERS, 200 TO 249

No.	Square	Cube	Square Root	Cubic Root	Logarithm	1000 x Reciprocal	No.—Diameter	
							Circum.	Area
200	40000	8000000	14.1421	5.8480	2.30103	5.00000	628.32	31415.9
201	40401	8120601	14.1774	5.8578	2.30320	4.97512	631.46	31730.9
202	40804	8242408	14.2127	5.8675	2.30535	4.95050	634.60	32047.4
203	41209	8365427	14.2478	5.8771	2.30750	4.92611	637.74	32365.5
204	41616	8489664	14.2829	5.8868	2.30963	4.90196	640.88	32685.1
205	42025	8615125	14.3178	5.8964	2.31175	4.87805	644.03	33006.4
206	42436	8741816	14.3527	5.9059	2.31387	4.85437	647.17	33329.2
207	42849	8869743	14.3875	5.9155	2.31597	4.83092	650.31	33653.5
208	43264	8998912	14.4222	5.9250	2.31806	4.80769	653.45	33979.5
209	43681	9129329	14.4568	5.9345	2.32015	4.78469	656.59	34307.0
210	44100	9261000	14.4914	5.9439	2.32222	4.76190	659.73	34636.1
211	44521	9393931	14.5258	5.9533	2.32428	4.73934	662.88	34966.7
212	44944	9528128	14.5602	5.9627	2.32634	4.71698	666.02	35298.9
213	45369	9663597	14.5945	5.9721	2.32838	4.69484	669.16	35632.7
214	45796	9800344	14.6287	5.9814	2.33041	4.67290	672.30	35968.1
215	46225	9938375	14.6629	5.9907	2.33244	4.65116	675.44	36305.0
216	46656	10077696	14.6969	6.0000	2.33445	4.62963	678.58	36643.5
217	47089	10218313	14.7309	6.0092	2.33646	4.60829	681.73	36983.6
218	47524	10360232	14.7648	6.0185	2.33846	4.58716	684.87	37325.3
219	47961	10503459	14.7986	6.0277	2.34044	4.56621	688.01	37668.5
220	48400	10648000	14.8324	6.0368	2.34242	4.54545	691.15	38013.3
221	48841	10793861	14.8661	6.0459	2.34439	4.52489	694.29	38359.6
222	49284	10941048	14.8997	6.0550	2.34635	4.50450	697.43	38707.6
223	49729	11089567	14.9332	6.0641	2.34830	4.48430	700.58	39057.1
224	50176	11239424	14.9666	6.0732	2.35025	4.46429	703.72	39408.1
225	50625	11390625	15.0000	6.0822	2.35218	4.44444	706.86	39760.8
226	51076	11543176	15.0333	6.0912	2.35411	4.42478	710.00	40115.0
227	51529	11697083	15.0665	6.1002	2.35603	4.40529	713.14	40470.8
228	51984	11852352	15.0997	6.1091	2.35793	4.38596	716.28	40828.1
229	52441	12008989	15.1327	6.1180	2.35984	4.36681	719.42	41187.1
230	52900	12167000	15.1658	6.1269	2.36173	4.34783	722.57	41547.6
231	53361	12326391	15.1987	6.1358	2.36361	4.32900	725.71	41909.6
232	53824	12487168	15.2315	6.1446	2.36549	4.31034	728.85	42273.3
233	54289	12649337	15.2643	6.1534	2.36736	4.29185	731.99	42638.5
234	54756	12812904	15.2971	6.1622	2.36922	4.27350	735.13	43005.3
235	55225	12977875	15.3297	6.1710	2.37107	4.25532	738.27	43373.6
236	55696	13144256	15.3623	6.1797	2.37291	4.23729	741.42	43743.5
237	56169	13312053	15.3948	6.1885	2.37475	4.21941	744.56	44115.0
238	56644	13481272	15.4272	6.1972	2.37658	4.20168	747.70	44488.1
239	57121	13651919	15.4596	6.2058	2.37840	4.18410	750.84	44862.7
240	57600	13824000	15.4919	6.2145	2.38021	4.16667	753.98	45238.9
241	58081	13997521	15.5242	6.2231	2.38202	4.14938	757.12	45616.7
242	58564	14172488	15.5563	6.2317	2.38382	4.13223	760.27	45996.1
243	59049	14348907	15.5885	6.2403	2.38561	4.11523	763.41	46377.0
244	59536	14526784	15.6205	6.2488	2.38739	4.09836	766.55	46759.5
245	60025	14706125	15.6525	6.2573	2.38917	4.08163	769.69	47143.5
246	60516	14886936	15.6844	6.2658	2.39094	4.06504	772.83	47529.2
247	61009	15069223	15.7162	6.2743	2.39270	4.04858	775.97	47916.4
248	61504	15252992	15.7480	6.2828	2.39445	4.03226	779.12	48305.1
249	62001	15438249	15.7797	6.2912	2.39620	4.01606	782.26	48695.5

MATHEMATICAL TABLES

FUNCTIONS OF NUMBERS, 250 TO 299

No.	Square	Cube	Square Root	Cubic Root	Logarithm	1000 x Reciprocal	No. — Diameter	
							Circum.	Area
250	62500	15625000	15.8114	6.2996	2.39794	4.00000	785.40	49087.4
251	63001	15813251	15.8430	6.3080	2.39967	3.98406	788.54	49480.9
252	63504	16003008	15.8745	6.3164	2.40140	3.96825	791.68	49875.9
253	64009	16194277	15.9060	6.3247	2.40312	3.95257	794.82	50272.6
254	64516	16387064	15.9374	6.3330	2.40483	3.93701	797.96	50670.7
255	65025	16581375	15.9687	6.3413	2.40654	3.92157	801.11	51070.5
256	65536	16777216	16.0000	6.3496	2.40824	3.90625	804.25	51471.9
257	66049	16974593	16.0312	6.3579	2.40993	3.89105	807.39	51874.8
258	66564	17173512	16.0624	6.3661	2.41162	3.87597	810.53	52279.2
259	67081	17373979	16.0935	6.3743	2.41330	3.86100	813.67	52685.3
260	67600	17576000	16.1245	6.3825	2.41497	3.84615	816.81	53092.9
261	68121	17779581	16.1555	6.3907	2.41664	3.83142	819.96	53502.1
262	68644	17984728	16.1864	6.3988	2.41830	3.81679	823.10	53912.9
263	69169	18191447	16.2173	6.4070	2.41996	3.80228	826.24	54325.2
264	69696	18399744	16.2481	6.4151	2.42160	3.78788	829.38	54739.1
265	70225	18609625	16.2788	6.4232	2.42325	3.77358	832.52	55154.6
266	70756	18821096	16.3095	6.4312	2.42488	3.75940	835.66	55571.6
267	71289	19034163	16.3401	6.4393	2.42651	3.74532	838.81	55990.2
268	71824	19248832	16.3707	6.4473	2.42813	3.73134	841.95	56410.4
269	72361	19465109	16.4012	6.4553	2.42975	3.71747	845.09	56832.2
270	72900	19683000	16.4317	6.4633	2.43136	3.70370	848.23	57255.5
271	73441	19902511	16.4621	6.4713	2.43297	3.69004	851.37	57680.4
272	73984	20123648	16.4924	6.4792	2.43457	3.67647	854.51	58106.9
273	74529	20346417	16.5227	6.4872	2.43616	3.66300	857.65	58534.9
274	75076	20570824	16.5529	6.4951	2.43775	3.64964	860.80	58964.6
275	75625	20796875	16.5831	6.5030	2.43933	3.63636	863.94	59395.7
276	76176	21024576	16.6132	6.5108	2.44091	3.62319	867.08	59828.5
277	76729	21253933	16.6433	6.5187	2.44248	3.61011	870.22	60262.8
278	77284	21484952	16.6733	6.5265	2.44404	3.59712	873.36	60698.7
279	77841	21717639	16.7033	6.5343	2.44560	3.58423	876.50	61136.2
280	78400	21952000	16.7332	6.5421	2.44716	3.57143	879.65	61575.2
281	78961	22188041	16.7631	6.5499	2.44871	3.55872	882.79	62015.8
282	79524	22425768	16.7929	6.5577	2.45025	3.54610	885.93	62458.0
283	80089	22665187	16.8226	6.5654	2.45179	3.53357	889.07	62901.8
284	80656	22906304	16.8523	6.5731	2.45332	3.52113	892.21	63347.1
285	81225	23149125	16.8819	6.5808	2.45484	3.50877	895.35	63794.0
286	81796	23393656	16.9115	6.5885	2.45637	3.49650	898.50	64242.4
287	82369	23639903	16.9411	6.5962	2.45788	3.48432	901.64	64692.5
288	82944	23887872	16.9706	6.6039	2.45939	3.47222	904.78	65144.1
289	83521	24137569	17.0000	6.6115	2.46090	3.46021	907.92	65597.2
290	84100	24389000	17.0294	6.6191	2.46240	3.44828	911.06	66052.0
291	84681	24642171	17.0587	6.6267	2.46389	3.43643	914.20	66508.3
292	85264	24897088	17.0880	6.6343	2.46538	3.42466	917.35	66966.2
293	85849	25153757	17.1172	6.6419	2.46687	3.41297	920.49	67425.6
294	86436	25412184	17.1464	6.6494	2.46835	3.40136	923.63	67886.7
295	87025	25672375	17.1756	6.6569	2.46982	3.38983	926.77	68349.3
296	87616	25934336	17.2047	6.6644	2.47129	3.37838	929.91	68813.4
297	88209	26198073	17.2337	6.6719	2.47276	3.36700	933.05	69279.2
298	88804	26463592	17.2627	6.6794	2.47422	3.35570	936.19	69746.5
299	89401	26730899	17.2916	6.6869	2.47567	3.34448	939.34	70215.4

CARNEGIE STEEL COMPANY

FUNCTIONS OF NUMBERS, 300 TO 349

No.	Square	Cube	Square Root	Cubic Root	Logarithm	1000 x Reciprocal	No. = Diameter	
							Circum.	Area
300	90000	27000000	17.3205	6.6943	2.47712	3.33333	942.48	70085.8
301	90601	27270901	17.3494	6.7018	2.47857	3.32226	945.62	71157.9
302	91204	27543608	17.3781	6.7092	2.48001	3.31126	948.76	71631.5
303	91809	27818127	17.4069	6.7166	2.48144	3.30033	951.90	72106.6
304	92416	28094464	17.4356	6.7240	2.48287	3.28947	955.04	72583.4
305	93025	28372625	17.4642	6.7313	2.48430	3.27869	958.19	73061.7
306	93636	28652616	17.4929	6.7387	2.48572	3.26797	961.33	73541.5
307	94249	28934443	17.5214	6.7460	2.48714	3.25733	964.47	74023.0
308	94864	29218112	17.5499	6.7533	2.48855	3.24675	967.61	74506.0
309	95481	29503629	17.5784	6.7606	2.48996	3.23625	970.75	74990.6
310	96100	29791000	17.6068	6.7679	2.49136	3.22581	973.89	75476.8
311	96721	30080231	17.6352	6.7752	2.49276	3.21543	977.04	75964.5
312	97344	30371328	17.6635	6.7824	2.49415	3.20513	980.18	76453.8
313	97969	30664297	17.6918	6.7897	2.49554	3.19489	983.32	76944.7
314	98596	30959144	17.7200	6.7969	2.49693	3.18471	986.46	77437.1
315	99225	31255875	17.7482	6.8041	2.49831	3.17460	989.60	77931.1
316	99856	31554496	17.7764	6.8113	2.49969	3.16456	992.74	78426.7
317	100489	31855013	17.8045	6.8185	2.50106	3.15457	995.88	78923.9
318	101124	32157432	17.8326	6.8256	2.50243	3.14465	999.03	79422.6
319	101761	32461759	17.8606	6.8328	2.50379	3.13480	1002.2	79922.9
320	102400	32768000	17.8885	6.8399	2.50515	3.12500	1005.3	80424.8
321	103041	33076161	17.9165	6.8470	2.50651	3.11526	1008.5	80928.2
322	103684	33386248	17.9444	6.8541	2.50786	3.10559	1011.6	81433.2
323	104329	33698267	17.9722	6.8612	2.50920	3.09598	1014.7	81939.8
324	104976	34012224	18.0000	6.8683	2.51055	3.08642	1017.9	82448.0
325	105625	34328125	18.0278	6.8753	2.51188	3.07692	1021.0	82957.7
326	106276	34645976	18.0555	6.8824	2.51322	3.06749	1024.2	83469.0
327	106929	34965783	18.0831	6.8894	2.51455	3.05810	1027.3	83981.8
328	107584	35287552	18.1108	6.8964	2.51587	3.04878	1030.4	84496.3
329	108241	35611289	18.1384	6.9034	2.51720	3.03951	1033.6	85012.3
330	108900	35937000	18.1659	6.9104	2.51851	3.03030	1036.7	85529.9
331	109561	36264691	18.1934	6.9174	2.51983	3.02115	1039.9	86049.0
332	110224	36594368	18.2209	6.9244	2.52114	3.01205	1043.0	86569.7
333	110889	36926037	18.2483	6.9313	2.52244	3.00300	1046.2	87092.0
334	111556	37259704	18.2757	6.9382	2.52375	2.99401	1049.3	87615.9
335	112225	37595375	18.3030	6.9451	2.52504	2.98507	1052.4	88141.3
336	112896	37933056	18.3303	6.9521	2.52634	2.97619	1055.6	88668.3
337	113569	38272753	18.3576	6.9589	2.52763	2.96736	1058.7	89196.9
338	114244	38614472	18.3848	6.9658	2.52892	2.95858	1061.9	89727.0
339	114921	38958219	18.4120	6.9727	2.53020	2.94985	1065.0	90258.7
340	115600	39304000	18.4391	6.9795	2.53148	2.94118	1068.1	90792.0
341	116281	39651821	18.4662	6.9864	2.53275	2.93255	1071.3	91326.9
342	116964	40001688	18.4932	6.9932	2.53403	2.92398	1074.4	91863.3
343	117649	40353607	18.5203	7.0000	2.53529	2.91545	1077.6	92401.3
344	118336	40707584	18.5472	7.0068	2.53656	2.90698	1080.7	92940.9
345	119025	41063625	18.5742	7.0136	2.53782	2.89855	1083.8	93482.0
346	119716	41421736	18.6011	7.0203	2.53908	2.89017	1087.0	94024.7
347	120409	41781923	18.6279	7.0271	2.54033	2.88184	1090.1	94569.0
348	121104	42144192	18.6548	7.0338	2.54158	2.87356	1093.3	95114.9
349	121801	42508549	18.6815	7.0406	2.54283	2.86533	1096.4	95662.3

MATHEMATICAL TABLES

FUNCTIONS OF NUMBERS, 350 TO 399

No.	Square	Cube	Square Root	Cubic Root	Logarithm	1000 x Reciprocal	No. = Diameter	
							Circum.	Area
350	122500	42875000	18.7083	7.0473	2.54407	2.85714	1099.6	96211.3
351	123201	43243551	18.7350	7.0540	2.54531	2.84900	1102.7	96761.8
352	123904	43614208	18.7617	7.0607	2.54654	2.84091	1105.8	97314.0
353	124609	43986977	18.7883	7.0674	2.54777	2.83286	1109.0	97867.7
354	125316	44361864	18.8149	7.0740	2.54900	2.82486	1112.1	98423.0
355	126025	44738875	18.8414	7.0807	2.55023	2.81690	1115.3	98979.8
356	126736	45118016	18.8680	7.0873	2.55145	2.80899	1118.4	99538.2
357	127449	45499293	18.8944	7.0940	2.55267	2.80112	1121.5	100098
358	128164	45882712	18.9209	7.1006	2.55388	2.79330	1124.7	100660
359	128881	46268279	18.9473	7.1072	2.55509	2.78552	1127.8	101223
360	129600	46656000	18.9737	7.1138	2.55630	2.77778	1131.0	101788
361	130321	47045881	19.0000	7.1204	2.55751	2.77008	1134.1	102354
362	131044	47437928	19.0263	7.1269	2.55871	2.76243	1137.3	102922
363	131769	47832147	19.0526	7.1335	2.55991	2.75482	1140.4	103491
364	132496	48228544	19.0788	7.1400	2.56110	2.74725	1143.5	104062
365	133225	48627125	19.1050	7.1466	2.56229	2.73973	1146.7	104635
366	133956	49027896	19.1311	7.1531	2.56348	2.73224	1149.8	105209
367	134689	49430863	19.1572	7.1596	2.56467	2.72480	1153.0	105785
368	135424	49836032	19.1833	7.1661	2.56585	2.71739	1156.1	106362
369	136161	50243409	19.2094	7.1726	2.56703	2.71003	1159.2	106941
370	136900	50653000	19.2354	7.1791	2.56820	2.70270	1162.4	107521
371	137641	51064811	19.2614	7.1855	2.56937	2.69542	1165.5	108103
372	138384	51478848	19.2873	7.1920	2.57054	2.68817	1168.7	108687
373	139129	51895117	19.3132	7.1984	2.57171	2.68097	1171.8	109272
374	139876	52313624	19.3391	7.2048	2.57287	2.67380	1175.0	109858
375	140625	52734375	19.3649	7.2112	2.57403	2.66667	1178.1	110447
376	141376	53157376	19.3907	7.2177	2.57519	2.65957	1181.2	111036
377	142129	53582633	19.4165	7.2240	2.57634	2.65252	1184.4	111628
378	142884	54011052	19.4422	7.2304	2.57749	2.64550	1187.5	112221
379	143641	54439939	19.4679	7.2368	2.57864	2.63852	1190.7	112815
380	144400	54872000	19.4936	7.2432	2.57978	2.63158	1193.8	113411
381	145161	55306341	19.5192	7.2495	2.58093	2.62467	1196.9	114009
382	145924	55742968	19.5448	7.2558	2.58206	2.61780	1200.1	114608
383	146689	56181887	19.5704	7.2622	2.58320	2.61097	1203.2	115209
384	147456	56623104	19.5959	7.2685	2.58433	2.60417	1206.4	115812
385	148225	57066625	19.6214	7.2748	2.58546	2.59740	1209.5	116416
386	148996	57512456	19.6469	7.2811	2.58659	2.59067	1212.7	117021
387	149769	57960603	19.6723	7.2874	2.58771	2.58398	1215.8	117628
388	150544	58411072	19.6977	7.2936	2.58883	2.57732	1218.9	118237
389	151321	58863869	19.7231	7.2999	2.58995	2.57069	1222.1	118847
390	152100	59319000	19.7484	7.3061	2.59106	2.56410	1225.2	119459
391	152881	59776471	19.7737	7.3124	2.59218	2.55754	1228.4	120072
392	153664	60236288	19.7990	7.3186	2.59329	2.55102	1231.5	120687
393	154449	60698457	19.8242	7.3248	2.59439	2.54453	1234.6	121304
394	155236	61162984	19.8494	7.3310	2.59550	2.53807	1237.8	121922
395	156025	61629875	19.8746	7.3372	2.59660	2.53165	1240.9	122542
396	156816	62099136	19.8997	7.3434	2.59770	2.52525	1244.1	123163
397	157609	62570773	19.9249	7.3496	2.59879	2.51889	1247.2	123786
398	158404	63044792	19.9499	7.3558	2.59988	2.51256	1250.4	124410
399	159201	63521199	19.9750	7.3619	2.60097	2.50627	1253.5	125036

CARNEGIE STEEL COMPANY

FUNCTIONS OF NUMBERS 400 TO 449

No.	Square	Cube	Square Root	Cubic Root	Logarithm	1000 x Reciprocal	No.—Diameter	
							Circum.	Area
400	160000	64000000	20.0000	7.3681	2.60206	2.50000	1256.6	125664
401	160801	64481201	20.0250	7.3742	2.60314	2.49377	1259.8	126293
402	161604	64964808	20.0499	7.3803	2.60423	2.48756	1262.9	126923
403	162409	65450827	20.0749	7.3864	2.60531	2.48139	1266.1	127556
404	163216	65939264	20.0998	7.3925	2.60638	2.47525	1269.2	128190
405	164025	66430125	20.1246	7.3986	2.60746	2.46914	1272.3	128825
406	164836	66923416	20.1494	7.4047	2.60853	2.46305	1275.5	129462
407	165649	67419143	20.1742	7.4108	2.60959	2.45700	1278.6	130100
408	166464	67917312	20.1990	7.4169	2.61066	2.45098	1281.8	130741
409	167281	68417929	20.2237	7.4229	2.61172	2.44499	1284.9	131382
410	168100	68921000	20.2485	7.4290	2.61278	2.43902	1288.1	132025
411	168921	69426531	20.2731	7.4350	2.61384	2.43309	1291.2	132670
412	169744	69934528	20.2978	7.4410	2.61490	2.42718	1294.3	133317
413	170569	70444997	20.3224	7.4470	2.61595	2.42131	1297.5	133965
414	171396	70957944	20.3470	7.4530	2.61700	2.41546	1300.6	134614
415	172225	71473375	20.3715	7.4590	2.61805	2.40964	1303.8	135265
416	173056	71991296	20.3961	7.4650	2.61909	2.40385	1306.9	135918
417	173889	72511713	20.4206	7.4710	2.62014	2.39808	1310.0	136572
418	174724	73034632	20.4450	7.4770	2.62118	2.39234	1313.2	137228
419	175561	73560059	20.4695	7.4829	2.62221	2.38663	1316.3	137885
420	176400	74088000	20.4939	7.4889	2.62325	2.38095	1319.5	138544
421	177241	74618461	20.5183	7.4948	2.62428	2.37530	1322.6	139205
422	178084	75151448	20.5426	7.5007	2.62531	2.36967	1325.8	139867
423	178929	75686967	20.5670	7.5067	2.62634	2.36407	1328.9	140531
424	179776	76225024	20.5913	7.5126	2.62737	2.35849	1332.0	141196
425	180625	76765625	20.6155	7.5185	2.62839	2.35294	1335.2	141863
426	181476	77308776	20.6398	7.5244	2.62941	2.34742	1338.3	142531
427	182329	77854483	20.6640	7.5302	2.63043	2.34192	1341.5	143201
428	183184	78402752	20.6882	7.5361	2.63144	2.33645	1344.6	143872
429	184041	78953589	20.7123	7.5420	2.63246	2.33100	1347.7	144545
430	184900	79507000	20.7364	7.5478	2.63347	2.32558	1350.9	145220
431	185761	80062991	20.7605	7.5537	2.63448	2.32019	1354.0	145896
432	186624	80621568	20.7846	7.5595	2.63548	2.31481	1357.2	146574
433	187489	81182737	20.8087	7.5654	2.63649	2.30947	1360.3	147254
434	188356	81746504	20.8327	7.5712	2.63749	2.30415	1363.5	147934
435	189225	82312875	20.8567	7.5770	2.63849	2.29885	1366.6	148617
436	190096	82881856	20.8806	7.5828	2.63949	2.29358	1369.7	149301
437	190969	83453453	20.9045	7.5886	2.64048	2.28833	1372.9	149987
438	191844	84027672	20.9284	7.5944	2.64147	2.28311	1376.0	150674
439	192721	84604519	20.9523	7.6001	2.64246	2.27790	1379.2	151363
440	193600	85184000	20.9762	7.6059	2.64345	2.27273	1382.3	152053
441	194481	85766121	21.0000	7.6117	2.64444	2.26757	1385.4	152745
442	195364	86350888	21.0238	7.6174	2.64542	2.26244	1388.6	153439
443	196249	86938307	21.0476	7.6232	2.64640	2.25734	1391.7	154134
444	197136	87528384	21.0713	7.6289	2.64738	2.25225	1394.9	154830
445	198025	88121125	21.0950	7.6346	2.64836	2.24719	1398.0	155528
446	198916	88716536	21.1187	7.6403	2.64933	2.24215	1401.2	156228
447	199809	89314623	21.1424	7.6460	2.65031	2.23714	1404.3	156930
448	200704	89915392	21.1660	7.6517	2.65128	2.23214	1407.4	157633
449	201601	90518849	21.1896	7.6574	2.65225	2.22717	1410.6	158337

MATHEMATICAL TABLES

FUNCTIONS OF NUMBERS, 450 TO 499

No.	Square	Cube	Square Root	Cubic Root	Logarithm	1000 x Reciprocal	No.—Diameter	
							Circum.	Area
450	202500	91125000	21.2132	7.6631	2.65321	2.22222	1413.7	159043
451	203401	91733851	21.2368	7.6688	2.65418	2.21729	1416.9	159751
452	204304	92345408	21.2603	7.6744	2.65514	2.21239	1420.0	160460
453	205209	92959677	21.2838	7.6801	2.65610	2.20751	1423.1	161171
454	206116	93576664	21.3073	7.6857	2.65706	2.20264	1426.3	161883
455	207025	94196375	21.3307	7.6914	2.65801	2.19780	1429.4	162597
456	207936	94818816	21.3542	7.6970	2.65896	2.19298	1432.6	163313
457	208849	95443993	21.3776	7.7026	2.65992	2.18818	1435.7	164030
458	209764	96071912	21.4009	7.7082	2.66087	2.18341	1438.8	164748
459	210681	96702579	21.4243	7.7138	2.66181	2.17865	1442.0	165468
460	211600	97336000	21.4476	7.7194	2.66276	2.17391	1445.1	166190
461	212521	97972181	21.4709	7.7250	2.66370	2.16920	1448.3	166914
462	213444	98611128	21.4942	7.7306	2.66464	2.16450	1451.4	167639
463	214369	99252847	21.5174	7.7362	2.66558	2.15983	1454.6	168365
464	215296	99897344	21.5407	7.7418	2.66652	2.15517	1457.7	169093
465	216225	10054625	21.5639	7.7473	2.66745	2.15054	1460.8	169823
466	217156	101194696	21.5870	7.7529	2.66839	2.14592	1464.0	170554
467	218089	101847563	21.6102	7.7584	2.66932	2.14133	1467.1	171287
468	219024	102503232	21.6333	7.7639	2.67025	2.13675	1470.3	172021
469	219961	103161700	21.6564	7.7695	2.67117	2.13220	1473.4	172757
470	220900	103823000	21.6795	7.7750	2.67210	2.12766	1476.5	173494
471	221841	104487111	21.7025	7.7805	2.67302	2.12314	1479.7	174234
472	222784	105154048	21.7256	7.7860	2.67394	2.11864	1482.8	174974
473	223729	105823817	21.7486	7.7915	2.67486	2.11416	1486.0	175716
474	224676	106496424	21.7715	7.7970	2.67578	2.10970	1489.1	176460
475	225625	107171875	21.7945	7.8025	2.67669	2.10526	1492.3	177205
476	226576	107850176	21.8174	7.8079	2.67761	2.10084	1495.4	177952
477	227529	108531333	21.8403	7.8134	2.67852	2.09644	1498.5	178701
478	228484	109215352	21.8632	7.8188	2.67943	2.09205	1501.7	179451
479	229441	109902239	21.8861	7.8243	2.68034	2.08768	1504.8	180203
480	230400	110592000	21.9089	7.8297	2.68124	2.08333	1508.0	180956
481	231361	111284641	21.9317	7.8352	2.68215	2.07900	1511.1	181711
482	232324	111980168	21.9545	7.8406	2.68305	2.07469	1514.2	182467
483	233289	112678587	21.9773	7.8460	2.68395	2.07039	1517.4	183225
484	234256	113379904	22.0000	7.8514	2.68485	2.06612	1520.5	183984
485	235225	114084125	22.0227	7.8568	2.68574	2.06186	1523.7	184745
486	236196	114791256	22.0454	7.8622	2.68664	2.05761	1526.8	185508
487	237169	115501303	22.0681	7.8676	2.68753	2.05339	1530.0	186272
488	238144	116214272	22.0907	7.8730	2.68842	2.04918	1533.1	187038
489	239121	116930169	22.1133	7.8784	2.68931	2.04499	1536.2	187805
490	240100	117649000	22.1359	7.8837	2.69020	2.04082	1539.4	188574
491	241081	118370771	22.1585	7.8891	2.69108	2.03666	1542.5	189345
492	242064	119095488	22.1811	7.8944	2.69197	2.03252	1545.7	190117
493	243049	119823157	22.2036	7.8998	2.69285	2.02840	1548.8	190890
494	244036	120553784	22.2261	7.9051	2.69373	2.02429	1551.9	191665
495	245025	121287375	22.2486	7.9105	2.69461	2.02020	1555.1	192442
496	246016	122023936	22.2711	7.9158	2.69548	2.01613	1558.2	193221
497	247009	122763473	22.2935	7.9211	2.69636	2.01207	1561.4	194000
498	248004	123505992	22.3159	7.9264	2.69723	2.00803	1564.5	194782
499	249001	124251499	22.3383	7.9317	2.69810	2.00401	1567.7	195565

CARNEGIE STEEL COMPANY

FUNCTIONS OF NUMBERS 500 TO 549

No.	Square	Cube	Square Root	Cubic Root	Logarithm	1000 x Reciprocal	No. = Diameter	
							Circum.	Area
500	250000	125000000	22.3607	7.9370	2.69897	2.00000	1570.8	196350
501	251001	125751501	22.3830	7.9423	2.69984	1.99601	1573.9	197136
502	252004	126506008	22.4054	7.9476	2.70070	1.99203	1577.1	197923
503	253009	127263527	22.4277	7.9528	2.70157	1.98807	1580.2	198713
504	254016	128024064	22.4499	7.9581	2.70243	1.98413	1583.4	199504
505	255025	128787625	22.4722	7.9634	2.70329	1.98020	1586.5	200296
506	256036	129554216	22.4944	7.9686	2.70415	1.97628	1589.6	201090
507	257049	130323843	22.5167	7.9739	2.70501	1.97239	1592.8	201886
508	258064	131096512	22.5389	7.9791	2.70586	1.96850	1595.9	202683
509	259081	131872229	22.5610	7.9843	2.70672	1.96464	1599.1	203482
510	260100	132651000	22.5832	7.9896	2.70757	1.96078	1602.2	204282
511	261121	133432831	22.6053	7.9948	2.70842	1.95695	1605.4	205084
512	262144	134217728	22.6274	8.0000	2.70927	1.95312	1608.5	205887
513	263169	135005697	22.6495	8.0052	2.71012	1.94932	1611.6	206692
514	264196	135796744	22.6716	8.0104	2.71096	1.94553	1614.8	207499
515	265225	136590875	22.6936	8.0156	2.71181	1.94175	1617.9	208307
516	266256	137388096	22.7156	8.0208	2.71265	1.93798	1621.1	209117
517	267289	138188413	22.7376	8.0260	2.71349	1.93424	1624.2	209928
518	268324	138991832	22.7596	8.0311	2.71433	1.93050	1627.3	210741
519	269361	139798359	22.7816	8.0363	2.71517	1.92678	1630.5	211556
520	270400	140608000	22.8035	8.0415	2.71600	1.92308	1633.6	212372
521	271441	141422761	22.8254	8.0466	2.71684	1.91939	1636.8	213189
522	272484	142236648	22.8473	8.0517	2.71767	1.91571	1639.9	214008
523	273529	143055667	22.8692	8.0569	2.71850	1.91205	1643.1	214829
524	274576	143877824	22.8910	8.0620	2.71933	1.90840	1646.2	215651
525	275625	144703125	22.9129	8.0671	2.72016	1.90476	1649.3	216475
526	276676	145531576	22.9347	8.0723	2.72099	1.90114	1652.5	217301
527	277729	146363183	22.9565	8.0774	2.72181	1.89753	1655.6	218128
528	278784	147197952	22.9783	8.0825	2.72263	1.89394	1658.8	218956
529	279841	148035889	23.0000	8.0876	2.72346	1.89036	1661.9	219787
530	280900	148877000	23.0217	8.0927	2.72428	1.88679	1665.0	220618
531	281961	149721291	23.0434	8.0978	2.72509	1.88324	1668.2	221452
532	283024	150568768	23.0651	8.1028	2.72591	1.87970	1671.3	222287
533	284089	151419437	23.0868	8.1079	2.72673	1.87617	1674.5	223123
534	285156	152273304	23.1084	8.1130	2.72754	1.87266	1677.6	223961
535	286225	153130375	23.1301	8.1180	2.72835	1.86916	1680.8	224801
536	287296	153990656	23.1517	8.1231	2.72916	1.86567	1683.9	225642
537	288369	154854153	23.1733	8.1281	2.72997	1.86220	1687.0	226484
538	289444	155720872	23.1948	8.1332	2.73078	1.85874	1690.2	227329
539	290521	156590819	23.2164	8.1382	2.73159	1.85529	1693.3	228175
540	291600	157464000	23.2379	8.1433	2.73239	1.85185	1696.5	229022
541	292681	158340421	23.2594	8.1483	2.73320	1.84843	1699.6	229871
542	293764	159220088	23.2809	8.1533	2.73400	1.84502	1702.7	230722
543	294849	160103007	23.3024	8.1583	2.73480	1.84162	1705.9	231574
544	295936	160989184	23.3238	8.1633	2.73560	1.83824	1709.0	232428
545	297025	161878625	23.3452	8.1683	2.73640	1.83486	1712.2	233283
546	298116	162771336	23.3666	8.1733	2.73719	1.83150	1715.3	234140
547	299209	163667323	23.3880	8.1783	2.73799	1.82815	1718.5	234998
548	300304	164566592	23.4094	8.1833	2.73878	1.82482	1721.6	235858
549	301401	165469149	23.4307	8.1882	2.73957	1.82149	1724.7	236720

MATHEMATICAL TABLES

FUNCTIONS OF NUMBERS, 550 TO 599

No.	Square	Cube	Square Root	Cubic Root	Logarithm	1000 x Reciprocal	No.—Diameter	
							Circum.	Area
550	302500	166375000	23.4521	8.1932	2.74036	1.81818	1727.9	237583
551	303601	167284151	23.4734	8.1982	2.74115	1.81488	1731.0	238448
552	304704	168196608	23.4947	8.2031	2.74194	1.81159	1734.2	239314
553	305809	169112377	23.5160	8.2081	2.74273	1.80832	1737.3	240182
554	306916	170031464	23.5372	8.2130	2.74351	1.80505	1740.4	241051
555	308025	170953875	23.5584	8.2180	2.74429	1.80180	1743.6	241922
556	309136	171879616	23.5797	8.2229	2.74507	1.79856	1746.7	242795
557	310249	172808693	23.6008	8.2278	2.74586	1.79533	1749.9	243669
558	311364	173741112	23.6220	8.2327	2.74663	1.79211	1753.0	244545
559	312481	174676879	23.6432	8.2377	2.74741	1.78891	1756.2	245422
560	313600	175616000	23.6643	8.2426	2.74819	1.78571	1759.3	246301
561	314721	176558481	23.6854	8.2475	2.74896	1.78253	1762.4	247181
562	315844	177504328	23.7065	8.2524	2.74974	1.77936	1765.6	248063
563	316969	178453547	23.7276	8.2573	2.75051	1.77620	1768.7	248947
564	318096	179406144	23.7487	8.2621	2.75128	1.77305	1771.9	249832
565	319225	180362125	23.7697	8.2670	2.75205	1.76991	1775.0	250719
566	320356	181321496	23.7908	8.2719	2.75282	1.76678	1778.1	251607
567	321489	182284263	23.8118	8.2768	2.75358	1.76367	1781.3	252497
568	322624	183250432	23.8328	8.2816	2.75435	1.76056	1784.4	253388
569	323761	184220009	23.8537	8.2865	2.75511	1.75747	1787.6	254281
570	324900	185193000	23.8747	8.2913	2.75587	1.75439	1790.7	255176
571	326041	186169411	23.8956	8.2962	2.75664	1.75131	1793.8	256072
572	327184	187149248	23.9165	8.3010	2.75740	1.74825	1797.0	256970
573	328329	188132517	23.9374	8.3059	2.75815	1.74520	1800.1	257869
574	329476	189119224	23.9583	8.3107	2.75891	1.74216	1803.3	258770
575	330625	190109375	23.9792	8.3155	2.75967	1.73913	1806.4	259672
576	331776	191102976	24.0000	8.3203	2.76042	1.73611	1809.6	260576
577	332929	192100033	24.0208	8.3251	2.76118	1.73310	1812.7	261482
578	334084	193100552	24.0416	8.3300	2.76193	1.73010	1815.8	262389
579	335241	194104539	24.0624	8.3348	2.76268	1.72712	1819.0	263298
580	336400	195112000	24.0832	8.3396	2.76343	1.72414	1822.1	264208
581	337561	196122941	24.1039	8.3444	2.76418	1.72117	1825.3	265120
582	338724	197137368	24.1247	8.3491	2.76492	1.71821	1828.4	266033
583	339889	198155287	24.1454	8.3539	2.76567	1.71527	1831.6	266948
584	341056	199176704	24.1661	8.3587	2.76641	1.71233	1834.7	267865
585	342225	200201625	24.1868	8.3634	2.76716	1.70940	1837.8	268783
586	343396	201230056	24.2074	8.3682	2.76790	1.70648	1841.0	269703
587	344569	202262003	24.2281	8.3730	2.76864	1.70358	1844.1	270624
588	345744	203297472	24.2487	8.3777	2.76938	1.70068	1847.3	271547
589	346921	204336469	24.2693	8.3825	2.77012	1.69779	1850.4	272471
590	348100	205379000	24.2899	8.3872	2.77085	1.69492	1853.5	273397
591	349281	206425071	24.3105	8.3919	2.77159	1.69205	1856.7	274325
592	350464	207474688	24.3311	8.3967	2.77232	1.68919	1859.8	275254
593	351649	208527857	24.3516	8.4014	2.77305	1.68634	1863.0	276184
594	352836	209584584	24.3721	8.4061	2.77379	1.68350	1866.1	277117
595	354025	210644875	24.3926	8.4108	2.77452	1.68067	1869.2	278051
596	355216	211708736	24.4131	8.4155	2.77525	1.67785	1872.4	278986
597	356409	212776173	24.4336	8.4202	2.77597	1.67504	1875.5	279923
598	357604	213847192	24.4540	8.4249	2.77670	1.67224	1878.7	280862
599	358801	214921799	24.4745	8.4296	2.77743	1.66945	1881.8	281802

CARNEGIE STEEL COMPANY

FUNCTIONS OF NUMBERS, 600 TO 649

No.	Square	Cube	Square Root	Cube Root	Logarithm	1000 x Reciprocal	No.—Diameter	
							Circum.	Area
600	360000	216000000	24.4949	8.4343	2.77815	1.66667	1885.0	282743
601	361201	217081801	24.5153	8.4390	2.77887	1.66389	1888.1	283687
602	362404	218167208	24.5357	8.4437	2.77960	1.66113	1891.2	284631
603	363609	219256227	24.5561	8.4484	2.78032	1.65837	1894.4	285578
604	364816	220348864	24.5764	8.4530	2.78104	1.65563	1897.5	286526
605	366025	221445125	24.5967	8.4577	2.78176	1.65289	1900.7	287475
606	367236	222545016	24.6171	8.4623	2.78247	1.65017	1903.8	288426
607	368449	223648543	24.6374	8.4670	2.78319	1.64745	1906.9	289379
608	369664	224755712	24.6577	8.4716	2.78390	1.64474	1910.1	290333
609	370881	225866529	24.6779	8.4763	2.78462	1.64204	1913.2	291289
610	372100	226981000	24.6982	8.4809	2.78533	1.63934	1916.4	292247
611	373321	228099131	24.7184	8.4856	2.78604	1.63666	1919.5	293206
612	374544	229220928	24.7386	8.4902	2.78675	1.63399	1922.7	294166
613	375769	230346397	24.7588	8.4948	2.78746	1.63132	1925.8	295128
614	376996	231475544	24.7790	8.4994	2.78817	1.62866	1928.9	296092
615	378225	232608375	24.7992	8.5040	2.78888	1.62602	1932.1	297057
616	379456	233744896	24.8193	8.5086	2.78958	1.62338	1935.2	298024
617	380689	234885113	24.8395	8.5132	2.79029	1.62075	1938.4	298992
618	381924	236029032	24.8596	8.5178	2.79099	1.61812	1941.5	299962
619	383161	237176659	24.8797	8.5224	2.79169	1.61551	1944.6	300934
620	384400	238328000	24.8998	8.5270	2.79239	1.61290	1947.8	301907
621	385641	239483061	24.9199	8.5316	2.79309	1.61031	1950.9	302882
622	386884	240641848	24.9399	8.5362	2.79379	1.60772	1954.1	303858
623	388129	241804367	24.9600	8.5408	2.79449	1.60514	1957.2	304836
624	389376	242970624	24.9800	8.5453	2.79518	1.60256	1960.4	305815
625	390625	244140625	25.0000	8.5499	2.79588	1.60000	1963.5	306796
626	391876	245314376	25.0200	8.5544	2.79657	1.59744	1966.6	307779
627	393129	246491883	25.0400	8.5590	2.79727	1.59490	1969.8	308763
628	394384	247673152	25.0599	8.5635	2.79796	1.59236	1972.9	309748
629	395641	248858189	25.0799	8.5681	2.79865	1.58983	1976.1	310736
630	396900	250047000	25.0998	8.5726	2.79934	1.58730	1979.2	311725
631	398161	251239591	25.1197	8.5772	2.80003	1.58479	1982.3	312715
632	399424	252435968	25.1396	8.5817	2.80072	1.58228	1985.5	313707
633	400689	253636137	25.1595	8.5862	2.80140	1.57978	1988.6	314700
634	401956	254840104	25.1794	8.5907	2.80209	1.57729	1991.8	315696
635	403225	256047875	25.1992	8.5952	2.80277	1.57480	1994.9	316692
636	404496	257259456	25.2190	8.5997	2.80346	1.57233	1998.1	317690
637	405769	258474853	25.2389	8.6043	2.80414	1.56986	2001.2	318690
638	407044	259694072	25.2587	8.6088	2.80482	1.56740	2004.3	319692
639	408321	260917119	25.2784	8.6132	2.80550	1.56495	2007.5	320695
640	409600	262144000	25.2982	8.6177	2.80618	1.56250	2010.6	321699
641	410881	263374721	25.3180	8.6222	2.80686	1.56006	2013.8	322705
642	412164	264609288	25.3377	8.6267	2.80754	1.55763	2016.9	323713
643	413449	265847707	25.3574	8.6312	2.80821	1.55521	2020.0	324722
644	414736	267089984	25.3772	8.6357	2.80889	1.55280	2023.2	325733
645	416025	268336125	25.3969	8.6401	2.80956	1.55039	2026.3	326745
646	417316	269586136	25.4165	8.6446	2.81023	1.54799	2029.5	327759
647	418609	270840023	25.4362	8.6490	2.81090	1.54560	2032.6	328775
648	419904	272097792	25.4558	8.6535	2.81158	1.54321	2035.8	329792
649	421201	273359449	25.4755	8.6579	2.81224	1.54083	2038.9	330810

MATHEMATICAL TABLE

FUNCTIONS OF NUMBERS, 650 TO 699

No.	Square	Cube	Square Root	Cubic Root	Logarithm	1000 x Reciprocal	No.—Diameter	
							Circum.	Area
650	422500	274625000	25.4951	8.6624	2.81291	1.53846	2042.0	331831
651	423801	275894451	25.5147	8.6668	2.81358	1.53610	2045.2	332853
652	425104	277167808	25.5343	8.6713	2.81425	1.53374	2048.3	333876
653	426409	278445077	25.5539	8.6757	2.81491	1.53139	2051.5	334901
654	427716	279726264	25.5734	8.6801	2.81558	1.52905	2054.6	335927
655	429025	281011375	25.5930	8.6845	2.81624	1.52672	2057.7	336955
656	430336	282300416	25.6125	8.6890	2.81690	1.52439	2060.9	337985
657	431649	283593393	25.6320	8.6934	2.81757	1.52207	2064.0	339016
658	432964	284890312	25.6515	8.6978	2.81823	1.51976	2067.2	340049
659	434281	286191179	25.6710	8.7022	2.81889	1.51745	2070.3	341084
660	435600	287496000	25.6905	8.7066	2.81954	1.51515	2073.5	342119
661	436921	288804781	25.7099	8.7110	2.82020	1.51286	2076.6	343157
662	438244	290117528	25.7294	8.7154	2.82086	1.51057	2079.7	344196
663	439569	291434247	25.7488	8.7198	2.82151	1.50830	2082.9	345237
664	440896	292754944	25.7682	8.7241	2.82217	1.50602	2086.0	346279
665	442225	294079625	25.7876	8.7285	2.82282	1.50376	2089.2	347323
666	443556	295408296	25.8070	8.7329	2.82347	1.50150	2092.3	348368
667	444889	296740963	25.8263	8.7373	2.82413	1.49925	2095.4	349415
668	446224	298077632	25.8457	8.7416	2.82478	1.49701	2098.6	350464
669	447561	299418309	25.8650	8.7460	2.82543	1.49477	2101.7	351514
670	448900	300763000	25.8844	8.7503	2.82607	1.49254	2104.9	352565
671	450241	302111711	25.9037	8.7547	2.82672	1.49031	2108.0	353618
672	451584	303464448	25.9230	8.7590	2.82737	1.48810	2111.2	354673
673	452929	304821217	25.9422	8.7634	2.82802	1.48588	2114.3	355730
674	454276	306182024	25.9615	8.7677	2.82866	1.48368	2117.4	356788
675	455625	307546875	25.9808	8.7721	2.82930	1.48148	2120.6	357847
676	456976	308915776	26.0000	8.7764	2.82995	1.47929	2123.7	358908
677	458329	310288733	26.0192	8.7807	2.83059	1.47710	2126.9	359971
678	459684	311665752	26.0384	8.7850	2.83123	1.47493	2130.0	361035
679	461041	313046839	26.0576	8.7893	2.83187	1.47275	2133.1	362101
680	462400	314432000	26.0768	8.7937	2.83251	1.47059	2136.3	363168
681	463761	315821241	26.0960	8.7980	2.83315	1.46843	2139.4	364237
682	465124	317214568	26.1151	8.8023	2.83378	1.46628	2142.6	365308
683	466489	318611987	26.1343	8.8066	2.83442	1.46413	2145.7	366380
684	467856	320013504	26.1534	8.8109	2.83506	1.46199	2148.8	367453
685	469225	321419125	26.1725	8.8152	2.83569	1.45985	2152.0	368528
686	470596	322828856	26.1916	8.8194	2.83632	1.45773	2155.1	369605
687	471969	324242703	26.2107	8.8237	2.83696	1.45560	2158.3	370684
688	473344	325660672	26.2298	8.8280	2.83759	1.45349	2161.4	371764
689	474721	327082769	26.2488	8.8323	2.83822	1.45138	2164.6	372845
690	476100	328509000	26.2679	8.8366	2.83885	1.44928	2167.7	373928
691	477481	329939371	26.2869	8.8408	2.83948	1.44718	2170.8	375013
692	478864	331373888	26.3059	8.8451	2.84011	1.44509	2174.0	376099
693	480249	332812557	26.3249	8.8493	2.84073	1.44300	2177.1	377187
694	481636	334255384	26.3439	8.8536	2.84136	1.44092	2180.3	378276
695	483025	335703375	26.3629	8.8578	2.84198	1.43885	2183.4	379367
696	484416	337155536	26.3818	8.8621	2.84261	1.43678	2186.5	380459
697	485809	338608873	26.4008	8.8663	2.84323	1.43472	2189.7	381553
698	487204	340068392	26.4197	8.8706	2.84386	1.43266	2192.8	382649
699	488601	341532099	26.4386	8.8748	2.84448	1.43062	2196.0	383746

CARNEGIE STEEL COMPANY

FUNCTIONS OF NUMBERS, 700 TO 749

No.	Square	Cube	Square Root	Cubic Root	Logarithm	1000 x Reciprocal	No.—Diameter	
							Circum.	Area
700	490000	343000000	26.4575	8.8790	2.84510	1.42857	2199.1	384845
701	491401	344472101	26.4764	8.8833	2.84572	1.42653	2202.3	385945
702	492804	345948408	26.4953	8.8875	2.84634	1.42450	2205.4	387047
703	494209	347428927	26.5141	8.8917	2.84696	1.42248	2208.5	388151
704	495616	348913664	26.5330	8.8959	2.84757	1.42045	2211.7	389256
705	497025	350402625	26.5518	8.9001	2.84819	1.41844	2214.8	390363
706	498436	351895816	26.5707	8.9043	2.84880	1.41643	2218.0	391471
707	499849	353393243	26.5895	8.9085	2.84942	1.41443	2221.1	392580
708	501264	354894912	26.6083	8.9127	2.85003	1.41243	2224.2	393692
709	502681	356400829	26.6271	8.9169	2.85065	1.41044	2227.4	394805
710	504100	357911000	26.6458	8.9211	2.85126	1.40845	2230.5	395919
711	505521	359425431	26.6646	8.9253	2.85187	1.40647	2233.7	397035
712	506944	360944128	26.6833	8.9295	2.85248	1.40449	2236.8	398153
713	508369	362467097	26.7021	8.9337	2.85309	1.40252	2240.0	399272
714	509796	363994344	26.7208	8.9378	2.85370	1.40056	2243.1	400393
715	511225	365525875	26.7395	8.9420	2.85431	1.39860	2246.2	401515
716	512656	367061696	26.7582	8.9462	2.85491	1.39665	2249.4	402639
717	514089	368601813	26.7769	8.9503	2.85552	1.39470	2252.5	403765
718	515524	370146232	26.7955	8.9545	2.85612	1.39276	2255.7	404892
719	516961	371694959	26.8142	8.9587	2.85673	1.39082	2258.8	406020
720	518400	373248000	26.8328	8.9628	2.85733	1.38889	2261.9	407150
721	519841	374805361	26.8514	8.9670	2.85794	1.38696	2265.1	408282
722	521284	376367048	26.8701	8.9711	2.85854	1.38504	2268.2	409415
723	522729	377933067	26.8887	8.9752	2.85914	1.38313	2271.4	410550
724	524176	379503424	26.9072	8.9794	2.85974	1.38122	2274.5	411687
725	525625	381078125	26.9258	8.9835	2.86034	1.37931	2277.7	412825
726	527076	382657176	26.9444	8.9876	2.86094	1.37741	2280.8	413965
727	528529	384240583	26.9629	8.9918	2.86153	1.37552	2283.9	415106
728	529984	385828352	26.9815	8.9959	2.86213	1.37363	2287.1	416248
729	531441	387420489	27.0000	9.0000	2.86273	1.37174	2290.2	417393
730	532900	389017000	27.0185	9.0041	2.86332	1.36986	2293.4	418539
731	534361	390617891	27.0370	9.0082	2.86392	1.36799	2296.5	419686
732	535824	392223168	27.0555	9.0123	2.86451	1.36612	2299.6	420835
733	537289	393832837	27.0740	9.0164	2.86510	1.36426	2302.8	421986
734	538756	395446904	27.0924	9.0205	2.86570	1.36240	2305.9	423138
735	540225	397065375	27.1109	9.0246	2.86629	1.36054	2309.1	424293
736	541696	398688256	27.1293	9.0287	2.86688	1.35870	2312.2	425447
737	543169	400315553	27.1477	9.0328	2.86747	1.35685	2315.4	426604
738	544644	401947272	27.1662	9.0369	2.86806	1.35501	2318.5	427762
739	546121	403583419	27.1846	9.0410	2.86864	1.35318	2321.6	428922
740	547600	405224000	27.2029	9.0450	2.86923	1.35135	2324.8	430084
741	549081	406869021	27.2213	9.0491	2.86982	1.34953	2327.9	431247
742	550564	408518488	27.2397	9.0532	2.87040	1.34771	2331.1	432412
743	552049	410172407	27.2580	9.0572	2.87099	1.34590	2334.2	433578
744	553536	411830784	27.2764	9.0613	2.87157	1.34409	2337.3	434746
745	555025	413493625	27.2947	9.0654	2.87216	1.34228	2340.5	435916
746	556516	415160936	27.3130	9.0694	2.87274	1.34048	2343.6	437087
747	558009	416832723	27.3313	9.0735	2.87332	1.33869	2346.8	438259
748	559504	418508992	27.3496	9.0775	2.87390	1.33690	2349.9	439433
749	561001	420189749	27.3679	9.0816	2.87448	1.33511	2353.1	440609

MATHEMATICAL TABLES

FUNCTIONS OF NUMBERS, 750 TO 799

No.	Square	Cube	Square Root	Cubic Root	Logarithm	1000 x Reciprocal	No.—Diameter	
							Circum.	Area
750	562500	421875000	27.3861	9.0856	2.87506	1.33333	2356.2	441786
751	564001	423564751	27.4044	9.0896	2.87564	1.33156	2359.3	442965
752	565504	425259008	27.4226	9.0937	2.87622	1.32979	2362.5	444146
753	567009	426953265	27.4408	9.0977	2.87680	1.32802	2365.6	445328
754	568516	428647522	27.4591	9.1017	2.87737	1.32626	2368.8	446511
755	570025	430341779	27.4773	9.1057	2.87795	1.32450	2371.9	447697
756	571536	432036036	27.4955	9.1098	2.87852	1.32275	2375.0	448883
757	573049	433730293	27.5136	9.1138	2.87910	1.32100	2378.2	450072
758	574564	435424549	27.5318	9.1178	2.87967	1.31926	2381.3	451262
759	576081	437118806	27.5500	9.1218	2.88024	1.31752	2384.5	452453
760	577600	438813063	27.5681	9.1258	2.88081	1.31579	2387.6	453646
761	579121	440507320	27.5862	9.1298	2.88138	1.31406	2390.8	454841
762	580644	442201577	27.6043	9.1338	2.88196	1.31234	2393.9	456037
763	582169	443895834	27.6225	9.1378	2.88252	1.31062	2397.0	457234
764	583696	445590091	27.6405	9.1418	2.88309	1.30890	2400.2	458434
765	585225	447284348	27.6586	9.1458	2.88366	1.30719	2403.3	459635
766	586756	448978605	27.6767	9.1498	2.88423	1.30548	2406.5	460837
767	588289	450672862	27.6948	9.1538	2.88480	1.30378	2409.6	462041
768	589824	452367119	27.7128	9.1577	2.88536	1.30208	2412.7	463247
769	591361	454061376	27.7308	9.1617	2.88593	1.30039	2415.9	464454
770	592900	455755633	27.7489	9.1657	2.88649	1.29870	2419.0	465663
771	594441	457449890	27.7669	9.1696	2.88705	1.29702	2422.2	466873
772	595984	459144147	27.7849	9.1736	2.88762	1.29534	2425.3	468085
773	597529	460838404	27.8029	9.1775	2.88818	1.29366	2428.5	469298
774	599076	462532661	27.8209	9.1815	2.88874	1.29199	2431.6	470513
775	600625	464226918	27.8388	9.1855	2.88930	1.29032	2434.7	471730
776	602176	465921175	27.8568	9.1894	2.88986	1.28866	2437.9	472948
777	603729	467615432	27.8747	9.1933	2.89042	1.28700	2441.0	474168
778	605284	469309689	27.8927	9.1973	2.89098	1.28535	2444.2	475389
779	606841	471003946	27.9106	9.2012	2.89154	1.28370	2447.3	476612
780	608400	472698203	27.9285	9.2052	2.89209	1.28205	2450.4	477836
781	609961	474392460	27.9464	9.2091	2.89265	1.28041	2453.6	479062
782	611524	476086717	27.9643	9.2130	2.89321	1.27877	2456.7	480290
783	613089	477780974	27.9821	9.2170	2.89376	1.27714	2459.9	481519
784	614656	479475231	28.0000	9.2209	2.89432	1.27551	2463.0	482750
785	616225	481169488	28.0179	9.2248	2.89487	1.27389	2466.2	483982
786	617796	482863745	28.0357	9.2287	2.89542	1.27226	2469.3	485216
787	619369	484558002	28.0535	9.2326	2.89597	1.27065	2472.4	486451
788	620944	486252259	28.0713	9.2365	2.89653	1.26904	2475.6	487688
789	622521	487946516	28.0891	9.2404	2.89708	1.26743	2478.7	488927
790	624100	489640773	28.1069	9.2443	2.89763	1.26582	2481.9	490167
791	625681	491335030	28.1247	9.2482	2.89818	1.26422	2485.0	491409
792	627264	493029287	28.1425	9.2521	2.89873	1.26263	2488.1	492652
793	628849	494723544	28.1603	9.2560	2.89927	1.26103	2491.3	493897
794	630436	496417801	28.1780	9.2599	2.89982	1.25945	2494.4	495143
795	632025	498112058	28.1957	9.2638	2.90037	1.25786	2497.6	496391
796	633616	499806315	28.2135	9.2677	2.90091	1.25628	2500.7	497641
797	635209	501500572	28.2312	9.2716	2.90146	1.25471	2503.8	498892
798	636804	503194829	28.2489	9.2754	2.90200	1.25313	2507.0	500145
799	638401	504889086	28.2666	9.2793	2.90255	1.25156	2510.1	501399

CARNEGIE STEEL COMPANY

FUNCTIONS OF NUMBERS, 800 TO 849

No.	Square	Cube	Square Root	Cubic Root	Logarithm	1000 x Reciprocal	No. = Diameter	
							Circum.	Area
800	640000	512000000	28.2843	9.2832	2.90309	1.25000	2513.3	502655
801	641601	513922401	28.3019	9.2870	2.90363	1.24844	2516.4	503912
802	643204	515849608	28.3196	9.2909	2.90417	1.24688	2519.6	505171
803	644809	517781627	28.3373	9.2948	2.90472	1.24533	2522.7	506432
804	646416	519718464	28.3549	9.2986	2.90526	1.24378	2525.8	507694
805	648025	521660125	28.3725	9.3025	2.90580	1.24224	2529.0	508958
806	649636	523606616	28.3901	9.3063	2.90634	1.24069	2532.1	510223
807	651249	525557943	28.4077	9.3102	2.90687	1.23916	2535.3	511490
808	652864	527514112	28.4253	9.3140	2.90741	1.23762	2538.4	512758
809	654481	529475129	28.4429	9.3179	2.90795	1.23609	2541.5	514028
810	656100	531441000	28.4605	9.3217	2.90849	1.23457	2544.7	515300
811	657721	533411731	28.4781	9.3255	2.90902	1.23305	2547.8	516573
812	659344	535387328	28.4956	9.3294	2.90956	1.23153	2551.0	517848
813	660969	537367797	28.5132	9.3332	2.91009	1.23001	2554.1	519124
814	662596	539353144	28.5307	9.3370	2.91062	1.22850	2557.3	520402
815	664225	541343375	28.5482	9.3408	2.91116	1.22699	2560.4	521681
816	665856	543338496	28.5657	9.3447	2.91169	1.22549	2563.5	522962
817	667489	545338513	28.5832	9.3485	2.91222	1.22399	2566.7	524245
818	669124	547343432	28.6007	9.3523	2.91275	1.22249	2569.8	525529
819	670761	549353259	28.6182	9.3561	2.91328	1.22100	2573.0	526814
820	672400	551368000	28.6356	9.3599	2.91381	1.21951	2576.1	528102
821	674041	553387661	28.6531	9.3637	2.91434	1.21803	2579.2	529391
822	675684	555412248	28.6705	9.3675	2.91487	1.21655	2582.4	530681
823	677329	557441767	28.6880	9.3713	2.91540	1.21507	2585.5	531973
824	678976	559476224	28.7054	9.3751	2.91593	1.21359	2588.7	533267
825	680625	561515625	28.7228	9.3789	2.91645	1.21212	2591.8	534562
826	682276	563559976	28.7402	9.3827	2.91698	1.21065	2595.0	535858
827	683929	565609283	28.7576	9.3865	2.91751	1.20919	2598.1	537157
828	685584	567663522	28.7750	9.3902	2.91803	1.20773	2601.2	538456
829	687241	569722789	28.7924	9.3940	2.91855	1.20627	2604.4	539758
830	688900	571787000	28.8097	9.3978	2.91908	1.20482	2607.5	541061
831	690561	573856191	28.8271	9.4016	2.91960	1.20337	2610.7	542365
832	692224	575930368	28.8444	9.4053	2.92012	1.20192	2613.8	543671
833	693889	578009537	28.8617	9.4091	2.92065	1.20048	2616.9	544979
834	695556	580093704	28.8791	9.4129	2.92117	1.19904	2620.1	546288
835	697225	582182875	28.8964	9.4166	2.92169	1.19760	2623.2	547599
836	698896	584277056	28.9137	9.4204	2.92221	1.19617	2626.4	548912
837	700569	586376253	28.9310	9.4241	2.92273	1.19474	2629.5	550226
838	702244	588480472	28.9482	9.4279	2.92324	1.19332	2632.7	551541
839	703921	590589719	28.9655	9.4316	2.92376	1.19190	2635.8	552858
840	705600	592704000	28.9828	9.4354	2.92428	1.19048	2638.9	554177
841	707281	594823321	29.0000	9.4391	2.92480	1.18906	2642.1	555497
842	708964	596947688	29.0172	9.4429	2.92531	1.18765	2645.2	556819
843	710649	599077107	29.0345	9.4466	2.92583	1.18624	2648.4	558142
844	712336	601211584	29.0517	9.4503	2.92634	1.18483	2651.5	559467
845	714025	603351125	29.0689	9.4541	2.92686	1.18343	2654.6	560794
846	715716	605495736	29.0861	9.4578	2.92737	1.18203	2657.8	562122
847	717409	607645423	29.1033	9.4615	2.92788	1.18064	2660.9	563452
848	719104	609800192	29.1204	9.4652	2.92840	1.17925	2664.1	564783
849	720801	611960049	29.1376	9.4690	2.92891	1.17786	2667.2	566116

MATHEMATICAL TABLES

FUNCTIONS OF NUMBERS, 850 TO 899

No.	Square	Cube	Square Root	Cubic Root	Logarithm	1000 x Reciprocal	No. = Diameter	
							Circum.	Area
850	722500	614125000	29.1548	9.4727	2.92942	1.17647	2670.4	567450
851	724201	616295051	29.1719	9.4764	2.92993	1.17509	2673.5	568786
852	725904	618470208	29.1890	9.4801	2.93044	1.17371	2676.6	570124
853	727609	620650477	29.2062	9.4838	2.93095	1.17233	2679.8	571463
854	729316	622835864	29.2233	9.4875	2.93146	1.17096	2682.9	572803
855	731025	625026375	29.2404	9.4912	2.93197	1.16959	2686.1	574146
856	732736	627222016	29.2575	9.4949	2.93247	1.16822	2689.2	575490
857	734449	629422793	29.2746	9.4986	2.93298	1.16686	2692.3	576835
858	736164	631628712	29.2916	9.5023	2.93349	1.16550	2695.5	578182
859	737881	633839779	29.3087	9.5060	2.93399	1.16414	2698.6	579530
860	739600	636056000	29.3258	9.5097	2.93450	1.16279	2701.8	580880
861	741321	638277381	29.3428	9.5134	2.93500	1.16144	2704.9	582232
862	743044	640503928	29.3598	9.5171	2.93551	1.16009	2708.1	583585
863	744769	642735647	29.3769	9.5207	2.93601	1.15875	2711.2	584940
864	746496	644972544	29.3939	9.5244	2.93651	1.15741	2714.3	586297
865	748225	647214625	29.4109	9.5281	2.93702	1.15607	2717.5	587655
866	749956	649461896	29.4279	9.5317	2.93752	1.15473	2720.6	589014
867	751689	651714363	29.4449	9.5354	2.93802	1.15340	2723.8	590375
868	753424	653972032	29.4618	9.5391	2.93852	1.15207	2726.9	591738
869	755161	656234909	29.4788	9.5427	2.93902	1.15075	2730.0	593102
870	756900	658503000	29.4958	9.5464	2.93952	1.14943	2733.2	594468
871	758641	660776311	29.5127	9.5501	2.94002	1.14811	2736.3	595835
872	760384	663054848	29.5296	9.5537	2.94052	1.14679	2739.5	597204
873	762129	665338617	29.5466	9.5574	2.94101	1.14548	2742.6	598575
874	763876	667627624	29.5635	9.5610	2.94151	1.14416	2745.8	599947
875	765625	669921875	29.5804	9.5647	2.94201	1.14286	2748.9	601320
876	767376	672221376	29.5973	9.5683	2.94250	1.14155	2752.0	602696
877	769129	674526133	29.6142	9.5719	2.94300	1.14025	2755.2	604073
878	770884	676836152	29.6311	9.5756	2.94349	1.13895	2758.3	605451
879	772641	679151439	29.6479	9.5792	2.94399	1.13766	2761.5	606831
880	774400	681472000	29.6648	9.5828	2.94448	1.13636	2764.6	608212
881	776161	683797841	29.6816	9.5865	2.94498	1.13507	2767.7	609595
882	777924	686128968	29.6985	9.5901	2.94547	1.13379	2770.9	610980
883	779689	688465387	29.7153	9.5937	2.94596	1.13250	2774.0	612366
884	781456	690807104	29.7321	9.5973	2.94645	1.13122	2777.2	613754
885	783225	693154125	29.7489	9.6010	2.94694	1.12994	2780.3	615143
886	784996	695506456	29.7658	9.6046	2.94743	1.12867	2783.5	616534
887	786769	697864103	29.7825	9.6082	2.94792	1.12740	2786.6	617927
888	788544	700227072	29.7993	9.6118	2.94841	1.12613	2789.7	619321
889	790321	702595369	29.8161	9.6154	2.94890	1.12486	2792.9	620717
890	792100	704969000	29.8329	9.6190	2.94939	1.12360	2796.0	622114
891	793881	707347971	29.8496	9.6226	2.94988	1.12233	2799.2	623513
892	795664	709732288	29.8664	9.6262	2.95036	1.12108	2802.3	624913
893	797449	712121957	29.8831	9.6298	2.95085	1.11982	2805.4	626315
894	799236	714516984	29.8998	9.6334	2.95134	1.11857	2808.6	627718
895	801025	716917375	29.9166	9.6370	2.95182	1.11732	2811.7	629124
896	802816	719323136	29.9333	9.6406	2.95231	1.11607	2814.9	630530
897	804609	721734273	29.9500	9.6442	2.95279	1.11483	2818.0	631938
898	806404	724150792	29.9666	9.6477	2.95328	1.11359	2821.2	633348
899	808201	726572699	29.9833	9.6513	2.95376	1.11235	2824.3	634760

CARNEGIE STEEL COMPANY

FUNCTIONS OF NUMBERS, 900 TO 949

No.	Square	Cube	Square Root	Cubic Root	Logarithm	1000 x Reciprocal	No.—Diameter	
							Circum.	Area
900	810000	729000000	30.0000	9.6549	2.95424	1.11111	2827.4	636173
901	811801	731432701	30.0167	9.6585	2.95472	1.10988	2830.6	637587
902	813604	733870808	30.0333	9.6620	2.95521	1.10865	2833.7	639003
903	815409	736314327	30.0500	9.6656	2.95569	1.10742	2836.9	640421
904	817216	738763264	30.0666	9.6692	2.95617	1.10619	2840.0	641840
905	819025	741217625	30.0832	9.6727	2.95665	1.10497	2843.1	643261
906	820836	743677416	30.0998	9.6763	2.95713	1.10375	2846.3	644683
907	822649	746142643	30.1164	9.6799	2.95761	1.10254	2849.4	646107
908	824464	748613312	30.1330	9.6834	2.95809	1.10132	2852.6	647533
909	826281	751089429	30.1496	9.6870	2.95856	1.10011	2855.7	648960
910	828100	753571000	30.1662	9.6905	2.95904	1.09890	2858.8	650388
911	829921	756058031	30.1828	9.6941	2.95952	1.09769	2862.0	651818
912	831744	758550528	30.1993	9.6976	2.95999	1.09649	2865.1	653250
913	833569	761048497	30.2159	9.7012	2.96047	1.09529	2868.3	654684
914	835396	763551944	30.2324	9.7047	2.96095	1.09409	2871.4	656118
915	837225	766060875	30.2490	9.7082	2.96142	1.09290	2874.6	657555
916	839056	768575296	30.2655	9.7118	2.96190	1.09170	2877.7	658993
917	840889	771095213	30.2820	9.7153	2.96237	1.09051	2880.8	660433
918	842724	773620632	30.2985	9.7188	2.96284	1.08932	2884.0	661874
919	844561	776151559	30.3150	9.7224	2.96332	1.08814	2887.1	663317
920	846400	778688000	30.3315	9.7259	2.96379	1.08696	2890.3	664761
921	848241	781229961	30.3480	9.7294	2.96426	1.08578	2893.4	666207
922	850084	783777448	30.3645	9.7329	2.96473	1.08460	2896.5	667654
923	851929	786330467	30.3809	9.7364	2.96520	1.08342	2899.7	669103
924	853776	788889024	30.3974	9.7400	2.96567	1.08225	2902.8	670554
925	855625	791453125	30.4138	9.7435	2.96614	1.08108	2906.0	672006
926	857476	794022776	30.4302	9.7470	2.96661	1.07991	2909.1	673460
927	859329	796597983	30.4467	9.7505	2.96708	1.07875	2912.3	674915
928	861184	799178752	30.4631	9.7540	2.96755	1.07759	2915.4	676372
929	863041	801765089	30.4795	9.7575	2.96802	1.07643	2918.5	677831
930	864900	804357000	30.4959	9.7610	2.96848	1.07527	2921.7	679291
931	866761	806954491	30.5123	9.7645	2.96895	1.07411	2924.8	680752
932	868624	809557568	30.5287	9.7680	2.96942	1.07296	2928.0	682216
933	870489	812166237	30.5450	9.7715	2.96988	1.07181	2931.1	683680
934	872356	814780504	30.5614	9.7750	2.97035	1.07066	2934.2	685147
935	874225	817400375	30.5778	9.7785	2.97081	1.06952	2937.4	686615
936	876096	820025856	30.5941	9.7819	2.97128	1.06838	2940.5	688084
937	877969	822656953	30.6105	9.7854	2.97174	1.06724	2943.7	689555
938	879844	825293672	30.6268	9.7889	2.97220	1.06610	2946.8	691028
939	881721	827936019	30.6431	9.7924	2.97267	1.06496	2950.0	692502
940	883600	830584000	30.6594	9.7959	2.97313	1.06383	2953.1	693978
941	885481	833237621	30.6757	9.7993	2.97359	1.06270	2956.2	695455
942	887364	835896888	30.6920	9.8028	2.97405	1.06157	2959.4	696934
943	889249	838561807	30.7083	9.8063	2.97451	1.06045	2962.5	698415
944	891136	841232384	30.7246	9.8097	2.97497	1.05932	2965.7	699897
945	893025	843908625	30.7409	9.8132	2.97543	1.05820	2968.8	701380
946	894916	846590536	30.7571	9.8167	2.97589	1.05708	2971.9	702865
947	896809	849278123	30.7734	9.8201	2.97635	1.05597	2975.1	704352
948	898704	851971392	30.7896	9.8236	2.97681	1.05485	2978.2	705840
949	900601	854670349	30.8058	9.8270	2.97727	1.05374	2981.4	707330

MATHEMATICAL TABLES

FUNCTIONS OF NUMBERS, 950 TO 999

No.	Square	Cube	Square Root	Cubic Root	Logarithm	1000 x Reciprocal	No.—Diameter	
							Circum.	Area
950	902500	857375000	30.8221	9.8305	2.97772	1.05263	2984.5	708822
951	904401	860085351	30.8383	9.8339	2.97818	1.05152	2987.7	710315
952	906304	862801408	30.8545	9.8374	2.97864	1.05042	2990.8	711809
953	908209	865523177	30.8707	9.8408	2.97909	1.04932	2993.9	713306
954	910116	868250664	30.8869	9.8443	2.97955	1.04822	2997.1	714803
955	912025	870983875	30.9031	9.8477	2.98000	1.04712	3000.2	716303
956	913936	873722816	30.9192	9.8511	2.98046	1.04603	3003.4	717804
957	915849	876467493	30.9354	9.8546	2.98091	1.04493	3006.5	719306
958	917764	879217912	30.9516	9.8580	2.98137	1.04384	3009.6	720810
959	919681	881974079	30.9677	9.8614	2.98182	1.04275	3012.8	722316
960	921600	884736000	30.9839	9.8648	2.98227	1.04167	3015.9	723823
961	923521	887503681	31.0000	9.8683	2.98272	1.04058	3019.1	725332
962	925444	890277128	31.0161	9.8717	2.98318	1.03950	3022.2	726842
963	927369	893056347	31.0322	9.8751	2.98363	1.03842	3025.4	728354
964	929296	895841344	31.0483	9.8785	2.98408	1.03734	3028.5	729867
965	931225	898632125	31.0644	9.8819	2.98453	1.03627	3031.6	731382
966	933156	901428696	31.0805	9.8854	2.98498	1.03520	3034.8	732899
967	935089	904231063	31.0966	9.8888	2.98543	1.03413	3037.9	734417
968	937024	907039232	31.1127	9.8922	2.98588	1.03306	3041.1	735937
969	938961	909853209	31.1288	9.8956	2.98632	1.03199	3044.2	737458
970	940900	912673000	31.1448	9.8990	2.98677	1.03093	3047.3	738981
971	942841	915498611	31.1609	9.9024	2.98722	1.02987	3050.5	740506
972	944784	918330048	31.1769	9.9058	2.98767	1.02881	3053.6	742032
973	946729	921167317	31.1929	9.9092	2.98811	1.02775	3056.8	743559
974	948676	924010424	31.2090	9.9126	2.98856	1.02669	3059.9	745088
975	950625	926859375	31.2250	9.9160	2.98900	1.02564	3063.1	746619
976	952576	929714176	31.2410	9.9194	2.98945	1.02459	3066.2	748151
977	954529	932574833	31.2570	9.9227	2.98989	1.02354	3069.3	749685
978	956484	935441352	31.2730	9.9261	2.99034	1.02249	3072.5	751221
979	958441	938313739	31.2890	9.9295	2.99078	1.02145	3075.6	752758
980	960400	941192000	31.3050	9.9329	2.99123	1.02041	3078.8	754296
981	962361	944076141	31.3209	9.9363	2.99167	1.01937	3081.9	755837
982	964324	946966168	31.3369	9.9396	2.99211	1.01833	3085.0	757378
983	966289	949862087	31.3528	9.9430	2.99255	1.01729	3088.2	758922
984	968256	952763904	31.3688	9.9464	2.99300	1.01626	3091.3	760466
985	970225	955671625	31.3847	9.9497	2.99344	1.01523	3094.5	762013
986	972196	958585256	31.4006	9.9531	2.99388	1.01420	3097.6	763561
987	974169	961504803	31.4166	9.9565	2.99432	1.01317	3100.8	765111
988	976144	964430272	31.4325	9.9598	2.99476	1.01215	3103.9	766662
989	978121	967361669	31.4484	9.9632	2.99520	1.01112	3107.0	768214
990	980100	970299000	31.4643	9.9666	2.99564	1.01010	3110.2	769769
991	982081	973242271	31.4802	9.9699	2.99607	1.00908	3113.3	771325
992	984064	976191488	31.4960	9.9733	2.99651	1.00806	3116.5	772882
993	986049	979146657	31.5119	9.9766	2.99695	1.00705	3119.6	774441
994	988036	982107784	31.5278	9.9800	2.99739	1.00604	3122.7	776002
995	990025	985074875	31.5436	9.9833	2.99782	1.00503	3125.9	777564
996	992016	988047936	31.5595	9.9866	2.99826	1.00402	3129.0	779128
997	994009	991026973	31.5753	9.9900	2.99870	1.00301	3132.2	780693
998	996004	994011992	31.5911	9.9933	2.99913	1.00200	3135.3	782260
999	998001	997002999	31.6070	9.9967	2.99957	1.00100	3138.5	783828

CARNEGIE STEEL COMPANY

NATURAL TRIGONOMETRIC FUNCTIONS

Degrees	SINES							Cosines
	0'	10'	20'	30'	40'	50'	60'	
0	0.00000	0.00291	0.00582	0.00873	0.01164	0.01454	0.01745	89
1	0.01745	0.02036	0.02327	0.02618	0.02908	0.03199	0.03490	88
2	0.03490	0.03781	0.04071	0.04362	0.04653	0.04943	0.05234	87
3	0.05234	0.05524	0.05814	0.06105	0.06395	0.06685	0.06976	86
4	0.06976	0.07266	0.07556	0.07846	0.08136	0.08426	0.08716	85
5	0.08716	0.09005	0.09295	0.09585	0.09874	0.10164	0.10453	84
6	0.10453	0.10742	0.11031	0.11320	0.11609	0.11898	0.12187	83
7	0.12187	0.12476	0.12764	0.13053	0.13341	0.13629	0.13917	82
8	0.13917	0.14205	0.14493	0.14781	0.15069	0.15356	0.15643	81
9	0.15643	0.15931	0.16218	0.16505	0.16792	0.17078	0.17365	80
10	0.17365	0.17651	0.17937	0.18224	0.18509	0.18795	0.19081	79
11	0.19081	0.19366	0.19652	0.19937	0.20222	0.20507	0.20791	78
12	0.20791	0.21076	0.21360	0.21644	0.21928	0.22212	0.22495	77
13	0.22495	0.22778	0.23062	0.23345	0.23627	0.23910	0.24192	76
14	0.24192	0.24474	0.24756	0.25038	0.25320	0.25601	0.25882	75
15	0.25882	0.26163	0.26443	0.26724	0.27004	0.27284	0.27564	74
16	0.27564	0.27843	0.28123	0.28402	0.28680	0.28959	0.29237	73
17	0.29237	0.29515	0.29793	0.30071	0.30348	0.30625	0.30902	72
18	0.30902	0.31178	0.31454	0.31730	0.32006	0.32282	0.32557	71
19	0.32557	0.32832	0.33106	0.33381	0.33655	0.33929	0.34202	70
20	0.34202	0.34475	0.34748	0.35021	0.35293	0.35565	0.35837	69
21	0.35837	0.36108	0.36379	0.36650	0.36921	0.37191	0.37461	68
22	0.37461	0.37730	0.37999	0.38268	0.38537	0.38805	0.39073	67
23	0.39073	0.39341	0.39608	0.39875	0.40142	0.40408	0.40674	66
24	0.40674	0.40939	0.41204	0.41469	0.41734	0.41998	0.42262	65
25	0.42262	0.42525	0.42788	0.43051	0.43313	0.43575	0.43837	64
26	0.43837	0.44098	0.44359	0.44620	0.44880	0.45140	0.45399	63
27	0.45399	0.45658	0.45917	0.46175	0.46433	0.46690	0.46947	62
28	0.46947	0.47204	0.47460	0.47716	0.47971	0.48226	0.48481	61
29	0.48481	0.48735	0.48989	0.49242	0.49495	0.49748	0.50000	60
30	0.50000	0.50252	0.50503	0.50754	0.51004	0.51254	0.51504	59
31	0.51504	0.51753	0.52002	0.52250	0.52498	0.52745	0.52992	58
32	0.52992	0.53238	0.53484	0.53730	0.53975	0.54220	0.54464	57
33	0.54464	0.54708	0.54951	0.55194	0.55436	0.55678	0.55919	56
34	0.55919	0.56160	0.56401	0.56641	0.56880	0.57119	0.57358	55
35	0.57358	0.57596	0.57833	0.58070	0.58307	0.58543	0.58779	54
36	0.58779	0.59014	0.59248	0.59482	0.59716	0.59949	0.60182	53
37	0.60182	0.60414	0.60645	0.60876	0.61107	0.61337	0.61566	52
38	0.61566	0.61795	0.62024	0.62251	0.62479	0.62706	0.62932	51
39	0.62932	0.63158	0.63383	0.63608	0.63832	0.64056	0.64279	50
40	0.64279	0.64501	0.64723	0.64945	0.65166	0.65386	0.65606	49
41	0.65606	0.65825	0.66044	0.66262	0.66480	0.66697	0.66913	48
42	0.66913	0.67129	0.67344	0.67559	0.67773	0.67987	0.68200	47
43	0.68200	0.68412	0.68624	0.68835	0.69046	0.69256	0.69466	46
44	0.69466	0.69675	0.69883	0.70091	0.70298	0.70505	0.70711	45
Sines	60'	50'	40'	30'	20'	10'	0'	Degrees
	COSINES							

MATHEMATICAL TABLES

NATURAL TRIGONOMETRIC FUNCTIONS

Degrees	COSINES							Sines
	0'	10'	20'	30'	40'	50'	60'	
0	1.00000	1.00000	0.99998	0.99996	0.99993	0.99989	0.99985	80
1	0.99985	0.99979	0.99973	0.99966	0.99958	0.99949	0.99939	88
2	0.99939	0.99929	0.99917	0.99905	0.99892	0.99878	0.99863	87
3	0.99863	0.99847	0.99831	0.99813	0.99795	0.99776	0.99756	86
4	0.99756	0.99736	0.99714	0.99692	0.99668	0.99644	0.99619	85
5	0.99619	0.99594	0.99567	0.99540	0.99511	0.99482	0.99452	84
6	0.99452	0.99421	0.99390	0.99357	0.99324	0.99290	0.99255	83
7	0.99255	0.99219	0.99182	0.99144	0.99106	0.99067	0.99027	82
8	0.99027	0.98986	0.98944	0.98902	0.98858	0.98814	0.98769	81
9	0.98769	0.98723	0.98676	0.98629	0.98580	0.98531	0.98481	80
10	0.98481	0.98430	0.98378	0.98325	0.98272	0.98218	0.98163	79
11	0.98163	0.98107	0.98050	0.97992	0.97934	0.97875	0.97815	78
12	0.97815	0.97754	0.97692	0.97630	0.97566	0.97502	0.97437	77
13	0.97437	0.97371	0.97304	0.97237	0.97169	0.97100	0.97030	76
14	0.97030	0.96959	0.96887	0.96815	0.96742	0.96667	0.96593	75
15	0.96593	0.96517	0.96440	0.96363	0.96285	0.96206	0.96126	74
16	0.96126	0.96046	0.95964	0.95882	0.95799	0.95715	0.95630	73
17	0.95630	0.95545	0.95459	0.95372	0.95284	0.95195	0.95106	72
18	0.95106	0.95015	0.94924	0.94832	0.94740	0.94646	0.94552	71
19	0.94552	0.94457	0.94361	0.94264	0.94167	0.94068	0.93969	70
20	0.93969	0.93869	0.93769	0.93667	0.93565	0.93462	0.93358	69
21	0.93358	0.93253	0.93148	0.93042	0.92935	0.92827	0.92718	68
22	0.92718	0.92609	0.92499	0.92388	0.92276	0.92164	0.92050	67
23	0.92050	0.91936	0.91822	0.91706	0.91590	0.91472	0.91355	66
24	0.91355	0.91236	0.91116	0.90996	0.90875	0.90753	0.90631	65
25	0.90631	0.90507	0.90383	0.90259	0.90133	0.90007	0.89879	64
26	0.89879	0.89752	0.89623	0.89493	0.89363	0.89232	0.89101	63
27	0.89101	0.88968	0.88835	0.88701	0.88566	0.88431	0.88295	62
28	0.88295	0.88158	0.88020	0.87882	0.87743	0.87603	0.87462	61
29	0.87462	0.87321	0.87178	0.87036	0.86892	0.86748	0.86603	60
30	0.86603	0.86457	0.86310	0.86163	0.86015	0.85866	0.85717	59
31	0.85717	0.85567	0.85416	0.85264	0.85112	0.84959	0.84805	58
32	0.84805	0.84650	0.84495	0.84339	0.84182	0.84025	0.83867	57
33	0.83867	0.83708	0.83549	0.83389	0.83228	0.83066	0.82904	56
34	0.82904	0.82741	0.82577	0.82413	0.82248	0.82082	0.81915	55
35	0.81915	0.81748	0.81580	0.81412	0.81242	0.81072	0.80902	54
36	0.80902	0.80730	0.80558	0.80386	0.80212	0.80038	0.79864	53
37	0.79864	0.79688	0.79512	0.79335	0.79158	0.78980	0.78801	52
38	0.78801	0.78622	0.78442	0.78261	0.78079	0.77897	0.77715	51
39	0.77715	0.77531	0.77347	0.77162	0.76977	0.76791	0.76604	50
40	0.76604	0.76417	0.76229	0.76041	0.75851	0.75661	0.75471	49
41	0.75471	0.75280	0.75088	0.74896	0.74703	0.74509	0.74314	48
42	0.74314	0.74120	0.73924	0.73728	0.73531	0.73333	0.73135	47
43	0.73135	0.72937	0.72737	0.72537	0.72337	0.72136	0.71934	46
44	0.71934	0.71732	0.71529	0.71325	0.71121	0.70916	0.70711	45
Cosines	60'	50'	40'	30'	20'	10'	0'	Degrees
	SINES							

CARNEGIE STEEL COMPANY

NATURAL TRIGONOMETRIC FUNCTIONS

Degrees	TANGENTS							Cotangents
	0'	10'	20'	30'	40'	50'	60'	
0	0.00000	0.00291	0.00582	0.00873	0.01164	0.01455	0.01746	89
1	0.01746	0.02036	0.02328	0.02619	0.02910	0.03201	0.03492	88
2	0.03492	0.03783	0.04075	0.04366	0.04658	0.04949	0.05241	87
3	0.05241	0.05533	0.05824	0.06116	0.06408	0.06700	0.06993	86
4	0.06993	0.07285	0.07578	0.07870	0.08163	0.08456	0.08749	85
5	0.08749	0.09042	0.09335	0.09629	0.09923	0.10216	0.10510	84
6	0.10510	0.10805	0.11099	0.11394	0.11688	0.11983	0.12278	83
7	0.12278	0.12574	0.12869	0.13165	0.13461	0.13758	0.14054	82
8	0.14054	0.14351	0.14648	0.14945	0.15243	0.15540	0.15838	81
9	0.15838	0.16137	0.16435	0.16734	0.17033	0.17333	0.17633	80
10	0.17633	0.17933	0.18233	0.18534	0.18835	0.19136	0.19438	79
11	0.19438	0.19740	0.20042	0.20345	0.20648	0.20952	0.21256	78
12	0.21256	0.21560	0.21864	0.22169	0.22475	0.22781	0.23087	77
13	0.23087	0.23393	0.23700	0.24008	0.24316	0.24624	0.24933	76
14	0.24933	0.25242	0.25552	0.25862	0.26172	0.26483	0.26795	75
15	0.26795	0.27107	0.27419	0.27732	0.28046	0.28360	0.28675	74
16	0.28675	0.28990	0.29305	0.29621	0.29938	0.30255	0.30573	73
17	0.30573	0.30891	0.31210	0.31530	0.31850	0.32171	0.32492	72
18	0.32492	0.32814	0.33136	0.33460	0.33783	0.34108	0.34433	71
19	0.34433	0.34758	0.35085	0.35412	0.35740	0.36068	0.36397	70
20	0.36397	0.36727	0.37057	0.37388	0.37720	0.38053	0.38386	69
21	0.38386	0.38721	0.39055	0.39391	0.39727	0.40065	0.40403	68
22	0.40403	0.40741	0.41081	0.41421	0.41763	0.42105	0.42447	67
23	0.42447	0.42791	0.43136	0.43481	0.43828	0.44175	0.44523	66
24	0.44523	0.44872	0.45222	0.45573	0.45924	0.46277	0.46631	65
25	0.46631	0.46985	0.47341	0.47698	0.48055	0.48414	0.48773	64
26	0.48773	0.49134	0.49495	0.49858	0.50222	0.50587	0.50953	63
27	0.50953	0.51320	0.51688	0.52057	0.52427	0.52798	0.53171	62
28	0.53171	0.53545	0.53920	0.54296	0.54674	0.55051	0.55431	61
29	0.55431	0.55812	0.56194	0.56577	0.56962	0.57348	0.57735	60
30	0.57735	0.58124	0.58513	0.58905	0.59297	0.59691	0.60086	59
31	0.60086	0.60483	0.60881	0.61280	0.61681	0.62083	0.62487	58
32	0.62487	0.62892	0.63299	0.63707	0.64117	0.64528	0.64941	57
33	0.64941	0.65355	0.65771	0.66189	0.66608	0.67028	0.67451	56
34	0.67451	0.67875	0.68301	0.68728	0.69157	0.69588	0.70021	55
35	0.70021	0.70455	0.70891	0.71329	0.71769	0.72211	0.72654	54
36	0.72654	0.73100	0.73547	0.73996	0.74447	0.74900	0.75355	53
37	0.75355	0.75812	0.76272	0.76733	0.77196	0.77661	0.78129	52
38	0.78129	0.78598	0.79070	0.79544	0.80020	0.80498	0.80978	51
39	0.80978	0.81461	0.81946	0.82434	0.82923	0.83415	0.83910	50
40	0.83910	0.84407	0.84906	0.85408	0.85912	0.86419	0.86929	49
41	0.86929	0.87441	0.87955	0.88473	0.88992	0.89515	0.90040	48
42	0.90040	0.90569	0.91099	0.91633	0.92170	0.92709	0.93252	47
43	0.93252	0.93797	0.94345	0.94896	0.95451	0.96008	0.96569	46
44	0.96569	0.97133	0.97700	0.98270	0.98843	0.99420	1.00000	45
Tangents	60'	50'	40'	30'	20'	10'	0'	Degrees
	COTANGENTS							

MATHEMATICAL TABLES

NATURAL TRIGONOMETRIC FUNCTIONS

Degrees	COTANGENTS							Tangents
	0'	10'	20'	30'	40'	50'	60'	
0	∞	343.77371	171.88540	114.58865	85.93979	68.75009	57.28996	89
1	57.28996	49.10388	42.96408	38.18846	34.36777	31.24158	28.63625	88
2	28.63625	26.43160	24.54176	22.90377	21.47040	20.20555	19.08114	87
3	19.08114	18.07498	17.16934	16.34986	15.60478	14.92442	14.30067	86
4	14.30067	13.72674	13.19688	12.70621	12.25051	11.82617	11.43005	85
5	11.43005	11.05943	10.71191	10.38540	10.07803	9.78817	9.51436	84
6	9.51436	9.25530	9.00983	8.77689	8.55555	8.34496	8.14435	83
7	8.14435	7.95302	7.77035	7.59575	7.42871	7.26873	7.11537	82
8	7.11537	6.96823	6.82694	6.69116	6.56055	6.43484	6.31375	81
9	6.31375	6.19703	6.08444	5.97576	5.87080	5.76937	5.67128	80
10	5.67128	5.57638	5.48451	5.39552	5.30928	5.22566	5.14455	79
11	5.14455	5.06584	4.98940	4.91516	4.84300	4.77286	4.70463	78
12	4.70463	4.63825	4.57363	4.51071	4.44942	4.38969	4.33148	77
13	4.33148	4.27471	4.21933	4.16530	4.11256	4.06107	4.01078	76
14	4.01078	3.96165	3.91364	3.86671	3.82083	3.77595	3.73205	75
15	3.73205	3.68909	3.64705	3.60588	3.56557	3.52609	3.48741	74
16	3.48741	3.44951	3.41236	3.37594	3.34023	3.30521	3.27085	73
17	3.27085	3.23714	3.20406	3.17159	3.13972	3.10842	3.07768	72
18	3.07768	3.04749	3.01783	2.98869	2.96004	2.93189	2.90421	71
19	2.90421	2.87700	2.85023	2.82391	2.79802	2.77254	2.74748	70
20	2.74748	2.72281	2.69853	2.67462	2.65109	2.62791	2.60509	69
21	2.60509	2.58261	2.56046	2.53865	2.51715	2.49597	2.47509	68
22	2.47509	2.45451	2.43422	2.41421	2.39449	2.37504	2.35585	67
23	2.35585	2.33693	2.31826	2.29984	2.28167	2.26374	2.24604	66
24	2.24604	2.22857	2.21132	2.19430	2.17749	2.16090	2.14451	65
25	2.14451	2.12832	2.11233	2.09654	2.08094	2.06553	2.05030	64
26	2.05030	2.03526	2.02039	2.00569	1.99116	1.97680	1.96261	63
27	1.96261	1.94858	1.93470	1.92098	1.90741	1.89400	1.88073	62
28	1.88073	1.86760	1.85462	1.84177	1.82907	1.81649	1.80405	61
29	1.80405	1.79174	1.77955	1.76749	1.75556	1.74375	1.73205	60
30	1.73205	1.72047	1.70901	1.69766	1.68643	1.67530	1.66428	59
31	1.66428	1.65337	1.64256	1.63185	1.62125	1.61074	1.60033	58
32	1.60033	1.59002	1.57981	1.56969	1.55966	1.54972	1.53987	57
33	1.53987	1.53010	1.52043	1.51084	1.50133	1.49190	1.48256	56
34	1.48256	1.47330	1.46411	1.45501	1.44598	1.43703	1.42815	55
35	1.42815	1.41934	1.41061	1.40195	1.39336	1.38484	1.37638	54
36	1.37638	1.36800	1.35968	1.35142	1.34323	1.33511	1.32704	53
37	1.32704	1.31904	1.31110	1.30323	1.29541	1.28764	1.27994	52
38	1.27994	1.27230	1.26471	1.25717	1.24969	1.24227	1.23490	51
39	1.23490	1.22758	1.22031	1.21310	1.20593	1.19882	1.19175	50
40	1.19175	1.18474	1.17777	1.17085	1.16398	1.15715	1.15037	49
41	1.15037	1.14363	1.13694	1.13029	1.12369	1.11713	1.11061	48
42	1.11061	1.10414	1.09770	1.09131	1.08496	1.07864	1.07237	47
43	1.07237	1.06613	1.05994	1.05378	1.04766	1.04158	1.03553	46
44	1.03553	1.02952	1.02355	1.01761	1.01170	1.00583	1.00000	45
Cotangents	60'	50'	40'	30'	20'	10'	0'	Degrees
	TANGENTS							

CARNEGIE STEEL COMPANY

NATURAL TRIGONOMETRIC FUNCTIONS

Degrees	SECANTS							Cosecants
	0'	10'	20'	30'	40'	50'	60'	
0	1.00000	1.00000	1.00002	1.00004	1.00007	1.00011	1.00015	89
1	1.00015	1.00021	1.00027	1.00034	1.00042	1.00051	1.00061	88
2	1.00061	1.00072	1.00083	1.00095	1.00108	1.00122	1.00137	87
3	1.00137	1.00153	1.00169	1.00187	1.00205	1.00224	1.00244	86
4	1.00244	1.00265	1.00287	1.00309	1.00333	1.00357	1.00382	85
5	1.00382	1.00408	1.00435	1.00463	1.00491	1.00521	1.00551	84
6	1.00551	1.00582	1.00614	1.00647	1.00681	1.00715	1.00751	83
7	1.00751	1.00787	1.00825	1.00863	1.00902	1.00942	1.00983	82
8	1.00983	1.01024	1.01067	1.01111	1.01155	1.01200	1.01247	81
9	1.01247	1.01294	1.01342	1.01391	1.01440	1.01491	1.01543	80
10	1.01543	1.01595	1.01649	1.01703	1.01758	1.01815	1.01872	79
11	1.01872	1.01930	1.01989	1.02049	1.02110	1.02171	1.02234	78
12	1.02234	1.02298	1.02362	1.02428	1.02494	1.02562	1.02630	77
13	1.02630	1.02700	1.02770	1.02842	1.02914	1.02987	1.03061	76
14	1.03061	1.03137	1.03213	1.03290	1.03368	1.03447	1.03528	75
15	1.03528	1.03609	1.03691	1.03774	1.03858	1.03944	1.04030	74
16	1.04030	1.04117	1.04206	1.04295	1.04385	1.04477	1.04569	73
17	1.04569	1.04663	1.04757	1.04853	1.04950	1.05047	1.05146	72
18	1.05146	1.05246	1.05347	1.05449	1.05552	1.05657	1.05762	71
19	1.05762	1.05869	1.05976	1.06085	1.06195	1.06306	1.06418	70
20	1.06418	1.06531	1.06645	1.06761	1.06878	1.06995	1.07115	69
21	1.07115	1.07235	1.07356	1.07479	1.07602	1.07727	1.07853	68
22	1.07853	1.07981	1.08109	1.08239	1.08370	1.08503	1.08636	67
23	1.08636	1.08771	1.08907	1.09044	1.09183	1.09323	1.09464	66
24	1.09464	1.09606	1.09750	1.09895	1.10041	1.10189	1.10338	65
25	1.10338	1.10488	1.10640	1.10793	1.10947	1.11103	1.11260	64
26	1.11260	1.11419	1.11579	1.11740	1.11903	1.12067	1.12233	63
27	1.12233	1.12400	1.12568	1.12738	1.12910	1.13083	1.13257	62
28	1.13257	1.13433	1.13610	1.13789	1.13970	1.14152	1.14335	61
29	1.14335	1.14521	1.14707	1.14896	1.15085	1.15277	1.15470	60
30	1.15470	1.15665	1.15861	1.16059	1.16259	1.16460	1.16663	59
31	1.16663	1.16868	1.17075	1.17283	1.17493	1.17704	1.17918	58
32	1.17918	1.18133	1.18350	1.18569	1.18790	1.19012	1.19236	57
33	1.19236	1.19463	1.19691	1.19920	1.20152	1.20386	1.20622	56
34	1.20622	1.20859	1.21099	1.21341	1.21584	1.21830	1.22077	55
35	1.22077	1.22327	1.22579	1.22833	1.23089	1.23347	1.23607	54
36	1.23607	1.23869	1.24134	1.24400	1.24669	1.24940	1.25214	53
37	1.25214	1.25489	1.25767	1.26047	1.26330	1.26615	1.26902	52
38	1.26902	1.27191	1.27483	1.27778	1.28075	1.28374	1.28676	51
39	1.28676	1.28980	1.29287	1.29597	1.29909	1.30223	1.30541	50
40	1.30541	1.30861	1.31183	1.31509	1.31837	1.32168	1.32501	49
41	1.32501	1.32838	1.33177	1.33519	1.33864	1.34212	1.34563	48
42	1.34563	1.34917	1.35274	1.35634	1.35997	1.36363	1.36733	47
43	1.36733	1.37105	1.37481	1.37860	1.38242	1.38628	1.39016	46
44	1.39016	1.39409	1.39804	1.40203	1.40606	1.41012	1.41421	45
Secants	60'	50'	40'	30'	20'	10'	0'	Degrees
	COSECANTS							

MATHEMATICAL TABLES

NATURAL TRIGONOMETRIC FUNCTIONS

Degrees	COSECANTS							Seconds
	0'	10'	20'	30'	40'	50'	60'	
0	∞	343.77516	171.88831	114.59301	85.94561	68.75736	57.29869	89
1	57.29869	49.11406	42.97571	38.20155	34.38232	31.25758	28.65371	88
2	28.65371	26.45051	24.56212	22.92559	21.49368	20.23028	19.10732	87
3	19.10732	18.10262	17.19843	16.38041	15.63679	14.95788	14.33559	86
4	14.33559	13.76312	13.23472	12.74550	12.29125	11.86837	11.47371	85
5	11.47371	11.10455	10.75849	10.43343	10.12752	9.83912	9.56677	84
6	9.56677	9.30917	9.06515	8.83367	8.61379	8.40466	8.20551	83
7	8.20551	8.01565	7.83443	7.66130	7.49571	7.33719	7.18530	82
8	7.18530	7.03962	6.89979	6.76547	6.63633	6.51208	6.39245	81
9	6.39245	6.27719	6.16607	6.05886	5.95536	5.85539	5.75877	80
10	5.75877	5.66533	5.57493	5.48740	5.40263	5.32049	5.24084	79
11	5.24084	5.16359	5.08863	5.01585	4.94517	4.87649	4.80973	78
12	4.80973	4.74482	4.68167	4.62023	4.56041	4.50216	4.44541	77
13	4.44541	4.39012	4.33622	4.28366	4.23239	4.18238	4.13357	76
14	4.13357	4.08591	4.03938	3.99393	3.94952	3.90613	3.86370	75
15	3.86370	3.82223	3.78166	3.74198	3.70315	3.66515	3.62796	74
16	3.62796	3.59154	3.55587	3.52094	3.48671	3.45317	3.42030	73
17	3.42030	3.38808	3.35649	3.32551	3.29512	3.26531	3.23607	72
18	3.23607	3.20737	3.17920	3.15155	3.12440	3.09774	3.07155	71
19	3.07155	3.04584	3.02037	2.99574	2.97135	2.94737	2.92380	70
20	2.92380	2.90063	2.87785	2.85545	2.83342	2.81175	2.79043	69
21	2.79043	2.76945	2.74881	2.72850	2.70851	2.68884	2.66947	68
22	2.66947	2.65040	2.63162	2.61313	2.59491	2.57698	2.55930	67
23	2.55930	2.54190	2.52474	2.50784	2.49119	2.47477	2.45859	66
24	2.45859	2.44264	2.42692	2.41142	2.39614	2.38107	2.36620	65
25	2.36620	2.35154	2.33708	2.32282	2.30875	2.29487	2.28117	64
26	2.28117	2.26766	2.25432	2.24116	2.22817	2.21535	2.20269	63
27	2.20269	2.19019	2.17786	2.16568	2.15366	2.14178	2.13005	62
28	2.13005	2.11847	2.10704	2.09574	2.08458	2.07356	2.06267	61
29	2.06267	2.05191	2.04128	2.03077	2.02039	2.01014	2.00000	60
30	2.00000	1.98998	1.98008	1.97029	1.96062	1.95106	1.94160	59
31	1.94160	1.93226	1.92302	1.91388	1.90485	1.89591	1.88709	58
32	1.88708	1.87834	1.86970	1.86116	1.85271	1.84435	1.83608	57
33	1.83608	1.82790	1.81981	1.81180	1.80388	1.79604	1.78829	56
34	1.78829	1.78062	1.77303	1.76552	1.75808	1.75073	1.74345	55
35	1.74345	1.73624	1.72911	1.72205	1.71506	1.70815	1.70130	54
36	1.70130	1.69452	1.68782	1.68117	1.67460	1.66809	1.66164	53
37	1.66164	1.65526	1.64894	1.64268	1.63648	1.63035	1.62427	52
38	1.62427	1.61825	1.61229	1.60639	1.60054	1.59475	1.58902	51
39	1.58902	1.58333	1.57771	1.57213	1.56661	1.56114	1.55572	50
40	1.55572	1.55036	1.54504	1.53977	1.53455	1.52938	1.52425	49
41	1.52425	1.51918	1.51415	1.50916	1.50422	1.49933	1.49448	48
42	1.49448	1.48967	1.48491	1.48019	1.47551	1.47087	1.46628	47
43	1.46628	1.46173	1.45721	1.45274	1.44831	1.44391	1.43956	46
44	1.43956	1.43524	1.43096	1.42672	1.42251	1.41835	1.41421	45
Cosecants	60'	50'	40'	30'	20'	10'	0'	Degrees
	SECANTS							

CARNEGIE STEEL COMPANY

BIRMINGHAM WIRE GAGE (B. W. G.)

EQUIVALENTS IN INCHES AND MILLIMETERS
CORRESPONDING WEIGHTS OF FLAT ROLLED STEEL

Gage Number	Thickness			Weight	
	Decimal Inches	Fractional Inches	Millimeters	Pounds per Square Foot	Kilograms per Square Meter
0000	.454	$\frac{29}{64}$	11.532	18.523	90.438
000	.425	$\frac{27}{64}$	10.795	17.340	84.661
00	.380	$\frac{49}{128}$	9.652	15.504	75.697
0	.340	$\frac{11}{32}$	8.636	13.872	67.729
1	.300	$\frac{19}{64}$	7.620	12.240	59.761
2	.284	$\frac{9}{32}$	7.214	11.587	56.573
3	.259	$\frac{89}{128}$	6.579	10.567	51.593
4	.238	$\frac{15}{64}$	6.045	9.710	47.410
5	.220	$\frac{7}{32}$	5.588	8.976	43.825
6	.203	$\frac{13}{64}$	5.156	8.282	40.438
7	.180	$\frac{23}{128}$	4.572	7.344	35.856
8	.165	$\frac{21}{128}$	4.191	6.731	32.868
9	.148	$\frac{19}{128}$	3.759	6.038	29.482
10	.134	$\frac{17}{128}$	3.404	5.467	26.693
11	.120	$\frac{15}{128}$	3.048	4.896	23.904
12	.109	$\frac{7}{64}$	2.769	4.447	21.713
13	.095	$\frac{3}{32}$	2.413	3.876	18.924
14	.083	$\frac{21}{256}$	2.108	3.386	16.534
15	.072	$\frac{23}{32}$	1.829	2.938	14.343
16	.065	$\frac{25}{32}$	1.651	2.652	12.948
17	.058	$\frac{15}{256}$	1.473	2.366	11.554
18	.049	$\frac{25}{512}$	1.245	1.999	9.761
19	.042	$\frac{11}{256}$	1.067	1.714	8.366
20	.035	$\frac{9}{256}$.889	1.428	6.972
21	.032	$\frac{1}{64}$.813	1.306	6.374
22	.028	$\frac{7}{256}$.711	1.142	5.578
23	.025	$\frac{13}{512}$.635	1.020	4.980
24	.022	$\frac{11}{512}$.559	0.898	4.382
25	.020	$\frac{5}{256}$.508	0.816	3.984
26	.018	$\frac{9}{512}$.457	0.734	3.586
27	.016	$\frac{1}{64}$.406	0.653	3.187
28	.014	$\frac{7}{512}$.356	0.571	2.789
29	.013	$\frac{13}{1024}$.330	0.530	2.590
30	.012	$\frac{3}{256}$.305	0.490	2.390
31	.010	$\frac{5}{512}$.254	0.408	1.992
32	.009	$\frac{9}{1024}$.229	0.367	1.793
33	.008	$\frac{1}{128}$.203	0.326	1.594
34	.007	$\frac{7}{1024}$.178	0.286	1.394
35	.005	$\frac{5}{1024}$.127	0.204	0.996
36	.004	$\frac{1}{256}$.102	0.163	0.797

Unless otherwise specified, all orders for flat rolled steel in gages will be executed by Carnegie Steel Company to Birmingham Wire Gage.

GAGES

UNITED STATES STANDARD GAGE

FOR

SHEET AND PLATE IRON STEEL

Gage Number	Approximate Thickness			Weight per Square Foot Ounces, Av.	Weight per Square Foot Pounds, Av.	Weight per Sq. Meter, Kilograms
	Fractional Inches	Decimal Inches	Millimeters			
0000000	$\frac{1}{2}$.5	12.7	320	20.00	97.65
000000	$\frac{15}{32}$.46875	11.90625	300	18.75	91.55
00000	$\frac{3}{16}$.4375	11.1125	280	17.50	85.44
0000	$\frac{13}{32}$.40625	10.31875	260	16.25	79.33
000	$\frac{5}{8}$.375	9.525	240	15.00	73.24
00	$\frac{11}{32}$.34375	8.73125	220	13.75	67.13
0	$\frac{9}{16}$.3125	7.9375	200	12.50	61.03
1	$\frac{9}{32}$.28125	7.14375	180	11.25	54.93
2	$\frac{17}{64}$.265625	6.746875	170	10.625	51.88
3	$\frac{1}{4}$.25	6.35	160	10.00	48.82
4	$\frac{15}{64}$.234375	5.953125	150	9.375	45.77
5	$\frac{7}{32}$.21875	5.55625	140	8.75	42.72
6	$\frac{13}{64}$.203125	5.159375	130	8.125	39.67
7	$\frac{5}{16}$.1875	4.7625	120	7.5	36.62
8	$\frac{11}{64}$.171875	4.365625	110	6.875	33.57
9	$\frac{5}{32}$.15625	3.96875	100	6.25	30.52
10	$\frac{9}{64}$.140625	3.571875	90	5.625	27.46
11	$\frac{1}{8}$.125	3.175	80	5.00	24.41
12	$\frac{7}{64}$.109375	2.778125	70	4.375	21.36
13	$\frac{3}{32}$.09375	2.38125	60	3.75	18.31
14	$\frac{5}{64}$.078125	1.984375	50	3.125	15.26
15	$\frac{9}{128}$.0703125	1.7859375	45	2.8125	13.73
16	$\frac{1}{16}$.0625	1.5875	40	2.50	12.21
17	$\frac{9}{160}$.05625	1.42875	36	2.25	10.99
18	$\frac{1}{20}$.05	1.27	32	2.00	9.765
19	$\frac{7}{160}$.04375	1.11125	28	1.75	8.544
20	$\frac{3}{80}$.0375	.9525	24	1.50	7.324
21	$\frac{11}{320}$.034375	.873125	22	1.375	6.713
22	$\frac{1}{32}$.03125	.793750	20	1.25	6.103
23	$\frac{9}{320}$.028125	.714375	18	1.125	5.493
24	$\frac{1}{40}$.025	.635	16	1.00	4.882
25	$\frac{7}{320}$.021875	.555625	14	.875	4.272
26	$\frac{9}{160}$.01875	.47625	12	.75	3.662
27	$\frac{11}{640}$.0171875	.4365625	11	.6875	3.357
28	$\frac{1}{64}$.015625	.396875	10	.625	3.052
29	$\frac{9}{640}$.0140625	.3571875	9	.5625	2.746
30	$\frac{1}{80}$.0125	.3175	8	.50	2.441
31	$\frac{7}{640}$.0109375	.2778125	7	.4375	2.136
32	$\frac{13}{1280}$.01015625	.25796875	6 $\frac{1}{2}$.40625	1.983
33	$\frac{9}{320}$.009375	.238125	6	.375	1.831
34	$\frac{11}{1280}$.00859375	.21828125	5 $\frac{1}{2}$.34375	1.678
35	$\frac{9}{640}$.0078125	.1984375	5	.3125	1.526
36	$\frac{9}{1280}$.00703125	.17859375	4 $\frac{1}{2}$.28125	1.373
37	$\frac{17}{2560}$.006640625	.168671875	4 $\frac{1}{4}$.265625	1.297
38	$\frac{1}{160}$.00625	.15875	4	.25	1.221

The United States Standard Gage is a weight gage based upon the weights per square foot, in ounces avoirdupois and approximate thicknesses based upon 480 pounds per cubic foot.

In the practical use and application of the United States Standard Gage, a weight variation of 2½ per cent either way may be allowed.

Unless otherwise specified, all orders for flat rolled steel in gages will be executed by Carnegie Steel Company to Birmingham Wire Gage.

CARNEGIE STEEL COMPANY

STANDARD GAGES

COMPARATIVE TABLE

Gage Number	Thickness in Decimals of an Inch					
	Birmingham Wire (B. W. G.) also known as Stubbs Iron Wire	American Wire or Browne & Sharpe	American Steel & Wire Co. formerly Washburn & Moen	Trenton Iron Company	British Imperial Standard Wire (S. W. G.)	Standard Birmingham Sheet and Hoop (B. G.)
00000004900500
000000580000	.4615464
000000516500	.4305	.450	.432
00000	.454	.460000	.3938	.400	.400
0000	.425	.409642	.3625	.360	.372
00	.380	.364796	.3310	.330	.348	.5000
0	.340	.324861	.3065	.305	.324	.4452
1	.300	.289297	.2830	.285	.300	.3964
2	.284	.257627	.2625	.265	.276	.3532
3	.259	.229423	.2437	.245	.252	.3147
4	.238	.204307	.2253	.225	.232	.2804
5	.220	.181940	.2070	.205	.212	.2500
6	.203	.162023	.1920	.190	.192	.2225
7	.180	.144285	.1770	.175	.176	.1981
8	.165	.128490	.1620	.160	.160	.1764
9	.148	.114423	.1483	.145	.144	.1570
10	.134	.101897	.1350	.130	.128	.1398
11	.120	.090742	.1205	.1175	.116	.1250
12	.109	.080808	.1055	.105	.104	.1113
13	.095	.071962	.0915	.0925	.092	.0991
14	.083	.064084	.0800	.0806	.080	.0882
15	.072	.057068	.0720	.070	.072	.0785
16	.065	.050821	.0625	.061	.064	.0699
17	.058	.045257	.0540	.0525	.056	.0625
18	.049	.040303	.0475	.045	.048	.0556
19	.042	.035890	.0410	.040	.040	.0495
20	.035	.031961	.0348	.035	.036	.0440
21	.032	.028462	.03175	.031	.032	.0392
22	.028	.025346	.0286	.028	.028	.0349
23	.025	.022572	.0258	.025	.024	.03125
24	.022	.020101	.0230	.0225	.022	.02782
25	.020	.017900	.0204	.020	.020	.02476
26	.018	.015941	.0181	.018	.018	.02204
27	.016	.014195	.0173	.017	.0164	.01961
28	.014	.012641	.0162	.016	.0148	.01745
29	.013	.011257	.0150	.015	.0136	.015625
30	.012	.010025	.0140	.014	.0124	.0139
31	.010	.008928	.0132	.013	.0116	.0123
32	.009	.007950	.0128	.012	.0108	.0110
33	.008	.007080	.0118	.011	.0100	.0098
34	.007	.006305	.0104	.010	.0092	.0087
35	.005	.005615	.0095	.0095	.0084	.0077
36	.004	.005000	.0090	.009	.0076	.0069
37004453	.0085	.0085	.0068	.0061
38003965	.0080	.008	.0060	.0054
39003531	.0075	.0075	.0052	.0048
40003144	.0070	.007	.0048

Unless otherwise specified, all orders for flat rolled steel in gages will be executed by Carnegie Steel Company to Birmingham Wire Gage.

MEASURES AND WEIGHTS

DECIMAL OF AN INCH AND OF A FOOT

Fractions of Inch or Foot	Inch Equivalents to Foot Fractions	Fractions of Inch or Foot	Inch Equivalents to Foot Fractions	Fractions of Inch or Foot	Inch Equivalents to Foot Fractions	Fractions of Inch or Foot	Inch Equivalents to Foot Fractions
.0052	$\frac{1}{160}$.2552	$\frac{31}{100}$.5052	$\frac{61}{100}$.7552	$\frac{91}{100}$
.0104	$\frac{1}{80}$.2604	$\frac{31}{80}$.5104	$\frac{61}{80}$.7604	$\frac{91}{80}$
$\frac{1}{64}$.015625	$\frac{1}{64}$	$\frac{1}{64}$.265625	$\frac{31}{64}$	$\frac{1}{64}$.515625	$\frac{61}{64}$	$\frac{1}{64}$.765625	$\frac{91}{64}$
.0208	$\frac{1}{48}$.2708	$\frac{31}{48}$.5208	$\frac{61}{48}$.7708	$\frac{91}{48}$
.0260	$\frac{1}{36}$.2760	$\frac{31}{36}$.5260	$\frac{61}{36}$.7760	$\frac{91}{36}$
$\frac{1}{32}$.03125	$\frac{1}{32}$	$\frac{1}{32}$.28125	$\frac{31}{32}$	$\frac{1}{32}$.53125	$\frac{61}{32}$	$\frac{1}{32}$.78125	$\frac{91}{32}$
.0365	$\frac{1}{27}$.2865	$\frac{31}{27}$.5365	$\frac{61}{27}$.7865	$\frac{91}{27}$
.0417	$\frac{1}{24}$.2917	$\frac{31}{24}$.5417	$\frac{61}{24}$.7917	$\frac{91}{24}$
$\frac{1}{80}$.046875	$\frac{1}{80}$	$\frac{1}{80}$.296875	$\frac{31}{80}$	$\frac{1}{80}$.546875	$\frac{61}{80}$	$\frac{1}{80}$.796875	$\frac{91}{80}$
.0521	$\frac{1}{60}$.3021	$\frac{31}{60}$.5521	$\frac{61}{60}$.8021	$\frac{91}{60}$
.0573	$\frac{1}{50}$.3073	$\frac{31}{50}$.5573	$\frac{61}{50}$.8073	$\frac{91}{50}$
$\frac{1}{100}$.0625	$\frac{1}{100}$	$\frac{1}{100}$.3125	$\frac{31}{100}$	$\frac{1}{100}$.5625	$\frac{61}{100}$	$\frac{1}{100}$.8125	$\frac{91}{100}$
.0677	$\frac{1}{85}$.3177	$\frac{31}{85}$.5677	$\frac{61}{85}$.8177	$\frac{91}{85}$
.0729	$\frac{1}{75}$.3229	$\frac{31}{75}$.5729	$\frac{61}{75}$.8229	$\frac{91}{75}$
$\frac{1}{64}$.078125	$\frac{1}{64}$	$\frac{1}{64}$.328125	$\frac{31}{64}$	$\frac{1}{64}$.578125	$\frac{61}{64}$	$\frac{1}{64}$.828125	$\frac{91}{64}$
.0833	$\frac{1}{60}$.3333	$\frac{31}{60}$.5833	$\frac{61}{60}$.8333	$\frac{91}{60}$
.0885	$\frac{1}{50}$.3385	$\frac{31}{50}$.5885	$\frac{61}{50}$.8385	$\frac{91}{50}$
$\frac{1}{32}$.09375	$\frac{1}{32}$	$\frac{1}{32}$.34375	$\frac{31}{32}$	$\frac{1}{32}$.59375	$\frac{61}{32}$	$\frac{1}{32}$.84375	$\frac{91}{32}$
.0990	$\frac{1}{25}$.3490	$\frac{31}{25}$.5990	$\frac{61}{25}$.8490	$\frac{91}{25}$
.1042	$\frac{1}{24}$.3542	$\frac{31}{24}$.6042	$\frac{61}{24}$.8542	$\frac{91}{24}$
$\frac{1}{64}$.109375	$\frac{1}{64}$	$\frac{1}{64}$.359375	$\frac{31}{64}$	$\frac{1}{64}$.609375	$\frac{61}{64}$	$\frac{1}{64}$.859375	$\frac{91}{64}$
.1146	$\frac{1}{40}$.3646	$\frac{31}{40}$.6146	$\frac{61}{40}$.8646	$\frac{91}{40}$
.1198	$\frac{1}{30}$.3698	$\frac{31}{30}$.6198	$\frac{61}{30}$.8698	$\frac{91}{30}$
$\frac{1}{80}$.1250	$\frac{1}{80}$	$\frac{1}{80}$.3750	$\frac{31}{80}$	$\frac{1}{80}$.6250	$\frac{61}{80}$	$\frac{1}{80}$.8750	$\frac{91}{80}$
.1302	$\frac{1}{60}$.3802	$\frac{31}{60}$.6302	$\frac{61}{60}$.8802	$\frac{91}{60}$
.1354	$\frac{1}{50}$.3854	$\frac{31}{50}$.6354	$\frac{61}{50}$.8854	$\frac{91}{50}$
$\frac{1}{64}$.140625	$\frac{1}{64}$	$\frac{1}{64}$.390625	$\frac{31}{64}$	$\frac{1}{64}$.640625	$\frac{61}{64}$	$\frac{1}{64}$.890625	$\frac{91}{64}$
.1458	$\frac{1}{40}$.3958	$\frac{31}{40}$.6458	$\frac{61}{40}$.8958	$\frac{91}{40}$
.1510	$\frac{1}{30}$.4010	$\frac{31}{30}$.6510	$\frac{61}{30}$.9010	$\frac{91}{30}$
$\frac{1}{32}$.15625	$\frac{1}{32}$	$\frac{1}{32}$.40625	$\frac{31}{32}$	$\frac{1}{32}$.65625	$\frac{61}{32}$	$\frac{1}{32}$.90625	$\frac{91}{32}$
.1615	$\frac{1}{25}$.4115	$\frac{31}{25}$.6615	$\frac{61}{25}$.9115	$\frac{91}{25}$
.1667	$\frac{1}{20}$.4167	$\frac{31}{20}$.6667	$\frac{61}{20}$.9167	$\frac{91}{20}$
$\frac{1}{64}$.171875	$\frac{1}{64}$	$\frac{1}{64}$.421875	$\frac{31}{64}$	$\frac{1}{64}$.671875	$\frac{61}{64}$	$\frac{1}{64}$.921875	$\frac{91}{64}$
.1771	$\frac{1}{40}$.4271	$\frac{31}{40}$.6771	$\frac{61}{40}$.9271	$\frac{91}{40}$
.1823	$\frac{1}{30}$.4323	$\frac{31}{30}$.6823	$\frac{61}{30}$.9323	$\frac{91}{30}$
$\frac{1}{100}$.1875	$\frac{1}{100}$	$\frac{1}{100}$.4375	$\frac{31}{100}$	$\frac{1}{100}$.6875	$\frac{61}{100}$	$\frac{1}{100}$.9375	$\frac{91}{100}$
.1927	$\frac{1}{50}$.4427	$\frac{31}{50}$.6927	$\frac{61}{50}$.9427	$\frac{91}{50}$
.1979	$\frac{1}{40}$.4479	$\frac{31}{40}$.6979	$\frac{61}{40}$.9479	$\frac{91}{40}$
$\frac{1}{64}$.203125	$\frac{1}{64}$	$\frac{1}{64}$.453125	$\frac{31}{64}$	$\frac{1}{64}$.703125	$\frac{61}{64}$	$\frac{1}{64}$.953125	$\frac{91}{64}$
.2083	$\frac{1}{40}$.4583	$\frac{31}{40}$.7083	$\frac{61}{40}$.9583	$\frac{91}{40}$
.2135	$\frac{1}{30}$.4635	$\frac{31}{30}$.7135	$\frac{61}{30}$.9635	$\frac{91}{30}$
$\frac{1}{32}$.21875	$\frac{1}{32}$	$\frac{1}{32}$.46875	$\frac{31}{32}$	$\frac{1}{32}$.71875	$\frac{61}{32}$	$\frac{1}{32}$.96875	$\frac{91}{32}$
.2240	$\frac{1}{25}$.4740	$\frac{31}{25}$.7240	$\frac{61}{25}$.9740	$\frac{91}{25}$
.2292	$\frac{1}{24}$.4792	$\frac{31}{24}$.7292	$\frac{61}{24}$.9792	$\frac{91}{24}$
$\frac{1}{64}$.234375	$\frac{1}{64}$	$\frac{1}{64}$.484375	$\frac{31}{64}$	$\frac{1}{64}$.734375	$\frac{61}{64}$	$\frac{1}{64}$.984375	$\frac{91}{64}$
.2396	$\frac{1}{40}$.4896	$\frac{31}{40}$.7396	$\frac{61}{40}$.9896	$\frac{91}{40}$
.2448	$\frac{1}{30}$.4948	$\frac{31}{30}$.7448	$\frac{61}{30}$.9948	$\frac{91}{30}$
$\frac{1}{4}$.2500	$\frac{1}{4}$	$\frac{1}{4}$.5000	$\frac{1}{4}$	$\frac{1}{4}$.7500	$\frac{1}{4}$	$\frac{1}{4}$ 1.0000	$\frac{1}{4}$ 12

SUBJECT INDEX

	PAGE
American Bridge Co. . . . specifications for steel structures	94-100
Anchors standard wall and pier anchors	184
Angles elements of sections	120-125
	profiles, dimensions and weights 36-43
	safe loads, explanatory notes 147
	safe load tables 171-175
	standard beam connections 181, 182
	structural details, punching and riveting 187-189
Angles, Back to Back . . . radii of gyration	109, 131-133
Arches, Floor Arches . . . explanatory notes	262-264
	terra cotta, safe load tables and weights 265-268
Areas circles, diameters 1 to 999	330-349
	circular segments 324-327
	method of increasing sectional areas 5
	plane figures 321
	rectangular sections 62-64
	reduction of area for rivet holes 189
	square and round bars 66, 67
	structural shapes, rails, etc. 110-130
	surface of solids 328, 329
Band Edge Flats list of sizes	58
Bars cold twisted square bars, sizes and weights	68
	concrete reinforcement bars, sizes and weights 68
	cup bars, sizes and weights 68
	eye bars, sizes and dimensions 86
	flats, list of sizes 58
	lattice bars, dimensions for columns 98
	merchant bars, list of sizes 65
	rounds and squares, weights and areas 66, 67
	splice bars, profiles, dimensions and weights 71, 73, 74
	upset screw ends, sizes and dimensions 84, 85
Beams, H-Beams see H-Beams	
Beams, I-Beams bending moments, tables	154, 155
	details, connection angles 181, 182
	" bearing plates 185
	" separators 183
	" standard gages for punching 178, 179
	elements of sections 110, 111
	grillage, notes and calculations 252-256
	profiles, weights and dimensions 7-16
	safe loads, explanation of tables 147-153
	safe load tables 157-184
	standard dimensions 6
	web resistance, tables 154, 155

	PAGE
Beam Columns	safe load tables 222, 223
Beam Connections	standard angles 181
	limiting values 182
Beam Separators	standard 183
Beam Girders	explanatory notes 195
	safe load tables 196, 197
Beam Safe Loads	explanation of tables 147-153
Beam Stresses	explanatory notes 138-153
	bending stresses 138-140
	buckling stresses 151, 152
	deflection, lateral 139, 149
	" vertical 139, 143-148
	flexure formulas, various loading conditions 141-146
	impact stresses 149, 150
	shearing stresses, longitudinal and vertical 150, 151
	tensile and compressive stresses 139
Bearing Plates	explanatory notes 185
	safe resistance 186
	standard for beams 185
Bearing Values	pins and rivets, explanatory notes 190
	pins, tables 193
	rivets, tables 191, 192
Bending Moments	explanatory notes 138-140
	beams, tables 154, 155
	channels, tables 156
	pins, tables 194
	various loading conditions, formulas 143-146
Bolts	standard dimensions 80, 81
	weights, hexagon heads and nuts 83
	weights, square heads and nuts 82
Bolt Heads and Nuts	standard dimensions 80, 81
	weights 82, 83
Buckle Plates	explanatory notes 276
	safe load table 276
	sizes and dimensions 277
Buckling of Webs	explanatory notes 151-153
	web resistance of beams and channels 154-156
Building Laws	extract from building laws of various cities 265
Bulb Angles	bulb angles 18-25, 116-119
	bulb angles, elements 116-119
	" " profiles, weights and dimensions 18-25
B. W. Gage	Birmingham Wire Gage 356
Car Bldg. Bulb Angles	profiles and properties 25, 119
Car Building Channels	profiles and properties 26, 27, 35, 115
Cast Iron Columns	allowable unit stresses 247
	hollow round and square, elements 136, 137
	" " " " safe loads 248, 249
Ceilings	deflection of plastered ceilings 147, 148
	weight of ceilings 268
Center of Gravity	see Neutral Axis 101-107, 110-130

CARNEGIE STEEL COMPANY

	PAGE	
Channels	bending moments, table	156
	standard dimensions	6
	details, standard gages for punching	180
	elements of sections	148, 113-115
	profiles, weights and dimensions	26-35
	safe loads, explanation of tables	147-153
	safe load tables	166-170
Checked Plates	web resistance, table	156
	elements and safe loads	278
	profiles, weights and dimensions	54
Circles	areas and circumferences, dia. 1 to 999	330-349
	properties of the circle	320
Circular Plates	extreme sizes, carbon steel	55, 56
Circular Segments	areas, tables of coefficients	324-327
Clevises	sizes and weights	88
Coefficients	circular segments	325-327
	deflection under uniform load	148
	expansion due to heat	307
Cold Twisted Squares	sizes and weights	68
Columns, Cast Iron	allowable unit stresses	247
	hollow round and square, elements	136, 137
	" " " " safe loads	248, 249
Columns, Steel	explanatory notes	217-219
	calculation of elements	108, 109
	" " stresses	217-219
	compression formulas	220, 221
	safe loads, angle and plate columns	236-243
	" " channel and plate columns	224-235
	" " miscellaneous beam columns	222-223
	" " pipe columns	250, 251
	typical details for mill and office buildings	244-246
	Columns, Wood	allowable unit stresses
	square and round, safe loads	298, 299
Compound Sections	calculation of elements	108, 109
Concrete, Masonry	strength, unit fiber stresses	306
	specific gravity and weight	301
Concrete, Reinforced	explanatory notes	269-273
	beams and slabs, formulas	270-272
	bending moments of slabs	274
	columns, formulas	272
	reinforcements, deformed bars, etc.	68
	" " round and square bars	66, 67
	" " triangle mesh	275
Connection Angles	standard for beams	181, 182
Construction Specifications	American Bridge Company	94-100
Conversion Tables	measures, metric and U. S. Standard	308-319
Corrugated Sheets	explanatory notes	286
	sizes and weights	287
Cotter Pins	sizes and dimensions	90
Cross Tie Sections	elements of sections	129
	profiles, weights and dimensions	76, 77
	safe load tables	165
Cubes and Cube Roots	numbers 1 to 999	330-349

INDEX

	PAGE
Decimal Table	equivalents of an inch and of a foot 359
Deflection, Lateral	explanatory notes and formula 96, 139, 149
Deflection, Vertical	explanatory notes 139, 147, 148
	coefficients, calculation and table 148
	coefficients for beams and channels . . 157-161, 165-168
	limit for plastered ceilings 147
	formulas loading under various conditions . . 143-146
Deformed Bars	concrete reinforcement bars, sizes and weights 68
Elasticity	elastic limit of substances 304, 305
	modulus of elasticity of substances . . 141, 289, 304-306
Elements of Sections	explanatory notes 101
	formulas for calculation of elements 102-109
	structural shapes, rails, etc 110-130
Equivalent Measures	metric and U. S. standard 308-319
Expansion, Heat	table of coefficients 307
Eye Bars	sizes, dimensions and weights 86
Fiber Stresses	concrete, reinforced concrete 306
	masonry, stone 306
	metals, alloys 304, 305
	miscellaneous substances 306
	structural steel 95, 305
	structural timber 289
Fireproof Floors	see Floor Construction 260-278
Flat Rolled Steel	list of sizes 55-58
	tables of weights 59-61
Flexure of Beams	explanatory notes and formulas 138-146
Floor Construction	explanatory notes 260-264
	live loads, various building laws 265
	reinforced concrete beams and slabs 269-275
	terra cotta arches, safe loads and weights 266-268
	thrust in arches 262-264
Floor Plates	buckle plates 276, 277
	checked plates 54, 278
Formulas	bending moments and deflection 141-146
	elements of sections 102-109
	geometric and trigonometric 320-324, 328, 329
	roof trusses, stresses and length of members . . 282-285
	stresses in beams, bending 138-140
	" " " buckling 151, 152
	" " " impact 149, 150
	" " " shearing 150, 151
Formulas	stresses in columns, cast iron 247
	" " " structural steel 220, 221
	" " " structural timber 289
	stresses in bearing plates and steel slabs . . 185, 252, 253
Functions	numbers 1 to 999 330-349
	trigonometric 350-355

CARNEGIE STEEL COMPANY

	PAGE
Gases	specific gravity and weight 300
Gages for Punching	angles 187
	beams and channels 178, 180
	splice bars 74
Gages, Standard	Birmingham wire gage 356
	United States standard gage 357
	various standard gages 358
Girders, Riveted	explanatory notes 195
	angle and plate girders, safe loads 198-216
	beam and plate girders, safe loads 196, 197
	elements of compound sections 108, 109
Grillage Foundations	explanatory notes and calculation 252-256
Grips of Rivets	length of field rivets 92
H-Beams	beam safe load tables 165
	column safe load tables 223
	elements of sections 112
	profiles, dimensions and weights 17
Half Rounds	list of sizes 65
Hexagons	list of sizes 65
Hollow Sections	rounds and squares, elements 136, 137
	cast iron columns 247-249
	steel pipe columns 250, 251
Impact Stresses	effect on beams 149, 150
Increase of Sections	method of rolling 5
Lateral Deflection	explanatory notes and formula 96, 139, 149
Lattice Bars	dimensions for columns 98
Liquids	coefficients of expansion 307
	specific gravity and weight 300
Live Loads, Floors	building laws of various cities 265
Logarithms	numbers 1 to 999 330-349
Longitudinal Shear	explanation and formula 150, 151
Loop Rods	sizes and dimensions 87
Masonry and Stone	coefficients of expansion 307
	specific gravity and weight 301
	strength, unit fiber stresses 306
Materials	coefficients of expansion 307
	specific gravity and weight 300, 301
	strength, unit fiber stresses 304-306
Measures and Weights	equivalents of U. S. and metric 308-319
Mensuration	mathematical formulas 320-329
Metals and Alloys	coefficients of expansion 307
	specific gravity and weight 300
	strength, unit fiber stresses 304, 305
Metric Tables	weights and measures 308-319
Minerals	specific gravity and weight 301
Modulus of Elasticity	various substances 141, 289, 304-306
Moments of Inertia	definition and formulas 101-109
	rectangles, tables 134, 135
	structural sections, rails, etc., tables 110-130

INDEX

	PAGE
Neutral Axis	definition and formulas 101-107 structural shapes, rails, etc., tables 110-130
Nuts	dimensions and weights 80-83 recessed pin nuts, sizes and dimensions 90 sleeve nuts, sizes and dimensions 89
Nut Steel Flats	list of sizes 58
Ordering Materials	general instructions 4
Piling, Steel Sheet	explanatory notes 257-259 elements 112, 263 profiles 53
Pins	explanatory notes 190 bearing values, tables 193 bending moments, tables 194 cotter pins, sizes and dimensions 90
Pipe	black and galvanized, sizes 78, 79
Pipe Columns	safe loads 250, 251
Plate Girders	see Girders, Riveted 108, 109, 196-216
Plates	extreme sizes 55-57 carbon steel, sheared, rectangular and circular 55, 56 " " , universal rectangular 55 nickel steel, sheared, rectangular 57 " " , universal, rectangular 57
Plates, Floor Plates	buckle plates, explanatory notes and sizes 276, 277 checkered plates, elements and safe loads 278 " " profiles, weights, dimensions 54
Plates, Wall Plates	see Bearing Plates 185, 186
Profiles of Sections	dimensions and weights 7-54, 68, 70-77
Punching	details for punching and riveting 187-189 construction specifications 99
Purlins	explanatory notes 281
Radius of Gyration	definition 101 angles back to back, tables 131-133 formulas for elements of sections 102-109 structural shapes, tables 110-129
Rails	elements of sections 130 profiles, weights and dimensions 70, 72 standard drilling for splice bars 74
Rails and Accessories	weights and dimensions 69
Rail Clips	profiles, dimensions and weights 75
Ratio of Slenderness	definition 217 unit stresses for compression formulas 220, 221
Recessed Pin Nuts	sizes and dimensions 90
Reciprocals	numbers 1 to 999 330-349
Rectangular Plates	extreme sizes, carbon and nickel steel 55-57
Rectangular Sections	areas 62-64 moments of inertia 134, 135
Reinforced Concrete 269-275

CARNEGIE STEEL COMPANY

	PAGE
Rivets and Riveting . . . areas of rivet holes	189
construction specifications	97, 98
conventional signs	187
dimensions	91
lengths for various grips	92
stresses, shearing and bearing values	190-192
structural details for riveting	187-189
weights, with button heads	93
Roofs explanatory notes	279-281
live loads, building laws of various cities	265
snow and wind loads	279
trusses, stresses and length of members	282-285
weights, roof covering and roof trusses	280, 281
Rounds list of sizes	65
weights and areas	66, 67
Screw Threads Franklin Institute, U. S. and A. B. Co. standards	80
Section Modulus definition and formulas	101-109
structural shapes, rails, etc.	110-130
Segments, Circular coefficients of areas	325-327
Separators standard for beams	183
Shearing Stresses longitudinal and vertical	138, 150, 151
Sheared Plates extreme sizes, carbon-and nickel steel	55-57
Shearing Values, Rivets tables	191, 192
Ship Bldg. Bulb Angles profiles and properties	18-24, 116-119
Ship Building Channels profiles and properties	26-35, 114-115
Skelp list of sizes	58
Sleeve Nuts sizes and dimensions	89
Snow Loads roofs and trusses	279
Specifications American Bridge Company	94-100
Specific Gravity various substances	300, 301
Splice Bars elements of sections	130
profiles, dimensions and weights	71, 73
standard punching for rails	74
Square and Round Bars weight and areas	66, 67
Square Edge Flats list of sizes	58
Squares list of sizes	65
weights and areas	66, 67
Squares, Square Roots numbers 1 to 999	330-349
Standard Dimensions beams and channels	6
Steel Sheet Piling elements	112, 259
explanatory notes	257-259
profiles	53
Strength of Materials unit fiber stresses	304-306
Stresses see Beam Stresses and Fiber Stresses	
Tees elements of sections	126, 127
profiles, weights and dimensions	44-50
safe load tables	176
Terra Cotta arches, ceilings, furring, partition, roofing	262-268
Threads length of bolt threads	81
standard dimensions of screw thread	80
Thrust in Arches effect in floor construction	262-264

INDEX

	PAGE
Tie Rods.....	length and weight..... 184
	spacing..... 264
Timber, Structural....	A. R. E. A. unit stresses and explanatory notes. 288, 289
	beams, deflections, limiting loads and spans... 291
	" explanatory notes..... 290
	" safe load tables..... 292-296
	coefficients of expansion..... 307
	columns, explanatory notes..... 297
	" safe load tables..... 298, 299
	specific gravity and weight..... 300
	concrete reinforcement..... 275
Trigonometric Formulas	functions of angles and triangles..... 322, 323
Trigonometric Functions	natural..... 350-355
Trusses.....	explanatory notes..... 281
	stresses and length of members..... 282-285
Turnbuckles.....	size and dimensions..... 89
Unit Stresses.....	see Fiber Stresses.....
Universal Mill Plates...	extreme sizes, carbon- and nickel steel..... 55, 57
Upset Screw Ends.....	square and round bars..... 84, 85
U. S. Standard Gage...	sheet and plate iron steel..... 357
U. S. Sheet Piling.....	elements..... 112, 259
	explanatory notes..... 257-259
	profiles..... 53
Vertical Shear.....	explanation..... 150
	formulas for various conditions of loading..... 143-146
Volume and Surface...	solids..... 328, 329
Web Resistances.....	beams and channels..... 154-156
Weights.....	flat rolled steel, tables..... 59-61
	rounds and squares..... 66, 67
	structural shapes, rails, etc..... 7-54, 68-77
	various substances..... 300-303
Weights and Measures..	metric and U. S. Standard..... 308-319
Wind Loads, Pressure..	building specifications of various cities..... 265
	roofs and trusses..... 279
Wire and Sheet Metal..	standard gages..... 356-358
Wooden Beams, Columns	see Timber, Structural..... 290-299
Zee Bars.....	elements of sections..... 128
	profiles, weights and dimensions..... 51, 52
	safe load tables..... 177

PRODUCTS

Blast Furnace Products.

Bessemer and Basic Pig Iron
Ferro-Manganese, Spiegeleisen

Semi-Finished Open-Hearth and Bessemer Products.

Ingots, Blooms, Billets, Slabs, Sheet Bars

Structural Mill Products.

Beams, Channels, Angles, Tees and Zees
Ship and Car Building Channels and Bulb Angles
Beam and Channel Cross Tie Sections
H-Beams for Steel Mine Timber
Steel Sheet Piling Sections
Miscellaneous Sections for Special Manufacture

Bar Mill Products.

Bar-size, Channels, U-Bars, Angles, Tees and Zees
Square Root and Round Back Angles
Merchant Bars and Flat Rolled Steel
Squares, Rounds, Half Rounds, Hexagons, Ovals
Square Edge, Band Edge and Round Edge Flats
Cooperage Steel, Hoop and Band Steel, Cotton Ties
Tire Steel, Round Edge and Oval Edge, Toe Calk Steel
Spring Steel, Round Edge and Round Edge Concave
Automobile, Vehicle and Railway Spring Steel
Tongue and Groove Spring Steel
Bevel Edge, Bevel Nose, Round Bevel Edge Sections
Miscellaneous Bevels, Scarfed Skelp, Drill Point Steel
Agricultural Sections
Cultivator and Harrow Beams and Channels
Channel Tire and Miscellaneous Vehicle Tire
Automobile Rim Sections
Barrel Sections, Can Ring Sections, Beaded Band Sections
Casement and Window Sash Sections
Concrete Reinforcement Bars
Squares, Rounds, Cold-Twisted Squares and Deformed Bars
Crescents, Hame, Neck Yoke and Pole Cap Sections
Strap and Clip Sections
Hame Straps, Box Straps, Bit Mouth Clips, etc.
Magneto and Pole Sections
Pipe Sections, Locking Bar Sections
Miscellaneous Sections for Special Manufacture

PRODUCTS

Plate Mill Products.

Sheared Plates, Rectangular and Circular
Universal Mill Plates, Rectangular
Checkered Floor Plates
Skelp

Rail Mill Products and Track Accessories.

Heavy Rails, Standard and Miscellaneous
Standard Light Rails, 45 pounds per yard and under
Angle Splice Bars and Fish Plates
Rail and Track Accessories, Miscellaneous Sections
Rail Frog Fillers and Reinforcing Bars
Beam, Channel or Trough Cross Ties
Heavy Types for Railroad Tracks
Lighter Types for Mines and Industrial Purposes
Portable Tracks

Alloy Steels for Various Purposes.

Wrought and Forged Steel Products.

Axles, Untreated, Annealed or Quenched and Tempered
Electric and Steam Railway Car Axles
Locomotive Driving and Trailing Axles, Tender Axles
Wheels, Solid Wrought, Carbon Steel
Wheels for Electric and Steam Railway Service
Wheels for Industrial and Mine Locomotives and Cars
Crane Tracks, Wheel Blanks
Miscellaneous Circular Sections
Flywheel and Brake Drum Blanks for Motor Trucks
Locomotive Piston Blanks

Fabricated Steel Products.

Steel Mine Timber, Gangway Sets and Mine Props
Framing for Underground Construction
Steel Sheet Piling

Coke and Coke By-Products.

Clairton Nut Coke
Ammonia Liquor, Ammonium Sulphate,
Solvent Naphtha, Naphthalene, Benzol and Toluol

Blast Furnace Slag.

Crushed, Granulated, Sand and Concrete Slag

PUBLICATIONS

Carnegie Pocket Companion

Structural Steel Shapes

Carnegie Shape Book

Flat Rolled Steel and Merchant Bars

Round Steel Bars

Rails and Angle Bars

Light Rails and Fastenings

Steel Cross Ties

Wrought Steel Wheels and other Circular Sections

Forged Steel Axles

Standard Specifications

Steel Sheet Piling

Steel Mine Timber

CARNEGIE STEEL COMPANY

WORKS

BLAST FURNACES

Carrie Furnaces	Rankin, Pa.
Isabella Furnaces	Etna, Pa.
Lucy Furnaces	Pittsburgh, Pa.
Neville Furnace	Neville Island, Pa.

STEEL WORKS, FURNACES AND ROLLING MILLS

Bellaire Steel Works and Furnaces	Bellaire, O.
Clairton Steel Works and Furnaces	Clairton, Pa.
Duquesne Steel Works and Furnaces	South Duquesne, Pa.
Edgar Thomson Steel Works and Furnaces	Bessemer, Pa.
Farrell Steel Works and Furnaces	Farrell, Pa.
Homestead Steel Works	Munhall, Pa.
Mingo Steel Works and Furnaces	Mingo Junction, O.
New Castle Steel Works and Furnaces	New Castle, Pa.
Ohio Steel Works and Furnaces	Youngstown, O.

ROLLING MILLS

McCutcheon Mills	Pittsburgh, N. S., Pa.
McDonald Bar Mills	McDonald, O.
Upper Union Mills	Youngstown, O.
Lower Union Mills	Youngstown, O.

FORGE AND WHEEL WORKS

Howard Axle Works	Homestead, Pa.
Schoen Steel Wheel Works	McKees Rocks, Pa.

COKE WORKS

Clairton By-Product Coke Works	Clairton, Pa.
Farrell By-Product Coke Works	Farrell, Pa.

WAREHOUSES

Baltimore Warehouse	Baltimore, Md.
Cleveland Warehouse	Cleveland, O.
New England Warehouse	Boston, Mass.
Pittsburgh Warehouse	Pittsburgh, Pa.
Texas Warehouse	Houston, Tex.
Waverly Warehouses	Newark, N. J.

CARNEGIE STEEL COMPANY

SUBSIDIARY OF UNITED STATES STEEL CORPORATION

OFFICES

GENERAL OFFICES:

Pittsburgh, Carnegie Building, 434 Fifth Avenue.

DISTRICT OFFICES:

Birmingham, Brown-Marx Building, 2000 First Avenue, North,
Boston, Statler Office Building, 20 Providence Street,
Buffalo, The Marine Trust Co. Building, 233-239 Main Street,
Chicago, 208 South La Salle Street,
Cincinnati, Union Trust Building, Fourth and Walnut Streets,
Cleveland, Rockefeller Building, 614 Superior Avenue, N. W.,
Denver, First National Bank Building, 17th and Stout Streets,
Detroit, Buhl Building, 535 Griswold Street,
New Orleans, Maison Blanche, 921 Canal Street,
New York, Empire Building, 71 Broadway,
Philadelphia, Widener Building, Chestnut and Juniper Streets,
Pittsburgh, Carnegie Building, 434 Fifth Avenue,
St. Louis, Liberty Central Trust Co. Building, 506 Olive Street,
St. Paul, Merchants National Bank Building, Fourth & Robert Sts.

EXPORT DISTRIBUTORS:

UNITED STATES STEEL PRODUCTS CO.

New York, Hudson Terminal Building, 30 Church Street.

PACIFIC COAST DISTRIBUTORS:

UNITED STATES STEEL PRODUCTS CO., PACIFIC COAST DEPT.

San Francisco, Russ Building, 235 Montgomery Street,
Los Angeles, 2087 East Slauson Avenue,
Portland, 777 Nicolai Street,
Seattle, Fourth Avenue South and Connecticut Street,
Honolulu, T. H., Castle and Cook Building.

