



## Summary

### SpeedCore Summit

Wednesday, March 20, 2019  
10 a.m. – 4:00 p.m.  
Hyatt Regency DFW  
2334 North International Parkway  
Dallas, TX 75261

*Summary Writeup by Devin Huber and Jennifer Traut-Todaro*

## 1. Overview

### 1.1. Summit Goal

*Our goal with this Summit and subsequent discussions is to get more practicable information out into the market for better understanding, increased comfort, accurate bidding, and SpeedCore market growth. We want to discuss the industry's reaction to the system, what information is missing from your point of view, and develop content to bring to the market this year.*

### 1.2. Attachments

- Attendee List (A)
- Meeting Agenda (B)
  - Research Outcomes Presentation (C)
  - Rainier Square Presentation (D)
  - SpeedCore Generalized Non-Seismic (Wind) Details Presentation (E)
  - Supreme Group Presentation on fabrication of panels (F)

### 1.3. Notes on Summary

The intent of this meeting summary is:

1. Provide a general overview of the Summit
2. Disseminate key discussion points
3. Provide a reference to attendees they can use when considering using SpeedCore

### 1.4. Discussion Topics

- Non-Seismic Design vs. Seismic Design
- Wall to Foundation Details
- Splice Options and Connection Details
- Erection Considerations
- Plate utilization and availability
- Fire Resistance – opportunities for fire engineering
- Marketing Approach

## 2. Wind Design vs. Seismic Design

### 2.1. Overview

One important consideration for pricing and specifying SpeedCore is to know the differences between using it in a seismic controlled region vs. a non-seismic, i.e. wind, region. The differences between seismic and non-seismic design requirements for SpeedCore system will impact the final, as-constructed system.

If you are looking to replace a reinforced concrete (RC) core with a SpeedCore system, a conservative first approximation assumes the overall cross-sectional area would stay the same. With more refined engineering, it is likely a more efficient cross-section could be used (thinner overall). Optimizing the wall design could potentially reduce the area by 20%.

The primary changes between a SpeedCore systems and an RC core would be:

- Rebar would not be required in SpeedCore
- External face plates would be used in SpeedCore
- The addition of cross ties would be required
- Steel-to-steel splices would be required between SpeedCore panels

Following the above assertions with the recommendations given below, an accurate high-level conceptual design could be developed and specified and or priced. If the system were to be newly designed for a particular building, the initial dimensions of the SpeedCore would need to be verified by the EOR using recommended design principles.

### 2.2. General Design Requirements (Figure 1)

**Non-seismic or wind** governed structures are generally designed by a prescriptive method (i.e. following a set of prescribed formulas estimating the lateral loads imposed on the building). The capacity of the structure must meet that required by the calculations. Generally speaking, non-seismic SpeedCore applications will be **strength governed**.

**Seismic** governed structures are designed by a prescriptive or a performance-based method. The capacity of the structure is more variable among components. The design process intentionally forces failure mechanisms into more structurally desirable components to act as fuses to maintain the integrity of the surrounding structure and protect occupants during an earthquake event. In the case of the SpeedCore System, plastic hinges (Figure 1) are designed to develop in the horizontal link beams that connect wall sections or modules between wall openings and at the base of the wall between the wall module and the supporting foundation. The expectation of plastic hinge development in the link beams and the wall base connection adds additional loading requirements to the wall components surrounding them. Generally speaking, seismic SpeedCore applications will be **stiffness governed**.

### 2.3. Specific Components Design Requirements Common to both Seismic and Non-Seismic Regions

One important topic brought up at the summit was what were the major differences between seismic and non-seismic design. Key differences were presented at the beginning of the summit through the presentations made and further smaller group discussion occurred afterward to discuss these in detail.

Please note, for the sake of completeness, a few equations for some of the basic checks to try and determine initial sizing of panels are included in the next few sections. These equations do not preclude a full engineering analysis and design being done by a qualified engineer. The inclusion of these equations is intended to aid the Fabricator or Erector in preparing material quantity take-offs only.

### 2.3.1. Minimum Area of Steel Plates and Plate Thickness

The steel plates shall comprise at least 1% of the total composite cross-section area. This is a stipulation based on the requirements for composite columns.

- Note that this is useful if one were comparing to 'like-for-like' replacement with a reinforced concrete core
- This resulting plate thickness may be quite small based on the 1% stipulation and it is recommended for handling of panels a plate thickness of at least 3/8" is used

In general, plate thickness will not be governing overall system strength or serviceability requirements. For a majority of non-seismic applications and also for many seismic locations, except in critical areas defined later, plate thicknesses of 3/8" to 5/8" would be expected. Some equations are given in subsequent sections to aid in helping the Fabricator/Erector in approximating sizes a bit more concisely (for value engineering activities or similar).

### 2.3.2. Slenderness Requirements

For both seismic and non-seismic areas, the steel plates of composite walls are required to be non-slender, i.e., yielding in compression must occur before local buckling. Based on recent research, a simple equation has been developed to check slenderness requirements for SpeedCore panels. It is presented below and allows for a quick check to see what sort of thickness of plate would be required if the tie spacing and yield strength of the steel is known. The first check for slenderness requirements of a SpeedCore panel is given as:

$$\frac{b}{t_p} = 1.2 \sqrt{\frac{E}{F_y}} \text{ (Equation 1)}$$

where,

$b$  = largest unsupported length of the faceplate between rows of steel anchors or ties, in. (mm)

$t_p$  = thickness of faceplate, in. (mm)

$E$  = Young's Modulus of Steel (ksi)

$F_y$  = Yield Stress of Steel (ksi)

In most cases, Equation 1 is adequate for checking slenderness of the SpeedCore system. There is one exception to this and this in a seismic case at the base of the wall where flexural (bending) yielding will occur. For this case, the following slenderness check is required.

$$\frac{b}{t_p} = 1.05 \sqrt{\frac{E}{R_y F_y}} \text{ (Equation 2)}$$

where,

$R_y$  = Ratio of the expected yield stress to the specified minimum yield stress (typically assumed to be 1.1 for many structural steel plates and shapes)

Should  $R_y$  be set to 1.1, as per typical practice, Equation 2 simplifies to  $\frac{b}{t_p} = 1.0 \sqrt{\frac{E}{F_y}}$ . This implies that in a seismic region, that at the base of the walls either tie spacing is decreased or plate thickness is increased by a factor of approximately 20%.

Note the above equation are the result of several research projects and further background is available from Zhang et al. (2014).

### 2.3.3. Maximum height of stacked empty modules prior to concrete placement

In lieu of further analysis, the height of empty modules should stay within two-three stories, or 30 ft, above the floor framing below. Shafaei (2018) provides the theoretical background to this basis.

### 2.3.4. Tie Spacing & Diameters

For pricing and planning purposes, using a tie spacing equal to or less than the overall composite wall thickness is sufficient, and 10 in. being the maximum tie spacing to specify for any wall greater than 10 in. thick and using 36 ksi or 50 ksi material. Similarly, for tie diameter, a 1 in. diameter tie will work for a range of wall thicknesses (10-36 in. thick) using both 36 ksi and 50 ksi material.

Should some refinement on tie spacing and diameter be desired, two equations are given herein to more precisely determine these variables. These equations are based on research completed by Shafael (2018). As such, equations relating tie spacing, tie diameter and plate thickness are given as:

$$\frac{S}{t_p} \leq 1.0 \sqrt{\frac{E_s}{2\alpha+1}} \quad (\text{Equation 3})$$

$$\alpha = 1.7 \left[ \frac{t_{sc}}{t_p} - 2 \right] \left[ \frac{t_p}{d_{tie}} \right]^4 \quad (\text{Equation 4})$$

where,

$S$  = largest clear spacing of the ties (maximum tie spacing allowed is the thickness of the composite wall)

$t_p$  = thickness of the steel plate

$t_{sc}$  = thickness of the composite wall

$d_{tie}$  = effective diameter of the tie

While the equation appears somewhat complex, simple tables can be extrapolated that allow for quick checks on maximum tie spacing and minimum tie diameters for different panel thicknesses and yield strengths of steel. To demonstrate application of the above equations, Table 1 and Table 2 are shown below. These tables show calculated tie spacing and diameters required for given plate thickness of  $\frac{3}{8}$ " (Table 1) and  $\frac{1}{2}$ " (Table 2) for varying overall wall thicknesses.

### 2.3.5. Tie to plate connections

The tie bar to steel plate connection shall develop the full yield strength of the tie bar.

## 2.4. Non-Seismic Design - Specific Components of SpeedCore System

### 2.4.1. Wall-to-Foundation Details

The capacity of the wall-to-foundation connection shall be adequate to resist the governing lateral load combination. The magnitude of loading to consider depends on the height, building location, overall geometry, and other site specific parameters. Specific types of potential configurations for this wall-to-foundation connection are described in Section 3.



## 2.4.2. Splices Between Panels

The splice shall be adequate to resist the loads resulting from governing load combinations. The splice between panels can be bolted or welded, but shall be rigid enough that the connected panels move as a single unit.

## 2.4.3. Coupling Beam (Figure 2)

In a non-seismic region, the coupling beam can be any sort of steel member - no requirement for a composite coupling beam. It is designed to force demands of the governing load combination. Important consideration for the coupling beam include:

- Ends of beam to be fixed, i.e. restrained against rotation
- Fabricator and Erector can work with the engineer to determine most economical solution for a specific project
- One solution highlighted at the summit is shown in Figure 2 - which utilized a wide flange beam with end plates embedded into the wall at the ends
  - Note this is just one potential solution - there are many others that could be utilized for a specific project

## 2.4.4. General Detailing

There are no specific additional detailing requirements beyond what would be normal practice for a steel building - however, some things to consider when using the system are:

- It is recommended to taper plates gradually from the wider wall section to the narrower wall section (i.e., avoid abrupt transitions) if there is a change in wall thickness over the height
- It is recommended to try and minimize workers having to work between external plates (within the wall) for both safety and economic considerations
- It is recommended that the splice detail between panels is carefully coordinated with the Fabricator and Erector to maximize efficiency in both the shop and field

# 2.5. Seismic Design - Specific Components of SpeedCore System

## 2.5.1. Wall-to-Foundation Connection

The wall-to-foundation connection considers the full seismic effect (loads) and shall be required to meet the requirements of:

- Shear: The required shear strength for the wall-to-foundation connections shall be equal to the required shear strength for the composite walls.
- Overturning: The required overturning strength for the wall-to-foundation connections shall be equal to the amplified overturning moment caused by the formation of the plastic hinges.
- As was mentioned previously, there are more stringent requirements at the base to allow for full flexural yielding

## 2.5.2. Splices Between Panels

The splice is designed to meet the capacity of the plates being connected to allow for ductility and full force transfer between plates. Some potential types of splice details that could be used are shown in Section 4.

## 2.5.3. Coupling Beams (Figure 3)

Coupling beams in a seismic area are designed to reach full capacity of composite beam (formation of plastic hinges at beam ends). Currently, coupling beams in seismic areas are required to be a composite steel-concrete beam. However, there is upcoming research that will investigate using alternative configurations for the coupling beams including rolled steel sections.

There are different ways to configure a composite couple beam in coupled wall system using SpeedCore - one such concept is shown in Figure 3, which was one of the options considered for use on the Rainier Square Project.

## 2.5.4. General Detailing

There are additional detailing requirements when the system is used in a seismic area and is intended to behave as noted previously. One critical item is with respect to requirements around protected zones. Some of the key considerations for protected zones include:

- Protected zone *areas* when using the SpeedCore system in a seismic location are defined as:
  - (a) The regions at the end of the coupling beams subjected to inelastic straining
  - (b) The regions at the base of the composite walls subjected to inelastic straining
- Protected zone *components* in a SpeedCore System are defined as:
  - (a) Welds connecting the composite wall flange (closure) plates to the web plates
  - (b) Welds connecting the coupling beam web plates to flange plates in built-up box sections
  - (c) Welds in the composite wall steel plate splices
  - (d) Welds at composite wall steel plate-to-base plate connections
- Welds in protected zones are classified as demand critical welds and requirements for these types of welds are given in AISC 341 Section A3.4b and Section I2.3

Table 1: Application of Eqns 1-4 to Determine Tie Spacing and Diameter for Various Grade Steels - 3/8" Plate

Plate Thickness (in.)	Wall Thickness (in.)	Plate Yield Stress 36 ksi		Plate Yield Stress 50 ksi		Plate Yield Stress 70 ksi	
		Max Tie Spacing (in.)	Min Tie Dia. (In.)	Max Tie Spacing (in.)	Min Tie Dia. (In.)	Max Tie Spacing (in.)	Min Tie Dia. (In.)
3/8	10	10	1/2	10	1/2	10	1/2
	12	12	1/2	11	3/4	10	1/2
	18	13	3/4	11	3/4	10	5/8
	24	13	3/4	11	3/4	10	5/8
	30	13	3/4	11	3/4	10	5/8
	36	13	3/4	11	3/4	10	5/8

Table 2: Application of Eqns 1-4 to Determine Tie Spacing and Diameter for Various Grade Steels - 1/2" Plate

Plate Thickness (in.)	Wall Thickness (in.)	Plate Yield Stress 36 ksi		Plate Yield Stress 50 ksi		Plate Yield Stress 70 ksi	
		Max Tie Spacing (in.)	Min Tie Dia. (In.)	Max Tie Spacing (in.)	Min Tie Dia. (In.)	Max Tie Spacing (in.)	Min Tie Dia. (In.)
1/2	10	10	1/2	10	1/2	10	1/2
	12	12	5/8	12	5/8	12	5/8
	18	18	3/4	15	3/4	13	5/8
	24	18	7/8	15	3/4	13	3/4
	30	18	1	15	7/8	13	3/4
	36	18	1	15	7/8	13	3/4

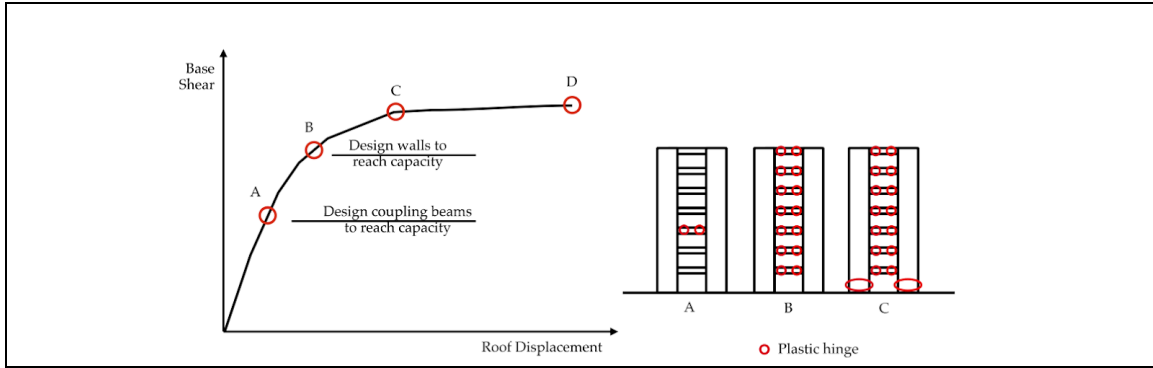

Figure 1: Characteristic Pushover Behavior (Broberg et al. 2019) Showing Plastic Hinge Locations

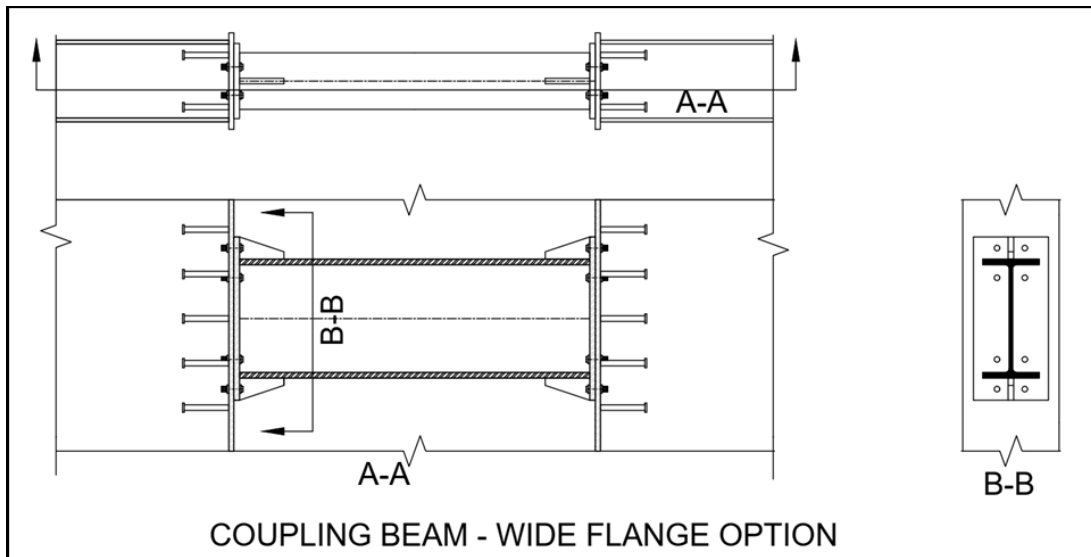
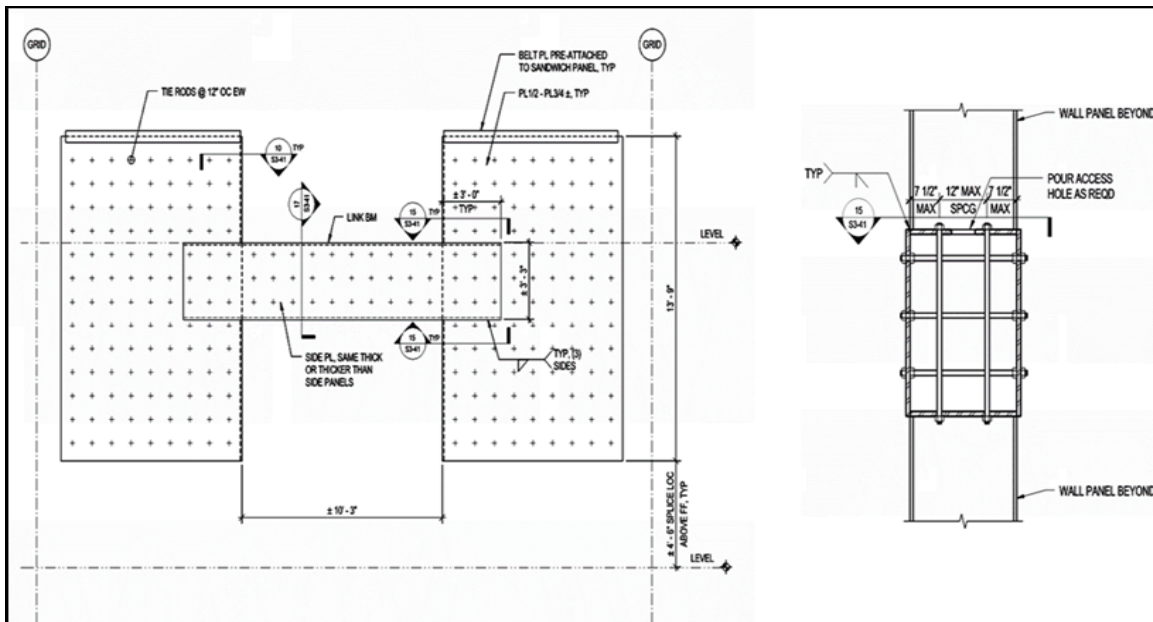

Figure 2: Potential Coupling Beam Option Using Wide Flange Beam and Embedded End Plates



## **3. Wall-to-Foundation Connection Options and Potential Details**

### **3.1. Overview**

A critical component of the SpeedCore system is the connection between the wall system itself and the supporting foundation system. Seismic and non-seismic detailing differ in complexity, strength, and cost. The smaller groups discussed some potential details that could be utilized with SpeedCore wall-to-foundation connections and the outcome of these discussions are described herein.

### **3.2. Potential Wall-to-Foundation Details**

Several different potential details for the connection of the panel walls to the foundation were discussed among the smaller groups. Based on the feedback received, the details noted below were developed by attendees. Initially, wall-to-foundation discussion was split between seismic and non-seismic considerations. However, it was noted that the same sort of general concepts were preferred regardless of it being in a seismic or non-seismic region. One consideration in seismic areas is that the wall-to-foundation detail is deemed a protected zone and specific detailing requirements apply as were noted previously in Section 2.5.4.

One important distinction to make, and as previously discussed, is that in the non-seismic case, the capacity of the wall-to-foundation connection shall be adequate to resist the governing lateral load combination and need not be designed to have the same shear capacity as the entire wall system.

All details presented are concepts and could be expounded upon and further developed. However, the final requirements for the wall base to foundation connection detail is a function of the force demands and it is up to the Engineer to decide how to accommodate those demands. It is recommended that the Engineer is involved early with the Fabricator to make the most constructable detail that can achieve the technical requirements.

For all details shown, the figures are assumed to be looking at a wall cross section, denoted in Figure 4 below as Section A-A.

#### **3.2.1. Perimeter Embed Plate Option (Figure 5)**

An embed plate running the perimeter of the wall to which the base walls are welded or bolted - whatever is the preference of the Fabricator and Erector as shown in Figure 5.

#### **3.2.2. Perimeter Angles Plate with Anchor Rods (Figure 6)**

Another option for the base connection could be angle plates with anchor rods attached to the wall as shown in Figure 6. This detail is very similar to the one shown in Figure 5, with the exception of using anchor rods in lieu of embedded shear studs. The details are likely interchangeable and ultimately the amount force needing to be transferred to the base would dictate the layout preferred by the Engineer, Fabricator and Erector.

### 3.2.3. Wide Flange Frame Embedment (Figure 7)

One other potential base connection would be a wide flange frame embedment somewhat similar to Rainier Square as shown in Figure 7. Note, that this sort of embedment is likely more applicable to seismic cases.

### 3.2.4. Dowels Embedded into Wall (Figure 8)

Another potential connection at the base could be dowels embedded within wall sections that could have lap splices as needed, shown conceptually in Figure 8.

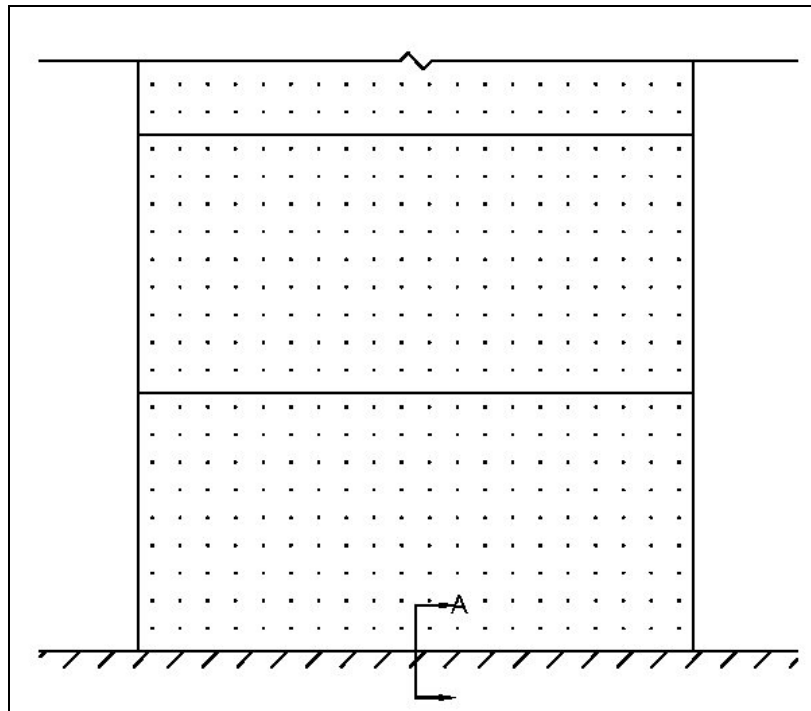

Figure 4: Idealized View Showing Side View of Wall Panels and Section A-A

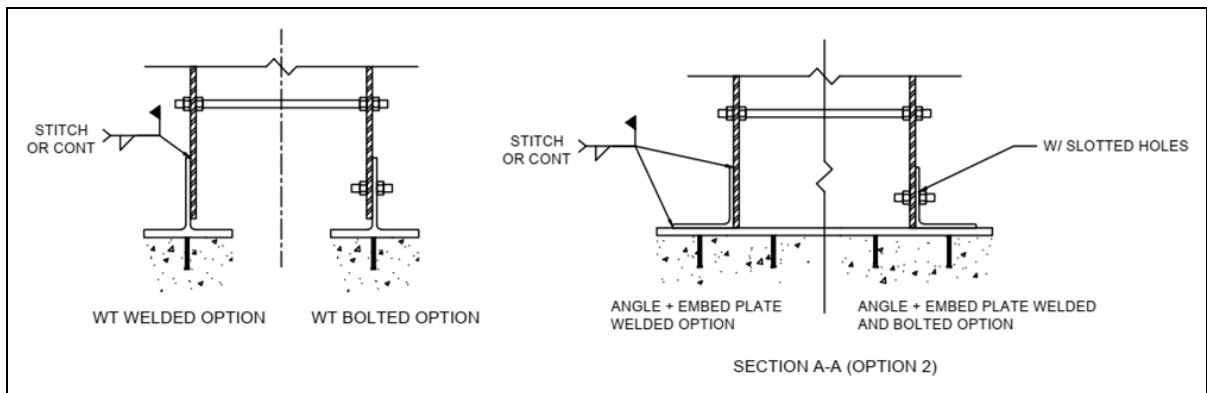

Figure 5: Angle Plates with Embeds Around Perimeter of Foundation

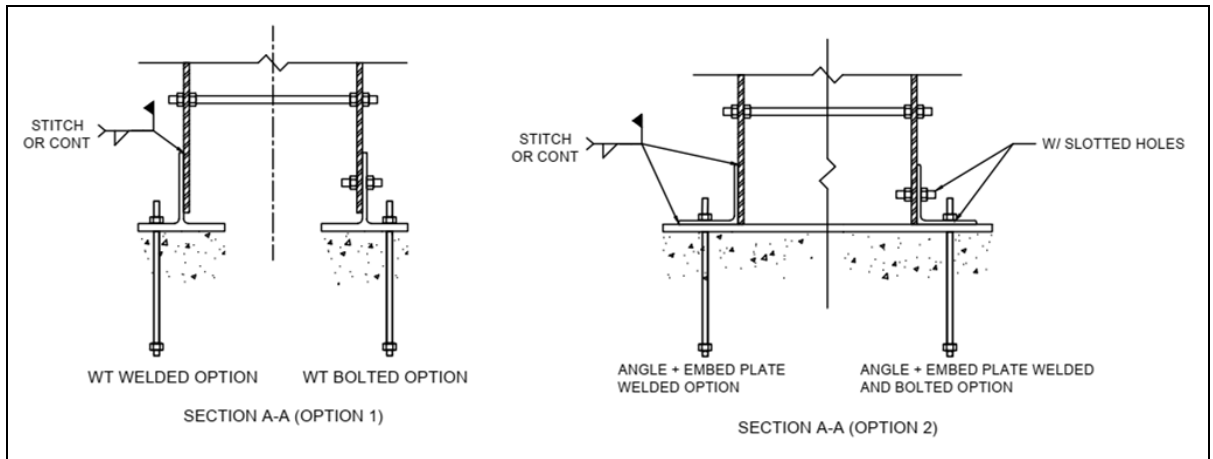

Figure 6: Angle Plates with Anchor Rods Around Perimeter of Foundation



Figure 7: Wide Flange Frame Embedment Used at Rainier Square

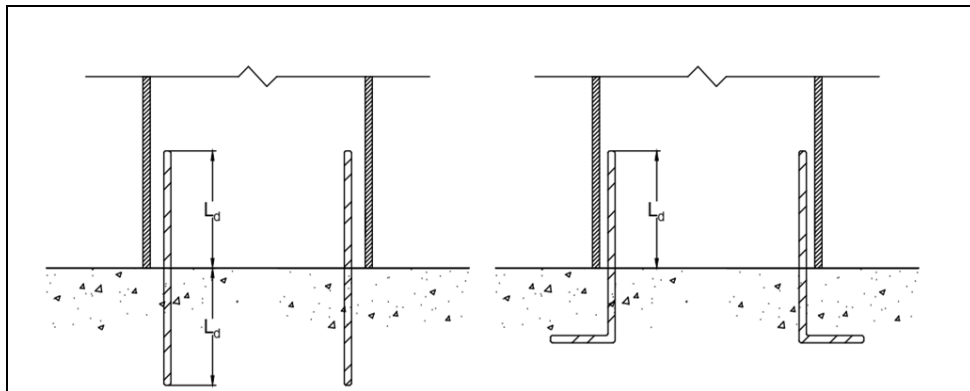

Figure 8: Foundation Schematic with Dowels Embedded into Foundation and Extending into Wall Panel  
(Note: Base Plate Not Shown - likely would be required for this detail)

## 4. Splice Connection Options and Potential Details

### 4.1. Overview

Another critical item discussed by the small groups was options for the splice connections required when using the SpeedCore system. This included splices between panels (vertical and horizontal) and at other critical locations. Some general potential details were developed and are discussed in this section.

Some items to consider while reviewing the details below:

- Splices between panels, both vertical and horizontal, can be achieved through various means and methods
- In a seismic area, there are more limited options as the full capacity of the steel panels must be developed
  - The potential to use bolted connections may be more limited in a seismic area, but could still potentially work.
- For a non-seismic case, the splice is designed to demands of the governing lateral load combination
  - It can be bolted or welded, but should be rigid enough that the connected panels move as a single unit

### 4.2. Bolted Connection Details - Panel Splices

All discussion groups generally expressed a strong preference to use bolted connections – especially if more splices would be required from using narrower plate, oriented vertically in place. Using shorter plates (possibly half-story height) would increase the number of module splices.

#### 4.2.1. Flash Welded Threaded Stud Option (Figure 9)

Flash weld threaded studs to the outward sides panel plates to be joined, use a loose splice plate and affix with washers and nuts as shown in Figure 9 below.

#### 4.2.2. Thru-Bolted Inward Facing Double Angle Splice (Figure 10-13)

This option would use inward facing angles to help and align the connection. There are two variations on this splice. The first would have inward-facing angles that were essentially flush with the end of the plate. This option is shown, with respect to how it could be sequenced, in Figure 10 , Figure 11 and Figure 12 below.

The other option on this splice would be very similar, but the angles would extend slightly past the faceplates and brought together as shown in Figure 13.

#### 4.2.3. Thru-Bolted Inward Facing Single Angle Splice (Figure14)

Another potential bolted splice option, which would also allow for ease of alignment when setting the modules is shown in Figure 14. This option, again, has a single inward facing angle on the lower module ( the module which has another panel being set atop it) only and the angle act more as an erection aid to help with aligning the modules.



#### **4.2.4. Thru-Bolted Outward Facing Double Angle Plate (Figure 15)**

One other bolted splice connection detail discussed was using a double angle concept, but this time have angles facing outward as shown in Figure 15.

#### **4.2.5. Expansion Anchor Bolts (Blind Bolts)**

The use of expansion anchor bolts (Blind Bolts) could offer a distinct advantage at bolted splices as no access on the inside of the all panels would be required. Should they be examined as a potential alternative, careful coordination with the bolt manufacturers would be needed to ensure they are properly utilized.

#### **4.2.6. The Use of Slotted Holes at Panel-to-Panel Splices**

Some of the bolted splice connection details presented showed that slotted holes could potentially be used with them. The intention of this was to allow for some movement and flexibility when trying to erect the panels. It should be noted that there is a reduction in bolt capacity when using slots. However, in non-seismic applications where there is likely lower strength demands at the splice and use of slots could be feasible.

### **4.3. Welded Connections - Panel Splices**

As was mentioned previous in Section 2.5.2, in **seismic** regions the splice between panels is designed to meet the capacity of the plates being connected to allow for ductility and full force transfer between plates. This would likely lead to using a full-penetration weld or some sort of full-depth partial penetration weld being required. As such, welded options for panel splices in seismic areas were not discussed in great detail.

With respect to **non-seismic** areas and based on summit small group discussions, there seemed to be a strong preference for using bolted connections wherever possible at splices. However, some still expressed interest in trying to utilize welded connections, especially if some form of automation could be integrated into the process. One such welded option is described below.

#### **4.3.1. Splice Plate Fillet Welded to Wall Panel (Figure 16)**

Should a welded option be preferred in a non-seismic region, there are several potential options that could be utilized. Note that the design of the weld should ensure the wall panels rotate as a single unit meaning there is no relative rotation between panels. The weld capacity should be adequate to resist loads of the governing lateral load combination.

One example of this would be as shown in Figure 16 below where a splice plate overlaps both of the wall panels to be connection and a fillet weld is placed along the length of the plate connecting the two panels together. This splice could potentially use stitch welds along the length, rather than one continuous fillet weld. Depending on the skill of the local workforce, this type of welded splice could be advantageous for Erectors who implement it.

### **4.4. Column Splices for Columns Within SpeedCore Panels**

When using SpeedCore in a coupled shear wall that has columns between panels or at corners, there will be splices required at the columns. This splice was discussed at the Summit and some of the comments that came forth from the group discussions included:

- Erectors preferred a bolted column splice specifically to ease plumbing exercises
- Bolting or another non-welded solution would avoid the need for two welders on opposing sides of the column, an expensive technique employed to avoid differential material stresses and to maintain column straightness
- Consideration should be made for adding rebar inside the column to transfer the forces to reduce plate splice requirements

#### 4.4.1. Discreet Attachment Between Wall Module and Corner Column Module (Figure 17-19)

One other consideration discussed to try and simplify column splices and placement was the concept of discrete attachment points between the wall module and column module. This is in contrast to a continuous connection between wall and column modules. This approach would lead to using more link beams at corners, but could aid in aligning and splicing columns.

The idea of discrete attachment points is applied in certain locations at Rainier Square where a wall opening is required adjacent to a corner column. As shown in Figure 17, the lower right hand corner of the shown core uses a series of link beams along the height in lieu of continuous panel to column connection. In non-seismic cases, non-composite link beams could be used or even boundary trusses. These are shown conceptually in Figure 18 and Figure 19.

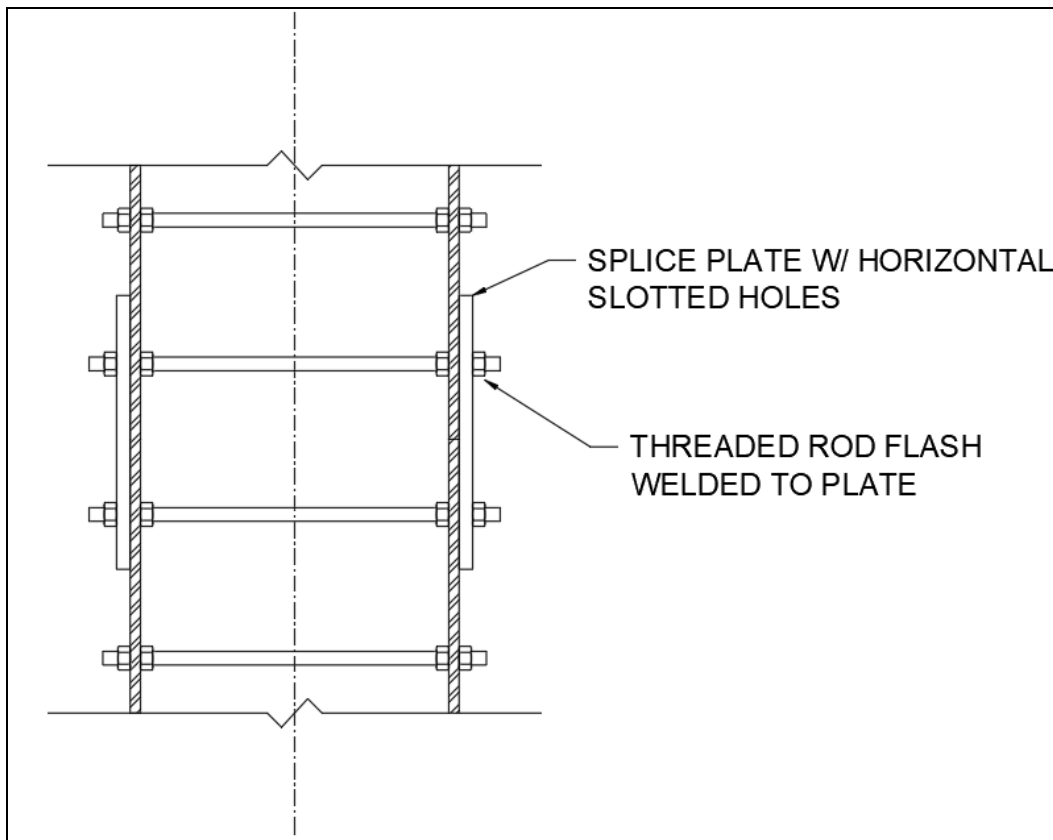

Figure 9: Flash Welded Threaded Stud Bolted Splice Detail

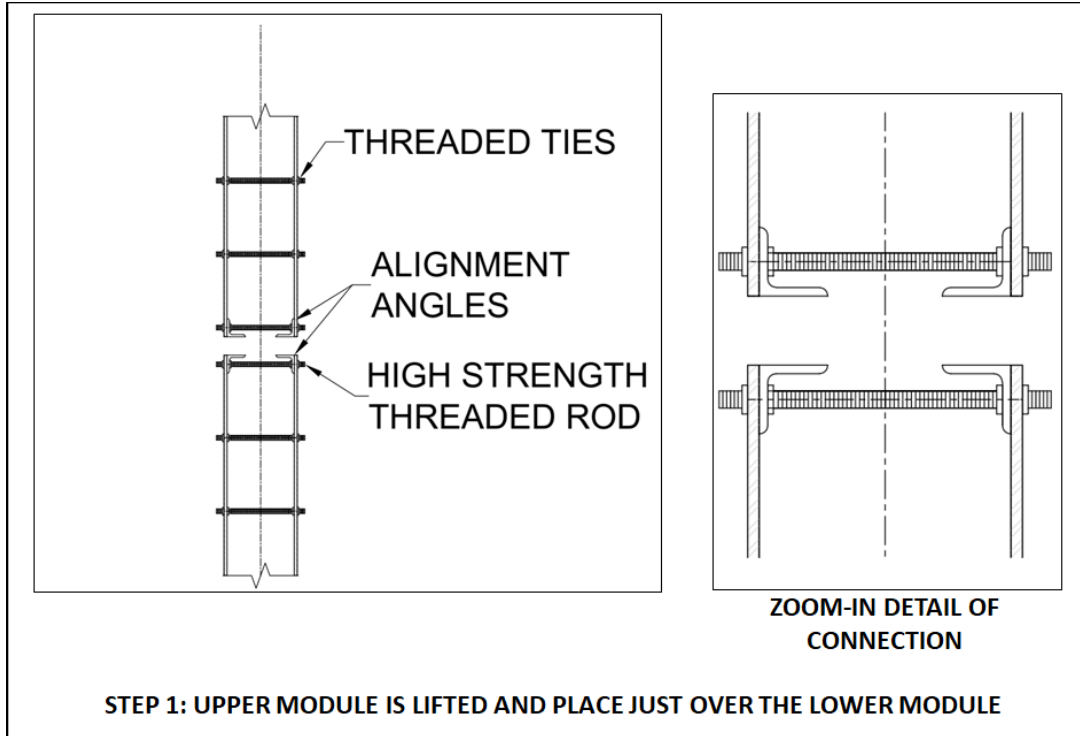

Figure 10: Thru-Bolted Double angle Splice Connection Assembly - Step 1

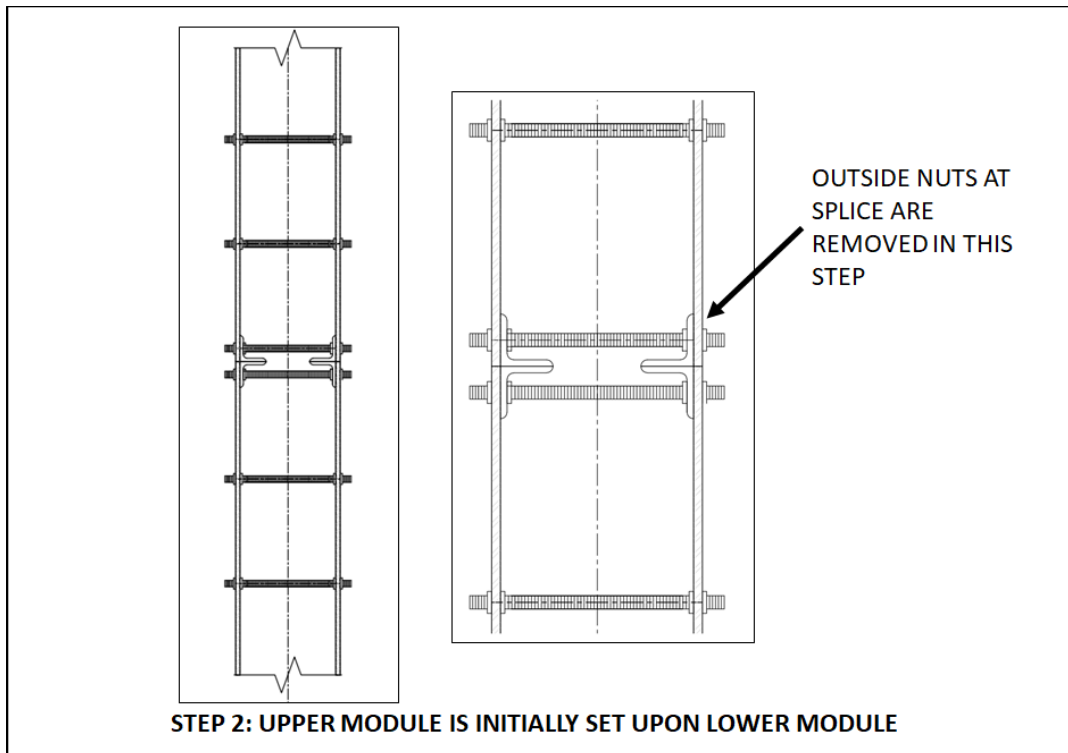

Figure 11: Thru-Bolted Double angle Splice Connection Assembly - Step 2

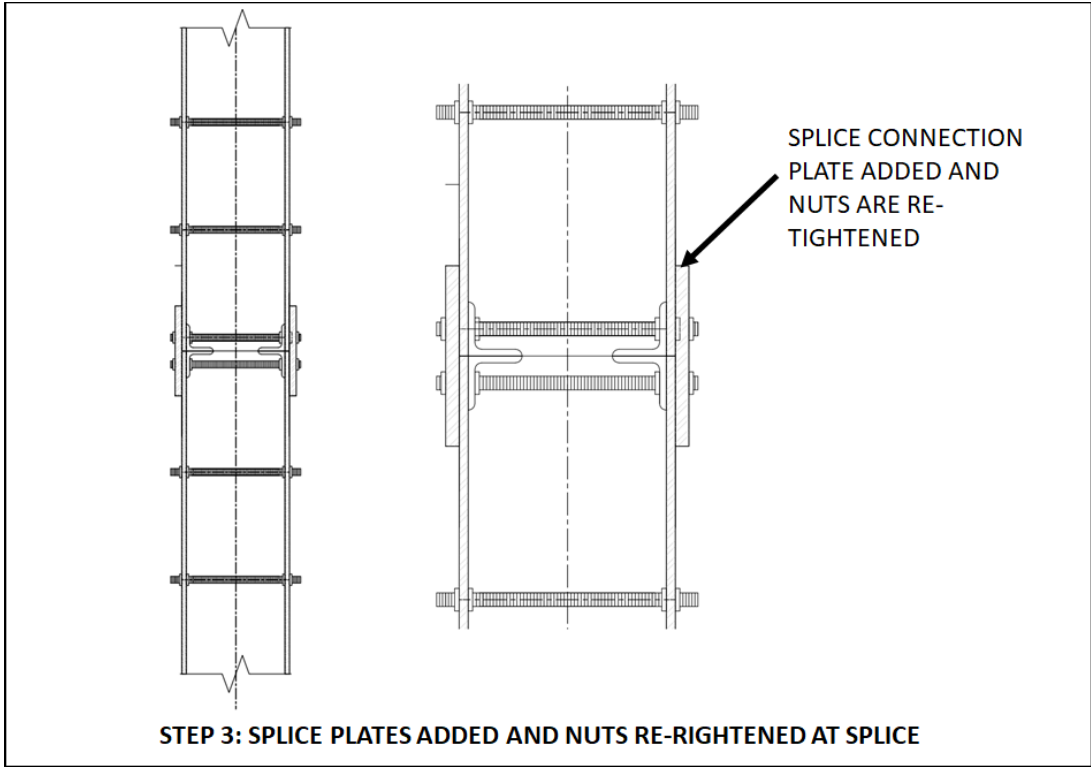

Figure 12: Thru-Bolted Double angle Splice Connection Assembly - Step 3

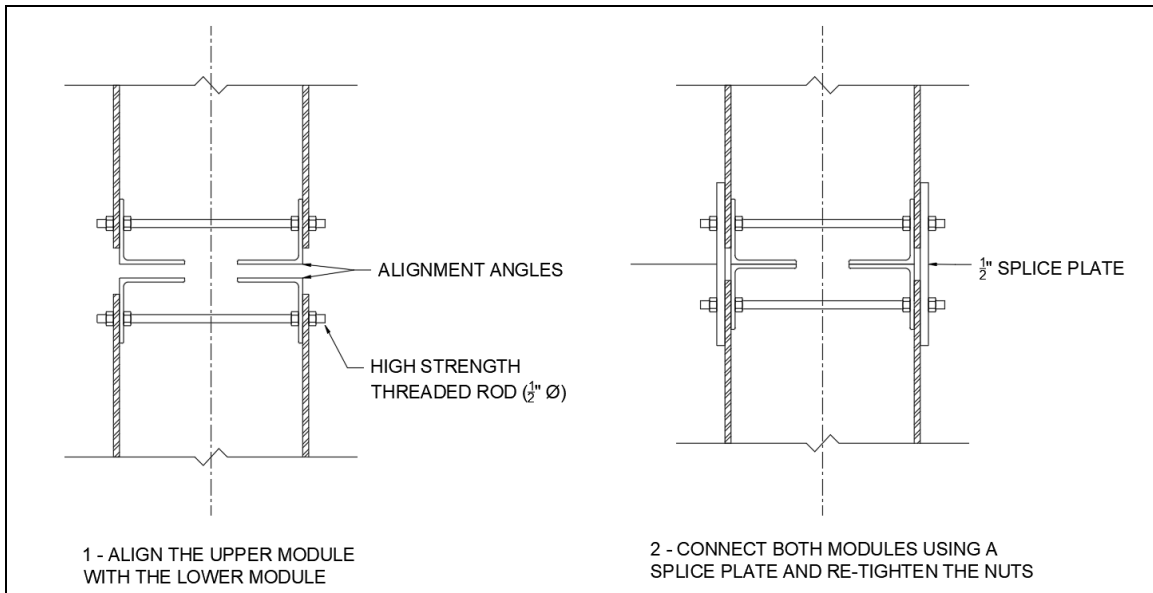

Figure 13: Thru-Bolted Double angle Splice Connection Assembly Option 2

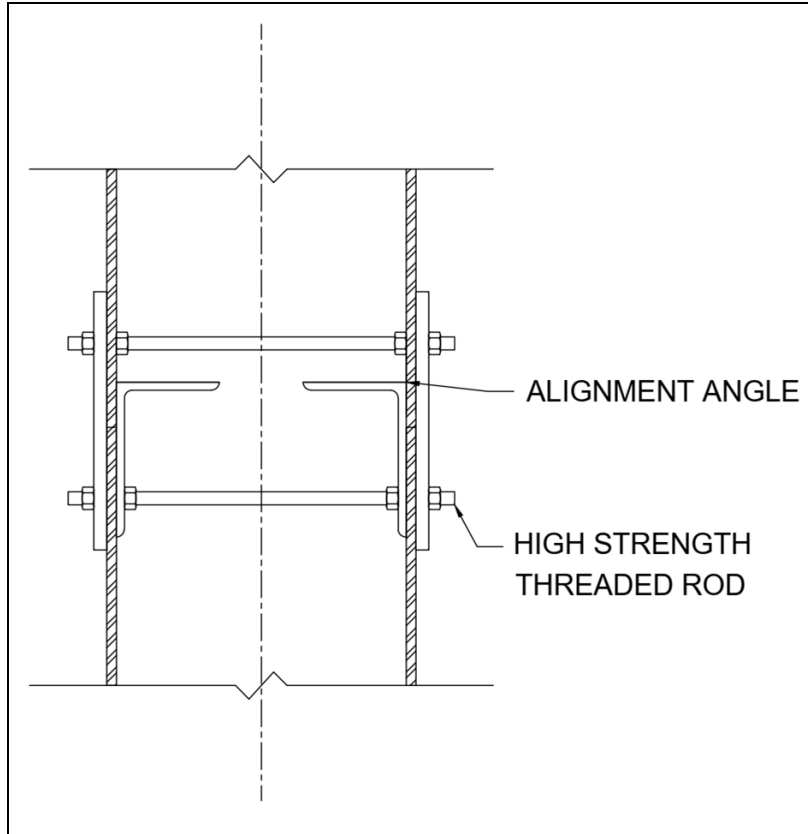

Figure 14: Thru-Bolted Inward Facing Single Angle Splice

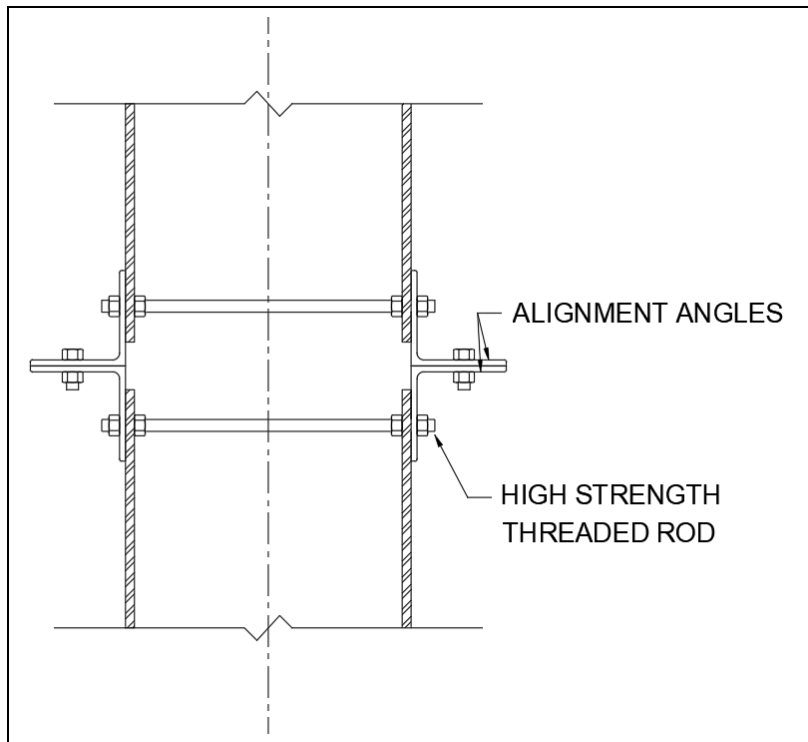

Figure 15: Thru-Bolted Outward Facing Double Angle Plate

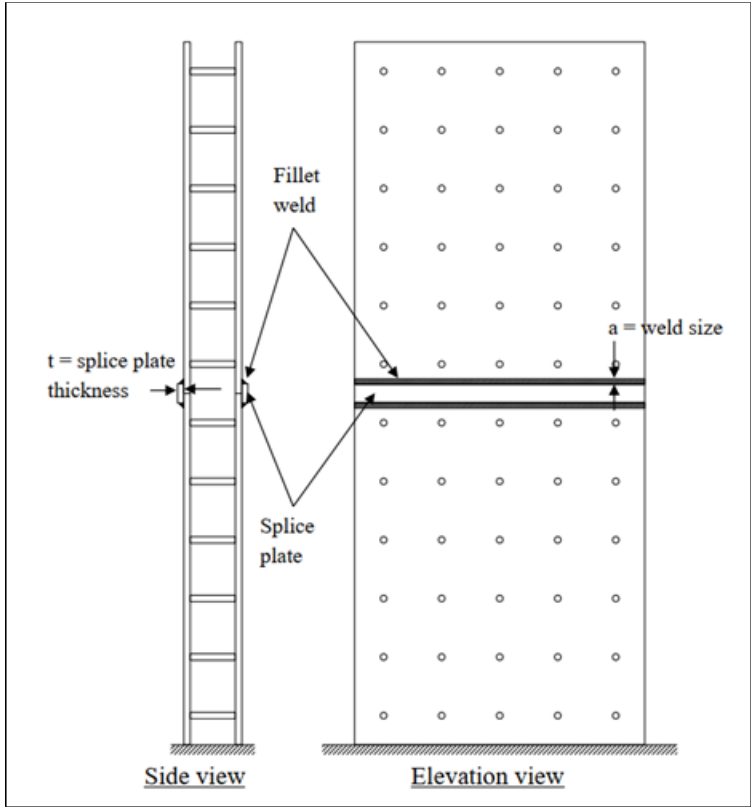

Figure 16: Splice Plate Fillet Welded to Wall Panels (Pankow 2014)

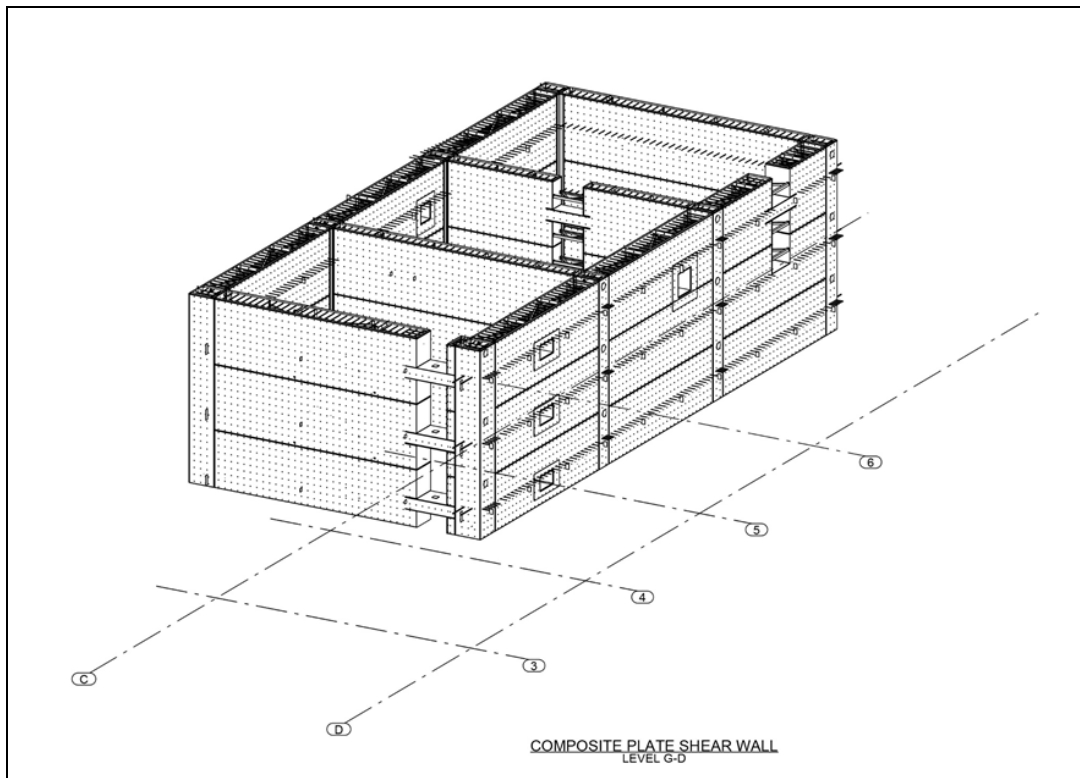

Figure 17: Isometric View of Rainier Square Core Structure

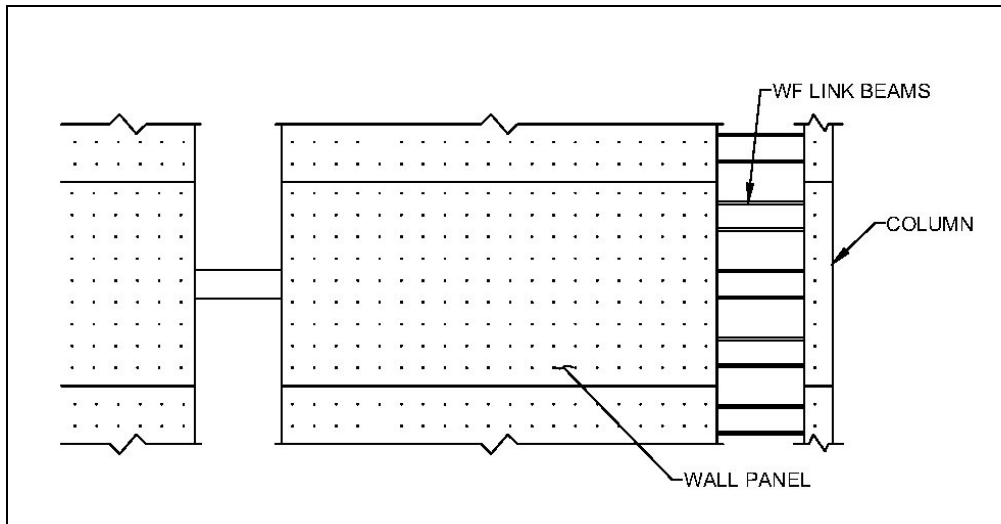

Figure 18: Wall Module to Column Module Connection with Wide Flange Link beam

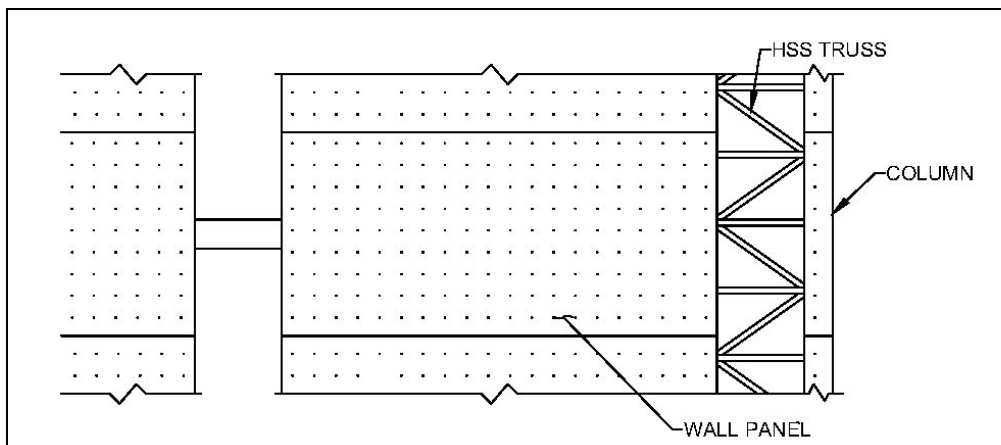

Figure 19: Wall Module to Column Module Connection with Continuous Boundary Truss

## **5. Erection Considerations**

### **5.1. Overview**

Erecting of the SpeedCore panels is something that requires close coordination between the Erector and Fabricator. Fabricators and Erectors were able to discuss some key erection considerations at the small group discussions.

### **5.2. Erection Aids**

The use of erection aids will greatly increase erection speed of SpeedCore panels. Some of the ideas discussed at the Summit are highlighted in this Section.

#### **5.2.1. Rainier Square Solution**

For the Rainier Square Project, a mechanical erection connection scheme was utilized to optimize module placement. Some key features of the setup are:

- Panels are baffled, trapezoidal in plan
- Swing in positioning only one-way
- (4) pre-installed (welded) bolts on corner columns are aligned with panel oversized holes, tightened - move on to the next panel

This system has shown to be effective and has allowed for very efficient panel placement.

#### **5.2.2. Panel Internal Bracing (Figure 20-21)**

The use of bracing internal to individual panels is critical for handling of modules in the shop and in the field. This is especially true when long (upwards of 30 ft) and wide (potentially 10' or wider) panels using relatively thin steel plate are commonly used.

As an example of internal bracing, the Rainier Square Project used internal trusses between the outside plates on the SpeedCore modules to aid in the handling of the modules. Photos showing the assembly of a module using these stabilizing trusses are shown in Figure 20 and Figure 21. As can be seen, these trusses are built-up from simple angle pieces provide much needed stability for handling the modules.

#### **5.2.3. Guide Plates (Figure 22-25)**

As was discussed at the summit, the use of some sort of guide plates can assist with fit-up of SpeedCore panels in the field. One concept shown was like that in Figure 22, Figure 23 and Figure 24. These guide plates could be tailor-made for the project and it would be preference of the Erector on how they would like to utilize them. One type of guide plate would be a bent plate like that shown in Figure 25. These plates could be placed intermittently or continuously along the panel edges to assist in placement of the modules.

#### **5.2.4. Lifting Attachments (Figure 26)**

Careful consideration should be made when specifying lifting points. The lifting points should be placed to minimize overall distortion of the panels and allow for quick placement of the panels. One such lifting attachment used on the Rainier Square Project is shown in Figure 26. The driver for using this type of lifting attachment was to accommodate width restrictions when shipping modules to site, but it also allowed for moving modules with minimal instability of the module itself.





Figure 20: Panel Stabilizing Frames Being Fitup on SpeedCore Wall Module



Figure 21: Fully Assembled Wall Module Showing Installed Stabilizing Frames

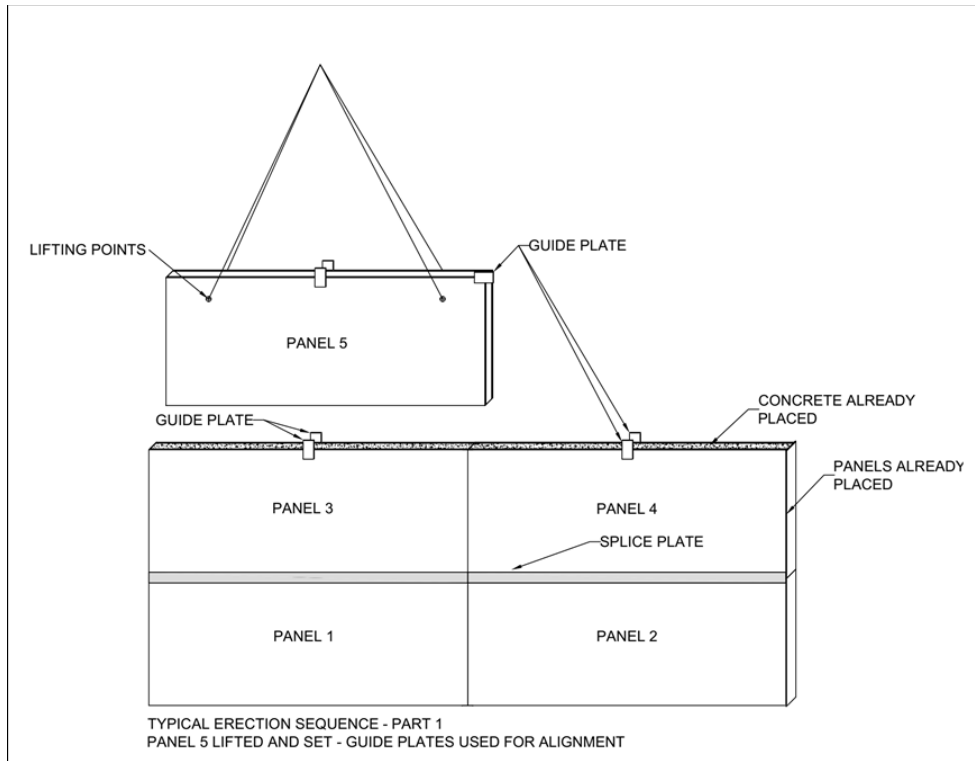

Figure 22: Typical Erection Sequence for Setting Wall Panel Modules - Part 1

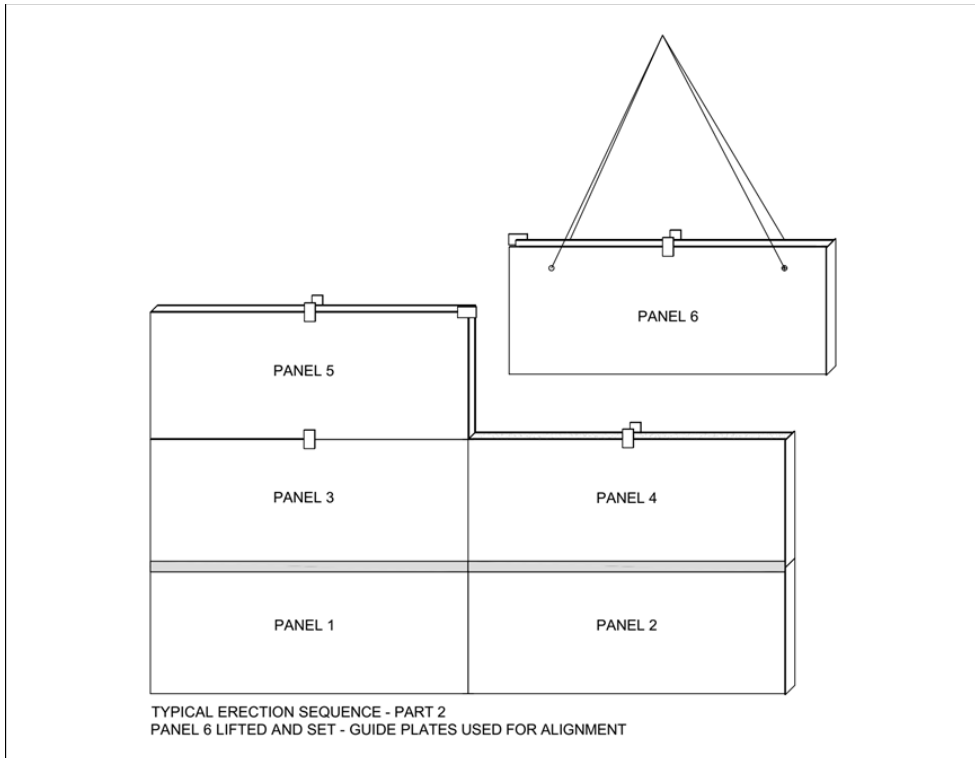

Figure 23: Typical Erection Sequence for Setting Wall Panel Modules - Part 2

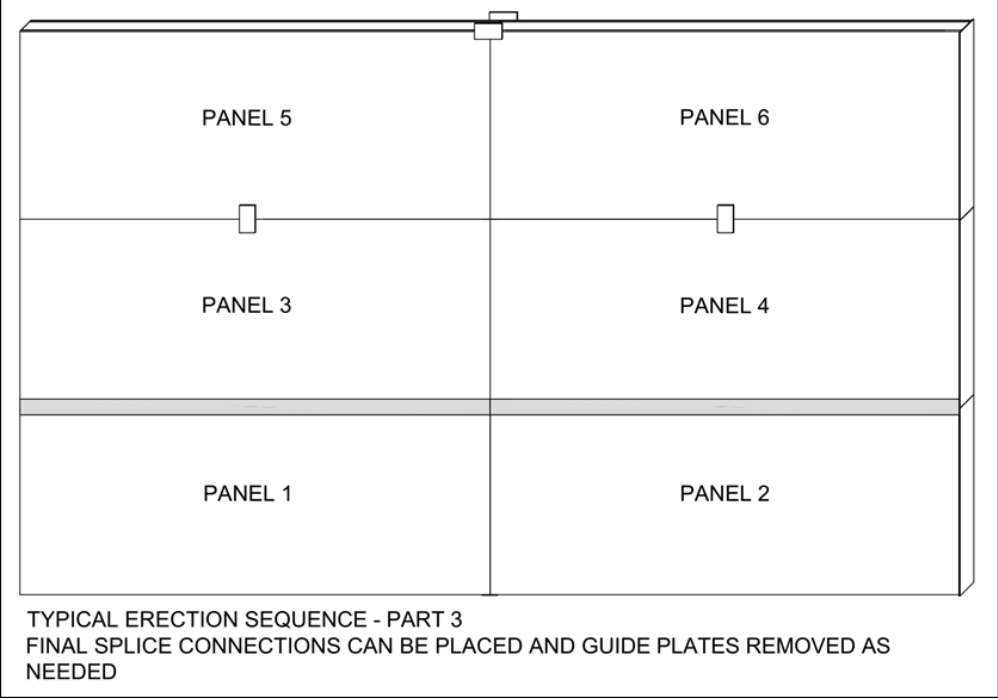

Figure 24: Typical Erection Sequence for Setting Wall Panel Modules - Part 3

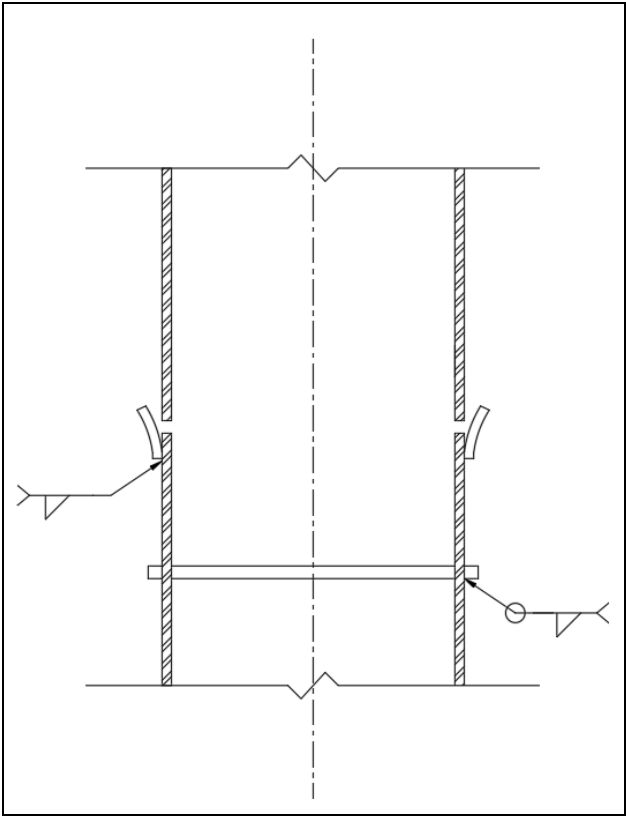

Figure 25: Bent Plates Used for Guiding Panels into Place



Figure 26: (a) Lifting Attachment on Rainier Square Panel and (b) Rotating a Panel Using the Attachment in the Shop

## **6. Plate Utilization and Availability**

### **6.1. Overview**

The steel plates used in SpeedCore Panels become a critical cost driver in choosing to use the system. There is the raw material cost, shipping cost and cost associated with having to handle the plate in the shop and the field that could determine what is ultimately specified.

### **6.2. Plate Geometric Constraints and Preferences**

One critical item relating to the steel plate used in SpeedCore is what is the optimal geometric sizes of plate to specify and use. As was previously discussed, it is recommended to keep thicknesses of the plate itself in a reasonable range to allow for ease of handling and installing the modules. Most commonly, this would encompass plate thicknesses in the range of  $\frac{3}{8}$ " to  $\frac{5}{8}$ " thicknesses.

Summit participants generally felt that using narrower width plate compared to the 14 ft wide plate, oriented vertically in place, (ultimately cut to 13'9") used at Rainier Square. Widths in the 7-8 ft range were preferred for the following reasons:

- (1) It is readily available in the US
- (2) Shipping and transport to site is much more straightforward than using wider plate
- (3) Handling of modules in field would be easier

### **6.3. Plate Material Properties**

The plates used in SpeedCore are not required to be exotic grades or specialty items. Standard A36 or A572 Grade 50 steel is sufficient when using the system. Since the strength of the plate rarely governs the design of SpeedCore, there is little advantage to using higher strength steels. Currently, the decision as to what grade of steel to use will likely be more influenced by availability than technical requirements.

### **6.4. Supplier Perspective**

A representative from the steel mills was in attendance at the Summit. In general, they indicated that from a supplier standpoint, they felt fairly removed from the design conversation. They also felt that if suppliers are kept engaged and involved at the industry level, they can be better receptive to market needs. One key takeaway is if SpeedCore gets wider spread implementation, producers will be much more receptive to ensuring availability of commonly used grades and sizes of material.

## **7. Fire Resistance – Opportunities for Fire Engineering**

### **7.1. Overview**

Another key consideration when specifying SpeedCore is the fire resistance of the system and what sort of additional fire protection may be required when using the system. There was limited discussion in the small groups about fire resistance of SpeedCore and much of the research to better understand elevated temperature behavior is ongoing currently. However, there are some important takeaways from the use of similar composite wall systems in the nuclear industry and what was applied at Rainier Square regarding elevated temperature behavior that are highlighted herein.

### **7.2. Current Practice and Understanding**

#### **7.2.1. Nuclear Application**

The current understanding of elevated temperature behavior of composite steel-plate and concrete wall systems stems from their use in nuclear facilities as containment internal structures. When used in nuclear applications, these steel-plate composite (SC) systems are often quite thick overall (36 inches plus) and their application is slightly different than the SpeedCore system. However, they share similar behavior as SpeedCore in many respects and fire resistance is one such area.

Based on research on SC systems subjected to elevated temperature, their unprotected behavior under elevated temperatures has been observed to be quite good. The faceplate exposed to the elevated temperatures will lose some strength and stiffness, but the bulk of the concrete and opposite faceplate maintain good strength and stiffness (AISC DG 32, 2017). If required by the governing authority, the SC systems can have spray-on fire protection (SFRM) applied to enhance their behavior in fire events.

#### **7.2.2. Commercial Application**

In transitioning application of SC systems from the nuclear industry to commercial high-rise construction, it is important to realize that SpeedCore panels behave similarly in fire as their nuclear counterparts. The Rainier Square Project in Seattle, as it is the first application of SpeedCore in a high-rise building, utilized spray-on fire protection on the exterior walls of the SpeedCore panels. Original requirements were for protection on both the inside and outside faces, but the city of Seattle approved an exception for the building to only apply on external facing faceplates - this resulted in large savings in cost and time for the project.

### **7.3. Ongoing Research for Fire Engineering**

It is important to note that the application of SFRM for the Rainier Square building is likely conservative based on what we know about how these types of systems perform in actual fire events. It is believed that through application of performance-based design that it is possible to greatly reduce additional passive fire protection requirements. As such, research is ongoing to examine the actual behavior of SpeedCore panels subjected to elevated temperature and to aid in developing performance-based design recommendations.

### **7.4. Accounting for Fire Protection**

While likely not directly affecting fabricators or erectors, having to apply passive fire protection is of interest to the General Contractor and Owner as it will impact overall construction time and cost of the overall project. Until research can be completed with regards to fire behavior of SpeedCore, it is safe to assume that SFRM would likely be required on at least external face of faceplates.

## 8. Marketing Approach

### 8.1. Overview

The goal of the marketing discussion is to consider different target audiences, what they want to and need to hear, how they perceive the SpeedCore system, and some marketing initiatives to support the technological advances occurring in practice and academic settings.

### 8.2. Key Items to Consider for SpeedCore

Several key items were brought forth at the Summit that AISC felt need to be highlighted and documented. These are noted below:

- Developing a suite of non-seismic details for the system is critical for market growth
  - We have attempted to partially address this in this Summary but realize there is a lot of work left to go
- Messaging has to overcome the “*later in the ground but finished faster*” hurdle
  - This has always been our stance, but we need to be consistent and steady in conveying this message
- SidePlate-like business model may add more capital behind promoting and optimizing the system for commercial use
  - This is noted, but AISC must be careful that we do not end up with a patented system that could limit innovations within the system itself.
- Fabricators need to be better equipped to bid the system
  - We hope this summit has laid the foundation for this, but we will continue to develop materials and keep sharing information as we receive it and publish new materials for fabricators and erectors to share internally and with their clients

### 8.3. Market Benefits to Emphasize for SpeedCore by Stakeholder Type

#### 8.3.1. Owner

- Fast
- High quality
- **Non-Seismic Question:** What is the construction cost increase over cast-in-place concrete?
- Good ROI
  - Explore this concept further

#### 8.3.2. GC

- Steel more adaptable in the field than concrete
  - No x-raying walls to locate rebar - all internal workings are obvious from the exterior
- No concrete to steel interface challenges
  - Embed misplacement avoided
- Steel team takes responsibility for schedule
- Increased worker safety
  - No overhead formwork and platform work
- Negligible creep in a steel core

### **8.3.3. Fabricator**

- No concrete to steel interface challenges
  - Embed misplacement avoided
- Steel team takes responsibility for schedule
- Increased worker safety
  - No overhead formwork and platform work

### **8.3.4. Erector**

- No concrete to steel interface challenges
  - Embed misplacement avoided
- Steel team takes responsibility for schedule
- Increased worker safety
  - No overhead formwork and platform work
- Internal core framing easier - can be pre-installed
  - Elevator divider beams
  - Hoist beams
  - Stair framing
- Negligible creep in a steel core

### **8.3.5. Engineer**

- Steel more adaptable in the field than concrete
  - No x-raying walls to locate rebar - all internal workings are obvious from the exterior
- No concrete to steel interface challenges
  - Embed misplacement avoided
- Steel team takes responsibility for schedule
- Negligible creep in a steel core

### **8.3.6. Architect**

- Steel more adaptable in the field than concrete
  - No x-raying walls to locate rebar - all internal workings are obvious from the exterior
- No concrete to steel interface challenges
  - Embed misplacement avoided
- Steel team takes responsibility for schedule

## **8.4. Market Challenges (Real and Perceived) by Stakeholder Type**

### **8.4.1. Owner**

- Need to overcome 30% increase (Seismic) in construction cost discussion

### **8.4.2. GC**

- Self-performing concrete GC
- Lack of education/no early system adoption
- Steel team takes responsibility for schedule
- Longer design time necessary for a significant gain in field time



### **8.4.3. Trade Unions**

- Opposing trade unions may be influential in persuading against SpeedCore

### **8.4.4. Fabricator**

- Steel team takes responsibility for schedule

### **8.4.5. Erector**

- Steel team takes responsibility for schedule

### **8.4.6. Engineer**

- Steel team takes responsibility for schedule
- Longer design time necessary for a significant gain in field time

### **8.4.7. Architect**

- Steel team takes responsibility for schedule
- Address details of wall finishing
- Longer design time necessary for a significant gain in field time

## **8.5. Marketing Initiatives to Consider**

- Target audience specific brochure (one-page max)
  - Fabricator/erector audience for internal use
  - GC procurement audience for fabricators/AISC to share with GCs
  - AEC audience schedule/cost comparison analysis
  - AISC/Specialists
- Construction/developer team marketing/education approach
  - Persuade an entire team (not just individual influencers) to approach a SpeedCore project together
  - Work through member fabricators who have developed strong relationships with repetitive client teams
    - Fabricator → Developer + GC
  - GC's and developers are always challenging to target. This may be a way around that challenge.
- Regional fabricator association education initiative
- Tours
  - Project site
  - Research lab
- AISC partner with fabricators one-on-one
  - Educate target audiences directly
  - Support project development by attending meetings
- Webinars
  - AISC authored fabricator SpeedCore webinar
  - AISC authored GC SpeedCore webinar - fabricator could offer this as a client value add and perform follow-up discussions with/without additional AISC support
- NASCC
  - SpeedCore team panel discussion (scheduled)

## **9. Miscellaneous Topics**

Some topics don't fit neatly into a category. The relevant but uncategorized discussion will be detailed here.

### **9.1. Differential settlement**

The question was raised about how to address the differential settlement that occurs with a heavy central core and lighter surrounding gravity system. This is a site by site consideration and would need to be addressed based on local ground conditions.

### **9.2. Technical resources - Design Guide**

Some key points, brought up by summit participants, and believed to be critical in any sort of Design Guide document include:

- Consistent, simple, reproducible details
- The approach must remove any technical knowledge barrier preventing the system from becoming commonplace
- Note: A Design Guide is forthcoming for the SpeedCore system - Date anticipated is December 2020

### **9.3. Rolled steel connection to the wall panel**

As discussed, gravity framing is attached to panels via simple shear tabs. Participants wondered how embedded steel within the panels are physically installed into the panels. Reference can be made to Section 5.2.1 which details how internal trusses were installed into the panels and also the Supreme Group Presentation (Attachment F). These photos and description in the presentation demonstrate how internal steel can be installed within the panels.

## 10. General Questions and Answers from Summit

Several very good questions came up at the summit. We noted these and have provided formal replies below.

**(1) RE: Oversized holes and plate washers used at splices and other connections**

**Question:** Can oversized holes + plate washers be used?

**Answer:** It is possible to use this configuration, but a focus on dimensional control must be maintained. Out-of-verticality tolerances need to be monitored closely for the system and erection aids should be considered to meet these tolerances.

**(2) RE: columns at corners of C-Shaped Walls**

**Question:** Are column components resisting torsion in addition to axial load?

**Answer:** This would depend on what was framing into them as it related to the floor framing, outriggers, etc. It would need to be verified by the Engineer of Record at the various locations of concerns.

**(3) RE: Welded Splice Fillet Fields Used in Connection Like What is Shown in Figure 16.**

**Question:** Can this be reduced down to stitch fillet welding?

**Answer:** Yes, a stitch weld may be possible, as long as it satisfies design criteria noted above

**(4) RE: Crane location and Attachment**

**Question:** Is there any advantage to be realized with crane location and/or crane attachment when using SpeedCore?

**Answer:** This becomes an Erector specific preference on how they may wish to climb the crane as they travel vertically up the building. It is possible to directly mount a crane off of already assembled modules, but this would need to be determined early in the Project such that proper allowances could be made in the design considerations of the modules.

**(5) RE: Heaviest Lifts to Consider During Erection?**

**Question:** What is the heaviest lift?

**Answer:** At the base of Rainier Square where up to 1" thick plate thickness, the heaviest lift was around 20 tons. Pick weight will depend on the plate thickness used and overall dimensions of the module. The weight of a 30'x14' panel using ½" plate would be approximately 10.5 tons. This would be fairly representative of a typical panel at Rainier Square.

**(6) RE: Temporary Steel Bracing to Aid Erection**

**Question:** How are the temporary steel bracing working to aid erection? Any lessons learned?

**Answer:** The most prominent type of stabilizing steel used in the Rainier Square Project is the use of internal trusses between the outside plates on the SpeedCore modules. Photos showing the assembly of a module using these stabilizing trusses are shown in Figure 20 and Figure 21.

**(7) RE: High Strength Plate Material for SpeedCore**

**Question:** Is there an advantage to higher strength plate (50 ksi used at Rainier Square)?

**Answer:** Not specifically. The perceived technical advantage would be you could potentially use less steel if the strength of the plate is governing design. However, this is rarely the case and as such, higher strength steel likely provides minimal, if any, economic advantage. The 50 ksi plate used at Rainier Square was available at the widths required and as such was specified accordingly. There would be nothing precluding use of A36 plate if it has more availability in a certain region of the country.

**(8) RE: Plate Thickness**

**Question:** Does thickening the plate allow for decreased tie spacing?

**Answer:** Yes, but there are other factors that influence tie spacing as was shown in Section 2. It becomes a bit of an iterative effort to find the ideal spacing and diameter of ties. It would come down to fabricator preference as to whether they would prefer to use thinner plate with tighter tie spacing or thicker (heavier) plate with reduced tie spacing.

## **11. Conclusion and Closing Remarks**

As was stated at the beginning of the Summit and this Summary:

*Our goal with this Summit and subsequent discussions is to get more practicable information out into the market for better understanding, increased comfort, accurate bidding, and SpeedCore market growth. We want to discuss the industry's reaction to the system, what information is missing from your point of view, and develop content to bring to the market this year.*

We endeavored throughout the summit and in preparing this Summary to meet these goals and hope that you, as those who ultimately build the system, have found some valuable information to take away.

Lastly, this Summit was intended to only be the beginning and we hope to continue to advance the SpeedCore system through ongoing research, collaboration with our members, and, most of all, by using it in actual steel structures for many years to come.

## 12. References

### 12.1. Referred to in Summary

Bhardwaj, S., and Varma, A.H. (2016). *AISC Design Guide 32: Design of Modular Steel Plate Composite (SC) Walls for Safety Related Nuclear Facilities*. AISC, Chicago, IL.

Shafaei, S., Wang, A., Varma, A.H., and Morgen, B. (2018). "Stability of Steel Modules During Construction." *Proceedings of the Annual Stability Conference*, Baltimore, MD, April 10-13, 2018.

Zhang, K., Varma, A.H., Malushte, S., and Gallocher, S. (2014). "Effects of Shear Connectors on the Local Buckling and Composite Action in Steel Concrete Composite Walls." *Nuclear Engineering and Design*, Special Issue on SMiRT-21 Conference, Vol. 269, pp. 231-239, Elsevier Science, <http://dx.doi.org/10.1016/j.nucengdes.2013.08.035>

### 12.2. Other Relevant References

Alzeni, Y., Bruneau, M., (2017). "In-Plane Cyclic Testing of Concrete Filled Sandwich Steel Panel Walls with and without Boundary Elements", *ASCE Journal of Structural Engineering*, Vol.143, No.9, DOI: 10.1061/(ASCE)ST.1943-541X.0001791

Bhardwaj, S., Wang, A.Y., and Varma, A.H. (2018). "Slenderness Requirements for CF-CPSW: The Effects of Concrete Casting." *Proceedings of the Eighth International Conference on Thin-Walled Structures*, ICTWS 2018, Lisbon, Portugal, July 24-27. ISBN: 978-989-20-8665-1

Broberg, M., Shafaei, S., Seo, J. Varma, A.H. (2019). "Introduction to the Seismic Behavior of Coupled Composite Plate Shear Wall – Concrete Filled." *Engineering Journal*, AISC, In Preparation

Bruneau, M., and Kenarangi, H. (2018). "Investigation of Cyclic Shear Behavior of Circular Reinforced Concrete Filled Steel Tubes." *Journal of Structural Engineering*, Under Review.

Bruneau, M., and Varma, A.H. (2019). "Shear Strength of Filled Composite Members." *Engineering Journal*, AISC, In Preparation.

Bruneau, M., Kizilarlan, E., Kenarangi, H. (2019) "Cyclic Behavior of C-Shaped Composite Plate Shear Walls – Concrete Filled." *Journal of Structural Engineering*, ASCE, In Preparation

Booth, P., Varma, A.H., and Seo, J. (2015). "Lateral Load Capacity of Steel Plate Composite Wall Structures." *Transactions of SMiRT 23 in Manchester, UK*, Paper ID 791, IASMiRT, North Carolina State University, Raleigh, NC, pp. 1-10, [http://smirt23.uk/attachments/SMiRT-23\\_Paper\\_791.pdf](http://smirt23.uk/attachments/SMiRT-23_Paper_791.pdf)

Kizilarlan, E., Seo, J., Broberg, M., Shafaei, S., Varma, A.H., Bruneau., M., (2018). "R-Factors for Coupled Composite Plate Shear Walls—Concrete Filled (Coupled-C-PSW/CF), Interim Project Report #2, Submitted to the Charles Pankow Foundation for CPF research grant #06-16.

Kizilarlan, E., Seo, J., Broberg, M., Shafaei, S., Varma, A.H., Bruneau., M., (2019). "Seismic Design Coefficients and Factors for Coupled Composite Plate Shear Walls—Concrete Filled (Coupled-C-PSW/CF), to be published.

Kurt, E.G., Varma, A.H., Booth, P.N., and Whittaker, A., (2016). "In-plane Behavior and Design of Rectangular SC Wall Piers Without Boundary Elements." *ASCE Journal of Structural Engineering*, Vol. 142, No. 6, [http://dx.doi.org/10.1061/\(ASCE\)ST.1943-541X.0001481](http://dx.doi.org/10.1061/(ASCE)ST.1943-541X.0001481)

Lehman, D., Roeder, C., Heid, A., Maki, T., and Khalegi, B., (2018). "Shear Response of Concrete Filled Tubes. Part 1: Experiments." *Journal of Constructional Steel Research*, Volume 150, November 2018, Pages 528-540, <https://doi.org/10.1016/j.jcsr.2018.08.027>

Nie, J.-G., Hu, H.-S., and Eatherton, M. R. (2014). "Concrete filled steel plate composite coupling beams: Experimental study." *Journal of Constructional Steel Research*, Elsevier, 94 49-63.

Seo, J., Varma, A.H., Sener, K., and Ayhan, D. (2016). "Steel-Plate Composite (SC) Walls: In-Plane Shear Behavior, Database, and Design." *Journal of Constructional Steel Research*, Elsevier Science, Volume 119, Pages 202-215, <http://dx.doi.org/10.1016/j.jcsr.2015.12.013>

Shafaei, S., Seo, J., and Varma, A.H. (2019). "Cyclic Behavior of Planar Composite Plate Shear Walls – Concrete Filled." *Journal of Structural Engineering*, ASCE, In Preparation.

Varma, A.H., Malushte, S., Sener, K., and Lai, Z., (2014). "Steel-Plate Composite (SC) Walls for Safety Related Nuclear Facilities: Design for In-Plane Force and Out-of-Plane Moments." *Nuclear Engineering and Design*, Special Issue on SMiRT-21 Conference, Vol. 269, pp. 240-249, Elsevier Science, <http://dx.doi.org/10.1016/j.nucengdes.2013.09.019>

Wallace, J. et al. (2019). *R-Factor for Coupled Concrete Core Wall System*. Report to the Charles Pankow Foundation.

Zhang, K., Varma, A.H. and Seo, J. (2019). "Steel-Plate Composite (SC) Walls: Behavior and Design and Behavior for Axial Compressive Loading." *Journal of Structural Engineering*, ASCE, submitted for review.

**ATTACHMENT A - SPEEDCORE SUMMIT ATTENDEE LIST**

<b>Company</b>	<b>Contact</b>	<b>Email</b>	<b>Field</b>
Purdue	Amit Varma	ahvarma@purdue.edu	Academic
W&W	Bill Lindley	blindley@wwsteel.com	Fabricator
SteelFab	Bill Pulyer	wpulyer@steelfab-inc.com	Fabricator
Peterson Beckner	Bob Beckner	bbeckner@pbisteel.com	Erector/GC
MKA	Brian Morgen	bmorgen@mka.com	Designer
AISC	Brian Ward	ward@aisc.org	AISC
Bosworth Erectors	Carl Williams	cwilliams@bosworthsteel.com	Erector
W&W Erection	Charles Dougherty	cdougherty@wwsteel.com	Erector
Peterson Beckner	Conrad Hernandez	chernandez@pbisteel.com	Erector/GC
Peterson Beckner	Craig Peterson	cpeterson@pbisteel.com	Erector/GC
Williams Erection Company	Dana Whitlow	dwhitlow@weoga.com	Erector
Peterson Beckner	Dave Atkins	datkins@pbisteel.com	Erector
Supreme Group	Dave Senio	Dave.Senio@supremegroup.com	Fabricator
SteelFab	David Garrett	dgarrett@steelfab-inc.com	Fabricator
Berlin	David Hunt	dhunt@berlinsteel.com	Fabricator
AISC	Devin Huber	huber@aisc.org	AISC
Midwest Steel	Duane Hartley	dhartley@midweststeel.com	Erector
Cives	Greg Orff	gorff@cives.com	Fabricator
Peterson Beckner	James Byrum	JByrum@pbisteel.com	Erector/GC
Prospect	Jay Ruby	jayru@lexicon-inc.com	Fabricator
Owen	Jeff Pate	jeff.pate@owensteel.com	Fabricator
Schuff Steel Company	Jeff Perrotti	jeff.perrotti@schuff.com	Fabricator
AISC	Jennie Traut-Todaro	trauttodaro@aisc.org	AISC
Bosworth Erectors	John Bosworth	jmbosworth@bosworthsteel.com	Erector
AISC	Larry Kruth	kruth@aisc.org	AISC
Peterson Beckner	Larry Peterson	lpeterson@pbisteel.com	Erector/GC
L & M Industrial Fabrication ()	Matt Smith	smithm@lmsteelfab.com	Fabricator
Bosworth Erectors	Nyckey Heath	nheath@bosworthsteel.com	Erector
Lindapter	Patrick Harris	pharris@lindapter.com	Supplier
Nucor	Pavan Gadicherla	pavan.gadicherla@nucor.com	Supplier
Banker	Ron Meng	rmeng@bankersteel.com	Fabricator
Drake-Williams Steel	Scott Van Deren	svanderen@dwsteel.com	Fabricator
Prospect	Steve Grandfield	steveg@lexicon-inc.com	Fabricator
Schuff Steel Company	Steve Meyers	steve.meyers@schuff.com	Fabricator
AISC	Tom Schlafly	schlafly@aisc.org	AISC
Bosworth Erectors	Vincent Bosworth	vbosworth@bosworthsteel.com	Erector

## **AISC SpeedCore Summit**

March 20, 2019

Hyatt Regency DFW - Room Enterprise 1  
2334 North International Parkway, DFW Airport, TX

<b>9:30 a.m.</b>	<b>Morning Refreshments</b> <ul style="list-style-type: none"><li>• Coffee/Tea/Snack</li><li>• Mixed table seating</li></ul>	
<b>10:00 a.m.</b>	<b>Welcome and Introductions - Intent of Meeting</b> <ul style="list-style-type: none"><li>• Summit goals</li><li>• Participant introductions</li><li>• Discussion expectations</li></ul>	<b>Singer</b>
<b>10:25 a.m.</b>	<b>Current Research Outcomes</b> <ul style="list-style-type: none"><li>• Presentation</li><li>• Large group Q&amp;A</li></ul>	<b>Varma</b>
<b>10:40 a.m.</b>	<b>Rainier Square - The Demonstration Project</b> <ul style="list-style-type: none"><li>• Presentation</li><li>• Large group Q&amp;A</li></ul>	<b>Morgen</b>
<b>10:55 a.m.</b>	<b>Potential Details Non-Seismic Areas</b> <ul style="list-style-type: none"><li>• Non-seismic design considerations</li><li>• High-level details for panels, splices, etc.</li></ul>	<b>Varma/Huber</b>
<b>11:10 a.m.</b>	<b>Small Group Discussion - What's important to you?</b> <ul style="list-style-type: none"><li>• Continue discussion in small group</li><li>• Scribe document key topics for further development</li></ul>	<b>All</b>
<b>11:40 am</b>	<b>Large Group Reporting</b> <ul style="list-style-type: none"><li>• Report key topics</li></ul>	<b>All</b>
<b>12:00 p.m.</b>	<b>Lunch</b>	<b>All</b>
<b>1:00 p.m.</b>	<b>Small Group Discussions</b> <ul style="list-style-type: none"><li>• Assigned topic problem-solving groups</li><li>• Scribe document key takeaways</li></ul>	<b>All</b>



<b>2:00 p.m.</b>	<b>Afternoon Refreshments</b> <ul style="list-style-type: none"><li>● Coffee/Tea/Snack</li></ul>	<b>All</b>
<b>2:15 p.m.</b>	<b>Small Group Discussion, cont.</b>	<b>All</b>
<b>2:45 p.m.</b>	<b>Small Group Summary Discussions</b> <ul style="list-style-type: none"><li>● Review notes and summarize<ul style="list-style-type: none"><li>○ Key takeaways</li><li>○ Action items for industry</li></ul></li></ul>	<b>All</b>
<b>3:00 p.m.</b>	<b>Large Group Summary Report &amp; Discussion</b> <ul style="list-style-type: none"><li>● Report<ul style="list-style-type: none"><li>○ Key takeaways</li><li>○ Action items for industry</li></ul></li></ul>	<b>All</b>
<b>3:45 p.m.</b>	<b>Closing Remarks</b> <ul style="list-style-type: none"><li>● Thank you</li></ul>	<b>Huber/Traut-Todaro</b>

# SPEEDCORE: RESEARCH OUTCOMES

Summarized by,

Amit H. Varma

Kettelhut Professor of Structural Engineering



# RESEARCH PROJECT - 1

## Design Procedure for Dual-Plate Composite Shear Walls

<b>Research Purpose</b>		To address the need for a rapidly-constructable core-wall system that will avoid the use of time-consuming climbing forms and significantly shorten the time required to construct core walls in multi-story buildings.
<b>Grantee</b>		Purdue University
<b>Project Area</b>		Structural Engineering
<b>CPF Research Grant #</b>		06-06
<b>Award Amount</b>		\$338,000
<b>Grant Period</b>		Sep 2006 - Oct 2009
<b>Grant Status</b>		Complete
<b>Principal Investigator</b>		Professors Mike Kreger and Mark Bowman
<b>Industry Champions</b>		Ron Klemencic, President, MKA Associates



## RESEARCH OUTCOMES

- ◆ Behavior and capacity of empty steel modules to support construction loads and concrete casting pressure
- ◆ Structural behavior → stiffness and strength of composite plate shear wall (T-shaped) with bolted ties
- ◆ Experimental results, numerical models, design procedure
- ◆ Documents available from CPF website



# RESEARCH PROJECT - 2

## Seismic and Wind Behavior and Design of Coupled CF-CPSW Core Walls for Steel Buildings

---

**Research Purpose** | There is increasing interest in the use of coupled Concrete-Filled Composite Plate Shear Walls (CF-CPSW) core wall structures for the design of high-rise steel buildings, particularly to optimize their design for wind or seismic load combinations. AEC firms will be able to optimize the design of high-rise buildings in high wind or seismic zones using these coupled CF-CPSW core wall structures. They will be able to address the challenges associated with conventional concrete core wall structures by finding a solution in steel-concrete composite structures. Coupled CF-CPSW core wall structures leverage steel pre-fabrication in the shop, and stay-in-place formwork to reduce the time spent at the site and thus improve the construction schedule.

The proposed project will generate experimental data, numerical models, and lead to the development of design guidelines that will empower engineers to consider coupled CF-CPSW core wall structures to optimize the design and construction schedule of high-rise buildings, thus bringing economic opportunities to the AEC industry.

**Grantee** | Purdue University

**Project Area** | Structural Engineering

**CPF Research Grant #** | 06-16



# RESEARCH PROJECT - 2

<b>Grantee</b>		Purdue University
<b>Project Area</b>		Structural Engineering
<b>CPF Research Grant #</b>		06-16
<b>Award Amount</b>		\$600,000
<b>Grant Period</b>		Aug 2016 - Jul 2019
<b>Grant Status</b>		In Progress
<b>Principal Investigator</b>		Amit Varma, Co-PI - Michel Bruneau, University at Buffalo
<b>Industry Champions</b>		Ron Klemencic, Magnusson Klemencic Associates Jim Malley, Degenkolb Ron Hamburger, Simpson Gumpertz & Hager Charlie Carter, AISC Peter Timler, Supreme Group LP
<b>CPF Allies</b>		American Institute of Steel Construction (AISC)
<b>Research Deliverables</b>		Task 1 – Design of the Theme Structure Task 2 – Experimental Investigations Task 3 – Numerical Models Task 4 – Parametric Studies Task 5 – Development of Design Recommendations





## RESEARCH OUTCOMES

- ◆ Development of design guidelines for empty modules. Includes requirements for tie size and spacing.
- ◆ Development of design guidelines for plate slenderness. Includes requirements for shear stud / tie spacing to get non-slender plates
- ◆ Cyclic behavior of planar CPSW subjected to axial loading. Design guidelines for estimating stiffness, strength, and rotation capacity of planar walls.
- ◆ Effects of parameters such as tie spacing, plate slenderness, and axial load level



## RESEARCH OUTCOMES

- ◆ Calibrated numerical models (3D Finite Element Models) that can be used to calculate the behavior (stiffness, strength etc.) of CPSW
- ◆ Calibrated numerical models (fiber-based beam elements) that can be used to estimate the cyclic behavior (stiffness, strength, and deformation capacity) of CPSW
- ◆ Recommendations for developing such numerical models, pitfalls, shortcuts, limitations etc.





## RESEARCH OUTCOMES

- ◆ Cyclic behavior of C-shaped CPSW under axial loading. Design guidelines for estimating stiffness, strength, and deformation capacity of C-shaped walls part of cores
- ◆ Calibrated numerical models for estimating the cyclic behavior of C-shaped CPSW
- ◆ Recommendations for modeling



## RESEARCH OUTCOMES

- ◆ Currently designing the coupling beam-to-wall connection specimens and tests
  - ◆ Three connection types and details identified
  
- ◆ Also, designing some composite wall-to-concrete foundation specimens and tests
  - ◆ Three connection types and details identified
  
- ◆ Testing to include wind loading protocol



# EXPERIMENTAL RESULTS: SPECIMENS





# TEST SETUP

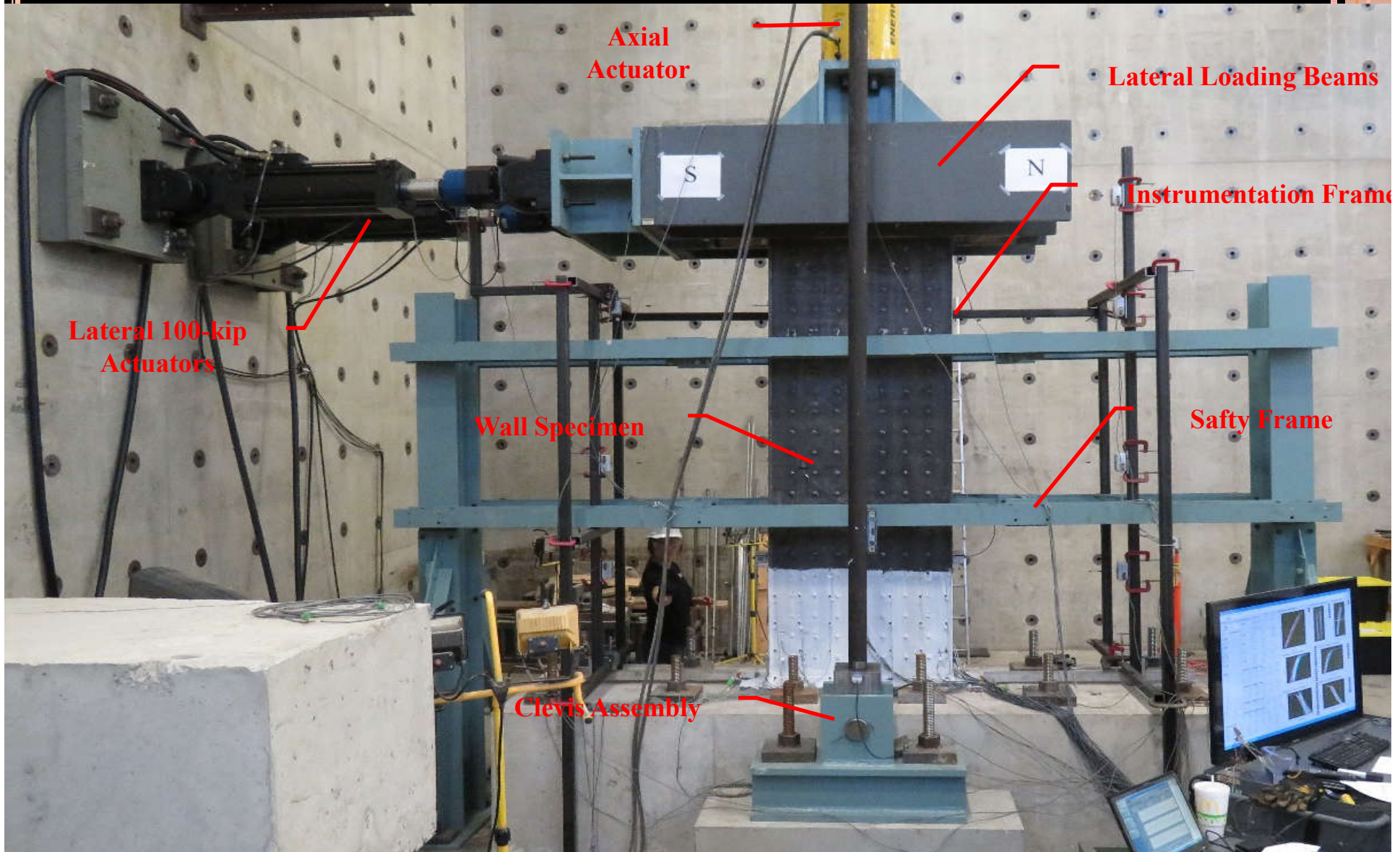

# EXPERIMENTAL RESULTS: LATERAL FORCE-DISPLACEMENT BEHAVIOR

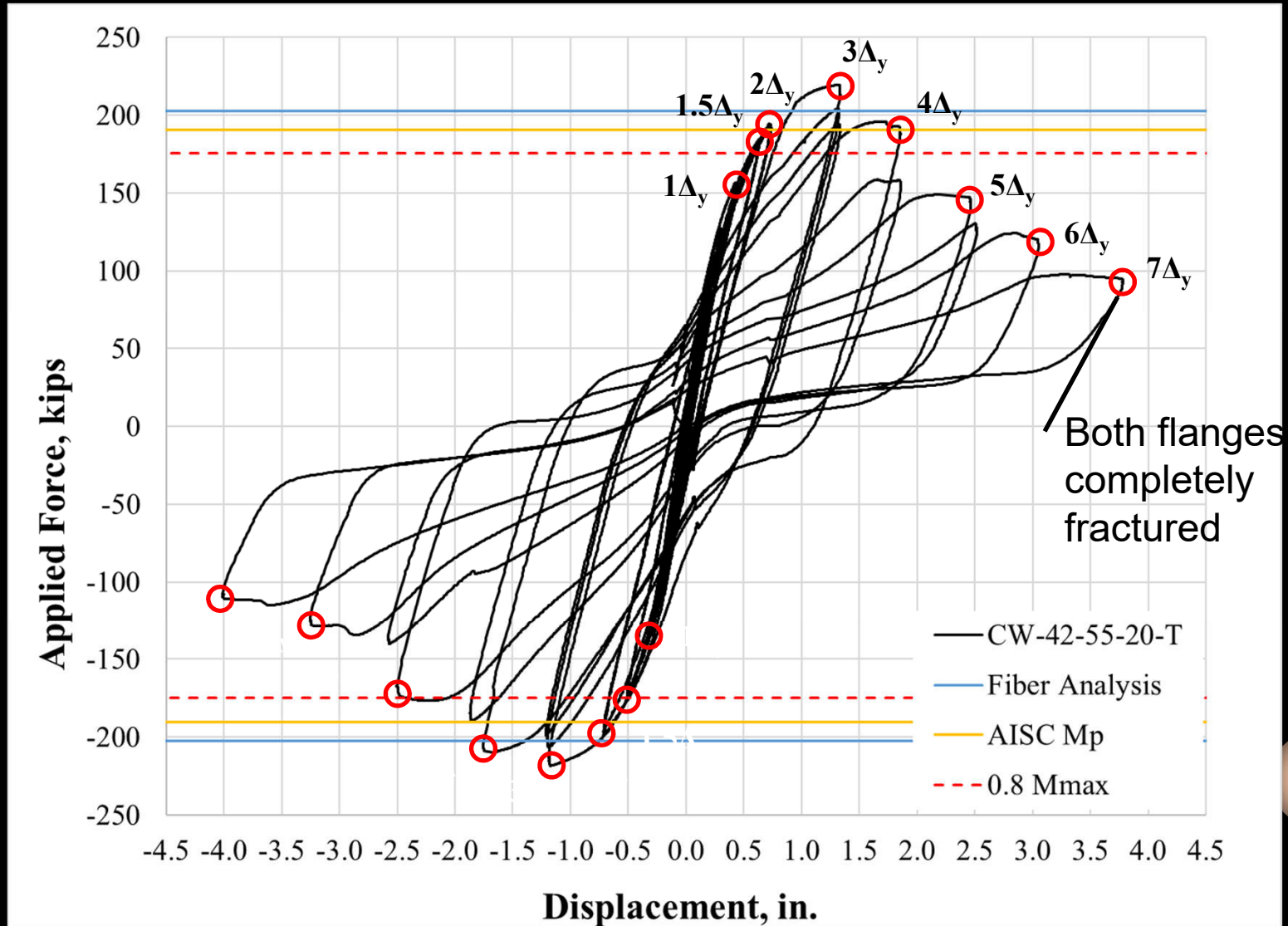

# EXPERIMENTAL RESULTS: EFFECTS OF AXIAL LOAD AND TIE SPACING

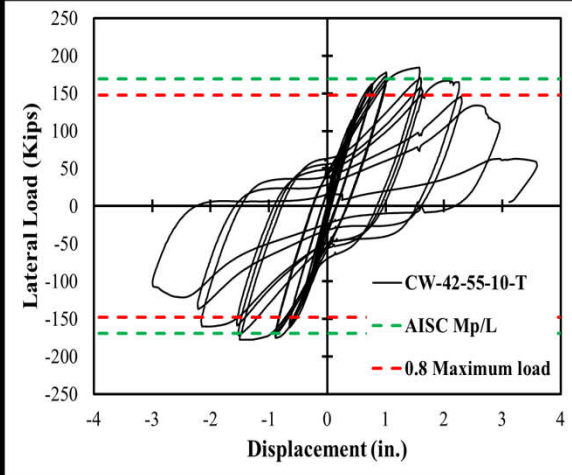

CW-42-55-10-T  
 $f'_c$ : 6508 psi  
 10% Axial Load: (211 kips)

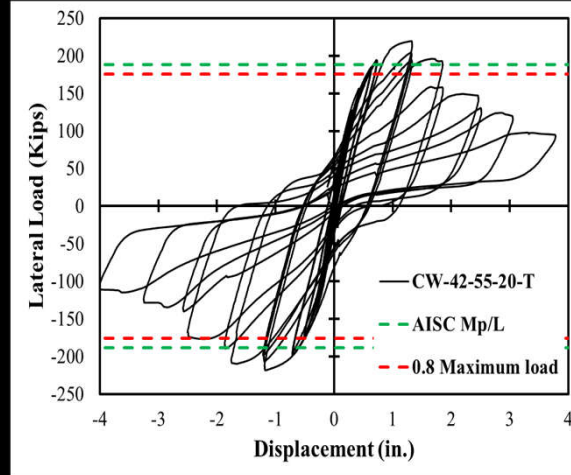

CW-42-55-20-T  
 $f'_c$ : 7789 psi  
 20% Axial Load: (505 kips)

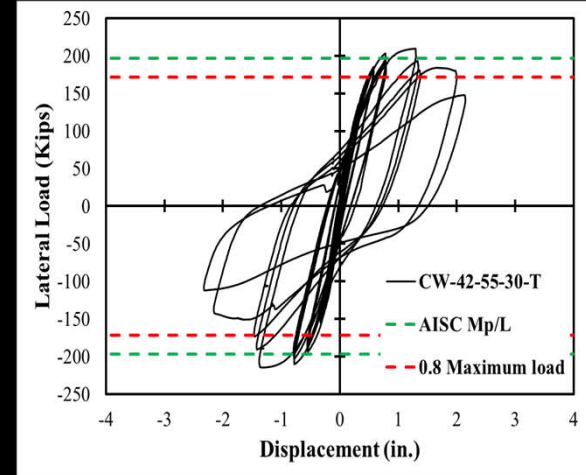

CW-42-55-30-T  
 $f'_c$ : 7386 psi  
 30% Axial Load: (718 kips)

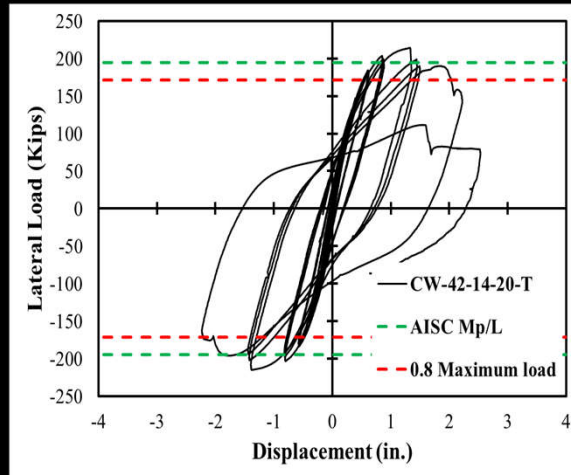

CW-42-14-20-T  
 $f'_c$ : 8741 psi  
 20% Axial Load: (566 kips)

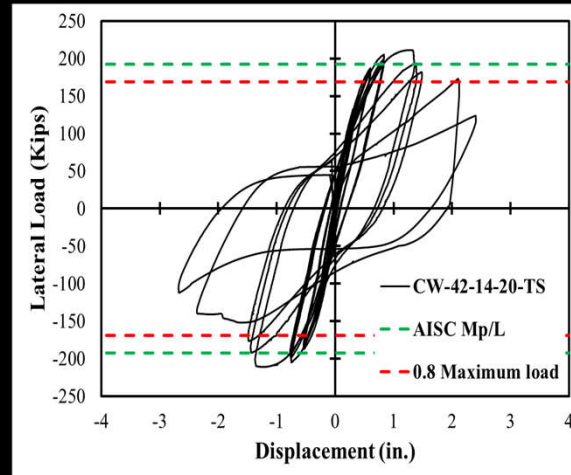

CW-42-14-20-TS  
 $f'_c$ : 8408 psi  
 20% Axial Load: (545 kips)





# EXPERIMENTAL RESULTS: EXTERNAL DAMAGE



# EXPERIMENTAL RESULTS: ROTATION CAPACITY

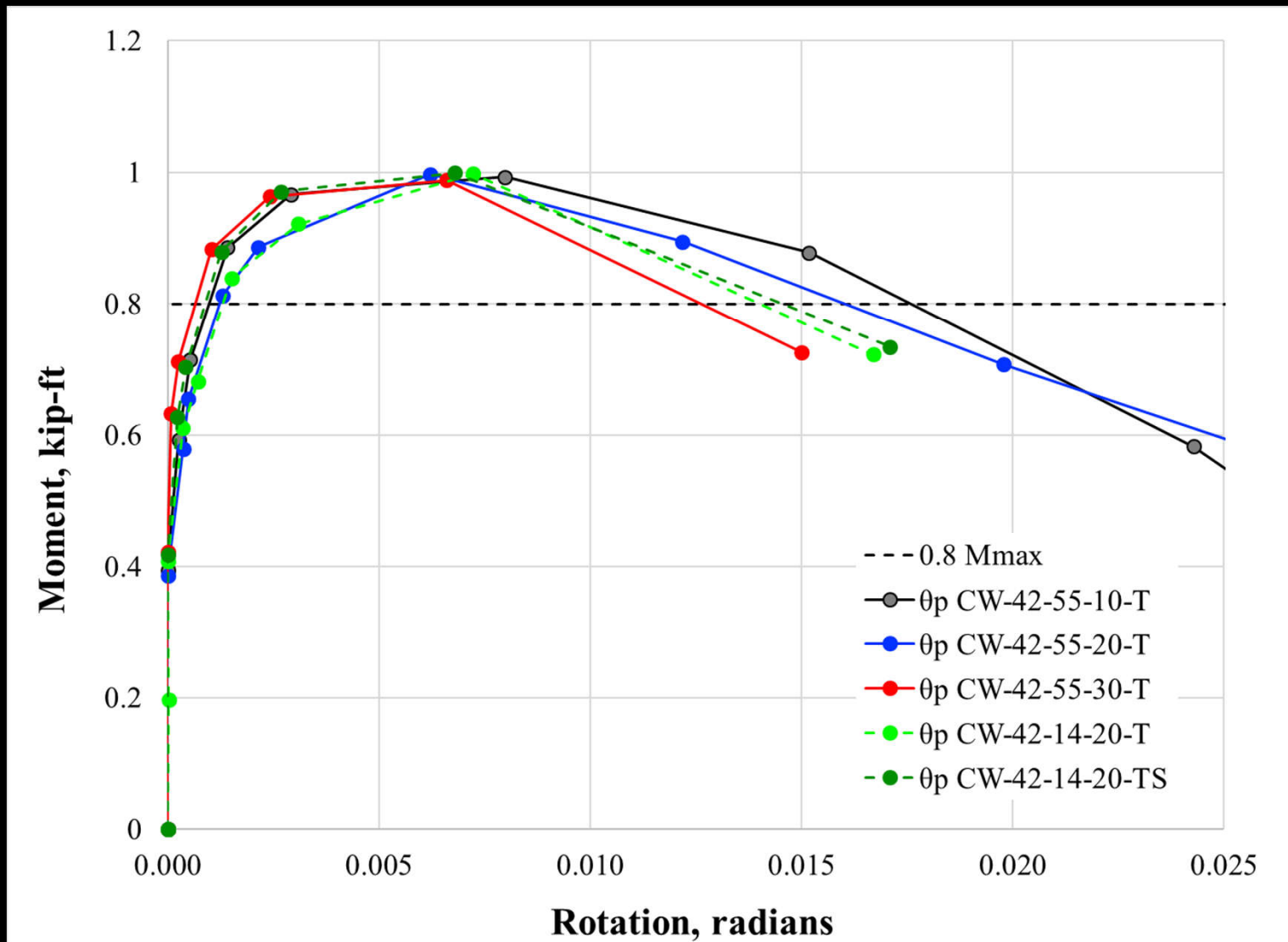



# NUMERICAL MODELS: 3D FEM MODELS AND RESULTS

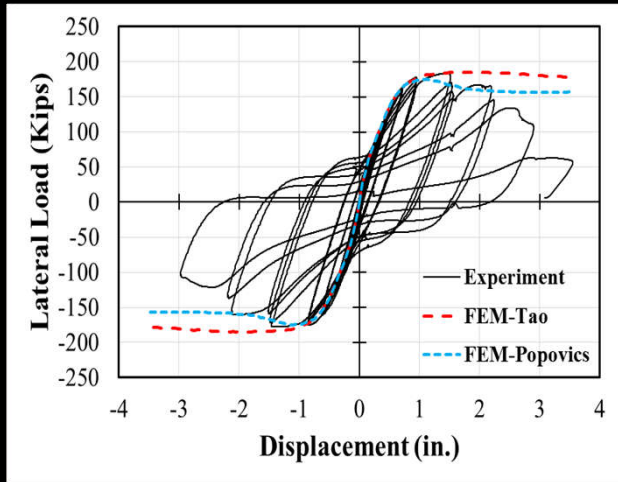

CW-42-55-10-T  
 $f'_c$ : 6508 psi  
 10% Axial Load: (211 kips)

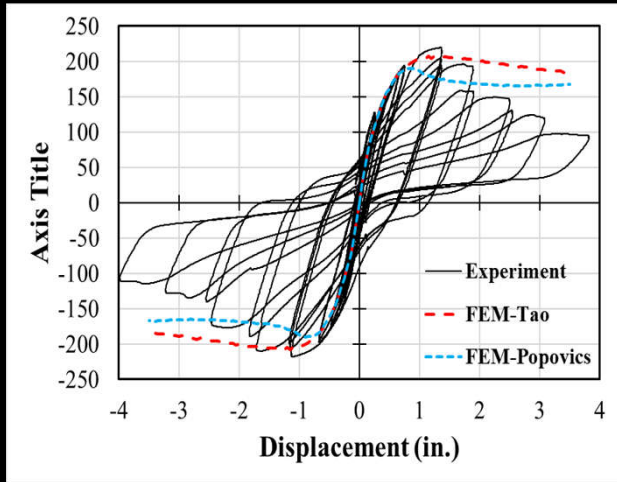

CW-42-55-20-T  
 $f'_c$ : 7789 psi  
 20% Axial Load: (505 kips)

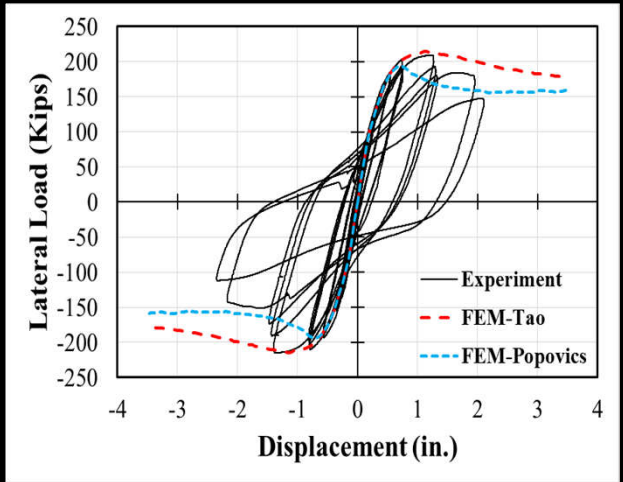

CW-42-55-30-T  
 $f'_c$ : 7386 psi  
 30% Axial Load: (718 kips)

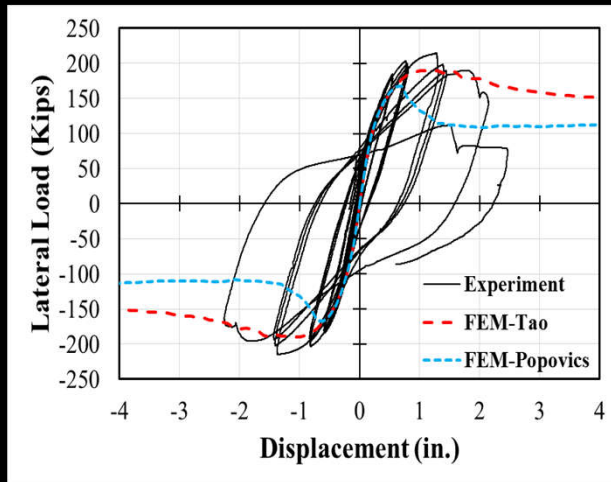

CW-42-14-20-T  
 $f'_c$ : 8741 psi  
 20% Axial Load: (566 kips)

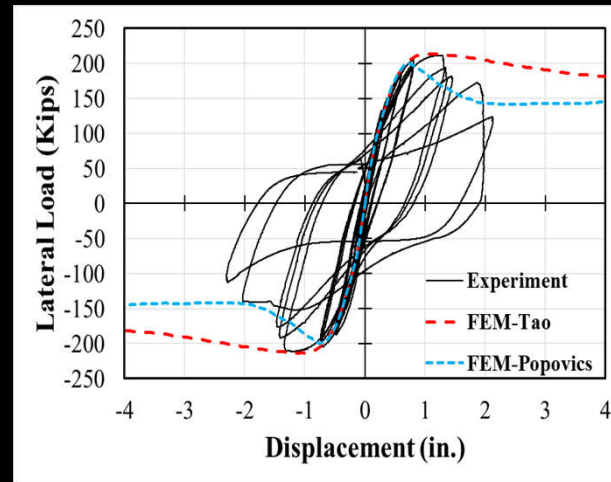

CW-42-14-20-TS  
 $f'_c$ : 8408 psi  
 20% Axial Load: (545 kips)



# NUMERICAL MODELS: CALIBRATED FIBER-BASED MODELS

Matching Exact Effective  
Stress-Strain from FEM

Simplified Effective Stress-  
Strain for Wall Models

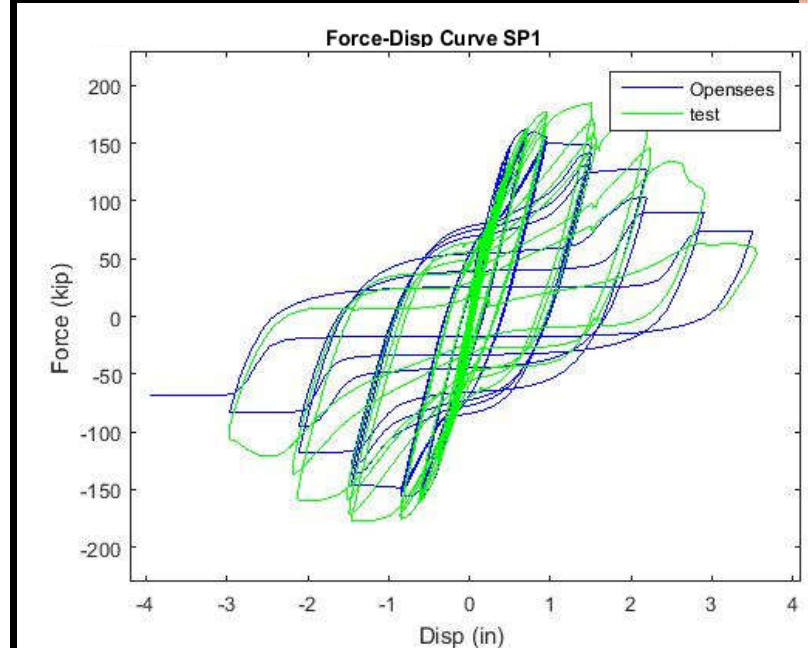
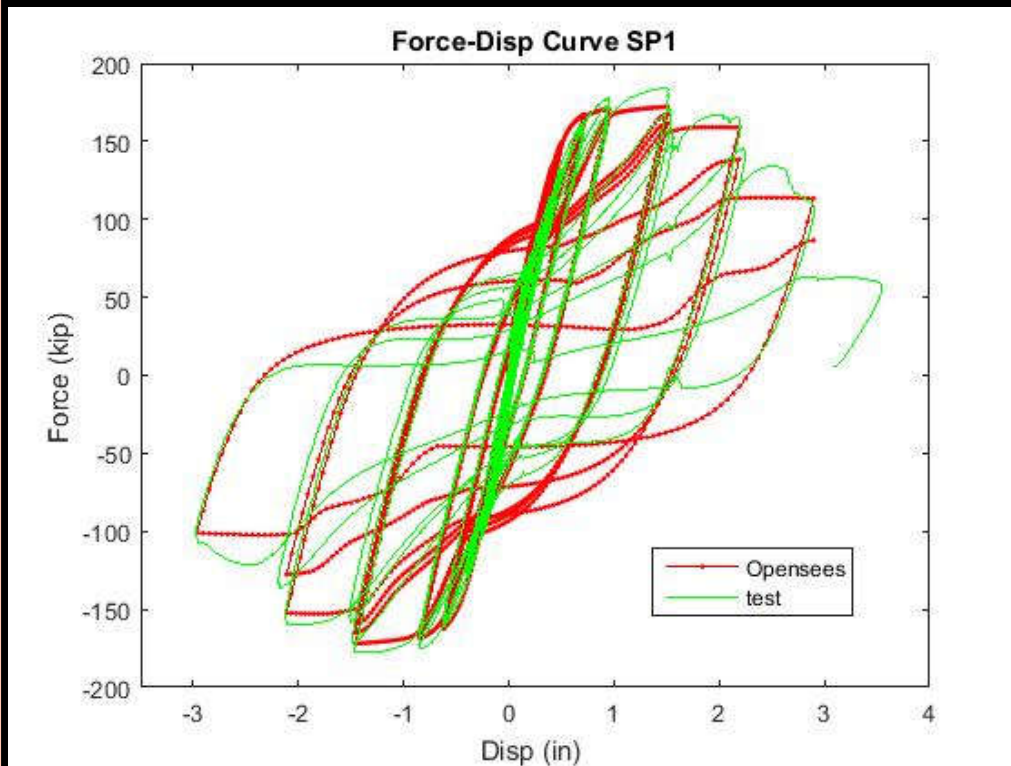

Material Model 1 – directly match ABAQUS

# RESEARCH PROJECT - 3

## R-Factors for Coupled Composite Plate Shear Walls–Concrete Filled (Coupled-C-PSW/CF)

**Research Purpose** | This project seeks R-Factors developed from FEMA P-695 studies for Coupled Composite Plate Shear Walls – Concrete Filled (Coupled-C-PSW/CF), for inclusion in ASCE-7, higher than R-factors for corresponding non-coupled walls. C-PSW/CFs is foreseen to become an efficient option for the lateral force resisting system of buildings when relatively large seismic demands lead to the design of concrete shear walls with dense reinforcement and large thickness, or steel plate shear walls with relatively thick web plates and large boundary elements. This system will be predominantly used in high-rise buildings having a core-wall system with coupled beams. Coupled systems are anticipated to be more ductile and have more redundancy, but ASCE currently does not assign them higher R-factors. This study uses the FEMA P-695 methodology to substantiate the R-factors for such Coupled-C-PSW/CF structures.

**Grantee** | University at Buffalo (SUNY)

**Project Area** | Structural Engineering

**CPF Research Grant #** | 05-17



# RESEARCH PROJECT - 3

<b>Grantee</b>		University at Buffalo (SUNY)
<b>Project Area</b>		Structural Engineering
<b>CPF Research Grant #</b>		05-17
<b>Award Amount</b>		\$165,805
<b>Grant Period</b>		Jan 2017 - Jun 2018
<b>Grant Status</b>		In Progress
<b>Principal Investigator</b>		Michel Bruneau; Co-PI Amit Varma, Purdue University
<b>Industry Champions</b>		John Hooper, Magnusson Klemencic Associates Jim Malley, Degenkolb Engineers Rafael Sabelli, Walter P. Moore & Associates Tom Sabol, Englekirk Institutional Larry Kruth, AISC Bonnie Manley, American Iron and Steel Institute
<b>CPF Allies</b>		American Institute of Steel Construction (AISC)
<b>Research Deliverables</b>		Interim Report Final Report





## RESEARCH OUTCOMES

- ◆ Developed extensive design criteria / code for the seismic design of coupled - composite plate shear walls (CCPSW)
- ◆ Includes requirements for composite walls, coupling beams, beam-to-wall connections, and wall-to-foundation connections
- ◆ Potential details for beam-to-wall connections and wall-to-foundation connections
- ◆ Archetype structure designs – 3, 8, 12, 18 and 22 story

## RESEARCH OUTCOMES

- ◆ Numerical models of different types for the designed systems, calibrated models using test data
- ◆ FEMA P695 studies completed using 22 ground motions for each structure. Thousands of incremental dynamic analyses
- ◆ R-factor of 8 for the system validated
- ◆ Overstrength factor of 2.5
- ◆ Displacement amplification factor of 5.5



# NUMERICAL ANALYSIS: TYPICAL PUSHOVER BEHAVIOR

**Point A** represents the lateral load level corresponding to the ELF distribution.

**Point B** represents where all of the coupling beams have developed flexural hinges. The composite walls are designed to have a flexural capacity adequate to resist this demand level.

**Point C** corresponds to the overall inelastic mechanism with flexural plastic hinging in all of the coupling beams and the base of the composite walls.

**point D** represents fracture failure of the composite walls.

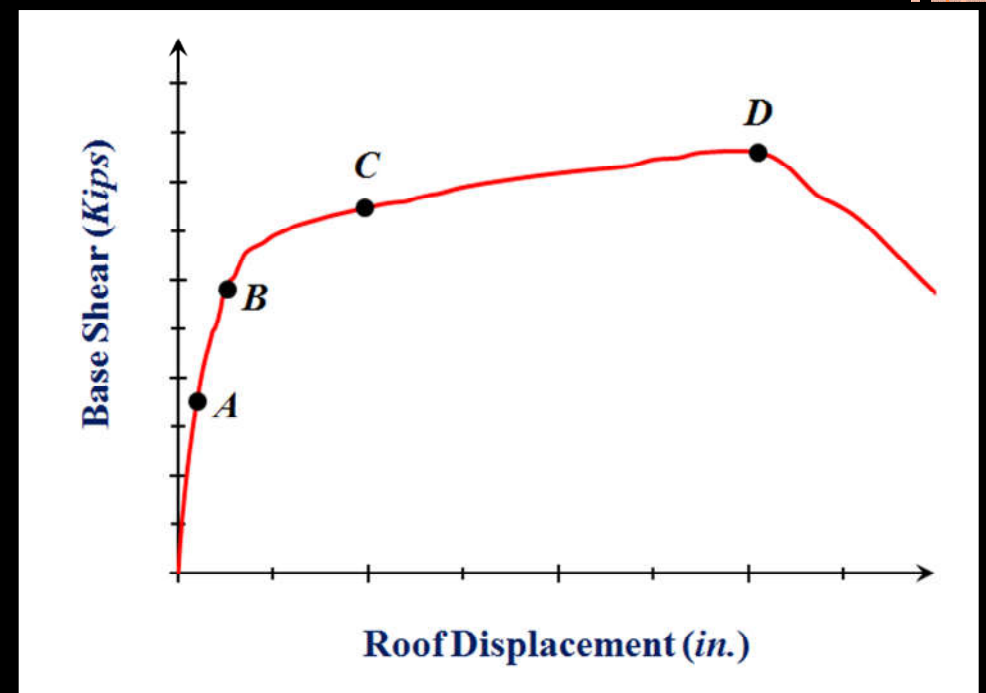

# NUMERICAL ANALYSIS: PUSHOVER BEHAVIOR

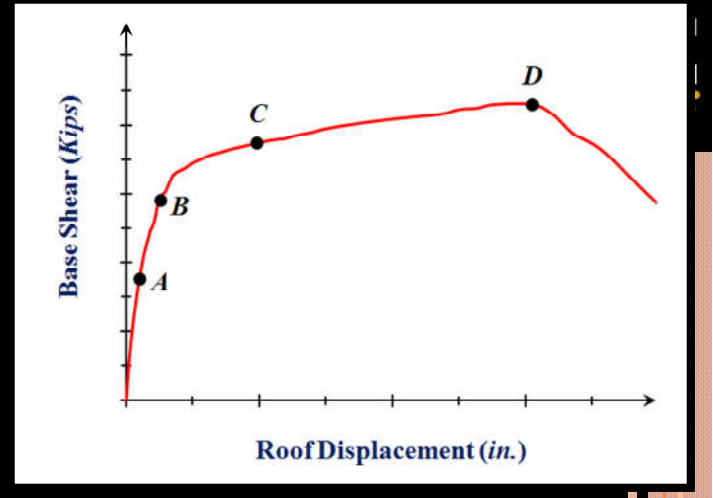

S, von Mises

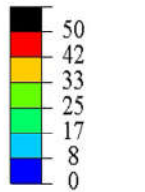

Fy= 50 ksi

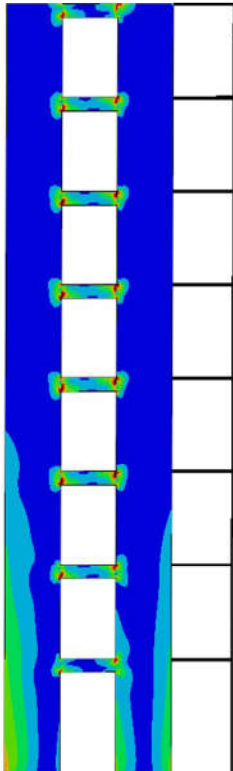

(Point A)

S, von Mises

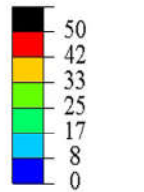

Fy= 50 ksi

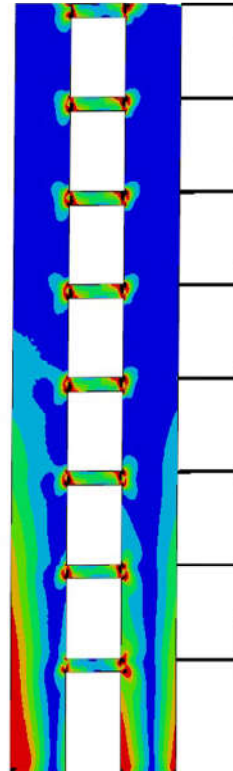

(Point B)

S, von Mises

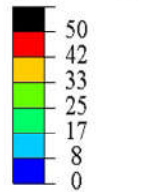

Fy= 50 ksi

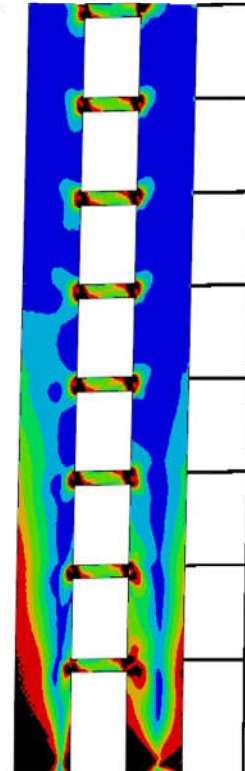

(Point C)

S, von Mises

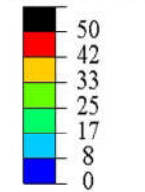

Fy= 50 ksi

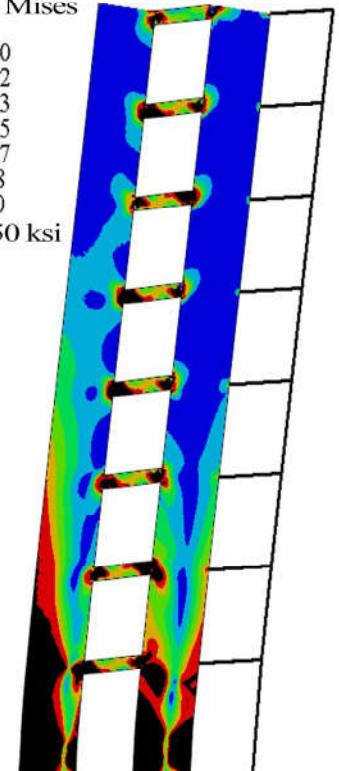

(Point D)



# NUMERICAL ANALYSIS: TIME HISTORY

**PG-1E-BICC090:**

**Response at scale factor = 7**

- 1- Yielding of CBs
- 2- Yielding of CF-CPSWs
- 3- Propagation of yielding of CB connections over CF-CPSW
- 4- Fracture initiation of CBs
- 5- Fracture initiation of CF-CPSWs
- 6- Total fracture of CBs
- 7- End of earthquake record

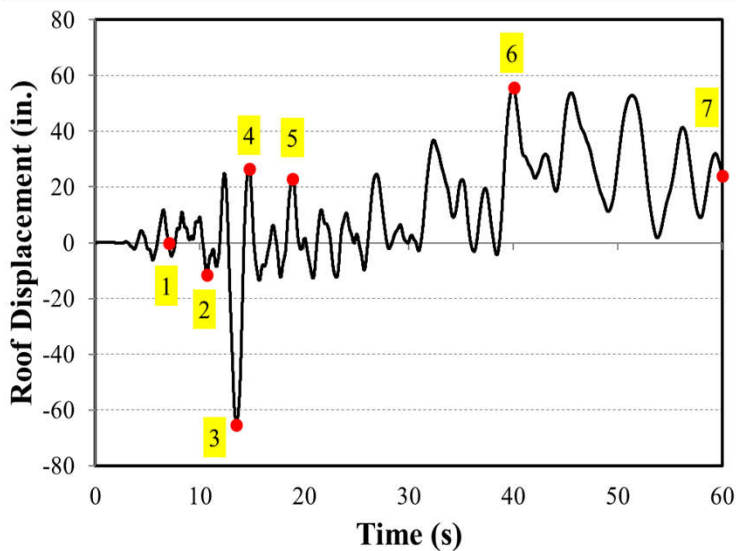

PEEQ  
Multiple section points  
(Avg: 75%)

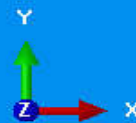
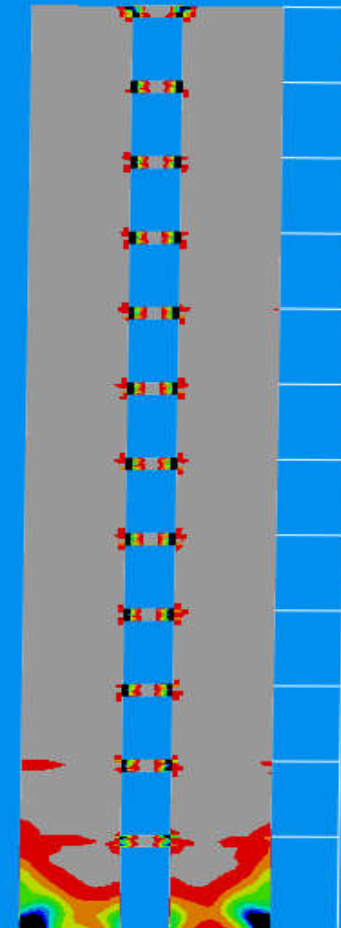
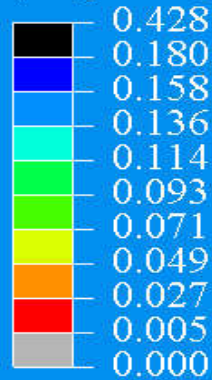

Step: Time-History  
Increment 3125194: Step Time = 60.00  
Primary Var: PEEQ  
Deformed Var: U Deformation Scale Factor: +1.000e+00

# RESEARCH PROJECT - 4

## Performance-Based Structural Fire Engineering of Buildings with Concrete-Filled Composite Plate Shear Walls (CF-CPSW)

**Research Purpose** | The overall goal is to develop research-based code change proposals for AISC Specification 360-XX (Appendix 4-Fire Design) to include structural performance-based design methodology and / or standard fire ratings for CF-CPSW walls and floor-to-wall connections while accounting for the effects of different material, geometric, loading, and fire (heating) scenarios.

**Grantee** | Purdue University

**Project Area** | Performance-Based Design

**CPF Research Grant #** | 03-18

**Award Amount** | \$160,000

**Grant Period** | Jul 2018 - Jan 2020

**Grant Status** | In Progress

**Principal Investigator** | Amit Varma, Professor, Purdue University



# RESEARCH PROJECT - 4

**Industry Champions** | Farid Alfawakhiri, American Iron and Steel Institute  
Larry Kruth, American Institute of Steel Construction  
Rob Chmielowski, Magnusson Klemencic and Associates  
Robert Berhinig, Consultant  
Kevin LaMalva, Simpson Gumpertz and Hager  
Lisa Choe, National Institute of Standards and Technology  
Ron Klemencic, Magnusson Klemencic and Associates  
Gary Higbee, Steel Institute of New York  
John Sui, City of Seattle

**CPF Allies** | American Institute of Steel Construction (AISC), Steel Institute of New York (SINY)

**Research Deliverables** | Task 1 – Testing Walls Under Fire Loading  
Task 2 – Testing Connections & Walls Under Fire Loading  
Task 3 – Numerical Modeling and Benchmarking  
Task 4 – Parametric Studies and Analysis  
Task 5 – Design Tools, Guidelines, and Final Report



## RESEARCH OUTCOMES

- ◆ Developed and calibrated numerical models (3D FEM) for calculating the thermal and structural behavior of CPSW subjected to fire loading and axial compression
- ◆ Special test setup for conducting fire tests in a structural laboratory. Parameters includes axial load level, plate slenderness, fire time-temperature curves, two sided and one sided heating
- ◆ Project ongoing – will develop recommendations for estimating fire resistance / rating of composite walls subjected to standard or realistic fire loadings





# EXPERIMENTAL INVESTIGATIONS TESTS READY

- ◆ Placing specimen in Test set-up



6/6/2019 Copyright, Amit H. Varma, Purdue Univ.



# EXPERIMENTAL INVESTIGATIONS: CHINA

◆ Instrumentation

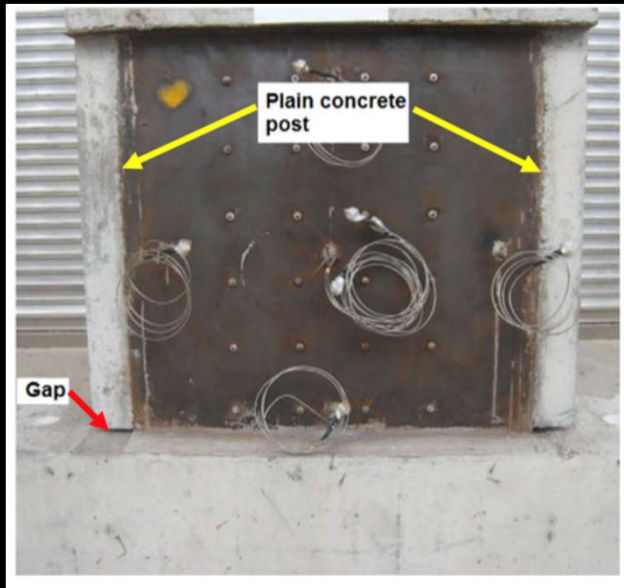

Plain concrete to protect the flanges

◆ Non-uniform fire tests' unexposed parts' protection



Brick wall on unexposed surface

6/6/2019 Copyright, Amit H. Varma, Purdue Univ.

Wei, Feng, Cheng Fang, and Bo Wu. "Fire resistance of concrete-filled steel plate composite (CFSPC) walls." *Fire Safety Journal* 88 (2017): 26-39.



# EXPERIMENTAL INVESTIGATIONS: CHINA

- ◆ Significant local buckling on plate surface
- ◆ Ties play an important role

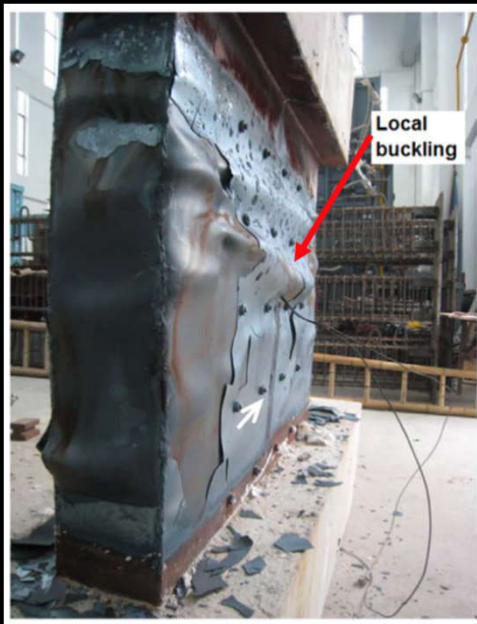

- ◆ Tie bars seemed to be more essential in constraining local buckling

Wei, Feng, Cheng Fang, and Bo Wu. "Fire resistance of concrete-filled steel plate composite (CFSPC) walls." *Fire Safety Journal* 88 (2017): 26-39.



# NUMERICAL ANALYSIS 3D FEM OF TESTS FROM CHINA

◆ Benchmarked models - Results

◆ SCW7

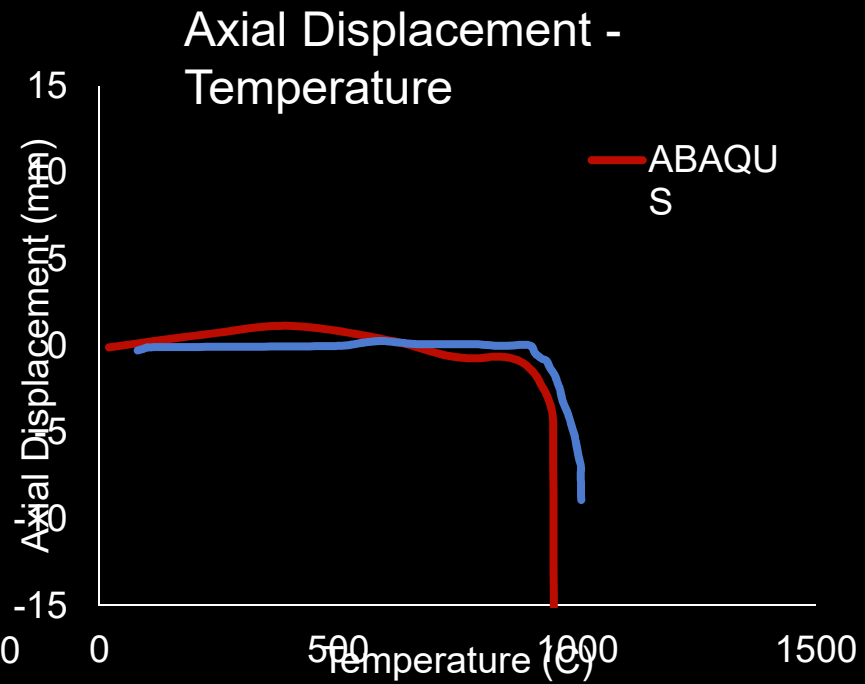
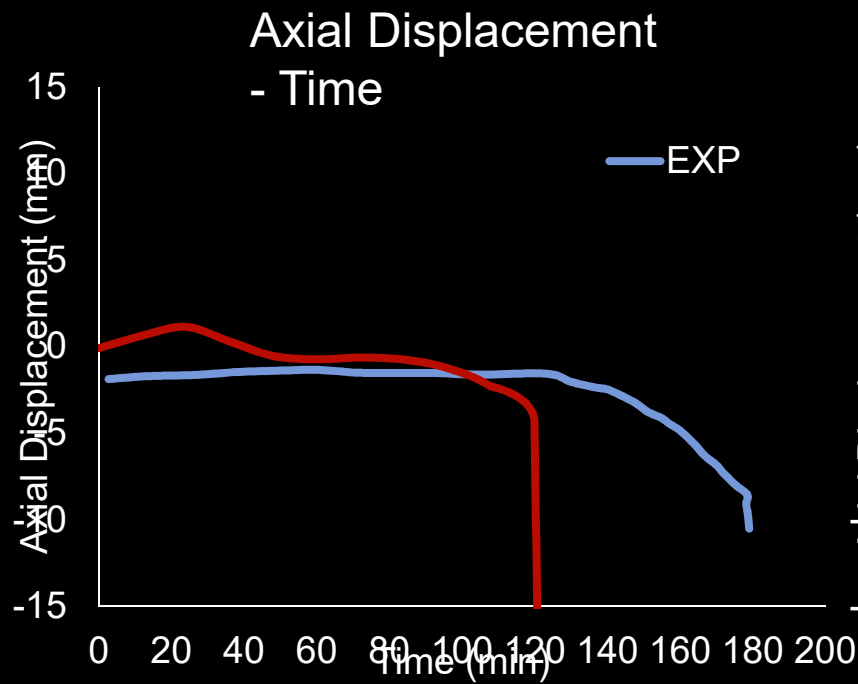

6/6/2019 Copyright, Amit H. Varma, Purdue Univ.





# NUMERICAL ANALYSES: BEHAVIOR MODELED

## ◆ CW6 - Results

Deformation  
(U2)

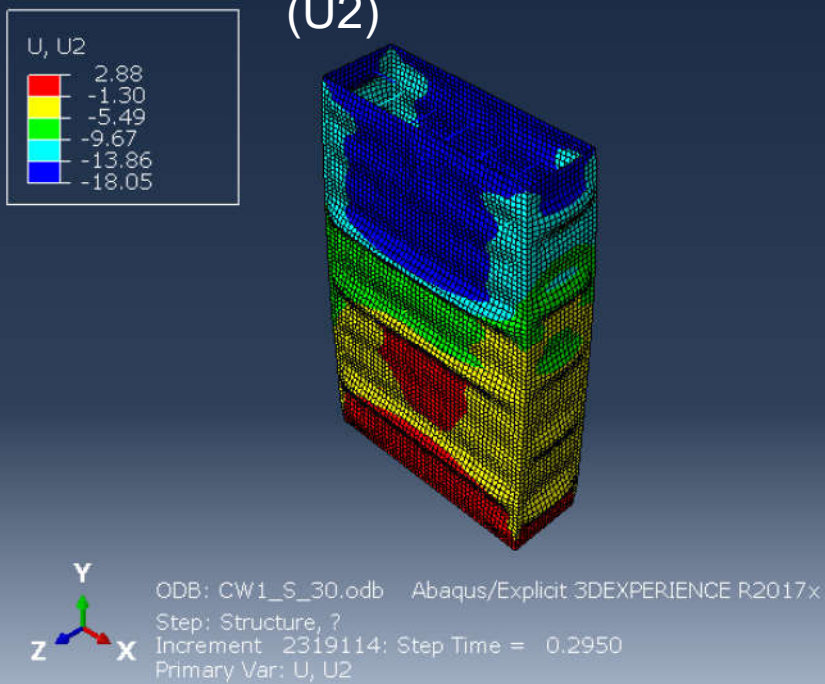

Steel plate buckling  
between tie bars

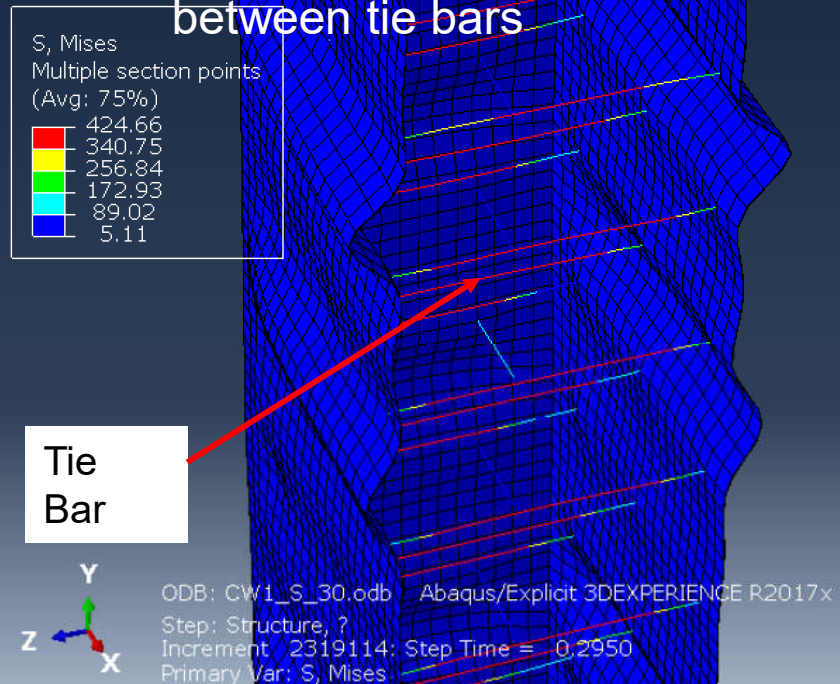

6/6/2019 Copyright, Amit H. Varma, Purdue Univ.



# NUMERICAL ANALYSIS: COMPARISON WITH EXPERIMENTAL RESULTS

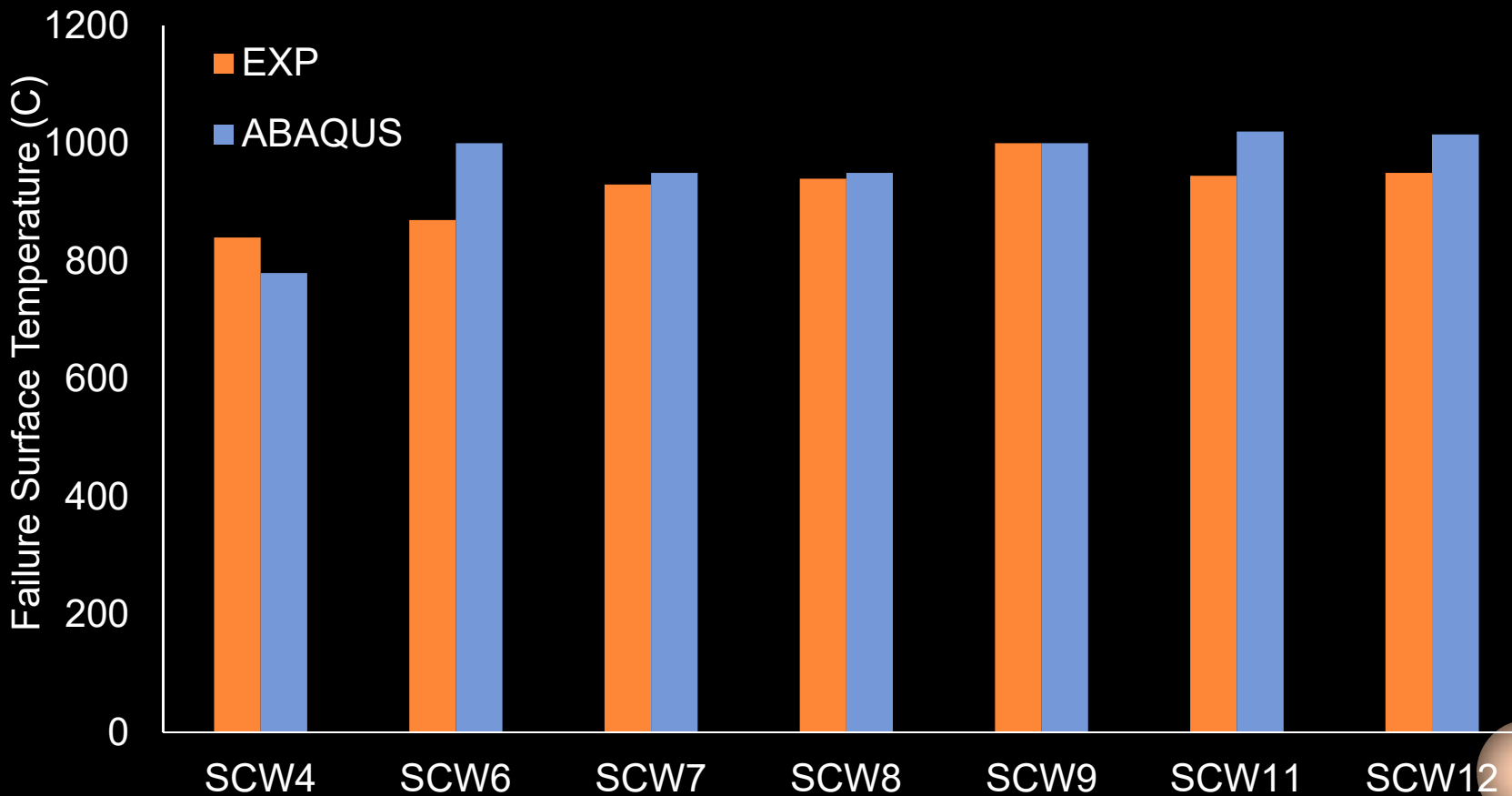

6/6/2019 Copyright, Amit H. Varma, Purdue Univ.

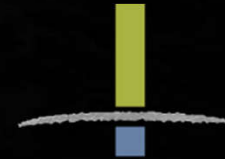

MAGNUSSON  
KLEMENCIC  
ASSOCIATES

Structural + Civil Engineers

# **Rainier Square Redevelopment**

## **Seattle, Washington**

**AISC SpeedCore Summit**  
**Dallas, TX**  
**March 20, 2019**

**Brian Morgen, Ph.D., P.E., S.E.**  
**Principal**  
**Magnusson Klemencic Associates**

THE CONSTRUCTION RESOURCE

# ENR

Engineering News-Record

DECEMBER 25, 2017/JANUARY 1, 2018 ■ enr.com

## CALCULATED RISKS

**Intrepid team for 850-ft-tall skyscraper in quake-prone Seattle predicts its cutting-edge composite steel frame will trigger an era of speedier, safer and better office-tower construction (P. 18)**

**ALSO INSIDE:  
FOURTH  
QUARTERLY  
COST REPORT**

A bnp PUBLICATION



# Why CF-CPSW / SpeedCore?









# Why CF-CPSW / SpeedCore?

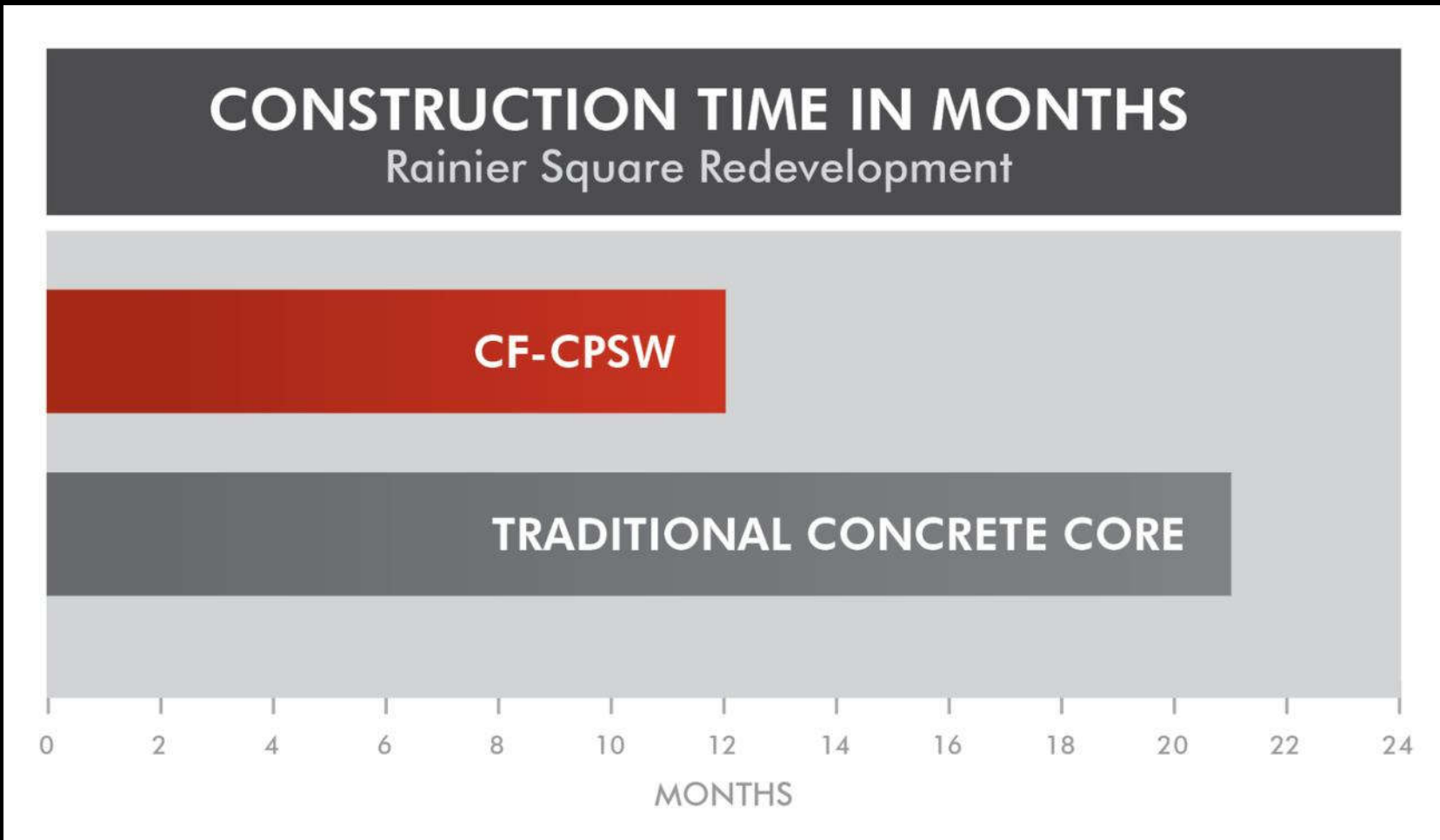

# CF-CPSW — Panel Wall Cross-Ties

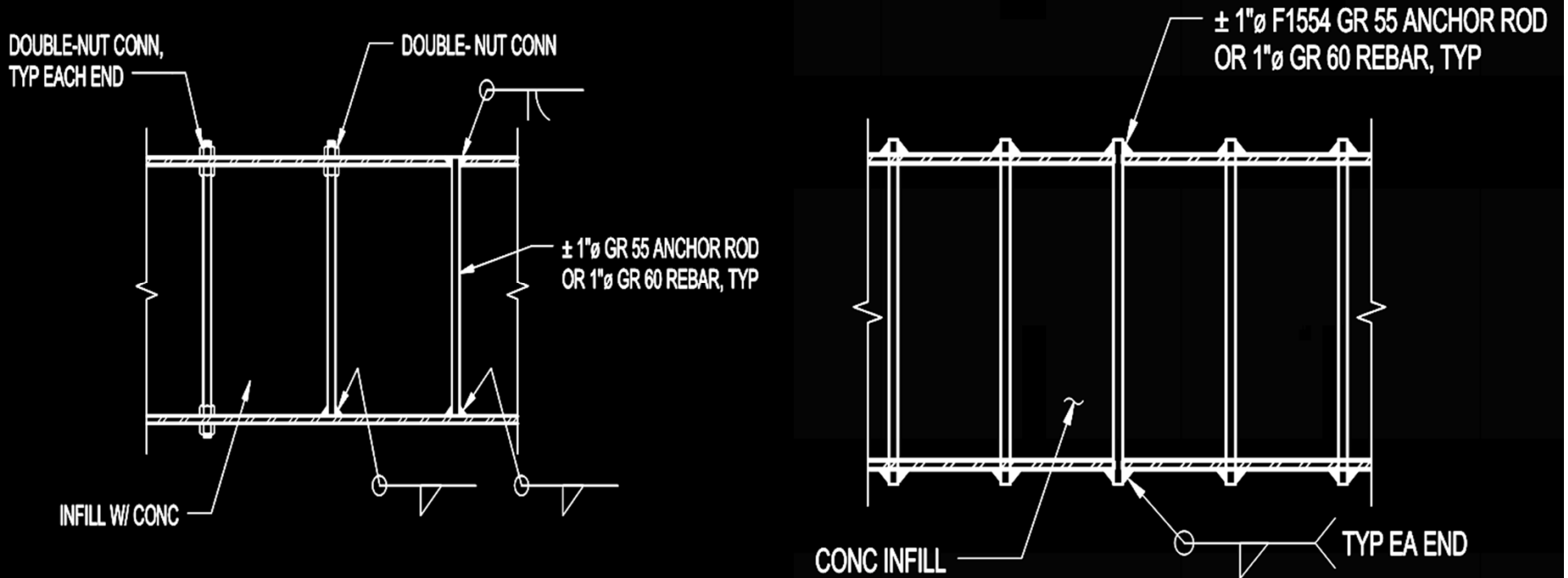



# CF-CPSW — Boundary Elements

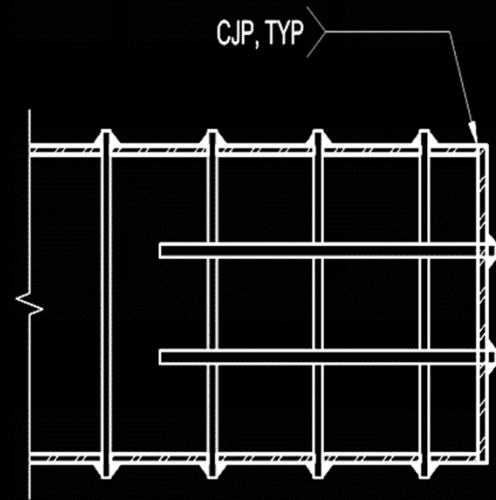
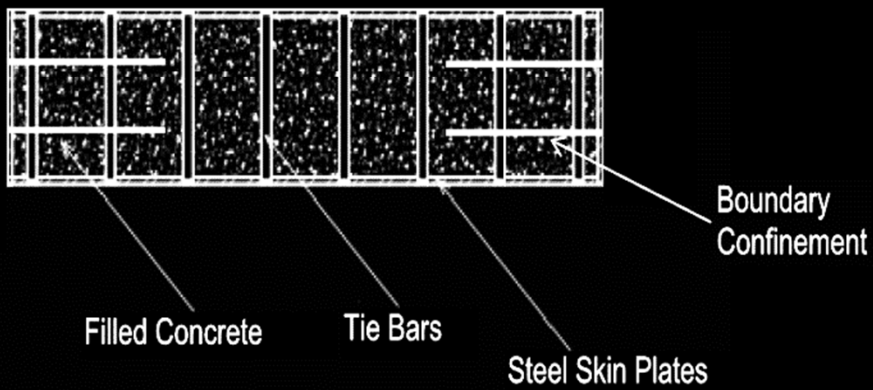
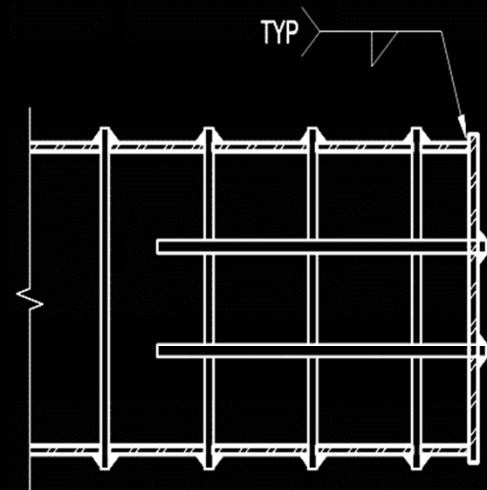
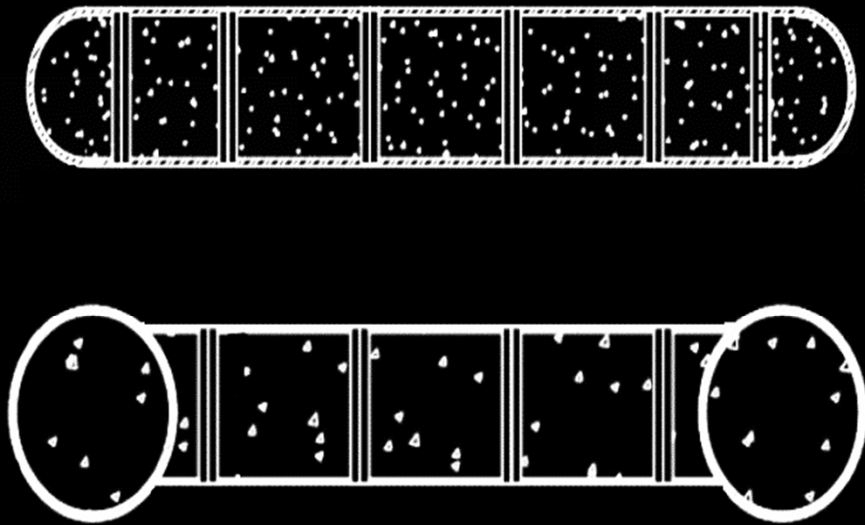

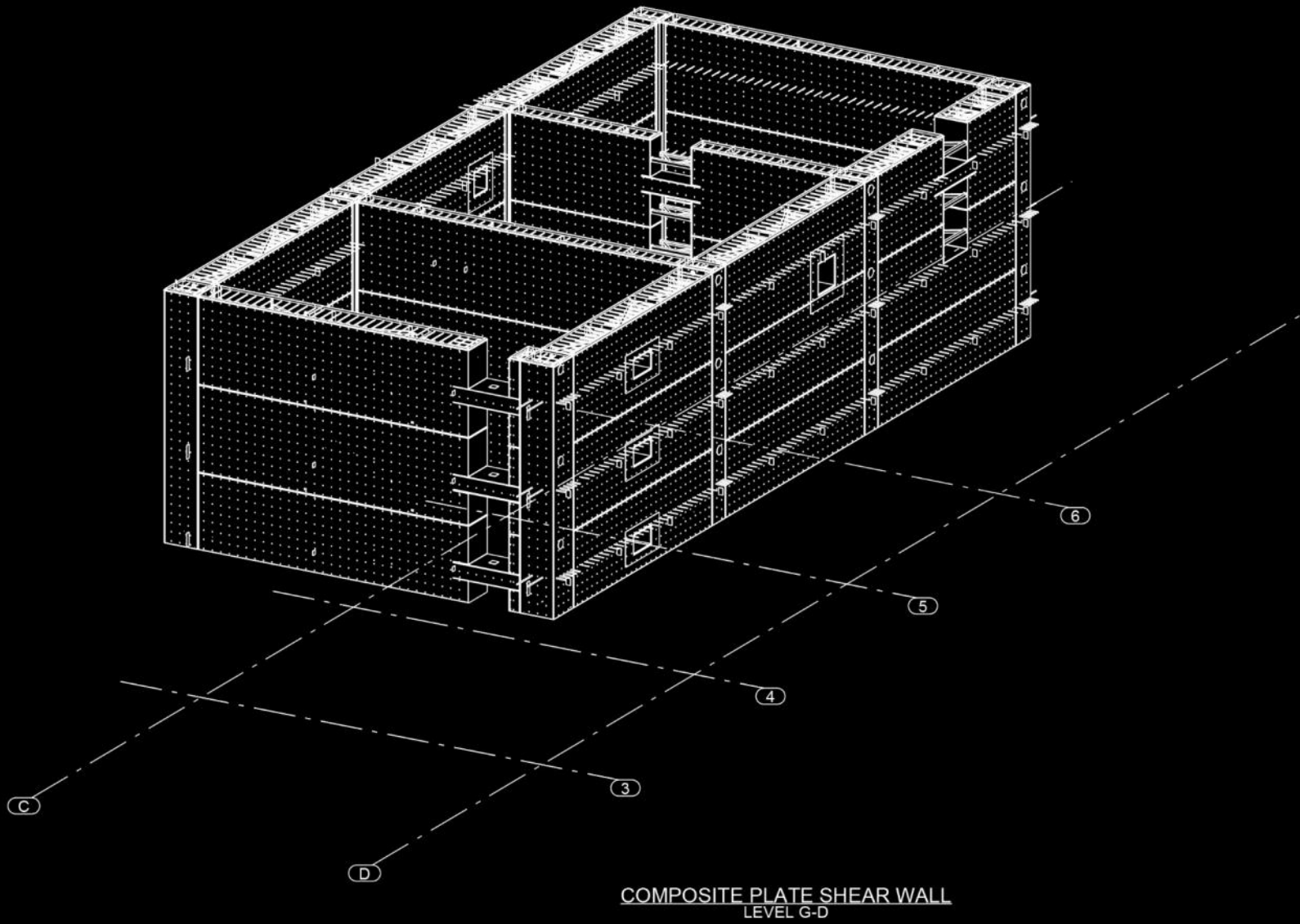

COMPOSITE PLATE SHEAR WALL  
LEVEL G-D

# CF-CPSW — Coupling Beams & Panels

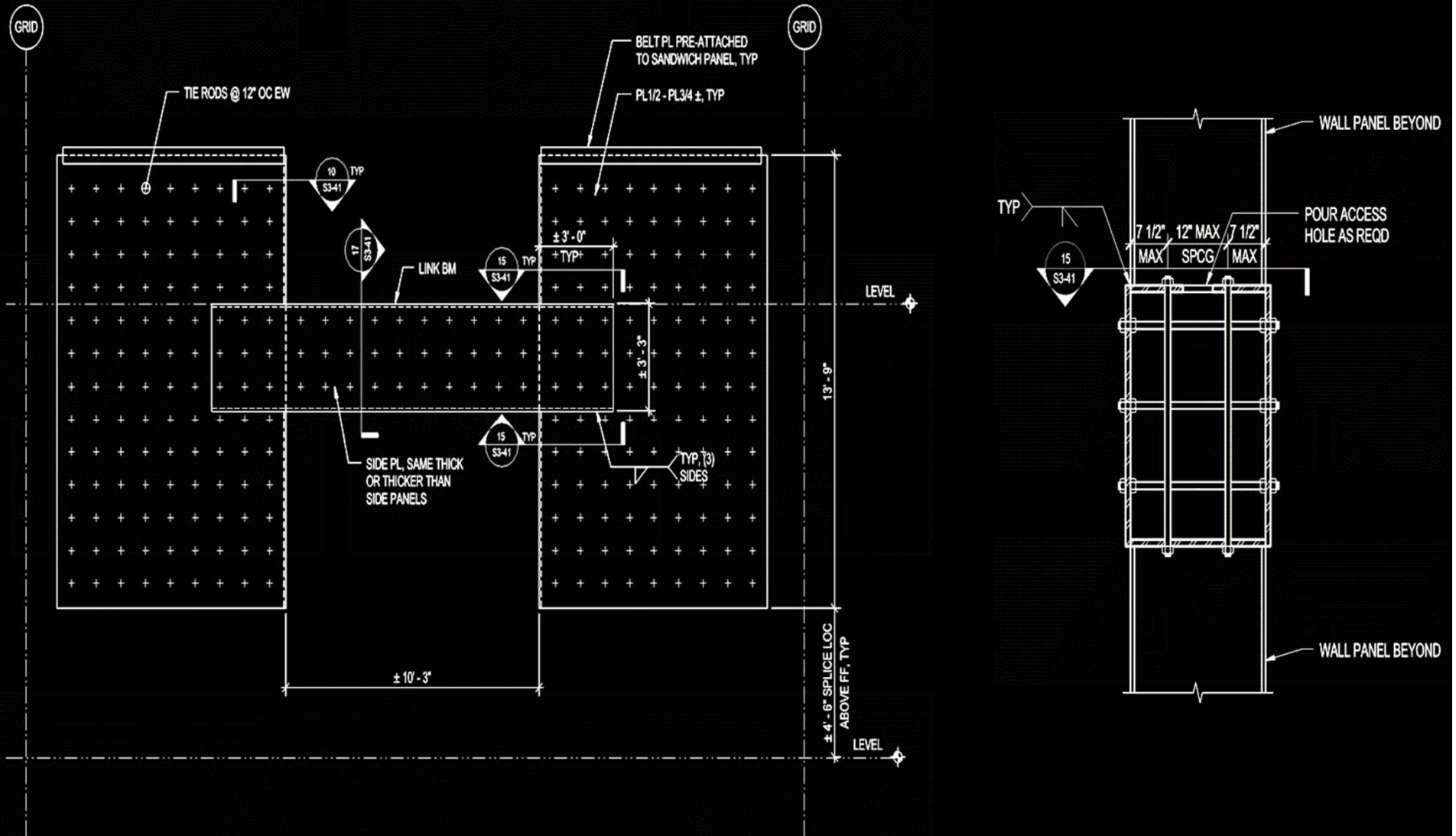





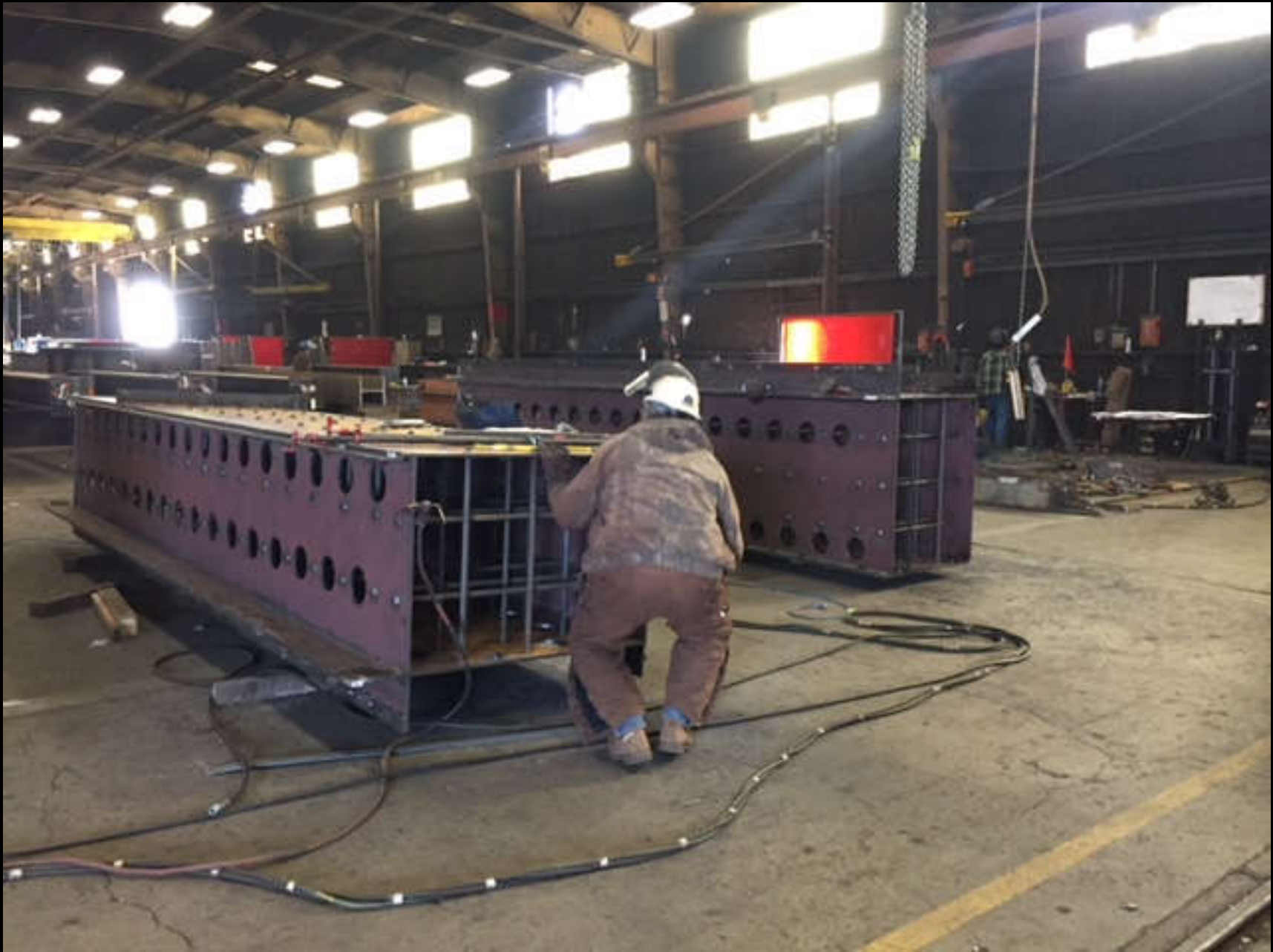





ATTACHMENT D - RAINIER SQUARE PRESENTATION









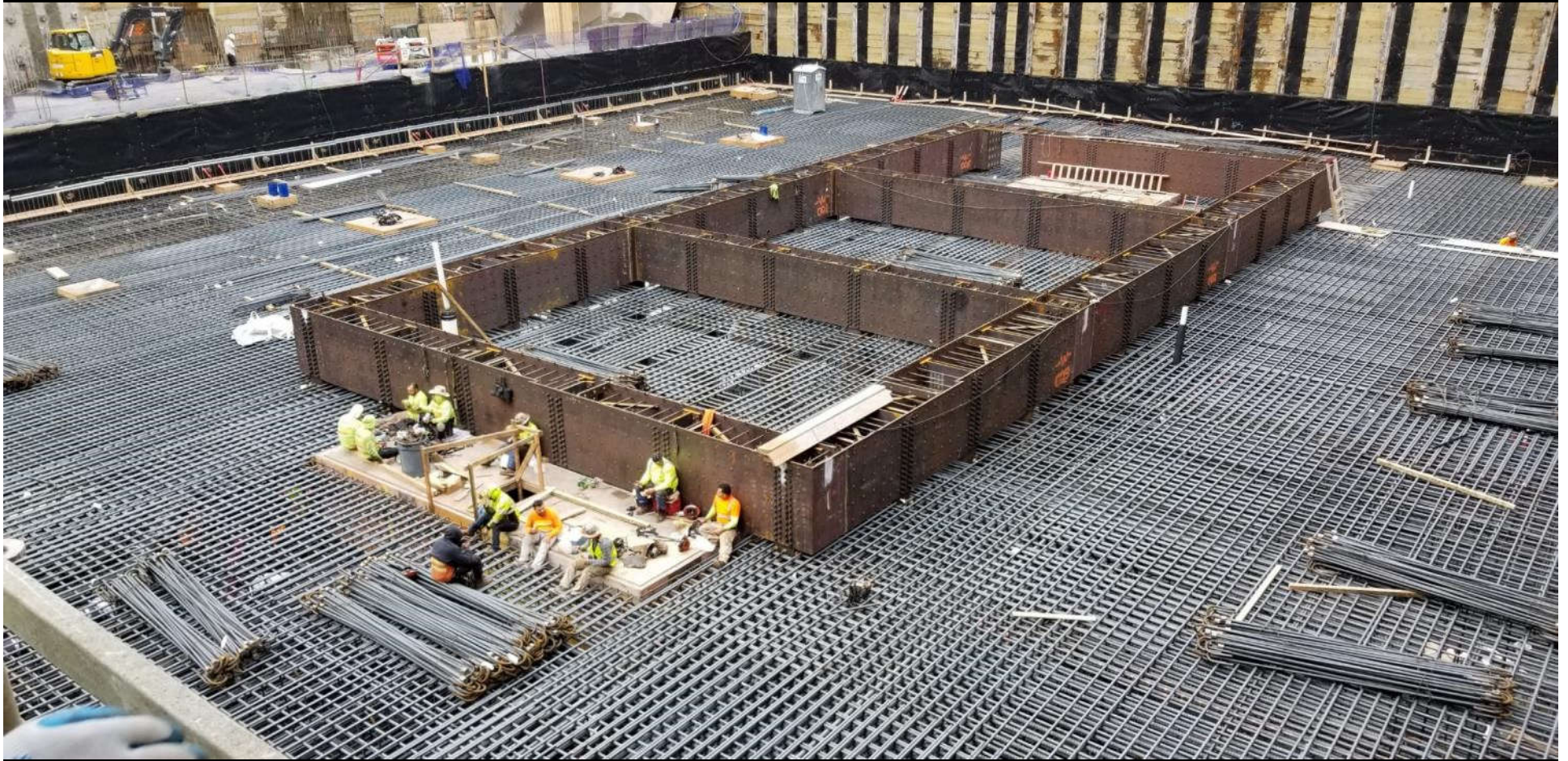



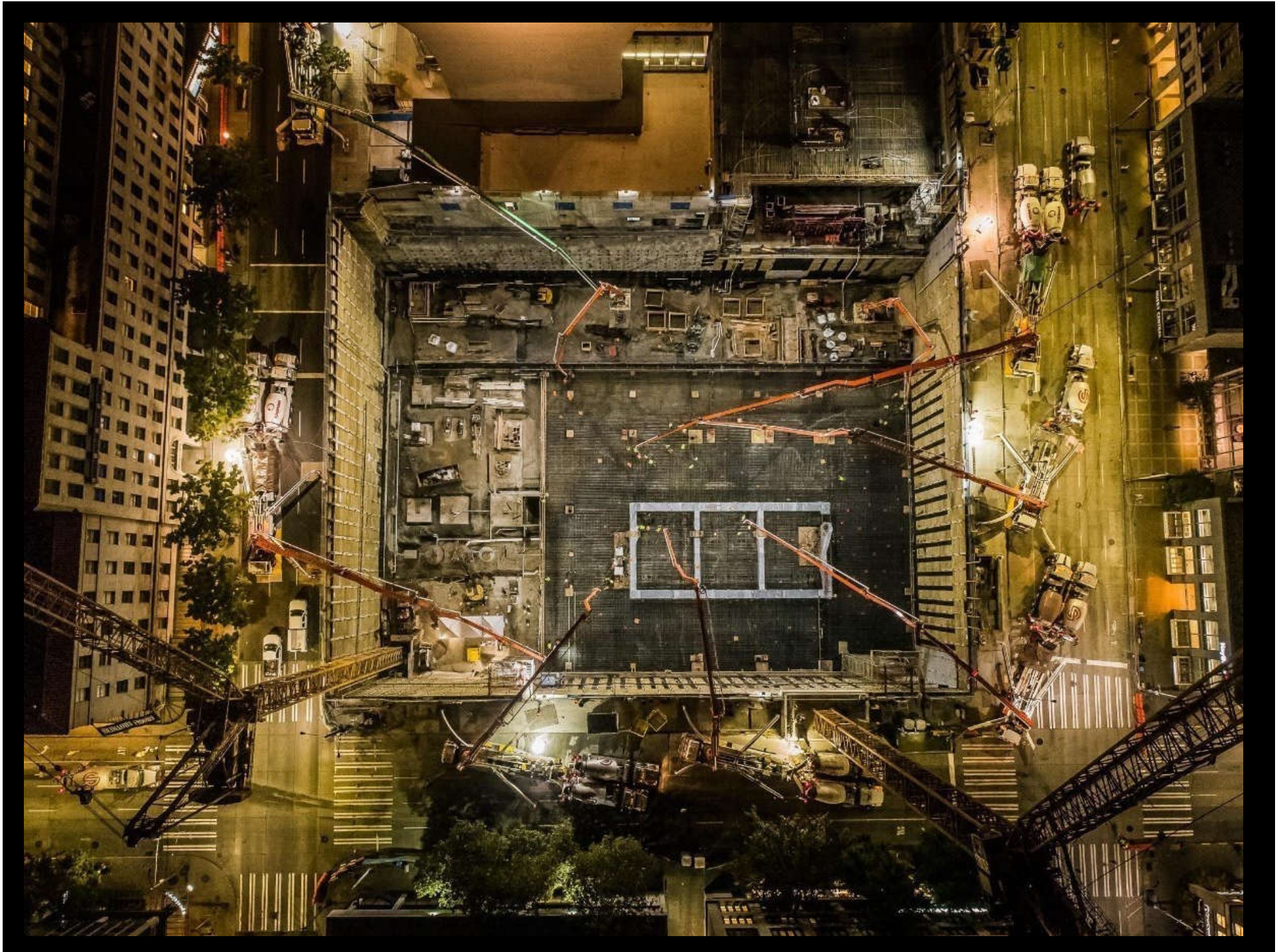



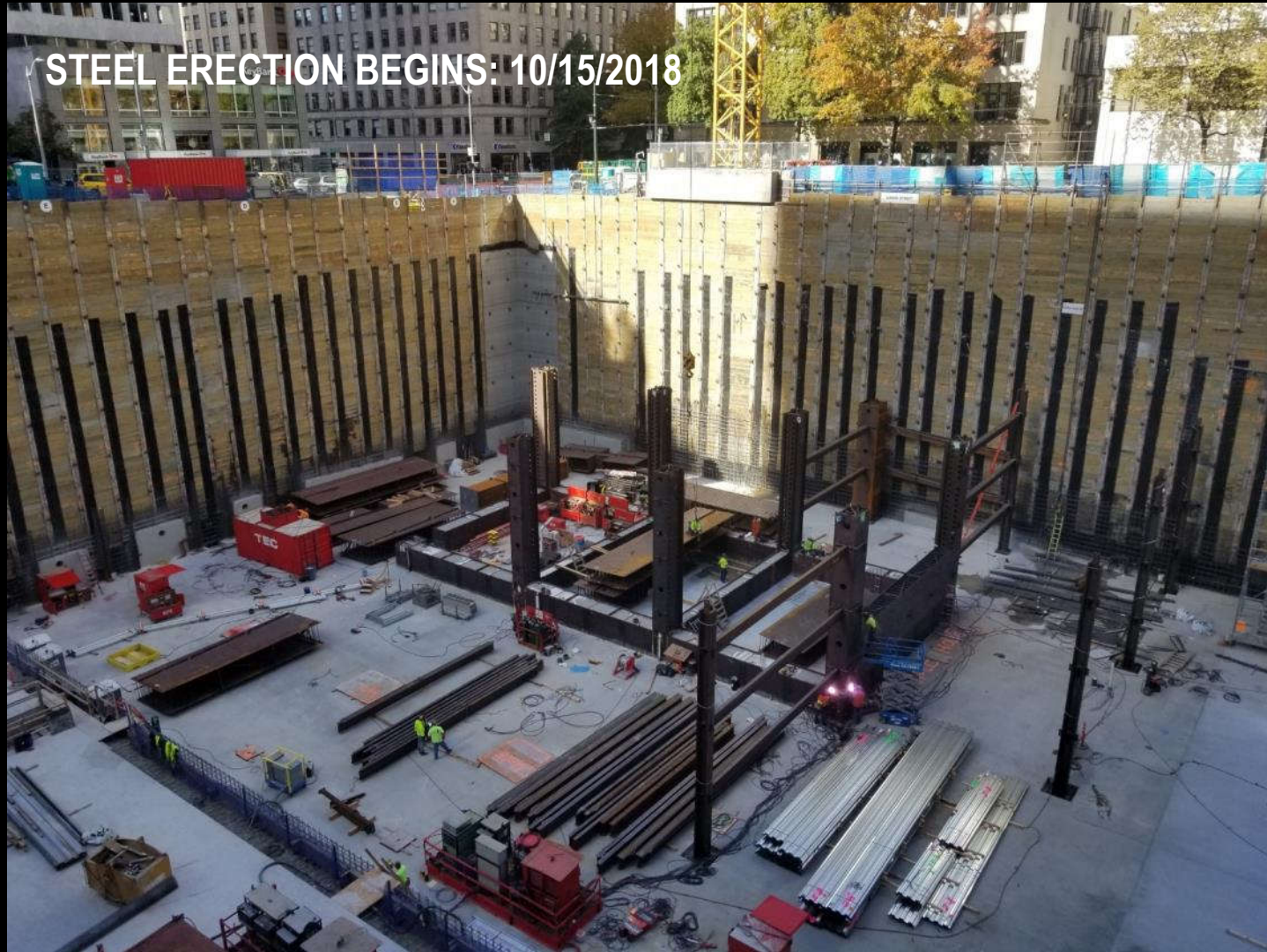



# Field Weld Splice Details

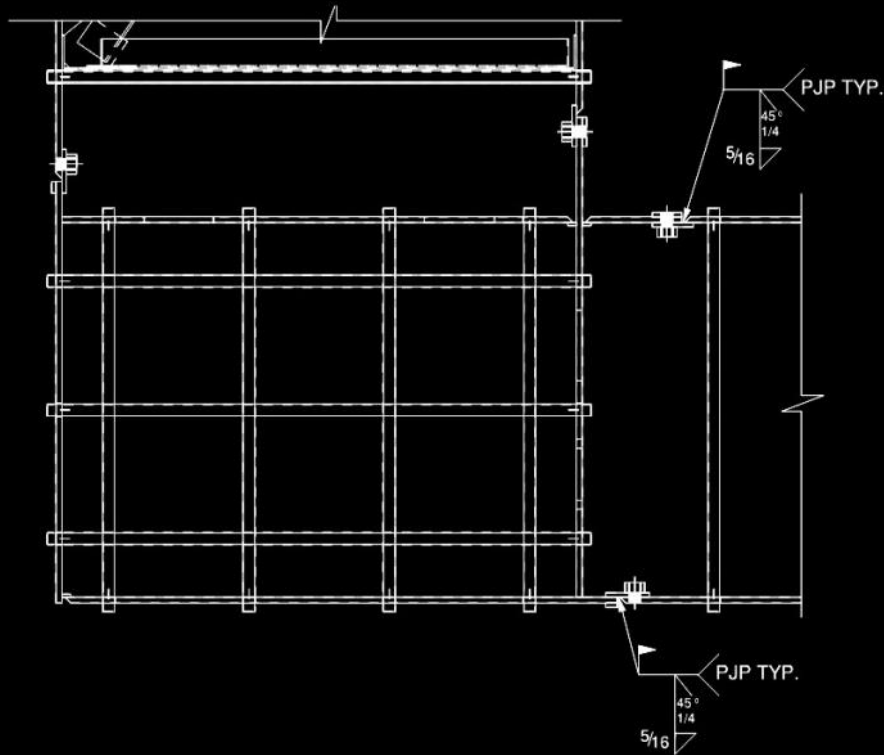

**Composite Core Column to Panel  
Vertical Splice Detail  
(Plan View)**

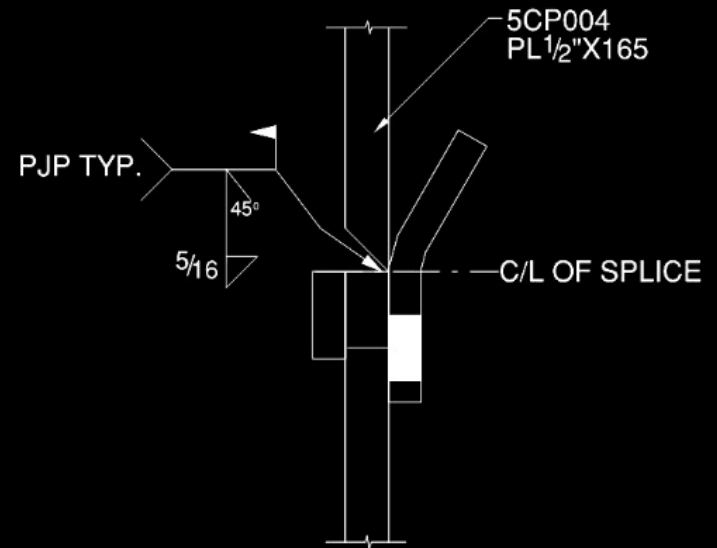

**Core Panel to Panel  
Horizontal Slice Detail**

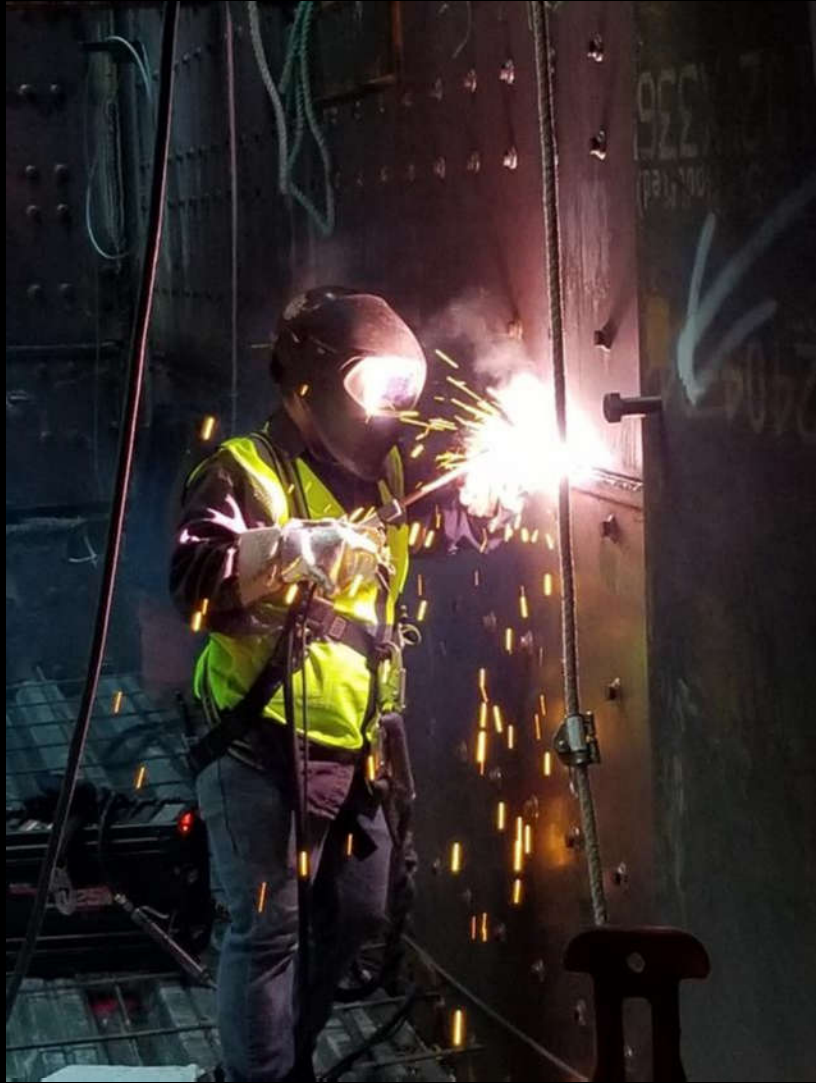

























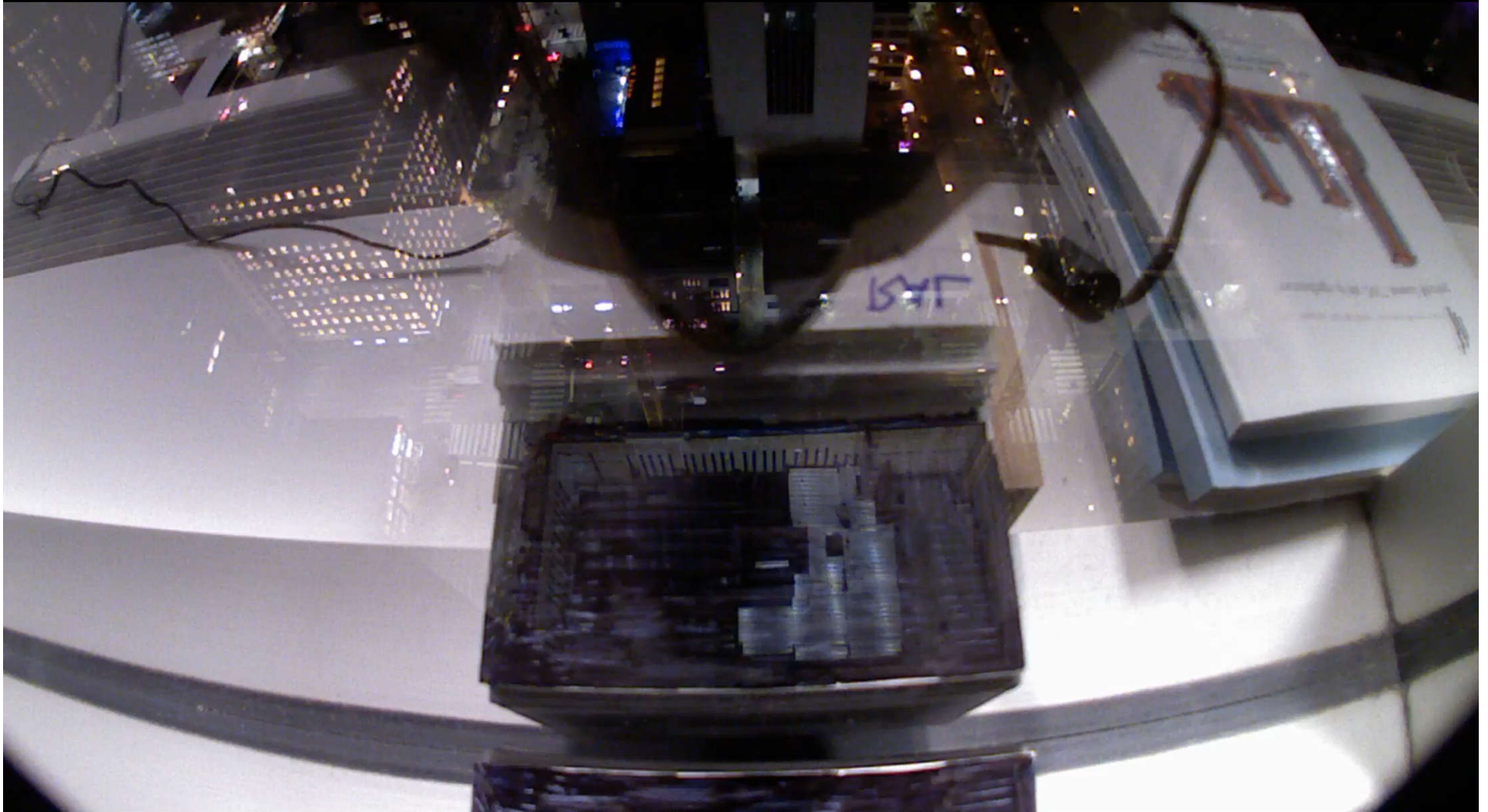

TLC200 2018/10/19 06:00:04

# Future Efficiency Opportunities?

- Mechanically Fastened Field Splices
- Seismic vs. Non-Seismic
- Fire Engineering
- Mill Order Widths for Plate (14'?)
- Minimum Plate Thickness
- Cross-Ties Type and Detailing
- Alternative Foundation Connection
- Coupling Beam Detailing
- Alternative Fabricator Panelization Preferences
- Wall End / Boundary Element Detailing
- Automated Welding Opportunities
- Others???



MAGNUSSON  
KLEMENCIC  
ASSOCIATES

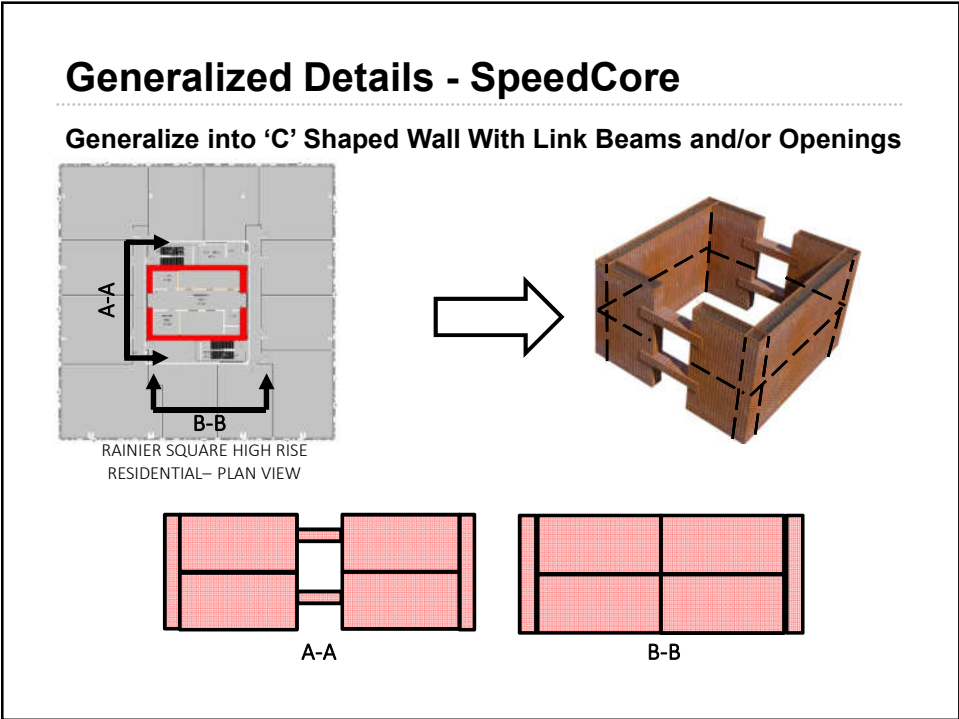



## SpeedCore Components

---

### Critical Considerations for Non-Seismic Designs

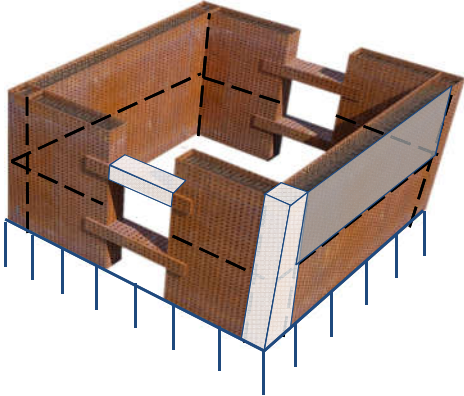

- 1) TYPICAL PANELS
- 2) SPLICE DETAILS
- 3) CORNER DETAILS
- 4) COUPLING BEAM DETAILS
- 5) FOUNDATION CONNECTION DETAILS
- 6) GENERAL ERECTION

SOME GENERALIZED DETAILS ARE PRESENTED HEREIN FOR DISCUSSION PURPOSES

## Typical Wall Panel

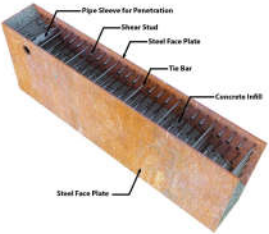

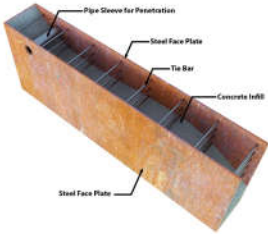

**NOTES**  
 PANEL PLATE THICKNESS AND OVERALL THICKNESS  
 GENERALLY GOVERNED BY HANDLING LIMITATIONS  
 COMBINATION OF STUDS AND RODS/BARS CAN BE USED  
 PLATE WIDTHS AND LENGTHS CAN VARY BASED ON  
 AVAILABILITY, FABRICATOR/ERECTOR PREFERENCES,  
 ETC

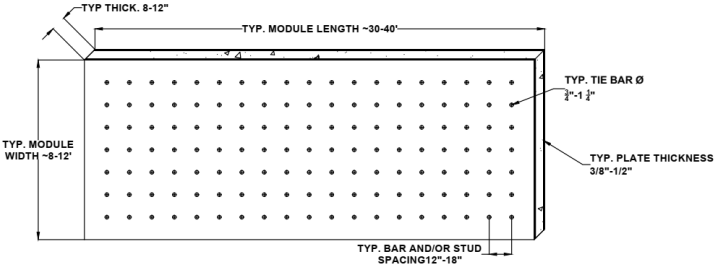

TYP. THICK. 8-12"  
 TYP. MODULE LENGTH ~30-40"  
 TYP. MODULE WIDTH ~8-12'  
 TYP. TIE BAR Ø 3/4"-1 1/4"  
 TYP. PLATE THICKNESS 3/8"-1/2"  
 TYP. BAR AND/OR STUD SPACING 12"-18"

### Typical Wall Panel

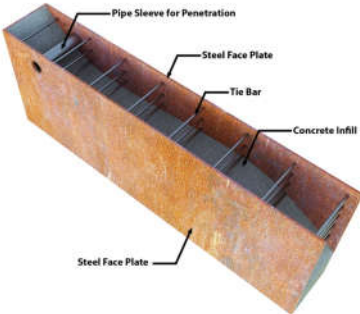
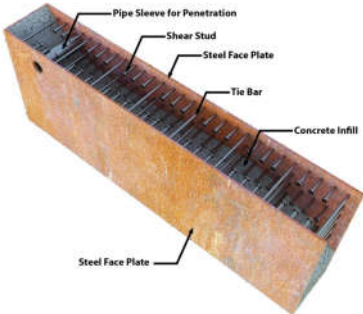

### Wall Panel Tie Bars – Fillet Weld Option

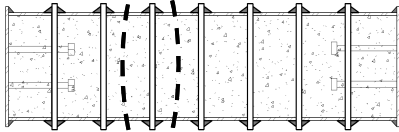
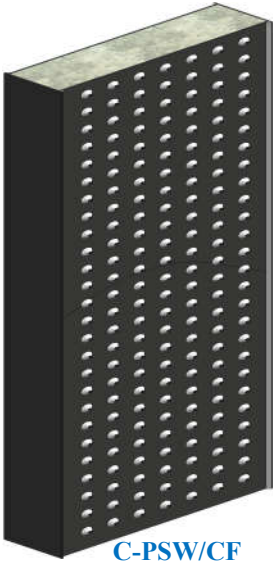

Wall section

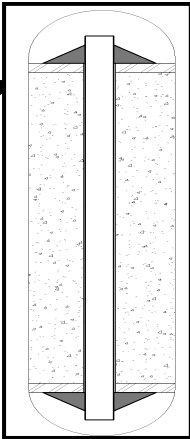

Fillet welded tie bars

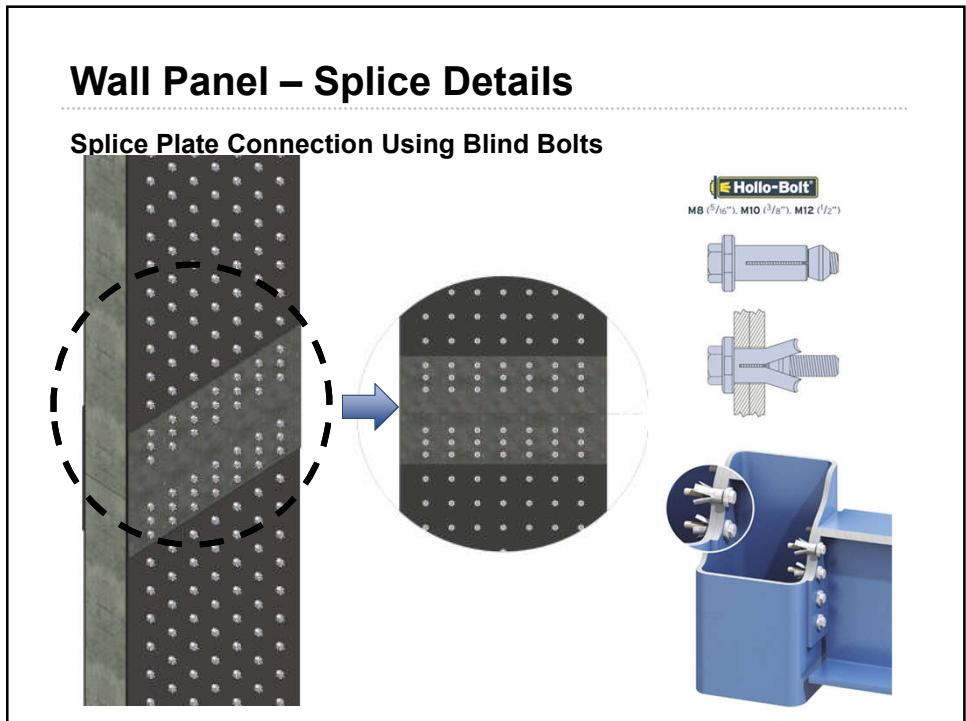
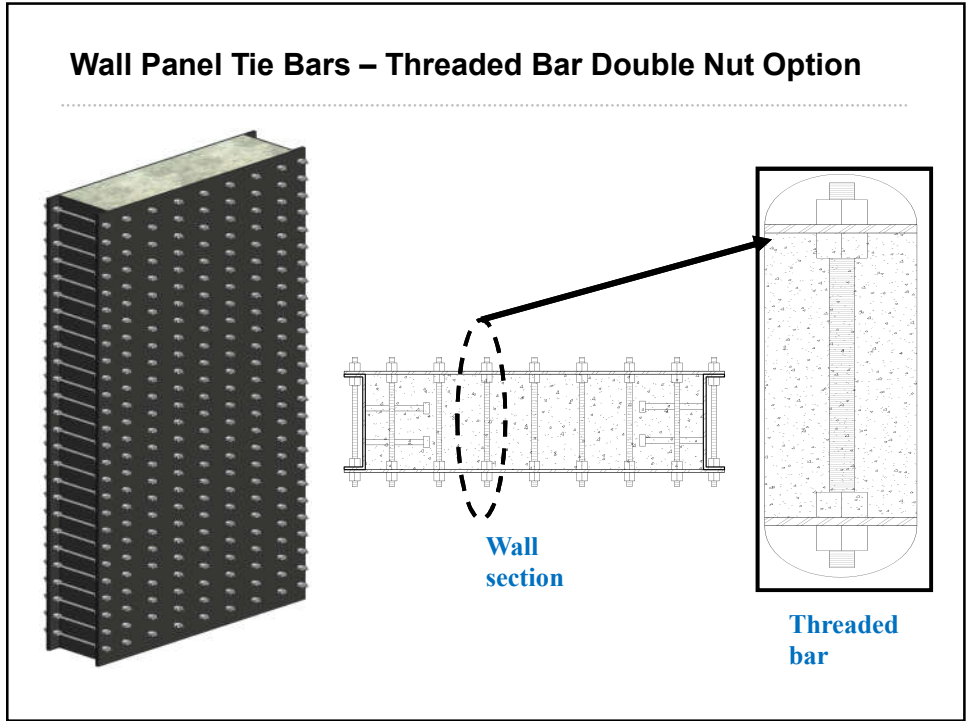

## Wall Panel – Splice Details

### Splice Plate Fillet Welded to Wall Panels

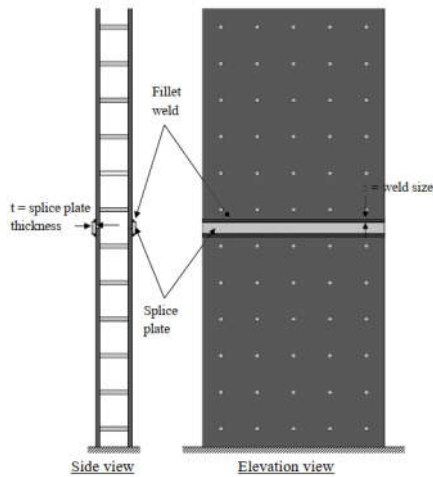

Fillet welded splice plates can be used in non-seismic areas  
 Important that connection allows panels to rotate as single unit but can be design for applied forces only

IMAGE SOURCE: PANKOW FOUNDATION DESIGN REPORT 2014

### Bolted Splice Option

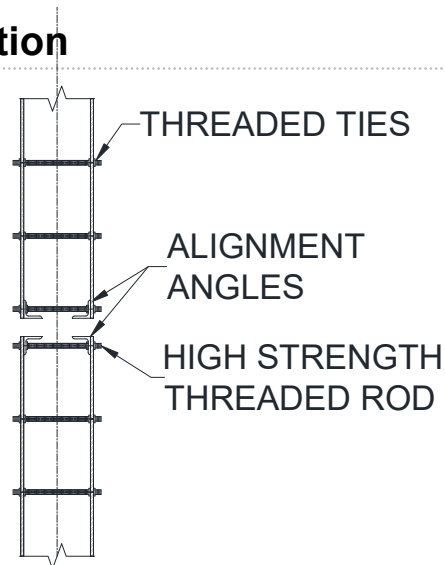

LOWER UPPER MODULE  
 TOWARD LOWER MODULE



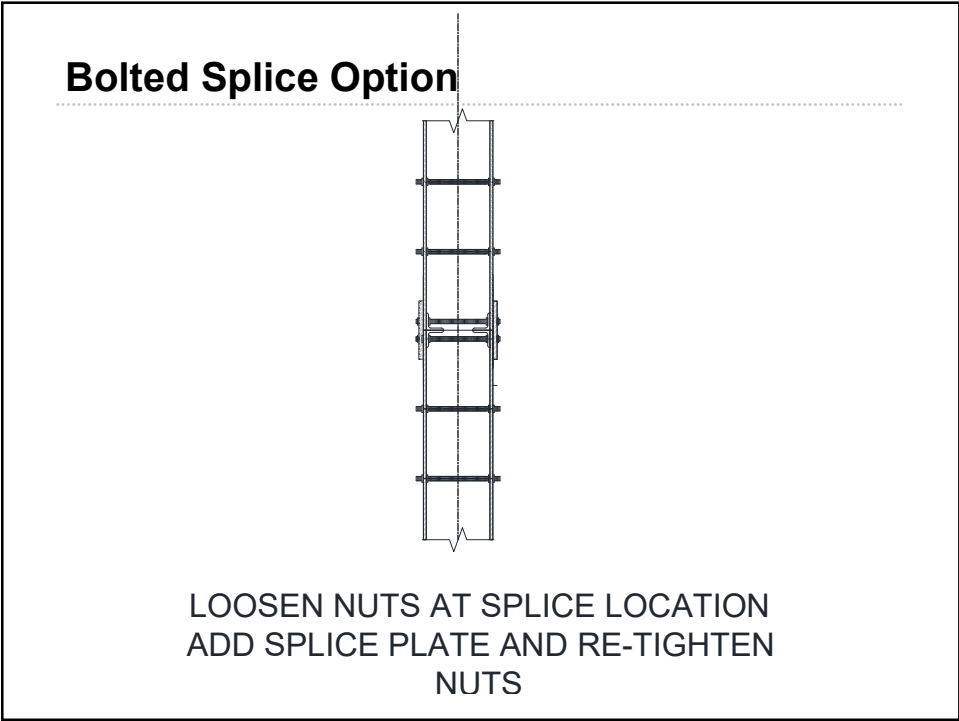
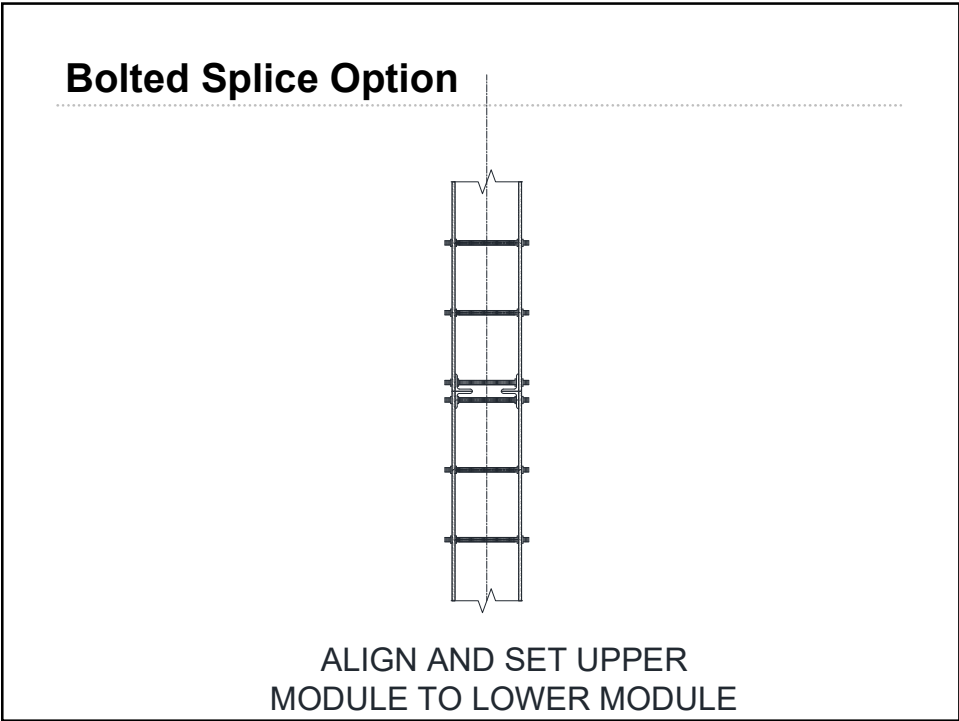



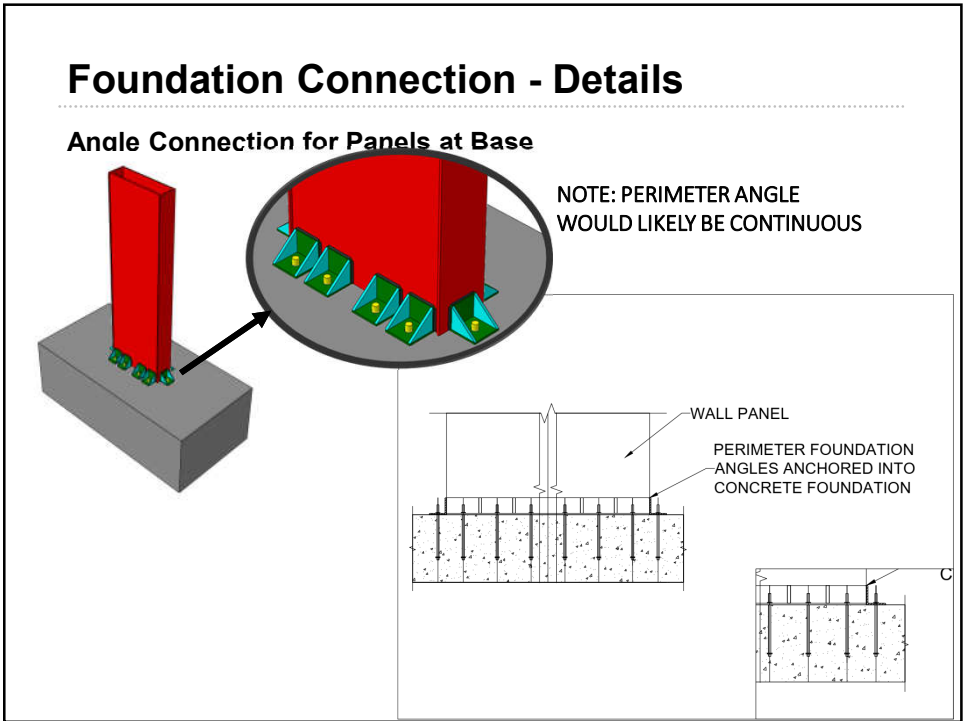
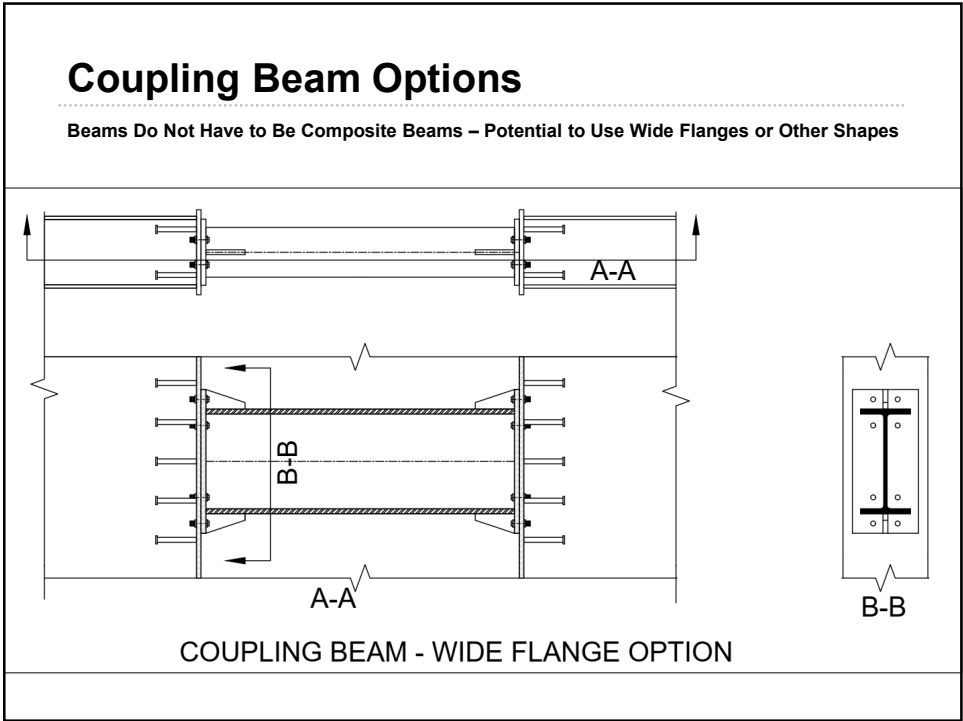

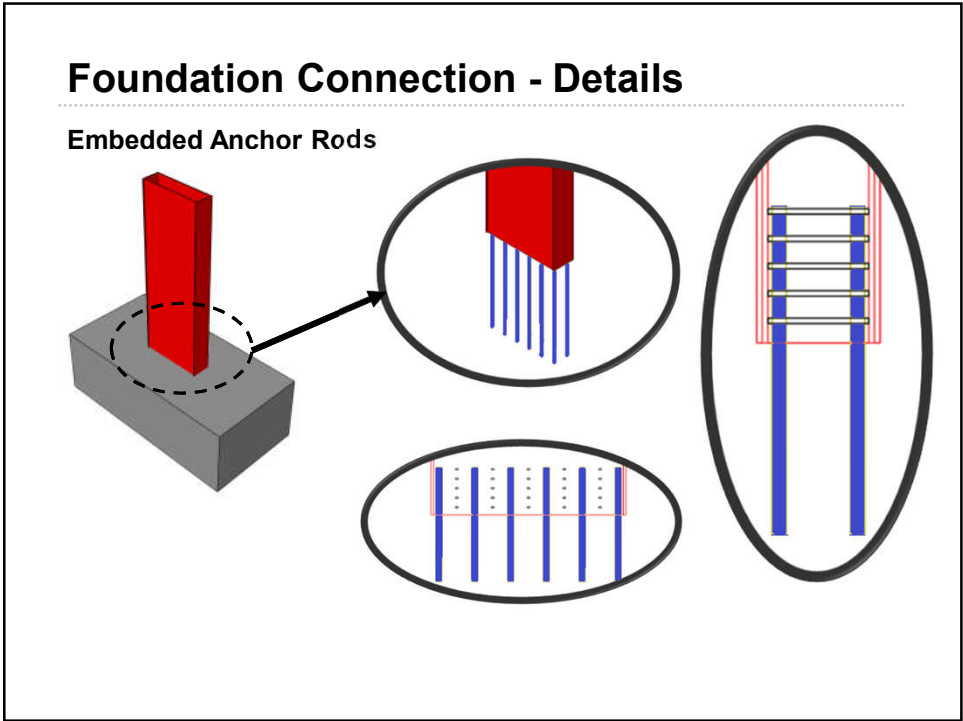

### General Erection Considerations

**Wall Panel Placement**

Current recommendations are that two stories of empty panels can be erected prior to concrete placement

Standard Lifting Appetences and Rigging Can Be Used

**Figure 3.24** Plate assembly with splice plates

**Figure 3.25** Erection of second story plate assembly

IMAGE SOURCES: PANKOW FOUNDATION DESIGN REPORT 2014



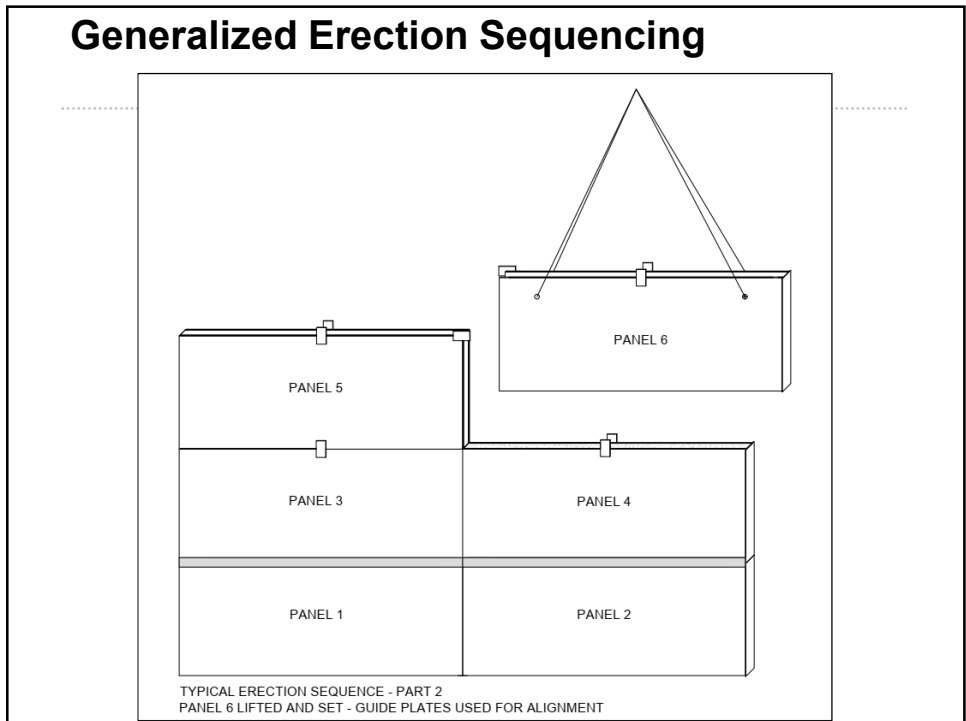
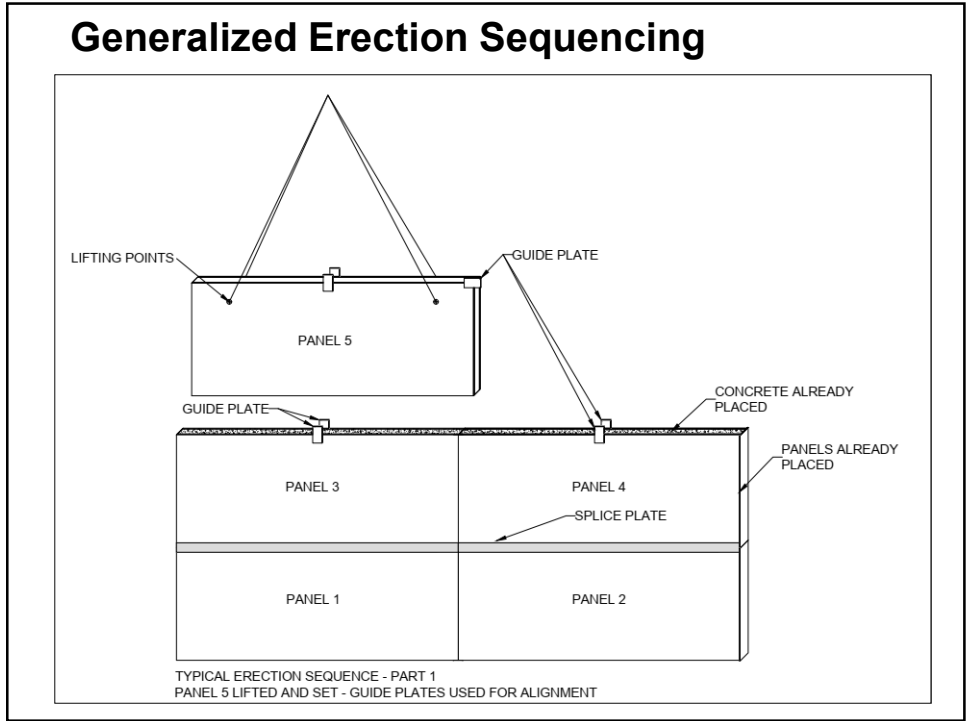

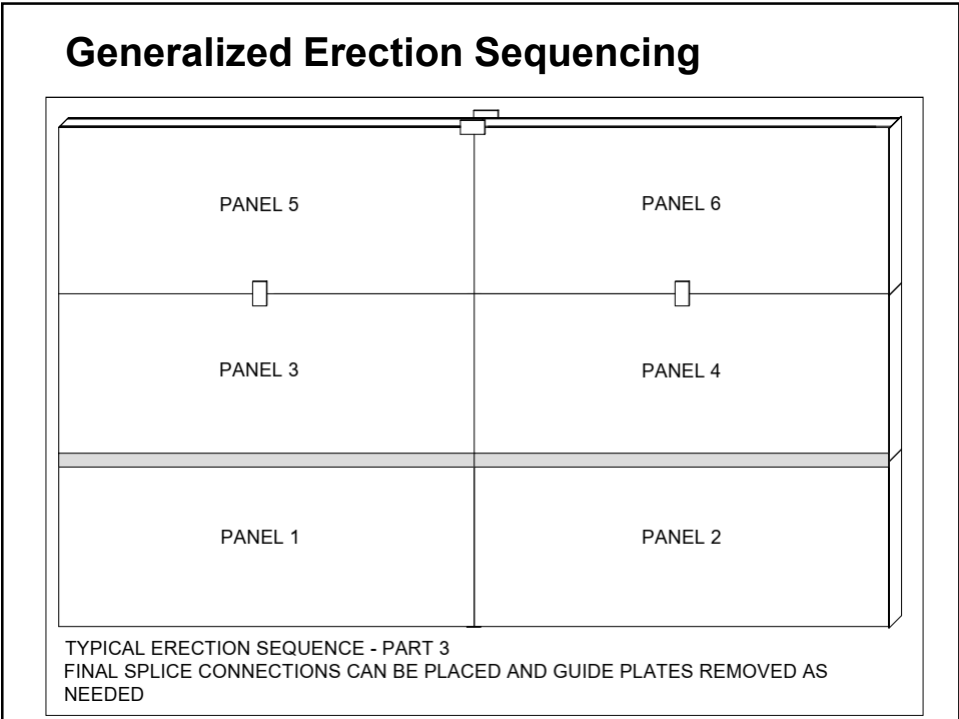

### Backup

---

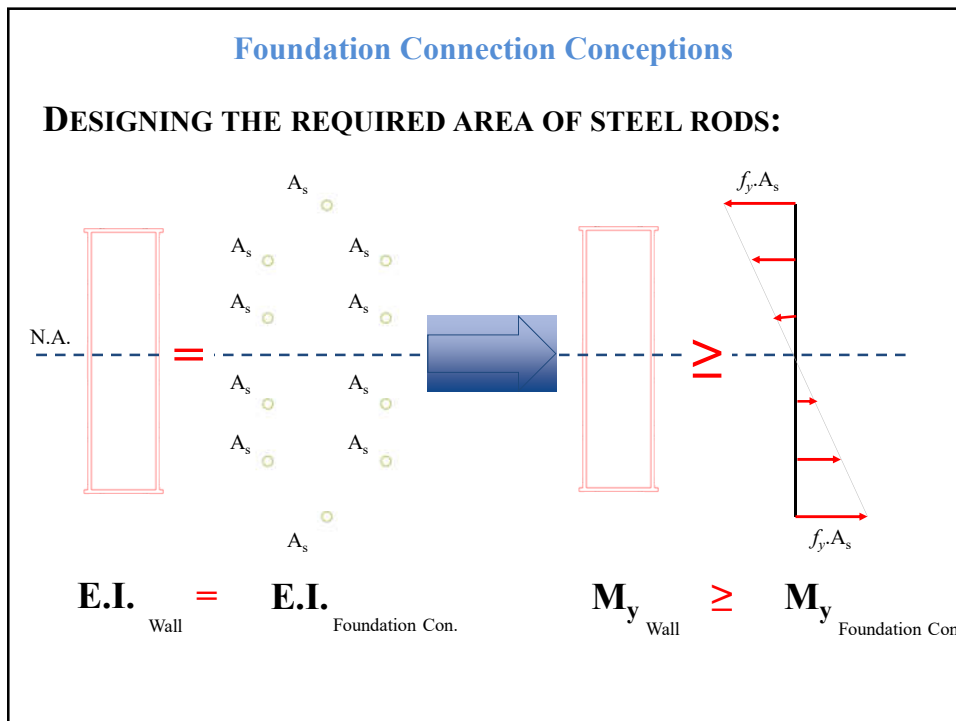
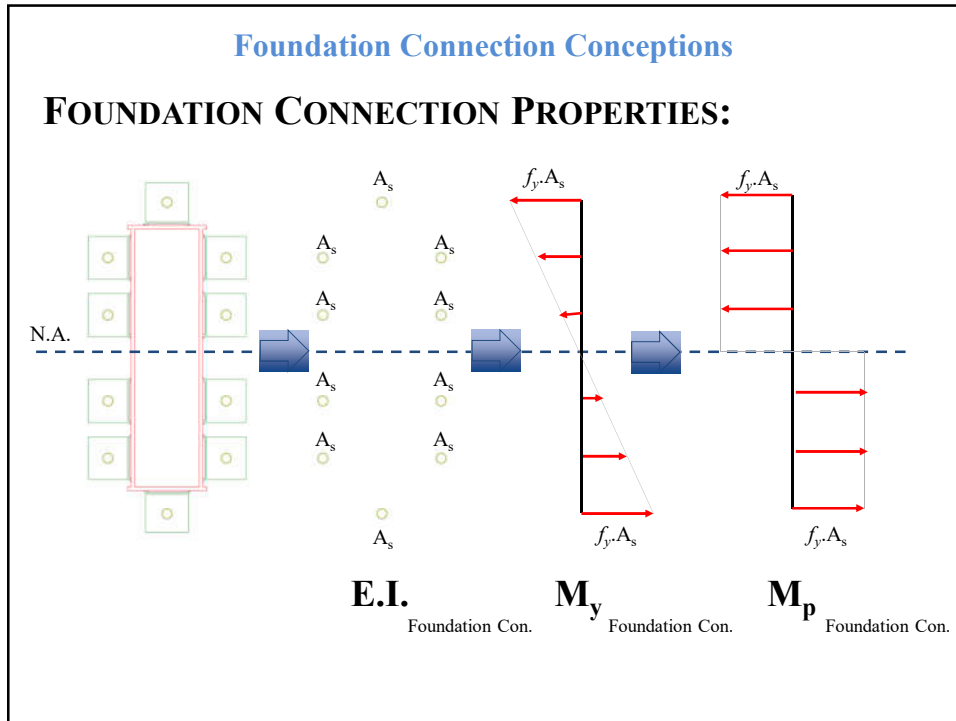

### Foundation Connection Conceptions

## DETAILS OF CONNECTION 2

### Coupling Beam Connection Conceptions

## DETAILS OF CONNECTION 2

- Using built up sections for the coupling beams.
- Anchorage bars are added to the connection plate and embedded in concrete.

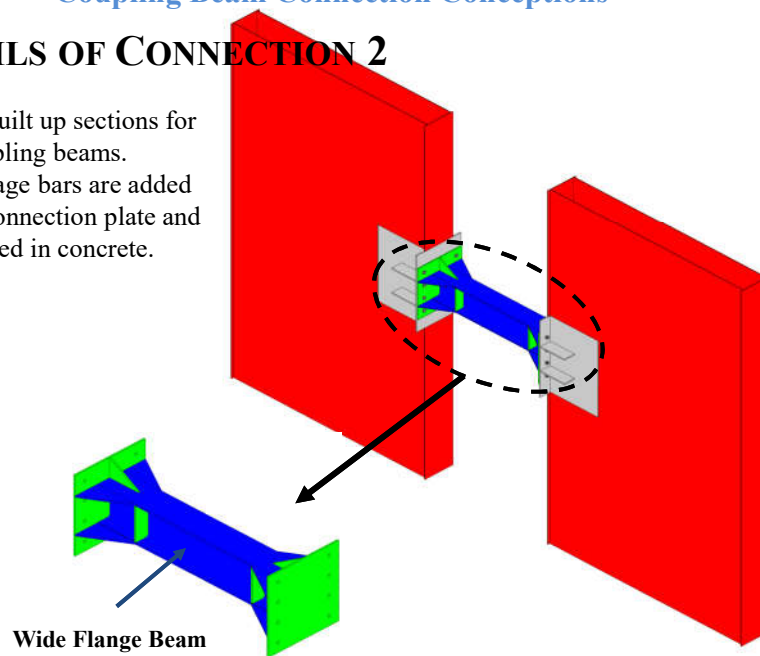



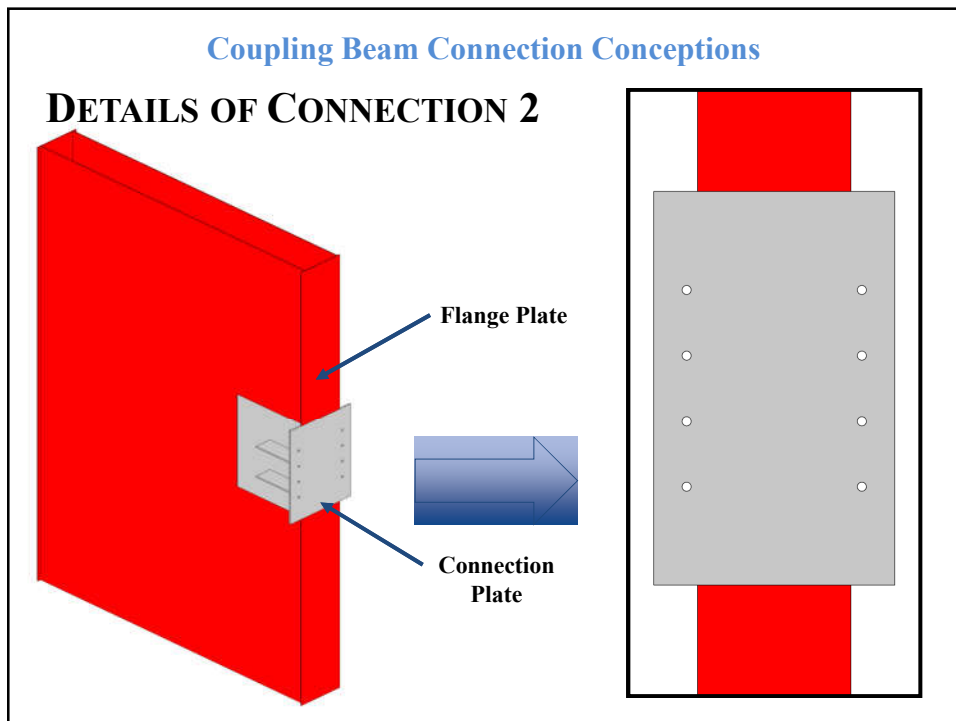
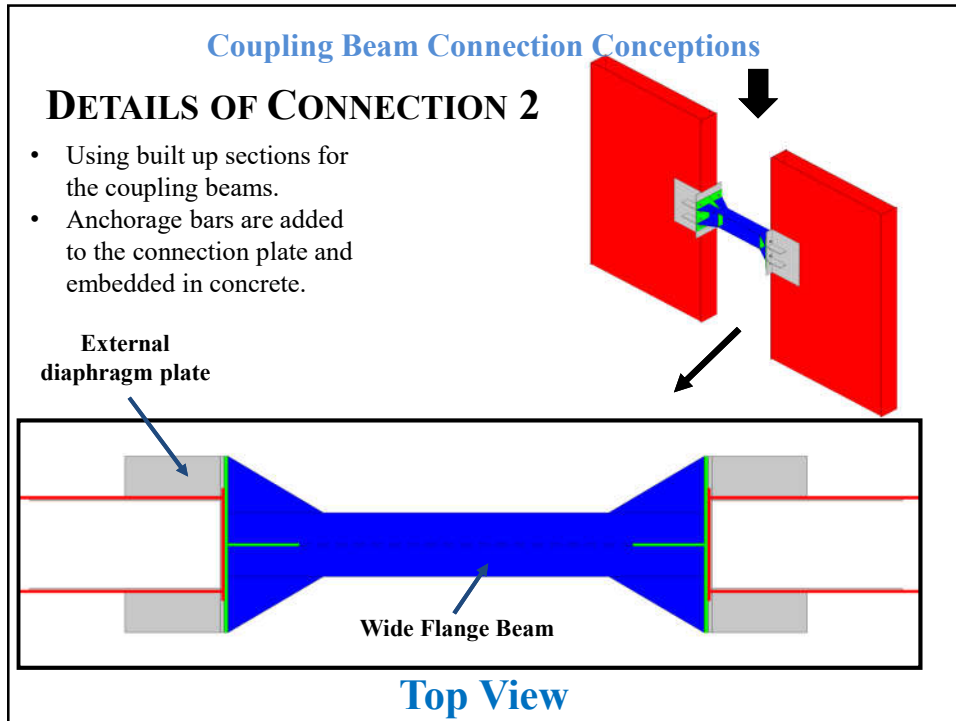

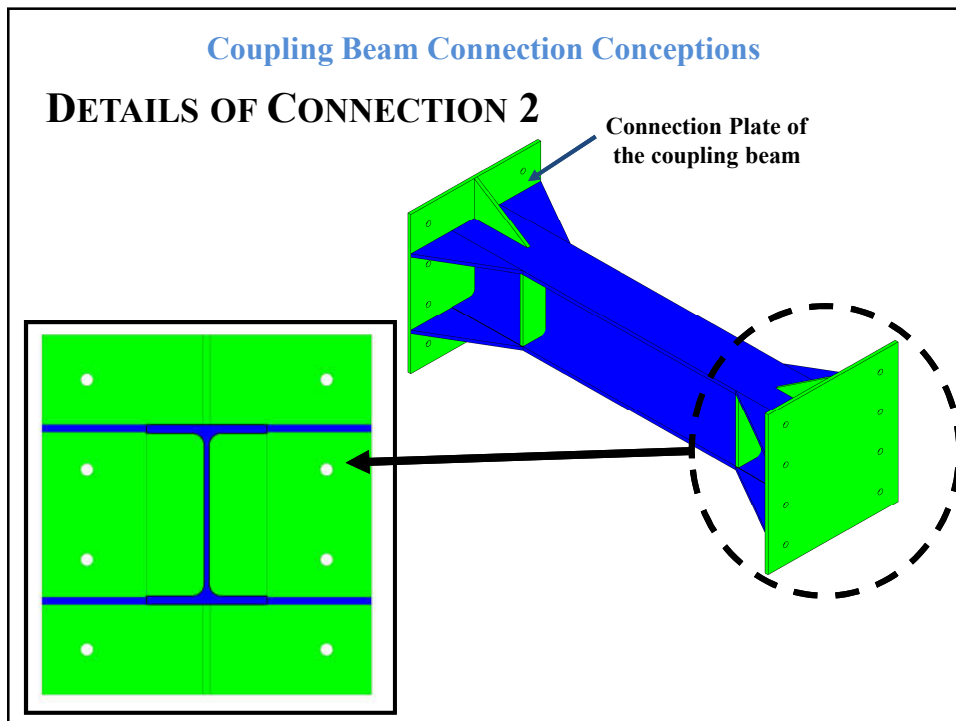
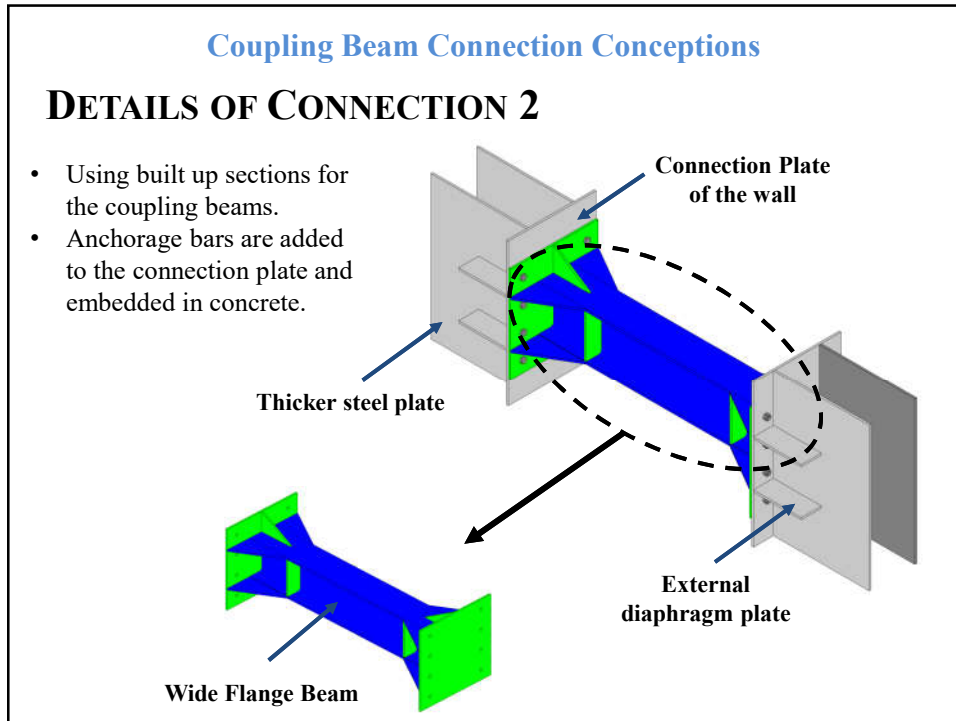

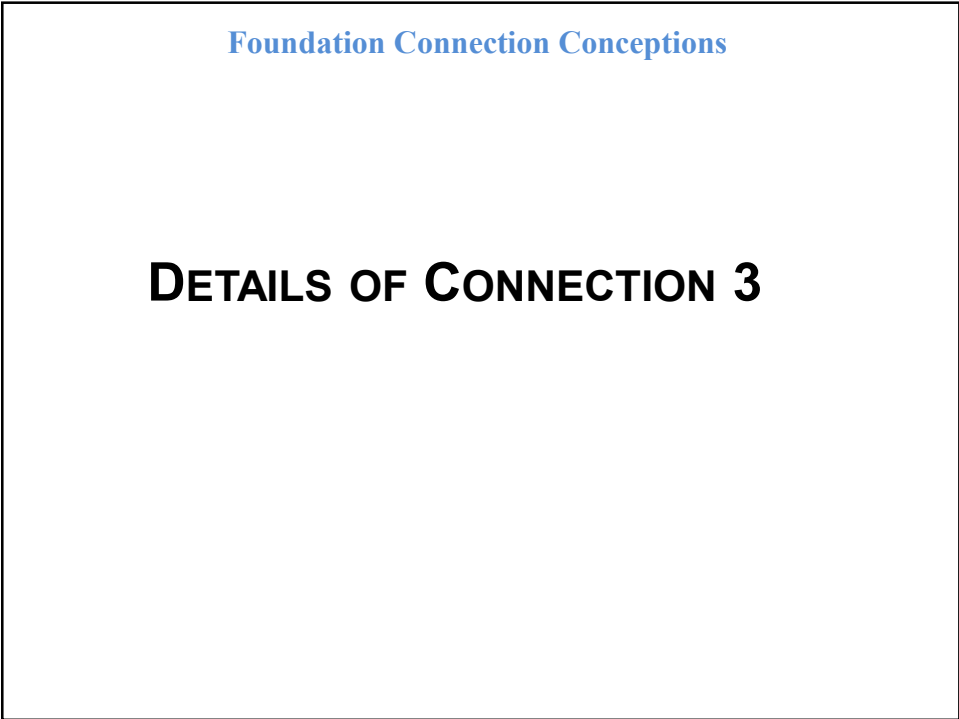
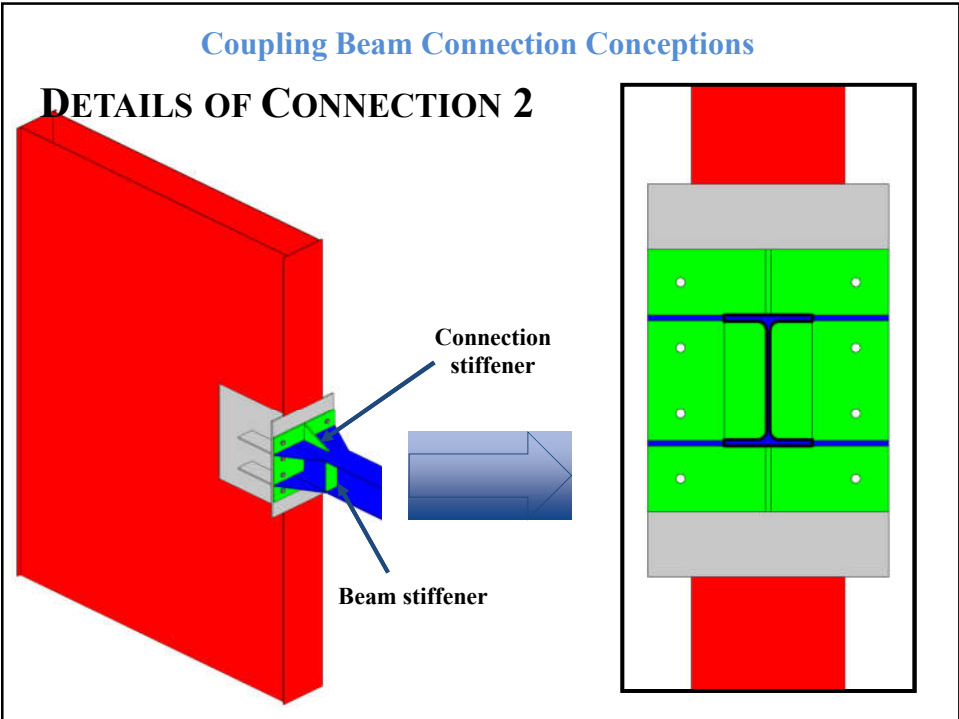

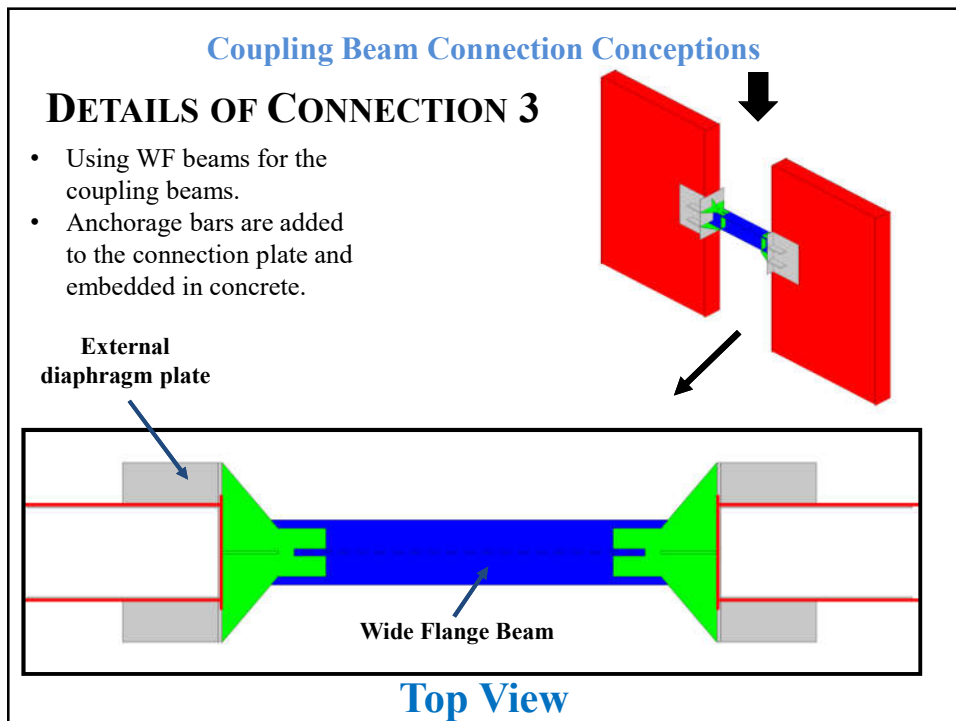
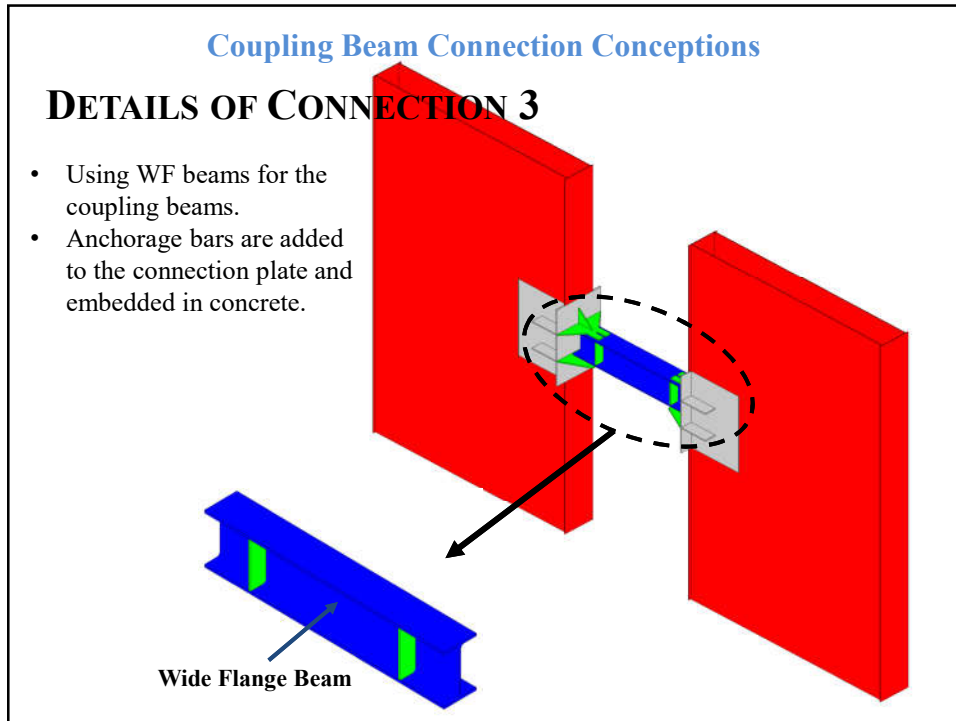



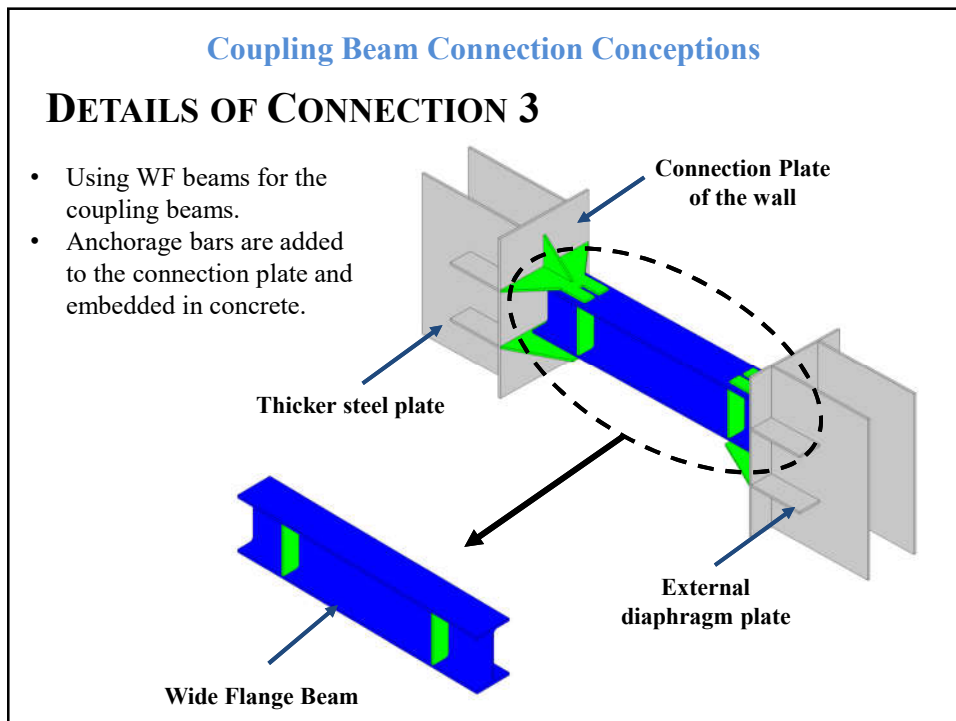
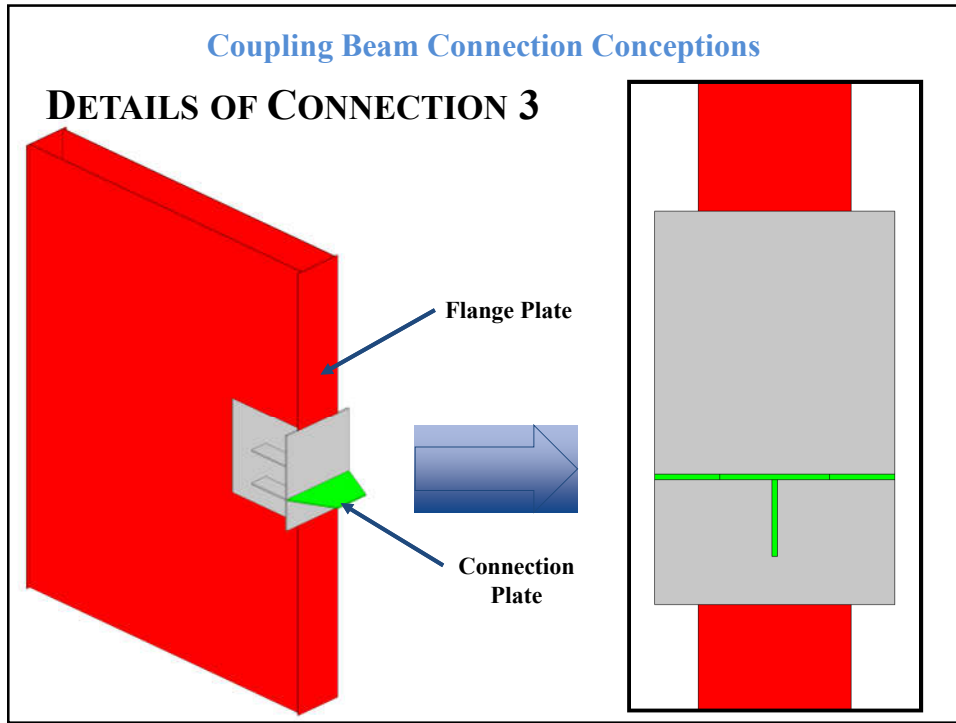

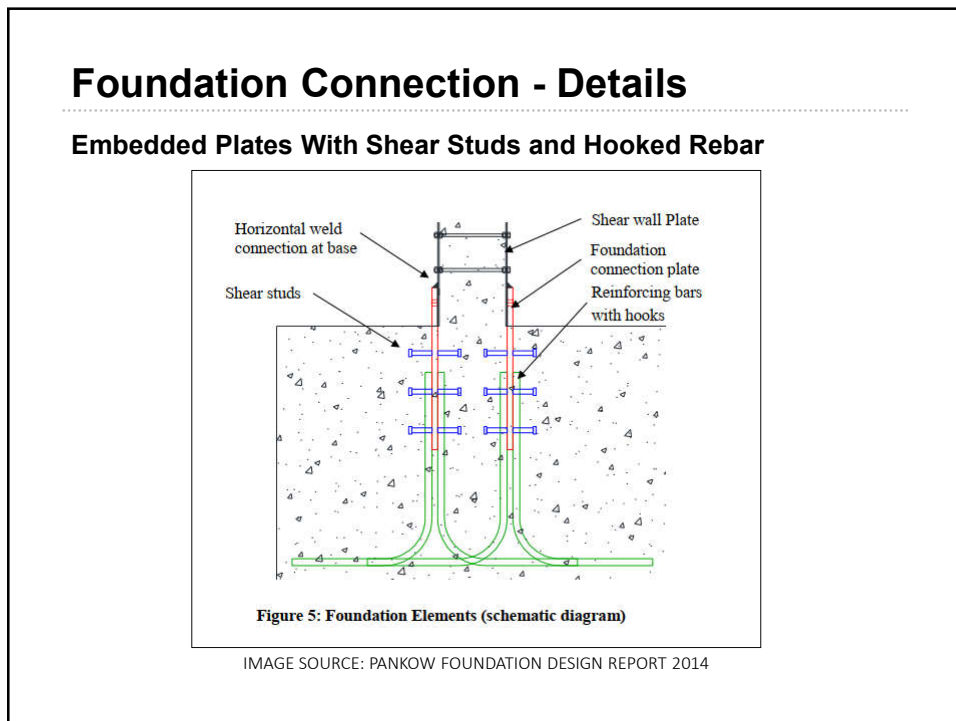
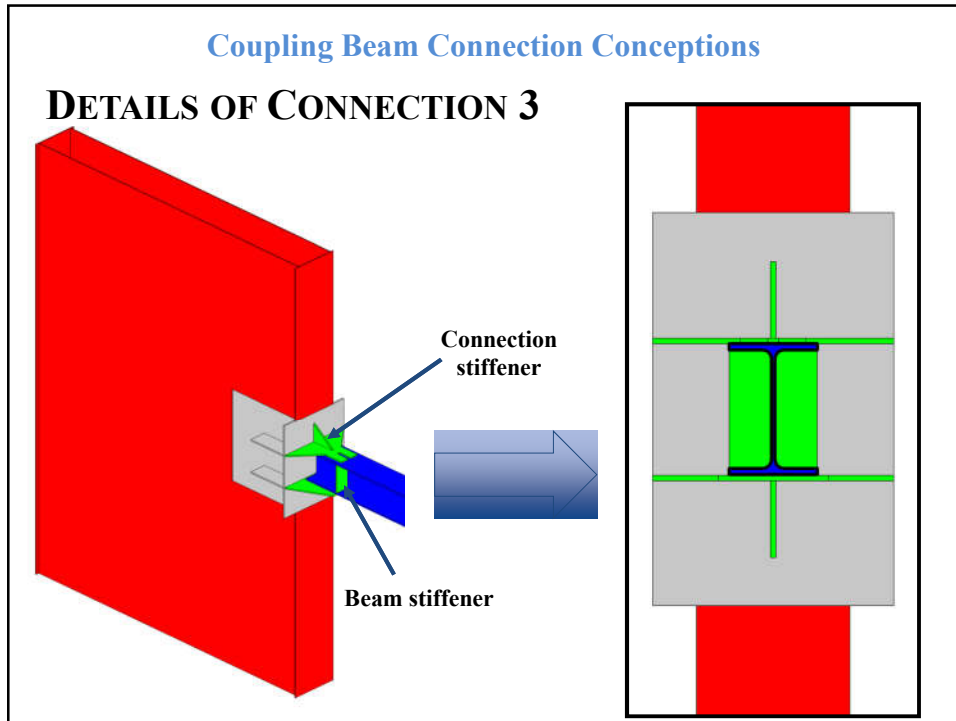

**SUPREME  
GROUP**

# **Fabrication Challenges Core Panels**

**Rainier Square Tower**

**Dave Senio VP of Construction Supreme Group**

*March 20, 2019*

**SUPREME  
STEEL**

**MIDWEST  
CONSTRUCTORS**

**PRO-V  
MANUFACTURING**

# Outline

- ◆ Schedule
- ◆ Design
- ◆ Equipment
- ◆ Potential for Automation
- ◆ Assembly
- ◆ Welding the panels
- ◆ Handling the panels
- ◆ Storage



# Earlier design with anchor rods bolted

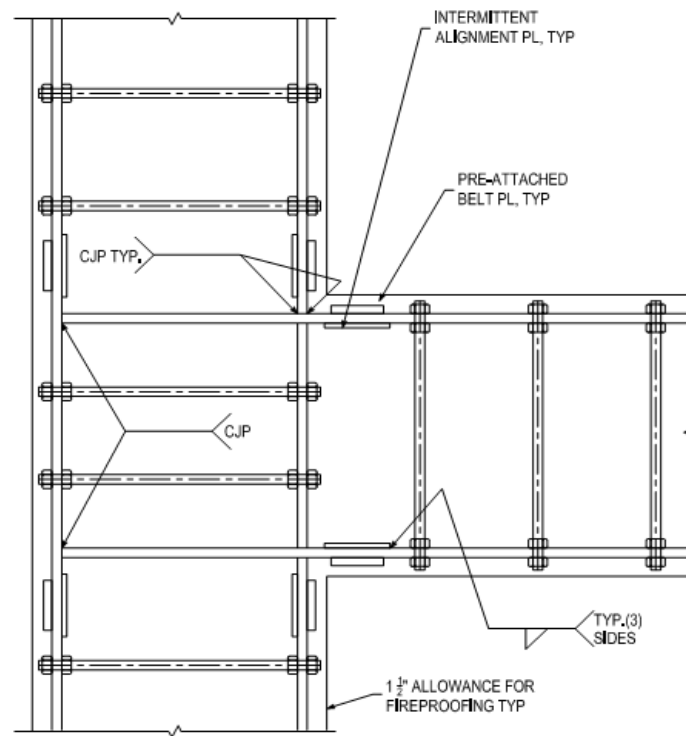



# FEA as designed no bracing

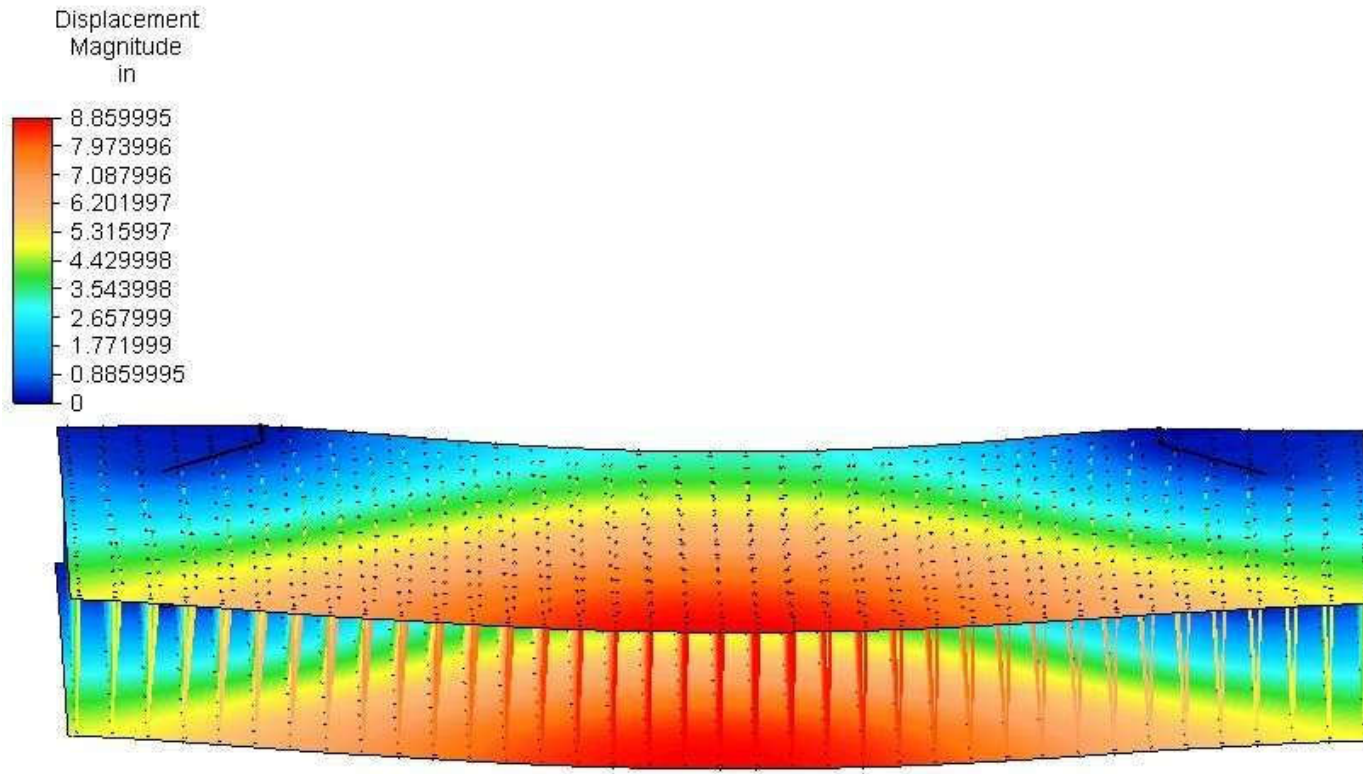

Load Case: 1 of 1  
Maximum Value: 8.86 in  
Minimum Value: 0 in  
2 < Design Scenario 2 >

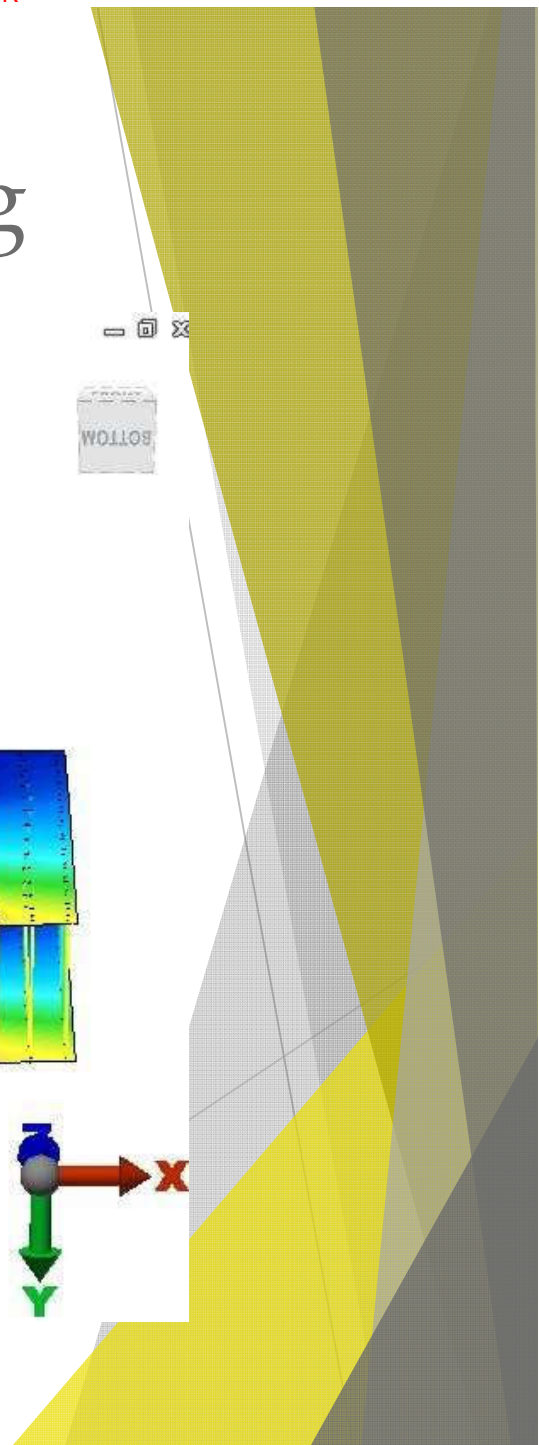
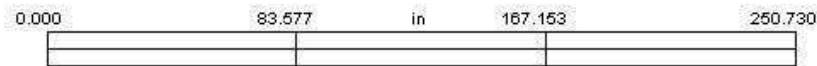

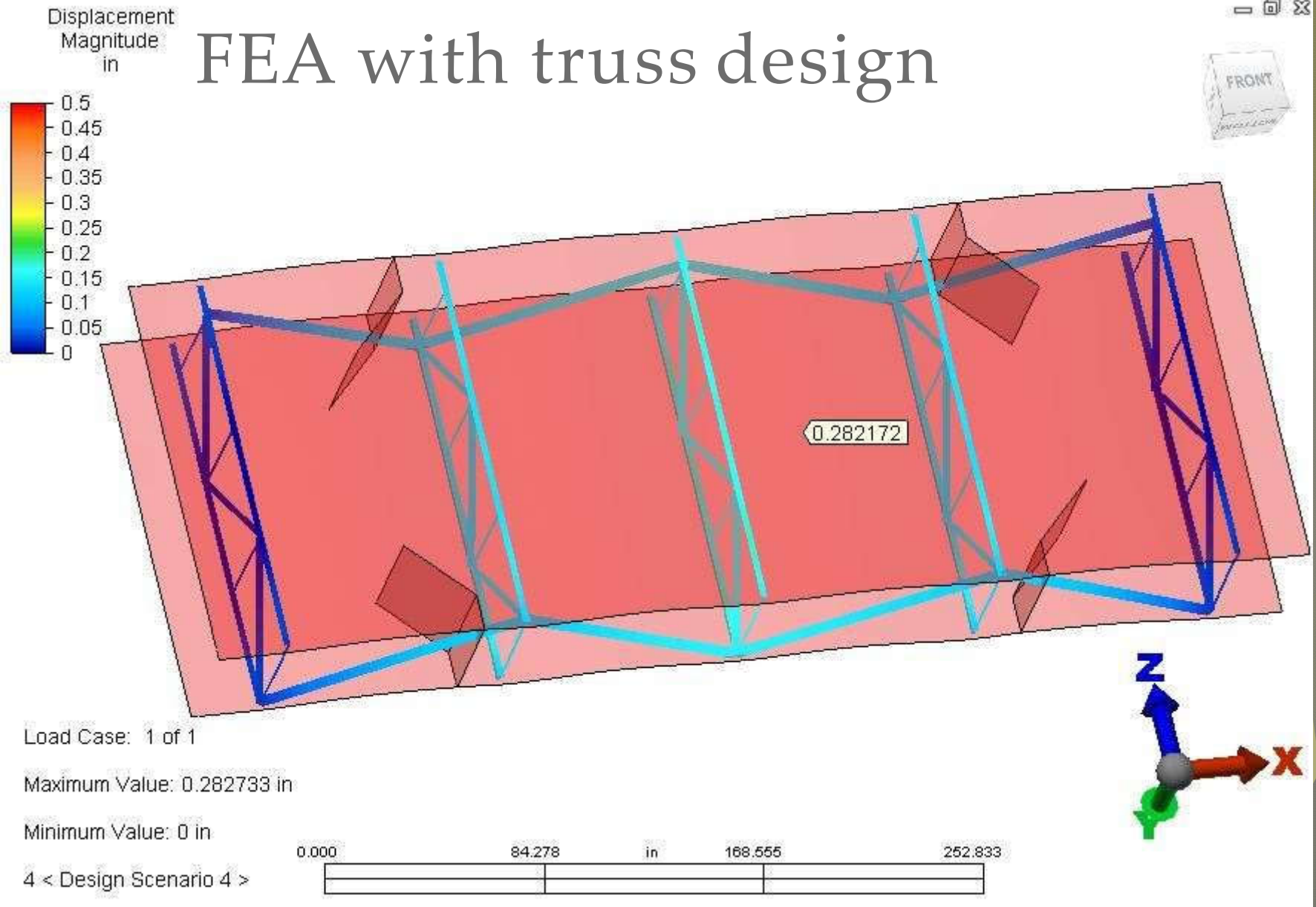



Stress  
von Mises  
lbf/(in<sup>2</sup>)

# Plate stress with trusses

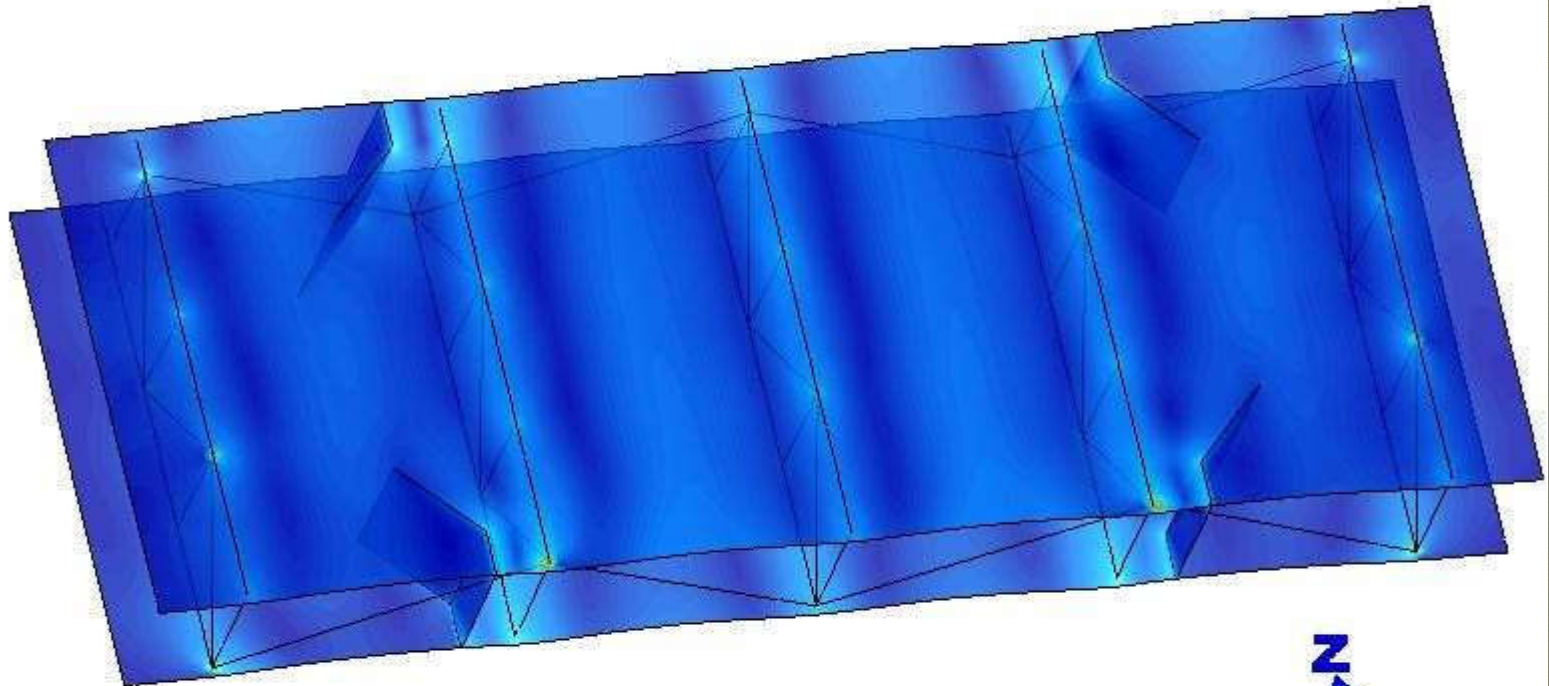
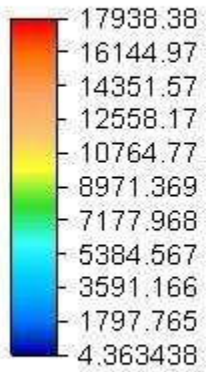

Load Case: 1 of 1

Maximum Value: 17938.4 lbf/(in<sup>2</sup>)

Minimum Value: 4.36344 lbf/(in<sup>2</sup>)

4 < Design Scenario 4 >

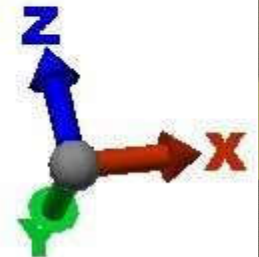
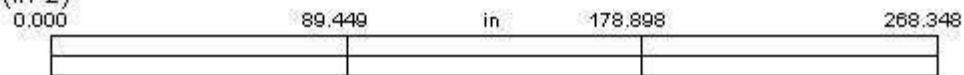

Start with a plate full of  
holes 14 feet x 30 feet

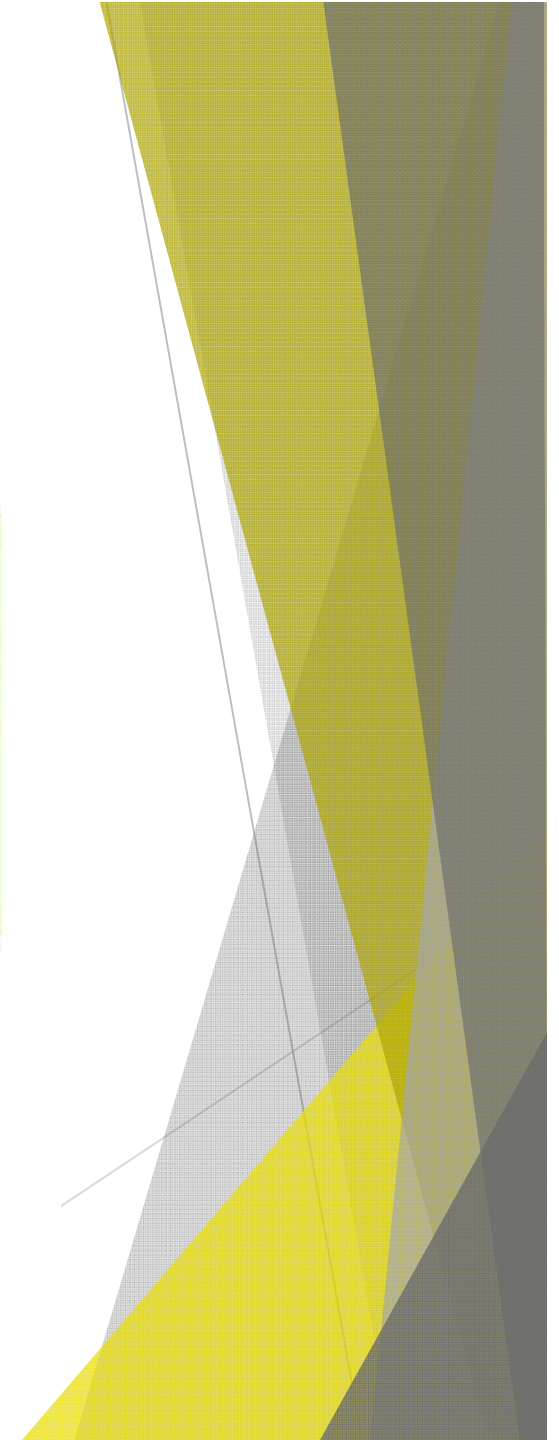
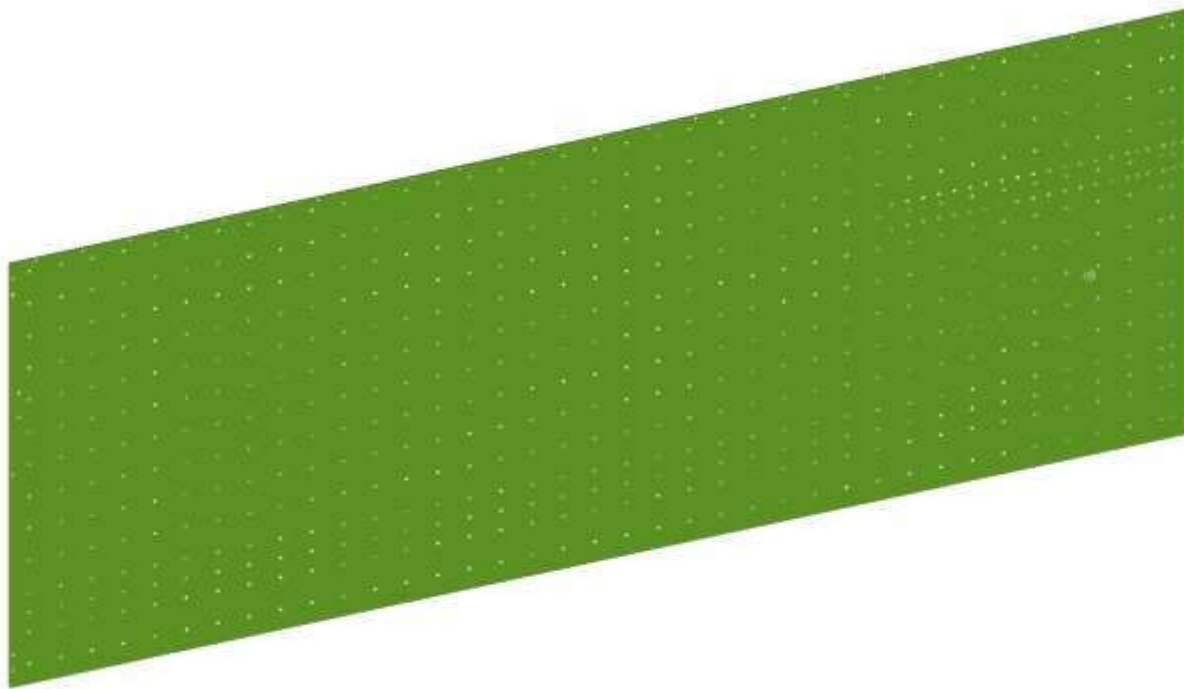



# Add Trusses to keep plates spaced

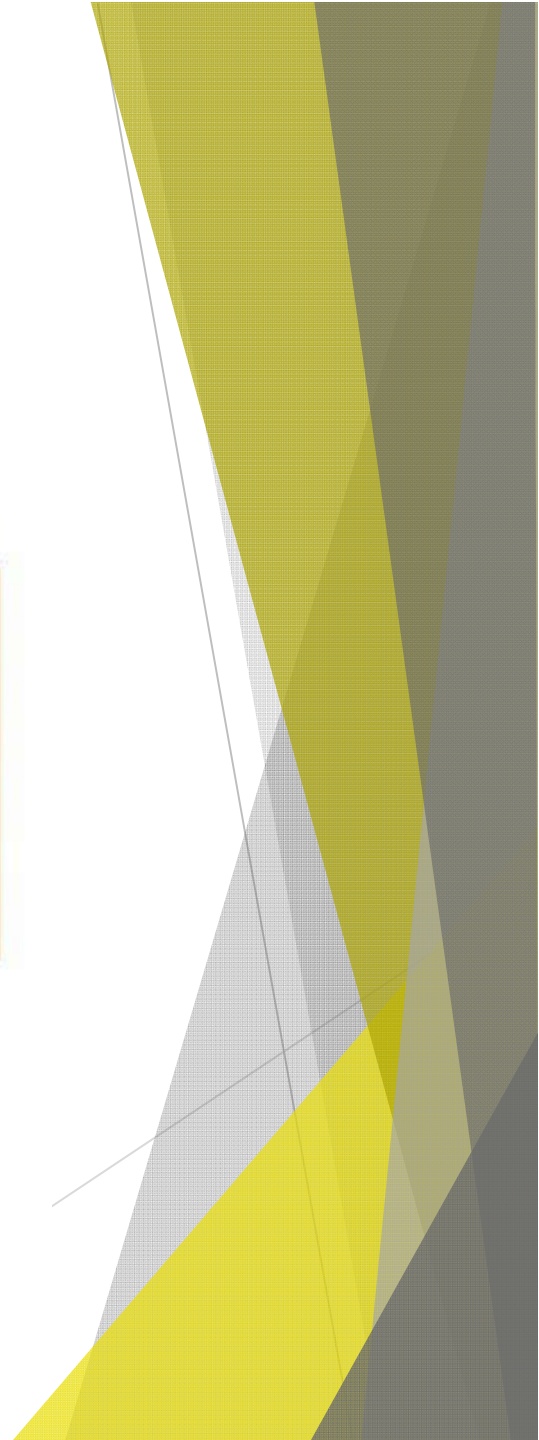
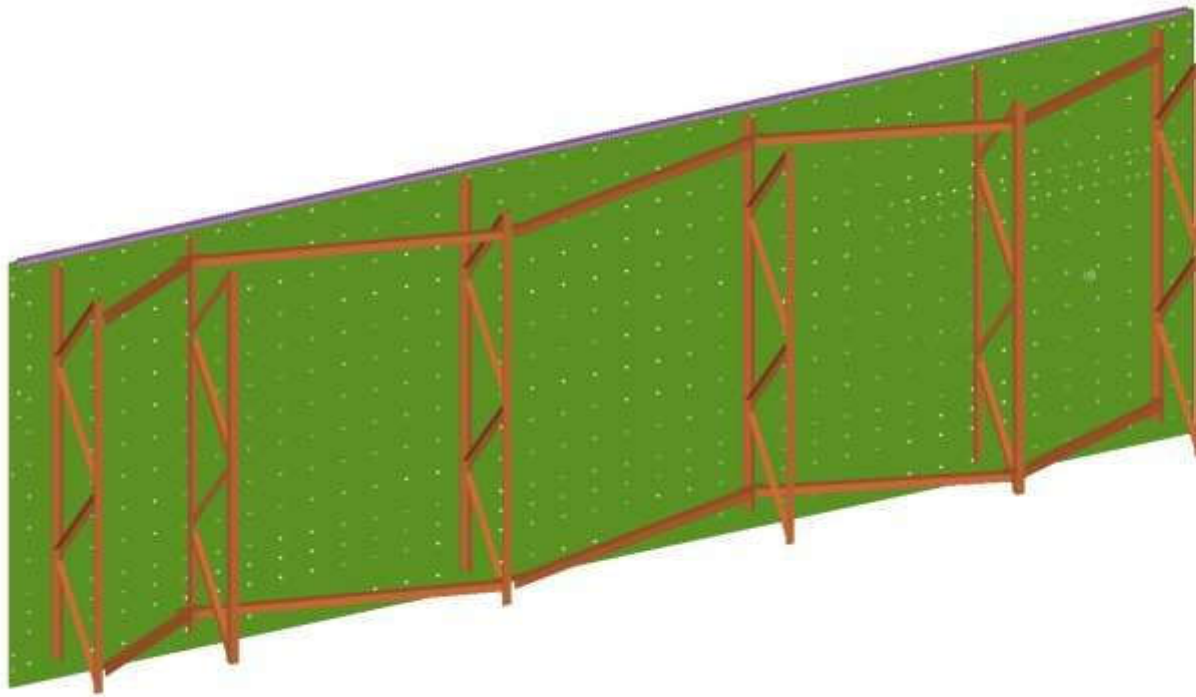



# Add top plate and insert rods

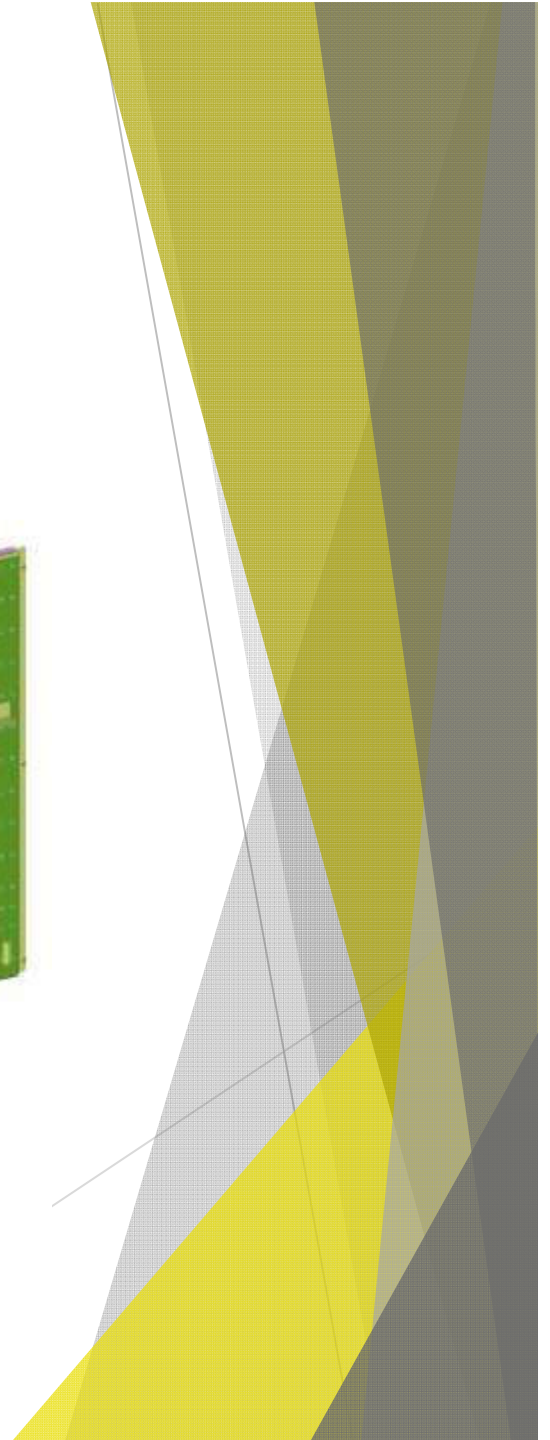
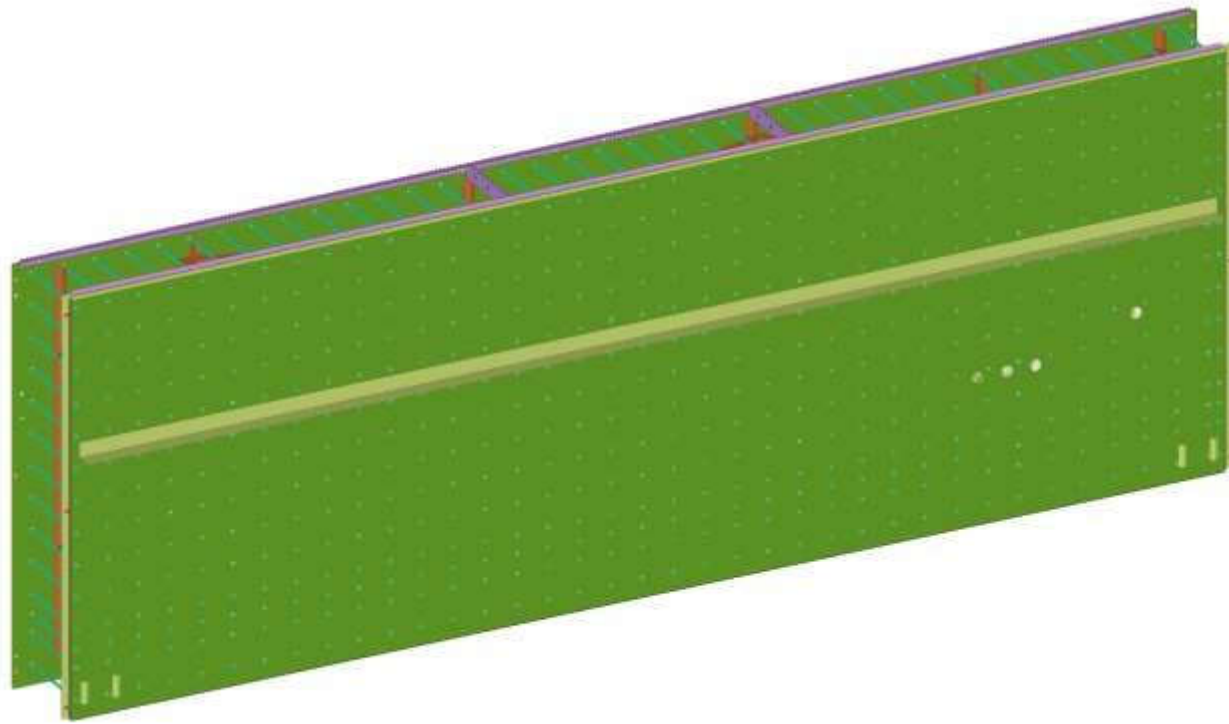

# Equipment Considerations ; conventional Robot with Rotator

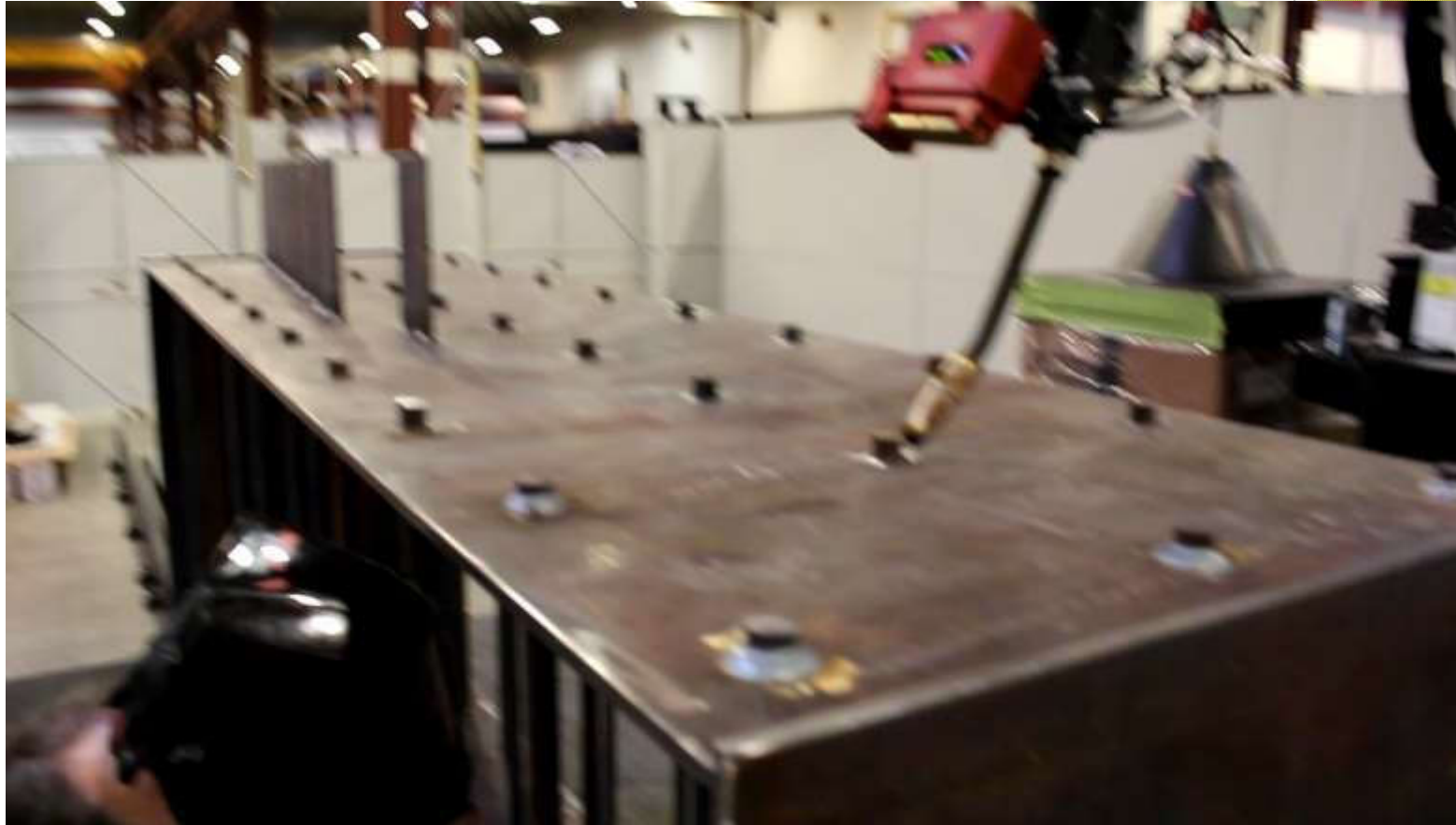



# Concerns/Considerations

- ◆ Space and capacity constraints
- ◆ Extra handling
- ◆ All fitting required to be complete before moved into cell
- ◆ Price
- ◆ Extra modelling
- ◆ Extra Programming if not repetitive
- ◆ Only one setup, if more capacity required
- ◆ Decided to move equipment to work rather than work to equipment

# Wide Plasma table with Beveler 20' x 100'





# Potential For Automation

- ◆ Potential for automation exist for fabrication of panels
- ◆ Supreme Group has been able to develop some custom, in-house, and proprietary systems for panel fabrication
- ◆ Fabricators will find it advantageous to utilize automation wherever possible in the module fabrication process
- ◆ One application recommended to consider for automation is the installation/placement of ties on the Bracing allows for efficient setup

# Completed welds on ties





# Assembly Level floor with $\frac{3}{4}$ " bars at 1-



# Trusses standing vertical





# Assembled panel



# Bolted Lifting lug



- ◆ Welded Lifting lugs needed to stay within the 14' envelope
- ◆ When lifted the bolted lug could not hit plate
- ◆ Offset to aid in turning the panel
- ◆ Same lug could be used in the field



# Turning panel

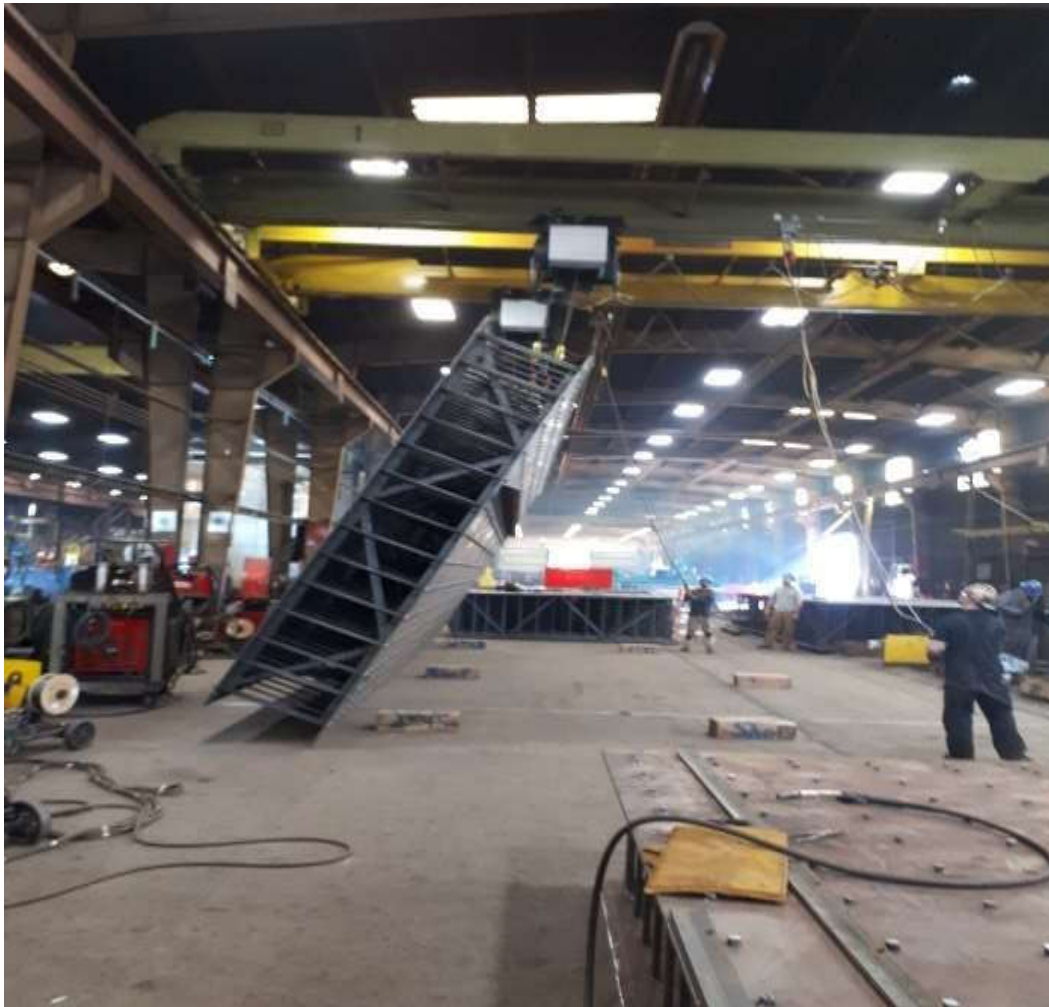

# Storage





# Things to keep in Mind

- ◆ Engineering needs to be complete well in advance
- ◆ Drawings need to be fully coordinated
- ◆ Welding design needs to be considered to reduce the amount of weld deposit where possible  
(Reduce bevels from 45 to 30 degrees?)
- ◆ Consider smaller panel size if practical  
Crane capacity onsite as a limiting factor  
Cost of over dimensional loads (Pilot Cars/Police)  
Logistics of access to site (Permits, Time of day)
- ◆ Area of storage required for backlog
- ◆ Control of distortion ( Panels and Columns)
- ◆ Tolerance in tensile strength of plate for seismic  
(4 times the lead time to order)

# Questions

## Rainier Square Tower

- ▶ Innovative structure
  - ▶ 58-story tower
  - ▶ 850 ft high
- ▶ Represents "proof of concept" for a composite structural-steel frame structure
  - ▶ Reduction of ~40% of time required as opposed to concrete cored structures
  - ▶ ~2% cost savings vs concrete core
    - ▶ \$370-million construction cost
- ▶ Seismic zone
  - ▶ AWS D1.8 in addition to D1.1

<https://www.aisc.org/why-steel/SpeedCore/>

