

A9.8-1

MODERN STEEL CONSTRUCTION

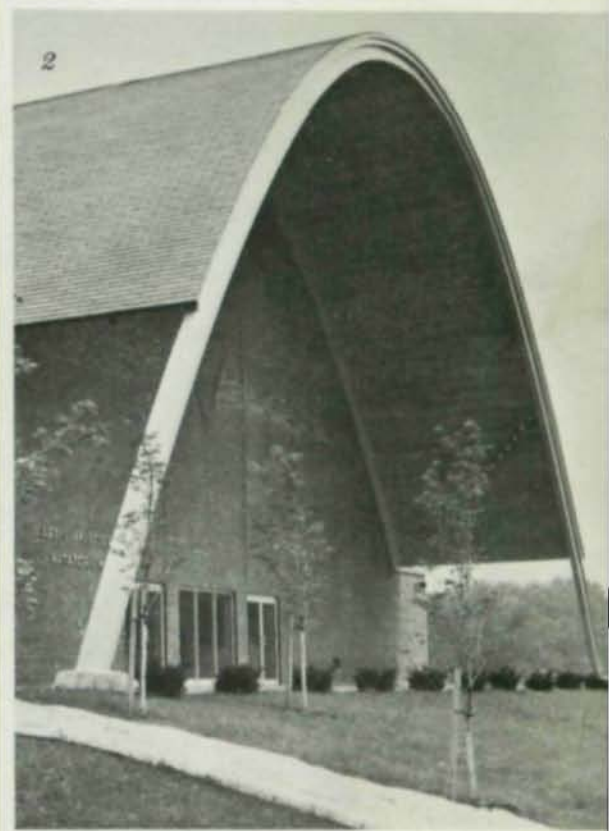

- 1 *Steel Is Ideal For A Library page 13*
- 2 *Natatorium Roof With Exposed Steel Arches .. page 3*
- 3 *Steel And Stucco For A Circular Bank page 6*



MODERN STEEL CONSTRUCTION



VOLUME VIII / NUMBER 1 / FIRST QUARTER 1968

Published by

American Institute of Steel Construction

101 Park Avenue, New York, N. Y. 10017

OFFICERS

Eugene J. Pidgeon, President
Edwin H. Webster, First Vice President
Gilbert M. Dorland, Second Vice President
William R. Jackson, Treasurer
John K. Edmonds,
Executive Vice President
Leslie H. Gillette,
Assistant Executive Vice President
M. Harvey Smedley,
Counsel and Secretary

EDITORIAL STAFF

Daniel Farb, Editor
Daniel M. Axelrod, Asst. Editor

REGIONAL OFFICES

Atlanta, Georgia
Birmingham, Alabama
Boston, Massachusetts
Chicago, Illinois
Cleveland, Ohio
Columbus, Ohio
Dallas, Texas
Denver, Colorado
Detroit, Michigan
Charlotte, North Carolina
Hartford, Connecticut
Houston, Texas
Los Angeles, California
Memphis, Tennessee
Milwaukee, Wisconsin
Minneapolis, Minnesota
New York, New York
Oklahoma City, Oklahoma
Omaha, Nebraska
Philadelphia, Pennsylvania
Pittsburgh, Pennsylvania
St. Louis, Missouri
San Francisco, California
Seattle, Washington
Syracuse, New York
Washington, District of Columbia

CONTENTS

Natorium Roof With Exposed Steel Arches	3
Steel and Stucco For a Circular Bank	6
Low Maintenance and Aesthetics For Interstate Bridge	8
A New Look At High-Rise Apartments	10
Steel Is Ideal For A Library	13
A Tree-like Structure	16

ARCHITECTURAL AWARDS COMPETITION

All architects practicing professionally in the United States are invited to submit entries in the 1968 Architectural Awards of Excellence Competition. Any steel framed building completed after January 1, 1967 and prior to June 1, 1968 is eligible.

Five distinguished architects, engineers, and urban planners will serve as a Jury of Awards. They are:

Harry C. Adley, AIP President, Adley Associates, Inc.,
Urban Planners/Atlanta, Georgia

Sam T. Hurst, FAIA Dean, School of Architecture and
Fine Arts, U. of Southern California/Los Angeles, Calif.

H. Samuel Krusé, FAIA Director, AIA, Florida Region/
Watson, Deutschman & Krusé, Architects and Engineers/
Miami, Florida

Frederick N. Severud Partner, Severud-Perrone-Sturm-
Conlin-Bandel, Consulting Engineers/New York, N. Y.

Wayne Winsor, AIA President, Ellerbe Architects/St.
Paul, Minnesota

Competition rules are available from AISC, 101 Park Avenue, New York, New York 10017. Entries must be post-marked prior to June 1, 1968.

NATIONAL ENGINEERING CONFERENCE

An outstanding program has been arranged for the 20th Annual National Engineering Conference to be held May 2 and 3 in Washington, D.C. Contact AISC, 101 Park Avenue, New York, N. Y. 10017 for details and registration.

SAN MATEO-HAYWARD BRIDGE HONORED

The American Society of Civil Engineers has named California's San Mateo-Hayward Bridge as the Outstanding Civil Engineering Achievement of 1968.

The bridge incorporates 5,542 ft of orthotropic steel deck construction (longest in the world) and its 750-ft central span is the longest unbraced girder span in the Western Hemisphere.

Designer was the State of California Division of Bay Toll Crossings; Murphy Pacific Bridge Builders was General Contractor for the superstructure. MPBB, American Bridge Div. of U. S. Steel, and Kaiser Steel Corp. shared the enormous steel fabrication job (37,500 tons of steel).



Large span roofs always present the designer with difficult economic and aesthetic decisions as to the structural system and material best for the particular project. In designing a natatorium roof the problems seem to increase because of concern over the apparent corrosive environment associated with indoor swimming pools. These challenging problems faced the architect-engineer firm of Munson & Mallis, Inc. when they were given the assignment to design the Art Linkletter Natatorium on the Springfield College campus in Springfield, Mass.

George Mallis is a consulting structural engineer, Springfield, Mass.

Ciprian A. Pauroso is Regional Engineer, American Institute of Steel Construction, Hartford, Conn.

Natatorium Roof With Exposed Steel Arches

by George Mallis
and Ciprian A. Pauroso

The Linkletter Natatorium is part of the college's 10-year Long Range Plan to strengthen academic programs and improve campus facilities. It was planned as an outstanding teaching, research and competitive facility. The \$850,000 cost, which has been fully paid, was kept within reasonable budget limitations by the structural steel system. Students raised the original "down payment" of \$25,000 in a "Work Week". This in turn was supplemented by alumni gifts and by entertainment personality Art Linkletter, the leader in the campaign for the needed facility.

Steel Arch Most Suitable

The use of an arch roof for the Natatorium was originally suggested because architecturally it blended with the exist-

ing arch-roofed Field House nearby. The arch form also efficiently provided the needed height over the diving boards. The preliminary design called for structural steel arches with wood planking spanning between the arches. Concern about possible corrosion of the steel and questions about the aesthetic blending of steel and wood suggested the investigation of wood arches. Although the cost of the all wood system was approximately the same as the steel and wood system, it was not as aesthetically pleasing. The larger wood arches lost their gracefulness, becoming overpowering and obstructing the view. The college, not satisfied with the apparent high cost, commissioned an independent estimate of a rectangular flat roofed building using longspan joists. The height re-

quired for the exterior walls and the larger volume enclosed increased the estimated cost of this building to \$25,000 more than the arch structure.

The main roof of the Natatorium, which is 234 ft long by 109 ft wide, consists of laminated wood 5-in. T & G matched planking covered with asphalt strip shingles. The planking is attached to 13 parabolic steel arch frames anchored to reinforced concrete buttresses. The graceful arches rise to 45 ft at their peaks and weigh four tons each. Variable in section, the arch is 22½ in. deep from the base to a 30-ft height, then tapers to a 14-in deep section at the peak. The arches were fabricated from cut plates of A36 steel, the webs cut out of rectangular plates and the flanges bent to the curve. The arches

Steel arches were fabricated, shipped and erected in one-half sections. Spacer braces were removed after installation of roof planking.





Exposed steel arches provide a graceful frame for indoor swimming pool. Repainting will not be required for 8 to 10 years.

were fabricated and shipped to the site in one-half sections.

The absence of purlins and other steel bracing made the erection of the arches rather "tricky", but the structural engineer and the fabricator worked out a relatively simple system of erection. The center arch was erected using two cranes, one for each half. A high strength bolted splice was then made at the peak, and the arch was plumbed and braced in its final position. The other arches were then erected as the first, one at a time, progressing from the center and using the center arch as a brace. Temporary steel angle spacer braces were installed between the arches; these braces were removed as soon as the wood planking was attached to the arches.

Paint System

To protect the exposed steel arches, a carefully specified paint system was adhered to. After a thorough shop cleaning of the steel, one shop coat of a chemical primer of 2 mils was applied. The field painting consisted of two coats of Chlorinated Rubber Paint, each coat 2 mils dry, resulting in a 6 mils total coating of paint. It is expected repainting will not be required for 8 to 10 years. As a bonus, the corrosive environment in the building is much smaller than usual, due to a low 45% relative humidity, air temperature of 85°F, and water temperature of 81°F. This condition has resulted because the pool water is not heated directly, but is warmed by the heated air. This is a departure from the normal operation of indoor pools.

The Linkletter Natatorium houses one of the longest indoor collegiate pools in the East. A movable steel bulkhead at one end allows for adjustment of length to meet national and international competitive meet requirements. Springfield College is justly proud of this new facility, one of the finest in the country. The steel arches certainly contribute to one of its finest features, a most aesthetically pleasing column-free interior.

Munson & Mallis, Inc. of Springfield, Mass. were the architect-engineers assisted by Professor Charles R. Bissey of University of Massachusetts, design consultant for the arches. The General Contractor was Ley Construction Co. of Springfield, Mass. The steel arches were fabricated and erected by Haarmann Steel Company of Holyoke, Mass.



Steel framing and a steel stud and stucco curtain wall provided the most economical construction for second floor cantilevered walls.

Steel and Stucco For A Circular Bank

Repetitive use of identical steel members reduced fabrication and erection costs.



The versatility of steel construction is demonstrated daily in the wide variety of building types and shapes designed and built with structural steel framing. In some buildings the steel frame is boldly expressed as part of the architectural concept. In others, steel is selected primarily for economic reasons, though other materials might seem more logical before a thorough analysis is made.

From the time architect Siegmund Spiegel of East Meadow, N. Y. first received the commission to design a small branch building for the Reliance Federal Savings and Loan Association in Albertson, N. Y., he felt that a round shape would be the ideal solution. A round building was not only functional, it also offered attractive vistas from all streets approaching the busy intersection at which the odd-shaped corner site was located.

Both the curved shapes and the design of the second floor exterior walls seemed to call for concrete or masonry. Careful studies, however, showed that a steel frame and a lightweight steel stud and stucco curtain wall provided the most economical construction for this 80-ft diameter structure.

According to the architect, both precast concrete and masonry with applied finish proved economically unfeasible for the second story exterior wall. The final design consisted of 6-in. steel studs, wire lath on both interior and exterior, insulation between the studs, plaster interior finish, and Portland cement stucco on the exterior with marble chips set into an epoxy matrix. The window surrounds were formed on the job of wire lath and stucco. The second floor fixed glass windows were set in flexible butyl glazing strips anchored into the metal stud window surrounds.

The steel framing for the circular building was extremely simple. Six interior columns, equally spaced on a 41'-4" diameter circle and thirteen exterior columns on a 78'-6" diameter circle support a series of 10B11.5 radial beams which frame the roof. The girders form chords of the circles on which the columns are spaced, and the radial beams

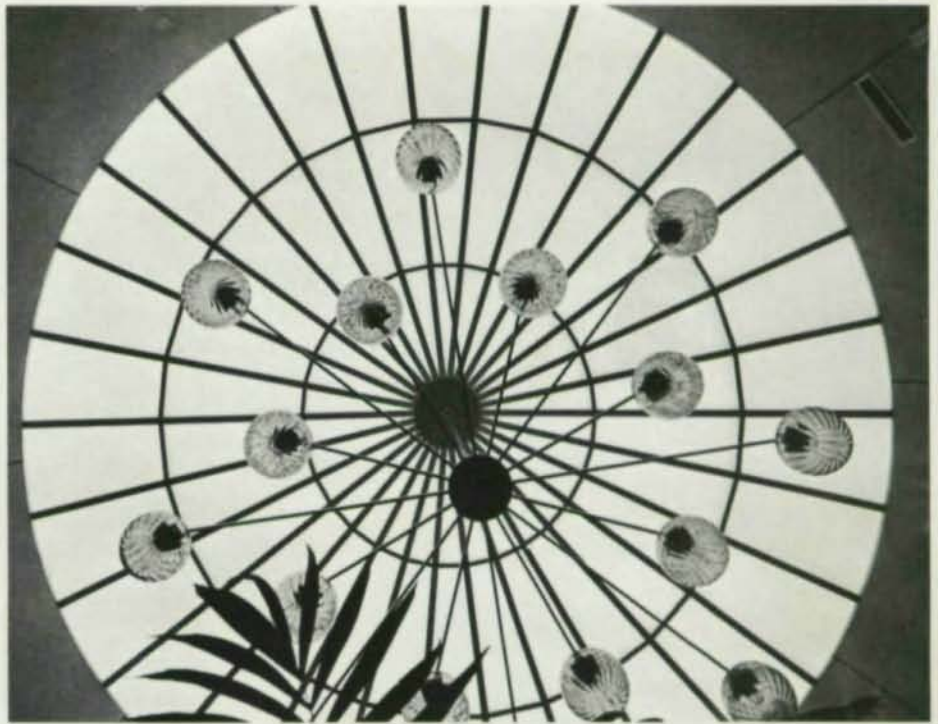

Rotunda, topped by sky dome, adds spaciousness and light over main banking floor.

cantilever over the girders to the circular periphery of the building and the interior open circle of the rotunda. A continuous $\frac{1}{4}$ x 10" steel plate caps the roof framing at the rotunda, and straight 6[8.2 members between the ends of the radial beams closely follow the circular exterior shape of the building. Floors and roof are steel decking with a 2½-in. concrete slab.

The first floor, housing the main banking complex, is 68 ft in diameter. The upper floor, housing offices around the periphery, is cantilevered 6 ft beyond the first floor. A 30-ft diameter rotunda, topped by a sky dome, pierces the sec-

ond floor and provides a feeling of spaciousness and light to the main banking floor. A chocolate brown brick curved pylon wall at the entrance houses a vault, stairs, a board room, and mechanical components of the building. The pylon extends above the roof sufficiently high to screen from view the cooling towers and flues, giving the building a clean, unencumbered appearance.

Architect: Siegmund Spiegel, AIA, East Meadow, New York

Structural Engineer: Thompson and Czark, East Meadow, New York

General Contractor: Glenwood Construction Corp., Glen Head, New York

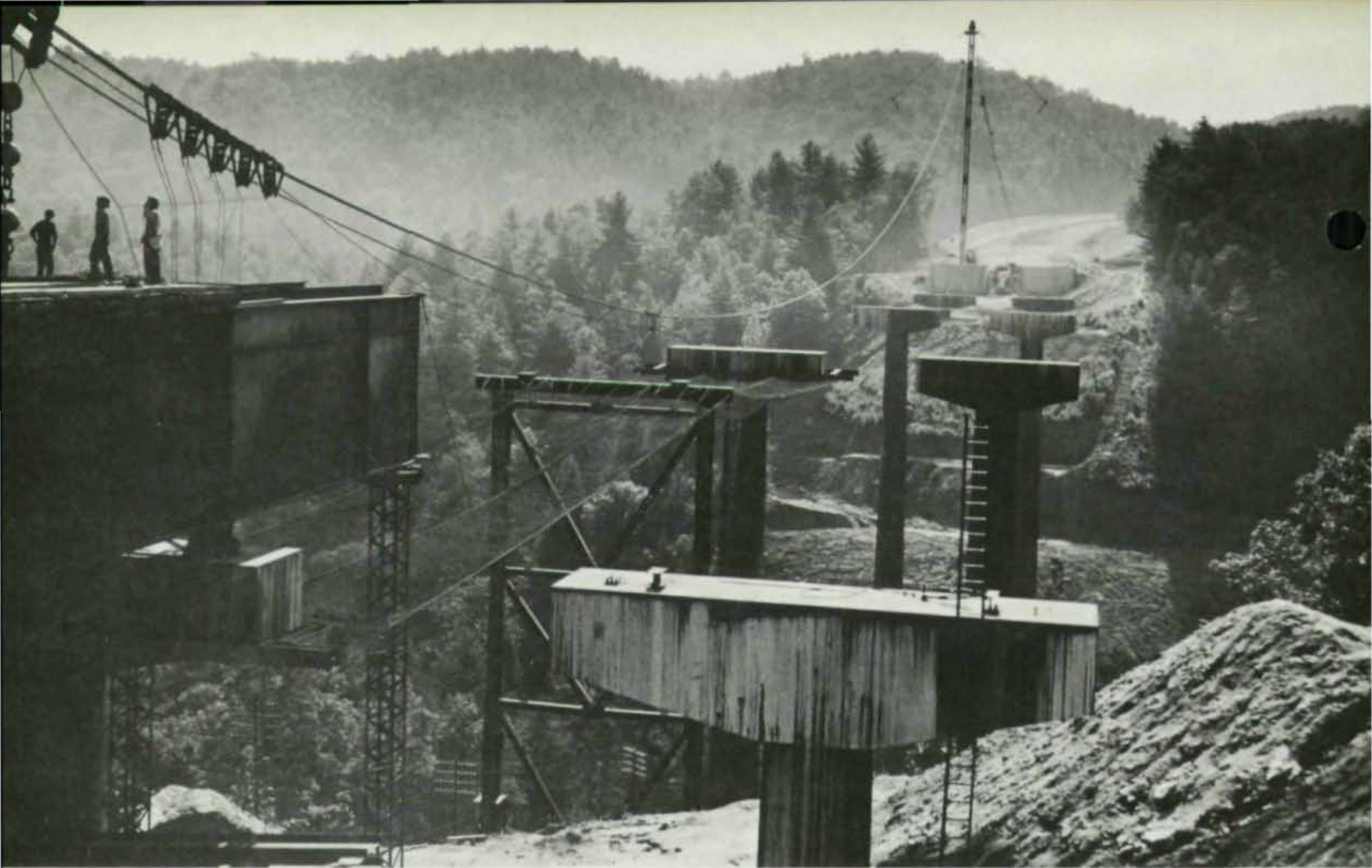

Corrosion-resistant steel will permanently "paint itself", eliminating the need for maintenance in difficult terrain.

Low Maintenance Plus Aesthetics

by R. Gene Ellis
AISC Regional Engineer
Charlotte, North Carolina

Interstate Route I-26 crosses Green River near the town of Saluda, about 30 miles south of Asheville, North Carolina. The stream is small, but the highway grade across the gorge is 200 ft above the stream bed. A \$2.28 million dual bridge, consisting of a continuous span unit of 260-330-260 ft flanked by a 100 ft simple span on each end for a total length of 1,050 ft, was determined by engineers of the North Carolina State Highway Commission to be most economical for the crossing.

Because of maintenance problems in painting a structure of this height, unpainted corrosion-resistant high-strength steel was selected for the superstruc-

ture. This steel was specified to meet the requirements of ASTM A242-modified; the modifications were requirements of special weathering qualities, corrosion resistance, and weldability.

Although no plans have yet been proposed for a scenic overlook or park, the possibility of such a later development near the site made aesthetics as important a design factor as low construction and maintenance costs. With this in mind, the Highway Commission prepared drawings illustrating several bridge types, to determine which might be most attractive. A 14-ft deep parallel flange welded plate girder bridge was chosen because of clean and simple

lines and its harmony with the general surroundings.

It was decided to prepare a scale model for a more detailed study of piers, abutments, and general proportions of the structure. Piers of uniform diameter for the full height, of stepped variable diameters, and of uniform taper were studied. A uniform taper design was selected.

Piers Also Corrosion-Resistant

Knowing that the corrosion-resistant steel selected for the superstructure would behave much the same as unpainted A36 steel for the first year or so, it was realized that concrete piers would

become severely rust-stained. Methods and costs of pier cleaning were first studied; this logically led to consideration of a thin-walled steel shell of the same type of steel selected for the superstructure. Several prospective contractors were consulted for their opinions regarding the use of permanent steel forms instead of removable forms, and all were very receptive to the idea. Safety during construction was a very important factor in favor of the permanent forms. It was decided to require a 5/16-in. thick shell for the higher piers and to utilize 1/8-in. of the steel shell thickness to replace a portion of the reinforcing steel. The contractor was given the option of using a minimum 3/16-in. shell for the shorter piers where its use as reinforcing steel was not important. Actually, the contractor chose to use the 5/16-in. thickness throughout. Before

finally specifying the uniformly tapered pier columns, the North Carolina Highway Commission was assured by tank manufacturers that the tapered sections would present no problem in fabrication. The higher piers are 133 ft high from top of footing to bottom of pier cap, 13 ft-17/8 in. diameter at the base, and 9 ft-0 in. diameter at the top. Steel shells were also used for the pier caps.

Erection

Erection of the superstructure is now well under way. Completion is scheduled for June, 1968.

A suspended cable system is being used to erect the steel girders. The cable system is supported by two 150-ft high masts at 1,120-ft centers, with backstays anchored 750 ft from the masts. Side guys extend to as much as 340 ft from the masts.

Lightweight concrete will be used on the continuous span unit of the bridge. The dual structures will have 28-ft wide roadways, 2-ft wide curbs, and aluminum rails. The design loading is HS20. The entire surface area of the steel spans and the piers are to be blast cleaned after all concreting operations have been completed, so that a uniform oxidation can be obtained to complement the natural setting of the bridge.

Structural Engineer: North Carolina Highway Commission, Raleigh, N. C.

General Contractor: Wannamaker and Wells, Inc. Orangeburg, S. C.

Fabricator:
 Superstructure: American Bridge Div., United States Steel Corp., Ambridge, Pa.
 Substructure: Buffalo Tank Div. Bethlehem Steel Corp., Charlotte, N. C.

For Interstate Bridge

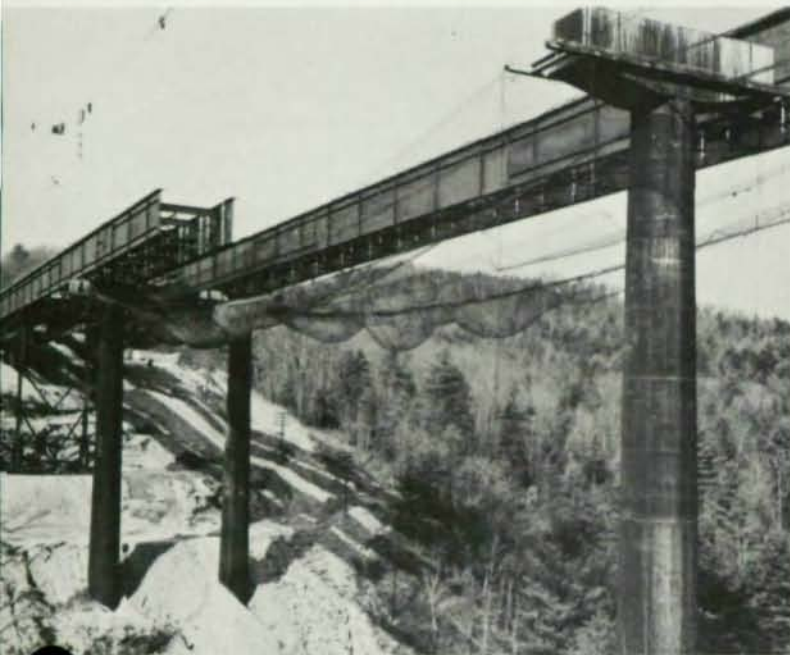

Aesthetic studies led to the choice of a welded plate girder bridge with uniformly tapered piers. Corrosion-resistant steel shells serve as permanent forms for concrete piers.

A New Look At High-Rise

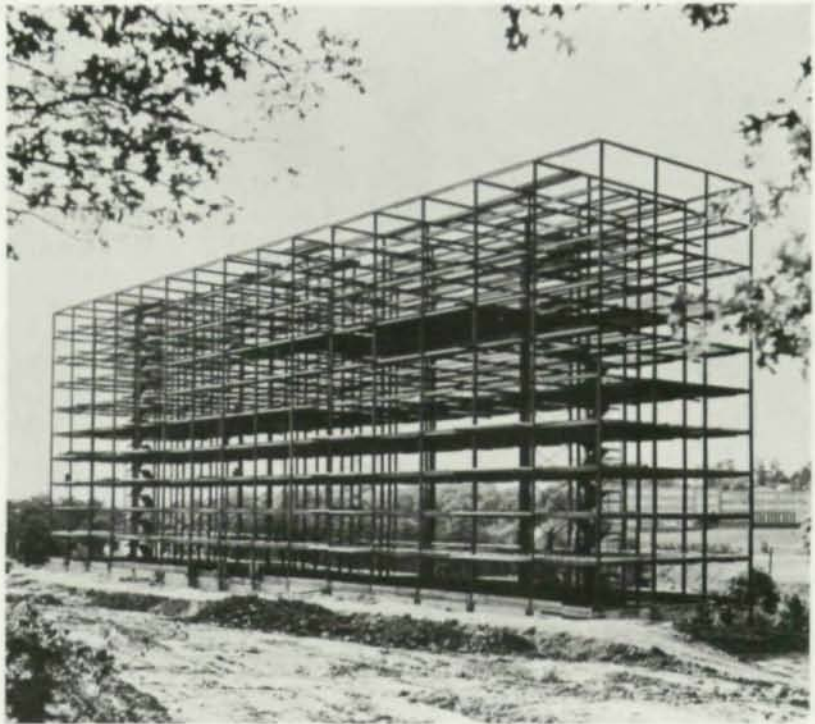

First plastically designed multi-story building is 11-story apartment house in Bladenburg, Md. (See MSC, 3rd Quarter, 1967).

Within the past two years, several spectacular developments in the design of steel-framed high rise apartment buildings have occurred. These new design concepts promise to replace older design methods because they offer sizable cost savings.

For the most part, these new developments are based on a "systems" approach to design and construction. The premise for this approach is that the most economical building can only be determined if all factors are considered. For instance, a particular framing scheme may not be the least expensive by itself, but when considered with mechanical, electrical and architectural features could provide the most economical solution. The entire "system" must be evaluated before a valid decision regarding the framing can be made.

Dry Floor System

At the 1966 AISC National Engineering Conference, Joseph H. Newman, vice president of Tishman Research Corp., announced the development of a dry floor system of construction for high rise apartments. He estimated a savings of about \$0.58 per sq ft compared to flat plate concrete. Basically the system consists of water-resistant 2-in. metal-edged gypsum plank on open-web steel joists spaced 4'-0" on center.

The first project using this system is now under construction in Pittsburgh. The architect, Joel R. Hillman of Chicago, estimates a total cost saving of about \$500,000, pared from an original \$7-million for a conventional flat plate concrete system. The structural engineer, William Schmidt of Chicago, states that dead load is decreased 40 percent.

Apartments

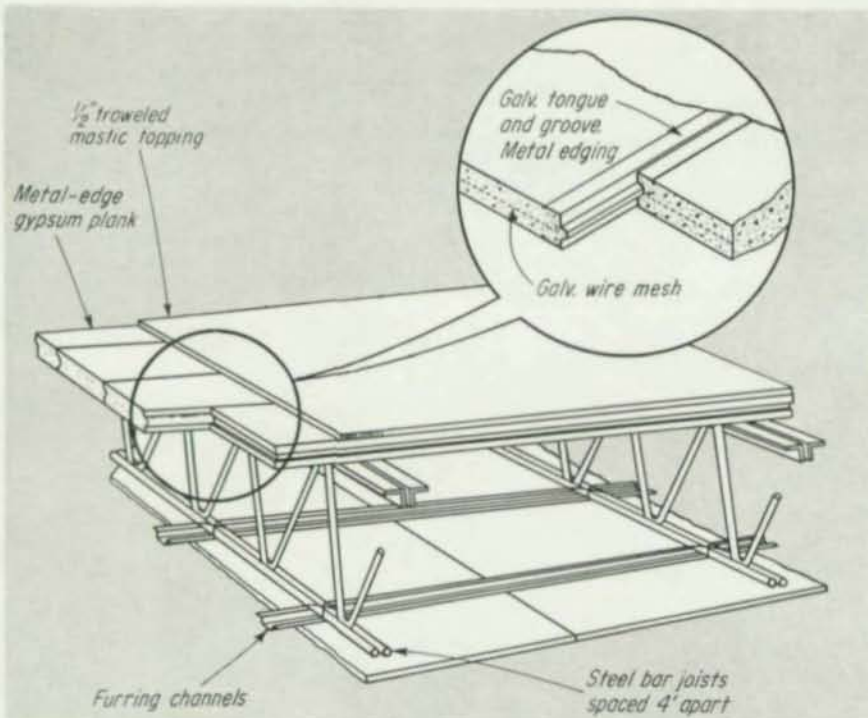

Reprinted from Engineering News-Record. All rights reserved.



New 19-story "dry floor" apartment building is now under construction in Pittsburgh.

The key to this drastic dead load reduction is the gypsum plank, which weighs only 18 psf.

United States Steel Corporation and United States Gypsum Company have run tests on the gypsum plank welded as a diaphragm. The results of these tests have been published in the January, 1968 AISC Engineering Journal.

Kelly & Gruzen, New York architects, have developed an adaptation of the Tishman scheme for residential buildings under six stories. In this dry floor system, 4½-in. cellular deck spans between girders of double angle or tee sections to support the gypsum plank floor. The tee-shaped girders are enclosed in interior partitions to eliminate the usual boxing and furring. Although this system has not yet been used in actual construction, estimates indicate that in the

New York area a structure could be built for as low as \$8.18 per sq ft including all costs except site work and foundation.

Staggered Truss System

Another scheme announced at the 1966 AISC National Engineering Conference was the "Staggered Truss System," developed by MIT under a grant from United States Steel Corp. Consulting engineer William J. LeMessurier of Boston described this method of framing high rise structures; story-high trusses span the width of the building, laid out in a staggered pattern, so that although trusses on each floor are 24 ft apart the floor is required to span only 12 ft. The floor rests on the top chord of one truss and hangs from the bottom chord of a truss 12 ft away on the floor above. The

trusses on any one floor are 24 ft apart. Looking at the long side of the building, the pattern of trusses looks like joints of brickwork.

The first project using this system will be a 17-story, \$2.3-million low-cost housing project for the elderly in St. Paul, Minn. In this structure, architects Beigstedt, Wahlberg and Wald, St. Paul, and engineer Harold Bakke, originally of Schoett-Meier and now with Bakke & Kopp, Minneapolis, expanded the truss spacing from 12'-0" to 28'-8" to gain flexibility in individual apartment layout and window location.

The building structure weighs just under 7 psf, compared to 9 psf for a braced frame and a probable 12 to 13 psf for a column-girder portal frame. The bid steel price was extremely low: \$288 per ton plus \$64 per ton for erection.

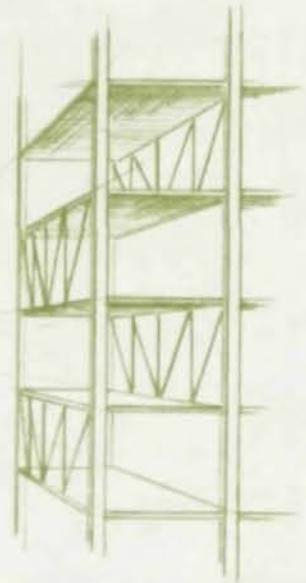
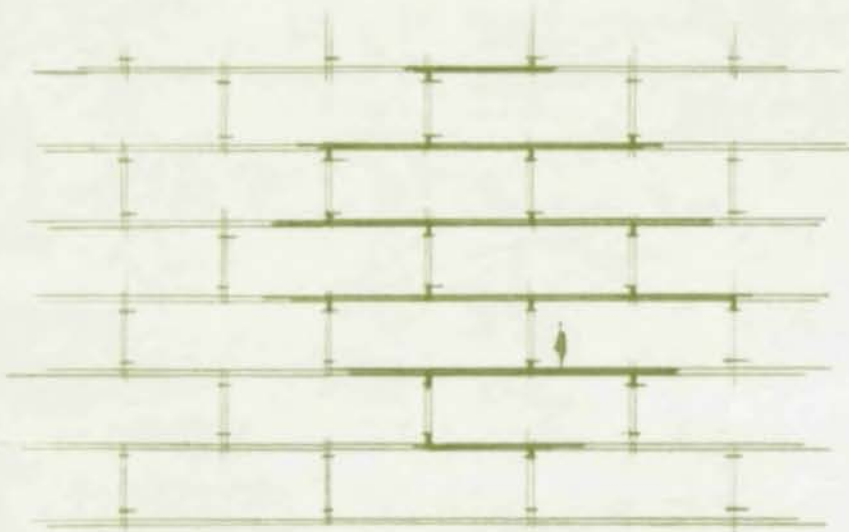

Low-cost housing project in St. Paul will feature "staggered truss" system developed at MIT.

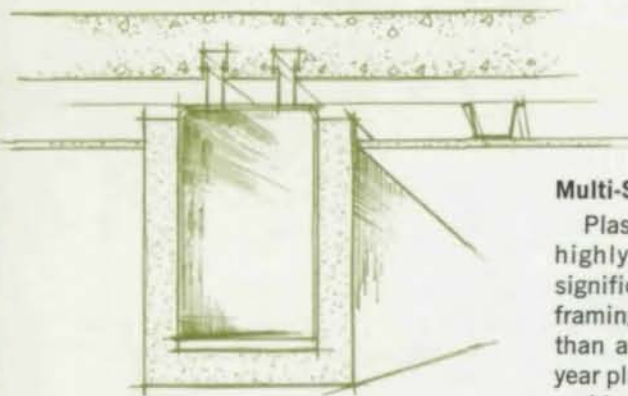

Hollow beams carry conditioned air in new "structural duct" system.

Multi-Story Plastic Design

Plastic design of steel structures, a highly efficient design method that significantly reduces the weight of steel framing, was introduced in the U.S. more than a decade ago. However, until this year plastic design was restricted to one- and two-story structures. In 1966 design criteria were established for the use of this method in multi-story buildings.

Nearly completed in Bladensburg, Md. is the nation's first plastically designed high rise building—the 11-story Stevenson Apartments. Structural engineer Horatio Allison, Silver Spring, Md., utilized high strength steels in his design to reduce framing costs by approximately 10 percent. More significantly, the cost for the steel frame, deck, lightweight concrete topping, and a plaster-board ceiling amounted to \$1.91 per sq ft, a saving of 10 percent from the \$2.10 per sq ft estimated for conventional flat plate concrete construction.

Structural Duct System

A new concept in building systems, developed by architect-engineers Reid & Tarics, promises to provide significant economies in high rise residential construction. Steel "box" beams serve as both structural framing members and horizontal ducts for heating and air conditioning. The box beams work in composite action with a concrete diaphragm on a metal deck. Columns will be standard wide flange sections.

All beams, regardless of span, have the same overall depth. Differences in span are accommodated by varying the lower-flange plate thickness from $\frac{3}{8}$ -in. to $\frac{7}{8}$ -in. for spans of 8'-4" to 35'-0", respectively. A $1\frac{1}{2}$ -in. corrugated metal deck provides the concrete form and positive reinforcement. Welded studs provide the shear connection. All electrical and mechanical requirements are integrated, making this a classic "systems" design.



Steel roof trusses and bracing, fireproofed with lightweight cement plaster, create an unusual sculpture in space over the main reading area.

Steel Is Ideal For A Library

by Matthew Robert Leizer, AIA
and Edward R. Stewart

Steel proved the ideal framing material for the new main Public Library in Santa Monica, California, a building which presented many design challenges. The foremost challenge was to meet all functional and aesthetic needs within a limited budget. A relatively simple system of steel trusses provided the perfect framing solution. It went beyond just meeting structural needs and accommodating the various architectural and mechanical elements. Steel was used to create many of the unique advantages of this building, including an exciting overhead sculpture and an attractive and useful V-type ceiling. Furthermore, the selected steel framing system, recommended by the engineer as the most economical, helped keep the building cost well within the budget.

Matthew Robert Leizer is the Principal in the architectural firm of Matthew Robert Leizer, AIA, Los Angeles, Cal.

Edward R. Stewart is Regional Engineer, American Institute of Steel Construction, Los Angeles, Cal.

Architectural Features

The modern two story structure is at a busy downtown intersection of the ocean front city. It replaced a 60 year old, outdated building. Completed and occupied in 1965, the impressive new structure has been of outstanding value to the community, both as a showpiece and a service facility. The library has drawn many new visitors and increased patronage. The efficient layout allows vastly improved service and provides almost double the area of the old facility, yet it required no increase in operating staff. The ground level and second floor house the library functions. Flow of patrons is directed through a central check stand at ground level. The supervisory personnel are centrally located to command a full view of the book stacks. A large basement area houses a fallout shelter, auditorium and an employee parking garage.

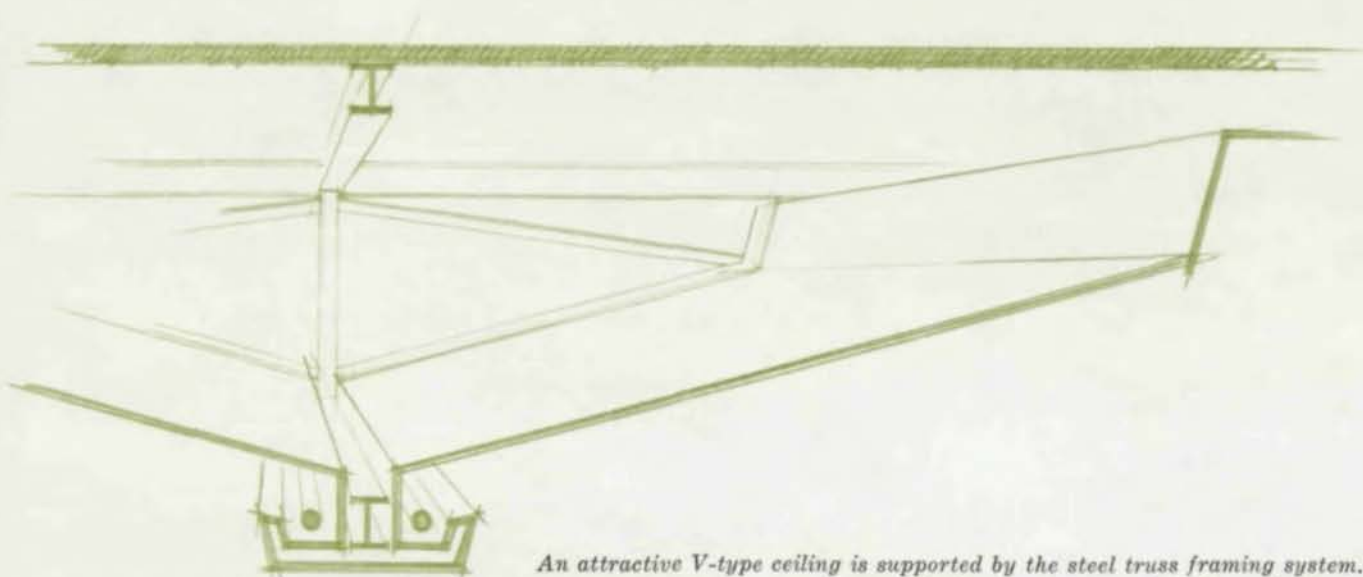

An attractive V-type ceiling is supported by the steel truss framing system. Air conditioning ducts are carried above the sloping ceiling.

One design goal was to create an open, spacious quality to the building interior. This was accomplished with dramatic effect even though the structure has only minimal window area. One-third of the two-story building has no second floor, but is instead an open well extending from the ground floor to the roof. A second floor balcony projects into the well on three sides and is used for art exhibits. The ground floor of the well accommodates current book shelves and the main reading area. An indoor patio is on the fourth side, opposite a busy street. Adjacent to the patio, a decorative concrete grille extends the full height of the well and forms the exterior wall. Considerable natural light enters through small glass panels in the grille.



Steel Trusses Create Sculptured Ceiling

To further enhance the well area, the steel trusses and bracing were used to create a sculpture in space. Instead of being hidden by a fireproofing membrane, truss and bracing members were fireproofed directly with lightweight cement plaster. The result is an attractive three-dimensional lattice structure. Pre-welded bracing assemblies give a decorative geometric flair to the lattice. The roof deck and supporting joists and purlins are four feet above the top of the trusses and separated from the well by a fireproofing membrane of lightweight cement plaster. Natural light filters through the lattice from numerous skylights in the roof.

Throughout the remainder of the building, at the first and second floor levels, the steel framing was invaluable in implementing the pleasing and very functional V-type ceiling. The ceiling is in effect a series of folded plates with a low edge under each truss and a high edge between the trusses. Truss braces extend diagonally up from the bottom chord of each truss to form convenient support for the ceiling.

The ceiling has several distinct advantages. It has excellent acoustical qualities, contributing significantly along with the carpeting to dampen noise within the building. Also it eliminates the light glare problem common to flat ceilings, even where recessed fix-

tures are used. Glare often originates from lights in adjacent bays. In this building the light fixtures are at the high point of the ceiling midway between trusses. The downward sloped ceiling on each side of the fixture prevents direct light rays from entering adjacent bays. A cove light under each truss provides supplementary indirect lighting. Ample room is provided above the ceiling for air conditioning ducts.

Steel Framing

Framing throughout the second floor and roof consists of steel trusses on steel columns. Three rows of trusses, at the second floor and roof level, span 35, 50 and 35 ft in tandem across the 120-ft

width of the building. The trusses form eleven 20-ft bays making up the 220-ft building length. Five second floor trusses spanning 50 ft are omitted at the south end of the structure to form the well. Both the second floor and roof are 26 ga. steel deck with a concrete filler slab. At the second floor, steel purlins span across the trusses to support the deck. At the roof, the deck and supporting steel beams and open web joists are raised 4 ft above the trusses. Short pipe columns extend from the top chord of the truss up to the beams running parallel to each truss. These beams support the joists and deck. A modified type of K-bracing is used to stabilize the trusses. The bracing is designed to form a 3-ft space between trusses to accommodate the lighting fixtures at the high line of the ceiling. The deck acts as a diaphragm to transfer wind and seismic forces to the masonry shear walls.

Other Details

The facade of the library features split travertine marble panels over the masonry shear walls. Walls run between columns and are separated from the columns by one foot wide heat resisting glass panels. A wide overhang is used both as sun control and as a continuation of interior structure. The extension of the V-shaped ceiling to the outside is a prominent facet of the exterior design. Extensive landscaping in the building's wide set-back area is planned to enhance the peaceful atmosphere associated with library operations.

The simplicity of the steel framing system and predictable ease of construction contributed to accurate cost estimating both at the design stage and the subsequent bidding. The City of Santa Monica initially budgeted \$1.5 million for construction. Based on the architect's cost estimate, a fund of \$1.460 million was finally allocated for the construction. The contract was let to the low bidder at \$1.404 million. Of the ten bids received, the high bid ex-

ceeded the low bid by only 5%. Nominal change orders during construction allowed a return of \$40,000 to the City treasury after completion.

Architects: Matthew Robert Leizer and Thomas J. Russell
Los Angeles, California

Structural Engineer: Albert A. Erkel and Associates
Los Angeles, California

General Contractor: Parr Contracting Co.
Los Angeles, California

An indoor patio provides a pleasant, open space adjacent to the main reading area.



The Santa Monica Library is both a community showpiece and an outstanding service facility.



A Tree-like Structure

Modern architecture and modern steel construction are having an affair – in Paris. At a lovely site overlooking the Seine, Architect Edouard Albert has created a unique steel-framed **structure arbor-escence** – a tree-like structure on a monumental scale. Inspired by the many trees which line the river and the avenues converging at nearby Pont d'Alma, this tall, transparent structure carries a group of suspended “business hotel” units, each crowned with green foliage.

According to Architect Albert, who has pioneered imaginative design in steel in other structures such as Paris' first skyscraper and the Air France Building at Orly, “the concept introduces a new architectural verticality, in which problems of view or isolation do not arise, for they are solved in advance by the basic proposals themselves. Height is divested of its usual crushing mass because the various parts of the structure . . . have first been scattered, then reconstituted on their individual stems.”

Twenty-two steel-framed “hotels”, each 59'-0" x 29'-6" x 29'-6", are supported by twenty vertical columns. Five vertical ducts house all utilities – electrical, mechanical, and air-conditioning – as well as ten elevators. Slender diagonal ties help keep the system rigid. Overall height is approximately 394 ft above street level.

The view from below has been carefully and imaginatively considered. The soffit of each unit is treated decoratively with bronze and mirrors, providing an effect of depth and density similar to that of the diamond-shaped bronze panels and glass of the vertical walls. The upper surface of each unit is a hanging garden, planted with trees.

When completed, the building will be used by business organizations to meet with important guests in privacy and comfort. Each hotel provides deluxe suites of reception rooms as well as private mezzanines. Ten elevators provide vertical transportation.

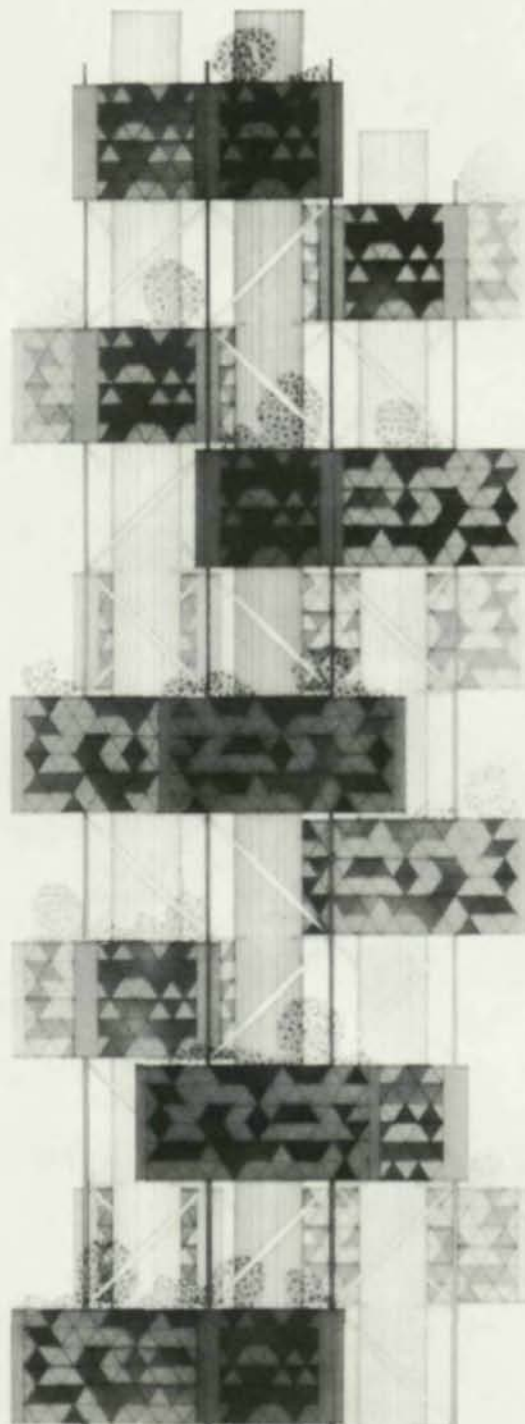

Courtesy Acier-Stahl-Steel