

09579

A9.18

MODERN STEEL CONSTRUCTION



1	Steel for an HP Band Shell	10
2	X-Braced "Super Trusses" .	3
3	Chicago Police Training Center	12



MODERN STEEL CONSTRUCTION

Published by

American Institute of Steel Construction

1221 Avenue of the Americas
New York, N.Y. 10020

OFFICERS

Robert P. Stupp, Chairman
William J. Tilley, Jr.,
First Vice Chairman
Phillip O. Elbert,
Second Vice Chairman
C. Farnham Jarrard, Jr., Treasurer
John K. Edmonds, President
Leslie H. Gillette,
Assistant Executive Vice President
William W. Lanigan,
Secretary and General Counsel

EDITORIAL STAFF

Daniel Farb, Director of Publications
Mary Anne Stockwell, Editor

REGIONAL OFFICES

Atlanta, Georgia
Birmingham, Alabama
Boston, Massachusetts
Chicago, Illinois
Cleveland, Ohio
Columbus, Ohio
Dallas, Texas
Denver, Colorado
Detroit, Michigan
Charlotte, North Carolina
Houston, Texas
Kansas City, Missouri
Los Angeles, California
Memphis, Tennessee
Minneapolis, Minnesota
New York, New York
Philadelphia, Pennsylvania
Pittsburgh, Pennsylvania
St. Louis, Missouri
San Francisco, California
Seattle, Washington
Syracuse, New York
Washington, District of Columbia



VOLUME XVIII / 1978

CONTENTS

X-Braced "Super Trusses"	3
An Expression in Steel	6
Steel for an HP Band Shell	10
Chicago Police Training Center	12
AISC Quality Certification Program	16

T. R. HIGGINS LECTURESHIP AWARD

The T. R. Higgins Lectureship Award will recognize an outstanding lecturer and author whose technical paper or papers may be identified as an outstanding contribution to engineering literature on fabricated structural steel published within the five year eligibility period that ended January 1, 1978. The award winner will receive a \$2,000 prize during a ceremony at the 1979 AISC National Engineering Conference in Chicago, Illinois, where he will present his paper.

A jury of six eminent engineers from the fields of education, design, and industry will select the award winner. They are:

Arthur P. Arndt American Bridge Division, United States Steel
Lynn S. Beedle Fritz Engineering Laboratory, Lehigh University
Paul J. Foehl Midwest Steel & Iron Works Company
John M. Hayes Purdue University
E. Alfred Picardi Oxford Development Group Ltd.
Carl E. Thunman, Jr. Illinois Department of Transportation

1979 FELLOWSHIP AWARDS PROGRAM

Four \$3,500 awards will be granted to civil and/or architectural engineering students pursuing a course of graduate study related to fabricated steel structures. \$3,000 is for the student's use and \$500 is for the department chairman's use in administering the grant.

Students interested should contact their department chairman or the AISC Committee on Education, 1221 Avenue of the Americas, New York, NY 10020. The deadline for receiving applications is March 1, 1979.

ERRATA

In the 3rd & 4th Quarter 1977 issue covering the Rush-Presbyterian-St. Luke's Medical Center's academic facility, Chicago, Ill., the steel fabricator should have been listed as:

American Bridge Division, United States Steel
Pittsburgh, Pennsylvania



DO YOU WANT THE LATEST INFORMATION ON STEEL DESIGN?

Keep Up-To-Date With a Subscription
To The AISC ENGINEERING JOURNAL

Four times a year in the comfort of your home or in your office, you will have the rare opportunity of meeting some of the leading minds in structural engineering, through the pages of AISC's Engineering Journal. The official technical journal of the American Institute of Steel Construction, this is the only magazine in America devoted exclusively to the practical aspects of structural steel design.

Each issue contains articles of immediate use and lasting interest by experts in research, design, fabrication methods and new product applications—articles designed to improve and advance the use of steel in contemporary building and bridge construction—articles which will allow you to share the latest knowledge and expertise of practicing consulting engineers, educators, and leaders in the field of structural steel research.

FROM _____
ADDRESS _____
CITY _____ STATE/COUNTRY _____ ZIP _____

FIRST CLASS

PERMIT No. 6009

NEW YORK, N.Y.

BUSINESS REPLY MAIL

NO POSTAGE STAMP NECESSARY IF MAILED IN THE UNITED STATES

—POSTAGE WILL BE PAID BY—

AMERICAN INSTITUTE OF STEEL CONSTRUCTION

1221 Avenue of the Americas

New York, New York 10020

Attention: Paul R. Johnson

To enter your subscription to the AISC ENGINEERING JOURNAL detach and return the attached envelope TODAY

We invite you to join more than 6,000 of your associates who are now regularly receiving the AISC Engineering Journal. . . . The cost is only \$6.00 for one year or \$15.00 for three years; single issue \$3.00; (Foreign rates: \$8.00 for one year, \$18 for three years; single issue \$4.00). Simply fill out the attached form and send your check or money order to begin your subscription. *Payment must be enclosed with this order. Make checks payable to AISC. Foreign subscriptions are payable in U.S. funds only.*

Please enter my subscription to the AISC ENGINEERING JOURNAL

U.S. and Canada

- 1 Year \$ 6.00
 3 Years \$15.00

*Other Countries

- 1 Year \$ 8.00
 3 Years \$18.00

*Payable in U.S. Funds

Payment **must** be enclosed with this order.
Make checks payable to AISC.



NAME

(please print)

FIRM OR AFFILIATION

STREET

CITY

STATE

ZIP CODE

Profession or occupation:

- Engineer Architect Educator Other

X-BRACED "SUPER TRUSSES"

by Hugh A. Stubbins, Jr., FAIA

Three main forces converged to shape the design of the Federal Reserve Bank of Boston: the importance of clear expression of distinct but related functions in a unified scheme which would enhance a prime downtown renewal area; the need for well defined circulation; and the requirement for a high level of security within a pleasant environment. Several different kinds of space were demanded by the client to conduct its complex banking functions and provide stimulation and a sense of fulfillment for its employees. Maximum security areas were required for the coin, currency, and check operations. Areas for a major banking floor, light attractive space for executive and administrative and research functions, rentable floors, and imaginative employee facilities were desired.

Careful study of program and organizational requirements led to the decision to place the secure areas in a separate, low-rise block and the office floors in a high-rise tower offering access to daylight and views over the harbor. To integrate the two elements within a single unified scheme, a connecting link was designed to house employee facilities, gallery/display area, and central control station—strategically located with a view over the whole complex. The location of the employee floor and recreation facilities at the top of the low-rise building made them accessible to everyone working in the complex, with the added amenity of a landscaped roof garden.

Mr. Hugh A. Stubbins, Jr. of Hugh Stubbins and Associates, Inc., Architects/Planners, served as principal-in-charge of this project.



Since the secure areas are to some extent inward looking—while the office areas are perceived as open, receptive, and outgoing—the low-rise building forms a U-shaped configuration around and connected to the tower. A landscaped court with pools emphasizes the humanity of the buildings in an urban setting and creates an effective transition between them.

Tower Design Features

Open, flexible office floors—which would lend themselves to an office landscape interior treatment—were part of the program. Service cores are thus located at each end of the tower instead of in the middle, leaving large, clear spans of column-free space in between. Continuous, uninterrupted glass walls are achieved by



bution to energy control. Its reflective surface lessens solar heat gain, thereby reducing air conditioning loads.

Structure

The slender proportions of this 33-story, 580-ft office tower, 85 x 196 ft in plan, and the 143-ft wide open space between its flanking cores below the fifth floor level, challenged engineers.

All transverse lateral forces are resisted by four major frames, two in each core. The two outer frames take about 70 percent of the forces due to their efficient X-braced "supertruss" design. The inner frames used moment-resisting connections. The seismic design criteria required these ductile moment-resisting frames to carry 25 percent of the specified forces. All moment connections above the sixth floor were field welded.

Extensive wind testing of models of the building and its surroundings was undertaken at the University of Western Ontario Boundary Layer Wind Tunnel. The results proved the safety, rigidity and comfort of the structural design, and provided design wind pressures on the building cladding.

Typical floors have only eight columns between the end cores, resulting in bays 30 ft x 55 ft with 16-ft cantilevers that permit the window lines to be column-free. Girders as well as filler beams were made composite with the 6¼-in. light-weight concrete deck-supported slab for rigidity and economy.

Thirty floors of column load are transferred across the large opening near the tower base by massive twin trusses, each 36 ft deep and weighing 650 tons. Truss members were generally H-shaped weldments using plates up to 6¼ in. x 48 in. in size. Some shop connections were electroslag welded, while field connections were high-strength bolted, using heavy gusset plates.

Structural steel, totaling 18,000 tons, was used for overall construction economy and to keep tower weight and truss and column sizes within reasonable limits. ASTM A36, A572, and A588 steels were used in the structure. In more detail, some of the reasons for using structural steel were:

- To provide large column spacing and long cantilevers without a heavy weight penalty.
- To allow use of metal deck floors having underfloor electrification.
- To provide efficient resistance to earthquake and wind forces.

holding the columns away from the exterior walls. Outside and above the glass, projecting aluminum spandrels ("eyebrows")—triangular shaped in section—which produce the textured effect in the building form, have two other important functional reasons for their existence. They serve as sunshades to shield the windows from glare and excess solar gain in the summertime, while allowing the sun to reach the glass in winter. They also help solve the wind problem associated with tall buildings. Since the downward acceleration of air causes discomfort around the base of a tall building, projecting spandrels function as "spoilers" softening the force of the wind.

The opening between the lobby and office floors in the tower is also a helpful element in reducing the downward force of the wind around the building base. By allowing the air to escape from the high to low pressure zone via the opening, the wind's force is diverted from the pedestrian entrances and walkways below. Architecturally, the opening expresses the change in function between public and office space, while making visible the link between the office tower and the rest of the complex. It also serves to lighten the effect of the tower, so that it appears to stand freely above the rest of the complex.

The bright aluminum facing expresses today's technology and makes a contri-



- By means of two massive trusses, to carry 30 stories of building across a 143-ft span to heavy core columns.
- Using 17-ft deep trusses, to span the third and fourth floors 143 ft across the column-free tower lobby.
- Steel framing will facilitate future owner or tenant alterations.

Although concealed, the major structural elements are reflected in the massing of the end cores and the depth of the block above the base opening. The result is a tower that is graceful and soaring, yet firmly supported and stable.

Special Requirements

The complex operations demanded a special study of the movement of data and goods throughout the complex. This resulted in an innovative computer-based system to control and analyze movement and inventory of commodities from dock receipt to shipment. The system effects economies by reducing man hours, providing safer conditions, guaranteeing a high degree of security, and providing flexibility to accommodate changes in working methods and software programs.

Indoor-Outdoor Environment

This exceptional 5.7-acre site, adjacent to South Station development activity within downtown Boston's financial core, permitted the provision for future expansion and the inclusion of landscaping unusual in a dense urban situation. Grassy banks, trees, and walkways surround the building. Pools provide a kind of "water

court" between the tower and the low-rise structure. An 18-ft high landscaped wall, running for 140 ft along the gallery-display area, is visible from the main entrance lobby, introducing tremendous drama to the city scene. The employee facilities—which include a cafeteria, store, kitchen and roof terrace with views over Fort Point Channel—all recognize the importance to office workers of access to the outdoors.

The solution has benefited from the close involvement of a client who has understood the impact of a good building, not only on its own process, but on the life of the city as a whole.

Architect:

Hugh Stubbins and Associates, Inc.
Cambridge, Massachusetts

Structural Engineer:

LeMessurier Associates/SCI
Cambridge, Massachusetts

General Contractor:

Perini Corporation
Framingham, Massachusetts

Steel Fabricator:

American Bridge Division
United States Steel
Pittsburgh, Pennsylvania

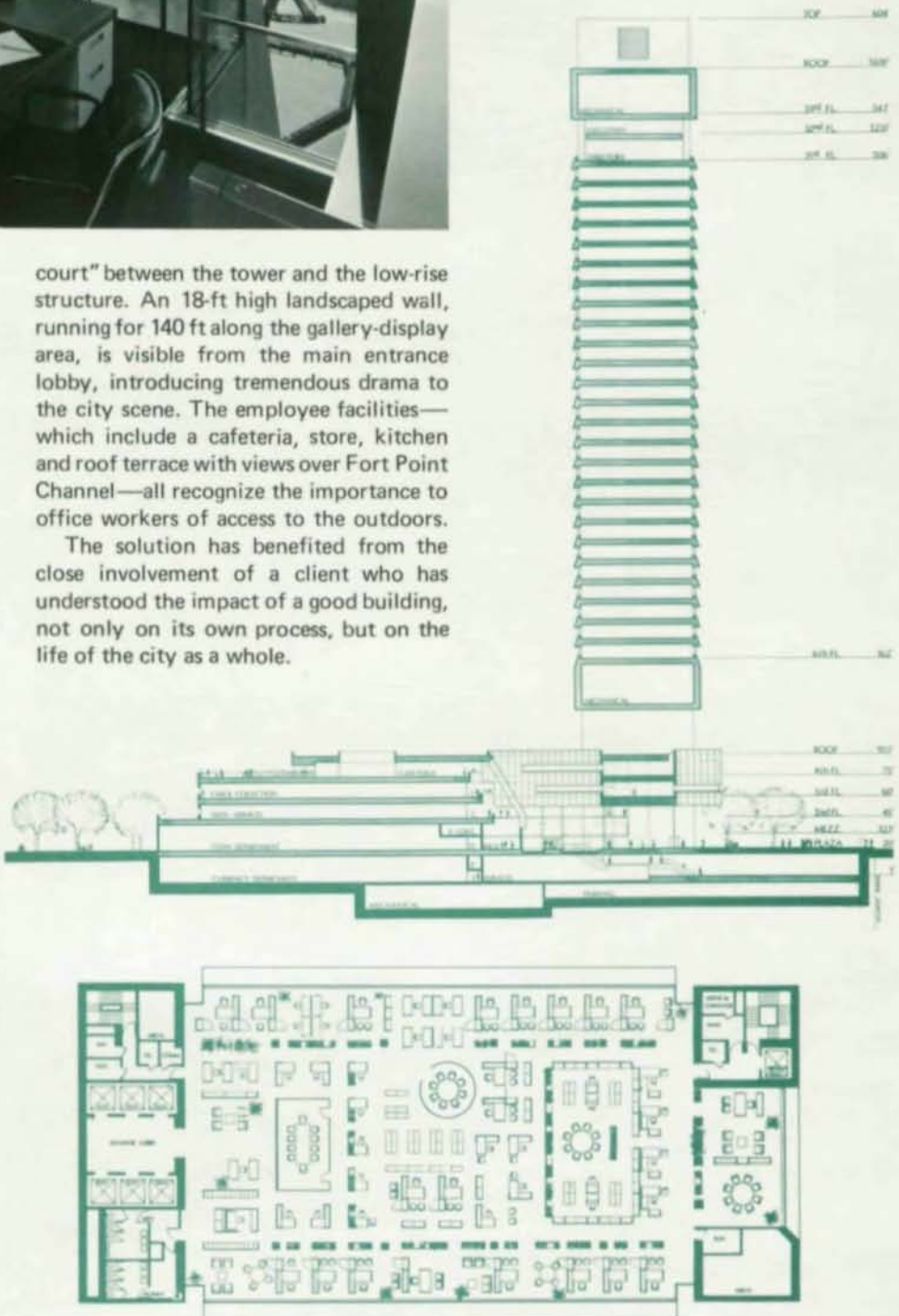

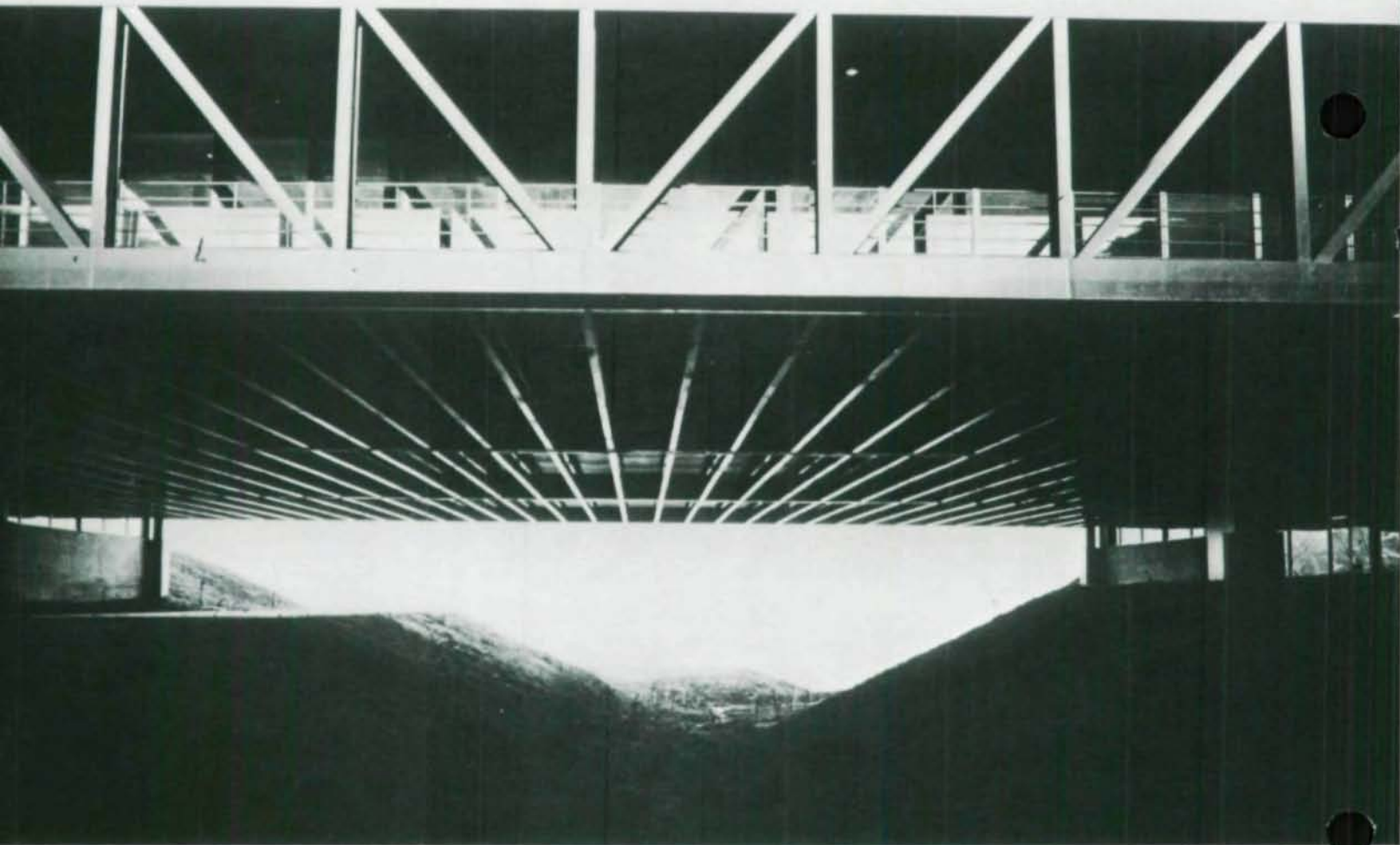

AN EXPRESSION IN STEEL

by Roy Becker

The Art Center College of Design recently completed construction of its new campus, located on a 175-acre hillside overlooking the Pasadena Rose Bowl. Internationally recognized as one of the world's finest institutions in the fields of industrial design and communications arts, the Art Center specializes in majors such as graphic design, product design, film making, and transportation design. In fact, more than sixty percent of the designers now working for Detroit auto makers are graduates of the Art Center, a fully accredited institution.

In terms of design excellence, this California school is hard to beat. "We have been to all the design schools, and there isn't another one like it," declares William L. Mitchell, Design Vice-President at General Motors. "Other schools tend to

teach more theory," he adds, "and theory isn't worth a hoot in my business."

Design Concept

In planning the new campus, college officials determined that one of their most important objectives would be to provide a creative environment for learning. However, zoning restrictions demanded that the new facilities complement the hillside and not distract from the rustic surroundings.

Faced with these criteria, as well as a limited budget, the architect conceived a "single," low-profiled structure of steel and glass, rather than several separated buildings, to meet the needs of the entire school.

To leave the natural surroundings of the chaparral-covered hillsides undisturbed, the architect decided to span a portion of the structure over a small existing canyon. This led to a bridge scheme, along

with north and south wings flanking it—the bridge to house the administrative offices and library; the two-story wings (with one story below grade) to contain classrooms and studios. To achieve the low profile desired, plans called for the final structure to measure 680 ft x 144 ft, with a total floor area of 166,000 sq ft.

To provide a creative environment for students, the architect required that the following qualities characterize the building's architecture:

- Boldness
- Modularity
- Openness
- Orderliness

To meet these goals, both architect and college officials agreed that an architecturally exposed structural steel framing system should be used on the exterior and throughout the interiors of all classrooms and studios. Hence, the classroom itself would become a learning tool as to how

Roy Becker is AISC Regional Engineer, Los Angeles, California.

the building was designed and constructed.

With these parameters set, project designer James Tyler and project architect Steven Woolley began working on the more detailed items to complete the facility.

The Bridge

In order to span the canyon and a major access roadway below, four exposed steel trusses spaced at 48 ft are utilized. These 16-ft deep trusses support the entire bridge for a clear span of 192 ft. The architectural expression of the bridge is primarily determined by these two exterior and two interior exposed steel Pratt-type trusses.

Between the exterior trusses and the recessed curtain wall, covered walkways interconnect the bridge with the adjacent wings. When viewed from a distance, the members of both truss and curtain wall

appear to converge to form unique geometric patterns. To blend the building with the surrounding San Rafael hills, the exterior trusses are painted satin black.

The exposed interior trusses form a division between the study and library areas, as well as in the administrative offices, creating an effect of triangular "doors" between the various areas of the bridge. The black-painted interior trusses contrast dramatically with the white interior partitions and white ceilings.

The elements of the trusses consist of 14-in. rolled column sections for web members, diagonals and verticals, with the chords fabricated from plate to create H-shapes. The webs of the chords lie in a horizontal plane, and the width of the chord flanges is maintained at 24 in. This constant flange width achieves uniformity of appearance across the exterior of the bridge. Also, it sets the top chords of the

trusses in exact alignment with the W24 spandrels framing the roof of the adjacent wings, while the bottom chords precisely align with the W24 spandrels framing the second floor of the wings.

To avoid massive bolted connections, all members of the trusses are connected by welds, using a combination of fillet and full penetration welds. All steel is A36. Special care was taken to minimize the probability of lamellar tearing adjacent to the weld areas. Two recent articles in AISC's *Engineering Journal* concerning lamellar tearing proved extremely informative and no lamellar tearing problems were encountered. The resulting connections are uniform and aesthetically pleasing.

The bridge, structurally separate from both adjoining wings, has its own bracing system to resist seismic and wind forces. The four trusses, together with their supporting steel columns, form rigid



The entire bridge is supported by four 16-ft deep trusses.

Two 2-story wings, both with one story below grade, contain classrooms and studies.





The bridge provides a major part of the complex's architectural expression.

frames in the longitudinal direction, while wide-flange girders and these same columns provide the necessary rigid frames in the transverse direction. Carefully detailed expansion and/or seismic joints structurally separate the floor, roof and walls of the bridge from the adjacent wings.

North and South Wings

Exposed steel frames around the exterior of the wings express the architecture of the building. The curtain wall system is integrated within the confines of this exterior steel frame, and its aluminum mullions are electrostatically painted (rather than anodized) in order to perfectly match the satin black of the steel frame. Although reflective glass is used at a few locations, most of the curtain wall is glazed with 1/4-in. solar gray glass. The match of the solar gray and reflective glass is so superb that it is almost impossible to visually detect any difference from the outside of the building.

Since the exterior steel frames serve not only to resist vertical forces, but also to resist lateral forces such as seismic or wind, moment connections are used to join its spandrels to the columns. In order to provide an architecturally pleasing

appearance, all-welded moment connections are used in lieu of the more common bolted-welded connections. The flanges of the 24-in. spandrels are welded to the face of the 14-in. column shapes with full penetration welds, while fillet welds connect the webs of the spandrels to the columns. By using all welded connections, the column-spandrel assemblage appears very much as if it were monolithic.

Since there are no suspended ceilings within the exterior of the wings, the overhead framing is exposed to view. But, by using a flat black to paint the exposed steel beams, metal deck soffit, mechanical ducts, and plumbing and electrical lines overhead, the absence of a ceiling system is not readily apparent. On the other hand, a distinct contrast exists between the bright white interior walls and the flat black framing overhead. The various mechanical and electrical components are cleverly integrated within the framework of the exposed beams and girders.

Multi-Functional Framing

Both the exterior trusses of the bridge and the exterior frame of the wings perform a significant number of building functions, such as:

- Supporting tributary dead and live loads.
- Resisting the total seismic and wind loads imposed on the building.
- Acting as an integral part of the curtain wall.
- Determining the overall external appearance and the decor of the building's facade.

Creative Environment

The architectural expression of both the exterior and interior of the Art Center is truly that of the steel frame. Clean, sharp lines having distinct geometric patterns predominate this exceptionally attractive and open structure.

During the first year of operation of this new facility, the students' response to this creative environment was clearly manifest in the quality of their projects. The facility provided the necessary freedom and impetus for creativity that the Art Center desired.

In the words of Don Kubly, President of the Art Center, "If there was ever a facility that demanded honest, problem-solving, simple, beautiful solutions—this is it."



The geometric pattern of the trusses predominate the interior.

Architect:
 Craig Ellwood Associates
 Los Angeles, California

Structural Engineer:
 Norman J. Epstein
 Santa Monica, California

General Contractor:
 Swinerton & Walberg Co.
 Los Angeles, California

Steel Fabricator:
 Federal Steel Corporation
 Long Beach, California

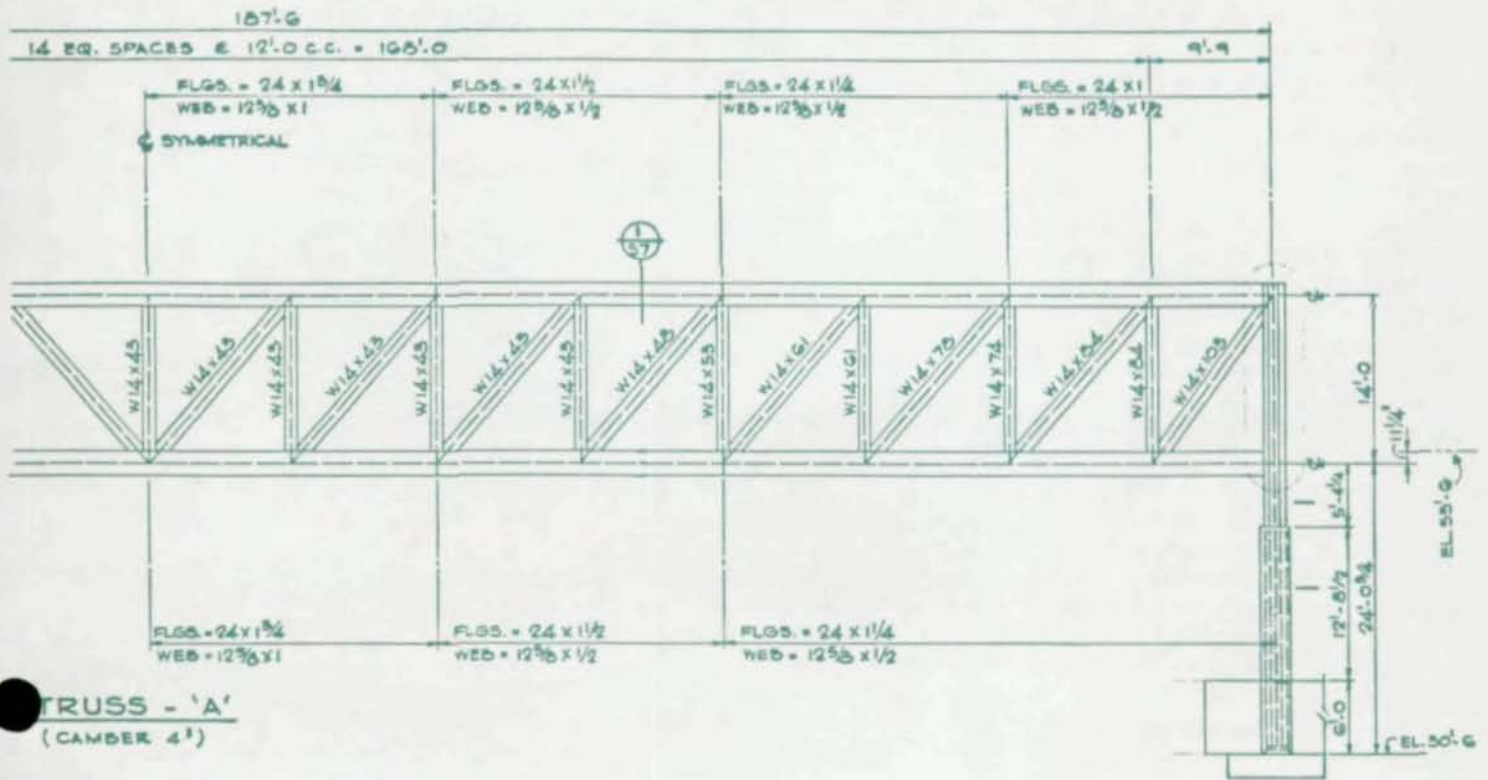
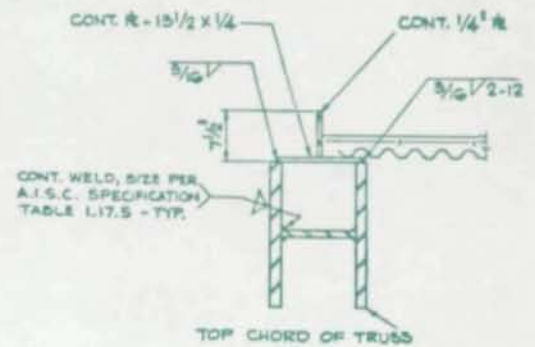



STEEL for an HP BAND SHELL

by Frederick M. Law

An exciting new structure was recently completed in New Bedford, Massachusetts—an exposed steel-framed hyperbolic paraboloid band shell.

This unique structure grew out of a feeling of pride in the City of New Bedford. The designers felt that New Bedford, with its proud history as a Whaling City and Textile Center in New England, should have a band shell for its cultural and social activities, in keeping with this greatness.

After a study of a number of structural forms, the unique exposed steel-framed hyperbolic paraboloid was selected primarily because of its particular acoustical and visual appeal.

The hyperbolic paraboloid form, by curving downward from the center to the sides, harmoniously blends the sounds coming from all parts of the stage. At the same time, this form, by curving upward from back to front, projects these blended sounds directly outward to the listening audience. As one member of the City Park Board put it, "It seems acoustically to be an almost perfect shape."

Frederick M. Law served as designer and structural engineer on this project.

Visually, the hyperbolic paraboloid form creates a structure which appears to soar upward from its solid concrete supports. It tends to lift the spirit in the same manner as will the music it is built to shelter.

Technologically, this structure is no less exciting. In plan view, the roof framing appears at first glance to be merely an orthogonal grid with diagonal ties. All the wide-flange steel ribs members are, indeed, absolutely straight. However, when it is noted that one corner of the roof is 18 ft higher than the other three corners, the exciting hyper form begins to emerge. (Mathematically, it is easy to prove that the doubly curved surface can be created by means of absolutely straight members; however, it is always somewhat hard to believe, until you actually see one built.)

Naturally, the ability to construct a hyper roof using only straight members is a tremendous construction simplification. Further, unlike concrete shell structures, no formwork is required.

To further simplify fabrication and erection, all the short wide-flange ribs, running in the east-west direction, were

made the same length. The connection plates for the short ribs were, however, of different lengths as required by the increasing slope. Each of the long ribs also had different lengths because of the increasing slope.

The diagonal tie plates were fabricated as continuous straight members, but, when connected to the wide-flange ribs, naturally assumed the virtually parabolic shape of the roof surface. All the structural steel in the roof is A36.

During erection, the front and rear corners of the roof were temporarily supported until all the structural steel was in place, at which time the roof was completely stable. Obviously, erection of the steel was far simpler than the elaborate formwork and falsework which would have been required to erect a concrete shell roof.

The design of the steel-framed hyperbolic paraboloid roof, with its orthogonal layout, was accomplished by means of simple statics. (An example of such an analysis is contained in *Design Examples: Space Forms in Steel*, American Institute of Steel Construction, 1966.)

The roof loads are carried by the wide-flange ribs which span between the diagonal ties. As a consequence, the ties take the entire roof load and can be analyzed as cables subjected to a series of concentrated loads. The rib members then take on the added function of struts as well as beams, since they serve as anchors for the ties.

Hence, the orthogonal arrangement is in simple static equilibrium, with all the ribs (including the exterior rib or fascia) in compression, and all the diagonal ties in tension. Naturally, additional secondary stresses are developed as a result of the particular connection details which cannot be overlooked.

The appeal of the exposed steel-framed hyperbolic paraboloid form is almost contagious. Virtually from their first contact with the project, the members of the City Park Board, the City Planning Department, and the Department of Public Works became enthusiastic supporters of the project. Based on their enthusiasm and favorable recommendations, the project was officially designated a Community Development Project by the Mayor.

Construction of the band shell took a little over three months.

Perhaps the feeling of all those who were involved in the project can best be

summarized by the following words of a resolution concerning the band shell passed by the New Bedford City Council:

"These gentlemen . . . have exhibited their civic pride in a manner which will benefit young and old for many years to come. Be it therefore resolved that the New Bedford City Council hereby commends Mr. Kaner, Mr. Ronney and Dr. Law for their foresight and visual contribution to the city's cultural and social activities."

Structural Engineer & Designer:

Dr. Frederick M. Law
North Dartmouth, Massachusetts

Associate Designers:

Lawrence Kaner and Martin Ronney
North Dartmouth, Massachusetts

General Contractors:

Paul G. Cleary Co., Inc.
New Bedford, Massachusetts

Steel Fabricator:

Providence Steel and Iron Co.
Providence, Rhode Island

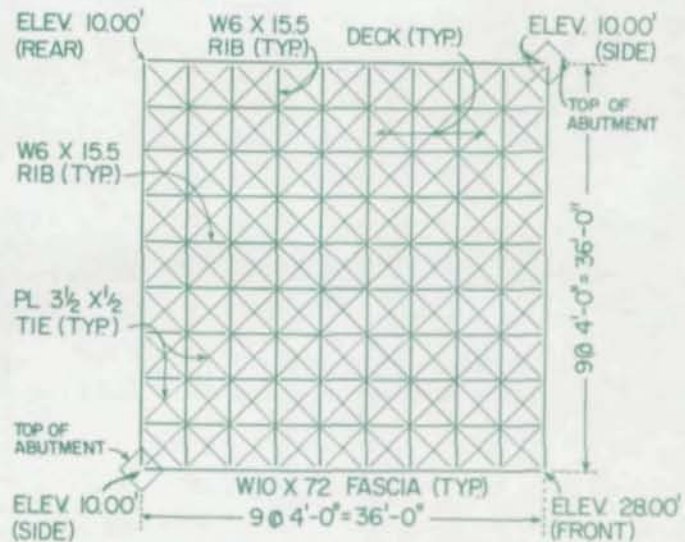



CHICAGO POLICE TRAINING CENTER

by Jerome R. Butler, Jr., FAIA

The 164,000 sq ft Chicago Police Training Center is one of the most advanced facilities of its kind in the nation. This \$13,800,000 project is designed to accommodate a rapidly expanding and innovative Police Training Program that encompasses many new disciplines.

Today, a policeman's job is more than simply law and order enforcement. He may at times be called upon to provide everything from family counseling to scientific evaluation to simple legal advice, as well as provide for the safety and protection of the community he serves. The

Jerome R. Butler, Jr. is Chicago City Architect and designer of this project.

curriculum of the Training Center currently carries over 40 different programs for training more than 15,000 police officers a year.

Besides a recruit training program of 90 days duration, the school provides courses for every policeman in the Department, from school crossing guards to officers seeking advancement. In fact, every Chicago policeman must spend a minimum of one week per year in the Training Center for review courses and updating of police techniques and regulations.

In order to accommodate this varied program and the large number of students, maximum flexibility of interior space was required. The design scheme developed was based on a 5-ft x 5-ft module, with

movable partitions which fit into the static grid of the coffered ceiling system. The plan includes 23 classrooms which wrap around a landscaped open interior court, featuring a statue memorializing the policemen killed in the Haymarket Riot of 1884.

There are a number of special use rooms, among which are lecture halls, drill hall, special laboratories for crime detection and mock-ups, language laboratory, shooting range and library. Electronic teaching aids, such as a studio with closed circuit TV and audio-visual equipment, will supplement conventional teaching systems. A medical section is included for routine annual physicals for the Police Department.



The structural steel system allowed for faster erection time.

The exterior spandrels are steel plate girders, completely weather sealed to the column covers.





Structural Steel Chosen

During the schematic design phase, a planning concept was utilized to study different structural systems which could be integrated with the architectural and mechanical requirements of the project, along with economic cost comparisons. Based on these studies, structural steel was selected for the following reasons:

- Most economical structural material for the specified bay size.
- Faster erection time, which permitted a "fast track" construction schedule.

The typical bay size is 30 ft x 40 ft. Steel truss girders span the long direction and composite wide-flange sections span the short direction between the girders. This arrangement provides a very shallow structural depth, thus allowing more mechanical space on each side of the trusses for the entire length of the building. The truss girders provide for mechanical crossovers between their diagonal members.

A deep foundation, consisting of caissons having a minimum shaft diameter of 3 ft, was required in order to carry the bearing level below a 30-ft deep buried stream channel. The caissons were provided with bells having a maximum diameter of 9 ft at a depth of approximately 60 ft below grade. Permanent casings were used within the buried stream channel limits to prevent adverse movement of adjacent ground.

The floor system consists of a 2-in. deep composite metal deck with poured light-weight concrete, to give a total floor thickness of 5 $\frac{1}{4}$ in. and provide the required 2-hr floor fire rating without the bottom of the deck being sprayed with fireproofing. Electrical underfloor duct is installed over special areas.

The exterior columns are wide-flange sections encased in concrete and covered with steel cladding. The exterior spandrels are structural plate girders completely weather-sealed to the column covers by continuous welding. The flame shielding method of fireproofing was utilized to permit these members to be left exposed. The trusses, beams, and backs of the spandrel member were sprayed with fireproofing to attain the required 2-hr rating.

Architect:

Jerome R. Butler, Jr., City Architect
Department of Public Works
Chicago, Illinois

Structural Engineer:

Louis Koncza, Chief Engineer
Department of Public Works
Chicago, Illinois

General Contractor:

S. N. Nielsen Company
Chicago, Illinois

Steel Fabricators:

Wendnagel and Company, Inc.
Chicago, Illinois
Rippel Architectural Metals
Chicago, Illinois

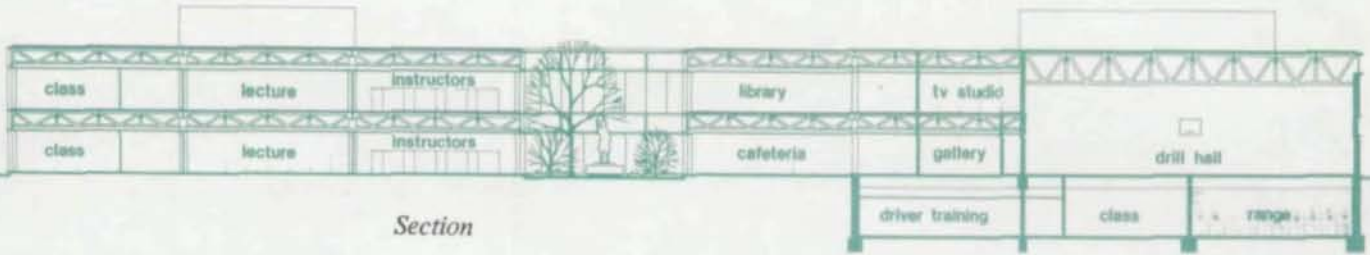

Section

Architectural Expression Achieved

The architectural expression is completed by filling in the structural frame with clearly articulated panels of dark face brick and bronze-tinted glass, depending upon the uses of the interior space. The bold horizontal proportions were the direct result of the structural, mechanical, and functional needs of the building.

Before 1941, the Chicago Police Department did not have a permanent training program. Since that year, Training Division programs have been conducted in a series of temporary facilities with limited space and inadequate mechanical and electrical capabilities. The new facility, making use of the latest educational tools and techniques, is expected to instill new pride and commitment to good, modern police service in all the men and women who pass through its training programs.

This facility, located just west of Chicago's Loop, close to the University of Illinois, Chicago Campus, is part of a continuing program by the City of Chicago for upgrading and renewing the inner City.

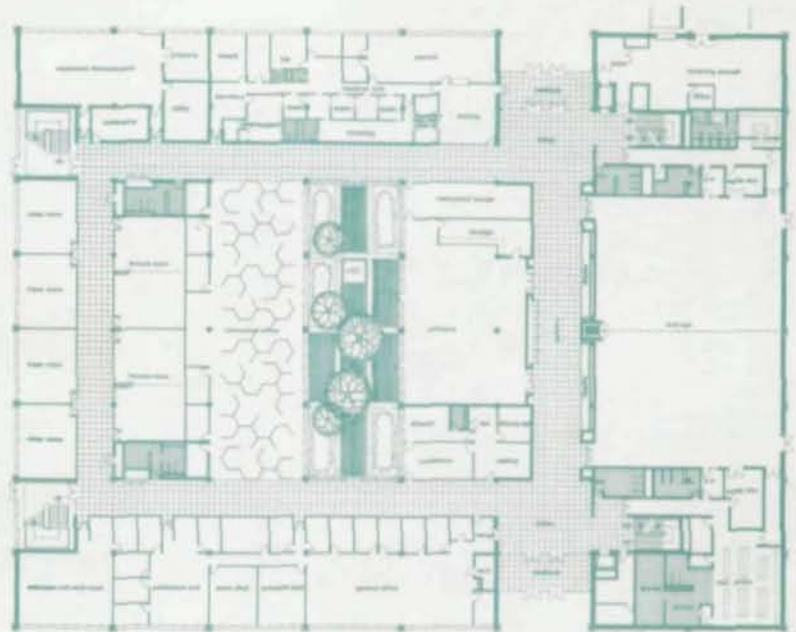

First Floor Plan



AMERICAN INSTITUTE OF STEEL CONSTRUCTION
1221 Avenue of the Americas
New York, N. Y. 10020

Address Correction Requested

BULK RATE
U.S. POSTAGE
PAID
NEW YORK, N.Y.
Permit No. 6662



Mr. L. H. Gillette 6a/7-3
97 Windsor Road
Kensington, Conn. 06037

The AISC Quality Certification Program

Recognizing the need for a comprehensive national standard for fabricator certification, and concerned by a trend toward costly inspection requirements that cannot be justified by rational quality standards, the American Institute of Steel Construction has developed and implemented a voluntary Quality Certification Program, whereby any structural steel fabricating plant—whether a member of AISC or not—can have its capability for assuring quality production evaluated on a fair and impartial basis. This national program has been in operation for the past two and a half years.

Since implementation of the AISC program, more than 50 plants have been certified in the various categories. The Certified plants are located in 23 different states. A considerable number of applications are in hand for future Inspection-Evaluation.

During the past year a number of owners, architects, and engineers have included the AISC Quality Certification Program as a part of the special provisions to their contract specifications.

The AISC Quality Certification Program does not involve inspection and/or judgment of product quality on individual projects. Neither does it guarantee the quality of specific fabricated steel products. Rather, the purpose of the AISC Quality Certification Program is to confirm to the construction industry that a Certified structural steel fabricating plant *has the personnel, organization, experience, procedures, knowledge, equipment, capability, and commitment to produce fabricated steel of the required quality for a given category of structural steelwork.*

A fabricator may apply for certification of a plant in one of the following four categories of structural steelwork for buildings, bridges, or other structures.

- I: Conventional Steel Structures
- II: Complex Steel Building Structures
- III: Major Steel Bridges—All bridge structures other than simple rolled beam bridges.
- MB: Metal Building Systems—Pre-engineered Metal Building Structures.

Certification in Category II automatically includes Category I. Certification in Category III automatically includes Categories I and II. Certification in Category MB is not transferable to any other Category.

An outside, experienced, professional organization, ABS Worldwide Technical Services, Inc. (a subsidiary of American Bureau of Shipping) has been retained by AISC to perform the plant Inspection-Evaluation in accordance with a standard check list and rating procedure established by AISC for each certification category in the program. Upon completion of this Inspection-Evaluation, this firm (commonly known as ABSTECH) will recommend to AISC that a fabricator be approved or disapproved for certification. ABSTECH's Inspection-Evaluation is totally independent of the fabricator's and AISC's influence, and their evaluation is not subject to review by AISC.

For further information, please write to the Quality Certification Administrator, AISC, 1221 Ave. of the Americas, New York, N.Y. 10020.