

AMERICAN INSTITUTE OF STEEL CONSTRUCTION
The Wrigley Building, 400 North Michigan Avenue
Chicago, IL 60611

Address Correction Requested

A9.27-1

BULK RATE
U. S. POSTAGE
PAID
PERMIT NO. 15
KENT, OHIO

MODERN STEEL CONSTRUCTION

NUMBER 1 • 1987

1987 NEC-COP ADVANCE PROGRAM INSIDE



THIS ISSUE



Dolphin Exhibit Framed in Steel
Steel Races on Super-Jack Track
A Crisp Look in Suburbia
Silver and Steel Work Together
50th-year Tribute to a Bridge
Steel Sculpture that Teaches
The Trend to Staggered-truss Framing

DECK DESIGN DATA SHEET

NO. 9

SPECIAL SHAPES

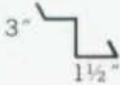
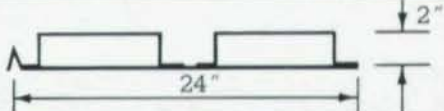
SPECIAL DECKS OR SPECIAL SHAPES ARE SOMETIMES REQUIRED FOR SPECIAL JOBS. WITH OUR BENDING EQUIPMENT AT UNITED STEEL DECK, INC. WE HAVE PRODUCED THE SHAPES SHOWN BELOW:

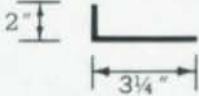
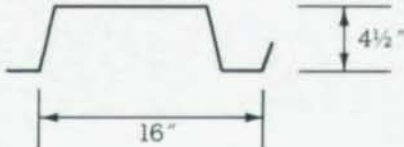
	12 GAGE SUPPORT TRACK.
	12 GAGE TOP HAT/ 16 GAGE BOTTOM PLATE HEAVY SLAB FORM.
	1/4" FORMED PLATE - HEAT SHIELD.
	1/2" FORMED PLATE - SPECIAL ANGLE.
	16 GAGE CANOPY DECK OF PRE-PAINTED STEEL.

IF YOU NEED A UNIQUE SECTION, OR IF YOU SIMPLY REQUIRE A SOURCE FOR BENT PLATE, CALL US. THE FOLLOWING TABLE IS A ROUGH GUIDE.

	MILD STEEL				A36 STEEL			
METAL THICKNESS	1"	3/4"	1/2"	1/4"	1"	3/4"	1/2"	1/4"
MAXIMUM LENGTH	9'	14'	20'6"	32'	7'	10'6"	15'6"	32'



NICHOLAS J. BOURAS INC.
 P.O. BOX 662, 475 SPRINGFIELD AVE.,
 SUMMIT, NEW JERSEY 07901 (201) 277-1617

UNITED STEEL DECK, INC.



ASSOCIATE MEMBER



MEMBER

LRFD & SCADA

An Opportunity for Safety and Profit

The AISC/LRFD code is going to make your structural steel designs more-reliable and economical than ever.

But its more involved equations may not make your life any easier.

Unless you're using the SCADA steel designer on one of your desktop computers.

SCADA automatically gives you all the safety and profit benefits possible with LRFD steel designs.

But without the hassles.

SCADA/LRFD is an integrated part of our general-purpose finite element program. So are the AISC/ELASTIC, AISC/PLASTIC, and other local and foreign codes.

With SCADA, you can design your structures according to any code you wish, and then compare results.

So call American Computers and Engineers and see how the savings on your next job can more than offset the cost of our system.

Or write to us explaining your particular requirements. We'll be more than happy to respond with a carefully designed opinion.

CIVIL ENGINEERING

- Steel & concrete beam & column design
- Shear wall & flat slab design
- Integrated analysis/design system

MECHANICAL ENGINEERING

- Solid modeling & mesh generation
- Heat transfer in solids: Conduction
Radiation
Convection
- Viscous fluid flow
- Heat transfer in fluids

AEROSPACE ENGINEERING

- Composite materials
- Buckling

GENERAL STRUCTURAL APPLICATIONS

- Linear analysis with load combinations and arbitrary load assignment capabilities to the load cases
- Geometric and material nonlinearities
- Plasticity and creep
- Dynamics: Response spectrum
Base motion
Time history

ELEMENT LIBRARY

- Truss/Spring/Gap/Beam
- Plane stress plane strain axisymmetric
- 3 to 4-node thin plate
- 3 to 9-node layered thick plate
- 4 to 27-node solid

COMPUTERS SUPPORTED

- VAX
- SUN
- APOLLO
- CRONEMCO
- IBM AT & Compatibles

For more information, call or write to:



11726 San Vicente Blvd.
Los Angeles, CA 90049
Tel.: (213) 820-8998
Telex: 493-0363 ACE UI

MODERN STEEL CONSTRUCTION

VOLUME XXVII • NUMBER 1
JANUARY-FEBRUARY 1987

American Institute of Steel Construction, Inc.

The Wrigley Building
400 North Michigan Avenue
Chicago, Illinois 60611-4185

OFFICERS

Werner H. Quasebarth
Chairman

Oscar W. Stewart, Jr.
Treasurer

Neil W. Zundel
President

William W. Lanigan
Secretary & General Counsel

Lewis Brunner
Vice President, Membership Services

Geerhard Haaijer
Vice President, Research & Engineering

William Y. Epling
Vice President, Government Affairs

EDITORIAL STAFF

George E. Harper
Director of Publications

Brenda Follmer
Assistant Editor

James Herman
Business

5 Steel Notes

8 World's Largest Dolphin
Exhibit Framed in Steel



12 Garden State Park
Steel on Super-fast Track



15 Harger Woods Center
A Crisp Look in Suburbia



21 The Novi Hilton
Steel and Silver Work
Together



25 San Francisco Bay Bridge
A 50th-year
Tribute to Excellence



29 A Steel Sculpture
that Teaches

31 The Trend to Staggered
Truss in High-rise
Apartments/Hotels

On our cover:

Cover and Bay Bridge story
photos courtesy California Dept. of
Transportation. Color photos by Bob Colin.

Steel Notes

LRFD MANUAL, SPECIFICATION & GUIDE SELLING FAST

All publications featuring Load and Resistance Factor Design (LRFD) are selling rapidly since their introduction last fall.

Over half of the *Load and Resistance Factor Design (LRFD) Manual of Steel Construction* 1st printing is now sold out. The 1,120-pg. Manual is based on the new design procedure which relies on the actual strength of a member or component, rather than on an arbitrary calculated stress. Both working loads and resistance are multiplied by factors, and design is performed by comparing the results. The concept is intended to help engineers design steel-framed buildings of more uniform reliability, with more efficient use of structural steel. The Manual (MO15) is \$42 for members and \$56 for non-members.

The LRFD Specification is also in popular demand from AISC's Publications Department. The Specification, included in the LRFD Manual, can also be purchased separately. The cost for the *Load and Resistance Factor Design Specification for Structural Steel Buildings*, effective Sept. 1, 1986 (S328) is \$7.50 for members; \$10 for non-members.

The *Guide to Load and Resistance Factor Design of Structural Steel Buildings* has also generated interest as shown by its high sales volume. The Guide supplies background information needed for a successful transition from Allowable Stress Design (ASD) to Load and Resistance Factor Design (LRFD). The 68-pg. Guide introduces the LRFD philosophy, discusses major topics, and provides simplified versions of several equations for design of simple structures or components. The Guide (S331) is \$7.50 for members; \$10 for non-members.

The LRFD Manual, Specification and Guide are all available from the AISC Publications Department, P.O. Box 4588, Chicago, IL 60680-4588. Please include check or money order. Visa and MasterCard are also accepted. List your card number and expiration date.

LRFD LECTURE SERIES TOURS U.S.

A lecture series to introduce Load and Resistance Factor Design (LRFD) began in December 1986. Programs have already drawn more than 2,000 industry professionals in Chicago, Atlanta, Los Angeles, Philadelphia, San Francisco, New York, Houston and Boston. Record attendance is expected in the 53 remaining cities on the lecture schedule. AISC staff members and guest speakers covered major sections of the new *Load and Resistance Factor Design (LRFD) Manual of Steel Construction*, and emphasized LRFD application to columns, beams and connections.

Upcoming lectures scheduled are: March 4 & 5 in Hartford, CN and in Minneapolis, MN; March 18 & 19 in Kansas City, MO; April 1 & 2 in Newark, NJ; April 7 & 8 in Cincinnati; April 21 & 22 in Columbus, OH; and May 20 in Syracuse, NY.

Many other cities across the U.S. are targeted for programs. Information will be sent to local design professionals once a program date and location are scheduled. For further information, call Janet Manning, AISC headquarters, 312/670-5431.

NEC/COP PROGRAM AVAILABLE

The Advanced Program for combining the National Engineering Conference and the Conference of Operating Personnel (NEC/COP), to be held April 29-May 2 in New Orleans, is included in the final section of this issue of *Modern Steel Construction*. The Preliminary Program of Events, Technical Program, Spouse's Program and Optional Events, and a registration form are all a part of that section.

Complete information concerning the program, travel accommodations, fees and special programs will be mailed to all Active, Associate and Professional members in February. For information, call Lona Babington, AISC headquarters, 312/670-5432.

AAE ENTRIES ACCEPTED SOON

Entry forms for the 1987 Architectural Awards of Excellence will be mailed soon.

The final date to enter the competition is June 1, 1987. Designers of a steel-framed building completed between June 1, 1985 and June 1, 1987 are eligible. Winners will be honored at the prestigious Annual Awards Banquet held in September 1987 at the Westin Hotel, Chicago.

FELLOWSHIP APPLICATIONS TO BE MAILED SOON

AISC's Education Foundation is now accepting applications from engineering students for \$5,000 fellowships. A maximum of eight fellowships will be awarded to those senior or graduate civil or architectural engineering students majoring in structural engineering who propose a one-year project dealing with some aspect of steel construction. Entries must be received no later than March 1, 1987. For an application, contact Robert Lorenz, AISC Education Foundation, 400 N. Michigan Ave., Chicago, IL 60611-4185; 312/670-5406.

T.R. HIGGINS WINNER ANNOUNCED

Reidar Bjorhovde, professor, Department of Civil Engineering and Engineering Mechanics, University of Arizona, Tucson, is the winner of AISC's 1987 T.R. Higgins Lectureship Award. The award has been presented annually by AISC since 1972. Bjorhovde, who received an engraved citation and a check for \$4,000, will present the winning lecture on five occasions. The premier presentation of his lecture, "Columns: From Theory to Practice," will be offered at the National Engineering Conference (NEC)/Conference of Operating Personnel (COP) in New Orleans, on April 30.

A member of numerous scientific and professional organizations, Bjorhovde is a fellow of ASCE, has published and lectured widely in the U.S., Canada and Europe, and served as an expert consultant to many organizations and committees in the U.S. and abroad. His research findings have been applied extensively, particularly in the areas of steel columns, stub girders and gusset plates.

NEW
WORKSTATION
PRICES

Looking at Computer Detailing?

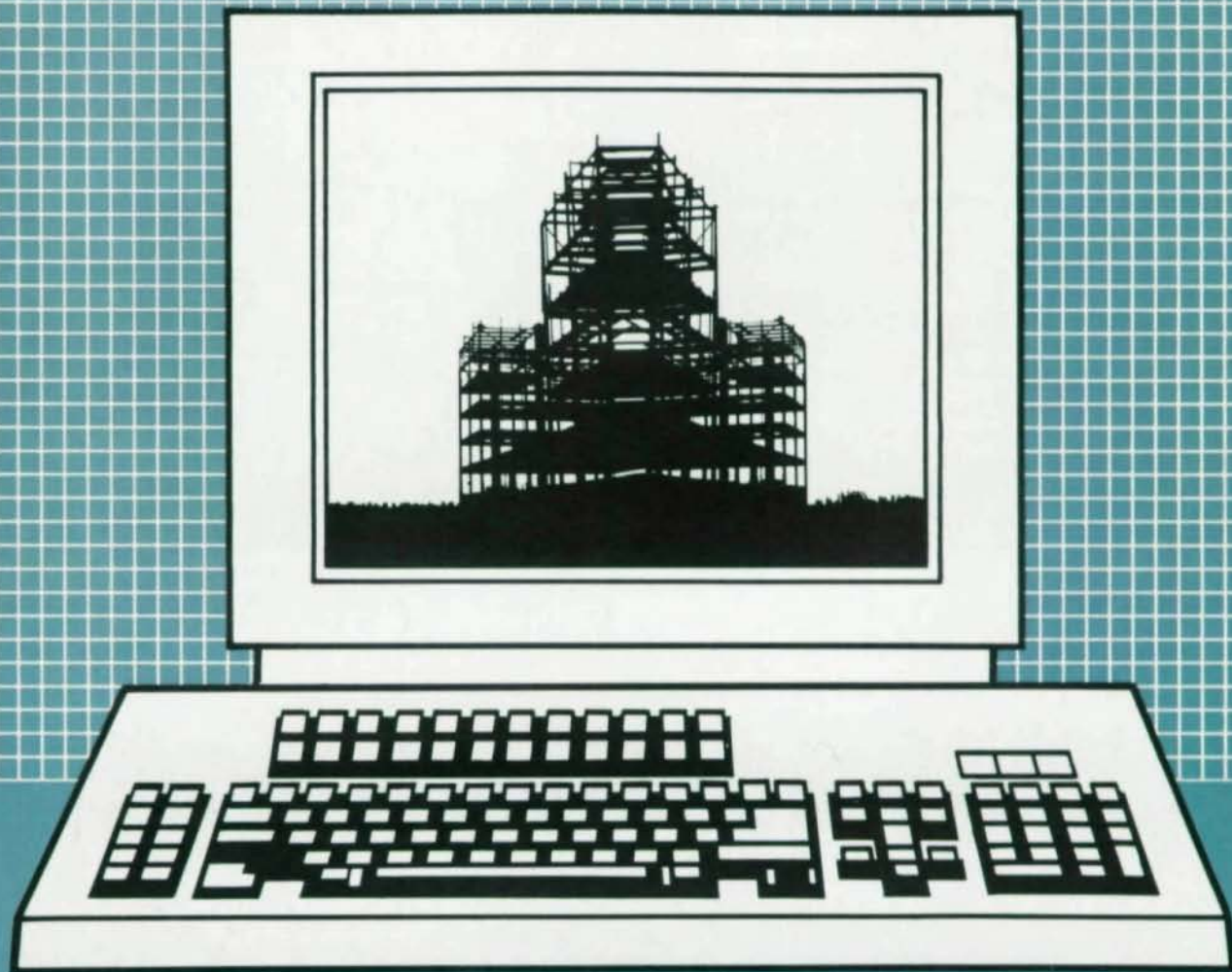

If you've been evaluating computerized structural steel detailing, you should know a new leader has emerged . . . **DETAIL™**

Compare, and you'll find, as others across the country have . . . nothing else comes close! **DETAIL™**

Simply the Best.

Also, **DETAIL JR™** — a full-function graphics based detailing system for \$4995!



GEOMETRIC DATA FLOW, INC

Geometric Data Flow's Detail™ Feature List

SIMPLY INPUT

- Uses grid planes from design instead of absolute X, Y, Z.
- Multiple member input instead of one at a time.
- Global assignment of connections, not point by point.
- Produces opposite hand structures with minimal effort.
- Interactive CAD graphics for drawing modifications.
- Easy to learn (8-10 hours training required).

INPUT VERIFICATION

- Plotted framing plans and elevations showing the position of members and the connection types assigned to each connection point, prior to producing shop drawings.

DRAWINGS AND REPORTS

- Automatically details all connection material separately.
- Automatically details all members (beams, columns, bracing, joists, etc.) by size and weight, combining all identical members.
- Automatically plots bills of material, weights.
- Automatically generates field bolt lists.
- Automatically assigns and plots shipping marks for erection.
- Automatically generates advance bill of material.

- Automatically generates load lists for sequencing.
- Automatically generates a mill order for most economical lengths.
- Automatically plots full size templates.

COMPREHENSIVE CONCEPT

- Details the building as a unit instead of member-by-member.
- Handles all shapes including wide-flange, channel, tubing pipe, etc.
- Performs connection design calculations.
- Flags troublesome connections, allowing the user to make corrections prior to plotting detail drawings.
- Maintains a complete file of structural members and connection material for estimation applications.
- Graphics processor language allows user to implement custom enhancements.
- Integrates to virtually any shop CNC equipment.

STATE-OF-THE-ART COMPUTER TECHNOLOGY

- Runs on Compaq 386™ three times faster than other PC/AT compatibles.
- Uses professional graphics high-resolution monitor — 1024 × 800 pixels.
- Supports voice response technology for super fast input.

FOR MORE INFORMATION:



GEOMETRIC DATA FLOW, INC

Computer Software For The Construction Industry

337 North Vineyard Avenue, Suite 206

Ontario, Calif. 91764

(714) 984-1269 1-800-DETAIL-5 (338-2455)

Architectural Solution

WORLD'S LARGEST DOLPHIN EXHIBIT FRAMED IN STEEL

by Ranjit Roy

Brookfield Zoo in suburban Chicago will soon inaugurate the new marine mammal exhibit known as the Seven Seas Complex. The facility includes an enclosed dolphin building, outdoor seascape for pinnipeds (sea lions and walruses) and a life-support building producing sea water. The existing Seven Seas Panorama building, which has attracted millions of visitors to the zoo for the dolphin shows, will be closed down because of deterioration of the concrete structures and the inadequate size to meet present needs.

The Seven Seas will be the largest non-coastal aquatic showplace for marine mammals in the world. Two other facilities similar to Brookfield's are located in southern California and Florida, both in close proximity to an unlimited sea water supply and in climates suitable for outdoor exhibition and zoological environment. The enclosed space at the Seven Seas Complex replicates the natural landforms, geological appearance, plant materials and water conditions of the coastal habitat of the display mammals.

Design of the Complex endeavors to present the visitors with the maximum opportunity to appreciate the physical characteristics, the social and behavioral patterns and intelligence and communication ability of the exhibited animals. It will also illustrate their relationship with the ecological systems to which they belong. Guidelines for the design envisioned a need to identify Seven Seas symbolically—immersed in the sight, sound, smell and texture of a marine world. To do this was a tall order. It required the architectural design to capture nature in an enclosed space. Adequate natural light, impression of expansiveness and continuity, free-forming natural contours and shorelines, water quality matching sea water and a planned temper-

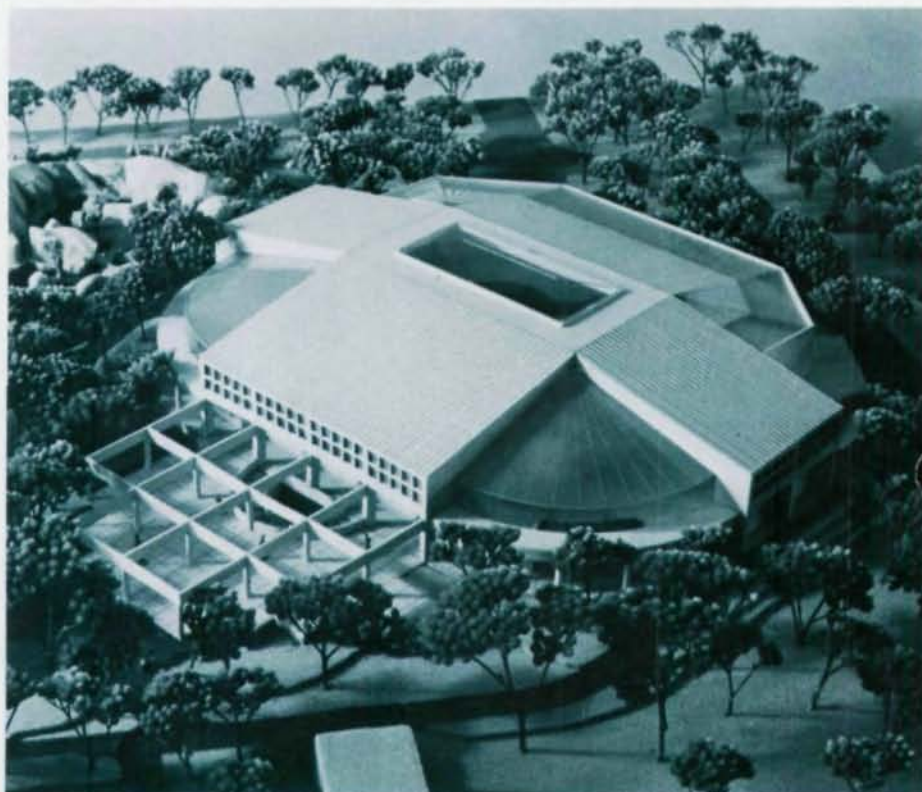

Model of world's largest dolphin exhibit nears completion at world-famous Brookfield, Ill. zoo.

ing of all distractions of man-made space—all constituted the theme for architectural design. Above all, the overriding concern of design, of course, was to maximize implementation of the guidelines within a limited budget.

The dolphin building covers 27,000 sq ft at the performance level with a viewing gallery of 2,000 seats. A lower level provides for under-water viewing. Plan dimensions are 158 ft x 210 ft. Foundations, retaining walls and the dolphin pools are poured concrete. Precast concrete framing and decks support the performance level floor. A clear-span structure supports a sloping wood deck roof with a flat center section for a skylight to provide natural light in the performing area.

Structural Steel for Architectural Impact

Structural steel was chosen as the framing material for the superstructure mainly for reasons of architectural need, clear open space and comparatively unobtrusive appearance. The options of space frame and truss construction were discarded because the myriad of structural components would cause distractions to viewing. All welded portal frames of enclosed box section satisfied the appearance requirements and permitted the architect greater freedom in designing the interior spaces.

The structural framing is five portal frames in the north-south direction spaced 22 ft o.c. Out-to-out span of the portals is 157 ft-3 in. Three lean-to frames spanning 60 ft-9 in. are spaced at 22-ft centers on

the east and west sides of the main frame envelope. This produces a clear space of 209 ft in the east-west direction. The southern corners in the shape of circular quadrants are framed by five radial lean-to bents meeting at the corner. Two triangular corners in the north are supported by three lean-to frames at each corner. All lean-to frames are supported by the two exterior portal frames in the north-south direction. Frame members are built-up box sections. Tube section purlins are spaced at 8 ft o.c. between the frames. Precast seating planks along the west, south and east sides are supported by a series of stringers from each frame to the performance-level framing.

A preliminary plane frame analysis provided the basic dimensions of the members. However, moments in the lean-to frames are dependent on the main frame deflection under lean-to loads. These loads in turn are the result of interaction of the lean-to stiffness and its support settlement due to the main frame deflection. After several trial sizes and "guesstimates" of settlement by plane frame analysis, built-up frame sections were developed that would produce compatible deflections

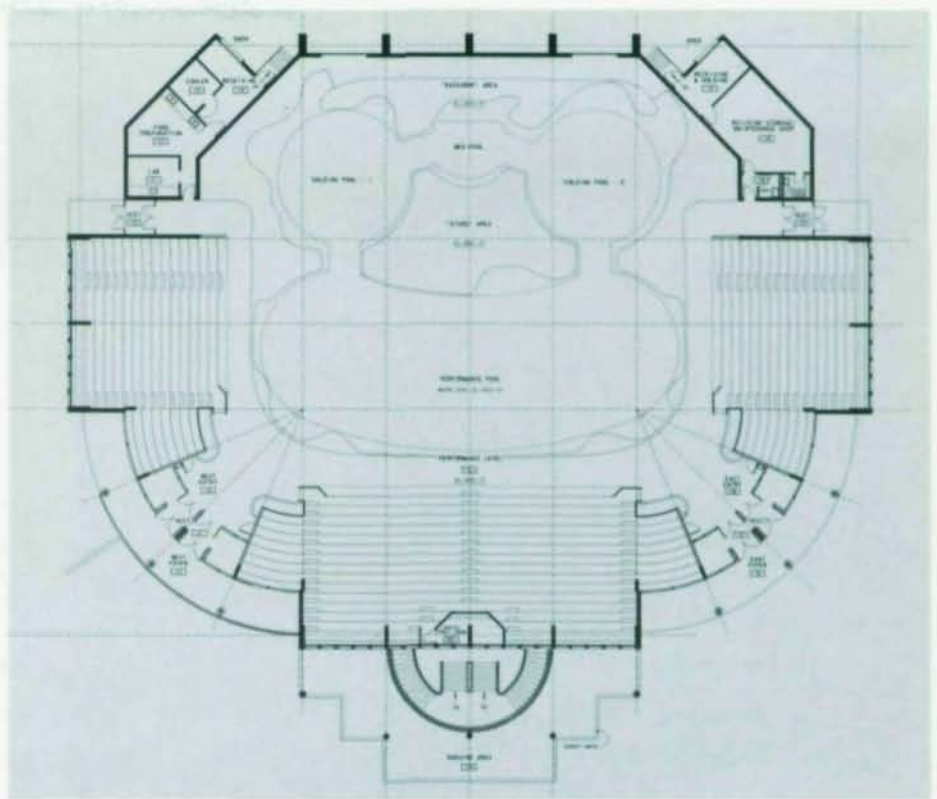

Floor plan (above) of complex. Interior photo (below) shows how expanse made possible by steel framing helps capture nature in enclosed environment.



in the main and lean-to frames. Finally, a three-dimensional analysis was performed to check design of the composite system. All structural steel is A36. Box sections are continuously welded using E70XX electrodes. Total tonnage of steel is 246 tons and the roof framework weighs 9 psf. All shop and field connections are welded for a clean appearance.

Corrosive Environment Solved

The corrosive environment created by the large body of water in the pools had a significant impact on the structural design. Manmade sea water in the pools contains salt, chlorine, ozone and other trace chemicals. Airborne salt and evaporates are highly corrosive to metals and concrete alike. Several protective measures were adopted to minimize the corrosive effects of this potentially damaging environment. All structural elements are designed with minimum surface exposure and protected with special coatings. The choice of a box section reduced the exposed surface of the steel members. Butt connection of members by welding eliminated all inaccessible nooks and crannies at the connections. All steel surfaces were blast cleaned to SSPC SP 6 and coated with organic zinc epoxy paint.

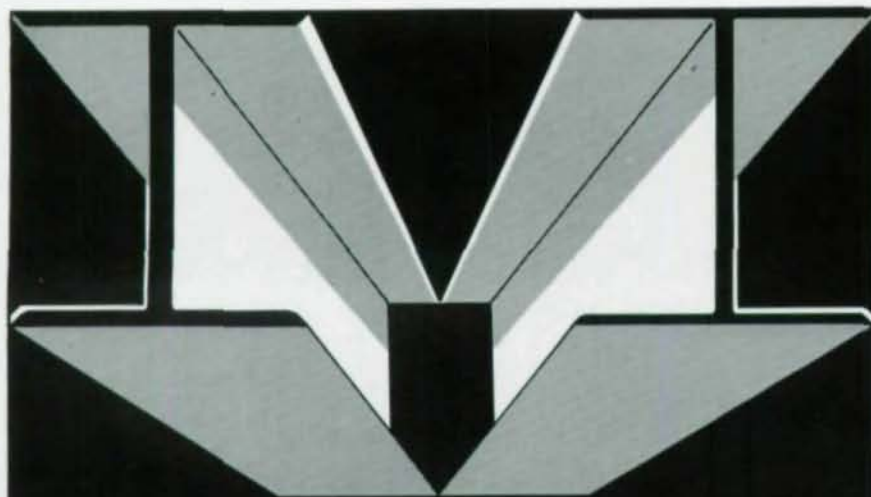

Our 40" and TAILOR-MADE rolled WF beams will keep your budget from going through the roof.

First is Arbed's new rolled 40" beam . . . available in 16 sections from 149 to 328 lbs. It gives high section moduli, great lateral buckling resistance, and competes economically with both fabricated sections, as well as reinforced precast and prestressed concrete.

Then there's Arbed's rolled "tailor-made" series (up to 42.45" x 18.13" x 848 lbs.)...that lets you specify the beam weight you need, other than what is normally available. Result? Big savings: in fabrication costs and weight.

Why not get all the facts? Send the coupon now for information including complete specifications.

TradeARBED Inc. 825 Third Avenue, 24th floor New York, N.Y. 10022
(212) 486-9890. Domestic Telex: (W.U.) 125 159, Int'l Telex (ITT) 421180.

In Canada: TradeARBED Canada, Inc., 1176 Blair Road, Burlington,
Ontario, Canada L7M 1K9. (416) 335-5710, Telex 0618258

Please send complete information on TradeARBED's 40" beams and
"TAILOR-MADE" beams.

Name _____ Title _____
Firm _____
Address _____
City _____ State _____ Zip _____

TRADE ARBED Inc.

10 INNOVATORS OF STEEL CONSTRUCTION PRODUCTS

For the roof construction, metal deck was considered unsuitable for the corrosive environment and precast planks too heavy for the large spans. Wood deck was selected because of its light weight and reduced vulnerability to corrosion. Cedar planks, 3-in. thick, were used. The tongue-and-groove deck joints were glued for diaphragm action. Nailer strips were anchored to the framing by welded studs to avoid punching the box section.

The erection process was a challenging task. The pieces had to be fitted together in the exact location with minimum deviation to achieve architecturally exposed quality. Tubular frame assemblies were detailed and prefabricated to demanding tolerances, then trucked to the site. Segments of the frame were lifted in place and assembled by temporary erection bolts before final welding. On completion of the welding, temporary connections were removed and the open holes were plug-welded. All welds were ground smooth for a clean appearance. Restriction of movement imposed by the already in place dolphin pools demanded extra attention and planning for selection of the crane size, sequencing of erection and difficulties of access.

The criteria imposed on the structural design by the guidelines of the Seven Seas Complex have been effectively met by the selection of a structural steel frame. The structure blends into the space, its slender dimensions are impressive and its smooth curved forms are aesthetically attractive. The simple, light and linear design of the steel frame will create a pleasing impression on the multitudes of visitors who will soon throng the Seven Seas Complex. □

Architect/Engineer

The Austin Company
Des Plaines, Illinois

General Contractor

The Austin Company
Des Plaines, Illinois

Steel Fabricator/Erector

Schelling Steel Co. Inc.
Posen, Illinois

Owner

Brookfield Zoo
Brookfield, Illinois

Ranjit Roy, S.E., is chief structural engineer for the Austin Company, Des Plaines, Illinois.

MODERN STEEL CONSTRUCTION

Hambro®...the most cost efficient floor system you can use.

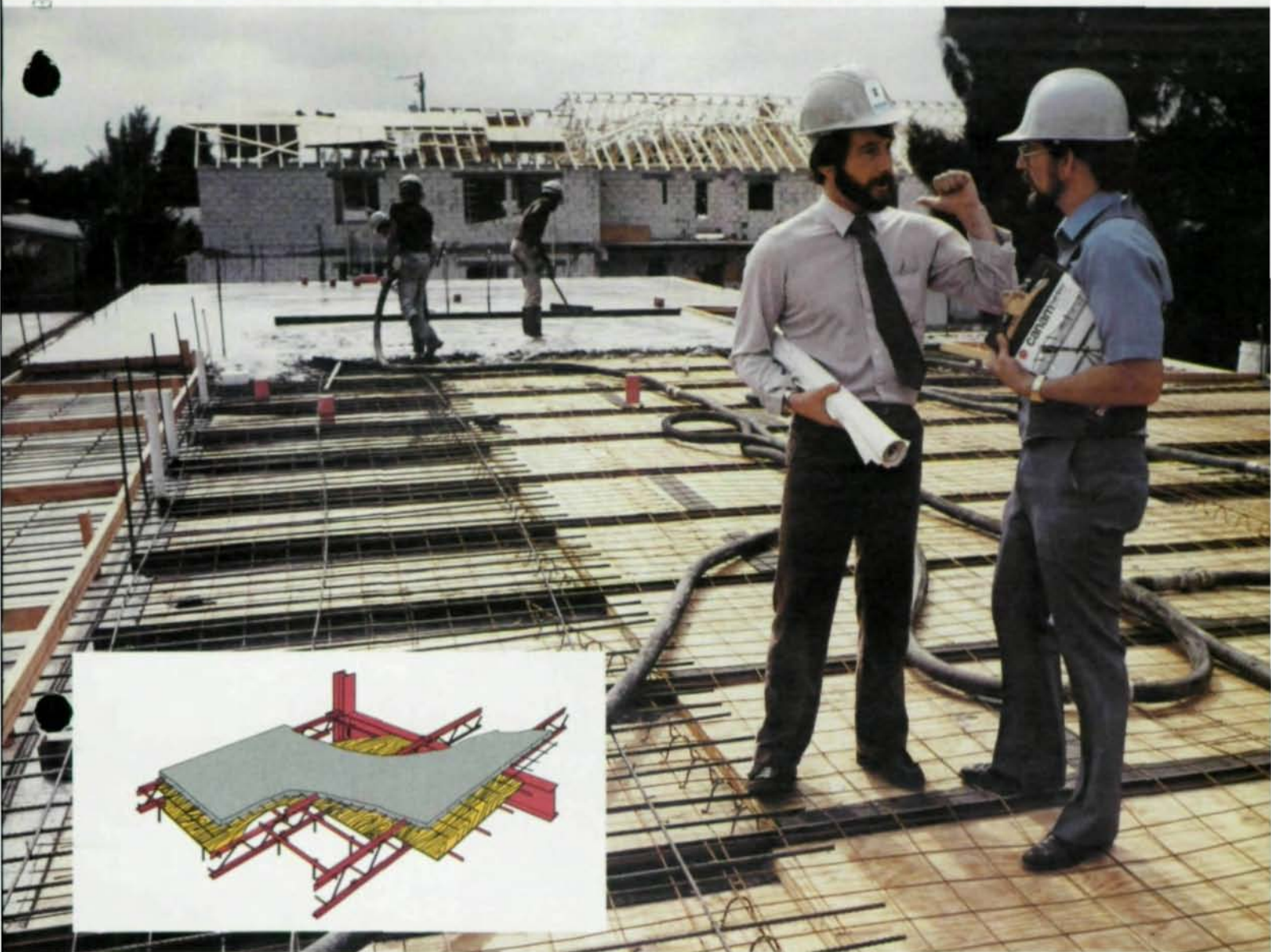

“We cast this Hambro composite floor today. We’ll strip it tomorrow.”

Robert Satter, President
The Satter Companies, Inc., West Palm Beach, FL

“The Hambro composite floor system saved us time, material and money when we used it to build our corporate headquarters, Congress Park IV,” says Robert Satter. “We cast a floor one day and stripped it just 24 hours later. By then, it was ready to use as a work platform. The plywood and roll bars are reusable. And the job required no bridging, or on-site welding.”

Hambro’s UL fire ratings are achieved without applying the 22/30 factor for reduction of capacity required for conventional “H” series joists. This, together with Hambro’s superior sound rating of STC 57, make it the ideal floor construction system for high or low rise commercial and residential buildings. Call or write for brochure.

 **canam steel** corporation

P.O. Box 223, Needham Heights, MA 02194 (617) 444-5504
Regional Offices and Distributors throughout the U.S.
In NYC, NJ, Eastern PA, MD, VA and DE: Mid-Atlantic Hambro, Inc.
114 East 25th St., Baltimore, MD 21218 (301) 338-1122 Telex: 87938

A subsidiary of  **canam manac**

Systems

GARDEN STATE PARK Steel Races on a Super-fast Track

by Pradeep R. Patel

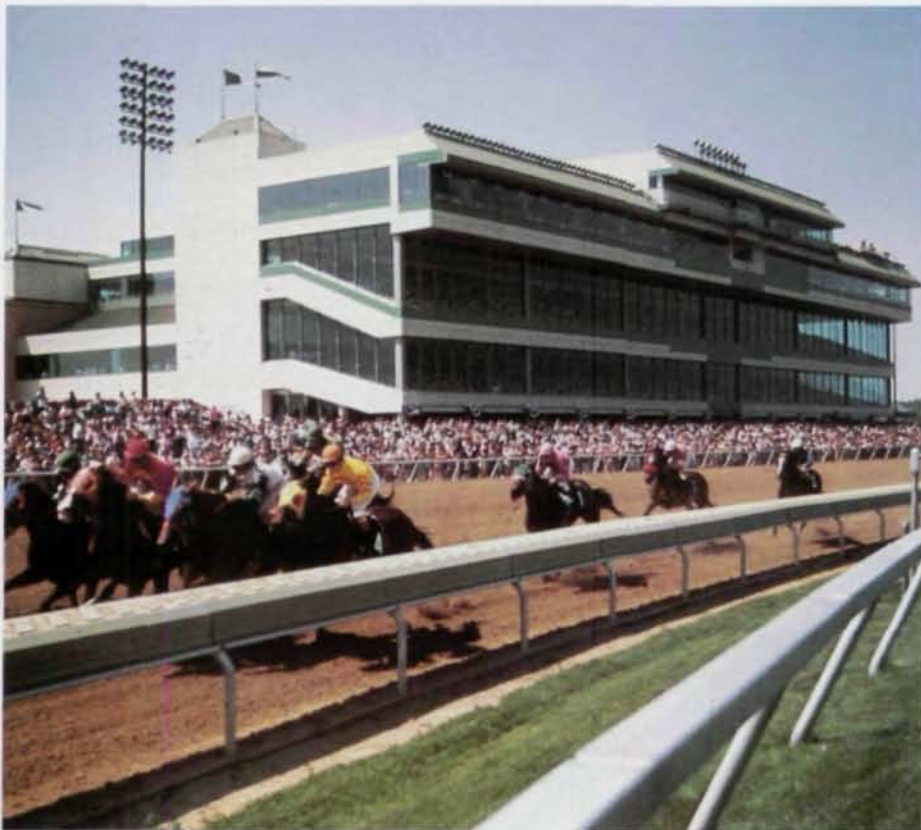

Trackside elevation of completed grandstand/clubhouse shows glass-enclosed structure supported by 50x60-ft bay structural steel framing.

In December 1982, a Philadelphia-based architect/engineer/interior designer firm prepared a proposal for the design of a new racetrack grandstand building for a client who hoped to purchase the old Garden State Park in Cherry Hill, N.J. This racetrack, about 10 miles from Philadelphia, had been destroyed by fire in 1977.

The architect proposed a fast-track schedule of 24 months for design and construction. However, the client lost out on his bid to purchase this 285-acre site. The new owner, International Thoroughbred Breeders, envisioned a much more ambitious development plan than originally proposed—and hired the same firm to design

a new, fireproof grandstand/clubhouse and other buildings to replace and expand the original facility.

The face of the project had changed—from a client with plans to spend several million dollars on a racetrack to one with a far grander vision for a multi-million dollar facility. But what did not change was the expectation to open on April 1, 1985. This new plan created a tremendously exciting challenge for the architectural/engineering/interior design team, as well as for the owner's: a 26-month schedule for a huge, multi-faceted facility, starting with schematic planning on Feb. 1, 1983 and ending when the doors opened on April 1, 1985.

Grandstand Structure

The structural steel scheme to meet this challenge was chosen because of its inherent quality of flexibility, ability to accommodate modifications in design and speed of construction, as well as its economy.

The footprint of the grandstand/clubhouse is about 220 ft x 400 ft, with 510,000 sq ft of total floor area. It rises to 80 ft, incorporating six levels above the basement: track level, grandstand level, grandstand mezzanine, clubhouse, special clubhouse and roof. The structure was to house special features, such as a glass-enclosed clerestory and an atrium entrance outfitted with escalators, stairways and a glass elevator.

The basic structural floor bay spans 30 x 30 ft, and 60- x 50-ft bays at trackside. Structural framing consists of 4½ in. normal-weight concrete on 2-in. composite floor deck, supported by A36 steel beams and girders. The trackside framing called for crippled-plate girders to suit the sightlines, fixed seating and dining terrace configuration. Cantilevered trusses were designed at roof level to support photo finish, television cameras and the judge's booth area.

Using structural steel enabled the design firm to accommodate long spans at the framed area at trackside. The 4½ in. normal aggregate slab, in combination with the A36 steel, provided the required two-hour rated floor system. It also created a floor of sufficient mass and rigidity to control transient vibrations to a limit below occupant perceptibility, a common problem in structures with large floor areas unbroken by partitions and subject to cyclic loading.

This structure included a large, glazed area with a minimum amount of stiffening elements. Expansion joints were provided; however, the provision of 60-ft bays at trackside, in combination with expansion joints and tall glazing elements, was dependent upon structural frame stiffness for stability. This created a real challenge for

the design of the structural steel elements, since stiffening elements (braces and the like) could not be introduced.

A computer frame analysis evaluated the drift caused by wind loading on the glazed box and the structural framing elements (i.e., columns, framing beams with moment connections). These elements were designed to control the drift to levels within the sway limitations for glazing elements.

The simplest but toughest criteria for structural framing design was to strike a balance among the following factors:

- Human comfort, considering vibrations in large open areas subjected to cyclic loading.
- Long-span framing requirements at trackside coupled with shallow construction depth for optimum sightlines.
- Sufficient mass and stiffness for controlling transient vibrations.
- Design of slender structural framing elements without bracing to support tall glazing elements at trackside subjected to high wind pressures normally present at any open site.

All of these considerations led to a structural design of the framing system controlled by stability, deflection and drift con-



Grandstand/clubhouse structural frame at trackside

TIME...

it's the only totally irreplaceable resource. How it's utilized, how it's invested determines how successful one will be. We've created time efficiency by creating the leading edge in computer aided design and detailing - SDS/2.

DESIGN DATA

"Software For The Professional"
800-443-0782

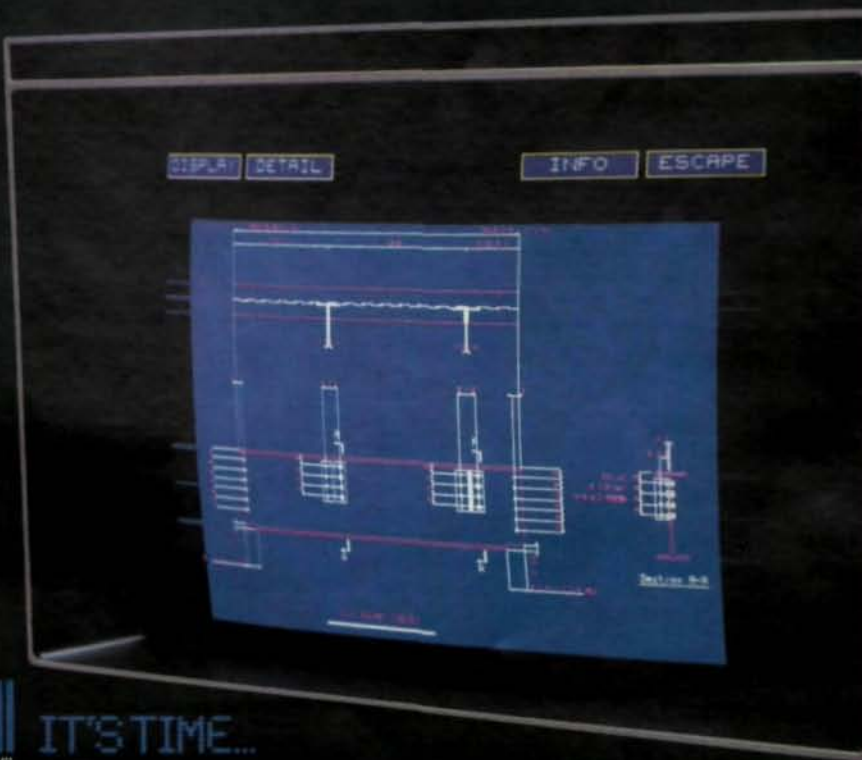

IT'S TIME...

tol of the frame, rather than by stresses in material. Under these criteria, and based on the designer's extensive experience designing stacked grandstand/clubhouse facilities, the selection of A36 steel became an obvious choice. This particular structural steel also allowed flexibility in the architectural design with regard to the shape and geometry, as well as flexibility in using various building facade materials chosen for economic and aesthetic reasons.

The main entrance of the building was most complex in structural detailing, its atrium, shiny finishes and Tivoli lights expressing the theme of "festive" public architecture. Structural steel framing permitted design refinements in this prominent area until the last minute in this super-fast-track project.

In total, this complex grandstand structure showcases the diverse possible uses of structural steel material: from a simple, 30 x 30-ft steel frame to a 60-ft high clerestory skylight area; from a cascading stairway frame to a 50 x 60-ft trackside area of varying functional configurations; from a support of a simple metal panel exterior wall to a complex support framing system for the trackside glass box, with a minimum



Crystal Paddock's glazed facade (above) supported by 27-in. valley beams. Below, clear-span space is created by exposed steel trusses of wide-flange shapes.



of structural elements to ensure patrons of a clear view of the track.

Fast Tracking

This super-fast-track project was as much a test of structural management as it was of structural design. Since concrete cast-in-place piles would support the columns, the foundations, too, had to be designed

on the fast-track schedule; the foundation completion schedule called for starting the erection of steel by November 1983.

Structural steel construction documents were begun in April 1983, and bids received on July 7, 1983 for this 5,200-ton steel-framed project. Some 1,400 shop drawings were reviewed over four months, and the structural steel was fabricated and

erected by April, 1984. The building was completed on schedule in exactly one year.

Crystal Paddock

The Crystal Paddock is a novel, open-air structure 180 x 180 x 90 ft high (maximum) with a cascading glass roof. Adjoining the north face of the grandstand/clubhouse building, this paddock embodies a new concept in racetrack design by allowing patrons on all five levels of the grandstand/clubhouse to watch the horses being saddled and walked before each race.

Elegance was achieved in the exposed framing construction by using simple framing elements painted white. A 90-ft span-welded truss design, using rolled shapes, provided column-free space in the paddock near the main building. Deflection of the structural steel framing elements, as well as the sway of column bents were scrutinized, since columns were slender and few for this tender glass box. Knee braces, used judiciously, played a major role in architectural/structural design integration by achieving stiffness and minimizing sway under wind loading.

Other examples of harmonious architectural/structural design integration include the uniform depth of structural framing, geometric layout of secondary trusses created by steel angles laced between glazing support steel in the planes of glass and use of boxed-steel members where necessary for the first glass-enclosed paddock ever built. □

Architect/Structural Engineer

Ewing Cole Krause,
the sports facilities division of
Ewing Cole Cherry Parsky
Philadelphia, Pennsylvania

Construction Manager (joint venture)

Torcon, Inc.
Westfield, New Jersey
Costanza Contracting Co.
Pennsauken, New Jersey

Structural Steel Fabricator

Owen Steel Company
Columbia, South Carolina

Owner

International Thoroughbred Breeders, Inc.
East Windsor, New Jersey

Pradeep R. Patel is a principal and director of structural engineering at Ewing Cole Cherry Parsky, architects, engineers and interior designers, with offices in Philadelphia, Pa. and Haddonfield, N.J.

Design

HARGER WOODS CENTER

A Crisp Look in Suburbia

Harger Woods Corporate Center brings a new look to the suburban Chicago office market. The use of structural steel as an architectural feature creates a fresh, crisp image for the 65,000-sq. ft building on an interesting triangular site just east of the famed Oak Brook (Ill.) shopping mall.

The importance of the 3.3-acre site at the junction of two well-traveled highways dictated a building to catch the eye of a variety of tenants—both large and small—as well as respond to the constraints of the site itself. The resulting design configures

the building as three office pods, two stories high, centered by a 3,700-sq. ft skylighted atrium. The three distinct pods—each floor containing about 10,000 sq. ft—offer smaller tenants an opportunity to have their own identity, yet provide the areas required by larger tenants.

The entrance treatment creates a striking introduction to the building. A two-way private drive from Harger Road circles past the main entrance and its outlined by white aluminum bollards, which are lit at night. The exterior is white-painted architectural

steel using built-up welded plates for the spandrels and columns. The architect chose steel to create the sharp, detailed delineation and enhanced shadow lines demanded by the design. Other types of building materials would not have provided such clear definition to the exterior of the building. A smooth, monolithic surface is ensured by exterior welds, while the interior framework consists of simple bolted connections.

The first floor of the two-story building is set back 5 ft from column line to glass. To

Harger Woods Center presents new look for suburban office market. Exposed structural steel framing adds architectural highlight and fresh image.

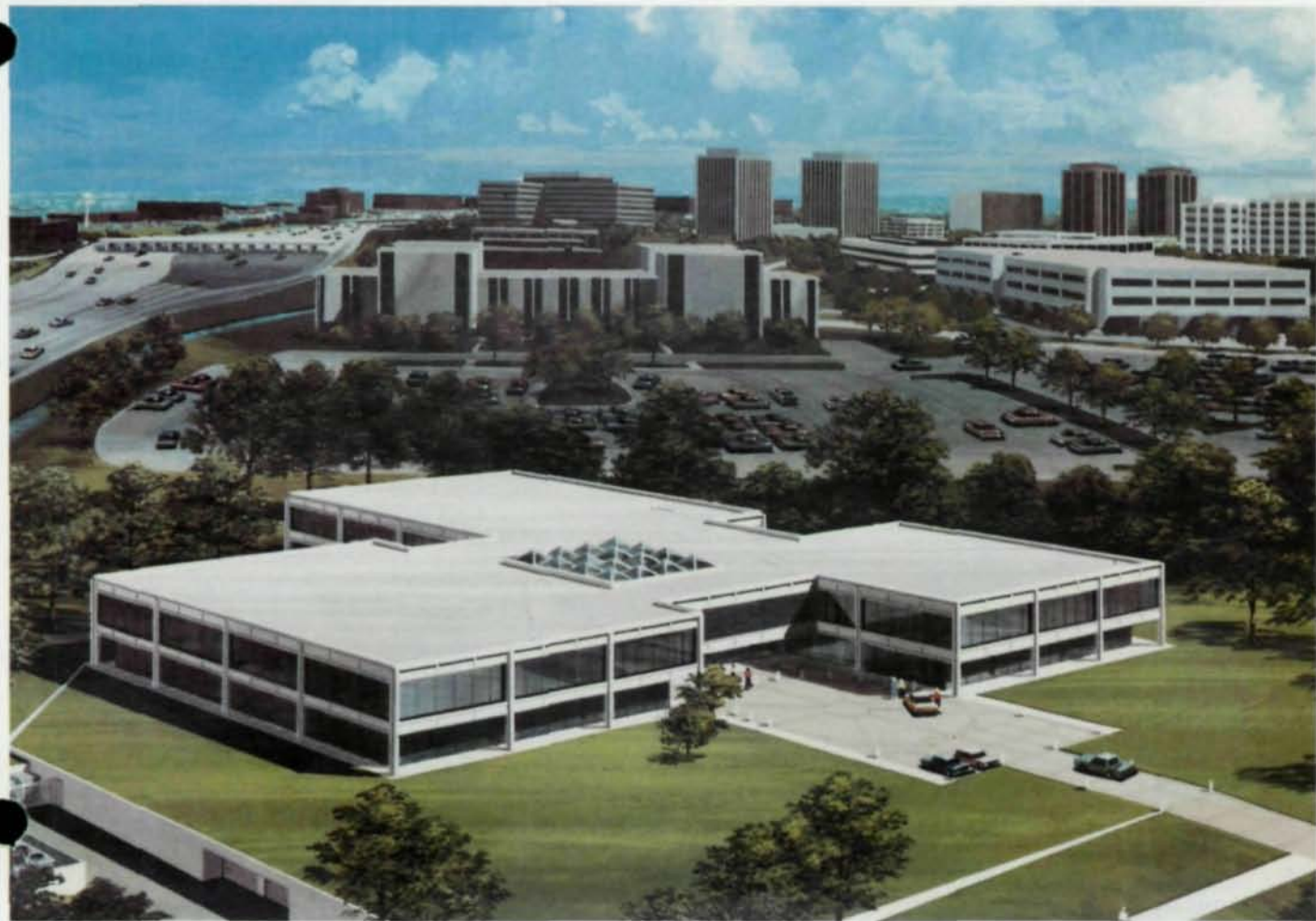

clearly define the presence of the atrium, which serves as the building lobby, the exterior of the first floor has 9-ft high clear glass panels, while Carnelian granite panels, also 9-ft high, are used on the exterior of the second floor. For contrast, a butt-glazed system of gray tinted glass defines tenant areas.

An unusual amenity of the building is an underground parking area with space for 230 cars. Access is down an inclined drive from Harger Road directly into the garage. The atrium is carried down into the parking area, so a tenant or visitor steps from a car immediately into the atrium. Access to the floors above is provided by hydraulic elevator or structural steel stairs. The cantilevered stairway—formed of built-up steel plates and structural steel tubing—floats up through the building as both a functional and sculptural element. Architectural steel was chosen for the same reason as on the exterior, the clarity of line created by the material. The steel is painted white and treads and risers are polished terrazzo.

The atrium serves as the focal point of the building, functioning both as an entrance and as a bridge between all office spaces. The same terrazzo used on the stairway carries into the atrium. The granite-clad elevator core and flush panels of Sapele mahogany provide additional richness. And an overhead skylight of 16

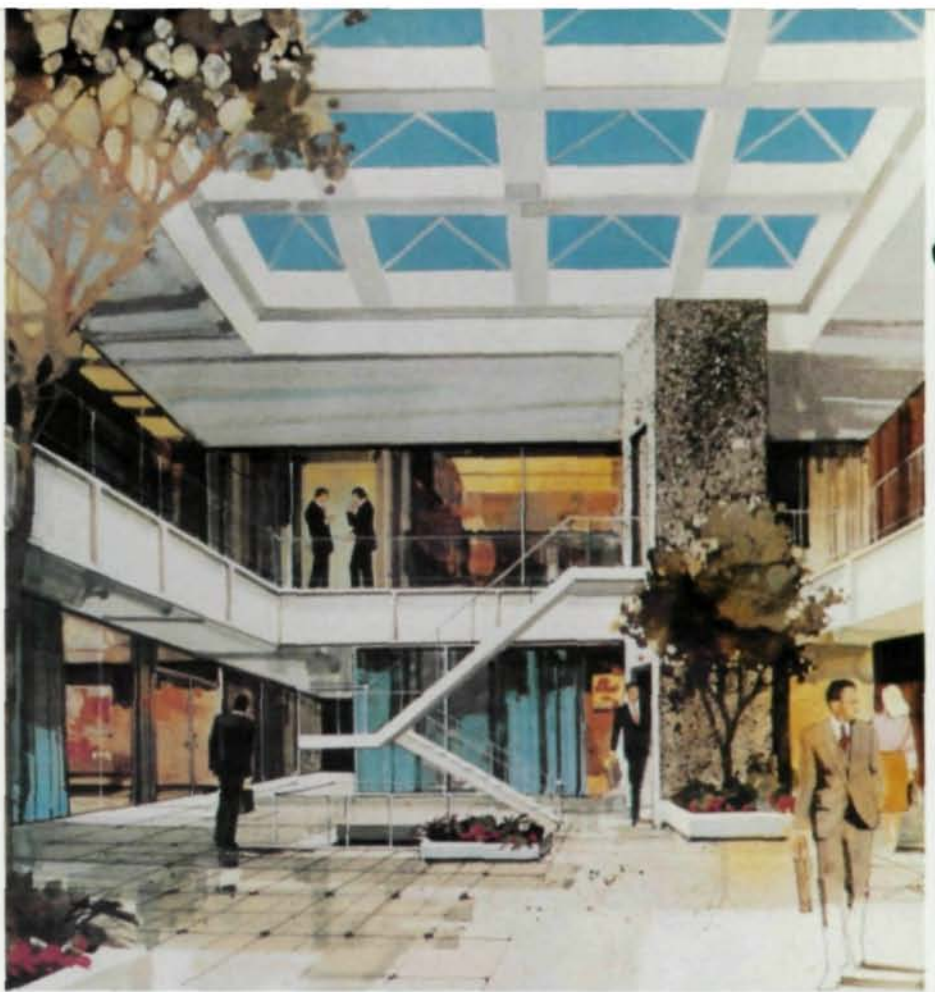

Architectural rendering of atrium, which also serves as lobby. Cantilevered stairway floats upward to repeat design elements of building. Interior frame is simple bolted connections.

Simple structural steel framing employs built-up welded plates for spandrels and columns to create sharp shadow lines.



clear-glass pyramids pours natural light into the atrium. Common core elements clustered in the atrium also give tenants great flexibility in their arrangement of office space.

Architectural and Structural Needs in Total Harmony Using Steel

The peripheral frame of A36 steel is 36-in. deep, 6-in. wide plate girders and star-shaped 14 x 14-in. fabricated plate columns. This frame, in addition to its architectural function, carries lateral loads as well. Special efforts were made to simplify the welding process by using partial penetrations only. This eliminated the need for backing bars and sizing the columns, thus lateral stiffeners were not needed. Problems with the re-entry corners of the frame led to some innovative framing ideas and connection details.

The basic steel framing is a composite construction for the second floor and non-composite for the roof. Very large ducts through the girders resulted in opening sizes which fell well outside of published design aid limits, and thus required special design. To be cost effective, optimization between reinforced holes versus heavier girders with unreinforced holes was made. Also, the cantilevered floating stairway required extensive computer analyses and posed challenging erection problems.

All the elements of a successful building—excellent location, thoughtful, exciting design and careful construction—blended in Harger Woods Corporate Center. □

Architect

Fujikawa Johnson and Associates
Chicago, Illinois

Structural Engineer

Cohen-Barreto-Marchertas, Inc.
Chicago, Illinois

General Contractor

Harbour Contractors, Inc.
Oak Brook, Illinois

Steel Fabricator

Munster Steel Co., Inc.
Munster, Indiana

Owner/Developer

Barofsky and Associates
Oak Brook, Illinois

Exterior rendering by Howard Associates
Interior rendering by Brian Keith



Common core elements, provided by steel framing, permit tenants greater flexibility in office planning.

**WE
PUT
100
YEARS
OF
EXPERIENCE
IN
EVERY
BOLT WE MAKE**



We operate the largest facility in the country for making big and special bolts. Just as important, we're big on dependable service and reliable delivery.

We're St. Louis Screw & Bolt and we make a full range of heavy structural bolts. Our entire manufactured product line, including Types I and III, is made from domestic materials and tested in our St. Louis plant. We're big on quality, too.

After 100 years, we know big bolts in a big way.

ST. LOUIS SCREW & BOLT COMPANY

6901 N. Broadway/St. Louis, MO 63147/(314) 389-7500



SINCE 1887



VULCRAFT SUPER LONG

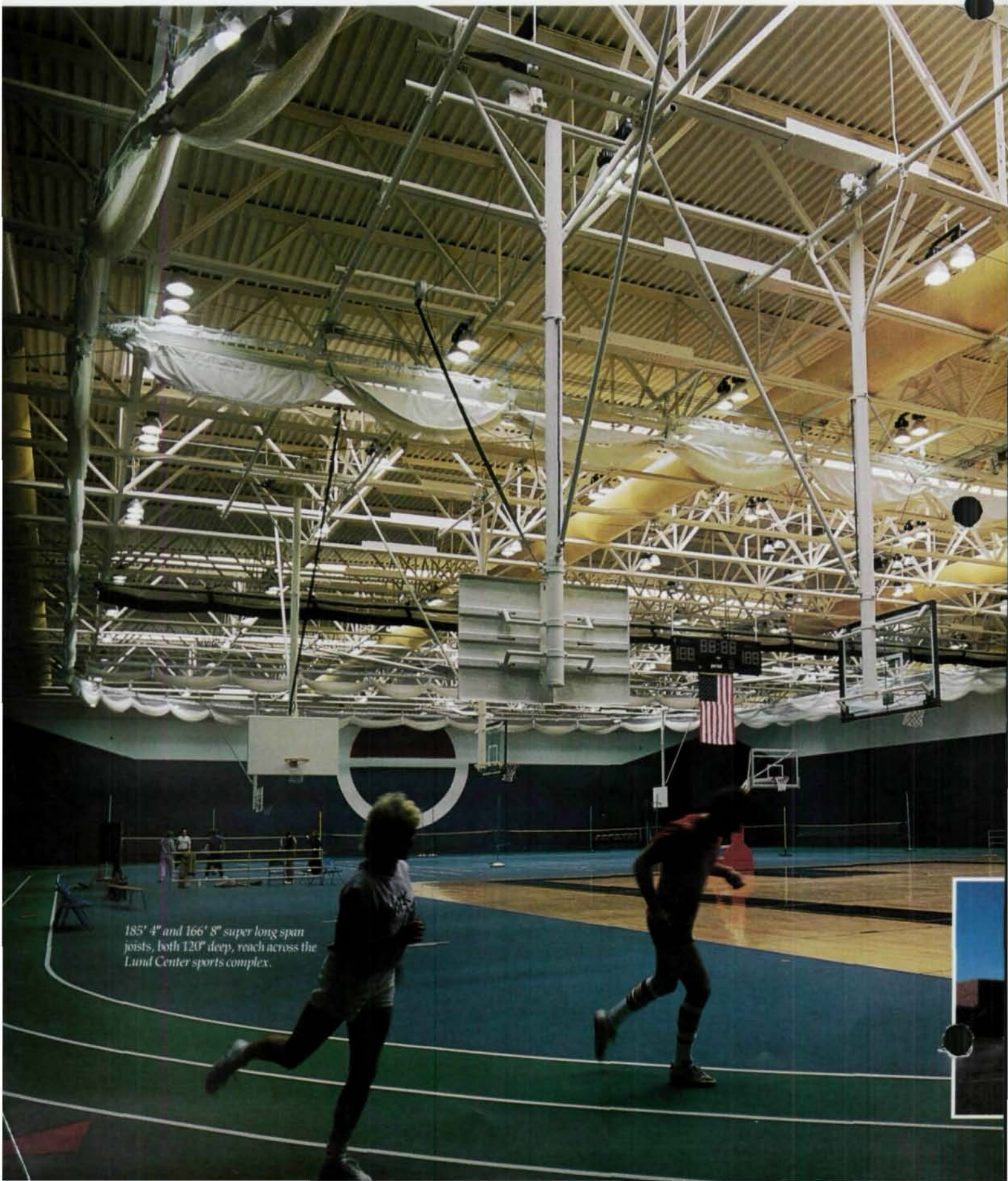

185' 4" and 166' 8" super long span joists, both 120" deep, reach across the Lund Center sports complex.

SPANS GO THE DISTANCE.

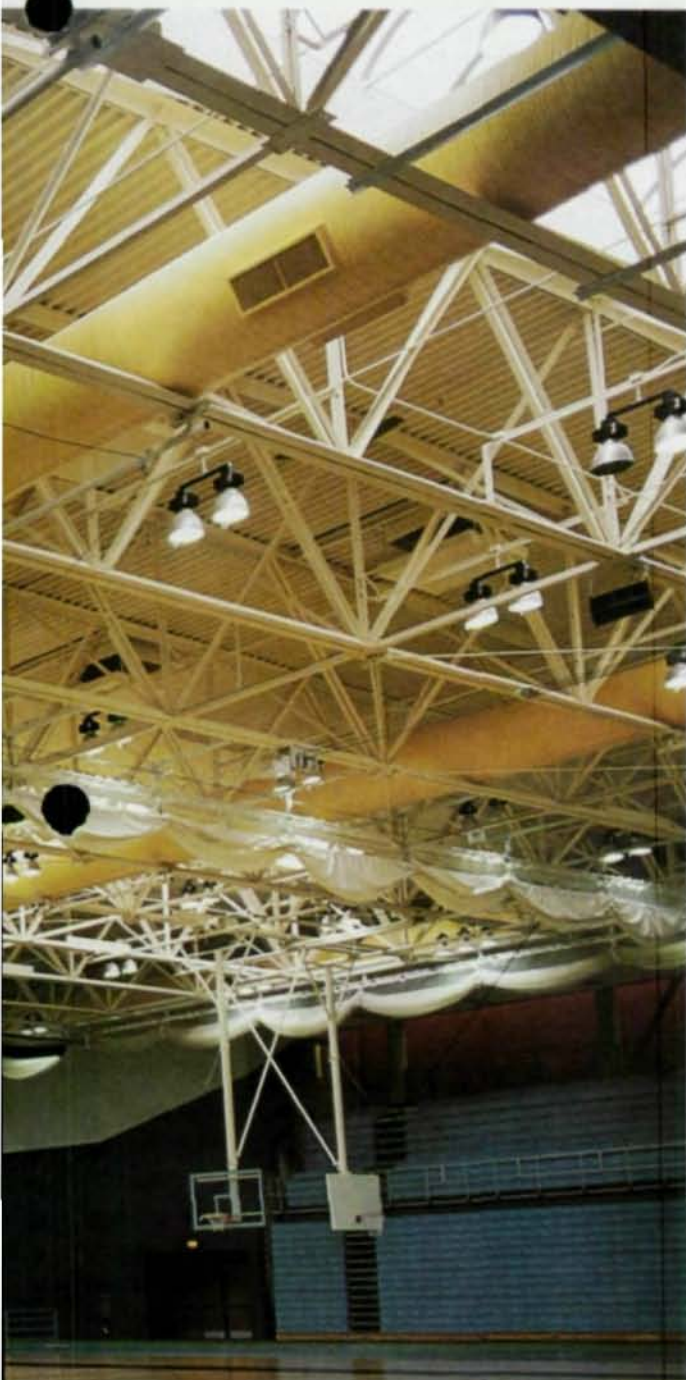

The Lund Center of Gustavus Adolphus College

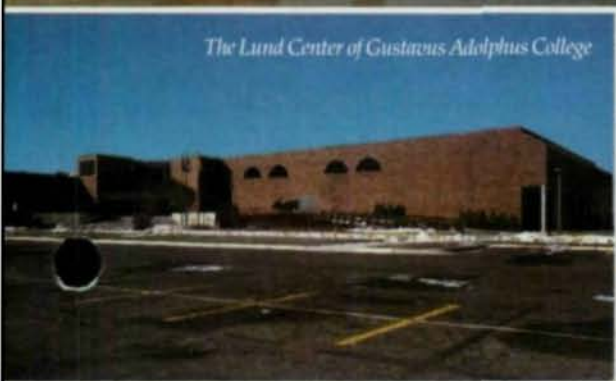

To build a sports complex as large and expansive as the Lund Center at Gustavus Adolphus College in St. Peter, Minnesota required a structural system that could go the distance. Vulcraft super long span joists were clearly the front runner.

As a result of careful analysis, Vulcraft super long span joists were selected over the other two alternatives: conventional trusses and rigid frame construction. The open configuration of Vulcraft super long spans provided a number of advantages. While long enough to span a basketball court, indoor tennis courts, and a running track as well as spectator seating, Vulcraft super long spans provided a strong, lightweight, and easy to install system. The open configuration of the Vulcraft joists also permitted the heating and ventilation ducts and electrical systems to be run through the spans. This created an uninterrupted ceiling line for the automated divider screens which separated the different sections of this vast sports complex.

Since the college is dependent on private funding, the savings afforded by using Vulcraft joists helped make it possible for the college to initiate the project. Also, by using Vulcraft's economical 3" N 20 gage deck, joists could be spaced farther apart. So, fewer joists were needed and construction costs were further reduced.

When your job has to go the distance, let Vulcraft put you out front. For more information concerning Vulcraft steel joists, joist girders and steel deck; or, for copies of our joist and steel deck catalogs, contact the nearest Vulcraft plant listed below. Or, see Sweet's 5.2/Vu and 5.5/Vu.

P.O. Box 637, Brigham City, UT 84320 801/734-9433
 P.O. Box F-2, Florence, SC 29502 803/662-0381
 P.O. Box 169, Fort Payne, AL 35967 205/845-2460
 P.O. Box 186, Grapeland, TX 75844 409/687-4665
 P.O. Box 59, Norfolk, NE 68701 402/644-8500
 P.O. Box 1000, St. Joe, IN 46785 219/337-5411

VULCRAFT

A Division of Nucor Corporation

Architects/Structural Engineers: Toltz, King, Duvall, Anderson & Associates. Steel Fabricator: Ted Mannstedt and Son, Inc. General Contractor: Kraus-Anderson Construction Company, Minneapolis Division. Steel Erector: Vickerman Construction Company.

Spanning the gap in bridge construction

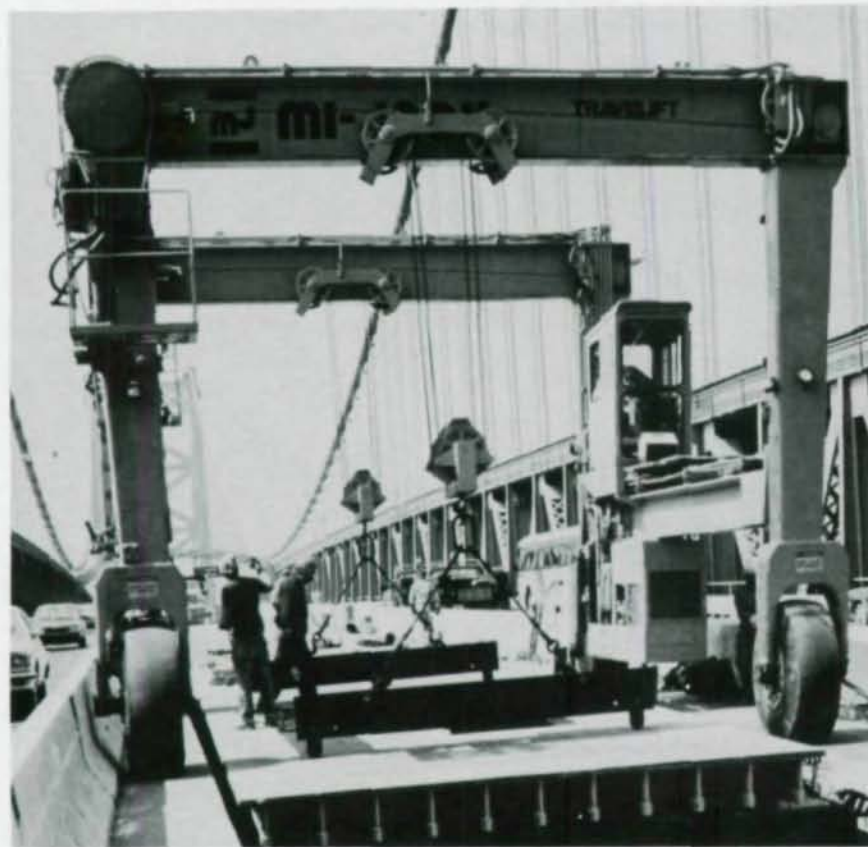

A single Mi-Jack TRAVELIFT crane replaced two hydraulic boom cranes and numerous hydraulic jacks on the Ben Franklin Bridge renovation project, reducing equipment and maintenance costs, personnel requirements and extending the hours worked per day.

Installation of new orthotropic bridge panels took just half the time required previously. Traffic flow on the bridge was maintained in both directions for the duration of the construction project.

A spokesman for the construction firm said, "The TRAVELIFT crane has met all our needs." And no wonder! Backed by 30 years of experience and over \$7,000,000 in spare parts inventories nationwide, Mi-Jack's Service and Parts departments specialize in keeping machine downtime to a minimum.

Let a Mi-Jack representative show you how a TRAVELIFT crane can span the gap in your next bridge construction project.

Mi-Jack TRAVELIFT, 3111 West 167th Street, Hazel Crest, IL 60429. (312) 596-5200.

STRUCTURAL ANALYSIS SOFTWARE FOR IBM MICROCOMPUTERS

Fast, accurate, inexpensive and easy-to-use software for the analysis of 2-D or 3-D frames and trusses.

BEAMS AND FRAMES

BEAMS AND FRAMES is an interactive computer program that quickly performs structural analysis of continuous beams and 2-D multi-bay/multi-story frame structures.

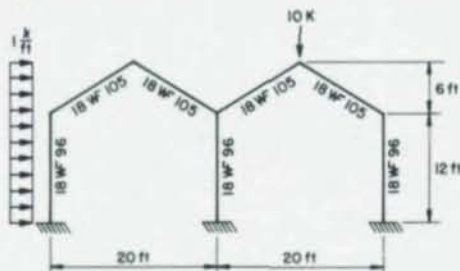

- Hardware Requirements: IBM-PC or Compatible with 256K Ram, Floppy Drive, Monitor and Printer.

BEAMS AND FRAMES Cost \$295.00
Trial Offer (1 Month) \$25.00

FRAME3D

FRAME3D is a general purpose structural program for analysis of 2-D or 3-D frames, trusses, floor systems, towers, etc.

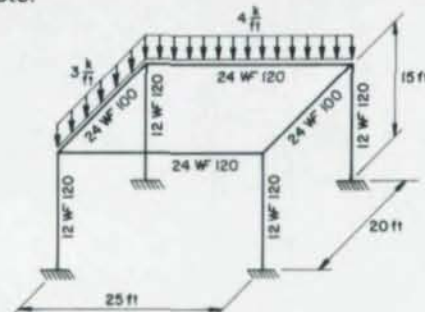

- Hardware Requirements: IBM-PC or Compatible with 512K Ram, Floppy Drive, Monitor, Printer, Hard Disk (Recommended), and 8087 Coprocessor (Recommended).

FRAME3D Cost \$495.00
Trial Offer (1 Month) \$40.00

One month trial offer applicable toward purchase price. Purchase both programs for \$595.00 and save \$195.00

For More Information Call or Write

Compu-Tec Engineering • 300 Chesterfield Center Suite 205 • Chesterfield, MO 63017 • (314) 532-4062

Steel Solution

THE NOVI HILTON Silver and Steel Working Together

by Ed Samson and Carl Knaebel

"Slick" is the term most frequently applied to describe the ultra-modern Novi Hilton Hotel in suburban Detroit. Set as the cornerstone of an office park containing such names as Digital, Hewlett-Packard and Norris Industries, the architecture demanded a fitting symbol for such an area. Its prominent position on a hillside overlooking the busy I275 expressway also demanded an eye-catching, eye-pleasing design for motorists.

Bright silver horizontal lines and an angular design set the style of the hotel. Foam-insulated steel sandwich panels using a baked enamel silver coating are alternated with Ford double-glazed silver reflective ribbon windows. Offsets with 45° angles separate the two wings of the guest room tower and provide a visual interest to the horizontal ribbons.

The seven-story hotel features 237 guest rooms on the second through seventh levels, plus nine parlor suites to double as conference rooms for smaller meetings. A Conference Center features a 9,000-sq ft Grand Ballroom to accommodate up to 1,050 people in one function, or it can be divided into separate sections with moveable partitions. A 100-seat Amphitheatre is featured in an adjacent section of the Center.

A large, uninterrupted ground floor area below the guest room tower serves as a spacious lobby, and holds the two restaurants and lounge. The desire to achieve this ground-floor open space led to the ultimate selection of a steel frame.

Why Steel?

Old-fashioned hotels typically have small lobby areas broken up by the numerous columns and walls necessary to support concrete or masonry walls. By using steel framing, the need for load-bearing walls and numerous columns was eliminated.

Number1/1987



Ultra-modern Novi Hilton Hotel in suburban Detroit

Transfer girders were considered for opening up the ground floor and supporting the walls and floors above, but potential deflection problems and the massive columns required for this method made this alternative unacceptable. Other reasons for using steel framing were the angular configurations used throughout the hotel, the economy and speed of steel construction and the need to keep a low building profile.

The fastest form of construction available is to use precast concrete floor plank on a supporting structural steel framework. This eliminated most of the slower wet-trade construction, and also permitted structural work to be performed in an easily controlled sequence. Steel erection alternated with the placement of the floor planking, which allowed double work crews to erect the structural system as quickly as possible. Structural work could also proceed without concern for winter heating and weather protection.

A second benefit to the steel/precast construction system was the minimal floor-to-floor required. The City of Novi limits

structures to 65 ft above grade. Because of the sloping site and a retaining wall placed at the back of the structure, it was possible to use an actual building height of 70 ft. The typical floor-to-floor height for the guest room floors is just 9 ft. For the second floor, the floor-to-floor height was raised to 9 ft-8 in. to improve the quality of the smaller conference suites. The ground floor level was given a 15 ft height, with the city height restrictions met.

The Structural System

An all-bolted steel system using Type II framing with wind-moment connections in both directions was selected for speed and economy. WT sections were used for the wind connections up to the third floor, and angles for the upper levels. This system allowed for spaces uninterrupted by bracing, without the need for masonry or concrete shear walls.

The guest room tower framing is 58 ft-6 in. front to rear, broken into 20-ft, 18 ft-6 in. and 20-ft bays. Longitudinally, the tower uses typical 27-ft bays. The 8-in. precast plank spans the 27-ft direction in the 20-ft

wide bays under the guest rooms. The plank spans the 18 ft-6-in. direction down the central corridor area and supports the bathroom areas of each guest room as well. For the floor beams that spanned transversely below the central corridor, end-plate connections were used. These beams were raised 7 in. above the other supporting steel so that the top of the steel beams came one in. below the top of the parallel concrete planks. This provided additional headroom for the mechanical, plumbing and electrical systems that run down the corridor.

In the longitudinal direction of the guest room tower, there are 11 bays of 27 ft. The south end uses six bays for guest rooms and the elevator lobby, which angles outward at 45° starting two bays from the expansion joint. This offsets the two ends of the tower by 38 ft-6 in. The north end of the tower has five bays, with stairs at each end of the tower. Special auxiliary framing was added at each end of the tower to provide 45° points that project 8 ft-5 in. beyond the otherwise straight face of the tower.

The precast planks used were typically 48 in. wide and 8 in. thick. They were anchored to the steel framing with embedded anchor plates field-welded to the structural

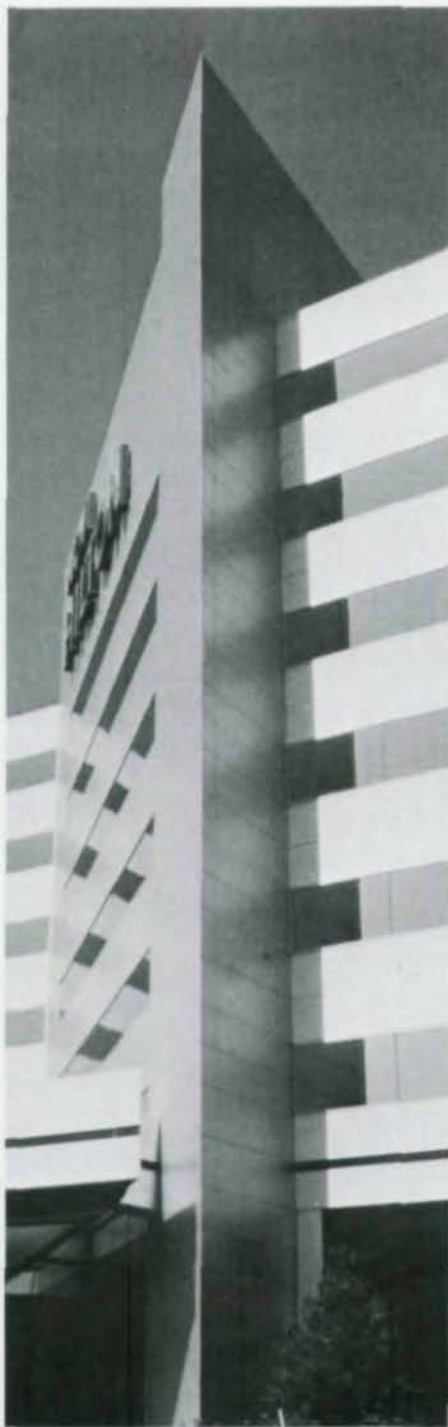

Porte Cochere, dramatic drive-through canopy, serves main entrance.

steel. For the guest parlor/conference rooms on the second floor, 10-in. planks were used because of the heavier floor loading requirements. Weld plates were cast into the plank at third-points to help maintain alignment and to level floors. A self-leveling topping was applied to the precast planks to assure an even floor surface. The underside of the plank, which serves as the finished ceiling, received a textured paint.

A basement area below the lobby holds both hotel service equipment and the health facilities of the hotel. Steel beams

with 3-in. composite metal deck frame the lobby floor. A 30-in. floor beam cantilevers out 11 ft on a 45°-skew to support an overhanging part of the lobby seating area overlooking the basement-level pool. Above the pool, a sloping TS18 x 6 member, also at a 45°-skew, frames the roof to the corner column and supports the skylight system.

The roof of the guest room tower was framed with conventional steel framing and bar joists supporting a 1.5-in. metal roof-deck. The clear spans of the Conference Center Ballroom are provided by three steel trusses 72 ft long supporting steel bar joists 34 ft long. Other low roof areas over the kitchen and service functions were framed with conventional beams and joists.

Soil conditions at the site varied considerably, so it was necessary to use a combination of drilled straight-shaft caissons and spread footings. The site also contained a high water table and underground stream that required considerable dewatering. The underground stream now helps feed a pond in front of the hotel.

Special Features

A dynamic feature of the hotel is the "Porte Cochere," the drive-through canopy at the main entrance to the lobby. Brightly lit, the canopy follows the 45°-skew of the project, but appears to be supported only by its two exterior columns. The porte cochere is separated from the main structure by a sloping glass skylight, adding to its floating appearance, but is actually supported by a system of cantilevered beams from the main hotel structure in four locations, plus the two exterior columns.

The 2¼ in. thick insulated sandwich panel used for the curtainwall is attached to the supporting structure by a metal stud backup system. The studs are, in turn, attached to embedded plates in the precast floor plank at third- and mid-points of the outermost planks, and also to the steel columns. The stud backup system, provided by the curtainwall contractor, was prefabricated to speed erection. Additional fiberglass insulation was placed in the studwall cavities to provide a more energy efficient curtainwall.

Individual heating and cooling units in each room are fed by vertical chilled and hot water lines run through pipe chases in the precast floors. The small fan-coil units are built into the drywall partition between guest rooms.

Fire protection is provided by a full sprinkler and detector system throughout. Steel beams and columns supporting the first and second floors received spray-on fireproofing. Beam and column framing at the

MODERN STEEL CONSTRUCTION

Metal Building Bolts

Serving the nation with the world's largest stock of A-325 Bolts under one roof.



Ask for a copy of our Price Catalog featuring A325

We carry a complete line of bolts and nuts for the building trade

METAL BUILDING BOLTS CORPORATION

10934 HAZELHURST, HOUSTON, TEXAS 77043
TELEPHONE (713) 461-0505

third floor level and above is protected by the two-hour rated drywall partitions and column enclosures. Roof decking and floor decking also received spray-on materials, but the steel joist roof framing is protected by a fire-rated ceiling.

The building is designed for future expansion to the west. Six floors of additional guest rooms were anticipated for the area above the rear service area, tying into the main lobby where the existing guest room tower is offset. Bolt holes in the steel columns were provided to facilitate construction of this future addition.

Construction Schedule

Design of the project began in earnest in the Spring of 1983. The construction manager took bids on the structural steel and precast plank packages in November 1983, with steel erection beginning with the completion of foundation work the following April. Erection of the structural system was closely coordinated between two subcontractors. The steel erector set the first two floors of one end of the guest room tower, up to the expansion joint that separates the two wings. They then moved to the opposite end of the tower to erect steel as the precast erector placed the plank on the steel frame just erected. The two erectors continued this alternating pattern to complete the 850-ton structural frame in just eight weeks. A gap in the schedule allowed the steel erector to set the Conference Center with no loss in total completion time.

The hotel opened for business in July 1985, and plans for the expansion are now underway. The use of structural steel framing enabled the architect and engineer to construct a modern hotel facility that will both serve as a cornerstone to the area and project an image of high technology and the future. □

Architect/Engineer

Nordstrom-Samson Associates, Inc.
Dearborn, Michigan

Construction Manager

SNG Associates
Dearborn, Michigan

Steel Fabricator

Carter Steel and Fabricating Company
Bellevue, Ohio

Owner/Developer

Orchard Hill Place III Properties
Novi, Michigan

Ed Samson is principal and Carl Knaebel a structural engineer with Nordstrom-Samson Associates, Inc., Dearborn, Michigan.



Continuing Education Program



Structural Software Company

Presents — "Computer Detailing with Steelcad II"



Structural Software Company

Wednesday, February 18, 1987

Session: 9:00 A.M.-12:00 Noon

Holiday Inn-Metro Airport

31200 Industrial Expressway (I-94 at Exit 198)

Romulus, Michigan 48174 (Detroit Area)

(313) 728-2800

Structural Software Company of Roanoke, Va. will be conducting a FREE seminar on computerized detailing. This seminar will be held February 18, 1987 from 9:00 A.M. to 12:00 Noon at the Holiday Inn-Metro Airport. Won't you please take a few moments to review the features list to see the many advantages that STEELCAD II has to offer.

If you would like to attend Structural Software's seminar, please return the registration form by February 12, 1987 or call John Fore at 703-362-9118 for reservations.

STEELCAD II FEATURES

WILL DO

- Runs on IBM PC and PC compatible computers
- Design Connections
- Multiple Member Input
- Handles Beams, Columns, Girts
- Global Connections, Sitings
- Generates Bill of Materials
- Generates Shop and Field Bills
- Place by Piece detailing system
- Handles Slopes
- Continents
- Easy to handle 11x17 sheets for shop use
- No Cad required
- Interfaces to AutoCAD or Viscad
- Interface available to Structural Software's Production Control Program for automatic input of bill of materials
- Handles joist and truss girders connection
- Welded or bolted connections with end plates shear tab
- Can do opposite hand beams and columns with minimum effort
- Generates shipping marks
- Can rotate columns, base plates, etc.
- Can handle wide flange, channel, tube, pipe, angles and plates
- Runs on IBM AT Computers
- Column splices
- Up to 8 different elevations

COMING SOON

- Horizontal or Vertical Bracing
- Moment Connections
- Anchor Bolt and Erection Plans
- More than 2 level columns permitted
- Option to use 24/36 sheets

IN THE FUTURE

- Hip and Valley Conditions
- Stairs, Rafters, Ladders and other miscellaneous Steel
- Trusses

Structural Software Co.

2839 Peters Creek Rd., Roanoke, VA 24019
(703) 362-9118



Louisville Galleria, Louisville, Kentucky. Skidmore, Owings & Merrill

Engineering. Quality. Performance. It's the formula you need to make great ideas happen.

Structural steel is only the beginning when you do business with Haven-Busch. Our century of service to the construction industry has helped make us the company you can count on to bring your best ideas to life. ■ With engineering. Our in-house team uses graphics software that we designed ourselves to ensure the structural integrity of connection designs for shop drawings. ■ With quality. Our facilities are state-of-the-art. Our Quality Assurance Department reports directly to our president. So you're guaranteed of consistent, high stand-

ards as evidenced by our Level III AISC certification. ■ With performance. We've placed a priority on planning. So you get the results you ordered: On time, no excuses. You'll also appreciate the availability of innovations like Space Frames and the Cirkel Line Entrance - products that help you stay on the leading edge of design. ■ Put our proven formula to work on your next project. Contact Haven-Busch Company, 3443 Chicago Drive, S.W., Grandville, Michigan 49418 / 616-532-3641 / Telex 292-879 / Telecopy 532-7585.

**HAVEN
BUSCH
COMPANY**

ESTABLISHED 1888

50th-year Tribute

SAN FRANCISCO-OAKLAND BAY BRIDGE

A Tribute to Steel's Excellence

On its 50th anniversary, the San Francisco-Oakland Bay Bridge stands as an enduring monument to engineering excellence in steel. The bridge is still the world's longest high-level span, and the only bridge to incorporate four major types of bridge construction. Third in volume of traffic carried, the bridge serves 250,000 vehicles per day. Only the Triborough and George Washington bridges in the New York City area carry more traffic.

The cantilever section of the bridge spans from East Bay to Yerba Buena Island and a suspension span connects the island to San Francisco. Five lanes of westbound traffic flow on the upper deck, while five lanes of eastbound traffic travel on the lower deck. Three freeway arteries, I80, I880 and I580, feed into the eastern end of the bridge.

Construction started on the bridge in July 1933 and the structure was completed in 40 months, six months early. Built at a cost of \$77 million and financed by the Reconstruction Finance Corporation, the project employed thousands of workers in the heart of the Depression.

Bridge-building Firsts

Building the Bay Bridge included many engineering advancements. The vehicular tunnel at Yerba Buena Island, measuring 76 ft wide and 58 ft high, became the world's largest bore tunnel. Originally built for trains, its ridership declined in the late 1950s. Now, the tunnel carries eastbound traffic in a toll-free direction. The upper deck, for westbound traffic, is subject to a toll.

The towers forming the San Francisco-Yerba Buena Island section of the span are

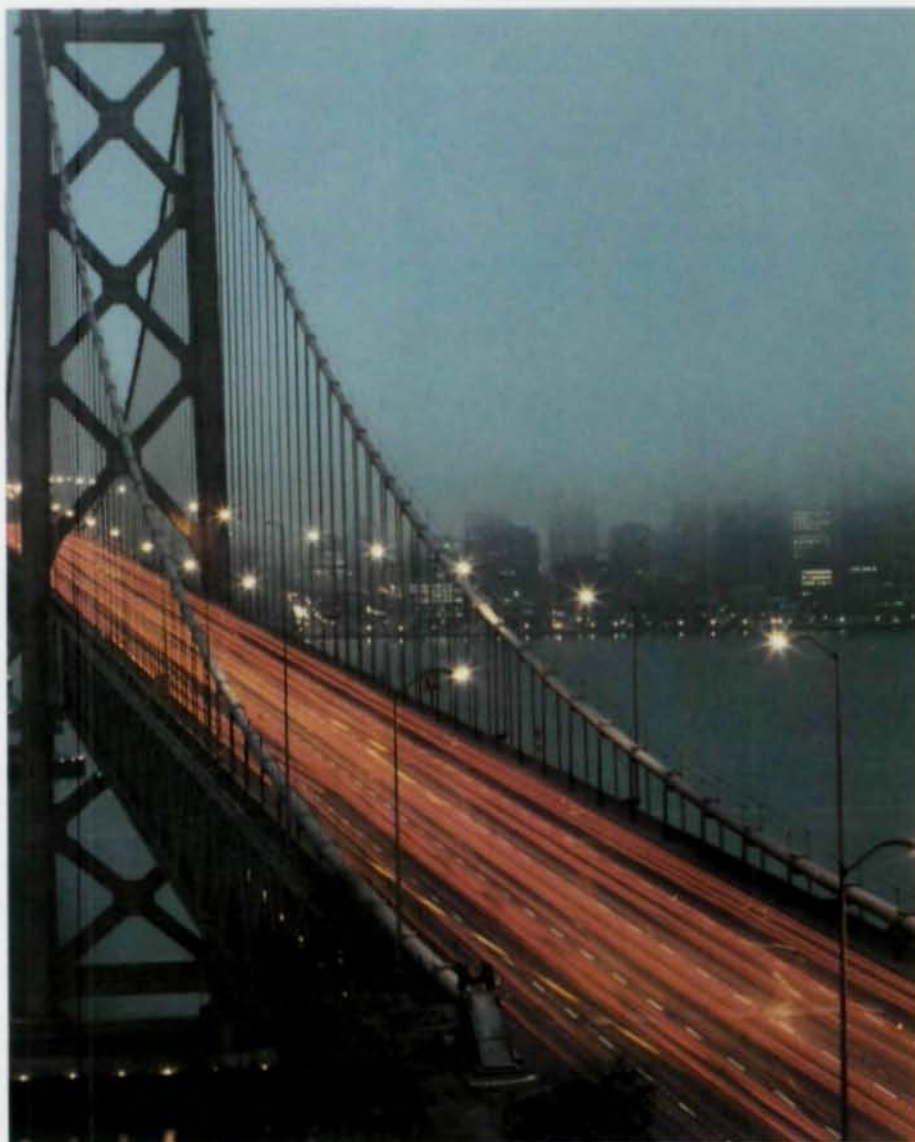

Jewel of California transportation system, Bay Bridge is still going strong, and is structurally sound, after 50 years of assault by sun, salt and zillions of vehicles.

the first "batter leg" towers ever used in a major suspension bridge. Each tower leg inclines forward toward the other and tapers toward the top, allowing each tower to compensate for stress, high winds and earthquakes.

Before the bridge was built, concrete had been poured only to a depth of about 185 ft under the water. Concrete pouring for the Bay Bridge piers reached a depth of 218 ft.

Overcoming Construction Hardships

Art Elliott was a junior engineer in 1934 when he joined the California Department of Transportation and began working on the bridge. Now retired, Elliott still remembers the difficulties of building the bridge. Because the bridge piers were the deepest ever poured to date, the inspection dives were record breaking for a diver in a hard hat and a canvas suit. "At that depth, it was pitch black. The diver did not have any light. It would have been useless in the muddy water, so he had to feel his way along and report what he found," recalls Elliott.

The Bay Area's famous fog also played havoc with bridge workers. Cable spinning proceeded around the clock, and when it was extremely foggy, a cowbell was put on the spinning wheel so workers could hear it coming their way. Also, being in the depth of the Depression, many of the men owned only a suit coat or light sweater. "During spinning they were working out there in the middle of the night wrapped in bits of canvas or burlap they picked up and would be freezing to death," Elliott remarked.

The contractor chose to tighten the bolts with a huge ratchet wrench with an eight-foot extension on the handle. Three of the biggest workers jumped on the handle to tighten the bolts. Once tightened, Elliott and another engineer made a final check of the tension. He remembered, "We would walk along the top of the cable, which looks just as it does today, and then at each saddle we hung over the side and swung our micrometer under to check the tension in the bottom bolts."

Forging into the Future

The bridge was opened in November 1936 by President Franklin D. Roosevelt. Although 3,000 miles away, he pressed a button igniting a "go" signal for three columns of automobiles to begin the 5.6-mi. journey across the Bay to San Francisco. For the last 50 years, the bridge has continued to serve travelers. But the question is how long can the bridge remain standing?



Looking for first signs of trouble that would compromise bridge integrity is Caltrans inspector Rich White. Making sure bridge bolts are tight is operator Richard Teraura.

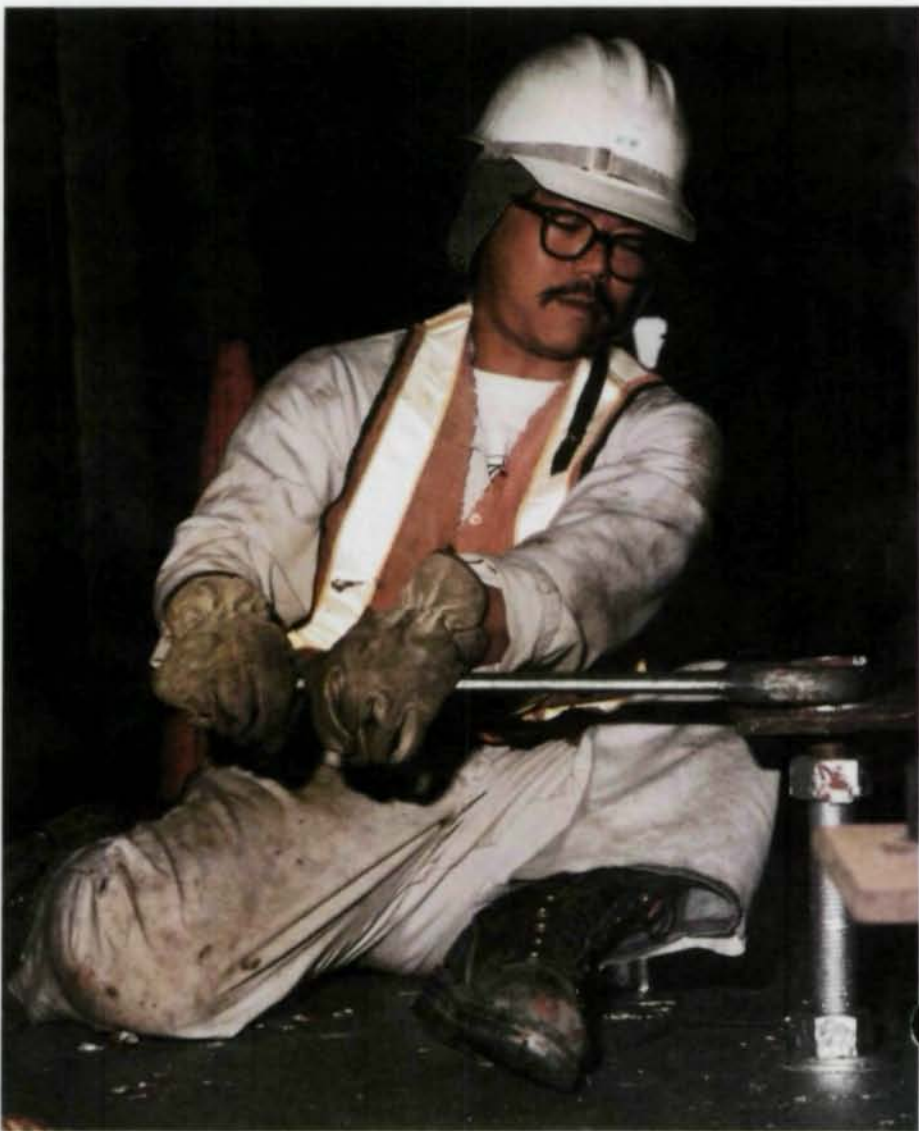

Despite 250,000 vehicles crossing the bridge daily, with that number expected to rise, the bridge has not been compromised. "Structurally, the bridge is in excellent shape . . . I'd say it would be a solid bet that the Bay Bridge will still be going strong in another 50 years and more, according to Mike Nagai, chief of the Office of Structures Maintenance and Investigations in Sacramento, who is responsible for inspections of all bridges on the state's highway system. He notes, "While the phenomenon of fatigue in structural steel members is a long-range concern, I don't expect to see any manifestations of it for many years to come."

A well-defined maintenance and inspection program is credited with keeping the bridge in top shape. A staff of seven engineers and technicians have the full-time responsibility to inspect all the state-owned toll bridges in the Bay Area. Maintenance workers are trained to look for any trouble signs too. Painters, for example, are out on the bridge constantly and will alert inspectors of any potential problems. Upkeep of the bridge is made difficult by its heavy use, currently running at capacity with 9,000 vehicles per hour. Inspections are coordinated along with other maintenance to make use of scaffolding in place



San Francisco-Oakland's famed Bay Bridge under construction, circa 1936.



FIRE-TROL PREFABRICATED, FIREPROOFED STEEL COLUMNS

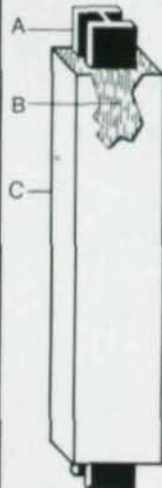

This is Fire-Trol:
 A prefabricated, fireproofed unit consisting of a load-bearing steel column (A), encased in a special proprietary insulating material (B), which is permanently protected by an outer nonload-bearing steel shell (C). Fire-Trol columns are rated and labeled by Underwriters' Laboratories, Inc., for fire retardant classifications of 2, 3, and 4 hours.

LT LALLY TUBULAR, INC.
 10700 W. 159th St.
 Orland Park, IL 60462
 Nationwide 800-323-5514
 In Illinois 312-349-2700

See Us In SWEETS 05100/LAL



or a lane closure; thus only inconveniencing motorists once to complete two necessary operations.

A traffic management system has been designed to try and maximize the capacity of existing facilities and reduce accidents and delays for motorists. Key elements of the plan include using a computer system to alert bridge employees more quickly to accidents and stalled vehicles so tow trucks can be dispatched. A message system would inform motorists of any problems on the bridge.

Wil Behrens, chief of the Maintenance Operations Branch in District 4, sums it up best. "The Bay Bridge is one of the greatest bridges in the world. Many of us may not be here in 50 years, but the Bay Bridge will still be doing its job of transporting people to and from San Francisco." □

GRATE-FAST

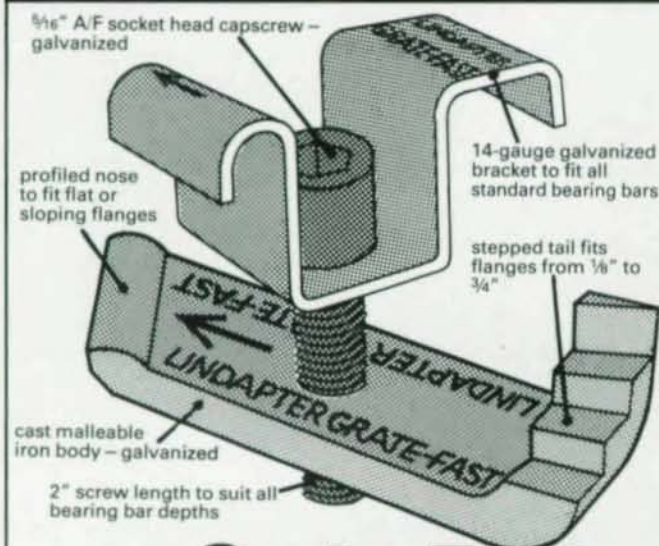

At last—a heavy-duty grating clip that's easy to install (without drilling or welding) secure, adjustable and relocatable — to fit all standard bar grating.



THREE SIMPLE STEPS TO FOLLOW . . .

- 1 Position pre-assembled Grate-Fast between grating bars
- 2 Slide Grate-Fast towards steelwork until nose fits under flange
- 3 Tighten capscrew with Allen wrench

ONE MAN, WITH ONE WRENCH,
FROM ABOVE

Grate-Fast new from

Struct-Fast

Struct-Fast Inc 20 Walnut Street Suite 101 Wellesley Hills MA 02181 Tel: (617) 235-6734

Education

A STEEL SCULPTURE THAT TEACHES

by Duane S. Ellifritt

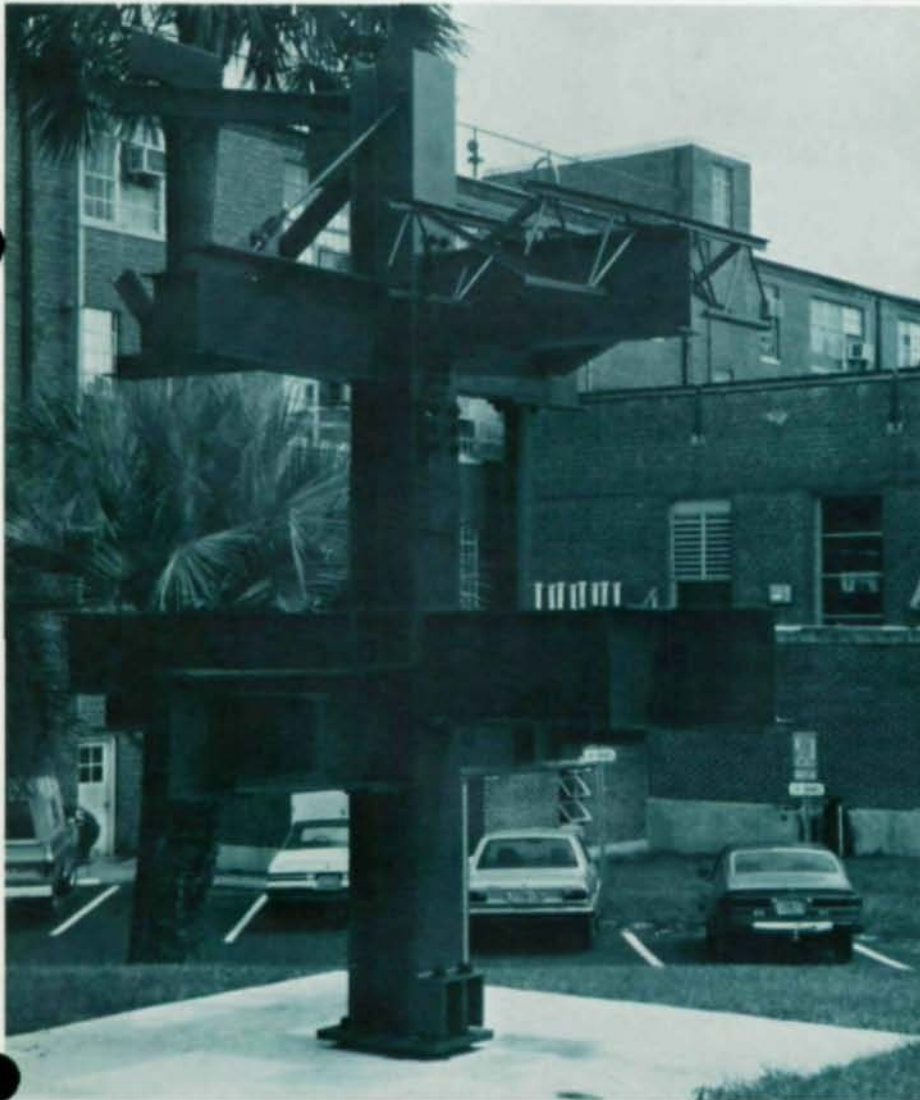

"Teaching" sculpture at University of Florida-Gainesville. Three-dimensional details help students visualize real connections. Sculpture is bright orange, and bolts painted black to emphasize connection details.

Number1/1987

Several semesters of teaching the beginning Steel Design course was followed by equal periods of frustration because students could not visualize a simple web-angle shear connection. I decided they needed to see real connections—in three dimensions. It would be helpful to take them on a field trip to a job site to see steel erected and get some flavor for the scale and details of steel construction. But this is getting more and more difficult to do. Contractors do not want students on the job site any more because of liability for injuries. In addition, a college in a small town does not have that many choices of jobs to visit. Another disadvantage of the field-site visit is that a student does not always see a wide variety of members, connections and framing schemes, but many repetitions of the same type.

If students cannot be taken to the job, then the next best thing is to take samples of construction details to the students. I toyed with the idea of fabricating short sections of two members, one connected to the other, with each assembly illustrating a different kind of connection. These would be carried to the classroom. This idea failed on two counts: the material is too heavy to be easily transported and there would have to be some place to store them when not in use.

A better solution to this problem was suggested by the various steel sculptures erected in front of municipal buildings in several cities—Chagall's baseball bat and Picasso's statue in Chicago; the weathering steel clothes pin in Philadelphia; Nôguchi's pipe in Cleveland, to name a few. Fi-

nally, the perfect solution—create a "sculpture" that enhances its surroundings, serves as a symbol for the Civil Engineering Department and also serves as an instructional aid.

I made some sketches and showed them to my department chairman and dean, who liked the idea. I then sent the drawings to the AISC regional office who distributed them to some Florida fabricators. The response was overwhelmingly positive. One firm, Steel Fabricators, Inc. of Ft. Lauderdale, even offered to fabricate and erect it for free.

The next step was to get the university to agree and to decide where to locate it. Appearing before the University Facilities and



Prof. Ellifritt points out connection details on "yet-to-be-nicknamed" sculpture.

Planning Committee, I made a pitch for the sculpture as a work of art. The committee was rather cool, but finally agreed to locate it behind an electrical substation where it is hidden from view to all except those who toil in the Engineering Building. Their reasoning was that it presented a potential liability problem. There were, after all, sheared edges of steel at hip and head level that could do some damage. The same is true, of course, of every chain link fence, bicycle rack, bench or palm tree on campus, but I accepted the plot behind the substation.

The next big hurdle was to prepare shop drawings. It was a detailer's nightmare, since no two pieces were alike and there were no two identical connections. At a meeting of the Civil Engineering Department's Board of Visitors, Kun-Young Chiu saw my rendering of the proposed project and volunteered his Valdosta, Ga. consulting firm to prepare shop drawings. These were completed in June 1986. After checking, they were sent to Ft. Lauderdale for fabrication.

The fabricator assembled 90% of the sculpture in his shop, delivered it to the job site on Oct. 8 and erected it. A few miscellaneous parts had to be attached after the assembly was mounted on its foundation.

Ground was broken for the foundation in January 1986. The ASCE Student Chapter provided the manpower to excavate and tie rebar. The foundation was made 10½-ft square, the extremities of the steel, so someone mowing the lawn would not get close enough to get clipped by a W18. The base was poured on Feb. 28, 1986—six or seven yards of concrete. That was a little overkill, but student labor is cheap, there was a lot of rebar left over from research projects and concrete is not terribly expensive.

The sculpture (yet to be named) is painted with a prime coat and a finish coat of acrylic orange—one of the University colors. The bolts are left black so the connections stand out. It has attracted much comment from passersby and draws attention to the Dept. of Civil Engineering and their activities. In addition, it has real purpose—to impress on the minds of future designers some of the advantages of steel-framed construction. □

TWO-MILLION USERS AND GROWING . . .

. . . That's how many professionals worldwide have chosen **LOTUS 1-2-3** as their premier spread sheet program. Put this industry standard to work on all your **structural design** tasks using **ENERCALC** software.



- A complete library of **40 programs** in steel, concrete, timber, masonry and retaining wall design & analysis.
- Dramatic ability to automate virtually all your everyday calculations using this "intelligent calcpad."
- Software including graphics, source code, free '800' support line and no copy protection.
- 60 day money back guarantee.
- Call today: 1-800-424-2252 or 1-714-720-1865.

ENERCALC

160 Newport Center Drive, Suite 125 • Newport Beach, CA 92660 • (714) 720-1865

Lotus 1-2-3 is a trademark of Lotus Development Corp.

D.S. Ellifritt is professor of the College of Engineering, University of Florida, Gainesville.

Technical

THE TREND TO STAGGERED-STEEL TRUSS FRAMING

FOR HIGH-RISE APARTMENTS AND HOTELS

For the first time in New York City, a staggered-steel truss framing system is under construction for apartments. At one corner of famed Central Park, the Towers on the Park complex of two 20-story and three 9-story buildings encompasses over 580,000 sq ft. Included are 600 condominium apartments and commercial space.

Also, the newest of the erected staggered-truss structures, and the world's tallest, is the 43-story, 1,200-room Resorts International Hotel on the Atlantic City oceanfront, a \$22-million project.

And, to cite a few other buildings using this framing system, there are the Nashville Convention Center Hotel; a 16-story addition to the Greensboro, N.C. Holiday Inn; the same company's unit in Bloomington, Minn.; Westwood House apartments, Westwood, N.J.; Hyatt Regency Hotel, Lexington, Ky.; Showboat Hotel/Casino, Las Vegas; and Elm Park Towers apartments in Worcester, Mass. These examples reflect a strong trend toward the staggered-truss system.

Considered best suited for hotels and apartments, a traditional concrete market, the system is especially appropriate for tall, narrow structures, filling today's need for high-rise buildings in space-scarce urban areas. Appropriately, these areas are also well-served by an abundance of ironworkers to erect the framing and steel fabricators who can produce it to close tolerances.

The two primary reasons for its growing use are the cost savings realized and its

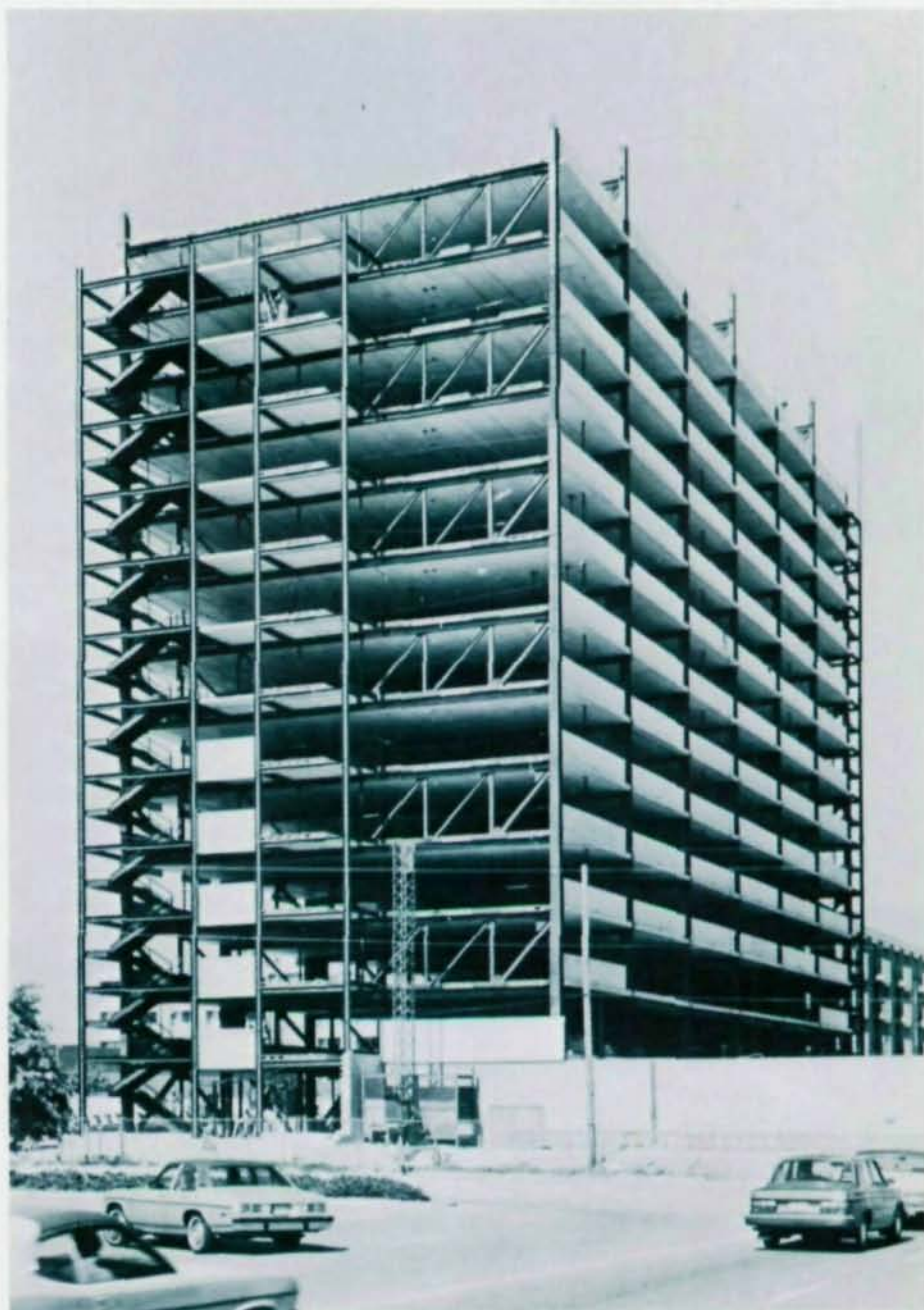

Tower addition to Greensboro, N.C. Holiday Inn. Note staggered trusses at alternate floors which permitted earlier occupancy with resultant direct savings in construction interest costs.

layout flexibility, since staggered-truss buildings completely eliminate all interior columns.

Essentially, the staggered-steel truss framing system employs story-high trusses to span the full building width on alternate floors at each line of columns. The trusses are supported only at their ends by perimeter columns, leaving the interior space clear. Trusses are staggered alternately from floor to floor so that, generally, all odd floors are identical, as are all even floors.

The full-floor-height trusses resist both gravity and transverse lateral loading. Diagonal members can be eliminated in selected panels of the trusses to permit openings for corridors and for doorways to adjoining spaces. The top and bottom chords of each truss are usually ASTM A36 steel in wide-flange shapes; web members (diagonals and verticals) are smaller wide-flange sections or angles. Floor systems, supported on top and bottom chords of the trusses, can be compos-



Close-ups of staggered-truss framing show diagonal and vertical members. Cost-saving, story-high trusses replace conventional beam-and-column framing and eliminate interior columns.

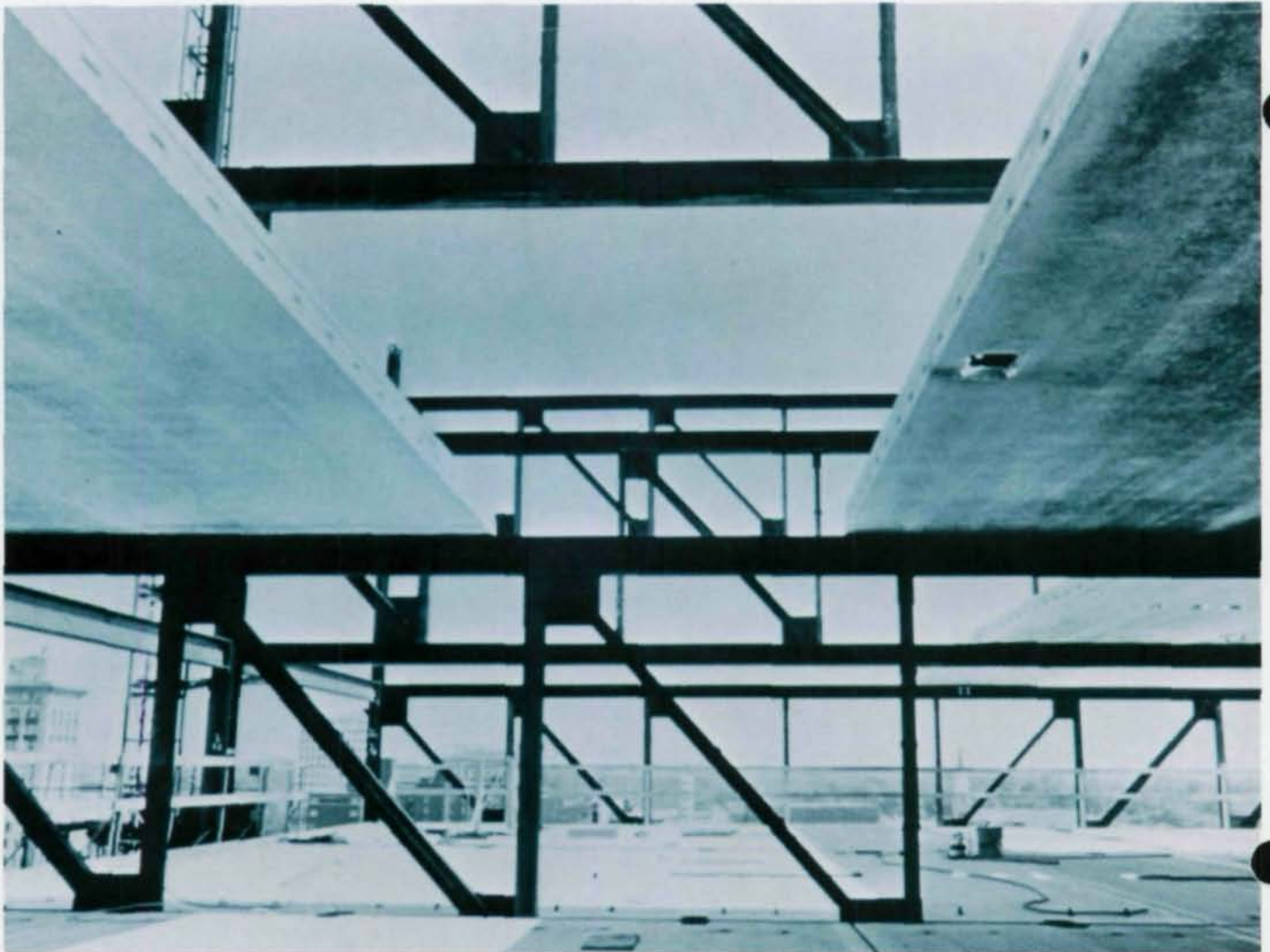

te steel deck with concrete fill, precast concrete plank or filigree slabs.

A key factor in the selection of staggered trusses is their cost savings. For example, the Glick Organization, developer of New York's Towers on the Park, projected a considerable savings when compared to poured-in-place or precast concrete systems. Part of the savings comes because lighter-weight staggered-truss framework was ideal for the site's abnormal subsoil. However, there should be savings on a similar project on a normal site with regular subsoil conditions.

The major savings come from the fact the staggered-truss system uses less steel (20% to 40% less) than conventional beam-and-column framing. Also, since staggered-truss framing is lighter than reinforced concrete or wall-bearing construction, foundation costs are lower on most sites.

Other significant money-savings comes when framing erection is performed entirely by dry-trade workers. One trade—ironworkers—can put up both frame and flooring if precast plank is employed. More savings accrue in labor costs because the building goes up faster, which also cuts construction loan interest and starts sales or rental income much earlier.

The staggered-truss system originated in the 1960s, the result of a study by a research team from the Departments of Architecture and Civil Engineering at the Massachusetts Institute of Technology. Its first applications were in Minnesota—the 22-story Radisson Hotel South in Minneapolis and a 17-story apartment building for the elderly in St. Paul. Since then, the concept won converts slowly, until the past few years when interest in the system has accelerated.

10 Tips on Staggered-Truss Framing

1. At New York's Towers on the Park, the staggered trusses use a Vierendeel open center panel to accommodate the corridor down the center of each building. To ease future layout redesign in the 1-, 2- and 3-bedroom apartments—combining apartments or changing configurations—almost half the trusses will have two additional panel openings, one on each side of the centerline.
2. To assume the staggered-truss system is applicable only to a rectangular configuration is a wrong assumption. It has

also been used in curvilinear and circular buildings and in combinations of offset rectangles. Besides placing trusses at alternate columns and floors in a checkerboard pattern, it is also feasible to use different layouts on alternate levels. This accommodates several uses within a single structure: apartments could be stacked above schools, commercial spaces, health clubs, etc.

3. A three-panel truss will overcome wind vibrations at the 34-story, 600,000-sq ft Nashville Convention Center Hotel,

now being built. The solution to the lateral loads of turbulent winds, this modified truss (most trusses have more panels) behaves as both a rigid and braced frame. To make it work, the top and bottom truss chords as well as the vertical members were increased in size and strength.

4. Logical use of the system suggests that truss spacing provide for placement of complete apartment units between trusses. However, the unit sizes on each floor can be varied by adjusting the space between trusses or by

NEW LRFD/ASD

Computer Data Base



FOR STRUCTURAL SHAPES

In a continuing effort to provide steel design aids to structural engineers, the American Institute of Steel Construction has improved and expanded its Computer Data Base for properties and dimensions of structural steel shapes, corresponding to data published in Part 1 of the 1st Edition, AISC LRFD Manual of Steel Construction, as well as properties needed for Allowable Stress Design according to the 8th Edition, AISC Manual of Steel Construction.

PROGRAM PACKAGE

1. Computer Data Base in binary format for the properties and dimensions of the following structural shapes:
 - a. W Shapes (many new sections)
 - b. S Shapes
 - c. M Shapes
 - d. HP Shapes
 - e. American Standard Channels (C)
 - f. Miscellaneous Channels (MC)
 - g. Structural Tees cut from W, M and S shapes (WT, MT, ST)
 - h. Single & Double Angles
 - i. Structural Tubing
2. Explanation of the variables specified in each of the data fields.
3. Listing of a BASIC read/write program and sample search routine.
4. Utility program to convert data file to ASCII format for FORTRAN applications.

ORDER FORM

I enclose payment of \$_____ for qty. of _____
NEW LRFD/ASD COMPUTER DATA BASE-DIMENSIONS AND
PROPERTIES OF STRUCTURAL SHAPES AT \$60 each.
(Member price: \$45. Members & non-members with trade-in: \$35.)

PERSONAL COMPUTER DISKETTE FOR:

- IBM-PC (& Compatibles) Tandy/Radio Shack
 HP-150 Wang PC
 DEC Rainbow PC

*For discounted "trade-in" price, the original copy of the previous AISC shape data base must be returned with your remittance.

Charge to Card No. _____

Expiration Date _____

MAIL TO: NEW LRFD/ASD COMPUTER DATA BASE
AMERICAN INSTITUTE OF STEEL CONSTRUCTION, INC.
P.O. Box 4588, Chicago, IL 60680-4588

Name _____ Title _____

Company _____

Address _____

City _____

State _____ Zip _____

Please enclose remittance. No C.O.D. orders. In New York, California and Illinois, add sales tax. Shipping charges prepaid in the U.S. On shipments outside the U.S., add 10% of total purchase for postage and handling. Visa and MasterCard accepted.

Signature _____

PRELIMINARY PROGRAM OF EVENTS

WEDNESDAY, APRIL 29

- 12:00 Noon AISC REGISTRATION DESK AND EXHIBITS OPEN—Rivergate Convention Center
STEEL EDUCATOR PROGRAM (Sheraton Hotel)
- 11:00 AM Partner in Education Advisors Meeting—PIE Advisors
- 12:30 PM Educator Luncheon—All Educators, guests and staff
- 1:30 PM Educator Session, "Current Challenges in Steel Education"
Welcome: R. P. Stupp, Chairman, AISC Education Foundation
Moderator: Lynn Beedle, Lehigh University
- 1:45 PM Session #1—"LRFD Undergraduate Education" (Panel-led discussion)
Chairman: Donald R. Sherman, University of Wisconsin/Milwaukee
- 2:45 PM Session #2—"Teaching Aids"
Chairman: J. Moore, Virginia Polytechnic Institute (with break-out sessions):
A. Fabrication Slide Program
B. Connection Slide Program
C. Monsanto Model
- 3:45 PM Break
- 4:00 PM Session #3—"Steel Design Education Software"
Chairman: Harry R. Lundgren, Arizona State University (Short presentations followed by discussion.)
- 4:45 PM Wrap-Up
- 5:00 PM Adjourn

SPECIAL EDUCATOR FEE \$150.00

(Educators employed full-time at an accredited architectural or engineering college or university may be eligible for sponsorship by the AISC Education Foundation. The Foundation will pay registration fees for the first 100 educators registering for the Conference. Simply return your registration form along with a letter on your college or university letterhead. Those registering after Foundation sponsorship is filled will be notified and, if they wish to attend at their own expense, will be billed for the \$150 Registration Fee.)

NOTE: Registration Fee includes all NEC/COP General Sessions, workshop sessions and coffee breaks, Continental breakfast Thursday, Friday and Saturday, Luncheons Thursday and Friday, the NEC/COP Cocktail Reception Wednesday evening, and a printed and bound copy of the Proceedings.

OPTIONAL EVENTS

- 2-5:00 PM See New Orleans (Event #1, advance tickets required, see registration form.)
- 6-7:30 PM AISC Cocktail Party—Rivergate Convention Center (No charge for Educators, Exhibitors and NEC/COP attendees registered for the Conference. Spouses' Program Fee includes Cocktail Party.)
- 8-12:00 PM Visit Bourbon Street (See Event #2)

THURSDAY, APRIL 30

- 6:30 AM Registration Desk Open—Rivergate Convention Center
- 7:00 AM Continental Breakfast in Rivergate Convention Center Exhibit Hall (Exhibits open 7:00 AM)
- 8:00 AM GENERAL SESSION—Rivergate Convention Center
KEYNOTE SPEAKERS:
"Material Considerations in Structural Steel Design"—John M. Barsom, Metallurgical Services, USX Corporation
"Trends of Steel in Construction"—Charles M. Thornton, Lev Zetlin Associates, Inc.
- 10:45 AM "The 1987 T. R. Higgins Lecture"—TO BE ANNOUNCED (Judging for the T. R. Higgins Lectureship is now in process. The winner, and title of the 1987 T. R. Higgins Lecture, will be announced prior to the Opening Session of the 1987 NEC/COP.)
- 11:45 AM LUNCH—Rivergate Convention Center Exhibit Hall (Exhibits Open)
- 1:30 PM WORKSHOP SESSIONS—Classrooms on Levels 1 & 2, Rivergate Convention Center (See Technical Program)
- 3:00 PM Coffee Break—Rivergate Convention Center Exhibit Hall (Exhibits Open)
- 3:30 PM WORKSHOP SESSIONS
- 5:00 PM Thursday Sessions Adjourn

OPTIONAL EVENT

- 6:30 PM Riverboat Dinner Cruise aboard the Natchez (See Event #3)



FRIDAY, MAY 1

- 6:30 AM Registration Desk Open—Rivergate Convention Center Exhibit Hall
- 7:00 AM Continental Breakfast in Rivergate Convention Center Exhibit Hall (Exhibits Open)
- 8:00 AM WORKSHOP SESSIONS
- 9:30 AM Coffee Break—Rivergate Convention Center Exhibit Hall (Exhibits Open)
- 10:00 AM WORKSHOP SESSIONS
- 11:30 AM LUNCH—Rivergate Convention Center Exhibit Hall (Exhibits Open)
- 1:15 PM WORKSHOP SESSIONS
- 2:45 PM Coffee Break—Exhibit Hall, Exhibits Open
- 3:30 PM WORKSHOP SESSIONS
- 5:00 PM Workshop Sessions Adjourn
- 6:00 PM Registration Desk Closes

(PLEASE NOTE: Exhibitors will be permitted to remove their displays after the conclusion of Friday afternoon's coffee break.)

OPTIONAL EVENTS

- 7-9:00 PM Annual Conference of Operating Personnel Dinner—Hilton Hotel, Napoleon Ballroom (See Event #5)
- 8-12:00 PM Bourbon Street Night (See Event #4)
- 9-10:30 PM Pete Fountain Show (See Event #6)

SATURDAY, MAY 2

- 6:30 AM Registration Desk Open
- 7:00 AM Continental Breakfast—Rivergate Convention Center, Level #1
- 8:00 AM Workshop Sessions (See Technical Program)
- 8:00 AM Conference of Operating Personnel Critique and Wrap-Up—Rivergate General Session Area, Level #1
- 9:30 AM Coffee Break—Level #1
- 10:00 AM CLOSING PLENARY SESSION OF THE 1987 NEC/COP "Engineer-Fabricator Cooperation"
Moderator: L. A. Kloiber, 1987 NEC Committee Chairman
Fabricator: To be Announced
Engineer: John L. Ruddy, Fletcher-Thompson, Inc.
Detailer: To be Announced
Erector: To be Announced
ASCE Responsibility Policy: Edward Becker, Lehigh Structural Steel Company
- 12:00 Noon DRAWING FOR DOOR PRIZES—Rivergate General Session Area, Level #1
- 12:15 PM The 1987 National Engineering Conference and Conference of Operating Personnel officially adjourns.

OPTIONAL EVENTS

- 2-5:00 PM Garden District Tour (See Event #7)
- 2-5:00 PM Danziger Bridge Tour (See Event #8)



WORKSHOP SESSIONS

Thursday, April 30—Saturday, May 2, 1987

1. STATE OF THE ART IN EARTHQUAKE DESIGN—PART 1

- "Overview of the 1988 Uniform Building Code Provisions"
Allan R. Porush—Dames & Moore
"Seismic Design of a Special Moment Resisting Space Frame under New Code Provisions"
Yogesh Meht—Chin & Hensolt Engineers, Inc.

2. STATE OF THE ART IN EARTHQUAKE DESIGN—PART 2

- "Seismic Design of an Ordinary Moment Frame and Concentrically Braced Frame Building Under the New Code Provisions"
Bradley A. Friederichs—Cole/Yee/Shubert
"Seismic Design of an Eccentrically Braced Frame"
C. Mark Saunders—Rutherford & Chekene

3. SURFACE PREPARATION AND COATING SYSTEMS

- Kenneth A. Trimmer—KTA-TATOR, Inc.

4. "OSHA RIGHT TO KNOW LAW IMPLEMENTATION PROCEDURES"

- Paul D. Arends—Cives Steel Company
Dean McDaniel—U.S. Dept of Labor

5. DESIGN OFFICE PROBLEMS—PART 1

- "The Effect of Connector Spacing on Double Angle Compressive Strength"
Cynthia J. Zahn *and* Geerhard Haaijer—AISC
"Answers to Most Frequently Asked Technical Questions"
Patrick M. Newman—AISC

6. DESIGN OFFICE PROBLEMS—PART 2

- "Stub-Girder Design"
Reidar Bjorhovde—University of Arizona
"Economics of Building Systems"
Horatio Allison—Allison, McCormac & Nickolaus

7. CERTIFICATION OF STRUCTURAL STEEL DETAILERS

- Charles Peshek—AISC
Joe A. Free, Jr.—J. A. Free, Jr. & Co., Inc.

8. "MANAGEMENT OF FAST TRACK CONTRACTS"

- Spencer L. Brown—Owen Steel Company *and*
Herbert R. Fletcher—Haven-Busch Company

9. LOAD AND RESISTANCE FACTOR DESIGN—PART 1 LRFD VS. ASD

- "Understanding Composite Beam Design Methods Using LRFD"
Robert F. Lorenz—AISC
"The Economics of LRFD in Composite Floor Beams"
Mark C. Zahn—Chris P. Stefanos Associates, Inc.

10. LOAD AND RESISTANCE FACTOR DESIGN—PART 2 PARTIALLY RESTRAINED CONSTRUCTION

- "Behavior of Semi-Rigid Composite Construction"
Roberto T. Leon—University of Minnesota
"Simplified Frame Design of Type PR Construction"
Michael H. Ackroyd—Techtrol Ltd.

11. "PROPER DOCUMENTATION OF CHANGE ORDERS"

- Robert B. Nelson—AFCO Steel *and*
S. W. Blaauw—Paxton & Vierling Steel Co.

12. "WHY A FABRICATOR SHOULD SEEK AISC QUALITY CERTIFICATION"

- Charles Peshek—AISC
Richard E. Blaisdell—Black & Veatch Engineers

13. "HOW THE COMPUTER IS USED BY THE CONSULTANT"

- William F. Baker, Jr.—Skidmore, Owings & Merrill *and*
James S. Notch—The Datum/Moore Partnership

14. "REINFORCING EXISTING STRUCTURES"

- David T. Ricker—The Berlin Steel Construction Company
John L. Ruddy—Fletcher-Thompson, Inc. *and*
Ray H. R. Tide—Wiss, Janney & Elstner

15. "VISUAL WELD ACCEPTANCE CRITERIA" *and* "PROPOSED NEW STANDARD WELDING PROCEDURES"

- Glenn W. Oyler—Welding Research Council
George D. Mandis—Haven-Busch Company

16. "PERFORMANCE OF ASTM A588 STEEL"

- R. Bruce Noel—New Jersey Turnpike Authority *and*
Seymour Coburn—Corrosion Consultants, Inc.

SPOUSES' PROGRAM

We've planned a Spouses' Program (and Optional Tours) that will give you a chance to see, hear and taste the very best of New Orleans. Our Spouses' Program begins

WEDNESDAY, APRIL 28

6:00-7:30 PM

Get *Acquainted Cocktail Party* in the Rivergate Convention Center Exhibit Hall. You'll have a chance to visit the 1987 NEC/COP Exhibits, greet old friends and meet new ones.

THURSDAY, APRIL 29

8:30 AM

Breakfast in the Hilton Hotel's Grand Ballroom. Buses depart at

9:30 AM

for *Plantation Homes of Louisiana*—a fascinating glimpse into the unique era of the antebellum South. You'll be escorted into the heart of the Mississippi River Plantation country, touring two homes and gardens restored to their original elegance. Reflecting the opulent days preceding the Civil War, this visit captures the romance that was once the Old South. A catered luncheon will be served at one of the homes.

FRIDAY, MAY 1

9:00 AM

The *New Orleans Museum of Art* houses one of the finest and most selective collections in the South—one of ten in the country presenting major international exhibitions. The magnificent jeweled eggs and flowers of Faberge are on permanent exhibit here. The tour will then proceed to St. Charles Avenue, the most prestigious residential street in the city, for a visit inside one of these magnificent private homes. We'll have you back to the hotel by

12:30 PM

So that you can enjoy browsing at your leisure through the many varied shops of The Riverwalk, entering from the Hilton Hotel's Lower Level onto the mile-long promenade of shops and restaurants on the site of the recent World's Fair.

SATURDAY, MAY 1

10:00 AM

Enjoy Saturday Brunch with one of the city's leading Creole chefs, who will introduce the philosophy, sometimes quirky habits, and social history of New Orleans' fine cuisine. Brunch will include some of the Hilton's best examples of the art.

REGISTRATION FEE: \$130.00

Then pick and choose among the Optional Events for on-your-own or with-companion excursions each evening, and Wednesday and Saturday afternoons.

FLY DELTA FOR SPECIAL DISCOUNTED RATES TO NEW ORLEANS

Delta Airlines, in cooperation with AISC, offers special rates for the 1987 NEC/COP which afford a 5% discount off **any** Delta published round trip fare* within the Continental U.S., including San Juan. This includes Super-saver and other promotional air fares. Discounts available only through Delta's toll-free number:

Call **1-800-241-6760** (8 AM-8 PM EST Daily)
Refer to Our File Number: PO442

or

Have your travel agent call for you.

*Applicable restrictions must be met.

THE NEW ORLEANS HILTON— Official Hotel for the 1987 NEC/COP

Just across the street from the Rivergate Convention Center (site of the 1987 NEC/COP Exhibits, all general and workshop sessions), the New Orleans Hilton overlooks the Mississippi River and has its own entrance to the newly opened Riverwalk—a mile-long promenade of shops and restaurants built on the site of the World's Fair. Indoor tennis courts, complete health club, two pools, docking facilities for Riverboat Cruises, plus four excellent restaurants. You're a short cab ride (or a pleasant 20-minute stroll) from the famous French Quarter. Accommodations are also available for 1987 NEC/COP attendees at New Orleans Sheraton, just a block from the Rivergate.

THE RIVERGATE CONVENTION CENTER Host to the 1987 NEC/COP

The Conference of Operating Personnel has been a traditional forum for many of the businesses who supply goods and services to the structural steel fabricating industry. With the expanded audience resulting from the combination of COP with AISC's National Engineering Conference, the "regulars" are coming back—and bringing many first-time exhibitors with them.

We've set aside nearly 150 exhibit spaces for exhibitors at the 1987 NEC/COP. If your company is interested in exhibiting this year, and you have not already been contacted by AISC, just call AISC's Public Affairs Department (312-670-5432) for details.

REGISTRATION AND ROOM RESERVATION FORM

National Engineering Conference & Conference of Operating Personnel
April 29-May 2, 1987

AISC MEMBER FEE: EARLY REGISTRATION (before March 15): \$250
LATE REGISTRATION (after March 15): \$300
(Includes AISC Active, Associate and Professional Members)

NON-MEMBER FEE: EARLY REGISTRATION (before March 15): \$300
LATE REGISTRATION (after March 15): \$350

SPECIAL EDUCATOR FEE: \$150

NOTE: Registration Fee includes all NEC/COP General Sessions, workshops, coffee breaks, Continental breakfast Thursday, Friday and Saturday, luncheons Thursday and Friday, the NEC/COP Cocktail Reception Wednesday evening, and a printed and bound copy of the Proceedings.

PLEASE REGISTER: (Type or Print)

Name	Nickname (for badge)	
Company	Title	
Mailing Address		
City and State/Zip	() - Bus. Telephone	() - Home Telephone

If Spouse or other guest wishes to register for Spouse's Program (Fee: \$130), complete next line.

Name of Individual Registering for Spouse's Program	Nickname (for badge)
---	----------------------

REGISTRATION FEES ENCLOSED:

AISC Member Fee \$ _____
Non-Member Fee \$ _____

Exhibitor, as indicated below:
Fee Paid with Exhibit Registration, No Balance Due
Additional Person, Added Now \$ _____

Educator, as indicated below:
Foundation Sponsorship Requested, Letter attached
If First 100 Educators already registered, bill me \$150 \$ _____

Spouse's Fee \$ _____

TOTAL REGISTRATION FEES \$ _____

ADD TOTAL TOUR FEES FROM COL. 2: \$ _____

TOTAL FEES ENCLOSED \$ _____

EXHIBITOR FEE (for additional Exhibit Personnel)
Member or Non-Member, EARLY REGISTRATION: \$250
LATE REGISTRATION: \$300

(Exhibitors are entitled to one registration for each booth reserved. Above fee is payable ONLY if in excess of one person per booth.)

REGISTRATION CANCELLATION POLICY: Cancellations received **before** April 15, 100% will be refunded; **after** April 15, 50% will be refunded. (See Exhibit Registration Form for Exhibitor cancellation policies.)

REGISTRATION FOR SPECIAL PROGRAMS

- PIE Advisors Meeting (11 AM Wednesday, PIE Advisors Only)
- Educators' Luncheon (12:30 PM Wednesday—No Fee)
- Educator Session (1:30 PM Wednesday—No Fee)

REGISTRATION FOR OPTIONAL TOURS, EVENTS

Event	No. Tickets	Total Price
#1—See New Orleans (Wed., 2 PM)	@ \$16.00	\$ _____
#2—Visit Bourbon Street (Wed., 8 PM)	@ \$32.50	\$ _____
#3—Riverboat Dinner Cruise (Thurs.)	@ \$48.00	\$ _____
#4—Visit Bourbon Street (again) (Fri.)	@ \$32.50	\$ _____
#5—COP Annual Dinner (Fri., 7 PM)	@ \$40.00	\$ _____
#6—Pete Fountain (Fri., 9 PM)	@ \$16.50	\$ _____
#7—Garden District Tour (Sat., 2 PM)	@ \$14.50	\$ _____
#8—Danziger Bridge Tour (Sat., 2 PM)	@ \$ 8.00	\$ _____
TOTAL TOUR FEES		\$ _____

(Make your check payable to AISC. If you wish to pay for the Optional Events selected with a separate check, you may do so. Tickets for Tours are reserved on a first-come, first-served basis. AISC reserves the right to limit number reserved by any individual.)

HOTEL REGISTRATION FORM

HILTON HOTEL: Special Rate Single—\$94 _____ Double—\$115 _____
Riverside Single—\$101 _____ Riverside Double—\$122 _____
Towers Single—\$115 _____ Double—\$136 _____
(If Double, Check One: Two Double Beds _____ King-Size Bed _____)

Arrival Date _____ Time _____
Departure Date _____

MAIL COMPLETED FORMS AND REGISTRATION FEE(S) TO:
American Institute of Steel Construction, Inc.

1987 NEC/COP
P.O. Box 804556
Chicago, Illinois 60680-4107
(Phone: 312-670-5432)

NOTE: Rates are subject to 11% local & state tax; children any age free in parents' room. Check-in time is 3:00 PM; check-out, 12 Noon. Rooms may be guaranteed to late arrival (after 6 PM) by a separate check, payable to the Hilton, in the amount of one night's stay, or by credit card (see space below). The Hilton will honor and guarantee reservations received by March 30, 1987, so return this form promptly.

_____ Yes, I wish to guarantee my room. I enclose check for \$ _____ payable to the New Orleans Hilton.

_____ Please charge my Credit Card # _____
Expiration Date _____

Circle One: American Express, VISA, MasterCard,
Diners, Carte Blanche

OPTIONAL TOURS AND EVENTS

EVENT #1 (WEDNESDAY, APRIL 29, 2-5 PM)

SEE NEW ORLEANS

Your tour traces the city from its rich past to its vibrant present. See Jackson Square, unique cemeteries and ride along the banks of Bayou St. John, the initial settlement of New Orleans. Following the crescent of the Mississippi, you pass the stately residences and universities lining fashionable St. Charles Avenue, paralleling the streetcar route to the Central Business District, passing the Louisiana Superdome and, of course, Canal Street. To enrich this outing, a tour of magnificent Longue Vue Estate is included.

TOTAL PRICE: \$16.00

EVENT #2 (WEDNESDAY, APRIL 29, 8-12 MIDNIGHT)

VISIT BOURBON STREET

This evening tour captures the magic and excitement of New Orleans by night. Professional escorts accompany you for a show on Bourbon Street, some Street Jazz and Dixieland at the city's brightest night spots. End with the traditional New Orleans nightcap... coffee and beignets at Cafe du Monde.

TOTAL PRICE: \$32.50 (includes complimentary cocktails at each club)

EVENT #3 (THURSDAY, APRIL 30, 6:30-9:30 PM)

RIVERBOAT DINNER CRUISE

Aboard our privately chartered sternwheeler, the Natchez, departing the Hilton's International Dock for a leisurely cruise up the Mississippi, a sumptuous dinner with serenade accompaniment by one of New Orleans' finest jazz quartets. Music for listening and dancing, a riverview of the city by twilight and moonlight, after-dinner coffee on deck as we return to the city.

TOTAL PRICE: \$48.00



EVENT #4 (FRIDAY, MAY 1, 8-12 MIDNIGHT)

VISIT BOURBON STREET (Again)

For those who missed Wednesday evening's adventure, or had so much fun they'd like to do it again.

TOTAL PRICE: \$32.50 (including cocktails at each club)

EVENT #5 (FRIDAY, MAY 1, 7-9 PM)

THE CONFERENCE OF OPERATING PERSONNEL'S ANNUAL DINNER

Conducted this year as an optional event in the Hilton's Napoleon Ballroom, it's a tradition with COP attendees. Entertainment, as always.

TOTAL PRICE: \$40.00

EVENT #6 (FRIDAY, MAY 1, 9:00-10:30 PM)

PETE FOUNTAIN is the undisputed King of New Orleans. We've reserved a limited number of seats for his Friday evening performance. This non-stop hour of jazz styling featuring the King himself includes complimentary cocktails.

TOTAL PRICE: \$16.50

EVENT #7 (SATURDAY, MAY 2, 2-5 PM)

GARDEN DISTRICT TOUR

The Garden District with its stately mansions and beautiful gardens was originally considered the "American" part of the city. Greek revival architecture dominates these stately mansions, complemented by luxurious gardens, flowering trees and ancient oaks. Two private homes will be opened especially for you.

TOTAL PRICE: \$14.50

EVENT #8 (SATURDAY, MAY 2, 2-5 PM)

DANZIGER BRIDGE TOUR

We've planned this special NEC/COP side trip for those who prefer their sights a bit more modern, and their tour narrator a bit more technical. The Louisiana Department of Transportation will provide guides with suitable expertise for this visit to one of the largest vertical lift spans in the world, now under construction.

TOTAL PRICE: \$8.00

58610 01985

EPIC LONG-SPAN DECKS



E750—SPANS TO 32 FT.
E600—SPANS TO 26 FT.
E450—SPANS TO 23 FT.
E300—SPANS TO 15 FT.

AVAILABLE FOR DELIVERY—NOW

Galvanized G60-G90
Lengths to 50 ft.

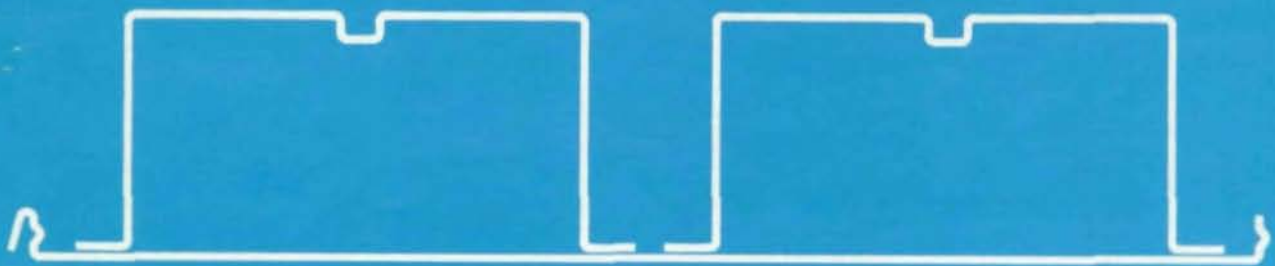

Plated Decks—Plain or perforated
Most complete line of deck products
in $\frac{5}{8}$ " to $7\frac{1}{2}$ " depths

OUR SERVICE WILL SAVE YOU TIME & MONEY

Epic has these profiles available for shipment on an A.S.A.P. Basis!

Your order will be processed in One Week in most cases. Ask about our A.S.A.P. Service.

Call (412) 351-3913 today for price and delivery information and for product advice on all types of Form Decks, Composite Decks, Long-Span and Roof Decks.

Manufacturing Plants:

- Pittsburgh, Pa.
- Chicago, Ill.
- Lakeland, Fla.

EPIC[®]
METALS CORPORATION

Eleven Talbot Avenue, Rankin, PA 15104
PHONE: 412/351-3913
TWX: 710-664-4424
EPICMETAL BRDK

CONTINUING A TRADITION OF RELIABILITY

...Launching A New Era
in Steel Design!

1ST
EDITION

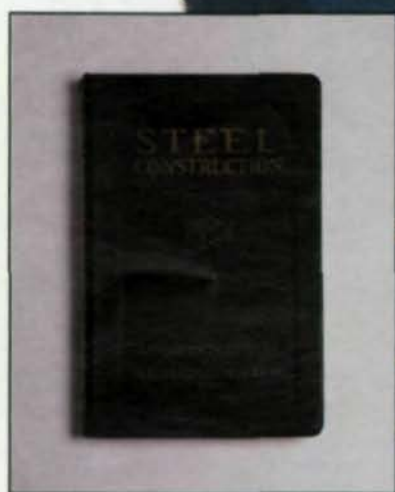

1927...

1986...

**It's Here! The Book We've
All Been Waiting For...**

- based on the 1986 AISC "LRFD" Specification for Structural Steel Buildings.
- grounded in the tradition of the AISC "bible" —the *Manual of Steel Construction*, introduced in 1927 and now in its 8th Edition.
- meshing the familiar and accepted basics with the very latest approaches to steel design, derived from current research and technological advances.
- helping you design more reliable, more economical steel-framed buildings.

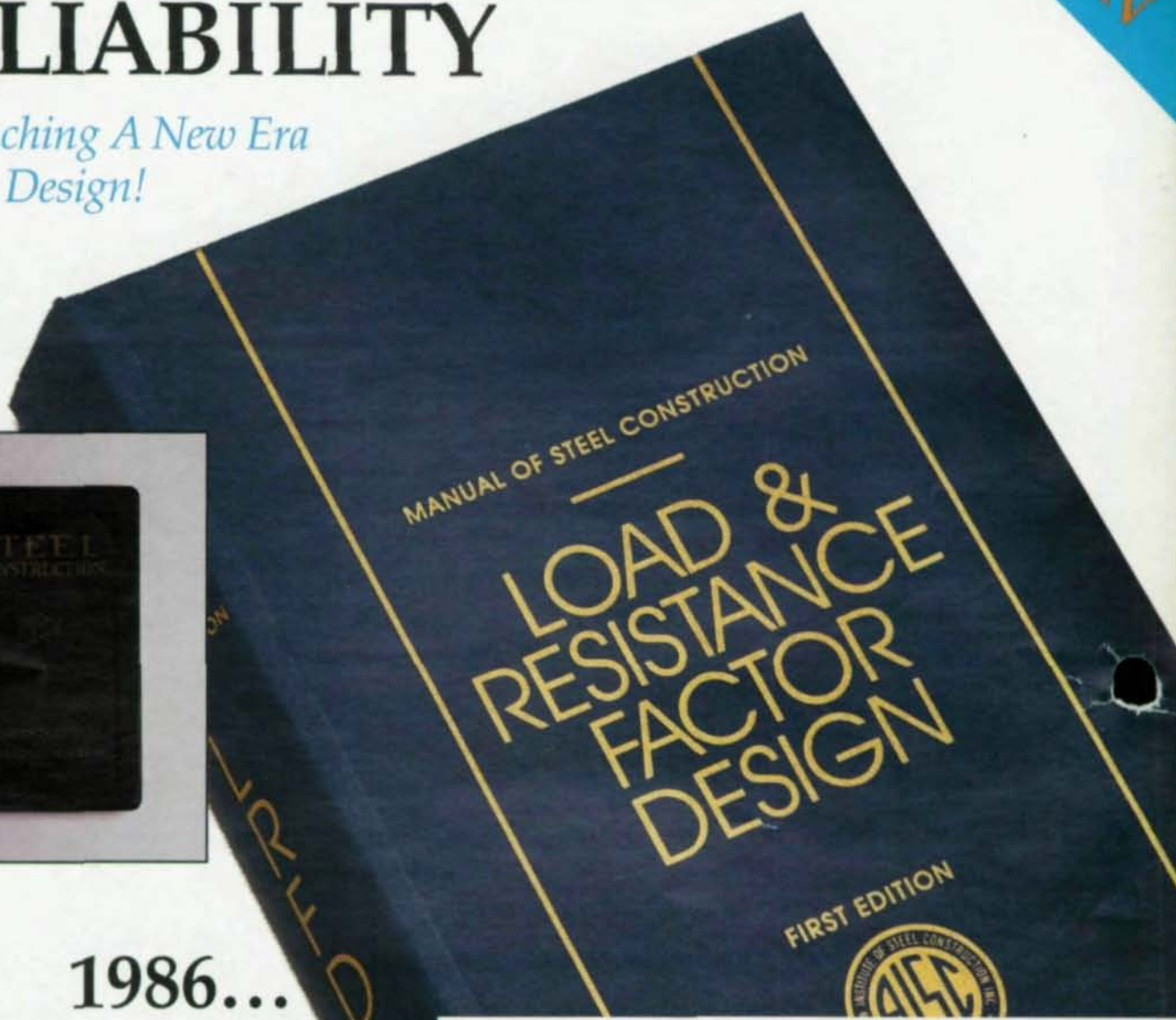

ORDER YOUR COPY NOW!

AMERICAN INSTITUTE OF STEEL CONSTRUCTION-DEPT B
P.O. BOX 4588, CHICAGO, IL 60680-4588

I enclose payment of \$ _____ for _____ copies of the First Edition Load and Resistance Factor Design Manual of Steel Construction at \$56.00 each.

Name & Title _____

Company _____

Address _____

City _____

State _____

Zip _____

Please enclose remittance. No C.O.D. orders. In New York, California and Illinois add sales tax. Shipping charges prepaid in the U.S. On shipments outside the U.S., add 10% of total purchase for postage and handling. **Visa and MasterCard accepted.**

Charge My Card No. _____