

A9.28-3

BULK RATE
U. S. POSTAGE
PAID
PERMIT NO. 15
KENT, OHIO

MODERN STEEL CONSTRUCTION

NUMBER 3 • 1988



THIS ISSUE

Using Steel Effectively
Miami Welcomes NEC-COP
NSCC Conference Highlights
A New "Station" in Life
New Impetus to Emerging City
School to Build a Better Life

ACTIV-WAY III

...because advancing communications, power and data technology necessitate a distribution system that keeps you current.

Why compromise with any other distribution floor system when ACTIV-WAY III is engineered to deliver the most complete, cost-effective cellular floor distribution system available anywhere.

ACTIV-WAY III is a quality, state-of-the-art distribution system designed to access the work station with the required networks from a single unit.

From diversity in design through labor and cost-saving voice, power and data presets and aftersets, each ACTIV-WAY III system gives you a value-added investment; a reduced capital investment; an unmatched, built-in flexibility that meets every projected need for each work station and floor area; and an advanced design that permits



easy abandonment and relocation of aftersets at minimal material and labor costs.

What's more, United Steel Deck, Inc. provides all of the U.L. listed components: exclusive 12" and 24" cellular decks,

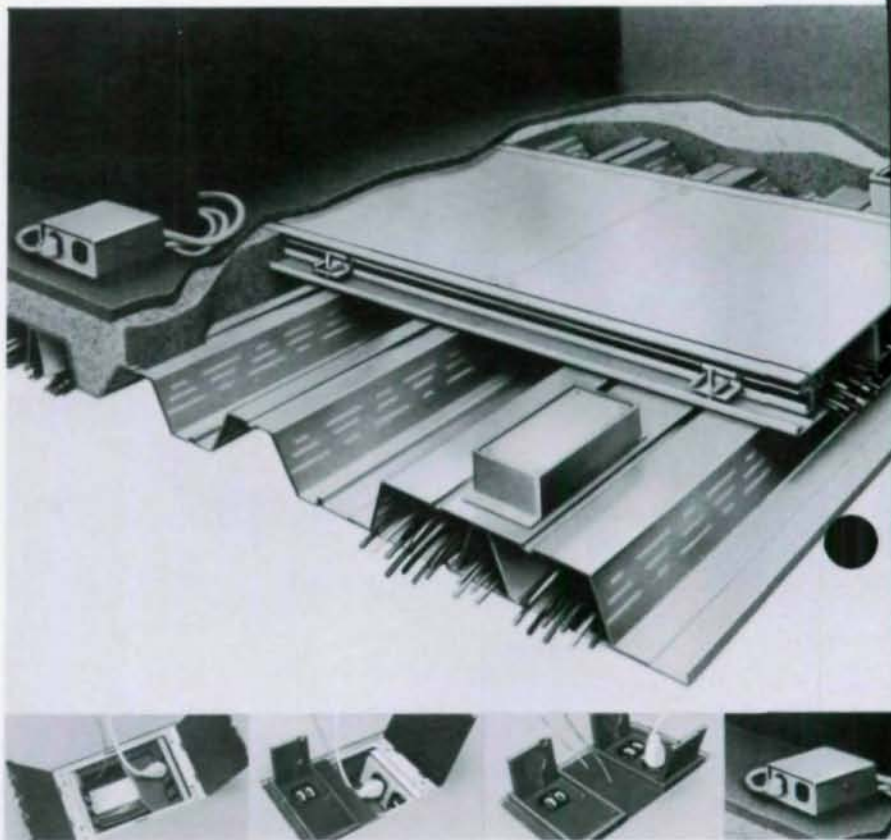

trench headers, preset and afterset inserts.

More than just another PLEC distribution system, these are versatile, total systems tailored to building owners' or developers' precise needs that enhance the total value of the "intelligent" building.

*Find out why **ACTIV-WAY III** is the key to your "intelligent" office building.*

Call us today at (201) 277-1617.

UNITED STEEL DECK, INC.



NICHOLAS J. BOURAS, INC.



Soda... designs your least-weight steel structure fast... and automatically

Finally, a practical structural engineering software package that not only analyses but automatically designs a least-weight (optimal) steel structure.

SODA represents the perfect blending of state of the art structural engineering and modern optimization research. SODA is a truly practical steel design optimization package that permits the designer to concentrate on engineering instead of routine calculations, thereby reducing design time and costs.

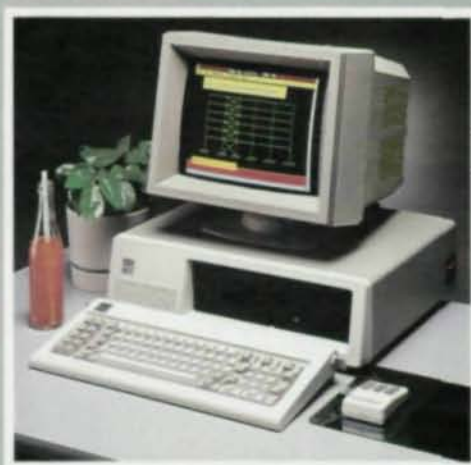

SODA automatically and completely designs a least-weight planar steel frame or truss from section databases in complete conformance with design code requirements. The design by SODA is complete, constructable and ready to implement. There is no need to re-analyse and re-size as is the case with other steel design programs. The software designs not only member by member, but by considering

the entire structure as a system. The design satisfies both strength and deflection requirements.

- Design codes supported:
 - AISC WSD 1978 Specification
 - AISC LRFD
 - Canadian CAN3 - S16.1 - M84 Limit States Design
- Microsoft® Windows environment
- Mouse or keyboard interaction
- Members selected from AISC or CISC database or from user's custom data base
- Comprehensive yet concise user's manual
- 30 day evaluation period, refund if not satisfied
- Runs on IBM PC XT/AT or compatible
- Minimum 512 KB and hard disk required

* - Microsoft is a registered trademark of Microsoft Corporation.

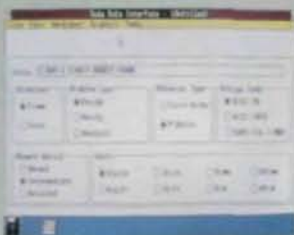

Input and editing is quick and easy.

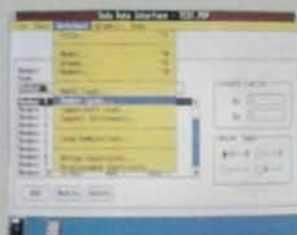

User interface is accomplished with mouse and drop down menus.



Graphics displays are accessible at any time.



The optimal design is presented in a logical and concise manner.

To get more information on SODA :

CALL TOLL FREE (in continental U.S.)
1-800-265-2766
or COLLECT (519) 885-2450

or WRITE
WATERLOO ENGINEERING SOFTWARE
A Member of the NEXA Group

Park Avenue Atrium
237 Park Ave., Suite 2143
New York, NY 10017

180 Columbia Street West
Waterloo, Ontario
Canada N2L 3L3

soda

STRUCTURAL
OPTIMIZATION
DESIGN AND ANALYSIS

MODERN STEEL CONSTRUCTION

VOLUME XXVIII • NUMBER 3
MAY-JUNE 1988

American Institute of Steel Construction, Inc.

The Wrigley Building
400 North Michigan Avenue
Chicago, Illinois 60611-4185
Phone: 312 / 670-2400

OFFICERS

Samuel Y. Golding
Chairman
Ralph H. Clarbour
First Vice Chairman
Stephen E. Egger
Second Vice Chairman
Oscar W. Stewart, Jr.
Treasurer
Neil W. Zundel
President
William W. Lanigan
Secretary & General Counsel
Lewis Brunner
Vice President, Membership Services
Geerhard Haaijer
Vice President, Technology & Research
Morris Caminer
Vice President, Finance/Administration
William Y. Epling
Vice President, Government Affairs

EDITORIAL STAFF

George E. Harper
Director of Publications
Brenda Follmer
Assistant Editor
Lona Babbington
Business

ADVERTISING REPRESENTATIVE

The PATTIS GROUP
Eric K. Nieman
4761 West Touhy Avenue
Lincolnwood, Ill.
312/679-1100

ON OUR COVER:

General Dynamics Complex
Sterling Heights, Michigan

-
- 9 General Dynamics
Using Steel Effectively



-
- 13 Miami Beach Welcomes
1988 National Steel Construction
Conference
Conference Highlights



-
- 14 Conference Program, Summary
and Key to Workshop Sessions

-
- 20 Exhibitors' Booth Guide

-
- 24 Norstar Bancorp
A New "Station" in Life



-
- 35 Cobo Exhibition Center
New Impetus to Emerging City



-
- 50 Mercer Jr./Sr. High
To Build a Better Life

-
- 53 Exhibitors' Ads



OOPs Dept.!

In Issue 2, the fabricator/erector was omitted on the World Financial Center project. Our apologies for this oversight to Canron Construction Corporation, Conklin, N.Y.



STRUCTURAL SOFTWARE'S COMPUTERIZED DETAILING SOFTWARE



UNDER \$30,000

Computerized Detailing is a relatively inexpensive structural steel detailing program designed to run on the IBM-AT compatible computer systems. The system not only completes details, but also designs connections according to the A.I.S.C. specifications.

Computerized Detailing allows a multiple member input of material using a grid plan thereby allowing the operator to easily make global assignments of connections. **Computerized Detailing** can then produce an erection plan as well as detail the project as a total integrated unit.

Computerized Detailing will handle wide flanges, channel, tube, pipe, angles, and plates. The design portion of the program investigates a wide variety of shop and/or field connections, that include combinations of bolted and/or welded, framed, cantilevers, knifed, end plate, stiffener and shear plates, moment connections, splice plates, tee connections, joist, joist girder, and one-sided connections. The design routines will also accommodate non-flush top beam framing, sloping beams, bracing, skewed beams, off column centerline framing (within limitations) and offset as well as opposite beam framing. An interface to Autocad graphics is available for additional special input.

A complete bill of material, shop and field bolt summaries and drawing index is supplied.

OVERALL VIEW UTILIZING DETAILING INTERFACES

By utilizing a standard IBM AT or 100% compatible one can draw the erection plan on the computer screen and automatically pass that information into the **Estimating** program, then by simply identifying the project a **Mill Order** can easily be developed based on preassigned values such as length desired, maximum weight, supplier, etc. The actual **Mill Order** can then be interfaced to the **Purchase Order/Inventory** system as being on order. Once the field and file use drawings are completed, by the Computerized Detailing Program, the **Detailing Interface to Production Control** allows the bill of material to be sorted into a cutting list by sequence, drawing number, main mark number, accessory piece, etc. The **Production Control/Multing/Inventory** interface then will look at your inventory and decide how to best utilize your inventory to minimize waste. In fact if you don't have enough material on order or in stock to fulfill the Bill of Material requirement, it will then decide how many additional pieces you need to purchase and how it should be cut. This information can then be passed to most shop **C.N.C. Equipment** automatically.

Structural Software Co.
5012 Plantation Rd.
Box 19220
Roanoke, Virginia 24019
(703) 362-9118

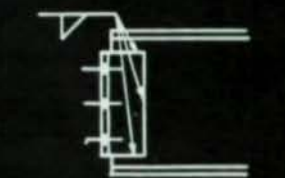
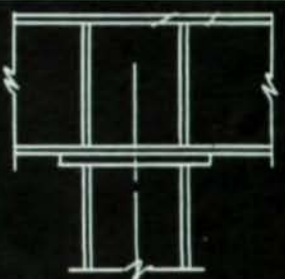
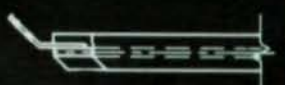
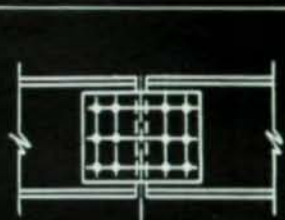
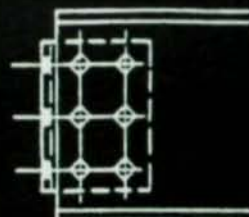
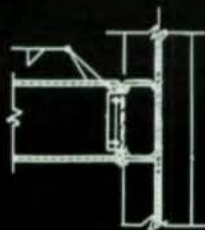
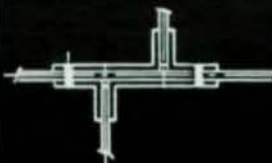
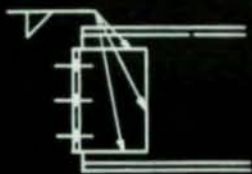
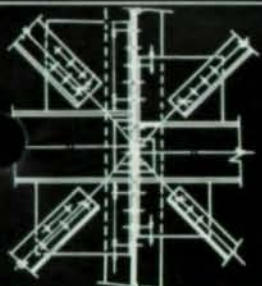
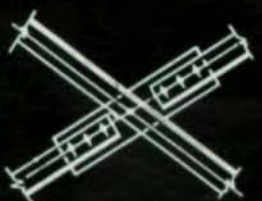
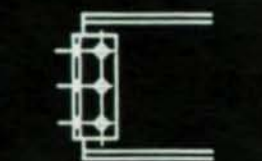
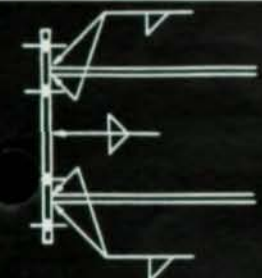
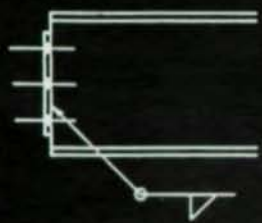
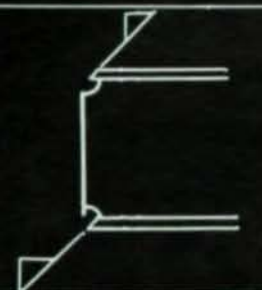

NEW
MODULAR PRICING
From \$35,000

How can you be sure to select the right system?

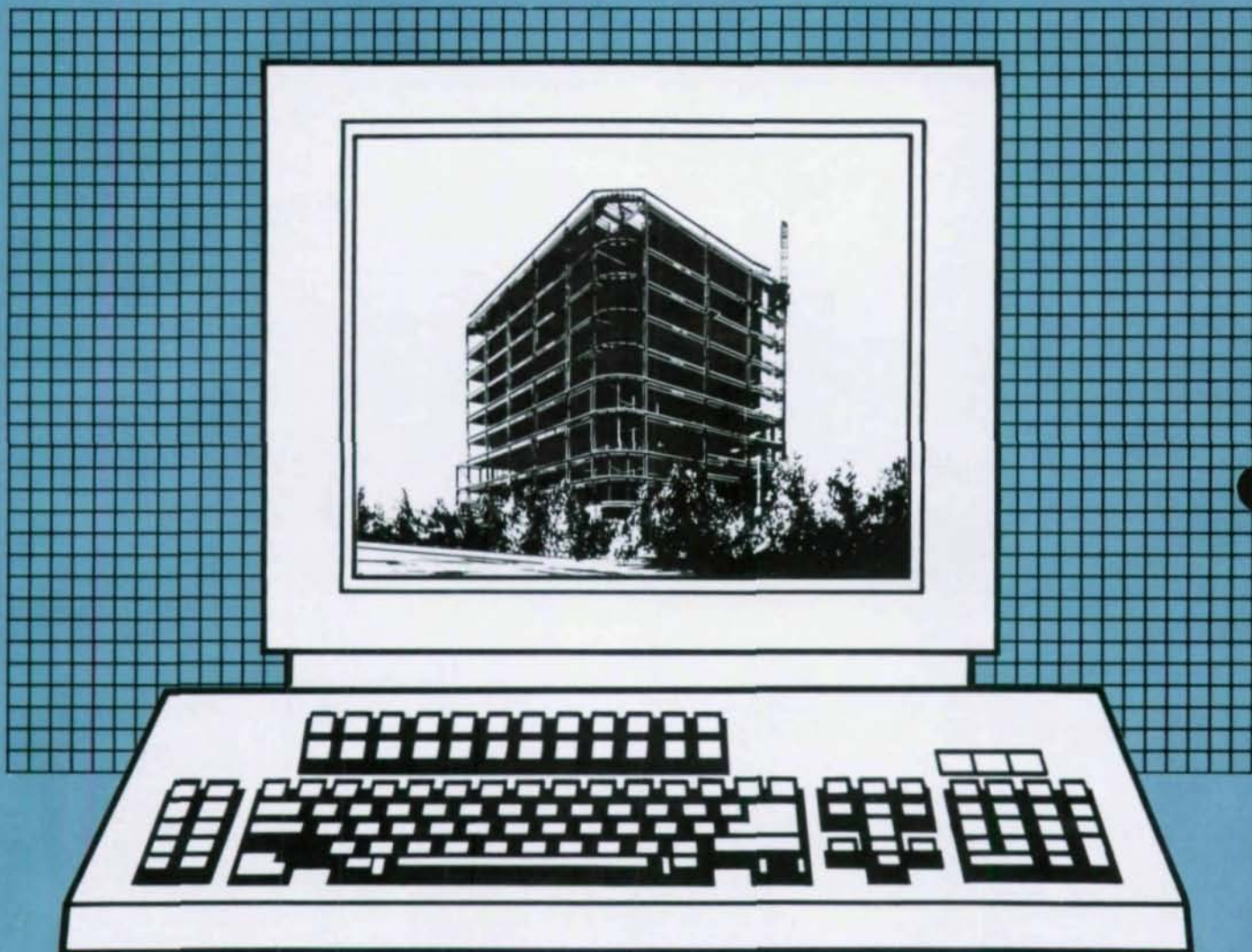

Some computer detailing systems work just fine on standard demonstration jobs . . .

We'll demonstrate **DETAIL™** on your production job. With your people involved, you will be able to clearly evaluate how much time is spent to get results.

Our 90-day trial shows how the best system works in your shop on real jobs.

Geometric Data Flow's Detail™ Feature List

SIMPLE INPUT

- Uses grid planes from design instead of absolute X, Y, Z.
- Allows multiple member input with a single command.
- Virtually eliminates trigonometry calculations for skewed and sloping members.
- Global assignment of connections, as opposed to point by point.
- Produces opposite hand structures with minimal effort.
- Interactive CAD graphics for drawing modifications.
- Easy to learn (8-10 hours training).

INPUT VERIFICATION

- Automatically produces scaled plan and elevation drawings to visually verify steel input and connection assignment prior to plotting shop details, greatly reducing the time required for checking.

DRAWINGS AND REPORTS

- Automatically details all connection material separately.
- Automatically details all members (beams, columns, bracing, etc.) by size and weight, combining all identical members.
- Automatically classifies and composes shop detail drawings for optimum space utilization.
- Automatically plots bills of material showing piece weights, assembly weights, and sheet totals.
- Automatically generates field bolt lists.
- Automatically assigns and plots piece marks customized to your shop standards.
- Automatically generates advance bill of material.
- Automatically generates user-defined piling or staging report for sequencing fabrication and shipping.
- Automatically generates a mill order for most economical lengths.

Automatically plots full size templates.

COMPREHENSIVE CONCEPT

- Details the building as a unit instead of member-by-member.
- Handles all shapes, wide-flange, tube, channel, pipe, etc.
- Supports over 60 commonly used connection types with maximum flexibility within each type.
- Automatically performs design calculations and reports for all connections (base and cap plates, angles, moments, etc.).
- Flags troublesome connections, allowing the user to make corrections prior to plotting detail drawings.
- Preserves marking and sequencing throughout successive design revisions.
- Maintains a complete file of structural members and connection material for interface for other applications.
- Automatically integrates to ESTIMATE™ for estimating and STEELFLOW™ for production management.
- Graphics processor language allows user to implement custom enhancements.
- Integrates to virtually any shop CNC equipment via direct down-load — no tapes or floppy diskettes required.

STATE-OF-THE-ART COMPUTER TECHNOLOGY

- Runs on Compaq 386™ three times faster than other PC/AT compatibles.
- A single workstation supports jobs from several detailers with a clerk/typist performing data input, processing, and plotting functions.
- Allows user to use interactive graphics or on-line formatted screens as alternate input methods.
- Supports voice response technology for super fast input, without a typist.
- Uses professional graphics high resolution monitor — 1024 x 800 pixels.



Associate Members

See us at AISC
NEC/COP #202-206



GEOMETRIC DATA FLOW, INC

337 North Vineyard Avenue, Suite 206
Ontario, Calif. 91764
(714) 984-1269 1-800-DETAIL-5 (338-2455)

STEELCAD II



**Our
Software Details**

**For the Best
in America**

**Come Visit Us
in Miami**

Imaginative Architecture

GENERAL DYNAMICS COMPLEX

Using Steel Effectively

by Guy R. York

General Dynamics Land Systems Division is keenly aware of the importance of using steel effectively when it comes to the design and development of their extraordinary land-based defense vehicles. They expected no less of the design team assigned the task of centralizing their Land System Division administration and engineering forces into a new modern office and research facility.

General Dynamics had two specific goals from the onset of the project. First, to consolidate their administrative and engineering functions into a state-of-the-art office environment and a working laboratory; and second, to integrate the new central office complex with existing data processing and electro-optical facilities. They then retained the Troy, Mich. architectural engineering firm of Ellis/Naeyaert/Genheimer

Associates to provide programming services to define short and long-term needs for office and prototype vehicle development space.

After several possible project locations were evaluated, a site in Sterling Heights, Mich. was selected and the detailed design of the facility began. In June 1985, ground was broken for a 330,000 sq. ft. three-story office structure with a full-service cafeteria

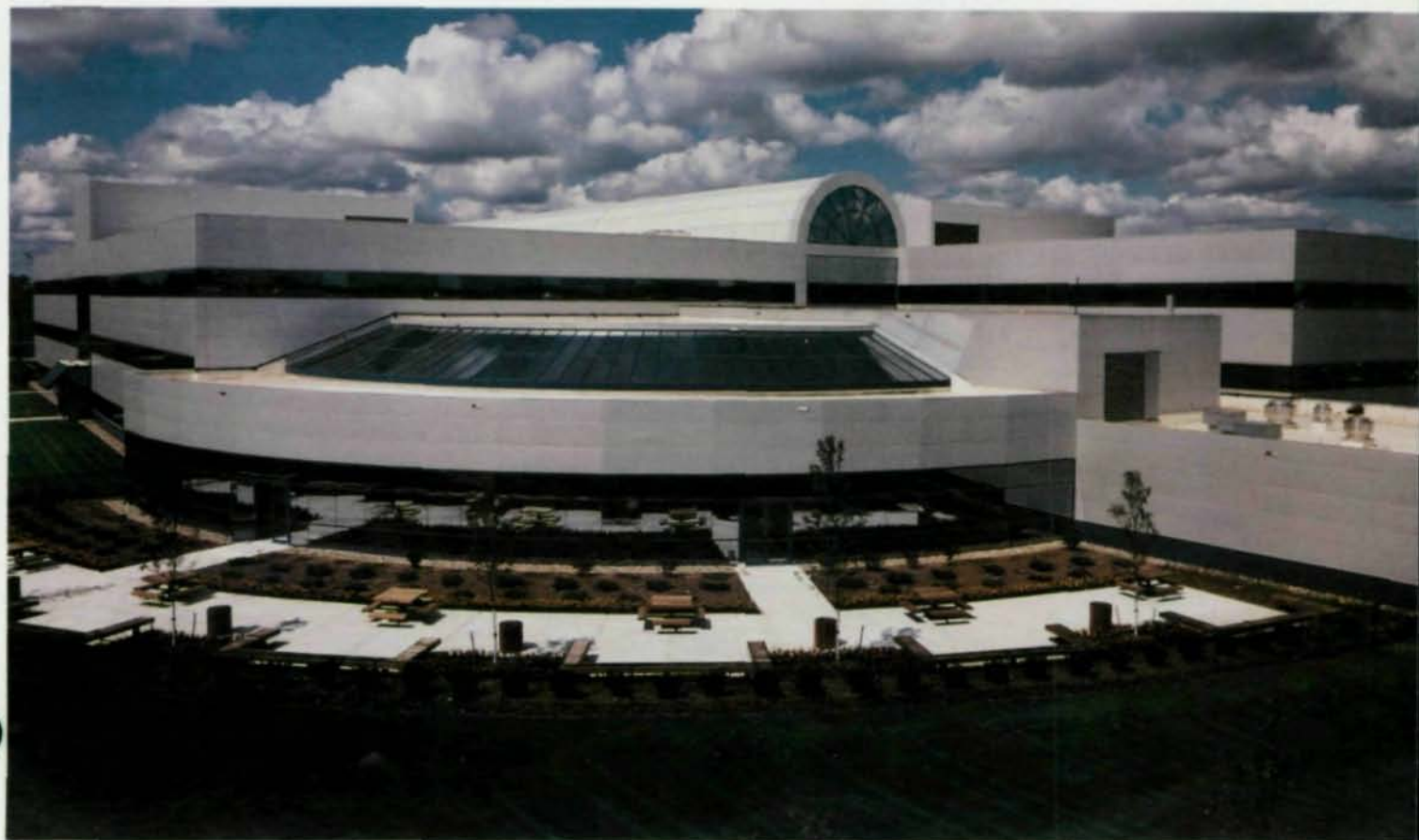



and a connected 120,000 sq. ft vehicle prototype development building. The complex would house approximately 2,200 employees. As the project developed, these specific requirements were defined:

- Present a corporate image with minimized costs
- Provide the necessary security requirements for the U.S. Dept. of Defense
- Offer the flexibility to accommodate changing organizational needs
- Optimize use of open office space by including natural light and exposure to the exterior where possible
- Encourage employee interaction and communication

The final design solution achieved these goals and evolved into two basic building elements (office and shop), actually set in a modular arrangement. The primary structural framing system of structural steel proved ideal for the design requirements.

Steel a Perfect Fit

The general office area, of 32- by 40-ft bays, offers a generous open floor plan for maximum user flexibility. Building ventilation and air-conditioning is furnished by fan penthouses located above three central core areas. These service cores house

stairways, elevators, restrooms, electrical and telephone closets and vending areas, plus conference rooms. Concentration of these areas localized associated building noise to lend a generally quiet office atmosphere elsewhere. The cores likewise offered ideal locations for the vertically braced towers with the required lateral load restraint.

Although the office building has the appearance of a single structure, there are actually two parallel structures linked by a three-story, 30-ft wide by 320-ft long atrium. Three modules 120 by 144 ft each make up the north structure, with two similarly sized modules forming the south structure. Siting of the building permits future addition of modules and skylights north and south of these two elements. The linking atrium brings natural light into both wings through an energy efficient, translucent skylight system. The 15-ft high barrel-vault skylight is set on a continuous structural steel curb, which is supported and stabilized by the extended steel building columns. At each end of the skylight, a steel tube vertical frame provides additional lateral stability for the full height glass curtain wall.

Within the atrium, three sets of bridges connect the parallel structures at the second and third floors. Each of the 20-ft wide bridges are accessible from the adjacent

floors by the use of cantilevered, steel-framed stairways projecting into the open atrium. The cost-to-load capacity ratio was minimized by incorporating the structural steel stringers with the bridge floor frame to provide a unified, three-dimensional framing system. The frame was modeled and analyzed using STRUDL to ascertain flexural, shear and torsional design forces, as well as to observe landing deflections under the possible arrangements of live-load patterns on the stairs and bridges.

A skylight roof system was also employed in the cafeteria module. This 100-ft radius quarter circle area used a stepped and sloping roof configuration, supported by steel beams and columns at three radii. Building expansion joists isolated this shape, allowing an independent, lateral frame. The support system consists of short steel girders on the circle chords with roof beams as spokes supporting the roof elements. To serve 500 people at a time for meals, the area is convertible to an 800-seat presentation area for various company meetings and seminars. Immediately adjacent is a service area offering the full-service kitchen and associated storage and receiving loading docks, with a central mechanical mezzanine.

Design Cost Effective

Early design efforts for the building complex involved review of the most cost effective structural systems. Concrete framing could easily have handled the office arrangement, but structural steel was selected throughout to accommodate:

- Larger spans in the office
- Desire to reduce the overall weight of structure
- Need for integration with a cellular deck for an electrical and communications distribution system
- Least cost and best phased construction schedule limitations
- Employment of single contract for the entire complex, including the industrial prototype development area.

Structure weight was indeed a factor, since the soils of the site were very weak to a subsurface elevation of about 20 ft below grade. Medium depth drilled piers with belled bases were required to take the column loads to suitable soils with a bearing capacity of 8,000 psf and acceptable anticipated settlements. Even the building skin of foam insulated metal sandwich panels was selected partially due to lowering required foundation costs.

Structure weight was further reduced by a doubly beneficial use of composite steel construction with the concrete floor slabs. The 5½ in. total thickness, lightweight con-

0072A



TAKE CONTROL.

Information shared through the Steel Fabrication Computer System from Design Data allows you to take control of the following

- Estimating
- Material Ordering
- Detailing
- Connection Design
- Inventory Control
- Production Control
- Downloading to CNC Equipment
- Job Cost

Take control with the Steel Fabrication System from Design Data. *It's time...*

DESIGN DATA 

"Software For The Professional"
800-443-0782

crete slabs were placed on a blend of 20 ga. steel, 3-in. composite cellular and open beam deck units with bottomless trenches offering a power and communications distribution network. Preset insets for electrical service fittings were located on a 5-ft by 5-ft pattern to provide maximum flexibility in locating work stations as future office layouts required. General Dynamics anticipates this will enable them to link electronic mail, video teleconferencing and mainframe data processing throughout the corporation, world-wide. Nearly the entire

first floor is cellular deck, placed on a mud mat in lieu of conventional slab-on-grade construction to offer the same power/communications distribution system.

Building height was likewise reduced by using the composite construction. Typical 32- by 40-ft bays used W27 x 84 girders and W21 x 50 floor beams at a 14-ft floor-to-floor spacing. Nearly 1,500 tons of structural steel and composite shear studs were erected in the office.

The prototype development building, linked to the office building by a glass cur-

tain wall enclosed walkway, houses various workshops, storage and vehicle work bays. An area where guns, turrets and complete tanks move, this building was equipped with a 50-ton, top running traveling crane, 55-ft bridge span; four 10-ton top running cranes, 27 ft-6 in. bridge span; and a number of two- and three-ton underhung bridge cranes. The entire roof structure, framed with open-web steel joists spanning to conventional pratt roof trusses, was designed for contingent loads to offer flexibility to place additional conveying devices from the structure. Nearly 800 tons of structural steel were erected in this building.

Most of the structural analysis and design was performed by ENGA using in-house computer systems, as well as time-sharing services. The construction drawings were generated on the architect's Intergraph VAX-751 graphics computer system. A fast-track approach was achieved by using the construction management building concept.

Phased occupancy of the new complex began with parts of the office building in December 1986. To complete the complex, the division plans to construct an adjacent laboratory building at a future date. □

METAL DECKS STEEL JOISTS TRUSS GIRDERS

For over 33 years, Riopelle has been providing customers with high quality, S.J.I. Specification steel bar joists, ASCE Standard metal decks.

- **Fast Estimates: Send Us Your Plans**
- **Quick In-House Detailing**
- **Delivery When You Want It**

We serve all fabricators and structural engineers. Our large volume assures both fast delivery and highly-competitive quotes. No job is too big or too small.

For unbeatable prices and favorable credit terms, give us a call today.



8817 West Lynx Avenue
Milwaukee, Wisconsin 53225-1833

Call collect: 414.353.8080
Jim VanDien • Dan Zane • Curt LaCount
FAX: (414) 353-8093
TELEX: 981215 RIO ENG

Architect/Engineer

Ellis/Naeyaert/Genheimer Associates
Troy, Michigan

Construction Manager

Barton-Malow Company
Southfield, Michigan

Steel Fabricator/Erector

Corvo Iron Works, Inc.
Livonia, Michigan

Owner

General Dynamics Land Systems Division
Sterling Heights, Michigan

Guy R. York, P.E., is senior structural engineer at Ellis/Naeyaert/Genheimer Associates, an architect/engineering firm with offices in Troy, Michigan; Asheville & Raleigh, North Carolina; and Charleston, South Carolina.

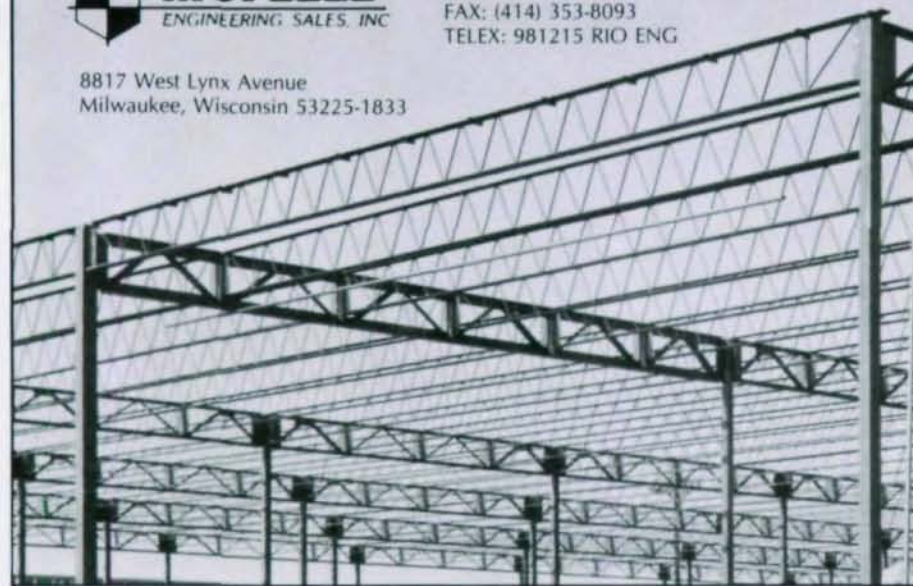

09725

Miami Beach Welcomes AISC's 1988 National Steel Construction Conference



1988 National Steel Construction Conference Schedule of Events

Monday, June 6

- 8:00 a.m. - AISC conference office open;
- 5:00 p.m. Exhibitor Registration only

- 8:00 a.m. - Exhibitor move-in - Grand Ballroom
- 5:00 p.m. Ballroom

Tuesday, June 7

- 8:00 a.m. - Exhibitor move-in continues - Grand Ballroom
- 5:00 p.m. AISC registration desk open - Grand Gallerie, bays 5-8

- 12:00 Noon - AISC registration desk open - Grand Gallerie, bays 5-8
- 5:00 p.m. American Society of Civil Engineers (ASCE) Committee on Steel Building Structures Task Force meeting Imperial III (4th-floor meeting rooms)

Wednesday, June 8

- 8:00 a.m. - AISC registration desk open - Grand Gallerie, bays 5-8
- 8:00 p.m. AISC Marketing, Inc. staff meeting Imperial IV (4th-floor meeting rooms)

- 8:30 a.m. - American Society of Civil Engineers (ASCE) Committee on Steel Building Structures Imperial II (4th-floor meeting rooms)
- 5:00 p.m. Research Council on Structural Connections Imperial III (4th-floor meeting rooms)

- 8:30 a.m. - American Institute of Steel Construction Education Committee Meeting Imperial I (4th-floor meeting rooms)
- 5:00 p.m. American Institute of Steel Construction Education Committee Meeting Imperial I (4th-floor meeting rooms)

- 11:00 a.m. - Partner in Education Advisors' Meeting Imperial I (4th floor)
- 12:00 Noon Partners in Education Luncheon Imperial V (4th floor)

- 12:00 Noon Exhibits open - Grand Ballroom
- 1:00 p.m. Fabricator-Exhibitor Pre-conference Special Session "Justification for Purchasing New Equipment" Location: Fontainebleau Ballroom A & B

- 12:00 Noon Exhibits open - Grand Ballroom

- 1:30 p.m. Fabricator-Exhibitor Pre-conference Special Session "Justification for Purchasing New Equipment" Location: Fontainebleau Ballroom A & B
- 3:00 p.m. This special session, directed specifically to fabricators, places particular emphasis on considerations in planning for the purchase of new automated equipment for the small and medium shop, with the specific intent of reducing man hours per ton of production. The planning process and the factors which should take precedence in decision-making will be discussed.

- 1:30 p.m. Educator Pre-conference Special Session "Current Challenges in Steel Education" Imperial I (4th floor)
- 5:00 p.m. Welcome 1:40 p.m. - "Capstone Projects in Steel Design Teaching" 2:20 p.m. - Classroom Software Exchange 3:00 p.m. - Coffee break (Grand Ballroom) 3:30 p.m. - "Elements for Teaching LRFD"

- 1:30 p.m. - Welcome
- 1:40 p.m. - "Capstone Projects in Steel Design Teaching"
- 2:20 p.m. - Classroom Software Exchange
- 3:00 p.m. - Coffee break (Grand Ballroom)
- 3:30 p.m. - "Elements for Teaching LRFD"

- 1:30 p.m. - American Institute of Steel Construction Professional Member Forum Location: Lemans (lower level)
- 5:00 p.m. Overview of Proposed AISC Specification Changes

- 1:30 p.m. - Overview of Proposed AISC Specification Changes
- 2:00 p.m. - Preparation of New AISC Design Guides
- 3:00 p.m. - Coffee break (Grand Ballroom)
- 3:30 p.m. - Professional Member assistance in B-



Testing of Electronic LRFD
4:00 p.m. - AISC Codes
and Standards for Fabricated Steel:

- a. Quality Criteria and Inspection Standards
- b. Code of Standard Practice
- c. Quality Certification

3:00 p.m. - **Coffee break** - Grand Ballroom (exhibits open)

3:30 p.m. - **WORKSHOP SESSIONS**

- 5:00 p.m.
1. **Heat straightening** - Bordeaux (lower level)
 2. **Heat Curving** - Lorraine (lower level)
 3. **Purchasing new equipment** (Workshop session) - Burgundy (lower level)

6:30 p.m. - **Get-acquainted cocktail party** - Grand Ballroom

Thursday, June 9

7:00 a.m. - **Registration desk open** - Grand Gallerie, bays 5-8

7:15 a.m. - **Southern Association of Steel Fabricators (SASF)**
8:15 a.m. Breakfast meeting for educators

SASF members will host a breakfast for educators from Tennessee, Louisiana, Georgia, Florida, Alabama, Mississippi and Arkansas
Location: Voltaire (4th floor)

7:15 a.m. - **Virginia Carolinas Structural Steel Fabricators (VCSSF)**
8:15 a.m. Breakfast meeting for educators

VCSSF members will host the breakfast for educators from Virginia, North and South Carolina
Location: Lafayette (4th floor)

7:30 a.m. - **Continental breakfast** - Grand Ballroom (exhibits open)

8:30 a.m. **THE 1988 NATIONAL STEEL CONSTRUCTION CONFERENCE**
Opening Plenary Session - Fontainebleau Ballroom

8:45 a.m. **Keynote address:** *Walter P. Moore, Jr.*, president and chairman,

Walter P. Moore Associates, Houston, Tex.
"The Future of Tall Steel Buildings"

9:30 a.m. **"AISC Third Ed., Quality Criteria and Inspection Standards"**
AISC staff presentation

9:50 a.m. **Special Citation Awards to:**
Dr. William H. Munse
University of Illinois
Dr. Edwin H. Gaylord
University of Illinois
Dr. Bruce G. Johnston
University of Michigan

10:00 a.m. **Coffee break** - Grand Ballroom (exhibits open)

- 10:30 a.m. **WORKSHOP SESSIONS**
4. **Bolt follow-up** - Imperial I (4th floor)
 5. **Shop Planning** - Imperial II (4th floor)
 6. **Steel decks/design and construction** - Bordeaux (lower level)
 7. **Economical Steel Design & Stability Provisions** - Burgundy (lower level)
 10. **Weld design** - Imperial III (4th floor)
 11. **Angle compression members** - Lorraine (lower level)
 12. **Short-span bridges** - Lemans (lower level)

11:00 a.m. - **SPOUSES' BRUNCH**
12:15 p.m. Fleur de Lis (first floor)

12:00 Noon - **LUNCH** - Grand Ballroom
1:30 p.m. (exhibits open)

12:30 p.m. - **SPOUSES' TRIP: VIZCAYA**
5:00 p.m. (Buses leave and return from hotel's main entrance.)

1:30 p.m. - **EXHIBIT SESSION** - Grand Ballroom
3:30 p.m. To encourage attendees to visit the exhibits, no workshop sessions will be held during this time period.

1:30 p.m. - **POSTER SESSION** - Jade Promenade (adjacent to Grand Ballroom)

3:30 p.m. A Poster Session is being presented for the first time at an AISC Conference. Authors of more than

20 selected papers will make their presentations in poster form and conduct question-and-answer discussions during this informal session.

- 3:30 p.m. - **WORKSHOP SESSIONS**
5:00 p.m.
- 5R. **Shop planning** (repeat) - Imperial II (4th floor)
 - 6R. **Steel decks/design & construction** (repeat) - Bordeaux (lower level)
 9. **Quality criteria** - workshop - Imperial I (4th floor)
 17. **Connections - mixed construction** - Imperial III (4th floor)
 19. **LRFD seismic design** - Burgundy (lower level)
 21. **Computerized LRFD Specification** - Lorraine (lower level)

5:00 p.m. Adjourn

6:00 p.m. - **American Society of Civil Engineers (ASCE)**
10:00 p.m. Committee on Fatigue & Fracture Meeting
Location: Brittany (lower level)

6:00 p.m. - **American Society of Civil Engineers (ASCE)**
10:00 p.m. Committee on Structural Connections Meeting
Location: Champagne (lower level)

7:00 p.m. - **Miami at Night**
10:00 p.m. Attendees may purchase tickets in advance or at the AISC registration desk in the Fontainebleau for dinner and floor show (tax, tips and transportation included - drinks are *not* included) at one of Miami's best supper clubs. Buses leave and return to hotel main entrance.

7:00 p.m. - **"The Spirit" dinner cruise**
10:00 p.m. All the elements of an ocean-going cruise on an affordable intercoastal adventure. Live entertainment, dinner and dancing while cruising one of the most beautiful waterways

in the country. Tickets (purchase at AISC registration desk) include all transportation, dinner, dancing, tips and taxes. Cash bar.

Friday, June 10

- 7:00 a.m. - Registration desk open
5:00 p.m.
- 7:30 a.m. - Continental breakfast -
8:30 a.m. Grand Ballroom (exhibits open)
- 8:30 a.m. - Plenary Session - Fontainebleau Ballroom
9:30 a.m. "Solutions for the Use of Jumbo Shapes" - Reidar Bjorhovde
- 9:00 a.m. - Spouse's Trip to Everglades (includes lunch)
4:30 p.m. (Buses leave and return from hotel main entrance.)
- 9:30 a.m. Coffee break - Grand Ballroom (exhibits open)
- 10:00 a.m. WORKSHOP SESSIONS
1R. Heat straightening (repeat) - Imperial I (4th floor)
2R. Heat curving (repeat) - Imperial II (4th floor)
8. United Airlines Terminal - Bordeaux (lower level)
10R. Weld design (repeat) - Imperial III (4th floor)
13. Jumbo shapes (workshop) - Burgundy (lower level)
16. Innovative bridges - Lorraine (lower level)
- 11:30 a.m. LUNCH - Grand Ballroom (exhibits open)
- 1:15 p.m. WORKSHOP SESSIONS
4R. Bolt follow-up (repeat) - Imperial I (4th floor)
7R. Economical steel design and stability provisions (repeat) - Burgundy (lower level)
14. Waste disposal - Imperial II (4th floor)
15. Tubular structures and connections - Imperial III (4th floor)
18. Controlling wind response - Bordeaux (lower level)
20. Fire protection - Lorraine (lower level)

- 2:45 p.m. - Coffee break - Grand Ballroom (exhibits open)
3:30 p.m.
- 3:30 p.m. EXHIBITOR MOVE-OUT begins
- 3:30 p.m. - WORKSHOP SESSIONS
5:00 p.m. 8R. United Airlines Terminal (repeat) - Bordeaux (lower level)
9R. Quality criteria (repeat) - Imperial I (4th floor)
13R. Jumbo shapes (repeat) - Burgundy (lower level)
14R. Waste disposal (repeat) - Imperial II (4th floor)
21R. Computerized LRFD Specification (repeat) - Lorraine (lower level)

5:00 p.m. ADJOURN

- 7:00 p.m. The 1988 NATIONAL STEEL CONSTRUCTION CONFERENCE DINNER "Moon Over Miami"
Attendees join new and old friends under the stars for a sumptuous poolside buffet and some of the finest entertainment Miami offers. Tickets for dinner and entertainment available in advance or at AISC Registration Desk (cash bar).

Saturday, June 11

- 8:30 a.m. - Plenary Session - Fontainebleau Ballroom
10:00 a.m. A tribute to memory of T. R. Higgins
- Dr. Lynn S. Beedle, professor
Lehigh University - Bethlehem, Pa.
THE 1988 T. R. HIGGINS LECTURE
- Bruce Ellingwood, professor
The Johns Hopkins University - Baltimore, Md.
- 10:00 a.m. - Coffee break - Jade Promenade
10:30 a.m.
- 10:30 a.m. "More Steel for the Buck" Plenary Session - Fontainebleau Ballroom
This panel discussion includes a consulting engi-

neer, the chief engineer for a steel fabricator, a steel erector and a structural steel detailer, and offers illustrations and suggestions for improving interaction between the various disciplines.

12:00 Noon - Drawing for Attendance Prizes
12:15 p.m.

12:15 p.m. THE 1988 NATIONAL STEEL CONSTRUCTION CONFERENCE officially adjourns

1:30 p.m. Seaquarium
5:00 p.m. Tour of Miami's world famous sea-sized aquarium. Tickets, including transportation and admission, available at AISC registration desk.

1:30 p.m. Parrot Jungle
5:00 p.m. Visit to unique attraction where parrots, macaws and exotic tropical birds fly free. Tickets, including transportation and admission, available at AISC registration desk.

Conference Proceedings, 640 pgs, will be available for \$35.

Key to 1988 Workshop Sessions

1. Heat straightening
2. Heat curving
3. Purchasing new equipment
4. Bolt follow-up
5. Shop planning
6. Steel decks/design & construction
7. Economical steel design & stability provisions
8. United Airlines Terminal; A case history
9. New Quality Criteria & Inspection Standards
10. Weld design-weld metal
11. Angle compression members
12. Short-span bridges
13. Jumbo Shapes: Workshop
14. Waste disposal
15. Tubular structures & connections
16. Innovative bridges
17. Connections-mixed construction
18. Controlling wind response
19. LRFD seismic design
20. Fire protection
21. Computerized LRFD Specification
22. Steel-framed high-rise residential buildings

PROGRAM SUMMARY
(Note: "R" sessions are repeats)

Wednesday, June 8 - Pre-conference events

- 8:30 p.m. - 3:00 p.m. - Plenary session: Purchasing New Equipment
- 1:30 p.m. - 5:00 p.m. - Educator session
- 1:30 p.m. - 5:00 p.m. - AISC Professional Member Forum
- 3:30 p.m. - 5:00 p.m. - Workshop Sessions 1 2 3
- 6:30 p.m. - 7:30 p.m. - Cocktail party

Thursday, June 9

- 8:30 a.m. - 10:00 a.m. - Opening Plenary Session/Keynote: Moore
- 10:30 a.m. - Noon - Workshop Sessions 4 5 6 7 10 11 12
- 1:30 p.m. - 3:30 p.m. - Exhibit Session
Poster Session
- 3:30 p.m. - 5:00 p.m. - Workshop Sessions 9 5R 6R 17 19 21 22
- 7:00 p.m. - 10:00 p.m. - Miami at Night Optional Tour
- 7:00 p.m. - 10:00 p.m. - "The Spirit" Dinner Cruise Optional Tour

Friday, June 10

- 8:30 a.m. - 9:30 a.m. - Plenary Session: Jumbo Shapes
- 10:00 a.m. - 11:30 a.m. - Workshop Sessions 1R 2R 8 10R 13 16
- 1:15 p.m. - 2:45 p.m. - Workshop Sessions 4R 7R 14 15 18 20
- 3:30 p.m. - 5:00 p.m. - Workshop Sessions 8R 9R 13R 14R 21R
- 7:00 p.m. - 10:00 p.m. - The 1988 National Steel Construction Conference Dinner

Saturday, June 11

- 8:30 a.m. - 8:45 a.m. - T. R. Higgins Tribute
- 8:45 a.m. - 10:00 a.m. - The 1988 T. R. Higgins Lecture
- 10:30 a.m. - Noon - Plenary Session: "More Steel For the Buck" - Panel
- 12:00 Noon - Drawing for door prizes
- 12:15 p.m. - 1988 National Steel Construction Conference officially adjourns
- 1:30 p.m. - 5:00 p.m. - Seaquarium optional tour
- 1:30 p.m. - 5:00 p.m. - Parrot Jungle optional tour



CST

Punches & Dies

- 24 Hour Shipments
- Lowest Prices



Write for catalogs.



Call 1-800-446-4402

THE CLEVELAND STEEL TOOL CO.

474 E. 105th Street • Cleveland, Ohio 44108
A-1401

"See you at AISC"

T.S.® Bolts & Tools

I.C.B.O. Listed
Full range of certified A325 and A490 bolts and complete complement of tools for installation, including "Tone" tools and the new TSW 60LC high speed, swivel head tool.

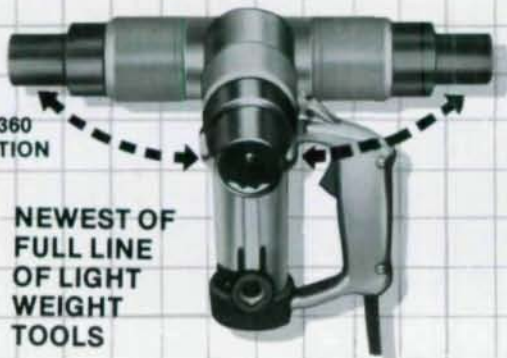

FULL 360 ROTATION

NEWEST OF FULL LINE OF LIGHT WEIGHT TOOLS

BRISTOL® MACHINE COMPANY
cfs Construction Fastener Systems Division

630 E. Lambert Road, Brea, CA 92621 • 714-990-6555
WATS 1-800-872-6587

ELLINGWOOD IS 1988 HIGGINS LECTURER

The 1988 T. R. Higgins Lecture will be presented Saturday morning, June 11, by Bruce Ellingwood. His award-winning lecture, "Serviceability Guidelines for Steel Structures," covers many of the guidelines being developed. He will address the fact that modern structural design methods, such as LRFD, distinguish between safety and serviceability. Strength provisions of specifications and codes provide for the safety aspects of design. He says serviceability guidelines are needed to assist in the design of buildings which are not only structurally sound but have satisfactory

deformation and vibration characteristics.

Ellingwood is currently a professor in the Department of Civil Engineering, The Johns Hopkins University, Baltimore, Md. He received his undergraduate, graduate and doctoral education at the University of Illinois, Champaign-Urbana. His main research interests involve application of methods of probability and statistics to structural engineering. A member of numerous industry organizations, Ellingwood has received several awards, including the ASCE Walter L. Huber Engineering Research Prize and the Norman Medal. □



Bruce Ellingwood

THREE SPEAKERS TO KEYNOTE NATIONAL STEEL CONSTRUCTION MEET

A different featured speaker will open each day's session at the 1988 National Steel Construction Conference to be held June 8-11 at the Hilton Fontainebleau Hotel, Miami Beach, Fla.

Thursday morning, June 9, Walter P. Moore, president and chairman, Walter P. Moore Associates, Houston, is the keynote speaker. His topic, "The Future of Tall Steel Buildings," highlights expected developments in design, materials and erection of high-rise buildings.

Reidar Bjorhovde, head of the civil engineering department, University of Pittsburgh, addresses "Solutions for the Use of Jumbo Shapes" on Friday morning, June 10. He is to present a position paper describing possible solutions for the engineer and fabricator dealing with the problems of welded splices in heavy wide-flange shapes. Following his presentation, there will be a workshop with representatives from domestic and foreign mills discussing their individual research studies and recommendations.

On Saturday morning, Bruce Ellingwood presents the 1988 T. R. Higgins Lecture, "Serviceability Guidelines for Steel Structures." □



Walter P. Moore



Reidar Bjorhovde

STEEL DETAILING

with

AUTOCAD



"BEAMS and COLUMNS"

Version 3

The most versatile
Structural Steel
detailing system
available...

COMPUTER
AIDED
DETAILING

Developed by Detailers for Detailers

COMPUTER DETAILING CORP.

1310 Industrial Blvd.
Southampton, PA 18966
215-355-6003

Le JEUNE "Domestic"

TENSION CONTROL FASTENING SYSTEM

**ONLY Le JEUNE IS
MADE IN THE USA**



Full domestic factory mill certification—traceable to each keg. Meets or exceeds current ASTM A-325, A-490 specifications.

**"THE LOWEST COST METHOD
FOR PROPERLY INSTALLING
HIGH STRENGTH BOLTS!"**

***Le JEUNE Tension Control Bolts
can be used wherever A-325 or A-490
high strength bolts are required.***

Combined benefits of low cost installation, consistent tension, and visual inspection have allowed Le JEUNE T.C. Bolts to be used in an impressive list of applications. Hospitals, schools, stadiums, bridges, power plants, warehouses, skyscrapers, auto plants, airport terminals...*the list goes on.*



Le JEUNE BOLT COMPANY
8330 West 220th Street
Lakeville, Minnesota 55044
Phone: 612 469-5521

**FOR INFORMATION OR
TECHNICAL ASSISTANCE
CALL 1-800-USA-BOLT (872-2658)
FAX 1-612-469-5893**

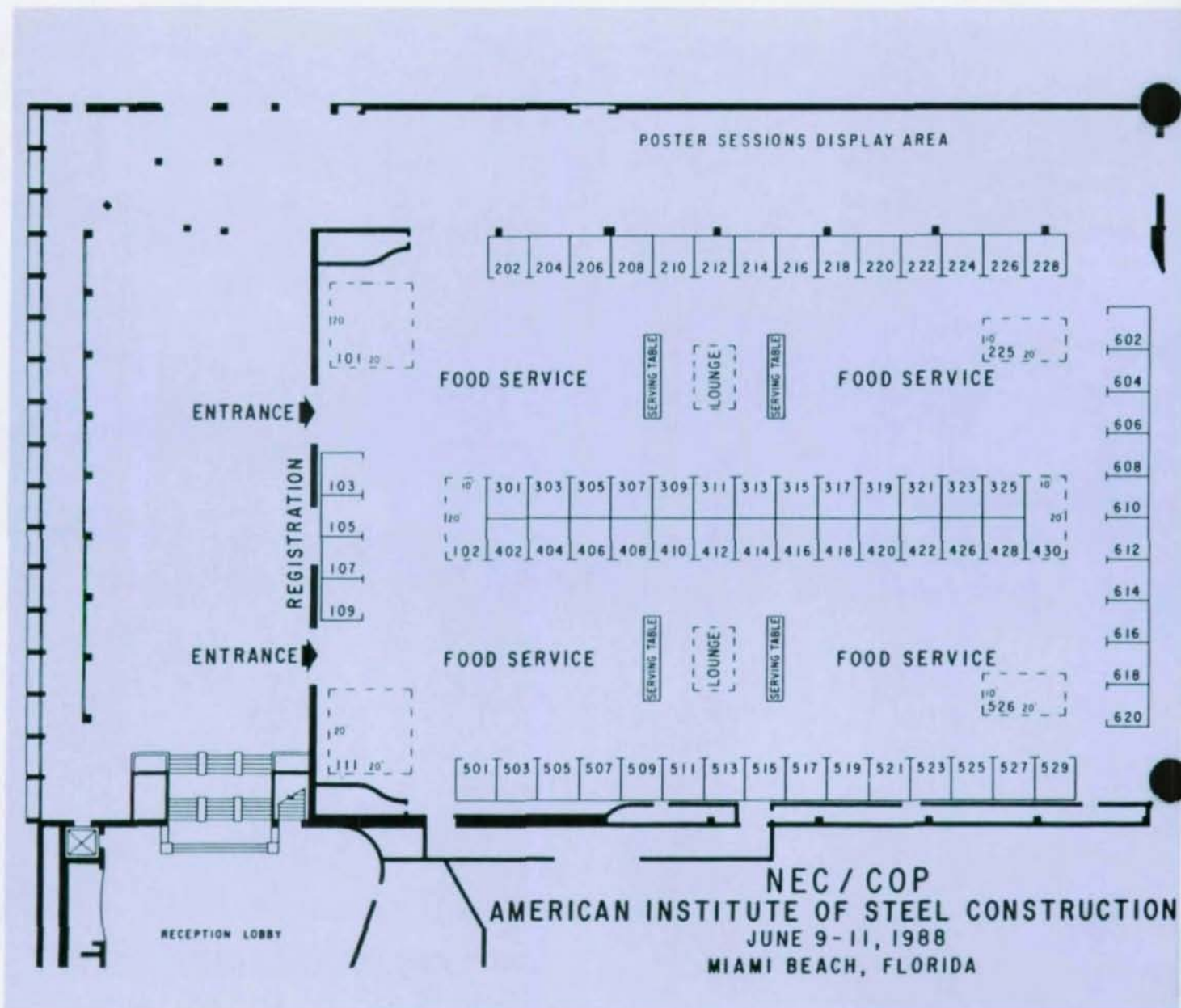

1988 NSCC Exhibitors to 4/19/88

Booth Company

111 American Institute of Steel Construction, Inc.	418 Epic Metals	602 Pneutek, Inc.
519 American Welding Society	222 FABTRACK	521 Production Machinery, Inc.
416 Armstrong-Blum Mfg. Co.	202 Geometric Data Flow	525 Research Council on Structural Connections
321 Associated Piping & Engineering Company	610 Graeme & Murray Consultants, Ltd.	501 Research Engineers, Inc.
111 AISC Marketing, Inc.	218 Hillman, Inc.	109 Richmond Erectors
606 Carboline Co.	604 Hypertherm	107 Richmond Steel
208 Cleveland Steel Tool Co.	404 Jancy Engineering	214 The Sharon Companies
614 Compudron, Inc.	307 Jet Wheelblast Equipment, Div., B & U Corporation	305 Southern Coatings, Inc.
430 COMEQ	608 JH Engineering	420 Steel Deck Institute
220 Data Management Systems, Inc.	212 Kaltenbach, Inc.	224 Struct-Fast Inc.
103 Derr Construction Company	301 LeJeune Bolt Company	226 Structural Software Company
309, Design Data	315 The Lincoln Electric Company	216 Tnemec, Inc.
410 D&M Drafting, dba Dogwood Technologies	105 Lohr Structural Fasteners, Inc.	505 Trade ARBED, Inc.
513 Elite Equipment	515 Mountain Enterprises	210 J. & M. Turner, Inc.
408 Engineering Design Automation	325 MDX	323 Valmont Industries
	102 Peddinghaus Corporation	422 Vernon Tool Company
	526 Pettitt Lawrence, Ltd.	402 Waterloo Engineering Software
	303 S. G. Pinney & Associates	426 W. A. Whitney Corporation
		225 Yamazen, U.S.A.

Now you can put all of your eggs in one basket.



The first structural analysis/design software with built-in drafting
Fully capable beyond 640K memory
(all for only \$3,400*)

The Integrated Structural Design System: classic STAAD-III analysis and design, STAADPL graphics, plus STAAD-DRAFT—the brand new drafting facility designed especially for structural engineers. One complete package. \$3,400.

This unprecedented level of integration is a much needed breakthrough for structural engineers. Previously, to generate drawings from design data, some sort of interface package was necessary to link the two programs. This cumbersome process involved purchasing, maintaining, and learning two (or more) programs from different vendors.

ISDS solves this problem with its unique capability

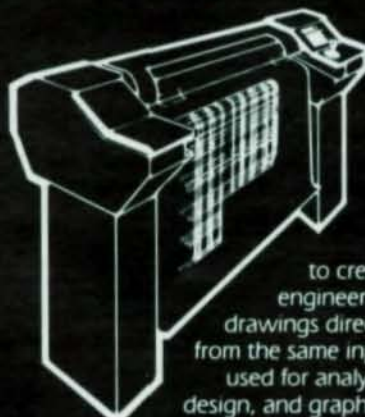

to create engineering drawings directly from the same input used for analysis, design, and graphics.

Furthermore, this information is held in a central database maintained by ISDS. User interaction is minimized, improving both efficiency and data integrity.

It makes sense.

At the heart of ISDS, STAAD-III performs static and dynamic analyses on two- and three-dimensional structures and designs

members in steel or concrete based on user-selected standard codes. Available codes include AISC working strength and the new LRFD specifications involving member deflection considerations, as well as ACI and AASHTO codes. STAAD-III handles a wide variety of loading conditions, including internally generated moving loads.

For more details on STAAD-III based ISDS or a demonstration version, please call or write: Research Engineers, 303 Pavilions at Greentree, Marlton, NJ 08053. Phone: (609) 983-5050. TLX: 4994385.

In Europe, Research Engineers, 17 Lansdowne Rd., Croydon CR9 3UN, U.K. Phone: 01 6867672 TLX: 929181.

*Licensing fee on MS-DOS based PCs

Research Engineers, Inc.
A REPUTATION YOU CAN BUILD ON

NEW IDEAS MAKE TRUSS BRIDGES COMPETITIVE

French Bridge Uses "Corrugated-web" Panels



Maupre Viaduct after completion

One of several experts from outside the U.S. who will appear on the program at the National Steel Construction Conference this year will be Jacques Combault, chief engineer of the Campenon Bernard BTP design and research department. Since 1980, Combault has been involved in the use of external prestressing for all types of bridges, specifically in incrementally launched bridges.

In a presentation during the same session, "Innovative Bridges," scheduled for Friday morning, June 10, 10:00 a.m., Ray J. McCabe, principal in the New York-based structural engineering firm of Howard Needles Tammen & Bergendoff, discusses new ideas in design, details, fabrication and erection which make truss bridges competitive with other structural types in the span range of 400-900 ft. Fox's presentation emphasizes the advantages of composite design and methods to obtain it.

McCabe also discusses aesthetics, need for sway bracing, corrosion protection and roadway decks—including orthotropic plates, elimination of stress-relieving deck joints, load-factor design, high-strength steels and design data for preliminary designs.

With P. Thivans and M. Cheyrezy, also of the Campenon Bernard BTP, Combault has designed a new type of composite structure using thin corrugated webs for bridge erection. These high-capacity girders made of concrete slabs connected to thin corrugated steel webs "increase stability, strength and efficiency of the materials used," according to Combault.

After considerable theoretical analysis, the French firm started a test program on isolated web panels in its experimental laboratory. A box girder loaded by prestressing was then designed and built. When tests performed on the model were successful, the French Department of Transportation gave Campenon Bernard BTP the opportunity to build an experimental bridge at Cognac, France. The bridge is subject to regular control surveying, which to date has confirmed the computations carried out before construction.

A second bridge using corrugated webs, a 1,064-ft long, seven-span viaduct near Charolles in Central France, has now been completed by the firm. Combault describes this new structure, erected by incremental launching, as "a structure of the future" for numerous reasons:

- Triangular typical deck cross section
- A bottom flange consisting of a steel pipe filled with reinforced concrete
- Webs welded onto the pipe and made of thin corrugated steel plates, 8-mm thick
- Very low dead loading, the weight of the deck being 10 t/m only. □

QUICK, ONE-SIDED GRATING FASTENING WITH THE GRATE-FAST SYSTEM.

- Installation by one man with a wrench working one-side.
- Sturdy, fits most standard bar grating.
- Fits in your hand.
- It is secure, adjustable, removable and relocatable.
- No welding, no drilling, no scaffolding necessary.

STRUCT-FAST INC.
 20 Walnut St., Suite 101
 Wellesley Hills, MA 02181
 617-235-6734
 800-327-6719

Please send me details

Name _____

Position _____

Company _____

Address _____

Tel _____

Struct-Fast Inc., 20 Walnut Street, Suite 101, Wellesley Hills, MA 02181

WIND RESPONSE CONTROLS

All buildings are often subjected to wind-induced vibrations which can cause human discomfort and other serviceability problems. Research regarding human sensitivity and procedures to predict motion, as well as methods to control wind response are outlined in companion presentations at a workshop Friday afternoon, June 10, 1:15 - 2:45 p.m. at the National Steel Construction Conference.

Ahsan Kareem, an associate professor and director of the Structural Aerodynamics and Ocean Systems Modeling Laboratory of the University of Houston's Civil Engineering Department, discusses performance requirements for serviceability in terms of limit-state equations. In the event a building does not meet those requirements, he also suggests design modifications including a "hybrid, knowledge-based expert system" currently under development. Kareem is conference chairman of the Sixth U.S. National Conference on Wind Engineering to be held in March 1989.

Carla J. Keel, an associate structural engineer with the consulting firm of Killing Ward Magnusson Barkshire Inc., examines two buildings in which a unique damping system for wind vibration control was employed. These engineered viscoelastic damping devices were developed, designed and installed in the Columbia Center building in Seattle. Similar devices are now being developed for the Two Union Square Building in that city. Keel will present a detailed discussion of these damping units, which she has helped to develop for both structures. □

DETAIL ANY JOB YOUR WAY!
AND THE ENGINEER'S WAY!

ME2

P.C. BASED
STEEL DETAILING SYSTEM
MOUNTAIN ENTERPRISES INC.
304-876-3845
SHEPHERDSTOWN, WV 25443



ARBED'S NEW EXPANDED RANGE OF ROLLED WF & WTM BEAMS KEEP QUALITY HIGH, COSTS LOW.

Arbed's rolled 40" beams, available in 16 sections from 149 to 328 lbs., has now been expanded to include our new rolled 44" beams, available in 4 sections from 198 to 245 lbs. They all offer the same benefits we're famous for: high section moduli, great lateral buckling resistance, and the ability to compete economically with both fabricated sections, as well as reinforced precast and prestressed concrete.

Arbed's rolled "Tailor-Made" series (up to 42.45" x 18.13" x 848 lbs) . . . lets you specify the beam weight you need, other than what is normally available. Result? Big savings in fabrication costs and weight.

Get all the facts now . . . send the coupon for information including complete specifications.

TradeARBED, Inc., 825 Third Ave.,
24th floor, New York, NY 10022.
(212) 486-9890,
FAX: 212-355-2159/2421,
Dom. TX: (W.V.) 125 159,
Int'l TX: (ITT) 421-180.

In Canada: TradeARBED Canada,
Inc. 3340 Mainway, Burlington,
Ontario, Canada L7M 1A7
(416) 335-5710,
FAX: (416) 335-1292, TX: 0618258.

Please send me the NEW literature
on ARBED's 40", 44" and
"TAILOR-MADE" rolled beams.

Name _____ Title _____

Firm _____

Address _____

City _____

State _____ Zip _____

TRADE ARBED Inc.
INNOVATORS OF STEEL CONSTRUCTION PRODUCTS

NORSTAR BANCORP

A New "Station" in Life

by J. Thomas Ryan and Chester J. Zaremba



In 1898, the New York Central and Hudson River Railroads decided to build a train station and corporate headquarters in downtown Albany. The structure, known as Union Station, became the crossroads of the Empire State linking New York City and Boston with Buffalo and the west via Albany.

In its earlier years, this magnificent station served thousands of railroad passengers each day. But in 1968, the station, listed in the National Register of Historic Places, saw its last train depart. This great building with a glorious past became a

doomed structure—abandoned real estate. The building interior and structural system deteriorated rapidly.

In 1984, with the monumental structure on the verge of demolition, Norstar Bancorp purchased Union Station and began the extensive restoration/renovation project to convert the building to its corporate headquarters. Norstar not only gave this magnificent part of our past a new life, but also, as U.S. Senator Alfonse D'Amato declared, it became the "cornerstone for the total redevelopment of downtown Albany." The social and economic benefits to the

New life for Buffalo's grand old Union Station. Magnificent new lobby floor was added and mezzanine widened to maintain overall spaciousness, double floor area.

city are enormous. At least three other development projects are now underway in downtown Albany, all stimulated by the reawakening of Union Station.

Because the building did not have sufficient office space for Norstar, the renovation would only be feasible if the design could provide for additional floor area. To achieve this, a complete new main lobby floor was added one level above the original lobby on ground level. And the mezzanines were widened and raised. The overall spaciousness of the grand interior was maintained. In the wings, three floors were made into four. By doing this, the usable floor area was increased from the original 52,000 sq. ft to 102,000 sq. ft—which made the project practical.

Engineering a Challenge

The engineering problems encountered in the renovation were a challenge. By 1984, much of the original structural steel and some of the masonry bearing walls had experienced significant deterioration because of long-term water damage. A substantial percentage of the structural steel roof trusses, steel floor beams and columns were rusted so extensively that significant load capacity had been lost. All of the structural steel components were field-evaluated and the remaining thicknesses of sound material measured. New reduced section properties were calculated and safe load capacities determined.

As it existed, the structural steel did not have adequate capacity to carry safely the proposed loads. To replace the steel would have been prohibitively expensive and would have jeopardized the project. The



Before—interior of ravaged Union Station

solution was to remove the heavy concrete and tile roof and floor systems and replace them with a lighter weight steel deck and concrete slab system. This load reduction made the partially deteriorated members structurally adequate. About 80% of the existing steel was cleaned and left in place for reuse. Where necessary, severely deteriorated steel components were reinforced or replaced.

The exterior masonry bearing walls of the station could not support the weight of the new enlarged mezzanines and the added lobby floor level. New columns could not be installed along the inside of the walls because they would conflict with the decorative plaster window arches and other historically significant components of the building. The unique structural design solution was to install new structural steel columns inside existing hollow ventilation shafts in the exterior wall. So as to fit the columns in the hollow void areas, short column sections were used. New foundations were designed to support the columns. Thus, the new columns were hidden within the existing structure.

New life through creative engineering:

A. Lightweight roof system replaced original heavy concrete and tile. **B.** New support columns inside ventilation shafts support enlarged mezzanines, added floor lobby, not possible with existing bearing walls.

C. Shallow, continuous composite steel intermediate floor system is suspended from floor above. **D.** Since facade could not support mezzanines, new columns were designed and hidden behind cast iron columns. **E.** Intricate structural steel system supports mechanical platforms without interfering with ceiling suspension or overloading roof trusses.

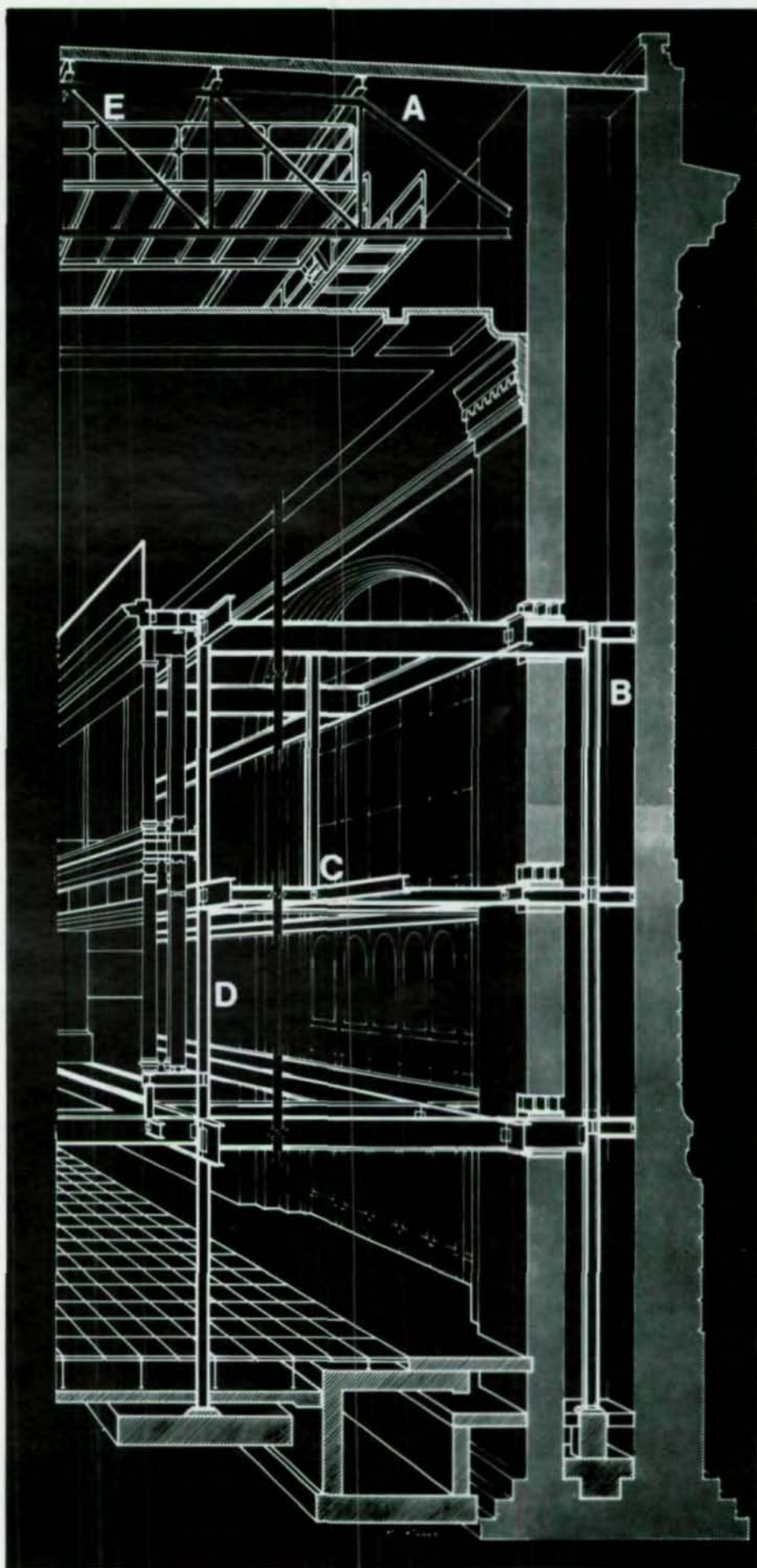

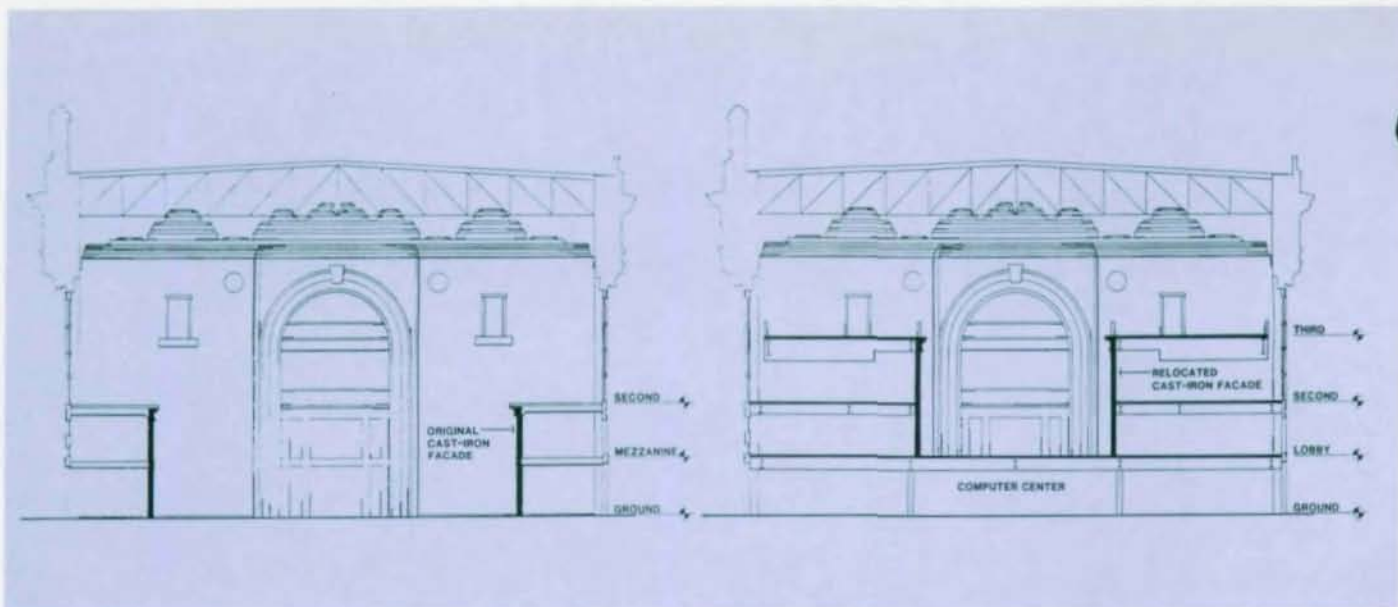

Fig. 1. Original section

Fig. 2 New section



Norstar Bancorp's handsome restoration of Buffalo's landmark depot (above). Original structure (top, r.). At right, interior before remodeling gives some idea of original elegance of station.



Steel Columns "Tucked in"

One of the major architectural significant interior features of Union Station was a two-story, cast-iron facade which served as structural support for the original mezzanines. The architectural concept was to raise the cast-iron facade, comprised of

many thousands of pieces, one full story and shift it closer to the center of the building to enlarge the mezzanine spaces. To accomplish this difficult task, the inner edge of the new mezzanine was supported by tucking new structural steel columns in behind the relocated cast-iron columns.

A practical and economical method of attaching the cast-iron facade to the new structural steel framing was developed for the mezzanine. The structural steel design and details were developed creatively so the cast-iron facade correctly gives the illusion of providing structural support for the new mezzanine.

Architecturally, the new mezzanines were required to align with existing floors in each wing of the building. As such, there was insufficient depth to structurally support the new mezzanine by conventional methods. A shallow-depth, composite structural steel and concrete intermediate floor system was designed and suspended with steel hangers from the floor above. The suspended composite floors provided a very shallow depth structural system.

Norstar's boardroom was to be located in one of the existing wings of the building, but an adequate column-free space had to be provided. A system of complex transfer structural steel girders was developed for the attic space. This system provided support for the roof and permitted hanging the floor above the boardroom so that existing columns could be removed.

Ceiling Spectacular

Restoration of the ceiling was a major architectural feature of the design. This spectacular plaster ceiling was constructed with ornate, deep coffers suspended from an extensive gridwork of steel components. Since the attic space was to house the extensive mechanical equipment, it was important not to interfere with or increase load into the ceiling support hangers or overload the trusses. An intricate structural steel mechanical support system was designed within the confines of the attic.

907573

Structural steel platforms were integrated into the roof truss system.

The structural design for the Union Station renovation was an engineering challenge met with innovation, practicality and economic consideration. Steel was selected as the major structural material because its strength enabled shallow beams and slender columns to fit within the confines of the historic structure. Steel was lightweight, flexible and easily installed. In recognition of this project's innovations, Ryan-Biggs Associates received a 1987 Grand Award for Engineering Excellence in the American Consulting Engineers Council annual competition. □

Structural Engineer

Ryan-Biggs Associates, P.C.
Troy, New York

Architect

Einhorn Yaffee Prescott
Albany, New York

General Contractor

MLB Industries, Inc.
Latham, New York

Steel Fabricator

Schenectady Steel Co., Inc.
Schenectady, New York



Handsome boardroom required large column-free area where there was none. Complex transfer girders in attic permitted floor above boardroom to be hung, columns removed.

Owner

Norstar Bancorp
Albany, New York

J. Thomas Ryan, P.E., is president, and Chester J. Zaremba, P.E., an associate, Ryan-Biggs Associates, P.C., Troy, New York.

**WE
PUT
100
YEARS
OF
EXPERIENCE
IN
EVERY
BOLT WE MAKE**



**ST. LOUIS SCREW
& BOLT COMPANY**

At St. Louis Screw & Bolt, we make a FULL range of structural fasteners. We produce Types I & III A-325 bolts, ASTM A-307 bolts, and have the capability to manufacture fasteners to YOUR specifications. Our products are made from American steel and tested in our plant to meet ASTM standards, with certification upon request.

**FOR ALL YOUR STRUCTURAL
FASTENER NEEDS, SPECIFY
ST. LOUIS.**

ST. LOUIS SCREW & BOLT COMPANY

6901 N. Broadway/St. Louis, MO 63147/(314) 389-7500



SINCE 1887



FAX, (314) 389-7510
Toll Free, 1-800-237-7059



VULCRAFT EXPERIENCE SIMPLIFY



As the only national company in the United States that designs and manufactures joists, joist girders and steel deck, Vulcraft works with the relationships between joists and deck every day. So, they have a depth of experience that can often simplify many seemingly complex problems.

The Woodfield at the Crossing office complex in Indianapolis, Indiana is a good example. The open web configuration of the steel joists was ideal for the use of suspended,

5-foot spacing between Vulcraft joists permits easy installation and maintenance of heat pump units.

energy efficient heat pumps. But, the 3' spacing between joists which is needed to support standard floor deck was not adequate for the installation and maintenance of the heat pumps. So, 5' spacings were initially specified wherever the heat pump units would be installed. However, varying the

joist spacings would make construction complicated, time consuming and expensive. This is where Vulcraft was able to help.

SIMPLIFIED A COMPLEX PROBLEM.



The Woodfield at The Crossing office complex in Indianapolis used 216 tons of Vulcraft joists and 169,000 sq. ft. of Vulcraft steel deck.

After reviewing the specifications and discussing the job with those involved, Vulcraft engineers came up with an idea that reduced the number of joists needed, sped up erection time, and stayed within budget. Drawing on their extensive application experience, Vulcraft recommended changing the joist size from the original "H" series to the "LH" series in order to provide a uniform 5' spacing throughout the job. In addition, Vulcraft proposed using 2" composite deck instead of standard $\frac{9}{16}$ " form deck. Thus, a deeper slab was created without using any more concrete and transitory vibration was reduced.

By taking advantage of Vulcraft's experience as well as their products, construction of the Woodfield office complex was greatly simplified. In addition, Vulcraft's recommendations added greater value and flexibility to the overall design.

For more information about Vulcraft steel joists, joist girders and steel deck, or for copies of our joist and steel deck catalogs, contact the nearest Vulcraft plant listed below. Or see Sweet's 05100/VUL and 05300/VUL.

P.O. Box 637, Brigham City, UT 84302 801/734-9433
P.O. Box F-2, Florence, SC 29502 803/662-0381
P.O. Box 169, Fort Payne, AL 35967 205/843-2460
P.O. Box 186, Grapeland, TX 75844 409/687-4669
P.O. Box 59, Norfolk, NE 68701 402/644-8500
P.O. Box 1000, St. Joe, IN 46785 219/337-5411

VULCRAFT

A Division of Nucor Corporation

Owner: Phillip R. Duke & Associates; Contractor: Duke Construction Management Inc.;
Architect: Cooper Carry & Associates, Inc.; Consulting Engineer: K. Gene Miller Inc.;
Steel Fabricator: Ferguson Steel Co.

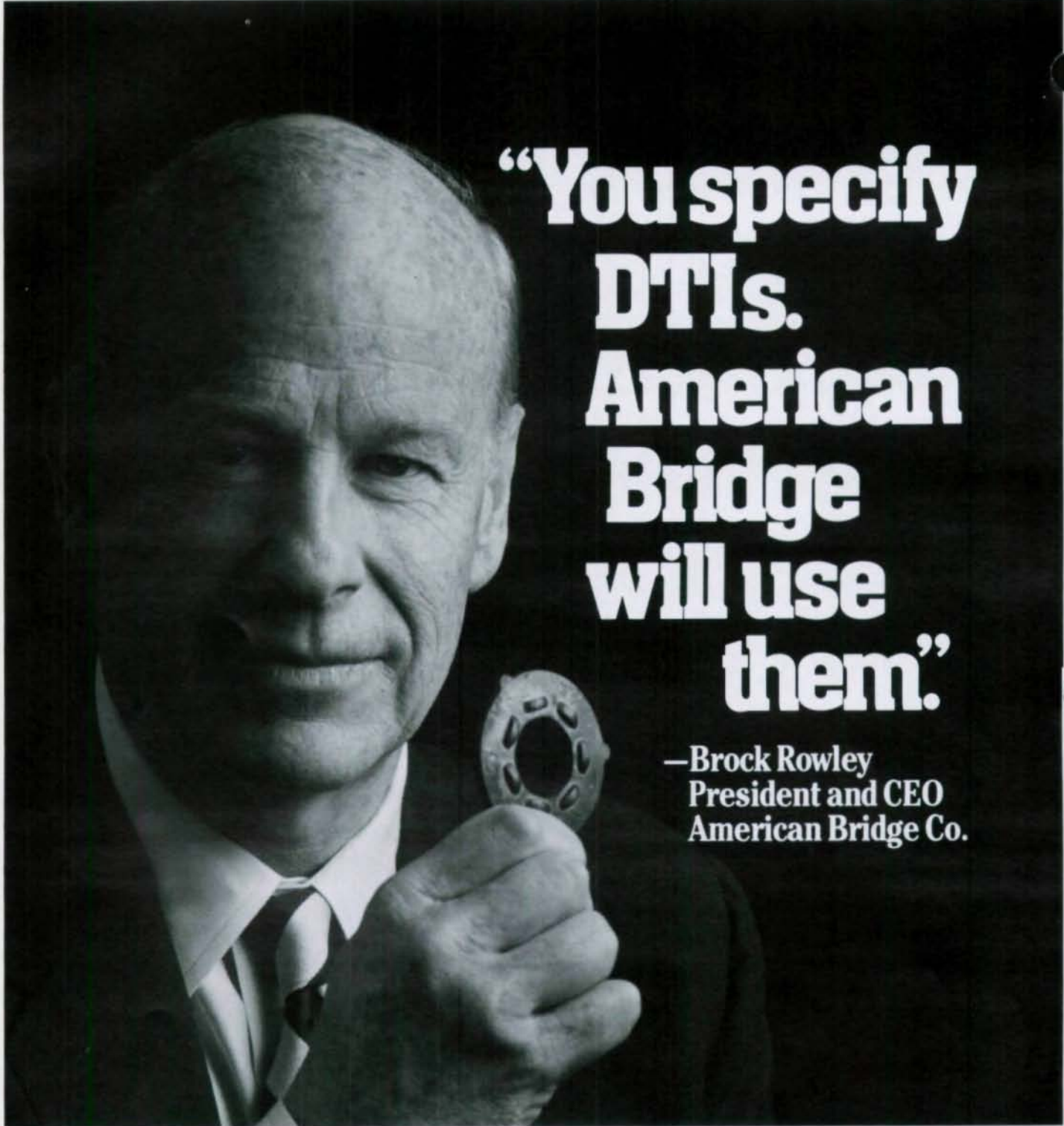

**“You specify
DTIs.
American
Bridge
will use
them.”**

**—Brock Rowley
President and CEO
American Bridge Co.**

Direct Tension Indicators

Brock Rowley knows a wise investment when he sees it. That's why he bought American Bridge Co., the century old structural steel giant that built some of the world's tallest buildings and most impressive bridge structures.

And that's why Brock supports the use of Direct Tension Indicators on structural steel projects where high clamping forces are critical, such as: high rise buildings and bridges. Because DTIs assure proper bolt tension every time, there's no guesswork. Expensive, inaccurate and potentially hazardous torque wrench

inspection is eliminated. DTIs are also a wise investment because they save on inspection costs.

Direct Tension Indicators from J&M Turner, Inc. An excellent investment in quality assurance.

Specify American-made Direct Tension Indicators on your next structural steel project, ASTM F959-85. For a side-by-side inspection cost comparison, or a copy of our free video, "The Dependable Connection," write to Jonathan Turner, J&M Turner, Inc., 770 Industrial Blvd., Southampton, PA 18966 or call 1-800-525-7193 (in PA: 215-953-1118).



J & M Turner Inc.

The bolting quality assurance people.

WELDING: DESIGN, FABRICATION AND INSPECTION REVIEWED

Important considerations in welding from both a design and fabrication point of view are discussed in a session on Welding at the 1988 National Steel Construction Conference, conducted both Thursday, June 9 from 10:30 a.m. - noon and Friday from 10:00 - 11:30 a.m.

Duane K. Miller, welding engineer with The Lincoln Electric Company's Welding Technology Center, Cleveland, focuses on the chemical and mechanical properties of deposited weld metal. Warren G. Alexander, a New York-based consultant in metals engineering, discusses the design of longitudinal welds for bridge members. Alexander was formerly director of the bridge construction section of the New York State Dept. of Transportation's structures division.

Miller describes the standard tests used to indicate degrees of yield and tensile strength, toughness, hardness, resistance to corrosion and contamination, as well as the ability to handle detrimental base material elements. However, Miller points out that engineers should not expect test results to be applicable directly to the properties of welded connections, inasmuch as production joints typically have much more admixture.

"The base metal will have a greater influence in actual production welds than the test plate," Miller says, "An understanding of the variables is essential to predict how

various filler metals will behave in actual joints. Chemical effects, penetration, bead size and shape and thermal cycles explain much of what happens as the change is made from test plates to actual configurations."

Miller concludes it is possible to increase quality and reliability through better awareness of how each variable affects the deposit properties and that complete understanding will permit use of cost effective fabrication techniques as well as limit the tendency to specify unjustified requirements.

Alexander notes by far the greatest amount of welding in all structures consists of longitudinal welds used to join components of axially loaded members so they act in unison. "In the absence of specific design instructions, many designers opt to use complete joint penetration groove welds 'just to be safe,' when other weld types or combinations would be a better choice," he says. He examines the factors that actually affect fatigue cracking and brittle fracture and reviews the weld type choices with respect to their effect on performance and cost. He also considers the effects of weld type and size on lamellar tearing and weld discontinuities.

Suggestions are given for selection of fillet and groove welds for I-shape and box-shape members, as well as advice about the design of longitudinal welds. "Success

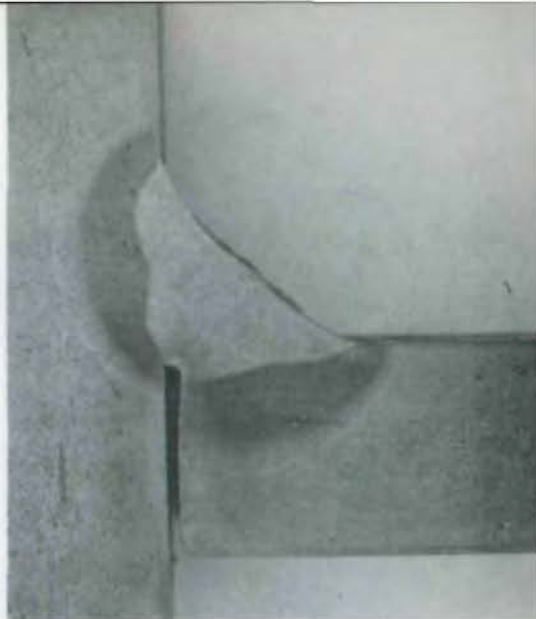

or failure of any weld or welded detail depends entirely on the presence or absence of significant discontinuities normal to the applied tensile stress," Alexander says, "and once all factors affecting performance are understood, it should no longer be necessary to overdesign, overweld or overspecify to insure safety." □

TUBULAR MEMBERS REQUIRE NEW APPROACHES TO CONNECTION DETAILS, FABRICATION

Increased use of tubular sections in structures has presented the fabricator and detailer with new fabrication and connection problems. Economical connection details and fabrication techniques which are—sometimes uniquely—applicable to tubular sections are outlined in a presentation Friday afternoon, June 10, 1:15 - 2:45 p.m. at the National Steel Construction Conference, Miami Beach.

Dr. Donald R. Sherman, professor of Civil Engineering at the University of Wisconsin-Milwaukee, has written a number of publications and reports concerning the design of tubular steel members. His pre-

sentation at the conference focuses on connections, discussing two general categories: direct tube-to-tube connections and those involving connecting elements which may be welded or connected by a combination of welding and bolting. He illustrates how connection strengths vary with parameters and provides some suggestions on obtaining the full strength of the members.

Larry A. Kloiber, president of L. L. LeJeune Company, presents a case study of a project recently fabricated by LeJeune which involved extensive use of tubular members. □

Structural Engineering Software For Your IBM Personal Computer or Compatible...



Structural Analysis/Design

Frame/Truss/Continuous Beam Analysis (Includes Shearwall Frame Interaction)	\$435.00
Load Analysis Program	\$275.00
Moving Load Analysis	\$450.00
Concrete Beam Design	\$175.00
PCSAP (3-D Frame /Truss)	\$200.00
Retaining Wall	\$275.00
Concrete Spread Footing	\$250.00
Pile Group	\$150.00
Shear Wall	\$275.00

ENGINEERING SOFTWARE SERVICES, INC.

978 Douglas Avenue, Suite 104
Altamonte Springs, Florida 32714
Call Our Hotline 1-800-257-8087
Florida Residents 305-862-7755

BOLTING PROBLEMS? LOHR has the solution!

VISIT OUR BOOTH #105
AT THE 1988 NEC/COP
CONFERENCE IN MIAMI
JUNE 8-11

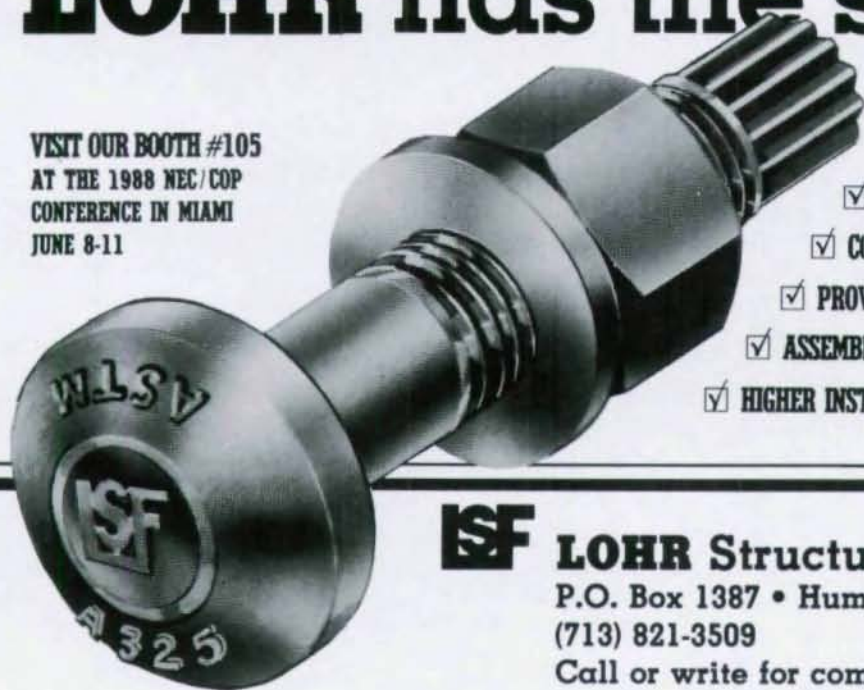

- ✓ FIRST WITH THE LARGE HEAD DESIGN
- ✓ EXCEEDS ASTM / AISC REQUIREMENTS
- ✓ COMPLETE MATCHING MILL CERTIFICATIONS
- ✓ PROVIDES "TOTAL SERVICE" START TO FINISH
- ✓ ASSEMBLED WITH NON-WATER SOLUBLE LUBRICANT
- ✓ HIGHER INSTALLED TENSION DRAWS HEAVY CONNECTIONS

LSF LOHR Structural Fasteners, Inc.
P.O. Box 1387 • Humble, Texas 77347
(713) 821-3509
Call or write for complete information.

COMPOSITE CONNECTIONS TO BE HIGHLIGHTED

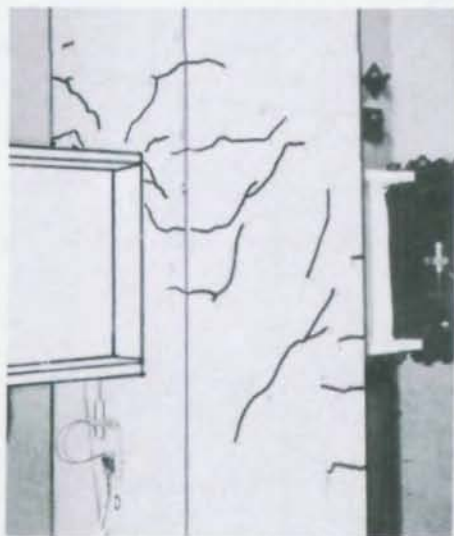

Cracking at service loads

With the advent of composite frame construction in high-rise buildings, engineers seek rational methods to take advantage of the stiffening and strengthening effects of reinforcing bars and concrete on the capacity of embedded steel shapes. But practical applications for the use of composite columns can be found in both low- and high-rise structures.

In presentations at the National Steel Construction Conference Thursday afternoon, June 9, two aspects of the design considerations are examined. Gregory Deierlein, of the Dept. of Civil Engineering, University of Texas-Austin, considers the results of research conducted at the University and sponsored by the National Science Foundation, AISC and CBM Consulting Engineers in Houston. The research

was directed specifically at the design of connections between steel beams and concrete (composite) columns.

Lawrence G. Griffis, senior vice president and head of the structural division for Walter P. Moore and Associates, Inc., considers the practical applications for use of composite columns. And he directs attention to the composite beam-column design tables developed by AISC as an aid to the practicing structural engineer in understanding uses and potential advantages of encased W-shape composite columns—as well as simplifying application of design procedures of the AISC Specifications (both Load and Resistance Factor Design and Allowable Stress Design) in routine use. □

ECONOMICAL DESIGN INFLUENCES DECISION TO FRAME IN STEEL

Practical solutions to stability and bracing problems are among session topics at the 1988 National Steel Construction Conference in Miami June 8-11. And those solutions can have a decided impact on the decision to frame in steel when they also reduce steel fabrication and erection costs.

David T. Ricker, vice president of Engineering, The Berlin Steel Construction Co., Berlin, Conn., concentrates on the designer's role in creating a safe, economical structure for his client, alerting designers to recent trends in design presentation resulting in huge increases in steel estimating costs. "If the designer is aware of cost-saving methods of steel construction, his client benefits in the long run. Sometimes this may be the deciding factor in the selection of steel over competing materials," Ricker says.

He points out that, quite often, a seemingly innocuous decision during the design stage can increase steel quotations by thousands of dollars. "The cost of fabricated steel depends to a great extent on what the fabricator is required to do to the raw steel shapes, and how he does it, Ricker says. "Erectability is another significant factor in determining total cost of construction."

In a companion presentation during the same session, scheduled for both Thursday and Friday, R. Shankar Nair, principal with Nair/KKBNA consulting engineers in Chicago, addresses stability analysis and design for stability, which he notes remain among the most intractable problems in structural design office practice. However, he also points out simple solutions sufficiently accurate for use in design are available for many of the stability problems faced, including lateral stability of buildings and towers, connection of columns to floor diaphragms, treatment of floors bypassed by the overall lateral load-resisting system, truss bracing and many other situations. In a separate session to be conducted both Thursday and Friday afternoon from 3:30 - 5:00 p.m., the subject is also addressed as it relates specifically to high-rise residential construction.

Robert K. Huzzard, a structural consultant for Bethlehem Steel Corporation, says, "Structural steel framing is competitive for most high-rise residential buildings if it is considered by the design team in the early evaluation of the building param-

eters. Of particular interest are least cost, speed of construction, minimum floor-to-floor height, fire protection requirements, provisions for balconies and lower-level parking."

Huzzard points out minor changes can be made to the architectural layout that substantially improve the efficiency of the frame. Selection of the appropriate floor system is essential to creating an economical structure and innovative ap-

proaches are available to solve balcony and parking problems.

Myron Wander, director of industry development for The Steel Institute of New York, continues the discussion of the various framing and floor systems which can be employed. He uses case studies to examine marketing approaches for converting projects to steel as well as services available to both the developer and consultant after the decision to "go steel" is made.

Plattzinc® 85/15 Zinc/Aluminum Metallizing Wire



For Corrosion Protection In Marine & Industrial Environments.

Metallizing structural steel with Plattzinc® 85/15 ensures years of protection in harsh atmospheres. Available for flame spraying equipment in 1/8" or 3/16" diameters in coil or fiber payoffpaks.

- An inorganic coating
- Bonds instantly
- Minimizes out of service losses
- No VOC / No Solvents
- Longer maintenance intervals
- Passive & galvanic protection

For More Information:

Platt Bros. & Co.
P.O. Box 1030
Waterbury, CT 06721
203-753-4194
Telex #64-3340
Fax #203-753-9709



Window Wall/Curtain Wall Mockup Testing



Wilshire/Westwood, Los Angeles
Granite and Aluminum/Glass Window Wall Mockup ready
for Dynamic Water Infiltration Test.

- Testing Facility is 45-foot high by 70-foot long; 300 psf loading capacity.
- Per ASTM and AAMA Specifications.
- Computer aided data acquisition with instant deflection readings +/- .001 inch.
- Dynamic Tests using 2000 HP Aircraft Engine w/13.5 foot propeller.

SMITH-EMERY COMPANY

The Full Service Independent Testing Laboratory, Established 1904
781 East Washington Blvd., Los Angeles, California 90021
213/749-3411 • Fax 213/746-7228



CASE STUDIES IN LRFD SEISMIC DESIGN

Two design engineers discuss how Load and Resistance Factor Design (LRFD) was used in the seismic design of a 38-story building in Los Angeles and an office building in Mexico City featuring composite columns—Thursday afternoon at the 1988 National Steel Construction Conference, June 9, from 3:30-5:00 p.m.

Nabih Youssef, director of structural engineering for the Los Angeles firm of Albert C. Martin and Associates compares LRFD and Allowable Stress Design in the Los Angeles structure. The building floor system is composed of steel beams and girders with composite-steel deck and concrete fill. Beams and girders are designed composite, and axial compression members and diagonal bracing.

The lateral framing system for wind (wind tunnel study) and earthquake (response spectra) loads is a modified framed tube, with a series of ductile eccentric braced frames in the core. The core eccentric braced frames are coupled with the exterior columns for overturning and drift through a series of outrigger Vierendeels.

In the upper eight stories of the building, the exterior tube is modified to a series of two-story (long-span) Vierendeels for gravity and lateral loads, responding to a series of design setbacks of the longitudinal face. The steel frame is designed through optimization techniques to a maximum efficiency.

Enrique Martinez-Romero, a consulting structural engineer in Mexico City and a professor of engineering at the University of Mexico, discusses a steel office building located in the lake zone of Mexico City, just beginning construction, in which Mexico's 1985 Emergency Regulations were made mandatory. The building was originally designed according to the 1976 Building Code, but with more stringent design requirements imposed by new regulations, the building had to be upgraded accordingly.

Martinez-Romero relates the alternative selected to accomplish this—encasement of the already fabricated steel columns in concrete to form composite columns. □



NEW IMPROVED

Power-PLANE

Now you can analyze this structure
in 14 seconds for **ONLY \$99.**

Power-PLANE can handle up to 400 joint
and 600 member loads.

NEW FEATURES:

- input repetition for joint member load generation
- intermediate member forces
- moments and shears at tenth points
- file output for force results
- six individual load cases and 12 load combinations

ALSO AVAILABLE:

Power-PLANECON designs all concrete
members in 21 seconds for **ONLY \$250.**

Power-PLANESTL designs all steel mem-
bers in 49 seconds for **ONLY \$250.**

Power-WOODFRAM designs all timber
members for **ONLY \$250.**

**And now you can analyze and design all
members in this structure in the same run!**

Easy to use programs run on IBM PC, XT, AT, PS/2,
models 30,50,60,80, and most true compatibles.

CALL TOLL FREE 1-800-635-6366 tone then dial 814

Mail orders receive bonus coupon worth \$50 off your next purchase. Send
check + \$5. s/h U.S. (foreign orders \$25.s/h) FL res. add 5% sales tax

See what our bright ideas in software can do for you...

Circle: Power-PLANE	Power-PLANECON	Power-PLANESTL	Power-WOODFRAM
\$99.	\$250.	\$250.	\$250.

NAME _____

ADDRESS _____

COMPUTER _____ ACCOUNT # _____

CHECK ENCLOSED FOR MASTERCARD VISA EXP. DATE _____

21 YEARS IN ENGINEERING SOFTWARE

SAI Structural Analysis, Inc., 301 W. Camino Gardens Blvd., # 110, Boca Raton, FL 33432

113 joints
189 members

34

MODERN STEEL CONSTRUCTION

00756

Dramatic Renovation

COBO CONFERENCE/ EXHIBITION CENTER

New Impetus to an Emerging City

by Art Nelson



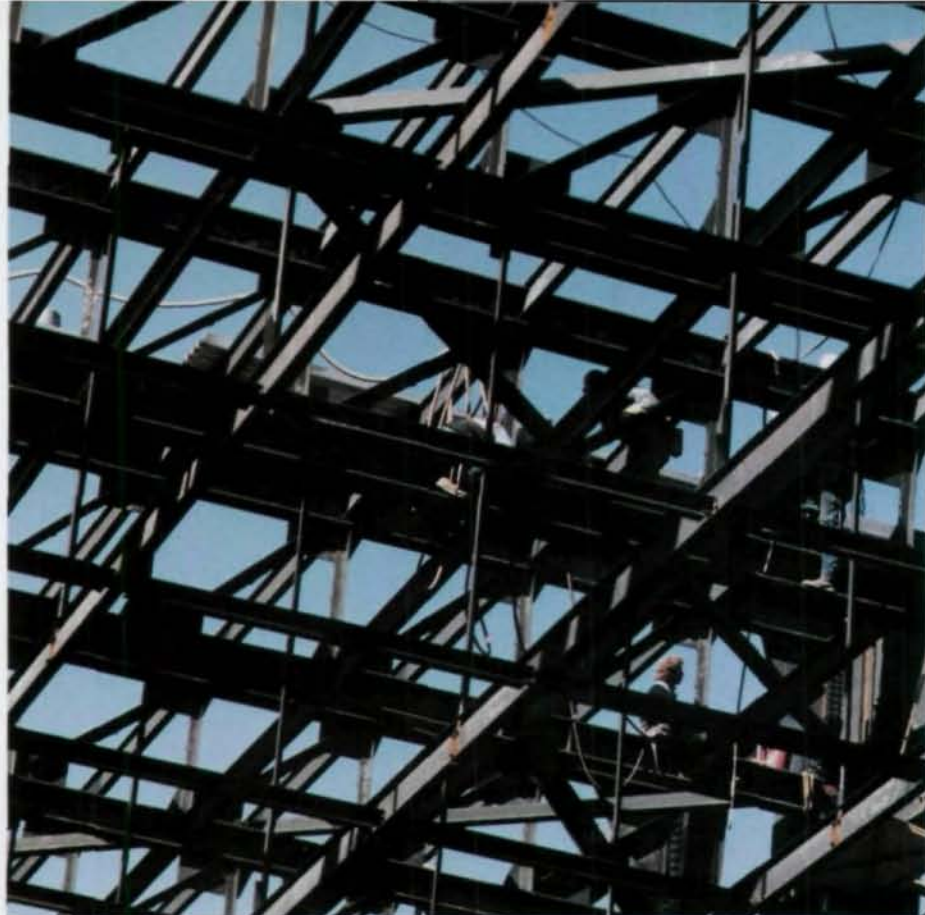

Since its opening in 1960, Cobo Conference/Exhibition Center has been Detroit's premier convention and trade show facility. The Center is currently undergoing a dramatic renovation and expansion in order to maintain its status as one of the nation's leading convention/exhibition centers. When completed, the project will cover a large part of Detroit's 75-acre Civic Center.

The present renovation and expansion will more than double the existing space—from 1.1 million to 2.5 million sq. ft. The new \$200-million Center includes 650,000 sq. ft of one-level continuous exhibition halls, 95 meeting rooms, a 27,000-sq. ft grand ballroom, a 12,000-seat arena, a people mover station, rooftop and underground parking and spectacular glass-covered atriums on the east side of the building facing the downtown Renaissance Center.

The large size of the new Center presented the architect and engineer with a number of technical and creative challenges, many of which were met by using structural steel—over 16,200 tons of it. The expansion of Cobo Hall is a combination of three major areas, each with their own unique design criteria: the east side, which includes meeting rooms, atriums and concourse; the north side, which houses a new exhibit hall; and the west side, the enlargement of the existing three halls and addition of new truck receiving docks for each exhibit hall.

East Side Expansion

The east side expansion embraces two distinct framing schemes, one for the multi-story meeting room areas and another for the four atrium areas. The 181,000 sq. ft of meeting rooms are located on the second and third levels above the Washington Blvd. street level concourse. This area is framed with composite steel beams supported by rigid frame bents tied laterally to the existing building. Part of the foundation system for these bents is above an existing underground parking structure. Four feet of earth cover was removed to reduce the load to the existing columns. Concrete grillage beams were then used to transfer the new column loads to the existing garage columns.

The atrium areas are located over the two main expressways which travel under the convention center and at each end of the concourse area. The main atriums are constructed with 4-vertical, and 2-horizontal Vierendeel trusses spanning 102 ft. The Vierendeels are made up of 10-ft x 10-ft panels formed with wide-flange shapes, boxed to look like tube sections.

The facade of the east addition consists

MBP for the IBM XT/AT and VAX

Except for the ability to *design* frames with tapered unequal-flange built-up members, powerful preprocessors, ease of use, versatility and excellent price... It's just another structural analysis program.

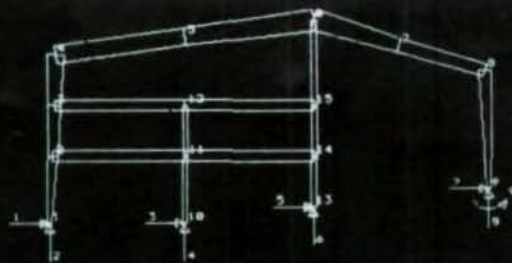

- Any 2-D geometry, regular or irregular
- Built-up, wide flange and pipe members
- Joint, member and temperature loads, support settlements
- Plots of shapes and internal stresses
- Analysis/optimization modes
- AISC design
- Preprocessors for common metal building frames.

Write or call for a free PC demo diskette

International Structural Engineers, Inc.

P.O. Box 241740, Los Angeles, CA 90024

Tel. (213) 398-3106 • Twx. 910-340-6449



East side expansion, existing Cobo Hall, rooftop parking



Rendering of interior atrium and concourse

of stepped 10-ft x 10-ft glass and granite cubes cantilevered from the main structural frame and converging into the atriums. The individual blocks of the atriums are truly an architectural statement, made possible by the structural support of the steel Vierendeel trusses. These atriums help to form the concourse at the front of the building. The concourse, 100 ft wide, extends the entire 1,000-ft length of the building. Atriums and concourse account for 155,000 sq. ft of the total floor area and provide a main entrance to the exhibit halls, as well as access to the upper level meeting rooms.

Spanning the atriums and connecting the meeting room blocks at the third level, are 102-ft long walkways constructed with composite plate girders, designed for 0.7 in. live-load deflection. The walkways also support escalators which connect the three levels.

The northeast corner atrium is supported by four large, two-story brackets and W14 x 311 columns symmetrical about a diagonal axis. The live-load deflection of the glass-lined, 30-ft deep, Vierendeel hung frame is 0.5 in. A three-dimensional finite element analysis, with over 1,100 members in the computer program, was

Nelson[®] stud welding for building construction

Whether you're designing a new building or retrofitting an old one, Nelson end-welded studs are the key to bonding steel and concrete for maximum strength and minimum weight. We design, manufacture and service any building anchoring requirement.

**Electrical - Mechanical - Embedments
Closures - Insulation - Composite - Facia**



Call us at 216.245.6931 and ask for our design literature, samples, or application engineering assistance. Or write to Nelson Stud Welding Division, TRW Assemblies & Fasteners Group, E. 28th St., Lorain, Ohio 44055

International:
England - France - West Germany - Australia

TRW

Nelson Stud Welding Division
TRW Assemblies &
Fasteners Group

© TRW Inc. 1988
TRW is the name and
mark of TRW Inc.

MICROSAFE \$160⁰⁰

Full-featured 2-D and 3-D
Finite Element Analysis
Program for IBM PC, XT,
AT, PS/2 and compatibles.

- *Static, linear*
- *Up to 400 nodes*
- *Up to 600 beams*
- *Up to 500 plates*
- *Multiple load conditions*
- *Interactive graphics (CGA, EGA, AT&T, Hercules...)*

Not copy-protected, full
refund within 30 days if
not completely satisfied.

Distributed by ISE, Inc.
P.O. Box 3074
Culver City, CA 90231
(213) 398-3106

IT IS FUN TO
**DESIGN STEEL
CONNECTIONS**

USING

DESCON

AN EASY TO USE SOFTWARE PACKAGE
FOR YOUR PC

25 TYPES OF BEAM TO COLUMN
CONNECTIONS, BEAM SPLICES AND
BEAM TO GIRDER CONNECTIONS

MOMENT CONNECTIONS
SHEAR CONNECTIONS
BOLTED AND WELDED

EXTENSIVE DATA BASE OF SHAPES,
MATERIAL PROPERTIES AND
SPECIFICATION REQUIREMENTS
INCLUDED

FOR INFORMATION CALL OR WRITE TO:

OMNITECH ASSOCIATES
P.O. BOX 7581
BERKELEY, CA 94707
(415) 528-8328

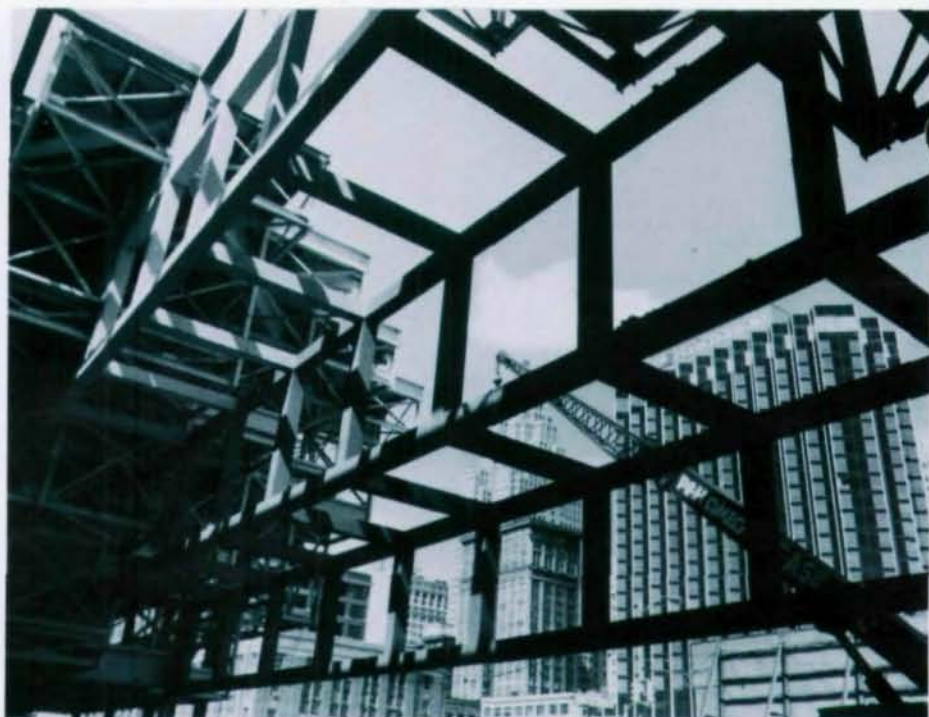

Horizontal and vertical Vierendeel trusses, east side atrium



Framing over people-mover guideway, north expansion

employed to produce the design stresses and deflections.

North Side Expansion

The greatest amount of steel is being used in the north addition. This addition encompasses the Detroit People Mover guideway, spans across Larned Street and houses 207,000 sq. ft of additional exhibit space. The three-block long by one-block wide addition has typical bays of 90 ft by 120 ft with some spans as large as 180 ft to accommodate the People Mover

guideway. The People Mover, Detroit's new computerized light track train, opened August 1, 1987, two years earlier than the scheduled completion of the Center. This presented a challenge to the architect and engineer, since the train runs directly through the structure.

The north addition was literally built from the top down, a method quite different than the normal mode of operation. The roof frame was erected first, before the exhibit floor concrete slab was placed. This was done to provide access to the existing roof



East side expansion, atrium area, with Vierendeel trusses, cantilevered facade



Ironworker on wide-flange truss, north expansion

top parking and to complete erection over the People Mover guideway. Shallow trusses spanning 90 ft were used to provide clearance for the People Mover operating envelope, as well as to maintain a level parking surface on the roof. The Cobo Hall People Mover station was suspended from roof trusses to eliminate additional columns in the exhibit hall. The deflection limitations for the station platform are a critical part of the design and operation of the automated train.

The Exhibition Hall roof trusses, which

are more like large bridge trusses with wide-flange members, were designed for building continuity as well as seismic and wind forces. These large trusses are of A572 steel, and the roof frame is supported on 30-in. x 30-in. steel box columns, made with 2-in. thick welded billet plates resting on 100-ft deep caissons to hardpan. To compensate for the unusual length of these trusses, Havens Steel Company fabricated and assembled the trusses in their Kansas City shop to ensure a perfect fit. The trusses were then unbolted for

shipment and reassembled at the Detroit project site.

Another interesting detail involves the removal of the existing load-bearing columns along the north face of the existing building. This was accomplished by supporting the upper portions of these columns on brackets from a jack truss erected with the new frame. The dead load from these columns was then transferred onto the new trusses prior to removing the lower part of the columns.

A major criteria for the new exhibit hall required that the floor line match the elevation of the existing building to create a large, single-level exhibit space which could be either divided or used as one hall. This was accomplished by lowering Larned Street, a major east-west artery into downtown Detroit, approximately 10 ft and reworking the Lodge Freeway-Jefferson Ave. interchange, including ramps, underground sewers, utilities and power lines.

The exhibit hall floor framing is basically a reinforced 30-ft by 30-ft flat slab, 11.5 in. thick, supported on concrete columns and caissons. The area over Larned Street is actually a bridge structure consisting of 36-in. wide-flange composite girders supporting an 8-in. thick reinforced concrete slab on metal deck. All areas of the exhibit floor are designed for HS-20-44 truck loading, plus a 160-kip concentrated load over any 8- by 10-ft area for heavy equipment displays.

West Side Expansion

The west side expansion employs some of the heaviest structural steel in the project. The exhibit hall's truck dock level spanning the Lodge Freeway contains large, 5-ft deep composite plate girders with spans up to 120 ft. In areas where exhibit hall roof columns are located over the roadway, three plate girders are spaced to carry the load.

The existing exhibit hall extension to the west required removal of several existing columns. This was accomplished by cantilevering the roof trusses 45 ft to carry the loads now supported on these columns. The anchor span for these trusses is 150 ft. A new, expanded truck dock facility located immediately west of the enlarged exhibit halls gives each hall its own truck access area. The existing truck dock and ramp area are being demolished to make room for the west expansion. The new truck ramp and bridge over the northbound Lodge Freeway access ramp accommodates traffic to the new dock area. Abutments for this bridge work are supported by a reinforced earth retaining system with galvanized steel straps anchored in the

STRUCTURAL CONSTRUCTION FASTENERS

From foundation to roof Haydon is your one source. Quality bolts to ASTM standards at competitive prices. Direct from the manufacturer.



You name the structural anchor, bolt, nut or rod you need in the size, metal and finish you want. Either we have it in our large inventory, or we can make it for you in a hurry. We've been known for quality and fast service since 1864. And, we'll quote prices and give details right over the phone. Try us. Call:

(215) 537-8700

HAYDON BOLTS, Inc.

Adams Ave. & Unity St.,
Philadelphia, PA 19124



Steel box column (30x30 in.), north expansion

earth backfill and connected to precast concrete wall units. The wide-flange bridge beams, designed for composite action, have curved spandrel sections to meet the roadway alignment.

Access to roof-top parking is via a new precast post-tensioned concrete helix and bridge to the west edge of the new structure. The bridge, nearly 80 ft above ground level, is supported by large concrete transfer girders spanning the Lodge Freeway access ramp.

The Convention Center is progressing in phases over a 2½-year period with final completion targeted for the Summer of 1989. From the beginning of the project, the goal has been to minimize disruption to local traffic and to users of the Center—and yet complete an accelerated design and construction within the 2½-year schedule. As the project enters the final phase, it is right on schedule. And well on its way to becoming another symbol of the reemerging vitality in Detroit. □

Architect

Sims Varner & Associates

Prime Consulting Engineer

BEI Associates, Inc.
(formerly Blount Engineers)

Engineering Sub-consultants

Sidney Shorter Associates
Madison-Madison International

Construction Manager

Turner Construction Company

Project Manager/Owner

City of Detroit—Community and Economic
Development Dept.

Steel Fabricators

Havens Steel Company

Corvo Iron Works

Vulcan Iron Works

Steel Erectors

SCI Steel-Con

Northeast Erectors

Art Nelson, P.E., is senior vice president of BEI Associates, Inc., Detroit, Michigan.

SINGLE AND DOUBLE ANGLES WORKSHOP

Latest research and design information on behavior of single angles with combined axial load and moments and on double-angle struts will be presented in a Thursday morning session at the 1988 National Steel Construction Conference. At 10:30 a.m. until noon, the session includes presentations by Dr. LeRoy A. Lutz, principal, Computerized Structural Design, Milwaukee, Wisc., and Dr. Murray C. Temple, associate dean of engineering, University of Windsor, Windsor, Ont., Can.

Dr. Lutz covers single angle struts as beam columns within the context of the proposed AISC Appendix F of the *Specification for the Design, Fabrication and Erection of Structural Steel for Buildings*. Lutz is a member of the AISC ad hoc committee on single-angle members. He summarizes the tensile and shear provisions of the specification and presents in greater detail the flexural and compression provisions for both equal and unequal leg angles. "The compression integrity of single angles may be affected by something other than flexural buckling," Lutz says. Provisions for local buckling are presented, as are requirements for evaluating torsional-flexural buckling. Information is also given to evaluate when local and torsional-flexural buckling controls.

The discussion also includes flexural integrity of single angles bent about either principal or geometric axes. Lateral-torsional provisions for both flexural orientations are given, as well as local buckling limits on flexural stress.

Lutz illustrates design of single-angle, beam-column members with several examples, showing how to apply the flexural and compression provisions for use in the combined stress interaction expressions.

During the same session, Temple discusses double-angle compression members, commonly used as web members in trusses and for bracing members. He notes that back-to-back, starred and boxed configurations are possible and explores advantages and disadvantages of each.

He also reviews the requirements for interconnection of double angles as contained in several North American and European standards, requirements which vary considerably, with the North American considered the most liberal and the British standard the most conservative. Temple reviews extensive testing of double angles conducted to determine interconnection requirements, forces in the interconnectors and effect of interconnector weld patterns.

You Want The BEST In An Automated Detailing System

PDS Provides Solutions To Current Industry Problems

- Fast track jobs
- Heavily architectural jobs
- Massive design revisions
- Connection design responsibility
- Necessary shop optimization

PDS Addresses The Diversity You Face

- Columns
- Beams
- Girts
- Bracing
- Connection design
- Standard caged ladders
- Pan and grating stairs
- Templates
- Water stops
- Transition chutes
- Material bill
- Sorted cut lists
- Short sheets
- Shipping tickets
- Weight calculations

PDS Is Easy To Learn And Effortless To Use

- Menu driven
- On-line help
- Newsletters
- Consistent "look and feel" systemwide
- Comprehensive support
- Complete, easy-to-read manual
- Toll free consultation
- Modem support

PDS Is Provided By A Single Vendor

- Complete hardware systems
- Complete installation
- Hardware support
- Software support
- Comprehensive training
- Detailing software
- Engineering software
- Shop management software
- Business management software
- Industry standard software

PDS Applies The Latest Technology

- Compatible with Intel 80x86 and Motorola 680x0 processors
- Operating up to 25 Mhz
- Math co-processor
- Distributed intelligence architectures
- True multi-user
- High resolution color graphics display (1024x780)
- Sophisticated 16 key graphics digitizer

PDS Utilizes Established Industry Standards

- IBM PC compatible, Multibus and VME bus based systems
- Unix operating system
- C Language
- Available on a variety of computers

PDS Is The Product Of Expertise And Experience

- Detailing expertise
- Engineering expertise
- Computer expertise
- Business management

PDS Is Cost Justified

- Lower cost per user
- Lowest cost per feature/function in the industry
- Quickest return on investment
- A single system for engineering, detailing, shop and business management

PDS Integrates Smoothly Into Your Operation

- Affordable lease and purchase options
- Complete hardware integration and installation
- Comprehensive training
- Short learning curve
- Applies to individual members or entire structures
- Full of features - not projections
- Follows standard detailing/shop procedures
- Adjusts to particular needs and practices
- You run it; it doesn't run you

Get the BEST . . . get PDS.

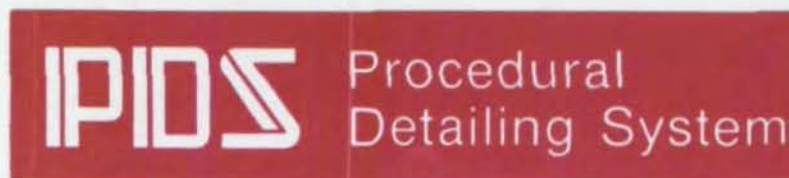

See PDS in Miami at the AISC National Conference, booth 101
Dogwood Technologies, Inc. 114 Anderson Ave. NW Knoxville, TN 37917
615-523-5634 800-346-0706

FOREIGN AND DOMESTIC MILL REPS TO DISCUSS USE OF JUMBO SHAPES

There are presently conflicting views on the use of jumbo shapes in tension, primarily as a consequence of the use of fully welded splices in heavy, wide-flange shapes. Because of the carbon-rich, low-fracture toughness core areas of these shapes, along with the high-tensile, residual stresses found in these regions, notch-sensitive cope holes and the high hardness of flame-cut surfaces, cracks have been known to occur in the base metal in the vicinity of the splices. However, it should also be noted that fully welded splices of heavy wide-flange shapes have been used for a number of construction projects without any apparent problems.

The subject comes into sharp focus at the 1988 National Steel Construction Conference, with a plenary session on jumbo shapes Friday morning, June 10, followed by workshop sessions from 10:00 to 11:30 a.m., and 3:30 to 5:00 p.m.

Reidar Bjorhovde is to present the position paper at the plenary session, establishing the parameters of the problems

encountered and discussing the various remedies which appear appropriate. He will review the chemical and mechanical properties of steel as they relate to the matter and explain considerations which should be taken into account by structural engineers and steel fabricators. The effects of typical fabrication operations will be included in those considerations.

In suggesting possible solutions, Bjorhovde demonstrates it should be possible to use fully welded splices, providing sufficient care is exercised in the preparation of the material specifications, particularly in the many fabrication operations involved.

"The use of fully killed steel with specified fracture toughness levels and Charpy V-Notch test locations may be required," Bjorhovde notes, and "careful attention must be paid to preheat and interpass temperature control, weld pass and joint sequencing and edge preparation." He also presents a suitable welded splice detail.

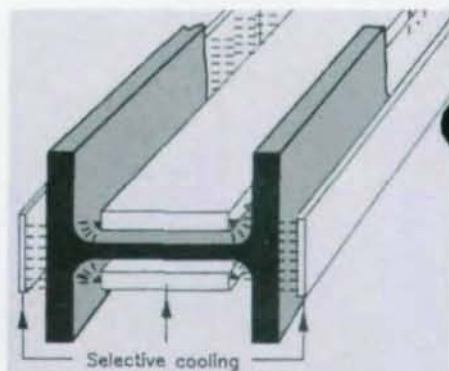

Speakers for the workshop session, drawn from the research departments of both domestic and foreign mills, include:

Dr. John M. Barsom, senior consultant of materials and structural performance, USS Division of USX, Pittsburgh, Pa.

Roger Schlim, research associate-product development department, ARBED Research Center, New York, N.Y.

Nobutaka Yurioka and Takeshi Fujimoto, senior researchers, Nippon Steel Corporation, Tokyo, Japan

Dean C. Krouse, senior metallurgical applications engineer, Bethlehem Steel Corporation, Bethlehem, Pa.

Barsom notes that use of "jumbo shapes" made of semi-killed A36 and A572 steels in column applications has a long history of satisfactory performance. In non-column applications, some brittle structural fractures have occurred. "Such fractures can be avoided only when material, design, fabrication, inspection and erection practices are properly defined and implemented for a particular structure," Barsom says. USS's recommendations for use of jumbo shapes as non-column members include:

1. Bolted splices and connections used whenever wide-flange shapes having flanges thicker than 1½ in. are used as non-column members
2. Bolted splices and connections used even when these shapes are produced to a killed-steel practice, and
3. Additional precautions are necessary when welded rather than bolted splices and connections are used.

Bethlehem initiated a study to evaluate the metallurgical characteristics of its jumbo shapes. Data from several sections ranging from W14 × 145 to W14 × 730 for both ASTM A36 and A572, Gr. 50 showed no significant differences in microstructure or toughness between the flange, core or web in any given section.

Typical Charpy V-Notch 15 ft-lb. transition temperatures for A572, Gr. 50 W14 × 730 sections range from 0 to

SHARON COMPANIES

architectural metals Ltd.

STEEL STAIR SYSTEMS

DESIGN ADVANTAGES

- * Competitively Priced
- * Designed per Project
- * Meets Required Codes
- * Assured Delivery Time
- * 5 Prefab Units per Floor
- * Quick Floor/Floor Access
- * Accelerated Installation
- * Significant Cost Savings

Drop-In Stair™ System

SHARON COMPANIES LTD.

- * Over 100,000 sq/ft Operating Facilities
- * 3 Fabricating Locations
Sharon Ornamental Iron, Inc. Medina, Ohio
RJC Industries, Inc. Barberton, Ohio
Sharon Stair Systems, Inc. Phoenix, Arizona
- * Erection Services
Sharon Erection Company, Inc. Medina, Ohio
- * Delivered and Erected Nationwide
- * List of Projects in Your Area Available upon Request
- * Call (216) 723-3225
Outside Ohio 1-800-792-0129

+30°F. This toughness level is similar to that of hot-rolled plates of similar composition and dimensions.

Bethlehem's data analysis showed compositional modifications within the current specification will provide only incremental improvements in toughness. In contrast, laboratory heat treatments demonstrated normalizing can provide a substantial toughness improvement, but at additional cost. The next step, the company suggests, should be for structural designers to define the strength and toughness parameters required for various applications.

Schlim also cites problems encountered in non-column applications, and references an extensive study conducted at Lehigh University which concluded that, due to low toughness—mainly in the core area of jumbo sections—bolted connections should be designed instead of welded joints when subjected to tension stresses.

ARBED's research program has directed its efforts to improving the technological and mechanical properties of ASTM A572 Gr. 50 steel for jumbo sections. A special steel grade called ASTM A572 Gr. 50 Fritenar has now been developed by ARBED for jumbo shapes in tension applications. The new grade combines standard properties of ASTM A572 Gr. 50 with improved toughness properties and high weldability, according to Schlim. He cites results of large scale tests which demonstrate that "groove-welded splices of jumbo shapes in ASTM A572 Gr. 50 Fritenar can perfectly be used in tension applications."

Nippon instituted a test program to find a better way to minimize cracking. The program employed aluminum-killed Nb-V steel shapes of 14-in. x 16-in. x 455-lb. and 605-lb. size, and toughness-improved steel of a 14-in. x 16-in. x 730-lb. size. Two kinds of weld joints were tested: a column-to-column joint by horizontal manual welding and an inserted stiffener joint by vertical electroslag welding.

Brittle cracks were initiated from the web-flange intersections in both types of joints only when welding Nb-V steel of a 605-lb. size at lower ambient temperatures of -5°C (23°F). No cracking occurred in the other conditions of higher ambient temperature (40°F), lighter shape (455-lb.) and toughness-improved shape.

Yurioka and Fujimoto's presentation focuses on methods to prevent brittle cracking during welding of heavy shapes from the viewpoint of preventing cold cracking, which research suggests may be a trigger of brittle cracking and reducing the rate of change in welding residual stresses. □

It's Here!

NEW

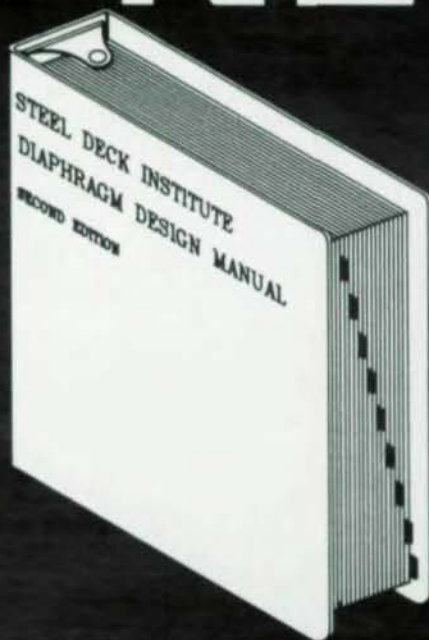

DIAPHRAGM DESIGN MANUAL

SECOND EDITION



A reference source that contains the answers to all of your questions! For practicing Engineers & Architects!

Organized For Easy Use/Explicitly Illustrated

MAJOR ADDITIONS

- Diaphragm Strength
- Diaphragm Stiffness
- Connections
- Concrete Filled Diaphragms
- 62 Pages Filled with Shear Diaphragm Examples
- Complete Guide to Symbols and References
- Complete set of Load Tables for Typical Panel Configurations and Connector Types
- Typical Fastener Layout
- Warping Factor Development
- D-Values for Warping

DON'T DELAY—ORDER YOURS TODAY!

Send checks; postal, world money orders, drafts, in U.S. currency.

QUANTITY

_____ NEW 2ND EDITION DIAPHRAGM DESIGN MANUAL, \$38.00 ea. _____
_____ 1st Edition Diaphragm Design Manual, \$28.75 ea. _____
_____ Steel Deck Design Manual, \$9.50 ea. _____

US Currency Total _____

Out of USA surcharge, 10% _____

Add on for Airmail _____

Total Enclosed _____

STEEL DECK INSTITUTE, INC.
P.O. BOX 9506, CANTON, OHIO 44711 ■ (216) 493-7886

"See us at 1988 NEC//COP Booth No. 420"

STRUCTURAL DESIGN USING LOTUS 1-2-3® + ENERCALC™



Use LOTUS 1-2-3® as your personal structural designer. Your \$795, 26 program "library" supplies design & analysis in steel, timber, retaining walls, concrete, masonry and can perform structural analysis.

Forward thinking engineers will realize this software is REQUIRED MATERIAL in today's competitive design office, and our nationwide user's are available as impartial references. Receive our brochure or demonstration packages by contacting:

ENERCALC™

3432 Via Oporto 207
Newport Beach, CA 92663 • 714-723-0295

NEW METHODS TO CONSTRUCT SHORT-SPAN PRESTRESSED STEEL BRIDGES

The concept of prestressed steel flexural members was studied extensively in the 1960s. However, the actual use of such members for bridge construction is a new development in the U.S. The principal advantage of prestressing is a reduction in material quantities required.

Thomas M. Murray, Montague-Betts Professor of Structural Design in the Department of Civil Engineering at Virginia Polytechnic Institute, reviews recent projects using this relatively new concept in a presentation at the National Steel Construction Conference Thursday morning, June 9, 10:30 a.m. He discusses the recently completed Bonners Ferry Bridge in Idaho and the Muddy Boggy River Bridge in Oklahoma, two examples of cable-stressed, plate-girder bridges. He will also examine the "Inverset" system of fabricating small river crossing bridges which is gaining wide use in Oklahoma and several southern states.

HILMAN ROLLERS SYSTEMS

From 1 to 1000 Tons or More

Hilman Systems operate in horizontal, vertical plane, inverted or trunion mount, semi-precise bearings, as a slide, submerged in water, indoors, outdoors, dirty environment or corrosive atmosphere. If you have a heavy application, let our systems analysts help you solve it efficiently and at low cost.

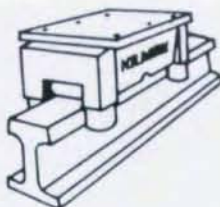

**HILMAN
ROLLERS**
SYSTEMS DIVISION

2604 Atlantic Avenue
Wall, N.J. 07719 USA
(201) 449-9296
Telex: 283782
Fax: (201) 223-8072

800-631-2177

See us in booth 218 at the National Steel Conference in Miami

STEEL DECKS: BASIC DIAPHRAGM DESIGN

The 1987 Steel Deck Institute's *Diaphragm Design Manual* is the subject for a presentation on Thursday from 10:30 a.m. - Noon (repeated 3:30 - 5:00 p.m.).

Philip Levine, vice president/Operations, Roll Form Products, division of RFP, Inc. (Boston, Mass.) presents both the Steel Deck Institute's specifications for steel deck fabrication and a discussion of available shapes, material selection, shop finish, coil coating, cold forming and storage.

Larry D. Luttrell, professor of Civil Engineering, West Virginia University (Morgantown, W. Va.), has been involved in diaphragm test programs for various institutes and sponsoring agencies for the past 25 years. His focus in the Manual has been to identify the more important parameters, assess their individual contributions and combine such influences to allow rather simple assessments of both strength and stiffness of typical diaphragms. □

MODERN STEEL CONSTRUCTION



Don Hill, P.E.
West Coast
714/770-3010



Stan Thompson
South Central
918/337-3717



Jon Cavallo, P.E.
Northeast
207/439-6765



Lloyd Smith, Ph.D.
Mid-Atlantic
703/478-0135



Ted Rudaitis, P.E.
North Central
312/425-9269

ENGINEERING, LABORATORY & INSPECTION SERVICES FOR PROTECTIVE COATINGS

SIX LOCATIONS
PROFESSIONALLY STAFFED
TO SERVE OUR CLIENTS RESPONSIVELY

S.G. Pinney & Associates, Inc.
473 S.E. Verada Avenue
Port St. Lucie, Florida 34983-2233
407/879-0574



Jerry D. Byrd, P.E.
Southeast
407/879-0574



Charlie Vallance
Underwater Engineering
407/879-0574



Steve Pinney, P.E.
Southeast
407/879-0574

BRIDGES: Short-span and Innovative Long-span

Michael A. Grubb, assistant manager of bridge engineering, AISC Marketing, Inc., spent much of his career contributing to the development of the autostress procedures for continuous steel bridge design. Autostress principles recognize the ability of continuous steel members to adjust automatically for the effects of local yielding, such as those caused by overloads.

By taking advantage of this inherent ability, designers generally are able to use prismatic steel members in continuous spans along the entire bridge length or between field splices. The benefits include

lower fabrication costs and elimination of structural details with undesirable fatigue characteristics.

Grubb's presentation focuses on the AASHTO *Guide Specification for Alternate Load-Factor Design Procedures for Steel Beam Bridges Using Braced Compact Sections*. The guide specification contains autostress procedures, which simply extend existing AASHTO Load Factor Design rules to permit inelastic load redistribution in continuous spans. The discussion includes a preliminary comparative design study recently completed for a two-span continuous bridge to be constructed in New York State. □

STRUCTURAL DETAILS FOR AUTOCAD

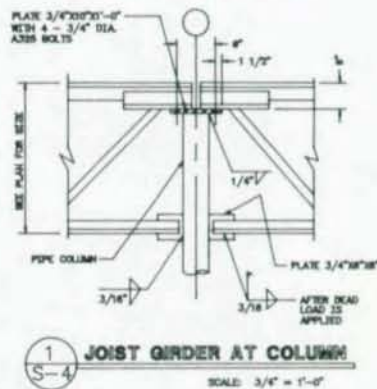

50 standard structural details on floppy disks with instructions and drawings. Includes foundation, steel framing, masonry, concrete, notes and more.

All necessary text fonts included. Will provide as DXF files, if requested. Send check or money order today for immediate delivery.

\$98.50

GOODMAN ENGINEERING
7076 PEACHTREE INDUSTRIAL BLVD.
NORCROSS, GEORGIA 30071

NEW IDEAS IN FIRE PROTECTION

From Belgium and Australia



The 1988 National Steel Construction Conference planning committee chose experts from Belgium and Australia to discuss "fire resistance engineering" as developed by ARBED S.A. and the Commission of the European Community, and test results which demonstrated to Australian building regulatory authorities that an effective automatic sprinkler system made fire protection of steelwork in open parking deck structures unnecessary. J. B. Schleich supervises research programs in the field of fire resistance of steel buildings at the ARBED Research Center in Luxembourg. His paper at the 1988 National Steel Construction Conference Friday, June 10 at 1:15 p.m., deals with a new powerful fire-resistance engineering which employs full advantage of the overall structural behavior of steel frames.

The computer program, code CEFICOSS, contains "a perfect duality between the mathematical failure and its physical meaning for structures submitted to fire load," Schleich says. "CEFICOSS accurately predicts the behavior of individual structural components as well as complete structures under the combined effect of static and fire loads," and thus permits a realistic prediction of the behavior of real frames under fire action.

This approach has now been used to determine the effect of local fires on real structures and, according to test results, has demonstrated that non-protected structural shapes, as part of a global frame, could have an unexpectedly high fire resistance.

Ian R. Thomas, manager of engineering research and development at the BHP Melbourne Research Laboratories, presents a paper co-authored with Arthur Firkins, director of technical services for the Australian Institute of Steel Construction, which reveals results of a research program conducted to investigate the effect on cars catching fire in an unprotected steel-framed parking garage. The research program on closed parking garages conducted in 1987 involved 20 cars and nine tests. The effect of minimum sprinkler and ventilation systems on temperatures developed in the air, cars and steel structure, with smoke and combustion products generated was investigated.

Thomas says, "The automatic sprinkler system was extremely effective in confining a developing fire, and sprinklers were equally effective in controlling well-developed fires. Without automatic sprinklers, fire spread from car to car in some tests, but with automatic sprinklers, fire did not spread from the test car.

"Without automatic sprinklers, smoke containing dangerous levels of toxic products occurred for long and potentially lethal periods, but with automatic sprinklers, dangerous levels occurred for shorter periods. Without sprinklers, steelwork temperatures due to fire within the car(s) caused no concern for periods of about 30 minutes and, with sprinklers, no concern at all."

Australian code regulations are now being changed accordingly, with a significant impact on the market for structural steel in Australia. □



AISC 1988 PRIZE BRIDGE COMPETITION

The Board of Directors of AISC
invites you to enter
the 1988
Prize Bridge Competition,
which honors the most
outstanding steel bridges
opened to traffic
from July 1, 1986
through June 30, 1988.

Entry deadline is July 26, 1988.



For rules and entry forms contact
American Institute of Steel Construction, Inc.
Awards Committee
400 North Michigan Avenue
Chicago, IL 60611-4185

0762

JM-2000 SLUGGER® BY JANCY ENG.

MADE IN AMERICA'S
HEARTLAND



IOWA

The JM-2000 SLUGGER® is a portable magnetic base drilling machine weighing only 42 pounds and capable of producing 2" diameter holes in carbon steel 2" thick in seconds. This is possible only because the JM-2000 accepts Jancy's patented annular SLUGGER® cutters. These SLUGGER® cutters are center free and cut only the periphery of the hole, thus requiring minimal torque and thrust.

The JM-2000 can be converted into a magnetic drill press in seconds, accepting twist drills up to 3/4". Some standard features of the JM-2000 are a rugged cast aluminum frame, internal lubrication of cutters through the arbor, easy to operate electrical panel located away from chips and oil and a heavy duty magnet with a minimum of 2250 pounds of dead lift on 1" plate.

Serving as Jancy's basic model, the JM-2000 can be readily adapted to handle a wide range of jobs on both steel plate and pipe. With Jancy, the customer can choose from a long list of optional equipment to build the machine for the job. For example, variable speed (RPM); pipe cradle adaptor for drilling in round material; chuck and adaptor with up to 3/4" twist drill capacity; chip breaker; 3" depth of cut conversion; gravity fed oil reservoir for continuous flow of oil to the cutting action; sensor panel to prevent the JM-2000 from starting on non-magnetic material or material too thin for proper holding force.

The JM-2000, like all of Jancy's SLUGGER® products, is sold only through the best stocking distributors. For the distributor nearest you, call Hollie or Debbie at 319-326-6251.



SLUGGER®
By Jancy Eng.

*gets the job done
at the plate every time.*

U.S. Patent Nos. 4385853,
4390309, 267011, 4596499

Caution:
Always use a safety chain when using a SLUGGER® magnetic drilling machine. Also safety glasses must be worn when operating SLUGGER® cutters or any other cutting tools.

Jancy Engineering Co.
4616 Kimmel Drive
P.O. Box 3098
Davenport, IA 52808
Telex #439002

Telephone (319) 326-6251
Fax #319-326-0949

FABRICATION/ERECTION UNITED TERMINAL



Fabrication and erection of the United Airlines Terminal in Chicago (see also *Modern Steel Construction*, No. 5-1987) will be detailed in presentations at the 1988 National Steel Construction Conference Friday morning and afternoon, June 10. Speakers will be Charles H. Thornton, principal of the consulting firm which designed the project, now president and principal of Thornton-Tomasetti, P.C., New York City, and Eugene W. Miller, senior vice president of Trinity Industries, Inc.'s structural steel division, which fabricated steel for the project.

The new terminal highlights the exposed

steel structure as an architectural feature. Built-up vaulted steel arches are used to form the 1,600-ft. long corridors. Folded-plate steel trusses comprised of tubular members form the support system for the ticketing pavilion, a large column-free area.

Design of connections became important architecturally as well as structurally, each exposed detail carefully reviewed by the design team. The achievement of both aesthetics and efficiency, however, also required a well-planned, in-depth strategy for the construction team. □

LRFD: The Computerized Specification

The American Institute of Steel Construction (AISC) is developing a new PC-based tool for automated and semi-automated interpretation and evaluation of the new Load and Resistance Design Specification. The research team developing the program presents an overview of the project during two separate sessions at the 1988 National Steel Construction Conference.

The workshop sessions will be conducted both Thursday and Friday, beginning at 3:30 p.m. Members of the team will also be available at the AISC booth in the exhibit hall throughout the conference for consultation and detailed explanation of software pro-

ducts now being developed. In the workshop sessions (Friday workshop repeats Thursday session) an overview is given of the structural engineering principles upon which the software is based. The resulting software tools and interfaces are illustrated with short design examples.

The role of this package in helping to solve practical office design problems is described, both in terms of current manual computations and in terms of computer-aided design systems. Finally, three commercial software products that will result from this development will be described according to their targeted uses. □

LRS

**LEVINSON
REGISTERED
STEELS**

The Levinson Steel Company:
P.O. Box 1617
Pittsburgh, PA 15230

**Pittsburgh, PA
Columbus, OH
Greenville, KY
Chicago, IL**

Levinson South Division:

**Atlanta, GA
Birmingham, AL
Dothan, AL
Mobile, AL
Orlando, FL
Raleigh, NC**

Borger Steel Division:

**Bethlehem, PA
York, PA**

Congdon & Carpenter Division:

**Auburn, MA
Seekonk, MA
Portland, ME**

KS Steel Division:

Kansas City, MO

**CALL
1-800-LEVINSON**

BEFORE THE SHORTAGE

Did you see it coming? Here's what we saw:

When people buy structural steel from one of our warehouses, they're looking for just two things: the material they need, and a low price. And the best way to provide both is to buy big, big, and bigger. That's what we were doing, long before the steel shortage developed.

DURING THE SHORTAGE

So, when the crunch came, we had quite a lot of steel on hand. Still do. (Our suppliers have treated us well.)

We can't say "Call any Levinson service center and you're guaranteed to get everything you need"—because frankly, sometimes you won't. But your chances are good.

AFTER THE SHORTAGE

In the future, you will find it even easier to buy out an order at a good price when you call Levinson. Here is what's in the works:

We'll be opening more new warehouses across the U.S. (maybe one close to where you sit). We will continue to carry a **complete** line of structurals (everything from jumbo beams to mini-mill sections, plus plates and bars).

And Levinson, now the nation's largest single buyer of structural steel, will continue to buy big . . . and pass that buying power on to you.

CALL 1-800-LEVINSON



The Levinson Steel Company • P.O. Box 1617, Pittsburgh, PA 15230

Steel's Flexibility

MERCER JR./SR. HIGH SCHOOL

To Build a Better Life

by James P. Rowan



Ten-year dream realized in Special Services School

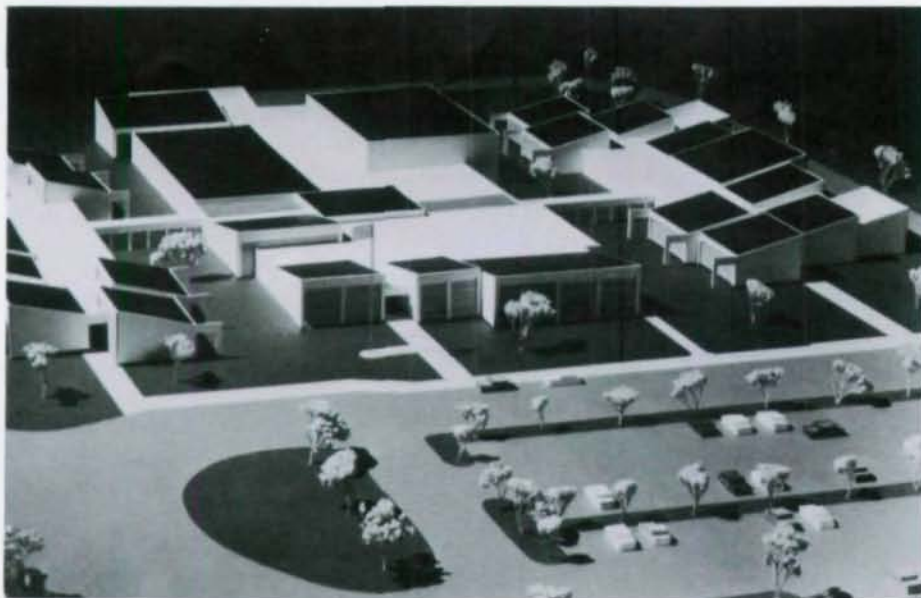

A 10-year dream of the Mercer County (N.J.) Special Services School District was realized with construction of the new Junior-Senior High School. Adolescent-age handicapped pupils with physical and behavioral disabilities served by the school district now have a facility appropriate for their educational, therapeutic and vocational needs. Previously, these students were housed in schools built for younger children and for other purposes. The new school, designed by Faridy Thorne Maddish, sits on 10 acres of the Mercer County Community College campus adjacent to the New Jersey Regional Day School.

When the Mercer County Special Services School District required additional facilities for their handicap programs, they entered into an agreement with the Mercer County Improvement Authority to have such a facility built. What resulted was a 74,000 sq. ft. one-story school of steel-frame and masonry construction consisting of three buildings. The facility has a footprint showing a large, central administrative building flanked on each side by a separate classroom wing.

An integrated facility for administrative and teaching purposes was achieved by the architect using the three-building concept. In addition to classrooms, the school houses the administrative offices of the Mercer County Special Services School District and will centralize much more of the special services Board of Education's operations. The central building is divided into two blocks. One end contains administrative offices, the other housing specialty classrooms for music, industrial arts, computer, basic skills and art, as well as health

and therapy rooms, library, gymnasium and cafeteria. Each wing, with 16,000 sq. ft of space, runs parallel, like outriggers, to the central structure. Both are connected to the central building by corridors. Combined, the two wings have a total of 23 classrooms, each approximately 24 x 32 ft. The two wings have an irregular geometric shape that causes offsets in the column layout of the framing system.

Several Systems Considered

After considering several possible framing systems the structural engineer opted for a structural-steel frame employing steel joist and standard wide-flange sections for beams and girders. Easily fabricated for sloped-roof conditions, the steel joist provided an economical support for the roof system. Light-gauge metal deck spans between the joists, spaced 6 ft o.c.

Wide-flange and tubular-steel columns provide the support for the framing system. The flexibility of steel provided a framing system that could easily adapt to the sloped roofs and irregular configuration of the facility. During fabrication, requirements for the sloped roof were addressed so that minimal field adjustments were necessary.

A large part of the roof area has a pitch of 2 in 12. Those sections of the building with sloped roofs also have clerestories with continuous strips of glass above the adjacent lower roof areas. The clerestory areas are framed by structural steel beams and channels that transfer all lateral and gravity loads to the steel column.

Concrete block and face brick and white stucco facade were chosen to complement existing buildings on campus. Easy and safe pedestrian traffic flow patterns for the handicapped have been created by both the architectural design and materials used throughout the structure.

In large complexes such as this one, erection of steel can begin while other parts are still being fabricated. The steel frame of the large central building was erected while the steel for the wings were still in fabrication. By the time steel was ready for wing erection, the frame of the central building was already complete. This process was adhered to during the erection of the right-side corridor and wing, followed by their left-side counterparts.

"Special schools like this one are very expensive to build," Arthur Julian, executive director of the Mercer County Improvement Authority, commented, "and there never seems to be enough money." "When the Authority was finally able to commit to the construction of this facility, they could not afford to waste motion or money or make any mistakes in the complex design



Steel-frame gave Authority edge in schedule and budget

and construction process . . . that is when, to keep this \$7-million project on track, the Authority hired a project manager," Julian explained.

To keep this \$7-million project on track, Charles Kinsing, the project manager's construction manager said that, "use of a structural-steel system gave us an edge in keeping the project on schedule and within budget. Fabrication and erection of a structural steel system is usually completed in a timely fashion."

Since opening its doors in September 1987—three months ahead of schedule—the Mercer Jr./Sr. High School has helped 165 physically and behaviorally handicapped children learn the fundamentals of a well-rounded education. □

Architect
Faridy, Thorne, Maddish

Structural Engineer
Blackburn Engineering Associates

Project Manager
Wagner-Hohns-Inglis, Inc.

General Contractor
McQuade-Burris, joint venture

James P. Rowan is director of project management services, Wagner-Hohns-Inglis, Mt. Holly, New Jersey.

**SAVE TIME AND MONEY
CALCULATE CONNECTIONS**

with CONNECT® version 3.0
Software and Data Base
for IBM PCs and Compatibles
Proven, easy-to-use, moderate price

DETAILERS, STRUCTURAL ENGINEERS
design, document, check:

- Framed Beam Connections
- Seated Beam Connections
- Eccentric Connections
- Connections in Tension
- Moment Connections
- Hip and Valley Details
- Oblique bracing with Setbacks
- Web Stiffeners
- Triangulation
- and more.

*Print a hard copy of calculations
and/or save on disk.*

Demo package available @ \$12.50.

Write or call today:

Hess Technical Services

2389 Mill Grove Road
Pittsburgh, PA 15241

(412) 831-2010 or (412) 833-7525

MORE

ACCURATE ESTIMATES PRODUCTION CONTROL

Bid more quickly and accurately...add productivity and cost-effectiveness to your plant...with the DMS Interactive Steel Fabrication System. A series of 8 interactive software modules, containing approximately 200 programs, addresses the specification needs of the steel fabricator.

Modules include:

- ESTIMATING
- BILL OF MATERIALS
- INVENTORY
- JOB COST
- GENERAL LEDGER
- ACCOUNTS RECEIVABLE
- ACCOUNTS PAYABLE
- PAYROLL

The DMS System is the product of 10 years development, and is currently being successfully used by over 40 steel fabricators.

Take control of the details each job demands with DMS. For more information, contact:



DATA MANAGEMENT SYSTEMS, INC.
12308 Twin Creek Road
Manchaca, Texas 78652
(512) 282-5018

NEW LRFD/ASD

Computer Data Base



**FOR
STRUCTURAL
SHAPES**

In a continuing effort to provide steel design aids to structural engineers, the American Institute of Steel Construction has improved and expanded its Computer Data Base for properties and dimensions of structural steel shapes, corresponding to data published in Part 1 of the 1st Edition, AISC LRFD Manual of Steel Construction, as well as properties needed for Allowable Stress Design according to the 8th Edition, AISC Manual of Steel Construction.

PROGRAM PACKAGE

1. Computer Data Base in binary format for the properties and dimensions of the following structural shapes:
 - a. W Shapes (many new sections)
 - b. S Shapes
 - c. M Shapes
 - d. HP Shapes
 - e. American Standard Channels (C)
 - f. Miscellaneous Channels (MC)
 - g. Structural Tees cut from W, M and S shapes (WT, MT, ST)
 - h. Single & Double Angles
 - i. Structural Tubing
2. Explanation of the variables specified in each of the data fields.
3. Listing of a BASIC read/write program and sample search routine.
4. Utility program to convert data file to ASCII format for FORTRAN applications.

ORDER FORM

1. Enclose payment of \$_____ for copy of NEW LRFD/ASD COMPUTER DATA BASE DIMENSIONS AND PROPERTIES OF STRUCTURAL SHAPES of 1989 each (Member price: \$45)

PERSONAL COMPUTER DISKETTE FOR:
 IBM PC (8 Completed) DEC Rainbow PC
 HP-100 Wang PC

Name _____ Title _____
 Company _____
 Address _____
 City _____
 State _____ Zip _____

Please enclose remittance. No C.O.D. orders. Inflow NYN, California and Illinois, add sales tax. Shipping charges prepaid in the U.S. On shipments outside the U.S., add 10% of total purchase for postage and handling. Visa and MasterCard accepted.

Signature _____
 Date _____

Visa & MasterCard accepted
 Card No. _____ Exp. Date _____

MAIL TO: NEW LRFD/ASD COMPUTER DATA BASE
 AMERICAN INSTITUTE OF STEEL CONSTRUCTION, INC.
 PO Box 4888 Chicago, IL 60680-4888

MSC ADVERTISERS

AISC	46	Levinson Steel	49
N.J. Bouras	2	Lohr Structural Fasteners ..	32
Bristol Machine	17	Omnitech	38
Cleveland Steel Tool	17	Pettitt Lawrence, Ltd.	8
Computer Detailing	18	S.G. Pinney	45
Computer Data Base (AISC) ..	52	Platt Bros. & Co.	33
Data Management	52	Research Engineers	21
Design Data	11	Riopelle Engineering	12
Dogwood Technologies	41	Sharon Companies	42
Enercalc	44	Smith-Emery	34
Engineering Software Serv. .	31	St. Louis Screw & Bolt Co. .	27
Epic Metals	55	Steel Deck Institute	43
Geometric Data Flow	6	Structural Analysis	34
Goodman Engineering	45	Struct-Fast, Inc.	22
Haydon Bolts	40	Structural Software Co.	5
Hess Technical	51	TRW-Nelson	37
Hilman Rollers	44	TradeARBED	23
International Struct. Eng. ...	36	J.M. Turner	30
ISE, Inc.	38	Vulcraft	28
Jancy Engineering	47	Waterloo Engineering	3
LeJeune Bolts Co.	19		

EXHIBITORS' DIRECTORY

Exhibiting MARVEL metal cutting band saw systems. Up to 37-inch capacity.

Armstrong-Blum Mfg. Co.
5800 W. Bloomingdale Ave.
Chicago, IL 60639 312/637-4000
Booth #416

Structural steel sections are bent with induction heat, providing design flexibility accuracy and uniformity. Integrity of material is enhanced; many structural shapes, sizes can be bent with exceptional accuracy.

Associated Piping & Engineering Co.
851 So. Freeport Industrial Pkwy.
Clearfield, UT 84015 801/773-7000
Booth #321

Carboline introduces a new line of VOC compliant coatings for industrial applications. Carbo Zinc D11 High Solids follows tradition of the Carbo Zinc series and offers additional key benefits.

Carboline Co.
350 Hanley Industrial Court
St. Louis, MO 63144 314/644-1000
Booth #606

Punches, die buttons, punch stems, coupling nuts, shear blades, angle blades, notch-er & coper tools and hand tools.

Cleveland Steel Tool Co.
474 E. 105th Street
Cleveland, OH 44108 216/681-7400
Booth #208

Structural fabricating machinery.

COMEQ
P. O. Box 2193
Baltimore, MD 21203 301/325-7900
Booth #430

Software for steel fabrication. "Interactive Steel Fabrication System" package production and general accounting modules; all have interactive, multi-processing capabilities, fully backed by authors. Complete installation & on-going support.

Data Management Systems, Inc.
12308 Twin Creek Road
Manchaca, TX 78652 512/282-5018
Booth #220

It's time. . .

Stop by our booth—#309-313 and #401-414—to see the most sophisticated, advanced computer system to emerge on the structural steel horizon.

INTRODUCING
The 4.0 Version of SDS/2

DESIGN DATA

"Software For The Professional"

Design Data Corporation
1033 "O" Street, Suite 324
Lincoln, NE 68508 402/476-8278

PDS Procedural Detailing System, a computer-aided detailing system designed by detailing, engineering and computer specialists; produces high quality detail drawings—one of the most practical, accurate, reliable and best-integrated systems on the market.

D & M Drafting Company, Inc.
(Dogwood Technologies, Inc.)
114 Anderson Ave. N.W.
Knoxville, TN 37917 615/525-4264
Booth #101

Autosteel™-3D frame analysis and steel design program.
Autopipe™ -Pipe stress analysis and design system.
Cadpipe™ -Piping design and drafting overlay for Autocad™.

Engineering Design Automation
1930 Shattuck Avenue
Berkeley, CA 94704 415/848-7080
Booth #408

Long span deck: plated, perforated, plain, welded sections—all in a variety of design thicknesses for economical spans up to 32 ft; a combination roof and ceiling panel, top surface ready for rigid insulation and roofing, underside becomes finished ceiling. Used successfully in stadiums, convention centers, theatres, criminal justice facilities.

Epic Metals Corp.
11 Talbot Avenue
Rankin (Pittsburgh), PA 15104 412/351-3913
Booth #418

The standard of excellence in integrated systems for detailing, CNC Equipment Automation, Estimating and Production Management using IBM PC/AT compatible computers.

Geometric Data Flow, Inc.
337 North Vineyard, Suite 206
Ontario, CA 91764 714/984-1269
Booths #204-206

MAX40 air plasma cutting unit used for hand cutting metals of all thicknesses up to 3/8". Uses low-cost shop air, cuts straight lines or shapes at higher speeds, produces high-quality cuts with minimum distortion. MAX20, designed for sheet metal workers, cuts steel, galvanized, stainless, most other metals up to 3/16".

Hypertherm, Inc.
P. O. Box A-10, Etna Road
Hanover, NH 03755 603/643-3441
Booth #604

Portable magnetic drilling machines, and annular cutting tools.

Jancy Engineering
4616 Kimmer Drive
Davenport, IA 52808 319/326-6251
Booth #404

Complete line of centrifugal wheel blast equipment for structural/plate steel suppliers. Machine designs include horizontal, vertical, to complete preservation lines. Blast machine rebuilds and retrofits available.

**B & U Corporation/
Jet Wheelblast Equipment Division**
401 Miles Drive
Adrian, MI 49221 517/263-0502
Booth #307

Largest manufacturer of CNC retrofits for structural steel fabricating equipment—offering the highest production levels and reliability in industry. Specializing in automated control systems for angle iron and structural steel beams.

JH Engineering
P. O. Box 26289, Dept. 418
Birmingham, AL 35226 205/945-8230
Booth #608

EXHIBITORS' DIRECTORY

Model RKT 631 universal miter cutting circular cold saw for solids, tubes and structural sections.

Kaltenbach, Inc.

P. O. Box 1629
Columbus, IN 47202 812/342-4471
Booth #212

LeJeune tension control bolts—open stock and domestic A325 and A490, black and galvanized. LeJeune power wrenches.

LeJeune Bolt Co.

8330 W. 220th St.
Lakeville, MN 55044 612/469-5521
Booth #301

New wire feeder equipment, designed to provide maximum portability while retaining procedure control for structural welding integrity. Also on display: engine welders, power sources and a high deposit, vertical-up self-shielded flux-cored process.

The Lincoln Electric Company

22801 St. Clair Avenue
Cleveland, OH 44117 216/481-8100
Booths #315, 317, 319

(Booth 325)

MDX

-PROGRAMS FOR
CONTINUOUS COMPOSITE
STEEL HIGHWAY GIRDER DESIGN-

Optimal Design without Interaction

- Welded or Rolled
- Horizontal Curvature
- Mainframe or Micro

MDX

1412 Ridgmont Ct.
Columbia, MO 65203
(314/442-3221)

Microcomputer-based structural steel detailing.

Pettitt Lawrence, Ltd.

550 Alden Road, Suite 201
Markham, Ont. Can. L3R 6A8
416/479-0399
Booth #526

Professional engineering and inspection services for the protective coatings industry: failure analysis, shop and field inspection, material recommendations, training, specification preparation, expert testimony, laboratory analysis. Six offices in the U.S.

S. G. Pinney & Associates, Inc.

473 SE Verada Avenue
Port St. Lucie, FL 34983 305/879-0574
Booth #303



Medina, Ohio
Barberton, Ohio
Phoenix, Arizona

Booth #212

Decorative and corrosion-resistant coatings for steel in various environments.

Southern Coatings, Inc.

P. O. Box 160
Sumter, SC 29151-0160 803/775-6351
Booth #305

Providing uniform industry standards since 1939 for engineering, design manufacture and field usage of steel decks. Information, publications displayed with particular emphasis on all new 2nd Edition of *Diaphragm Design Manual* for engineers, architects, containing updated information on diaphragm strength, diaphragm stiffness, connections, filled diaphragms, with example problems.

Steel Deck Institute, Inc.

P. O. Box 9506
Canton, OH 44711 216/493-7886
Booth #420

Software for steel fabricators: estimating, detailing, production control, inventory, mulling.

Structural Software Company

2829 Peters Creek Road
Roanoke, VA 24019 703/362-9118
Booths #226-228

"ARBED" structural steel products, ranging from standard wide-flange beams to rolled W40 in.-44 in. and tailor-made (WTM), wide-flange beam series.

Trade ARBED Inc.

825 Third Avenue
New York, NY 10022 212/486-9890
Booths #505-507

Extensive line of high-performance primers and other coatings for steel construction industry. All systems free of lead and chromate pigments.

Themec Company, Inc.

P. O. Box 411749
Kansas City, MO 64141 816/483-3400
Booth #216

Direct tension indicators (ASTMF959) for most reliable assurance of properly tensioned, high-strength bolts.

J & M Turner, Inc.

770 Industrial Blvd.
Southampton, PA 18966 215/953-1118
Booth #210

Daito cutoff machine—30 in. wide-flange capacity.

Yamazen USA

735 East Remington Road
Schaumburg, IL 60173 312/882-8800
Booth #225

8765

EPIC LONG-SPAN DECKS



E750-SPANS TO 32 FT.
E600-SPANS TO 26 FT.
E450-SPANS TO 23 FT.
E300-SPANS TO 15 FT.

AVAILABLE FOR DELIVERY—NOW

Galvanized G60-G90
Lengths to 50 ft.

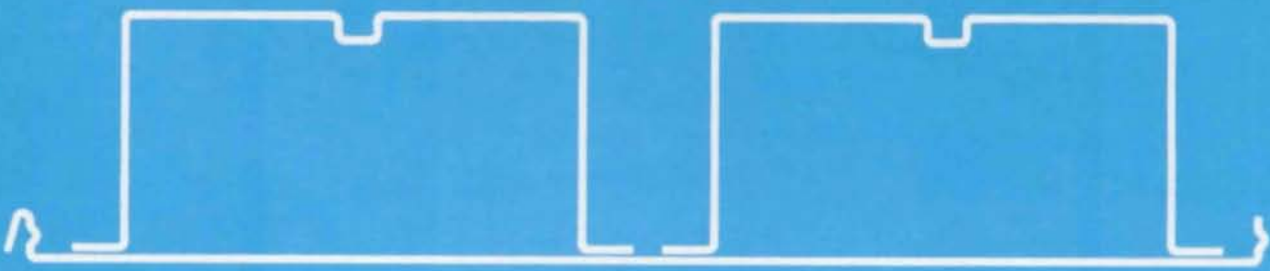

Plated Decks—Plain or perforated
Most complete line of deck products
in $\frac{5}{8}$ " to $7\frac{1}{2}$ " depths

OUR SERVICE WILL SAVE YOU TIME & MONEY

Epic has these profiles available for shipment on an A.S.A.P. Basis!

Your order will be processed in One Week in most cases. Ask about our A.S.A.P. Service.

Call (412) 351-3913 today for price and delivery information and for product advice on all types of Form Decks, Composite Decks, Long-Span and Roof Decks.

Manufacturing Plants:

- Pittsburgh, Pa.
- Chicago, Ill.
- Lakeland, Fla.

Dealer Inquiries Invited

EPIC[®]
METALS CORPORATION

Eleven Talbot Avenue, Rankin, PA 15104
PHONE: 412/351-3913
TWX: 710-664-4424
EPICMETAL BRDK

You need one of these before you build...



and one of these before you design.

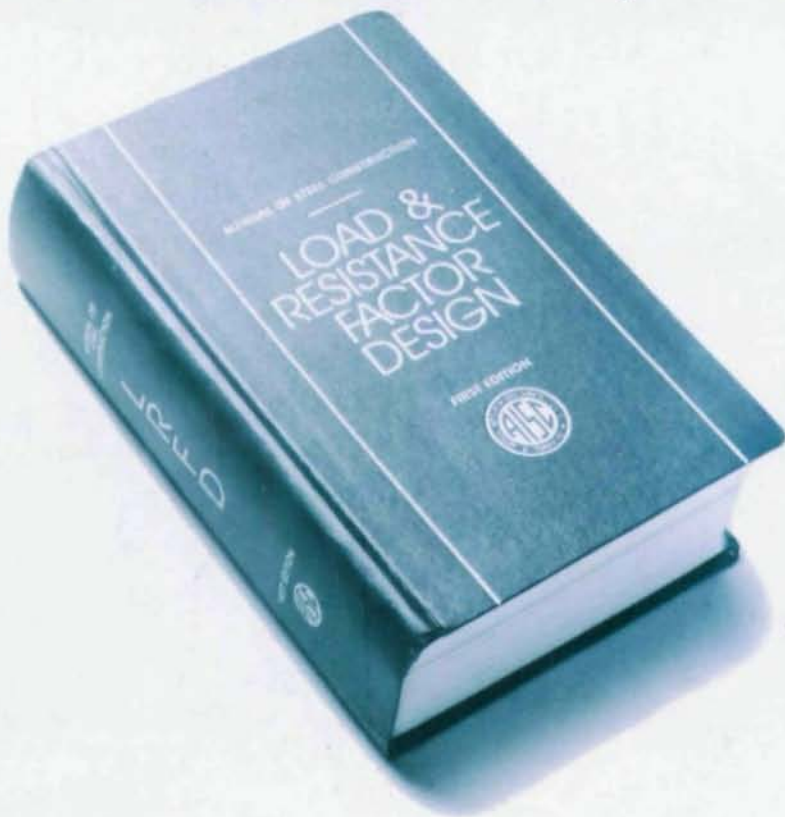

Designing a building is obviously more complicated than using a spud wrench. That's why the First Edition of Load and Resistance Factor Design Manual of Steel Construction belongs in your library.

It blends familiar, established basics with the most up-to-date advances in steel design. Already

accepted by model and city building codes, it offers you an alternative to traditional design methods.

Why not discover the advantages of Load and Resistance Factor Design for yourself? Order this valuable design tool today!

Order your copy today!

Mail to: American Institute of Steel Construction-Dept. B
P.O. Box 4588, Chicago, IL 60680-4588

I enclose \$_____ for _____ copies of the First Edition of Load and Resistance Factor Design Manual of Steel Construction at \$56.00 each.

Name & Title _____

Company _____

Address _____

City _____ State _____ Zip _____

Please enclose remittance. No C.O.D.'s. In New York, California and Illinois add sales tax. Shipping charges prepaid in the U.S. On shipments outside the U.S., add 10% of total purchase for postage and handling. Visa and Mastercard accepted.

Charge my card no. _____ /Exp _____



**AMERICAN INSTITUTE
OF STEEL CONSTRUCTION, INC.**