

2" Bridge Form (Stay In Place Steel Forms)

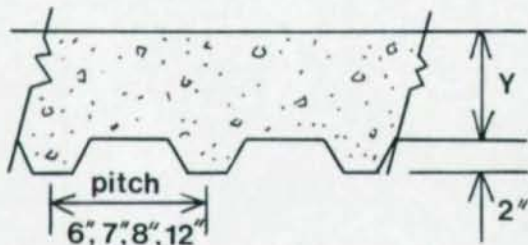

(Also available in 5½", 6½" + 7½" pitches)

$$\text{Concrete Volume} = \frac{Y}{12} + C_v, \text{ Ft.}^3 / \text{Ft.}^2$$

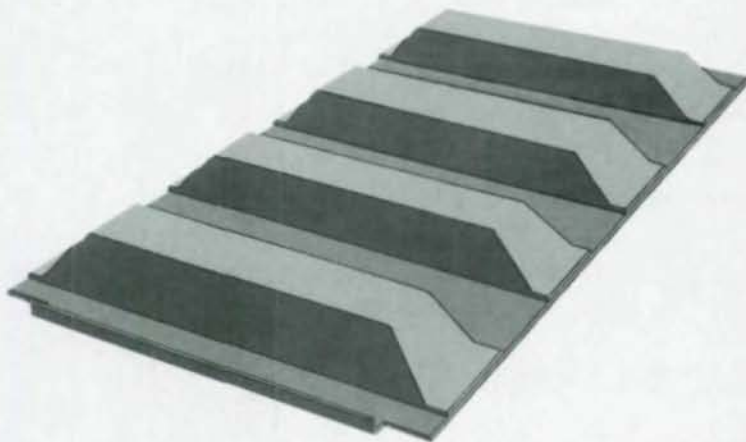

(2" x 12" not shown)

- - TABLE OF MAXIMUM (SINGLE) SPANS IN FEET - -

Profile	Ga	Y, Concrete Topping										
		5"	5.5"	6"	6.5"	7"	7.5"	8"	8.5"	9"	9.5"	10"
2" x 6" Cv = 0.0833	22	6.14	6.14	6.08	5.95	5.83	5.72	5.61	5.51	5.42	5.33	5.24
	20	6.65	6.65	6.65	6.65	6.65	6.52	6.40	6.29	6.18	6.07	5.98
	18	7.46	7.46	7.46	7.46	7.46	7.46	7.46	7.46	7.35	7.23	7.12
	16	7.95	7.95	7.95	7.95	7.95	7.95	7.95	7.95	7.86	7.77	7.68
2" x 7" Cv = 0.0714	22	5.88	5.87	5.74	5.62	5.50	5.40	5.30	5.20	5.11	5.02	4.94
	20	6.39	6.39	6.39	6.39	6.30	6.18	6.06	5.95	5.85	5.75	5.66
	18	7.22	7.22	7.22	7.22	7.22	7.22	7.22	7.22	7.13	7.01	6.90
	16	7.87	7.87	7.87	7.87	7.87	7.87	7.87	7.87	7.81	7.71	7.63
2" x 8" Cv = 0.0625	22	5.65	5.55	5.43	5.31	5.20	5.10	5.00	4.91	4.82	4.74	4.66
	20	6.15	6.15	6.15	6.09	5.97	5.85	5.74	5.64	5.54	5.44	5.35
	18	6.97	6.97	6.97	6.97	6.97	6.97	6.97	6.90	6.78	6.67	6.56
	16	7.69	7.69	7.69	7.69	7.69	7.69	7.69	7.69	7.65	7.56	7.45
2" x 12" Cv = 0.0764	22	6.03	6.03	5.91	5.78	5.66	5.55	5.45	5.35	5.26	5.17	5.09
	20	6.54	6.54	6.54	6.54	6.49	6.36	6.24	6.13	6.02	5.92	5.82
	18	7.28	7.28	7.28	7.28	7.28	7.28	7.28	7.28	7.19	7.08	6.97
	16	7.79	7.79	7.79	7.79	7.79	7.79	7.79	7.79	7.72	7.63	7.54

- Maximum spans are based on USFHA loading
 - construction load = 50 psf; minimum deflection load = 120 psf.
- Allowable deflection = the least of 1/180 or 0.5".
- Allowable deck stress = 29 ksi.
- Concrete weight taken at 145 pcf; deck and rebars estimated at 5 psf.
- Deck Span is usually edge to edge of stringers less 2"
- For some states the slab design depth is Y; for others the slab design depth is measured from the centroid of the form - - estimate this as Y + 1".



NICHOLAS J. BOURAS INC.
P.O. BOX 662, 475 SPRINGFIELD AVE.,
SUMMIT, NEW JERSEY 07901 (201) 277-1617



ASSOCIATE MEMBER

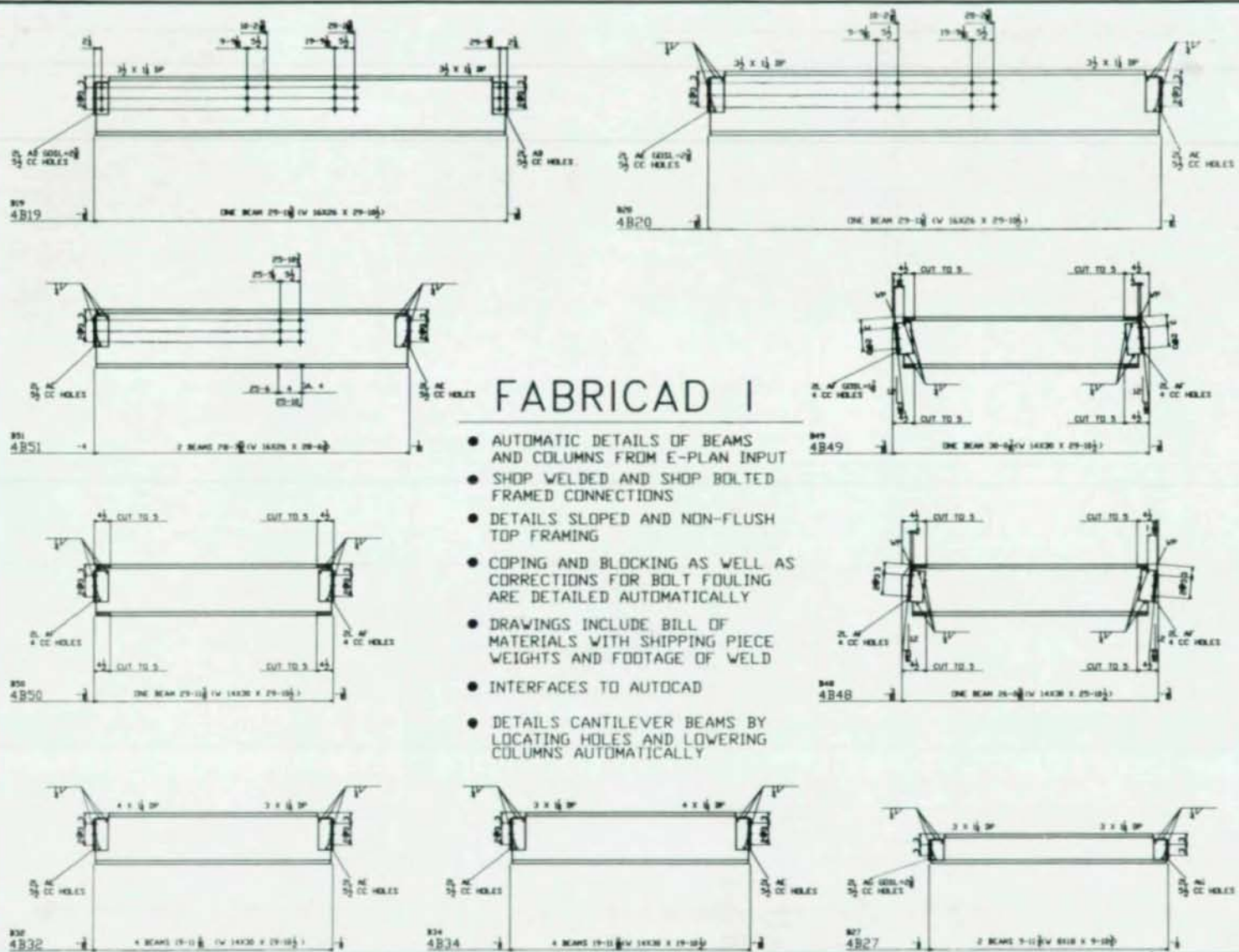

FABRICAD I

- AUTOMATIC DETAILS OF BEAMS AND COLUMNS FROM E-PLAN INPUT
- SHOP WELDED AND SHOP BOLTED FRAMED CONNECTIONS
- DETAILS SLOPED AND NON-FLUSH TOP FRAMING
- COPING AND BLOCKING AS WELL AS CORRECTIONS FOR BOLT FOULING ARE DETAILED AUTOMATICALLY
- DRAWINGS INCLUDE BILL OF MATERIALS WITH SHIPPING PIECE WEIGHTS AND FOOTAGE OF WELD
- INTERFACES TO AUTOCAD
- DETAILS CANTILEVER BEAMS BY LOCATING HOLES AND LOWERING COLUMNS AUTOMATICALLY

PART	BEAM	SHAPE	LENGTH	REMARKS	ACCURACY
4819	ONE	V 14X26	29-1/2		799
AD	4	L 14X26	29-1/2		
	6	PLATE ANTS-M	29-1/2		
4820	ONE	V 14X26	29-1/2		797
AC	4	L 14X26	29-1/2		
	1	W	29-1/2		
4821	2	V 14X26	29-1/2		1596
AC	8	L 14X26	29-1/2		
	1	W	29-1/2		
4849	ONE	V 14X26	29-1/2		814
AF	4	L 14X26	29-1/2		
	1	W	29-1/2		
4850	ONE	V 14X26	29-1/2		814
AF	4	L 14X26	29-1/2		
	1	W	29-1/2		
4848	ONE	V 14X26	29-1/2		794
AF	4	L 14X26	29-1/2		
	1	W	29-1/2		
4832	4	V 14X26	19-1/2		2467
AC	16	L 14X26	19-1/2		
	1	W	19-1/2		
4834	4	V 14X26	19-1/2		2467
AC	16	L 14X26	19-1/2		
	1	W	19-1/2		
4827	2	V 818	9-1/2		383
AG	8	L 818	9-1/2		
	1	W	9-1/2		

STEEL WEIGHT THIS SHEET 1081
 PERFORMER (ENTER NO.)

NOTES
 MATERIAL A36 UNLESS NOTED
 WELDS EXX ELECTRODE
 OPEN HOLES UNLESS NOTED
 PAINT

STRUCTURAL SOFTWARE COMPANY
 5012 PLANTATION ROAD
 ROANOKE, VIRGINIA 24019

FABRICAD I DEMONSTRATION
 STRUCTURAL SOFTWARE COMPANY

DATE	DRAWING NO.	SHEET NO.
REVISED		4
BY: (NAME)		REV. NO.

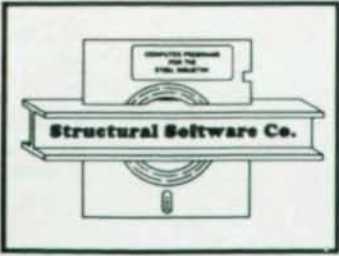

Structural Detailing Made Affordable.

If high prices have kept you from automated detailing, wait no longer. FabricAD I is a robust sub-set of the Structural Software Company's computerized steel detailing system. This fully upgradable product will multiply the productivity of your detailing department immediately. And, FabricAD I can grow with you as your needs change. Runs on IBM-AT or compatible.

Structural Software Company
 PO Box 19220
 5012 Plantation Road NE
 Roanoke, VA 24019
 (703) 362-9118

\$9,995

MODERN STEEL CONSTRUCTION

VOLUME XXVIII • NUMBER 5
SEPTEMBER-OCTOBER 1988

American Institute of Steel Construction, Inc.

The Wrigley Building
400 North Michigan Avenue
Chicago, Illinois 60611-4185
Phone: 312 / 670-2400

OFFICERS

Samuel Y. Golding
Chairman
Ralph H. Clarbour
First Vice Chairman
Stephen E. Egger
Second Vice Chairman
Oscar W. Stewart, Jr.
Treasurer
Neil W. Zundel
President
William W. Lanigan
Secretary & General Counsel
Lewis Brunner
Vice President, Membership Services
Geerhard Haaijer
Vice President, Technology & Research
Morris Caminer
Vice President, Finance/Administration

EDITORIAL STAFF

George E. Harper
Director of Publications
Brenda Follmer
Assistant Editor
Lona Babbington
Business

ADVERTISING REPRESENTATIVE

The PATTIS GROUP
Eric K. Nieman
4761 West Touhy Avenue
Lincolnwood, Ill.
312/679-1100

ON OUR COVER

Steelworkers near tip
of Infinity Room high above
valley floor. See story on p. 23.

-
- 7 Minnesota Center
To Define an Image



-
- 12 Steel Notes

-
- 13 Nashville Metro Airport
A Cascade of Steel



-
- 21 Riverside Drive Viaduct
Re-creating an Original

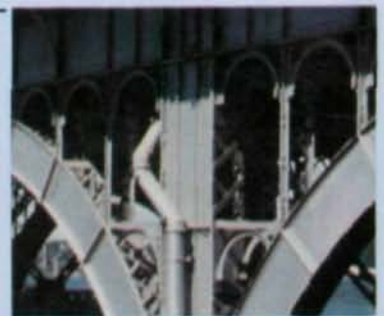

-
- 23 House on the Rock
Steel—from Here to Infinity



-
- 28 Stamford Landing
No "Boxes" on the Coastline



00791
1600

**A GRAPHIC
EXAMPLE
OF WHAT
SEPARATES**

Scada

**FROM
PROGRAMS
COSTING
TEN TIMES
AS MUCH.**

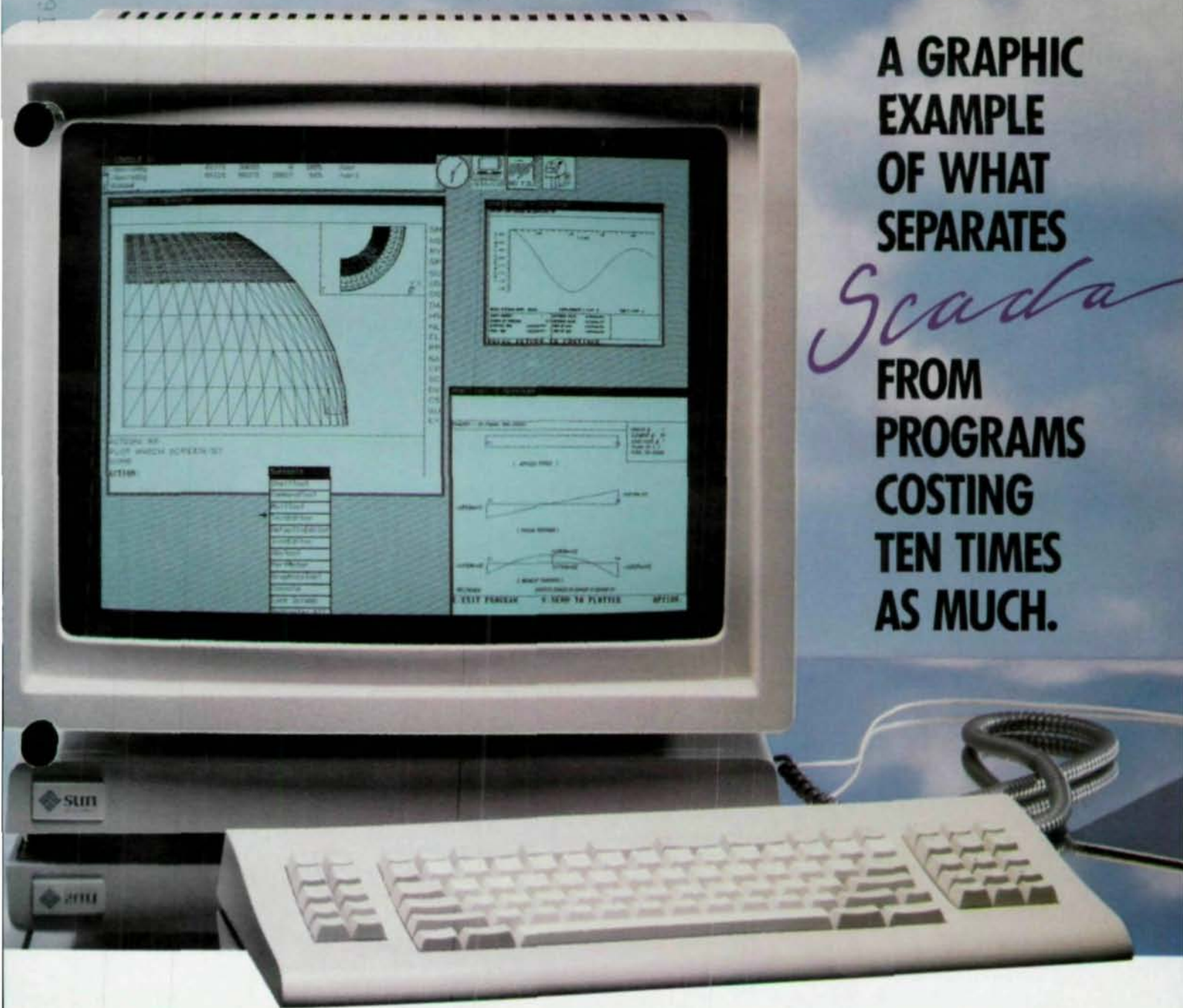

If an \$1,800 base price seems too low for advanced finite element analysis and design software, you can always spend ten times more on a competitive program. But look what you'll be missing:

- ▲ The world's most powerful and versatile 2-D and 3-D desktop finite element analysis system.
- ▲ Graphics capabilities only available in far more expensive programs.
- ▲ SEDIT. A state-of-the-art, interactive and menu-driven preprocessor offered by SCADA at no extra charge, and unlike anything attempted by any other FEA developer.
- ▲ Plus the ability to add, for \$1,000 more, either concrete or steel design capabilities including AISC's latest Load Resistance Factor Design (LRFD) Code.



AMERICAN COMPUTERS & ENGINEERS

11726 San Vicente Blvd., Suite 212,
Los Angeles, CA 90049

Tel.: (213) 820-8998 Telex: 493-0363 ACE UI

Taken as a whole, SCADA represents the finest integrated design and analysis software available today. SCADA's integrated modular configuration makes it the only program that can grow without any change to its architecture. Add flat-slab or shear-wall design—even buckling and nonlinear capabilities. Whether you're a big organization designing some of today's largest structures, or a smaller firm with simpler requirements, you'll find SCADA adapts easily to the projects at hand.

SCADA is available exclusively through American Computers & Engineers. For a brochure detailing the full scope of its capabilities, simply contact us at the address below. And prove to yourself that a powerful engineering program needn't come with an overpowering price.

Now you *can* put all of your eggs in one basket.

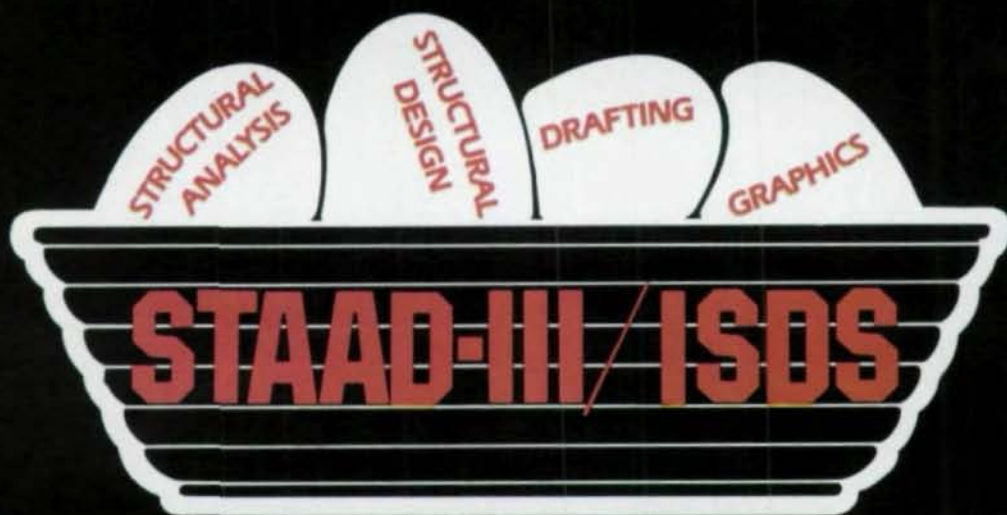

The first structural analysis/design software with built-in drafting
Fully capable beyond 640K memory
(all for only \$3,400*)

The Integrated Structural Design System: classic STAAD-III analysis and design, STAADPL graphics, plus STAAD-DRAFT—the brand new drafting facility designed especially for structural engineers. One complete package. \$3,400.

This unprecedented level of integration is a much needed breakthrough for structural engineers. Previously, to generate drawings from design data, some sort of interface package was necessary to link the two programs. This cumbersome process involved purchasing, maintaining, and learning two (or more) programs from different vendors.

ISDS solves this problem with its unique capability

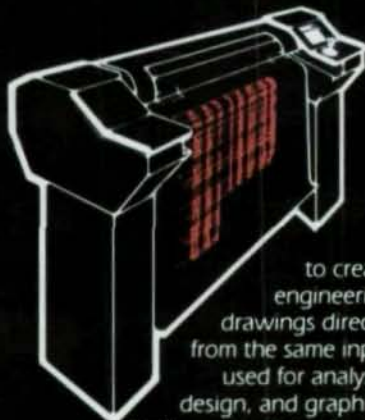

to create engineering drawings directly from the same input used for analysis, design, and graphics.

Furthermore, this information is held in a central database maintained by ISDS. User interaction is minimized, improving both efficiency and data integrity.

It makes sense.

At the heart of ISDS, STAAD-III performs static and dynamic analyses on two- and three-dimensional structures and designs

members in steel or concrete based on user-selected standard codes. Available codes include AISC working strength and the new LRFD specifications involving member deflection considerations, as well as ACI and AASHTO codes. STAAD-III handles a wide variety of loading conditions, including internally generated moving loads.

For more details on STAAD-III based ISDS or a demonstration version, please call or write: Research Engineers, 303 Pavilions at Greentree, Marlton, NJ 08053. Phone: (609) 983-5050. TLX: 4994385.

In Europe, Research Engineers, 17 Lansdowne Rd., Croydon CR9 3UN, U.K. Phone: 01 6867672 TLX: 929181.

*Licensing fee on MS-DOS based PCs

Research Engineers, Inc.
A REPUTATION YOU CAN BUILD ON

System Selection

MINNESOTA CENTER

To Define an Image

by David J. Galey

Developing a speculative office building is always a balance between architectural design, leasing trends of the marketplace and financial constraints. At Minnesota Center in suburban Minneapolis, the demands of the highly competitive marketplace mandated very specific requirements. The leasehold space had to be efficient and extremely flexible so a wide variety of tenants could adapt the building readily to individual needs. In addition, the owner wanted the maximum number of amenities and special features to insure attraction of stable tenants.

Within this context, the developers paid close attention to system and material selections. This involved thoroughly examining not only initial costs, but also value engineering and life cycle costing. Budgetary decisions were based on maintenance and flexibility requirements as well as initial one-time expenses.

The building is a luminous set of rectangles intersecting at 45° angles. The distinctive profile changes with every shift in direction, creating a unique, highly identifiable structure that distinguishes Minnesota Center from a number of nearby suburban office buildings. The blue/green curtainwall is punctuated by pearl-toned mullions and a rich, warm Kasota stone entrance canopy.

In the lobby, the space expands into a two-story atrium defined by patterned marble and granites, and sleek detailing. Office space begins on the second floor. Below ground are two levels of heated parking; a five level parking ramp is located adjacent to the building on the north.

After thorough consideration of the design factors and the cost analysis, structural steel was chosen as the primary framing system for the building.



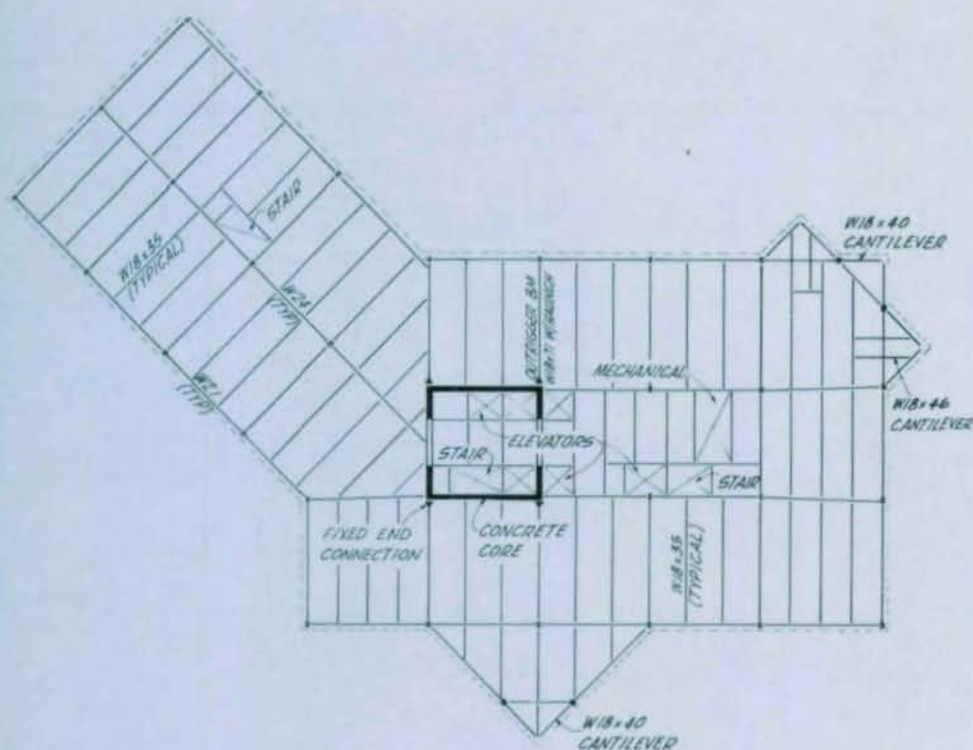

Typical floor framing plan

Site Considerations and Foundations

Previously the site of a drive-in movie theater, this valuable commercial location had somewhat difficult soil conditions. Originally wetland with seven to 15 ft of peat, the current site had accumulated a substantial layer of uncontrolled fill during the 1950s and 60s.

The unsuitability of these upper soils for vertical or lateral support mandated the use of a deep piling foundation system which could accommodate the load of the 17-story building. This was accomplished by using groups of 150-ton capacity, 10 $\frac{1}{4}$ -in. dia. steel pipe piles driven to depths ranging from 100 to 175 ft. Battered piles provide resistance to lateral loads from wind and unbalanced earth pressures. Steel strapping field-welded to the top of selected piles provides resistance to uplift forces. Because of its relatively light weight, the structural steel superstructure resulted in substantial foundation cost savings.

Lateral Load-resisting System

The basis of the lateral system at Minnesota Center is a single concrete shear core. This monolithic element was chosen after comparing a number of bracing schemes and moment-resisting frames. It was determined to be the most efficient and cost-effective means to provide drift control for both lateral and torsional translation.

Located very close to the wind pressure centroid in both of the building's primary axes, the core measures 30 ft x 30 ft and encloses three elevators, a stair and other fixed spaces. Wall thickness is typically 12 in., except for the walls in the transverse direction below Level 8. Here, an 18-in. thickness was required to achieve the necessary strength and rigidity for the link beams which span the large elevator lobby openings. Concrete strength was varied from 6,000 psi at the base to 4,000 psi by Level 5.

Shear force at the base of the core was distributed to piles directly below and to perimeter foundation walls through diaphragm action of the first floor and P2 level parking floor. A computer model was used to determine the relative stiffnesses and force distributions to these elements. Above the shear core, which terminates at Level 14, diagonal steel bracing carries wind forces from the top three levels.

Stabilizing the shear core, a series of outrigger beams span in the transverse direction of the building on each level. These girders extend from each of the four corners of the core to exterior columns. Rigid, fixed-end connections were made to the concrete core, while simple pinned-end connections were used at exterior col-



Punches & Dies

- 24 Hour Shipments
- Lowest Prices



Write for catalogs.



Call 1-800-446-4402
THE CLEVELAND STEEL TOOL CO.
 474 E. 105th Street • Cleveland, Ohio 44108
 A-1401

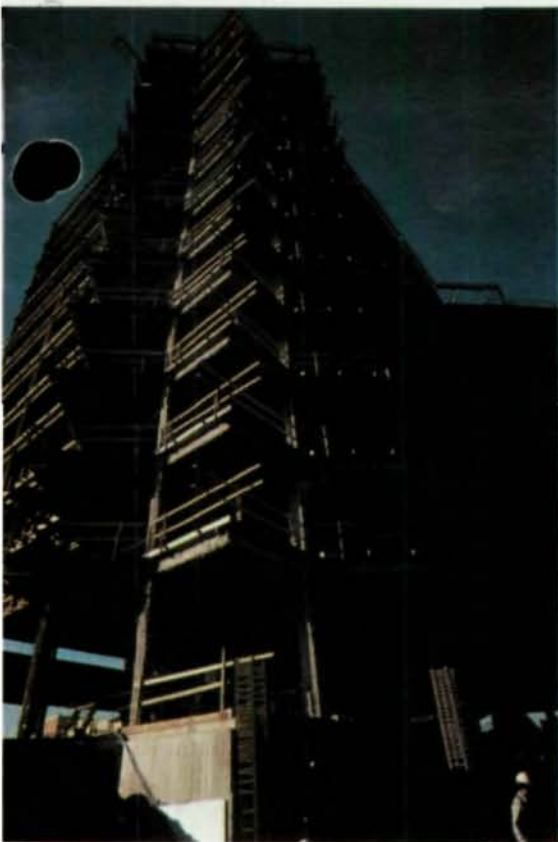

Column-free corners created by using cantilevered floor framing

umns. These outrigger beams serve to reduce the amount of lateral drift. And, of equal importance, they minimize the overturning force at the base of the core, thus allowing for significant savings in piling.

Gravity Framing System

The gravity framing system for this 300,000-sq. ft structure is fairly typical floor construction. With a typical floor-to-floor height of 13 ft and a nominal 30-ft x 33-ft bay size, an approximate steel weight of 10½ psf of framed area was achieved.

The typical floor slab construction is 3¼ in. of lightweight concrete (3,000 psi) over 3-in., 20-ga. phosphatized painted composite metal deck. The resulting 6¼ in. thick slab typically spans 10 ft and is reinforced with 6 x 6 - W1.4 x W1.4 W.W.M. draped over continuous No. 5 support bars located high in the slab over purlin locations. Additional No. 4 reinforcing bars were placed high in the slab above and perpendicular to girder locations as well as where composite deck changed span directions to minimize concrete cracking.

Typical floor framing members are A36 purlins and girders, designed to act compositely with the concrete floor slabs. Shear transfer for composite behavior was achieved through the use of ¾-in. dia. x 5-



Dramatic lobby expands into two-story atrium with sleek patterned marbles and granites

STRUCTURAL DESIGN USING LOTUS 1-2-3® + ENERCALC™



Use LOTUS 1-2-3® as your personal structural designer. Your \$795, 26 program "library" supplies design & analysis in steel, timber, retaining walls, concrete, masonry and can perform structural analysis.

Forward thinking engineers will realize this software is REQUIRED MATERIAL in today's competitive design office, and our nationwide user's are available as impartial references. Receive our brochure or demonstration packages by contacting:

ENERCALC™

3432 Via Oporto 207
Newport Beach, CA 92663 • 714-723-0295

Cantilevered framing and shear core

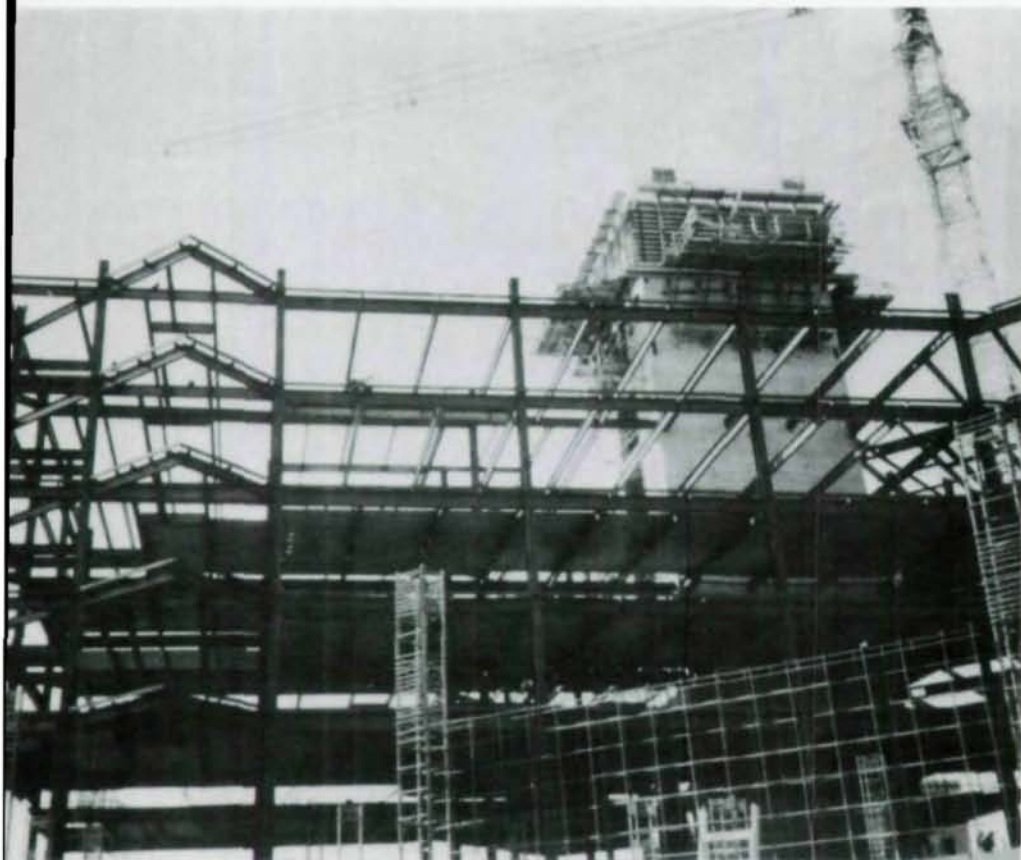

in. long headed, shear studs, field-welded to the top flanges of purlins and girders once the metal deck had been placed. Floor purlin members 20 ft and longer were shop-cambered to compensate for deflections caused by wet concrete. These cambers created special considerations for the contractor, since concrete floor slab elevations were monitored by a laser leveling device. Top-of-slab elevations had to be adjusted to compensate for sequential loading of the cambered purlins to achieve the required slab thickness. Girder members were required to be shored until 75% of the required concrete design strength was achieved. An allowable live-load deflection of $\frac{5}{16}$ in., required to accommodate the curtainwall system selected for the building, governed the design of edge beams around the perimeter of the building. All floor framing members were spray-fireproofed to achieve the required ratings.

Typical purlin and girder end connections were simple, pinned connections using double clip angles and A325 Type N bolts. This connection was used in both steel-to-steel member connections as well as steel-to-concrete shear wall connections, except for the outrigger beams previously mentioned. Clip angles at concrete shear wall locations were field-welded to embedded steel plates anchored into the concrete with shop-welded headed shear studs.

Column-free building corners were accomplished in four locations by using cantilevered floor framing construction. Two such locations use bolted end-plate connections on W18 perimeter beams framing into column webs to create a 13-ft cantilevered projection. The remaining two locations employ bolted top and bottom flange plates with double-clip, angle-web connections to cantilever W18 floor purlins past W18 edge girders at the same top elevations. Additional No. 4 reinforcing bars were placed high in the concrete slab at these cantilevered purlin locations to increase stiffness of the cantilevered floor area, as well as to provide crack control. In all cases, cantilevered member sizes were governed by stiffness requirements to accommodate curtainwall live-load deflection criteria.

Columns are typically Gr. 50 W14 sections varying from W14 x 257 at the base of

Window Wall/Curtain Wall Mockup Testing



- Testing Facility is 45-foot high by 70-foot long; 300 psf loading capacity.
- Per ASTM and AAMA Specifications.
- Computer aided data acquisition with instant deflection readings +/- .001 inch.
- Dynamic Tests using 2000 HP Aircraft Engine w/13.5 foot propeller.

Wilshire/Westwood, Los Angeles
Granite and Aluminum/Glass Window Wall Mockup ready for Dynamic Water Infiltration Test.

SMITH-EMERY COMPANY

The Full Service Independent Testing Laboratory, Established 1904
781 East Washington Blvd., Los Angeles, California 90021
213/749-3411 • Fax 213/746-7228



the building to W14 x 43 at the top. Columns were designed for gravity loads only, thereby simplifying column splice design and details, and minimizing the section sizes required. Base plates, shop-welded to base tier columns, ranged in size up to 25½ in. x 25½ in. x 3¼ in. thick.

Framing transitions at the top of the building, necessary to creating the desired stepped profile, required a number of column transfers at the lower penthouse floor level (14). These were accomplished by using rolled sections up to W33 depths with Gr. 50 steel, as required. To avoid interferences these deeper sections would have created with the mechanical and electrical systems within the tenant ceiling space in the level below, the floor-to-floor height was increased 12 in. between Levels 13 and 14.

Screen walls at the top of the building used to shield rooftop mechanical equipment and create the stepped profile are laterally supported by cantilevering the uppermost tier of perimeter columns up past the roof slab. Curtainwall stiffness criteria for these cantilevered columns was

met by installing shop-welded cover plates to the column flanges and W8 diagonal braces inside the building from the column flange to the underside of inframing roof beams. These braces engaged the stiffness of roof beam members from inside the building allowing for a rooftop mechanical space unencumbered by diagonal braces.

The completed building represents a good example of well-integrated architecture and engineering. Characterized by efficient design and a thorough sensitivity to the developer's goals, the structural system of Minnesota Center received a 1988 Grand Award from the Minnesota Consulting Engineers Council. To date, the project has been an unqualified success for the developer, meeting both aesthetic and budgetary expectations and offering a competitive advantage in a very tight leasing market. For the community in which it is located, the building has become an image-defining structure that represents a sense of architectural elegance and sophisticated suburban planning. □

Architect/Engineer

Hammel Green and Abrahamson, Inc.
Minneapolis, Minnesota

General Contractor

Bor-Son Construction
Minneapolis, Minnesota

Steel Fabricator

L. L. LeJeune Company
Minneapolis, Minnesota

Steel Erector

L. H. Sowles Co.
Minneapolis, Minnesota

Owner/Developer

Homart Development Co.
Chicago, Illinois

David J. Galey is associate vice president, Hammel, Green & Abrahamson, Inc. architects and engineers, Minneapolis, Minnesota.

FIRST. LAST. ALWAYS.

We created the *first* name in computer aided steel detailing — SDS/2. The *last* system you will ever need to buy. Because we are *always* enhancing our software to achieve unsurpassed efficiencies. More structural steel is detailed by SDS/2 than with any other computer aided system.

First. Last. Always. SDS/2.

**DESIGN
DATA** 

"Software For The Professional"
800-443-0782

It's Time...

IT IS FUN TO
**DESIGN STEEL
CONNECTIONS**

USING

DESCON

AN EASY TO USE SOFTWARE PACKAGE
FOR YOUR PC

25 TYPES OF BEAM TO COLUMN
CONNECTIONS, BEAM SPLICES AND
BEAM TO GIRDER CONNECTIONS

MOMENT CONNECTIONS
SHEAR CONNECTIONS
BOLTED AND WELDED

EXTENSIVE DATA BASE OF SHAPES,
MATERIAL PROPERTIES AND
SPECIFICATION REQUIREMENTS
INCLUDED

FOR INFORMATION CALL OR WRITE TO:

OMNITECH ASSOCIATES
P.O. BOX 7581
BERKELEY, CA 94707
(415) 528-8328

**Structural Engineering
Software For Your IBM
Personal Computer or
Compatible...**



Structural Analysis/Design

Frame/Truss/Continuous Beam Analysis
(Includes Shearwall Frame Interaction)

.....	\$435.00
Load Analysis Program	\$275.00
Moving Load Analysis	\$450.00
Concrete Beam Design	\$175.00
PCSAP (3-D Frame /Truss)	\$200.00
Retaining Wall	\$275.00
Concrete Spread Footing	\$250.00
Pile Group	\$150.00
Shear Wall	\$275.00

**ENGINEERING SOFTWARE
SERVICES, INC.**

978 Douglas Avenue, Suite 104
Altamonte Springs, Florida 32714
Call Our Hotline 1-800-257-8087
Florida Residents 305-862-7755

Steel Notes

**THREE SCHOLARSHIP
WINNERS NAMED**

Winners have been named for the AISC/Klingelhofer Scholarship, the Stupp Bros. Bridge & Iron Co. Scholarship and the AISC/USS Scholarship.

Thomas E. Conneen, a student at the University of New Hampshire, was awarded the \$5,000 AISC/Klingelhofer Scholarship. Conneen expects to receive his Bachelor of Science degree in civil engineering (structures option) in May 1989.

The AISC/Klingelhofer Scholarship Award was offered to undergraduates in civil or architectural engineering schools in the New England states except Massachusetts. The Klingelhofer Memorial was established to provide financial support for those students, thus benefiting the steel fabrication industry.

Arizona State University student, Brian von Allworden was selected to receive the \$5,000 Stupp Brothers Scholarship. He plans to obtain his Bachelor of Science degree in civil engineering in December 1988. He hopes to pursue a Master of Science degree focusing on the design of steel domes so that they are self-supporting during construction. The Stupp Brothers Scholarship Award was available in the states of Nevada, Arizona, Alaska and non-urban areas of California.

Steven J. Barz of the University of North Carolina, Charlotte, was named winner of the \$5,000 AISC/USS Scholarship. Barz will study bolt-nut interaction in fasteners and expects to receive his Master of Science degree in December 1988. The AISC/USS Scholarship was offered in Tennessee, North and South Carolina schools.

All three annual scholarships were offered by the AISC Education Foundation. Next year, the AISC/Klingelhofer Scholarship will be available to schools in the Los Angeles area. The Stupp Brothers Scholarship will be offered to schools in Ohio. The AISC/USS Scholarship will be available to schools in the New York City area and New Jersey.

**NORTHEAST ACCEPTING
LRFD SPECIFICATION**

Following the first acceptance of the new AISC *Load and Resistance Factor Design Specification for Structural Steel Buildings* by members of the Building Officials and Code Administrators International in June 1986 for inclusion in the 1987 *BOCA National Building Code*, regulatory bodies in the northeast U.S. continue to accept the new design approach.

- New Jersey—adopted in April 1987
- New York City—adopted in July 1987
- Philadelphia—adopted in September 1987
- Massachusetts—adopted in January 1988
- Rhode Island—adopted in April 1988
- Virginia—adopted in April 1988
- New York State Fire Prevention and Building Code Council—adopted April 1988

Acceptance by the remaining northeastern states is expected shortly. Additional information about steel specification adoption in the northeastern U.S. can be obtained from Daniel M. McGee, regional director of construction codes and standards, American Iron and Steel Institute, P.O. Box 311, Matawan, NJ 07747; 201/583-5700.

**NUMBER OF AISC-CERTIFIED
PLANTS GROWS**

The number of structural steel fabricating plants achieving AISC certification continues to grow to an all-time high. Currently, 188 plants, representing 157 companies—107 of which are AISC members—are certified under the AISC program. Four applications await inspection.

The purpose of the AISC Quality Certification Program is to confirm to the construction industry that a certified structural steel fabricating plant has the personnel, organization, experience, procedures, knowledge, equipment, capability and commitment to produce fabricated steel of the re-

(continued on p. 34)

Creative Engineering

NASHVILLE METRO AIRPORT

A Cascade of Steel

by Dr. Stanley D. Lindsey and Jack Horner



The new Nashville Airport Terminal serves as a much-needed replacement facility for the rapidly growing Nashville-area.

State-of-the-art design allows operations convenience and passenger flow to work at an optimum within an aesthetically pleasing architectural environment. The complex, built on the opposite side of the runways, more than doubles the flight capacity of the older terminal.

The terminal building, a 350,000-sq. ft steel-framed building, has independent floor levels for service, baggage and ticketing. The floor system is composed of composite steel beams and lightweight structural concrete. The large open bays

prompted the use of extra concrete thickness for floor vibration damping to eliminate the perceptibility of the foot traffic vibrations.

The 3,500 lin. ft of runway concourses are also steel-framed, composite floor systems supported with a series of two- and three-bay rigid frames. At the center of the south concourses is a six-story service hub tower for American Airlines, complete with Admiral's Club and ground support control tower.

Dominant Aesthetic Feature

The dominant aesthetic feature of the terminal building is the sloping glass skylight roof spanning the ticket lobby. Architectur-

al requirements dictated the use of an exposed, three-dimensional pipe truss as the main element to span the distance. The trusses, made from A36 pipe, were also to cascade and slope to match the three different roof elevations. A cross section through the truss reveals a triangular pattern with two top chords and one bottom chord, with web members in each of the three planes.

The spans were either 48 ft-6 in. or 73 ft with the bay spacings 20 ft, 30 ft or 36 ft. The wide-flange roof purlins match the truss panel points and connect to the top chords. The purlins supported a roof deck, roofing and ceiling in the flat areas of the trusses, while skylight framing was

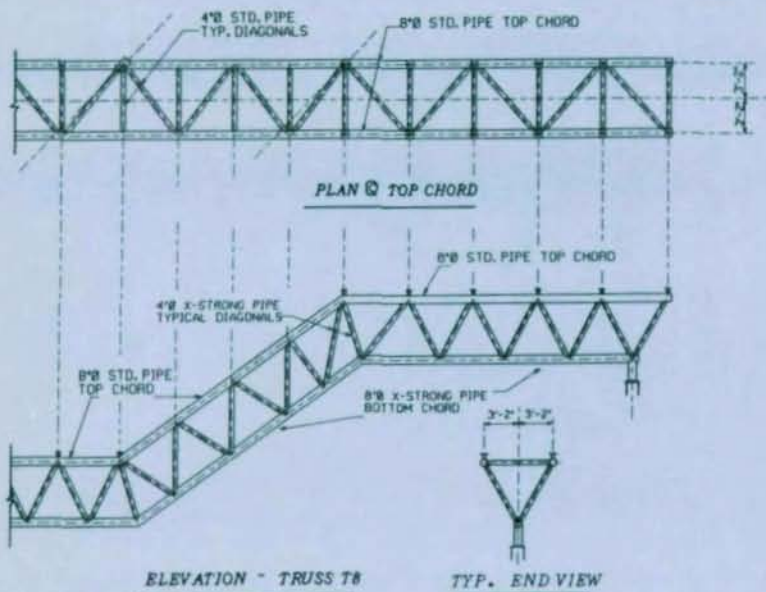

Partial section of trusses (1).

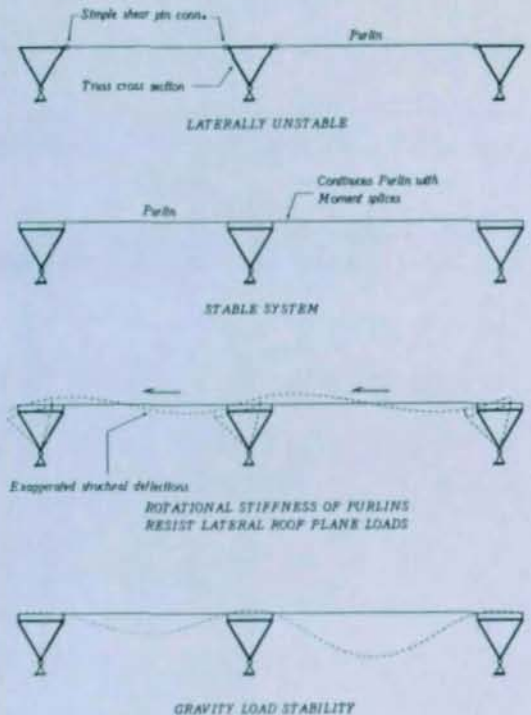

If purlins made simple pin-shear connection to both top chords, system would be unstable.

21 Years of Software Development & Support.....

\$49.00
MONTHLY SOFTWARE SPECIALS

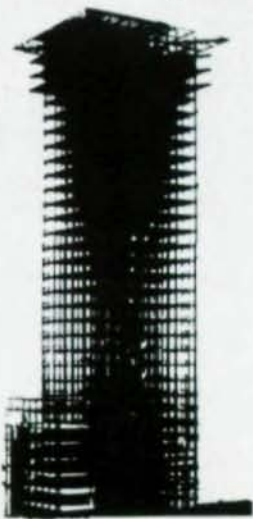

Buy ALL Your Software from the Professionals.

- * general structural analysis
- * concrete beam, column, slab, shearwall and frame design
- * post-tensioned frame design
- * steel beam, column, truss and frame design
- * foundation and timber analysis and design
- * CAD software and details
- * Job costing and billing software
- * Macintosh software now available!

YES! Please send more information.

NAME: _____ COMPANY: _____
STREET ADDRESS: _____
ZIP: _____ PHONE: () _____

SAI 21 YEARS IN ENGINEERING SOFTWARE
Structural Analysis, Inc.

301 W. Camino Gardens Blvd., Boca Raton, FL 33432 (407) 392-6597

employed over the sloping faces. To further complicate the problem, the trusses were to bear on the bottom chord and in some instances, beyond the cantilever. The bearing was to appear to be perched on top of a concrete column as if to be a single-point, pin-type connection. There was to be no truss bridging. Three-dimensional models were generated on a VAX 11/780 Intergraph CAD system of all the different truss elements. Visual graphic representation was performed with surfacing and hidden line removal to observe for data integrity.

Engineering Complicated

Existing in-house, three-dimensional analysis software was modified to add a module for member sizing for pipe elements. The vertical load stress analysis was straightforward, but the bracing and stability of the trusses required a more-than-meets-the-eye type of an investigation.

Normally, it might be considered that purlins or bridging might brace the trusses. Not so in this case. For all practical purposes, the small, bottom-chord bearing offered little or no rotational stability for erection or final position. Further, since the loads came into both of the top chords, the uneven bay spacings generated differential loadings on each side of the truss which resulted in a net rotational torque on

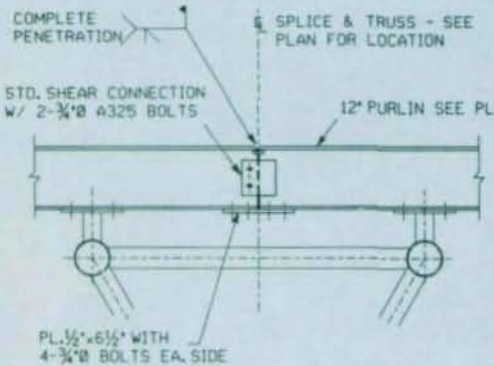

Typical purlin splice over truss

Ticket lobby with sloping skylight roof features exposed three-dimensional pipe trusses.



You
can't
get
heat
treated
plate
any
longer.

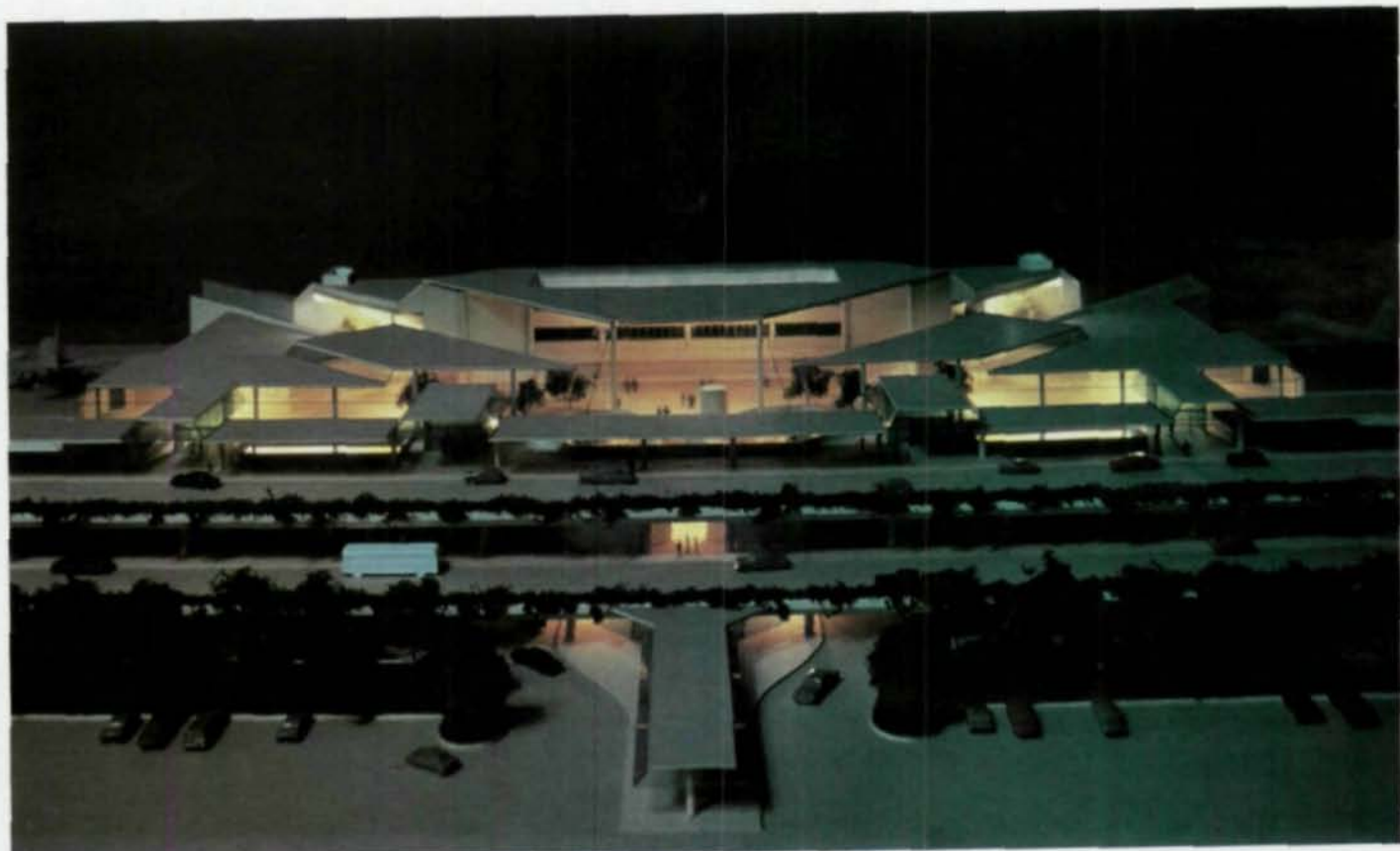

Model of totally new Nashville Metro Airport

T.S.[®] Bolts & Tools

I.C.B.O. Listed
Full range of certified A325 and A490 bolts and complete complement of tools for installation, including "Tone" tools and the new TSW 60LC high speed, swivel head tool.



FULL 360
ROTATION

NEWEST OF
FULL LINE
OF LIGHT
WEIGHT
TOOLS

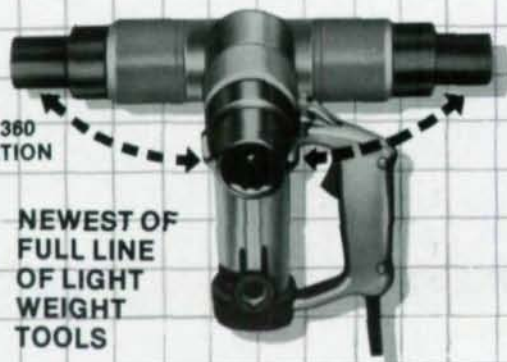

BRISTOL[®] MACHINE COMPANY
cfs Construction Fastener
Systems Division

630 E. Lambert Road, Brea, CA 92621 • 714-990-6555
WATS 1-800-872-6587



Interior view of stair-step trusses in airport atrium

the system. If the purlin connection beared on the centerline of truss cross section, the truss could still rotate. If the purlins made a simple pin shear connection to both of the top chords, the system would also be unstable.

To insure a resistance to rotation and a stable situation, purlins ran continuous over both of the top chords and were spliced with moment connections (see figure). Then, the rotational stiffness of the purlins prevented the truss from rolling over. In the computer analysis the purlins were modeled along with the truss so the additional stability moment could be determined for the purlins. The roof loads were applied directly to the purlins. See the three-dimensional screen display of one of the truss and purlin models. The three chords of the truss were at vertices of a 60° triangle, with the c. to c. of 6 ft or 4 ft, depending on the span. The chord sections were 6 in. to 8 in. in diameter and the diagonals placed in each of the three planes were smaller than the chords to facilitate welding. Work points were permitted in certain kinked areas to be moved to eliminate overlap on the diagonals.

All T, K and Y diagonal pipe connections were made with complete penetration, pre-qualified joint welding details according to the American Welding Society Sect.

(continued on p. 20)

Or heavier.

Only Lukens offers heat treated plate that's as long as 890"—or that weighs 50 tons. We can also supply widths to 195". So the easiest way to fill your tall orders is to contact the Plate Products Division, Lukens Steel, Coatesville, PA 19320. (215) 383-2452

Lukens Steel
The specialist in plate steels.

SOME OF NORTHERN STATE AREN'T IN IT

191' super long span joists, 120" deep, reach across the Joseph H. Barnett Physical Education Complex and Convention Center.

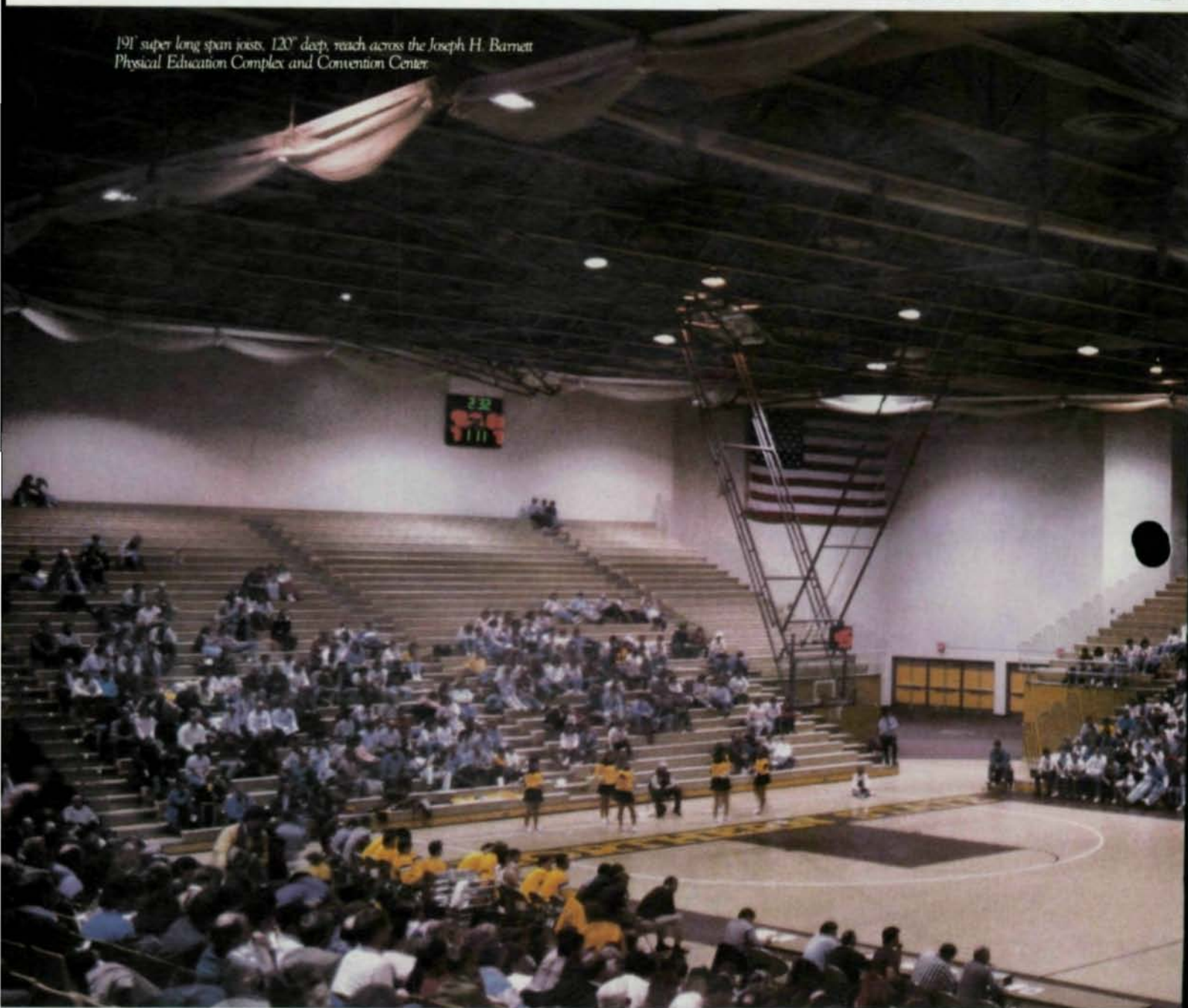

The supporters are the super long span Vulcraft joists high above the floor of the Northern State College Barnett Center in Aberdeen, South Dakota. And super long isn't all they are. They're also super strong.

The architect first considered a space frame type of structure. But he chose super long span joists because he was impressed by what he had seen on other Vulcraft jobs. Impressed with the strength of the joists,

Impressed with the aesthetics. Impressed with Vulcraft's design experience. Impressed with the ease of construction. And impressed, too, with the low cost.

The joists for the Barnett Center are 191 feet long and they arrived in three pieces at the job site and were simply bolted together. Which made it a very fast and simple method of doing things.

And Vulcraft helped keep the job on track by

007-1

THE BIGGEST SUPPORTERS THE STANDS.



making sure that the materials arrived on site exactly when they were scheduled. And that includes the almost 99,000 square feet of steel deck we supplied too.

So if you're into dynamic designs, now you know where you can find easy to install super long span joists that will fit right into your game plan. Contact your nearest Vulcraft plant or take a look at Sweet's 05100/VUL and 05300/VUL product review.

VULCRAFT

A Division of Nucor Corporation

PO Box 637, Brigham City, UT 84302 801/734-9433; *PO Box F-2, Florence, SC 29502 803/662-0381; PO Box 169, Fort Payne, AL 35967 205/845-2460; *PO Box 186, Grapeland, TX 75844 409/687-4665; *PO Box 59, Norfolk, NE 68701 402/644-8500; *PO Box 1000, St. Joe, IN 46785 219/337-5411. * Deck manufacturing locations. Architect/Engineers: Spitznagel, Inc., and Henges-Kirchgasler-Geisler & Associates; General Contractors: Kyburz-Carlson Construction, Inc.; Construction Managers: The Christensen Corporation; Steel Fabricator: Mid-America Steel, Inc.



**ARBED'S
NEW EXPANDED
RANGE OF ROLLED
WF & WTM BEAMS
KEEP
QUALITY
HIGH,
COSTS LOW.**

Arbed's rolled **40" beams**, available in 16 sections from 149 to 328 lbs., has now been expanded to include our new rolled **44" beams**, available in 4 sections from 198 to 245 lbs. They all offer the same benefits we're famous for: high section moduli, great lateral buckling resistance, and the ability to compete economically with both fabricated sections, as well as reinforced precast and prestressed concrete.

Arbed's rolled "**Tailor-Made**" series (up to 42.45" x 18.13" x 848 lbs) . . . lets you specify the beam weight you need, other than what is normally available. Result? Big savings in fabrication costs *and* weight.

Get all the facts now . . . send the coupon for information including complete specifications.

TradeARBED, Inc., 825 Third Ave.,
24th floor, New York, NY 10022.
(212) 486-9890,
FAX: 212-355-2159/2421.
Dom. TX: (W.V.) 125 159,
Int'l TX: (ITT) 421-180.

In Canada: TradeARBED Canada,
Inc. 3340 Mainway, Burlington,
Ontario, Canada L7M 1A7
(416) 335-5710,
FAX: (416) 335-1292, TX: 0618258.

Please send me the NEW literature
on ARBED's 40", 44" and
"TAILOR-MADE" rolled beams.

Name _____ Title _____
Firm _____
Address _____
City _____
State _____ Zip _____

TRADE ARBED Inc.
INNOVATORS OF STEEL CONSTRUCTION PRODUCTS

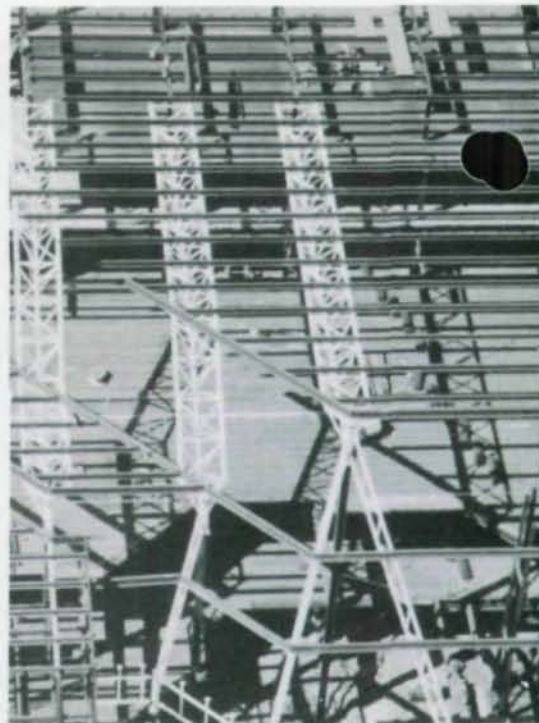

Photo of truss under construction

10.13. All shop and field butt splices were single-bevel, complete-penetration groove welds with backup rings.

Total structure steel tonnage for the concourses was 2,230 tons. The terminal building contained 2,205 tons of structural trusses, 202 tons of which were atrium trusses. The truss weights were approximately 10 psf of roof area. □

Architects

Robert Lambert Hart
New York, New York, and
Gresham & Smith & Partners
Nashville, Tennessee

Structural Engineer

Lindsey & Associates
Nashville, Tennessee

Construction Manager

Turner Construction Company
Nashville, Tennessee

Steel Fabricators

Fisher Steel (terminal & pipe trusses)
Memphis, Tennessee, and
Kingston Steel (concourses)
Nashville, Tennessee

Owner

City of Nashville

Stanley D. Lindsey, Ph.D., is founder and president of Lindsey and Associates, Nashville, Tennessee.

Jack R. Horner is vice president of Lindsey and Associates, Nashville, Tennessee.

Restoring a Landmark

RIVERSIDE VIADUCT

Re-creating an Original



Planning an accurate restoration of an ornate, turn-of-the-century, iron and steel highway structure is not a routine professional assignment. This is particularly true when the structure is a heavily traveled, 2,100-ft viaduct from West 125th Street to West 135th Street on New York City's Riverside Drive. The complexity of the undertaking required a wide range of engineering competence and the distinctive capability of re-creating the original structural concept.

In the last decades of the 19th century, Riverside Drive was created within Riverside Park by the preeminent landscape architect, Frederick Law Olmstead. While Olmstead's plan for the drive terminated at the bluffs

overlooking West 125th Street, the entire park roadway eventually extended from its starting point at West 72nd Street to Manhattan's north end, where it met Spuyten Duyvil Creek. Begun in 1870, the drive was completed in 1920. A key link on the roadway was the visually dramatic elevated portion, 60-80 ft above 12th Avenue, known as The Riverside Drive Viaduct.

The viaduct's Victorian-age engineering planners and designers were F. Stuart Williamson and John W. Ripley, his principal assistant engineer. Their designs were approved in December 1897 and the viaduct was completed and opened to traffic in the fall of 1900. It served the city for over eight

decades—during which time it has been able to support significant traffic growth.

Typical span construction consists of four steel-laced columns (two at each end, shared with adjacent spans) connected with transverse and longitudinal latticed arches. Spanning between columns, across the tops of the longitudinal arches, are 5-ft deep box girders supporting transverse floor beams. Originally, the transverse beams supported longitudinal stringers which carried a steel buckle plate and asphalt deck. Sidewalks, supported by steel brackets, cantilever from the box girders on both sides of the viaduct and an ornamental railing of wrought iron with cast iron posts provided security for pedestrians. Gas



Ornate Riverside Drive Viaduct remodeled dramatically for safety and aesthetics.

necessary to develop its rebuilding with careful reflection of the original architectural design in order to maintain the circa-1900 ornate iron and riveted steel image.

Working closely with the New York State Office of Parks, Recreation and Historic Preservation, "in-kind" rehabilitation was designed with close attention to means to maintain the structure's historic character. Within current design and safety code requirements, the structure's exposed elements were replicated as closely as possible. Bolted fabrication was chosen for the replacements to maintain, as closely as possible, the appearance and details of the original riveted structure. Salvageable wrought and cast iron elements were refurbished and re-used where these mementos of a by-gone era had widest public exposure. Also, the conclusion was that, in the interests of safety and economy, total replacement of all structural elements was necessary.

This notable landmark—a compelling structure of 19th-century engineering and construction—was totally restored and re-opened to 20th-century traffic in June 1987.

□

PRODUCTIVITY-PROFITABILITY?
It's All Here in Black and White

- STRESS Plus
- Bridge Designer
- Structural Steel Detailing and Scheduling (SSDS)
- Reinforced Concrete Detailing and Scheduling (RCDS)

CIVILSOFT has been an Industry leader since 1976 in providing high quality design and analysis software for the professional engineer.

Call us and find out why over 7,000 of your fellow engineers have put their trust in CIVILSOFT products.

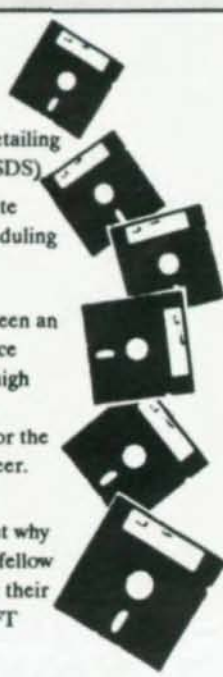

CIVILSOFT®

1592 N. Batavia St., Suite 1A, Orange, California 92667
(714) 974-1864 Telex 265111 TTGI UR

lights, later converted to electric, were installed on the railing at each column line.

Despite normal maintenance, recent years witnessed the need for an increasing number of repairs and rehabilitation efforts, and the seriousness of the rapidly accelerating deterioration of the structure was intensified by the viaduct's role as:

1. A structure that was officially declared historically significant by the New York State Historic Preservation Officer;
2. A critically important traffic link on an arterial parkway serving an average of over 14,000 vehicles daily; and
3. The sole vehicular access to a large high-rise apartment complex at West 134th Street.

The prospective loss of the viaduct's functionally useful and safe life for the motoring public, and the total loss of a unique Victorian image, became of great concern. Analysis of recent indepth inspections showed that limited repair programs could neither alleviate nor correct basic problems, but that extensive restoration and possibly a total replacement would be needed.

Restoring this historic viaduct to its role as a safe and vital part of the city's transportation network was, of course, the primary mission. However, since the structure had received landmark recognition, it was also

Designer

Goodkind & O'Dea, Inc.
New York, New York

Consulting Engineer

Omni Engineering
New York, New York

General Contractor (joint venture)

Yonkers Contracting and
Argrett Enterprises
New York, New York

Steel Erector

American Bridge
Pittsburgh, Pennsylvania

Owner

City of New York DOT

HOUSE ON THE ROCK

Steel—from Here to Infinity

by Rolf T. Killingstad



Air view of Infinity Room. Rock outcrop (c.) supports 140-ft cantilever over valley.

The Infinity Room is one of the more spectacular displays at the unique House on the Rock, at Spring Green, Wisc., in the rough and tumble Wyoming Valley of Iowa County. The topography consists of rock outcrops, steep slopes and hardwood forests punctuated by occasional flat, fertile valleys and rolling uplands.

The original House was built on a vertical rock outcrop, projecting some 30 ft

above the top of a steep-sided hill. It has grown to incorporate three floors of unusual construction, topped by a deck with a magnificent view of the valley. Alex Jordan, the owner, creator and artist of the facility, conceived the idea of the Infinity Room, which projects from the first level of the House across a second rock outcrop about 50 ft away and then cantilevers for 140 ft over the valley. The free end is about 165 ft above ground. Visitors stroll into the

Infinity Room and enjoy the sensation of walking down a space tunnel.

The room, triangular in plan, has a base at the House about 23 ft wide and a length of 200 ft. In section, the room is pentagonal, with a horizontal floor, outward sloping walls and a pitched roof. The height of the room at the house, the largest cross section, is about 16 ft to the ridge. The ridge slopes down and meets the floor at the apex of the triangle so that, on entering,



Tube of wide-flange sections carry cantilever moments of dramatic Infinity Room (above and r.).

the visitor has the visual sense that the room goes on forever.

Design

The structure was conceived as a tube of wide-flange sections carrying the cantilever moments, with sloping, trussed sides supporting the vertical shear loads. Bay spacing is 10 ft. At each bay, a rigid pentagon frame is provided to help resist torsional forces. The base of the structure is anchored to the house rock outcrop (main rock) with epoxy-set expansion bolts. The

rock outcrop (secondary rock) over which the structure cantilevers was prepared by pouring a concrete cap to provide a flat base to support the frames and beams. The floor, from this support back to the house rock, was filled with 12 in. of concrete to act as ballast. The tube is designed using 20-ft long W12x19 sections. The number of wide-flange sections increases and decreases to match the moment envelope, and all splices and connections are welded.

In addition to their being tube members,

W12x19 sections form the top and bottom chords of the sloped trusses. Where required, the W12x19s are doubled to provide additional chord capacity. The diagonals are all positioned to be in tension and are fabricated from tubes and double- and single-channels, as required for strength. The pentagonal frames at each bay use a variety of steel shapes, including structural tubes, wide-flange and angle sections. The sizes vary from lighter at the apex end to heavy at the supports. Connections are moment resisting. These

Learn FEA in about 25 minutes. For \$25!

Elm™ is the graphic, interactive software that *automates* finite element analysis. All you do is draw the structure and specify beams from the built-in AISC library. Your PC automatically generates displacements and stresses. Results appear on the screen overlaid on your

original model. It's fast, easy and efficient, even if you have no formal FEA training. See for yourself. Order the Elm "hands-on" demonstration disk with full documentation. It runs on any PC with EGA graphics, Microsoft® mouse and math co-processor. Just send a check, including applicable state sales tax. Or call 800-233-1798.

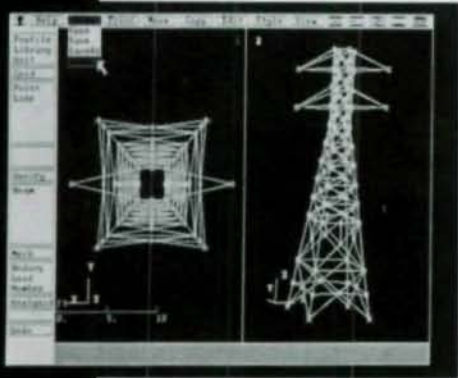

Elm™
Stressless Analysis

FUJITSU

Fujitsu America Inc., Information Systems Division
3055 Orchard Drive, San Jose, CA 95134-2017 • (415) 432-1300 ext. 5043

Elm is a trademark of Fujitsu America. Microsoft is a registered trademark of Microsoft Inc. ©1988 Fujitsu America. All rights reserved.



frames provided torsional stiffness and help to transfer lateral forces to the rock foundations where they can be removed.

The roof, a light-gauge steel roofdeck such as used in the metal building industry, is fastened to the structure by self-drilling screws. The floor beyond the point of cantilever is $\frac{3}{4}$ -in. plywood deck fastened to the beam flanges with self-drilling screws. The walls, infilled in the plane of the truss, are made of 1 in. x 4 in. wood mullions screwed to the steel structure and spaced about 1 ft o.c., with 1-in. x 4-

in. wood horizontal muntins spaced about 1 ft o.c. The wall is completed with panes of glass or plastic placed in the spaces with 1-in. x 1-in. wood glazing beads. The window panes, from floor to roof, present a grand view.

Construction

The site has no access by road or a space where crane or other equipment could work or area for storage of fabricated material. The owner permitted a very primitive road to be bulldozed part way up the hill,

allowing materials to be brought near enough to snake and hoist the rest of the way by cable. All fabrication was done at the site, using torch, hand grinder and electric arc welder.

The structure was begun by constructing a level concrete platform on the smaller support rock near the House rock. A steel crib was bolted to the rock and forms constructed to contain concrete which was pumped in place from the base of the hill. Lifting of materials was accomplished with a stiffleg made of wood timbers and

**WE
PUT
100
YEARS
OF
EXPERIENCE
IN
EVERY
BOLT WE MAKE**



ST. LOUIS SCREW & BOLT COMPANY

At St. Louis Screw & Bolt, we make a FULL range of structural fasteners. We produce Types I & III A-325 bolts, ASTM A-307 bolts, and have the capability to manufacture fasteners to YOUR specifications. Our products are made from American steel and tested in our plant to meet ASTM standards, with certification upon request.

**FOR ALL YOUR STRUCTURAL
FASTENER NEEDS, SPECIFY
ST. LOUIS.**

ST. LOUIS SCREW & BOLT COMPANY

6901 N. Broadway/St. Louis, MO 63147/(314) 389-7500



SINCE 1887



FAX, (314) 389-7510
Toll Free, 1-800-237-7059



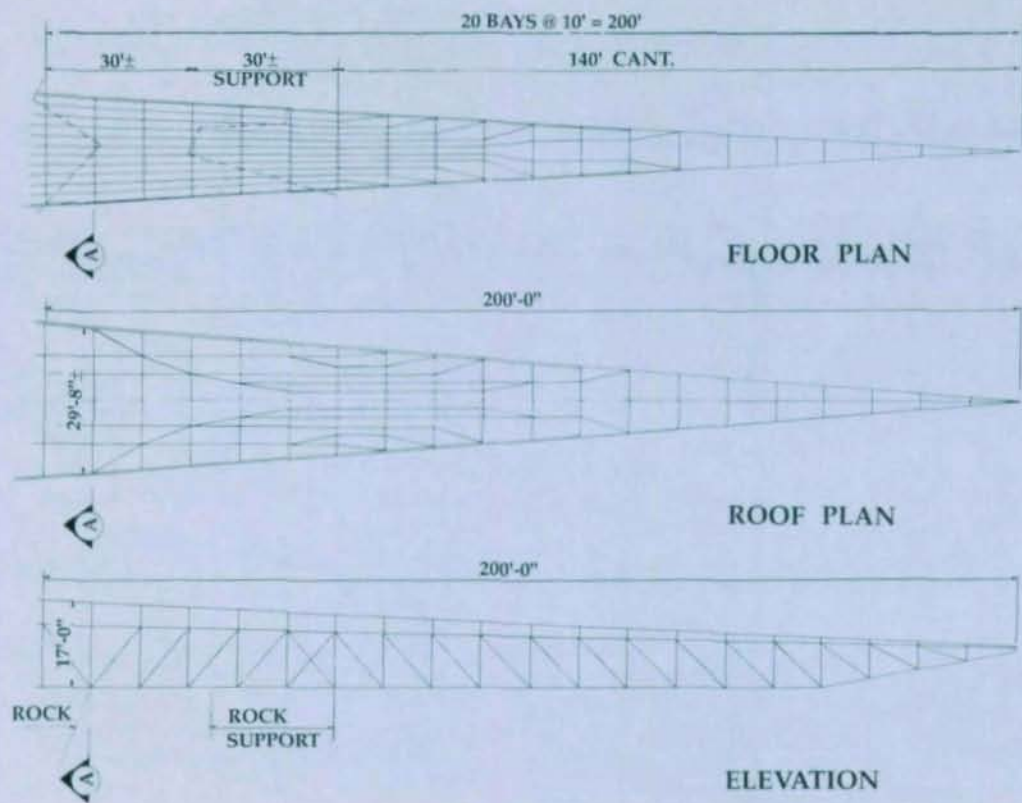

Floor and roof plans and elevation of Infinity Room

Warning: This product is implicated in increasing profits.

TransCalc lets you develop any of these in 15 seconds.

TransCalc software accepts foot-inch-fraction input and prints layout instructions. For these and many other shapes. Using IBM PC or compatible computers. DXF and CNC interfaces available.

Structural Software Company
 Dept. MSC40
 PO Box 19220
 Roanoke, VA 24019
 (703)362-9118

\$695

powered by hand, and later a fractional horsepower electrical motor.

With the platform complete, a temporary shore was set up between the main and secondary rocks. Beams were then extended between the two rocks to which they were anchored. These beams provided the floor of the structure. After metal deck was installed on the bottom flange, the space between the beams was pumped full of concrete to provide ballast for future construction. The W12x19 beams are spaced approximately 2 ft o.c. and the clear span varies from 10 to 20 ft. About 54 yds. of concrete were used to fill the 1-ft deep space between top and bottom flanges.

Out into Space

Next, the frames were installed at the panel points. Truss members were placed between the frames and the roof steel erected. Now, with the structure firmly anchored to the rock, the construction of the cantilever could begin.

All fabrication of materials was done on the platform formed by this first section between the rocks, with most material lifted up in 20-ft lengths. Cutting, coping and fitting was done with cutting torch and grinder. A small, portable stiffleg was used to place the smaller members and a larger, moveable stiffleg was moved bay by bay on the end of the cantilever to place

the wide-flange longitudinal members. The trussed exterior walls were placed first by extending the bottom chord member with the first diagonal attached and connecting at the panel points. Then the first vertical and top chord were placed. Finally, the second diagonal and vertical. The structure advanced 20 ft at a time, or two bays. A temporary support was placed at the far end and floor beams placed. Next, bottom cross members were welded in position. Finally, a temporary support was positioned to receive the longitudinal roof members and transverse members were installed to complete the frames. This sequence of operations was repeated until the structure was complete.

The design drawings provided dimensions locating working points at the top centerline of all longitudinal members. Field fabrication was accomplished using these dimensions. Additionally, deflection calculations were made to determine the cumulative deflection at each bay as construction proceeded. Camber was built into the structure so the floor will be level when the structure supports full live load.

A fixed base was welded to the structure on the centerline at frame line A to support a builder's transit used to survey in all members. An interesting phenomenon was observed as construction proceeded. The axis of the structure is generally north and south with the supported end to the south. As the morning sun heated the red steel, the eastern steel expanded, moving the cantilever end west. As the sun moved to the noon sky, the top steel expanded, moving the end down. Finally, the western sun moved the end back east. This precipitated confusion until the situation was understood by the erectors. These movements were incorporated into the positioning of members. Cross bracing of 2-in. x 1/2-in. strap was placed in all roof bays and in the floor bays beyond the concrete portion.

A safety net was advanced under the structure to provide security for the crew. Since the construction was over a heavily wooded area, fire from welding was always a threat. Every evening after work stopped, a sprinkler was turned on to wet down the trees and ground under the structure to prevent fire.

The structure was topped out when the traditional evergreen and American flag was mounted on the last member. When the frame was completed, a test

load of 2,000 lbs. was lifted off the end and a deflection of 3/8 in. recorded.

The structure was completed by placing the plywood floor with self-drilling screws. The roof incorporates an overhang of 3 ft. Steel tube (TS4x2) outriggers were placed at 2 ft o.c., with an eave girt between the outriggers. Finally, the steel roof deck was screwed to the longitudinal roof steel and the walls completed as previously described.

The inside is decorated with a carpet floor and carpet ceiling, which exposes the roof structure. Living plants are hung overhead and placed in pots on the floor. The visitors took down the Infinity Room

which seems to go on and on, gaze out over the beautiful Wyoming Valley and sometimes feel the minute movements caused by the wind blowing against the structure. □

Architect/Structural Engineer

Rolf T. Killingstad
Madison, Wisconsin

Fabricator/Erector

Nelson Steel Erectors
Madison, Wisconsin

Owner

House on the Rock
Spring Green, Wisconsin

Plattzinc® 85/15 Zinc/Aluminum Metallizing Wire



For Corrosion Protection In Marine & Industrial Environments.

Metallizing structural steel with Plattzinc® 85/15 ensures years of protection in harsh atmospheres. Available for flame spraying equipment in 1/8" or 3/16" diameters in coil or fiber payoffpaks.

- An inorganic coating
- Bonds instantly
- Minimizes out of service losses
- No VOC / No Solvents
- Longer maintenance intervals
- Passive & galvanic protection

For More Information:

Platt Bros. & Co.
P.O. Box 1030
Waterbury, CT 06721
203-753-4194
Telex #64-3340
Fax #203-753-9709



Rolf T. Killingstad, P.E., is associate professor, department of Engineering Professional Development, University of Wisconsin-Madison.

Architectural Sculpting

STAMFORD LANDING

Standard Steel Framing—
but No “Boxes” on the Coastline

by Alex McDonald





A combination of influences brought about the choice of steel framing for a condominium building—the Village of Stamford Landing—overlooking Long Island Sound. The six stories are oriented to enjoy the seascape, with each floor adjusted to provide penthouse quality terraces. These amenities for the residents gave occasion for an architectural sculpturing that pleases and avoids the common appearance of residential warehouses, thinly disguised with bric-a-brac. The architectural control is again exhibited in the individual apartment unit layouts, uncompromised by the demands of the external configuration. Nor was any compromise permitted in the building frame. The structure was required to be cost-competitive and at the same time meet the highest standards for luxury housing. To meet these demands, an open-web joist system was selected. Standard details were improved to insure this lightweight steel framing did not translate into a bouncy floor, sometimes thought to indicate flimsy construction.

The origins of the highly articulated steel framing sprang from a cooperative effort between the developer and the local city planners. Controls were established to assure sight lines from the sea that were both interesting and unique. They would not permit a coastal view of box buildings marching up to the shoreline. Incorporating a marina also did much to soften the picture.

Adversity to Advantage

What might have been seen as an architectural adversity was turned to advantage. The incorporated setbacks developed into the architectural designer's motif. He pressed the permitted envelope to get a 10 ft-8 in. floor-to-floor dimension.

WHO KNOWS MORE ABOUT IMPROVING THE EFFICIENCY OF DRAFTSMEN THAN DRAFTSMEN?



Ex-draftsmen,
Robert Pettitt and
Lawrence Shinkaruk,
creators of the
STEELCAD II
Software Program
for structural
steel detailing.

ALL THE STEEL FABRICATORS WHO'VE TESTED STEELCAD II HAVE ONE THING IN COMMON

THEY BOUGHT IT.

PETTITT LAWRENCE LTD.
STEELCAD II

550 Alden Road, Suite 201
Markham, Ontario L3R 6A8

TELEPHONE (416) 479-0399



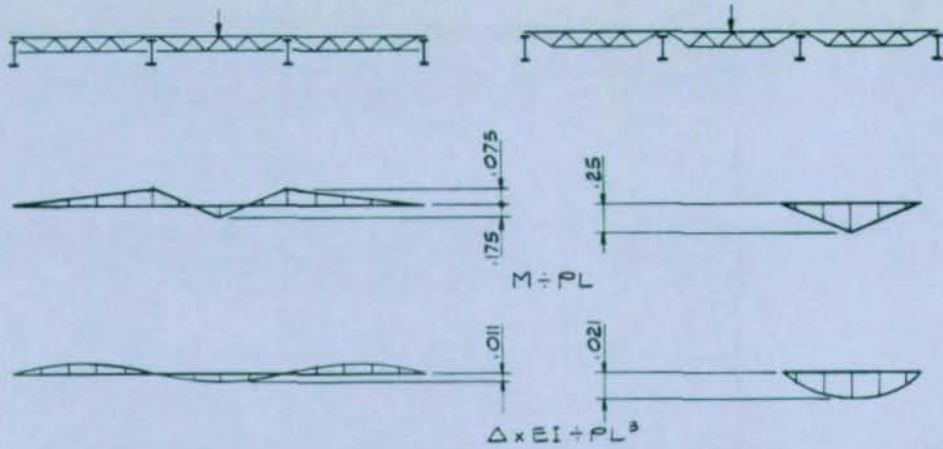

Bending and deflection diagrams for continuous and simple spans

800-331-3002

Custom squares and shapes. Order squares from 12" to 24". Rectangles from 4" X 20" to 24" X 30".

Single lengths from 5' to 40', spliced lengths to 60'. A500 dimensions.

No minimum quantity. Material grades ASTM A36 to A572-50. Contact John Holdon.

FREE CATALOG



Six-story building provides penthouse-quality terraces for owners to enjoy seascape. Steel made it all possible.

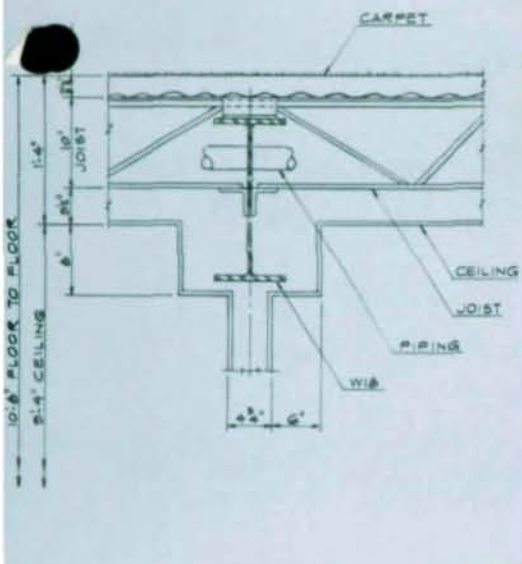

Typical floor construction

Ceilings were specified at 9 ft-4 in. to create an interior appearance of luxury. Consequently, the structural-mechanical sandwich between the ceiling and floor was restricted to 16 inches.

The owner emphasized no personal preference for any particular structural framing system. He did impose restraints on cost and time schedules. To that end, he expressed interest in precast planks and concrete block bearing walls. This inclination was based on observing the prevalence of that system in the local market. Market forces are known to operate and allow only survival of the fittest. This marketing orientation also dictated winter construction. Some in-place construction was needed for spring and summer sales to the sailors on Long Island Sound. Steel construction, if it could meet the price competition, began to suggest itself.

Preliminary framing plans were made for both cast-in-place concrete and structural steel construction. Interestingly, bearing walls and precast concrete were immediately disqualified in the face of the predisposition. That system would not permit large window openings in the end walls for the sea views. Also, it could not contend with the irregularities at the terraces where walls above do not line up with the walls below. Post and beam construction was more amenable. In cast-in-place construction this imposed a cost burden of non reuse of formwork. Added to this, the relatively small area of floor slabs caused crew inefficiency. On the other hand, by placing columns and girders 16 ft apart at the location of the partitions between

It's Here!

NEW

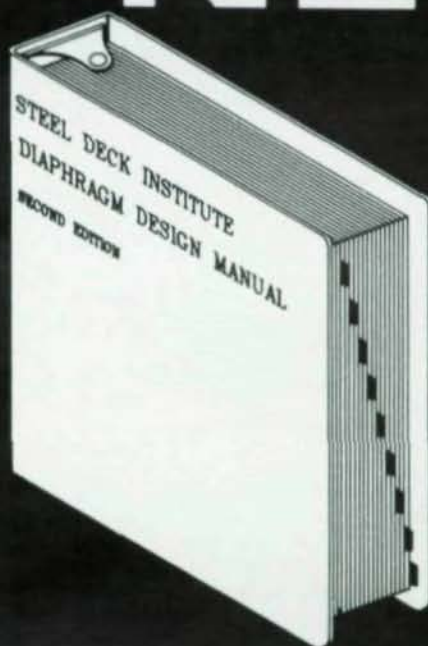

DIAPHRAGM DESIGN MANUAL

SECOND EDITION



**A reference source that contains the answers to all of your questions!
For practicing Engineers & Architects!**

Organized For Easy Use/Explicitly Illustrated

MAJOR ADDITIONS

- Diaphragm Strength
- Diaphragm Stiffness
- Connections
- Concrete Filled Diaphragms
- 62 Pages Filled with Shear Diaphragm Examples
- Complete Guide to Symbols and References
- Complete set of Load Tables for Typical Panel Configurations and Connector Types
- Typical Fastener Layout
- Warping Factor Development
- D-Values for Warping

DON'T DELAY—ORDER YOURS TODAY!

Send checks; postal, world money orders, drafts, in U.S. currency.

QUANTITY

_____ NEW 2ND EDITION DIAPHRAGM DESIGN MANUAL, \$38.00 ea. _____
 _____ 1st Edition Diaphragm Design Manual, \$28.75 ea. _____
 _____ Steel Deck Design Manual, \$9.50 ea. _____

US Currency Total _____

Out of USA surcharge, 10% _____

Add on for Airmail _____

Total Enclosed _____

STEEL DECK INSTITUTE, INC.
 P.O. BOX 9506, CANTON, OHIO 44711 ■ (216) 493-7886

M-STRUDL

The Best Selling
Civil/Structural Program
Since 1987

ANALYSIS

- 2D/3D Frame / Truss / Plate / Shell
- Static / P-Delta / Dynamic / RSA Analysis
- Capable of 1000's of joints and 100's of load cases
- Interactive geometry, deflection, mode shape, plots
- Interactive shear and moment diagram plots
- AISC Library included

DESIGN

- Interactive graphic menu driven design
- Continuous beam, section properties, frequency calculations
- AISC code check and sizing
- ACI column, beam, footing design
- Design details can be output to AUTOCAD
- Excellent in report presentations

GUARANTEE

M-STRUDL is superior in productivity and power. It has extremely flexible input/output options and supports most PC/XT/AT/PS2 hardware.

"JOIN THE WINNING TEAM"

Ask for a brochure today!



P.O. Box 7326
Fremont, CA 94536-7326
(415) 795-0509

SAVE TIME AND MONEY CALCULATE CONNECTIONS with CONNECT® version 3.0

Software and Data Base
for IBM PCs and Compatibles
Proven, easy-to-use, moderate price

DETAILERS, STRUCTURAL ENGINEERS
design, document, check:

Framed Beam Connections
Seated Beam Connections
Eccentric Connections
Connections in Tension
Moment Connections
Hip and Valley Details
Oblique bracing with Setbacks
Web Stiffeners
Triangulation
and more.

Print a hard copy of calculations
and/or save on disk.

Demo package available @ \$12.50.

Write or call today:

Hess Technical Services

2389 Mill Grove Road
Pittsburgh, PA 15241

(412) 831-2010 or (412) 833-7525



Terraced steel frame

rooms, shallow depth joists met the budget and permitted duct runs within the restricted depth of construction (see drawing).

Ceiling-wall intersections were articulated because of the girder depth, but in such a way as to create some architectural interest. The detail was coordinated with a similar concept at the corners of the walls where column sizes intruded into the rooms. Thus, a picture-frame-like molding was made to surround the walls. It remained to verify price estimates which had indicated economy.

Steel framing enjoyed a greater advantage than precast concrete framing: an advantage denied to cast-in-place concrete framing. The off-site fabrication opened competition to a large number of suppliers. The 550-ton project was of interest to a large number of suppliers, which made for a buyer's market. Opposed to that, the concrete framing alternative restricted the job to a small number of qualified local subcontractors—a backlog which produced a seller's market. The distinction in unit pricing found in either a buyer's or a seller's market had a preponderant influence. It was so dominating that preliminary designs and estimates could have been misleading. Such preliminary estimates must always be remembered as preliminary. Finished contract documents cannot be counted as final until preliminary estimates have been confirmed or denied in the marketplace.

Rumors Dispelled

The final problem was the perception of

open-web joists as slender construction. Fear was expressed that prospective buyers might perceive discomfort standing in the middle of a span when foot traffic passed nearby. Any rumors to that effect would compound the problem. Positive and effective steps to overcome this perception were necessary for the design to proceed. The relatively inexpensive remedy of continuity for performance under live loads was chosen. This consisted of specifying joists with bottom chord ceiling extensions to be welded to the girders after the concrete slab had been placed.

Intuitively, it can be seen that deflections will be minimized with continuity. The approach of using static deflections to assess vibrations is consistent with the recommendations of Allen and Rainer¹ who state: "For short-span floors, the persons involved, both the one causing and the one feeling the vibration, interact with the floor to damp out the vibration quickly. For these floors, the motion due to static deflections of the walker has more effect on human response than the transient vibrations in the fundamental mode; static deflection criteria under concentrated load therefore appear to be more appropriate in these cases."

The appropriate concentrated load is taken to be the initial peak of load of 600 lbs. for a heel impact suggested by Lenzen and Murray.² The appropriate section properties are taken to be a composite of joist and concrete slab as suggested by the Steel Joist Institute.³ This produces a calculated deflection of 0.06 in. for simple-span construction and 0.03-in. for multi-

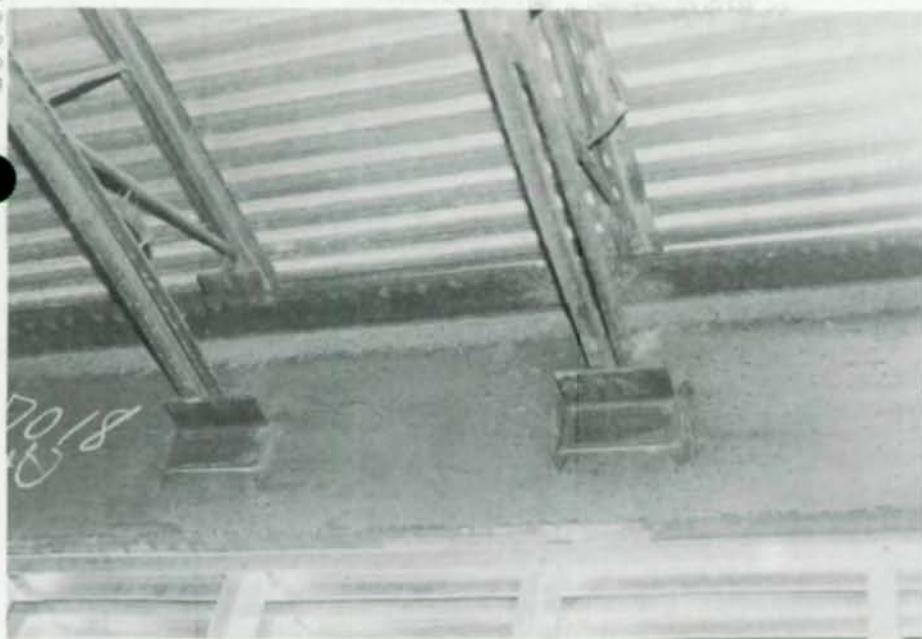

Joist ceiling extensions

ple-span construction. The deflections would be further reduced if the joist-slab floor system is taken to be a two-way plate system with a number of joists effectively participating. This would result in trivial deflections leading to the suspicion of no significant problem. Such was found to be the case. Even prior to the installation of the damping effects of partitions, ceilings and rugs, an exaggerated impact test found no perceptible response in a sensitized observer. Specifically, when an overweight man tried to induce vibrations, an observer who was trying to perceive them found no response. It was concluded that the expedient of reducing static live load deflections in half by inducing continuity was, at minimal cost, good insurance for producing comfortable floors.

It might be noted that, in a conventional dynamic analysis, the increased stiffness of multiple-span construction would tend to increase the natural frequency of the system—and higher frequencies are to be discouraged. However, this is more than compensated for in a conventional analysis which also considers amplitude. In fact, Prof. Murray of the University of Oklahoma considers the product of frequency and amplitude in determining a minimum required damping. The product of frequency and amplitude in the multiple span construction proves to have been improved by 20% and the damping provided by the system is acceptable.

Since topping out, sales of the condominium units have been brisk. Certainly many factors contribute, but it is clear the aura of success tends to justify the choice of a steel framing system. □

References:

1. Allen, D.E. and J. H. Rainer *Vibration Criteria for Long-span Floors Canadian Journal of Civil Engineering*, Vol. 3, No. 2, June 1976.
2. Lenzen, K. H. and T. M. Murray *Vibration of Steel Beam Concrete Slab Floor Systems Report No. 29, University of Kansas, 1969.*
3. *Steel Joist Institute Vibration of Steel Joist-Concrete Slab Floors Technical Digest No. 5.*

Architect

Robert E. Schwartz
Greenwich, Connecticut

Structural Engineer

McDonald & van der Poll
Stamford, Connecticut

Construction Manager

Tishman Construction Company
New York, New York

Steel Fabricators

Post Road Iron Works
Stamford, Connecticut, and
Bennington Iron Works
Bennington, Vermont

Steel Erector

Post Road Iron Works
Stamford, Connecticut

Owner/Developer

Pacific Development Corporation

Alex McDonald, PE., is a principal in the firm of McDonald & van der Poll and a professional member of the AISC.

STRUCTURAL CONSTRUCTION FASTENERS

From foundation to roof Haydon is your one source. Quality bolts to ASTM standards at competitive prices. Direct from the manufacturer.



You name the structural anchor, bolt, nut or rod you need in the size, metal and finish you want. Either we have it in our large inventory, or we can make it for you in a hurry. We've been known for quality and fast service since 1864. And, we'll quote prices and give details right over the phone. Try us. Call:

(215) 537-8700

HAYDON BOLTS, Inc.

Adams Ave. & Unity St.,
Philadelphia, PA 19124



Warning: stand clear of more product going out the door.

StairCalc: lets you figure stairs without staring at figures.

You put in the easy numbers -- such as the length of the base, the distance between the floors, and the number of risers.

StairCalc does the dirty work, and gives you the bevel, slope in degrees, work point to workpoint distance, height of first riser, riser height, tread width, and point-to-point distance of treads. Instantly. And more!

StairCalc runs on MS-DOS computers and can position bolt holes precisely, translating dimensions in vertical coordi-

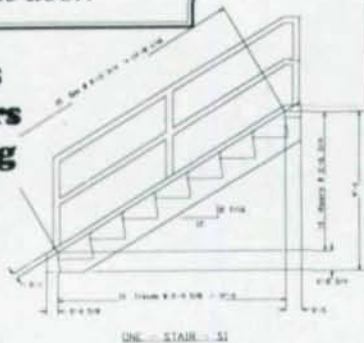

nates into measurements off the face of the stringer. Also calculates the miter bevel, to properly mate stringer to upper and lower beams.

StairCalc uses the same measurements you use -- feet/inch/fractions, inches/fractions, or decimal inches. And, includes a triangle calculator. All for only --

\$199

Structural Software Company
Dept. MSC40
PO Box 19220
Roanoke, VA 24019
(703)362-9118

STEEL NOTES (continued from p. 12)

quired quality for a given category of structural steelwork. The program is open to all structural steel fabricators. For more information on the AISC Quality Certification Program, contact Charles Peshek, director of fabricating operations and standards, AISC, 400 N. Michigan Ave., Chicago, Ill. 60611-4185; 312/670-5412.

SPECIAL SALE OF PUBLICATIONS

AISC is making a special offer on technical manuals. One copy of *Engineering for Steel Construction* (M014) is available for \$10 with each purchase of a *Load and Resistance Factor Design (LRFD) Manual of Steel Construction* (M015), 1st Ed. or *Manual of Steel Construction* (M011), 8th Ed. *Engineering for Steel Construction* regularly sells for \$39 to Institute members, \$52 to non-members, the *Manual of Steel Construction* is \$36 to members, \$48 to non-members and the *LRFD Manual of Steel Construction* is \$42 to members, \$56 to non-members. The sale continues through Nov. 1, 1988.

To take advantage of this price break, send check, money order or Visa/MasterCard information (type of card, number and expiration date) to AISC Publications Dept., P.O. Box 806276, Chicago, Ill. 60680-4124.

MSC ADVERTISERS

American Computers & Engineers . . .	5
N.J. Bouras . . .	2
Bristol Machine Co.	16
Cast, Inc.	32
Civilsoft	22
Cleveland Steel Tool Co.	8
Design Data	11
Enercalc	9
Engineering Software Services	12
Epic Metals	35
Fujitsu	24
Haydon Bolts	33
Hess	32
Lukens Steel	15, 17
Omnitech	12
Pettit Lawrence Ltd.	29
Platt Bros. & Co.	27
Research Engineers	6
St. Louis Screw & Bolt	25
Smith-Emery Co.	10
Steel Deck Institute	31
Structural Analysis	14
Struct-Fast, Inc.	3, 26, 34
Struct-Fast, Inc.	34
TradeARBED	20
Valmont	30
Vulcraft	18,19

THE FASTEST WAY TO INSTALL STEEL PLATE FLOORING... WITH THE FLOOR-FAST SYSTEM



- Installation by one man with a wrench working from one side.
- No drilling, no welding, no scaffolding.
- Faster, safer, and more economical than any other method.
- Excellent field experience.



STRUCT-FAST INC.
20 Walnut St., Suite 101
Wellesley Hills, MA 02181
617-235-6734 800-327-6719

Please send me full technical literature

NAME _____
POSITION _____
COMPANY _____
ADDRESS _____
TEL. _____

EPIC LONG-SPAN DECKS

E750—SPANS TO 32 FT.
E600—SPANS TO 26 FT.
E450—SPANS TO 23 FT.
E300—SPANS TO 15 FT.

AVAILABLE FOR DELIVERY—NOW

Galvanized G60-G90
Lengths to 50 ft.

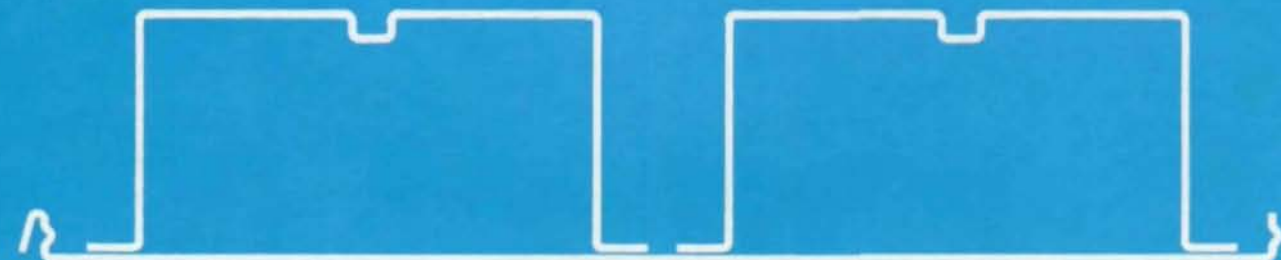

Plated Decks—Plain or perforated
Most complete line of deck products
in $\frac{5}{8}$ " to $7\frac{1}{2}$ " depths

OUR SERVICE WILL SAVE YOU TIME & MONEY

Epic has these profiles available for shipment on an A.S.A.P. Basis!

Your order will be processed in One Week in most cases. Ask about our A.S.A.P. Service.

Call (412) 351-3913 today for price and delivery information and for product advice on all types of Form Decks, Composite Decks, Long-Span and Roof Decks.

Manufacturing Plants:

- Pittsburgh, Pa.
- Chicago, Ill.
- Lakeland, Fla.

Dealer Inquiries Invited

EPIC[®]
METALS CORPORATION

Eleven Talbot Avenue, Rankin, PA 15104
PHONE: 412/351-3913
TWX: 710-664-4424
EPICMETAL BRDK

You need one of these before you build...

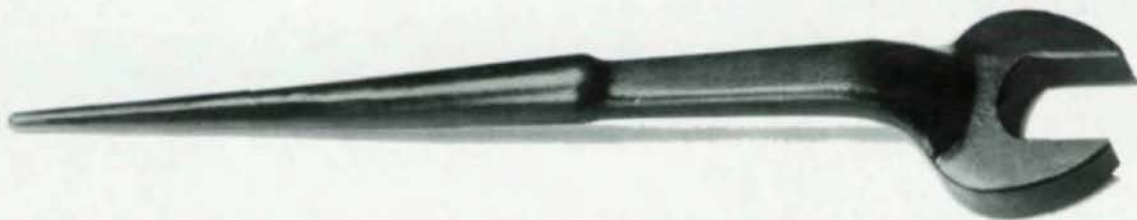

and one of these before you design.

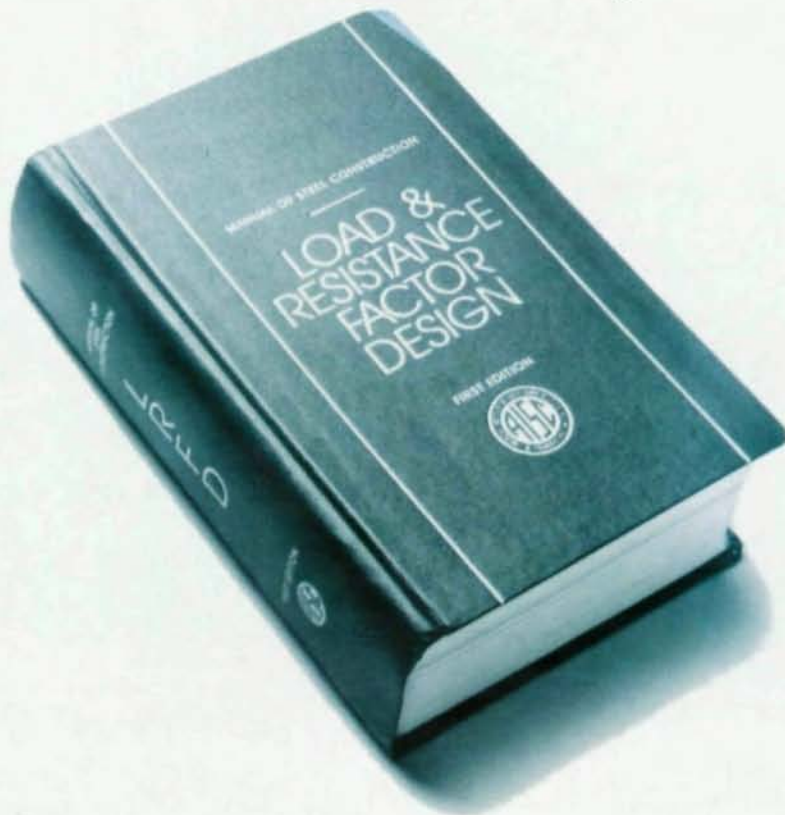

Designing a building is obviously more complicated than using a spud wrench. That's why the First Edition of Load and Resistance Factor Design Manual of Steel Construction belongs in your library.

It blends familiar, established basics with the most up-to-date advances in steel design. Already

accepted by model and city building codes, it offers you an alternative to traditional design methods.

Why not discover the advantages of Load and Resistance Factor Design for yourself? Order this valuable design tool today!

Order your copy today!

Mail to: American Institute of Steel Construction-Dept. B
P.O. Box 4588, Chicago, IL 60680-4588

I enclose \$_____ for _____ copies of the First Edition of Load and Resistance Factor Design Manual of Steel Construction at \$56.00 each.

Name & Title _____

Company _____

Address _____

City _____ State _____ Zip _____

Please enclose remittance. No C.O.D.'s. In New York, California and Illinois add sales tax. Shipping charges prepaid in the U.S. On shipments outside the U.S., add 10% of total purchase for postage and handling. Visa and Mastercard accepted.

Charge my card no. _____ /Exp. _____



**AMERICAN INSTITUTE
OF STEEL CONSTRUCTION, INC.**