

A9.29-3

MODERN STEEL CONSTRUCTION

NUMBER 3 • 1989



THIS ISSUE

Moving on a Fast Track
Bigger Than Big!
Snug-tight Makes Steel Competitive
Victorian Powerhouse Fires Up
Backdrop to Urban Development

SPECIAL ISSUE:
1989 NSCC CONFERENCE

BULK RATE
U.S. POSTAGE
PAID
COLUMBIUS, WI
PERMIT NO. 75

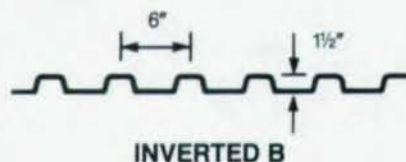

INVERTED B

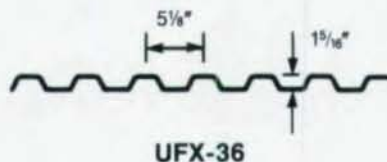

UFX-36

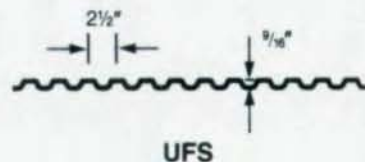

UFS

Questions and Answers About Form Deck

Q. How does form deck differ from floor deck?

Floor deck is the generic term given to composite deck — that is, deck that acts with the concrete, as positive moment reinforcing, to form a structural slab. Form deck simply acts as a stay-in-place form for the reinforced slab. Almost any deck can be a form deck, but the usual profiles are UFS, UFX or inverted B.

Q. How are the slabs designed?

By conventional reinforced concrete design — the reinforcement is usually draped mesh; that is the mesh is held up (into the negative bending region) over the beams (or joists) and draped into the positive bending region at the center of the span. Tables for uniform load, based on allowable stress design, are shown in the USD catalog. The deck profile can influence the design, particularly in the negative bending zone, because it eliminates some of the concrete available for compression. If slabs are cast on unshored galvanized deck, the deck is considered to be permanent and therefore carry the slab weight for the life of the structure; the slab only needs to be reinforced to carry live loads.

Q. What if the slab is under-reinforced?

This frequently happens — particularly on short (2' to 3') deck spans on joists. The common construction is a 2.5" slab with 66 x W2.9 x 2.9 mesh on 9/16" form deck; the mesh does not meet ACI temperature requirements. However, if the deck is galvanized and is therefore permanent, it may be capable of carrying all of the applied loads even if the concrete turns to sand; this would be a worst case model and is a very conservative approach.

Q. How is the deck fastened to the bar joists or the structural steel?

Usually by arc puddle welding; if the deck is less than 0.028" thick (22 gage) welding washers should be used. Air powered fasteners, screws, and powder driven pins can also be used.

Q. Can form deck be used with composite beams and girders?

Yes — but the deck bottom rib dimension must be large enough to accept a 3/4" stud. Our UFX-36 can be used but UFS cannot; B deck, either inverted or "right side up" is, of course, acceptable. Composite beam tables for UFX-36 are available on request.

Q. Is diaphragm design data available?

Yes. The SDI Diaphragm Design Manual, second edition has tables for 9/16" form deck. We can provide data on UFX-36.

Q. Are there fire rated assemblies?

Yes. The UL GXXX series covers many constructions. D753 and D863 cover UFX-36 type profiles on beams.

Q. Is form deck used for other purposes?

Yes. Exposed roofing; utility siding; dry installed roof systems; shelving; temporary covers; and draft curtains are some of the many uses. It is also used with non-structural insulating fills for roofs, but that is a different subject and we are out of room. Remember, any time you need deck design data or pricing call us — Nicholas J. Bouras, Inc. We have the information available.



NICHOLAS J. BOURAS, INC.

P.O. BOX 662, 475 SPRINGFIELD AVE.,
SUMMIT, NEW JERSEY 07901 (201) 277-1617



ASSOCIATE MEMBER



Structural Software Co. Material Allocation System

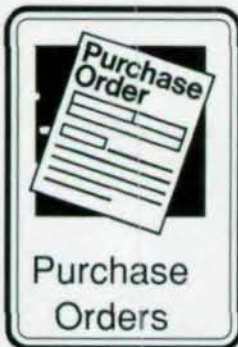

If you want to drive a shop,
as well as a plotter

with your **IBM-AT** or compatible computer, then you need the Structural Software Company (SSC) family of programs. The information you input to detail a job, using our **FabriCAD** system, can also update the other members of the family.

The **SSC Purchase Order** program places this same information (your Bill of Material) into a requisition file which lists each piece of material you need to purchase for the project.

Using the **SSC Multing** program you can then combine (mult) selected pieces into warehouse lengths. Or, use the **SSC Mill Orders** program to specify mill length. The combined requisition list lets you see the ordered length as well as what will be cut from it when it arrives. You can also manually adjust each mult or combination to fit a special situation.

The **SSC Purchase Order** program can automatically update your **SSC Inventory Control** program, showing material on order. Use this same information in the **SSC Plate Nesting** program, and print out the most efficient and economical cutting instructions.

Finally, this information can go into the **SSC Production Control** program, to generate the cut and loading lists which guide the material through your shop and to the job site, while maintaining a record of exactly what happens to each piece.

From beginning to end, and at every step in between, the SSC family of programs improves your control, reduces your expenses, and increases your profit margin.

PO Box 19220, Roanoke, VA 24019
Phone: (703) 362-9118

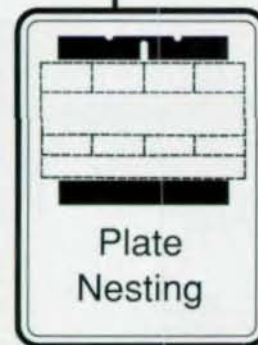
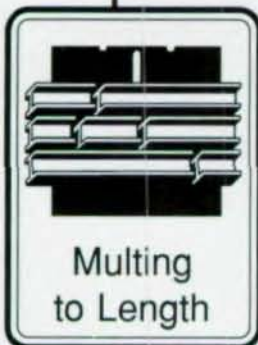
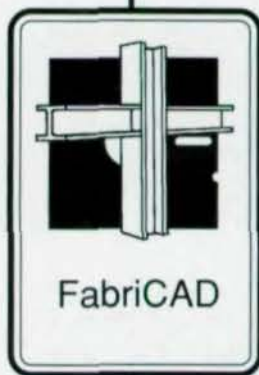

See us at the AISC National Steel Construction Conference

MODERN STEEL CONSTRUCTION

VOLUME XXIX • NUMBER 3 1989
MAY-JUNE 1989

American Institute of Steel Construction, Inc.

The Wrigley Building
400 North Michigan Avenue
Chicago, Illinois 60611-4185
Phone: 312 / 670-2400

OFFICERS

Samuel Y. Golding
Chairman

Ralph H. Clarbour
First Vice Chairman

Stephen E. Egger
Second Vice Chairman

Oscar W. Stewart, Jr.
Treasurer

Neil W. Zundel
President

David Ratterman
Secretary & General Counsel

Lewis Brunner
Vice President, Membership Services

Geerhard Haaijer
Vice President, Technology & Research

Morris Caminer
Vice President, Finance/Administration

EDITORIAL STAFF

George E. Harper
Editor

Lona Babbington
Business

ADVERTISING REPRESENTATIVE

Pattis-3M
Eric K. Nieman
4761 West Touhy Avenue
Lincolnwood, Ill. 60646
312/679-1100
FAX 312/679-5926

ON OUR COVER

Koll Center North,
Irvine, Cal. Story on pg. 59.

- 11 O'Hare Mail Facility
Moving on a Fast Track



- 19 Air Force One Complex
Bigger than Big!

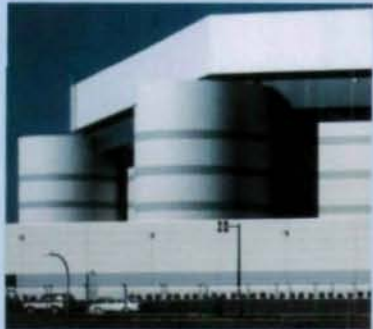

- 36 Snug-Tight Makes Steel
More Competitive



- 37 Boston Edison No. 514
Victorian Powerhouse Fires Up

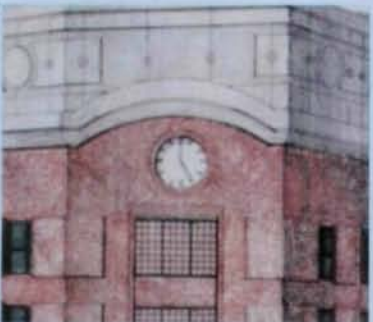

- 59 Koll Center North
Backdrop to Urban Development



NONLINEAR FEA ANALYSIS PLUS DESIGN ON YOUR PC. \$4,990

SCADA/PC-S1: \$2,800

This general purpose program has everything most structural engineers need. Features such as: 2D and 3D linear analysis with P- Δ effects. Out-of-core routine for virtually unlimited-size structures. Steel and concrete design. Interactive graphics with stress contours. Macro-programmable query language. Mesh generation.

SCADA/PC-S2: \$3,800

All the features of SCADA/PC-S1 plus time history, response spectrum, and buckling.

SCADA/PC-S3: \$4,990

All the features of SCADA/PC-S2 plus material and geometric nonlinearities.

All three SCADA packages include the following elements: 3D truss, 2D and 3D beam, 3 & 4-node thin plate/shell, 3 to 9-node thick plate/shell, plane/axisymmetric, and 4 to 27-node solid.

Other SCADA modules include nonlinear

heat transfer and fluid flow. Prices shown are for PC-version only. SCADA versions for SUN, VAX, and APOLLO are also available.

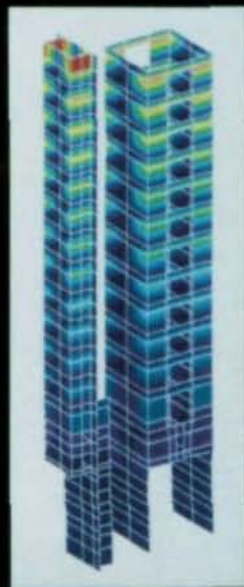
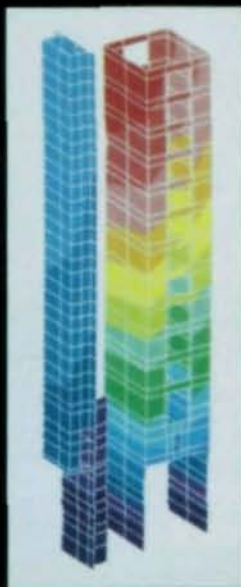

Scada



AMERICAN COMPUTERS & ENGINEERS
11726 San Vicente Blvd., Suite 212
Los Angeles, CA 90049, USA
Tel: (213) 820-8998 Fax: (213) 826-1964
Telex: 495-0365 ACE UI



TRW World Headquarters; Architect: Lohan Associates; Photographer: Nick Merrick, Hedrich - Blessing

OUR WELDING PRODUCTS ARE UNSEEN IN ALL THE RIGHT PLACES.

To stand out in a crowd takes more than a pretty face. Real beauty comes from within.

The inner strength of so many award-winning designs comes from Lincoln Electric.

Lincoln is behind the scenes

with everything for welding.

From welders, power sources, wire feeders, guns and cables, spool and stick electrodes.



To expert technical support, for welding applications, inside and out.

So if you're working on the kind of project that people are going to notice, specify Lincoln Electric.

The results will be as enduring as they are endearing.

Where productivity isn't a foreign idea.

For more information about Lincoln welding products, contact your Lincoln distributor or The Lincoln Electric Company, 22801 St. Clair Ave., Cleveland, Ohio 44117-1199.

See us at the AISC National Steel Construction Conference

©1988 The Lincoln Electric Company

00882

Can You Spot The Difference?

THEIRS

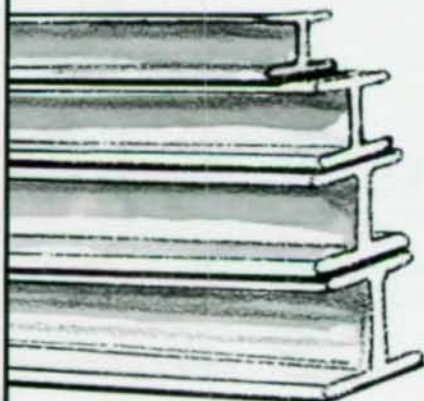

OURS

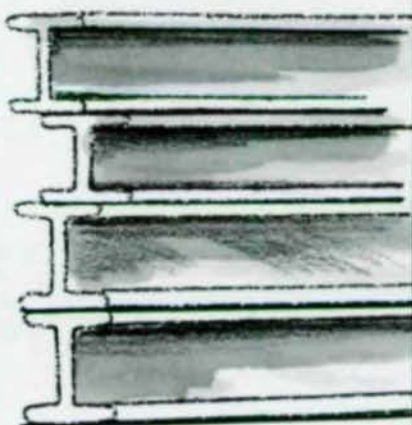

Interstate offers **A-572** high-strength steel. So does the competition. What's the difference? Steel is steel. But all steel suppliers are not the same.

Some suppliers in the industry sell promises that are hard for them to deliver. At Interstate, we sell product and reliability, not promises. We won't promise you our high-strength steel will be there unless it will be. High-strength steel is a premium product that is not always easy to get. We may not have the market cornered, but we don't act that way either. Our A-572 is clean, straight, made to order, and available. That is the difference.

So don't be misled by all the advertising. Steel IS steel. But a supplier who cares can mean everything to you when you plan your project. Forty years of experience has taught us that nothing can replace fine service and honesty. That is what you get from Interstate. Our reputation is our business, and we live up to it... Everyday. There IS a difference.

Get to know Interstate. You'll be happy with the company you keep.



INTERSTATE
STEEL SUPPLY CO.

(215) 673-0300
FAX (215) 969-0334

1800 East Byberry Road • Philadelphia, PA 19116



It May Surprise You Where The Lowest Priced Standard Fasteners In The World Are Cropping Up.

The corn fields of Indiana aren't where you'd expect to find an ultramodern fastener plant. But this is where Nucor Fastener has put down roots. And where we're going to make the lowest cost standard fasteners in the world.

We have the most advanced plant in the United States for cold heading and hot forging. Here we handle every step in house from raw material annealing to computerized warehousing.

Furthermore, most of our raw ma-

terials come from Nucor Steel. As a result, we have total control over quality. And if there ever is a question, traceability is simple.

In addition, we're using the same incentive plan that's helped make our corporation, Nucor, such a phenomenal success. Simply put, we pay employees according to productivity, so we get excellent efficiency.

With this kind of management and technology in place, we can be absolute-

ly competitive with imports. And since we're only as far away as Indiana we can give you better service and delivery. Find out about our current line of hex head cap screws and structural bolts as well as other products we have in the offing. Call 219/337-5611, FAX 219/337-5394. Or write Nucor Fastener, P.O. Box 6100, St. Joe, IN 46785.

NUCOR FASTENER

A Division of Nucor Corporation

See us at the AISC National Steel Construction Conference

Buying Structural Steel Should Be This Easy.

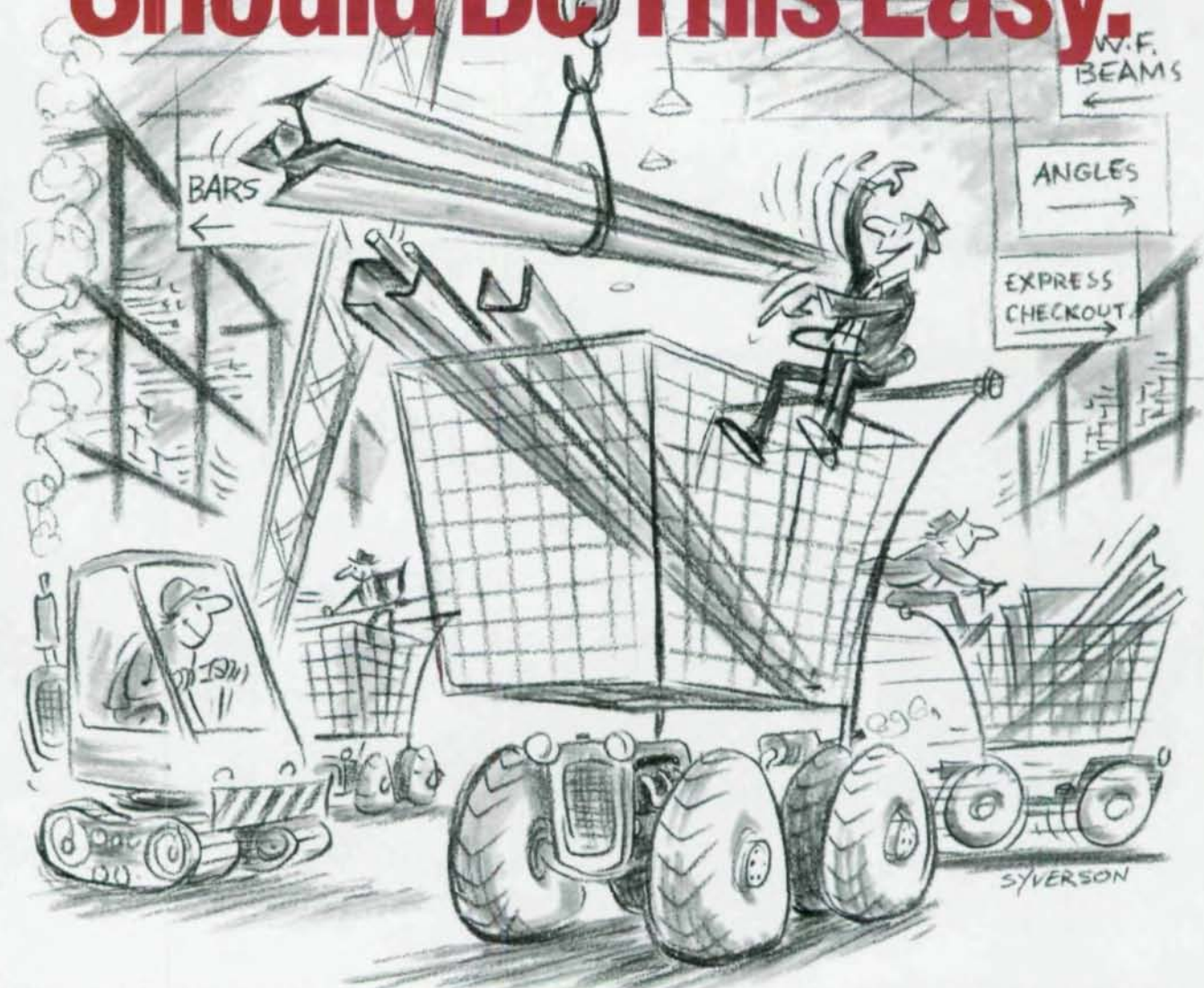

Before we talk steel, let's talk about food.

Think of how complicated our food supply is: We get oranges from Florida, potatoes from Idaho, coffee from Colombia. Not to mention beef from the cattle ranch and chocolate from the chocolate factory.

But is it hard to buy food? Of course not. You just go to the supermarket.

Well, that's how easy it should be to buy structural steel—even though the supply picture in this industry is getting complicated, too. And that is why Levinson

has become your structural steel supermarket.

At Levinson, you can buy anything in structurals, plates and bars with just one phone call. "Anything" includes jumbo beams from jumbo mills, mini-shapes from mini-mills, ship channel, high-strength, A-36, you name it.

Prices are always competitive at 18 handy Levinson locations. So give us a call—whether you need a whole market basket, or one express item.

Free Book: For a look at the future of steel buying, request a copy

of *Strategies for Structural Steel*. Call or write: Dotti Bechtol, V.P. Adm., The Levinson Steel Company, P.O. Box 1617, Pittsburgh, PA 15230.

1-800-LEVINSON

LRS[®]
LEVINSON
REGISTERED
STEELS

ARBED-ROLLED WIDE FLANGE BEAMS: BRIDGING THE GAP BETWEEN PERFORMANCE AND ECONOMY.

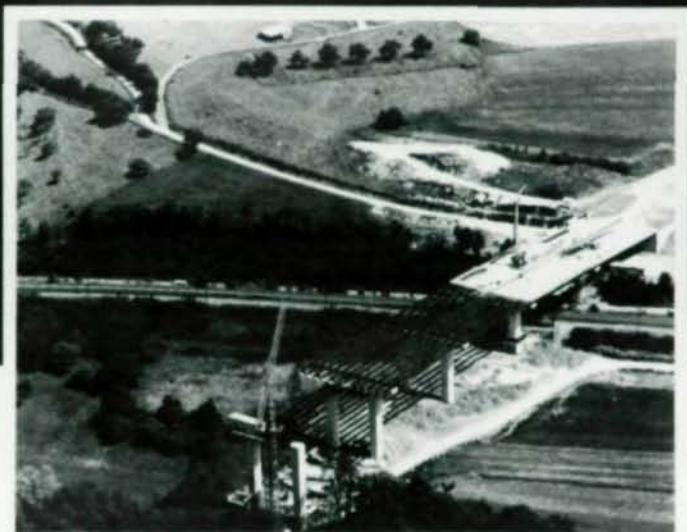

Now economy meets performance to solve all your shortspan bridge problems. The project shown here is using Arbed-rolled 40" sections, 130.7 feet in length, 328 lbs. per foot.

With Arbed's extensive custom rolling capabilities even the most difficult construction requirements can be met.

ARBED-ROLLED 40" & 44" BEAMS.

Arbed's rolled 40" beams, available in 16 sections from 149 to 328 lbs., has now been expanded to include our new rolled 44" beams, available in 4 sections from 198 to 245 lbs. They all

offer the same benefits we're famous for: high section moduli, great lateral buckling resistance, and the ability to compete economically with both fabricated sections, as well as reinforced precast and prestressed concrete.

ARBED-ROLLED "TAILOR-MADE" BEAMS.

This is the series (up to 42.45" X 18.13" X 848 lbs./Ft.) that lets you specify the beam according to the section properties you need, other than what is normally available. For example, our 40" and 36" TAILOR-MADE

series allows you to raise the moment of inertia to 67,400 in⁴ and the section modulus to 3,170 in³. This eliminates the need to add plates to standard WF beams. Result? Big savings: In fabrication cost and weight.

GET ALL THE FACTS.

Send now for complete information including specifications: TradeARBED Inc. 825 Third Avenue, 24th floor, New York, NY 10022. (212) 486-9890. Domestic telex: (W.U.) 12-6159, Int'l telex: (ITT) 421180. OMNIFAX (G-3): 212 355 2159/2421.

A TRADE ARBED Inc.

INNOVATORS OF STEEL CONSTRUCTION PRODUCTS.

See us at the AISC National Steel Construction Conference

Steel's Flexibility

O'HARE MAIL FACILITY

Moving on a Fast Track

by Donald C. Russell



The new 380,000 sq. ft Airport Mail Facility (AMF) along the south edge of O'Hare International Airport was recently completed and is now operational. The largest airport mail facility in the Midwest, it was designed by Chicago-based engineers/architects, Teng & Associates, Inc. Subconsultants included Booth/Hansen and Associates, associate architect and I.G. Associates, mechanization designer. Work was coordinated with the U.S. Postal Service, the City of Chicago and O'Hare Development Program. This significant project, located adjacent to the southwest cargo area of O'Hare, was completed ahead of schedule and under budget.

Services and Operation

The expansive AMF is about nine acres under one roof. In addition to a separate,

secure parking area for employees, a customer parking lot and a 16-bay loading area for postal trucks, the facility has six automated full-service windows in the public lobby, 24-hour Express Mail service, 885 post office boxes and a 24-hour self-service convenience center. The facility has a public lobby, customer service dock, a mail processing work room and a 130,000-sq. ft airline concourse area where all air mail coming in and out of O'Hare is handled. The facility is equipped with the most advanced and efficient computerized mail processing and mail handling technology available for processing more than 800,000 lbs. of domestic outgoing mail and over 100,000 lbs. of military and international mail daily.

The building was designed around a computerized mail handling system. The

mechanization system dictated the spatial configuration of the building. Mail traveling through the facility is transported on 102 belt-type rollers, 42 roller-type conveyors and 10 single-sort machines which employ 207 trays to send mail to various airlines. The air carriers have their designated side of the building where they bring mail in from their flights.

The AMF also serves 10 surrounding states, funneling mail to air carriers for domestic points and international points such as Canada, along with mail headed for servicemen in Europe from states west of the Mississippi. Much of the mail going through has already been sorted and tagged and is just transferred to another plane or truck. Also, the Postal Service has allocated a 6,500-sq. ft area for U.S. Customs.



Operations in control room monitored by three computers in logic control system

All this activity is handled by three separate computers in a logic control system. Twenty-five cameras are located strategically to help monitor the system and permit the central control to look when a computerized graphic display indicates trouble on a specific belt. The control room is then in contact with maintenance by two-way radio to direct them to the problem. The system also indicates if a cart is in position to receive mail and if it is full or empty.

Site Development and Project Coordination

The capability to coordinate the work of various public and private agencies and utilities in the design and construction of site improvements was demonstrated with the AMF. The 23-acre site development had to meet USPS design criteria as well as O'Hare design criteria. These two sets of criteria had many conflicting, overlapping items. Teng was responsible for identifying, coordinating between the two agencies and resolving conflicts.

Site development included 1,700 linear feet of new access road, 1,800 linear feet of new tug and cart road designed for the special requirements of mail vehicles,

T.S.® Bolts & Tools

I.C.B.O. Listed
 Full range of certified A325 and A490 bolts and complete complement of tools for installation, including "Tone" tools and the new TSW 60LC high speed, swivel head tool.



FULL 360
 ROTATION

NEWEST OF
 FULL LINE
 OF LIGHT
 WEIGHT
 TOOLS

BRISTOL MACHINE COMPANY
cfs Construction Fastener
 Systems Division

630 E. Lambert Road, Brea, CA 92621 • 714-990-6555
 WATS 1-800-872-6587

three parking lots and 2,650 linear feet of utility corridor for sewers, water mains, gas and electrical connections.

Structural Versatility Important

MF's operations required use of roof-suspended equipment throughout to permit an open floor plan for circulation and mechanization conveyors. The Postal Service required a system to accommodate variances in locations and loadings of future equipment changes. Teng recommended nonuniform spacing of hangers to allow for locations and loadings to change as needed. These parameters were important input in developing an economical and cost-effective structural framing system.

The engineer developed a structural steel system that had to work within a 36-ft by 54-ft bay size and a special system of frames to carry wind as well as gravity load. While the trussed frames were located on column grids, lightweight purlins span 12 ft to carry required suspended loads by adding intermediate trusses. Because purlins permit subframing to receive concentrated loads wherever re-

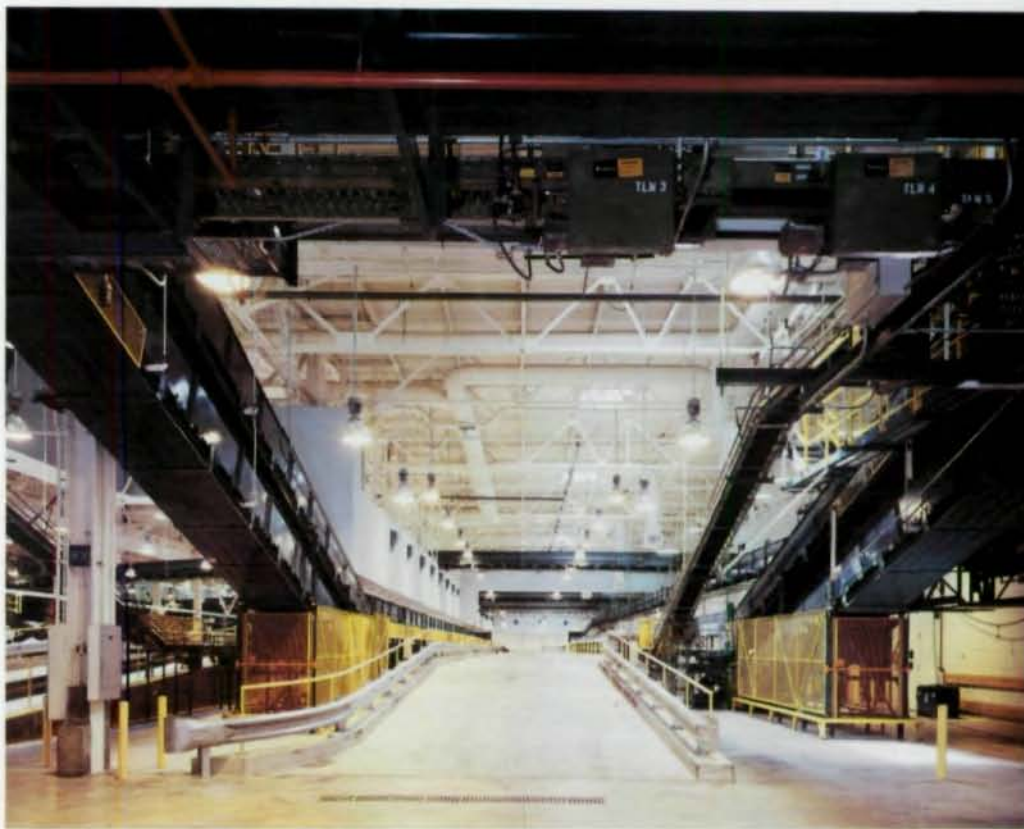

Suspended processing/handling equipment permits open floor plan for circulation and flexibility

It's good to have a choice . . .

Choose Experience

- Detailing expertise
- Computer expertise
- Engineering expertise
- Service expertise

Choose Solutions to

- Massive design revisions
- Heavily architectural jobs
- Fast track jobs
- Necessary shop optimization
- Connection design responsibility

Choose Variety

- Beams & Columns
- Ladder Systems
- Pan and Grating Stairs
- Connection Design
- Bracing
- Shop Management Reports
- Templates
- Plate Work
- Girt Walls and Door Frames

. . . it's GREAT to make the right one!

Make the profitable choice in Automated Detailing . . . choose PDS



Dogwood Technologies, Inc. P.O. Box 52831 Knoxville, TN 37950-9928
615-523-5634 800-346-0706

See us at the AISC National Steel Construction Conference

IPDS Procedural
Detailing System



High ceiling creates congenial "local post office" atmosphere

quired, this system meets the flexibility requirements established by the owner. Because of appropriately developed spans, the system is lightweight with uniform purlin and truss spacing and associated repetition to gain additional economy.

Knowing the Postal Service's needs for

a tall, single-story structure, the structural engineer recognized this need could be satisfied by using continuous frames with trusses as the roof element. Extending the bottom chord to develop fixity lent special attention to top chord connections because of tension across the joint. Bolted

connections could be accommodated and permit efficient construction. This was very important in meeting the fast-track schedule for the project.

Because of its location at O'Hare Airport, height restrictions also limited building height in the airline concourse part of the facility. The truss system permitted locating duct runs within the structural depth. By using a truss frame to address interior clearance requirements along with height restrictions, the engineer was able to take advantage of the maximum available stiffness in developing the structural system for this area. The mechanical systems were also coordinated into the structural system.

To gain additional time within a constricted construction schedule, a foundation system was selected to permit construction during winter. While soil conditions would have permitted spread footings, the use of shallow caissons and perimeter grade beams gained precious months in the construction schedule without major cost changes.

The building enclosure was accomplished efficiently and economically by specifying end-load bearing precast concrete wall panels. The wall panels span horizontally to the wind columns spaced on 18-ft centers. Grade beam costs were not escalated by this system. Of the three generic wall systems reviewed, the precast concrete system offered the greatest economy in terms of present dollars and life cycle cost.

Electrical Engineering

An analysis was made of the cost-effective methods for the power and lighting distribution systems for the AMF. Considerations were made to incorporate the fast-track design and construction schedule, about occupancy in less than three years, the amount of mechanization and sorting equipment to be installed and the fact that two thirds of the building would be occupied by conveyor systems.

Electrical engineering design included using a 4160-volt electrical distribution system vs. the 480-volt system for distribution economies, roof skylights for supplemental daylighting, a state-of-the-art dimming system for high-pressure sodium lighting intensity and combining it and metal halide luminaires to create a natural lighting environment. Final electrical cost was both within one percent of the original cost estimate and the allocated time frame. The designed facility fully met the goals and original concepts set up by U.S.P.S. for a design of an energy-efficient facility.

IRONWORKER shear knives

Punches & Dies

Stems & Nuts

Notcher
Punches & Dies

Coper Punches
& Dies



The leader in high quality
tooling



Call 1-800-446-4402

THE CLEVELAND STEEL TOOL CO.
474 E. 105th Street • Cleveland, Ohio 44108

A-1743

See us at the AISC National Steel Construction Conference

Mechanical Engineering

The Airport Mail Facility was designed to protect the public and employee health and safety by incorporating high efficiency filtered system in all HVAC systems, incorporating carbon monoxide monitoring and purge systems to control safe levels of carbon monoxide for human occupancy where people and vehicles come in contact. Dust collection systems are used so as not to pollute the atmosphere where handling of mail sacks create a dust problem. Equipment was selected to maintain safe noise levels within OSHA standards and HVAC systems were employed to maintain comfortable working conditions.

Mechanical, plumbing and fire-protection design combined O'Hare Design Standards, Postal Service architectural design criteria, U.S.P.S. energy and utility design criteria, Chicago Building Code Requirements, N.F.P.A., OSHA and ASHRAE design requirements.

Extraordinary conditions and project requirements which had to be met included:

1. All office and workroom air conditioning systems had to be designed to incorporate prefiltering high efficiency bag filters and activated carbon filters to eliminate heavy concentrations of jet fuel emissions.



Sorting bin area shows facility equipped with most advanced, efficient computerized technologies.

DEMAND

ACCURATE ESTIMATES PRODUCTION CONTROL

Bid more quickly and accurately...add productivity and cost-effectiveness to your plant...with the DMS Interactive Steel Fabrication System. A series of 8 interactive software modules, containing approximately 200 programs, addresses the specification needs of the steel fabricator.

Modules include:

- ESTIMATING
- BILL OF MATERIALS
- INVENTORY
- JOB COST
- GENERAL LEDGER
- ACCOUNTS RECEIVABLE
- ACCOUNTS PAYABLE
- PAYROLL

The DMS System is the product of 10 years development, and is currently being successfully used by over 40 steel fabricators.

Take control of the details each job demands with DMS. For more information, contact:

DATA MANAGEMENT SYSTEMS, INC.
12308 Twin Creek Road
Manchaca, Texas 78652
(512) 282-5018

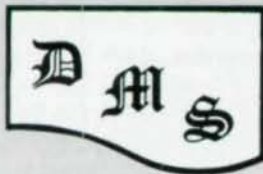

- The heating, ventilating and exhaust system had to incorporate an automatic carbon monoxide monitoring system which would maintain automatically a safe level of carbon monoxide in the airline concourse where mail was brought in by ground tugs.
- The workroom area of the facility was designed to maintain a positive pressure to avoid the possibility of recirculating carbon monoxide-laden air from the adjacent concourse.

The computer room areas were 24-hour areas with year-round air conditioning DX systems requiring an emergency back-up air conditioning system. They were designed to switch over automatically from DX system to central chilled water air conditioning system if the DX system failed.

Architectural Features

The customer lobby entrance is accented by a series of steel-clad columns and a recessed curtain wall to focus attention on the public entrance. This facility is one of the first in the Chicago area to offer 24-hour lobby service. The entrance of the building was designed to create a feeling of openness and draw attention to the public area of the building. The high ceiling and the design of the customer service

area create a welcoming and congenial local post office atmosphere. Mahogany wood complemented with a light blue trim is used in the customer service area which has the latest in automation.

A specially designed insulated precast exterior wall system adds texture to the exterior appearance and the alternating gray and white color bands not only distinguish the building but also meet the airport material color palette for harmony and U.S.P.S. requirements for energy efficiency. Other features include a dramatic 20-ft high sweeping screen wall in front to mask the 16-bay truck dock facing the main highway.

Special acoustical glazing was introduced at all office areas to provide a comfortable noise level, because of the proximity of adjacent runways and airport operations. Glazing was used for clerestories to introduce daylight into all the work areas and for user awareness of outside conditions.

The construction cost of the project was \$47 million, including \$9.5 million for conveyors and mail-handling equipment. Construction of the building was accomplished in fast-track phases to meet the completion date. The building came in under budget and was occupied almost one month ahead of the expected date. □

Architect/Engineer

Teng & Associates

Associate Architect

Booth Hansen & Associates

General Contractor

George Sollitt Construction Co.

Construction Manager

Sverdrup-Gilbane (joint venture)

Steel Fabricator

Zalk-Josephs Fabricators: Stoughton, Wisconsin

Steel Erector

Area Erectors

Donald C. Russell, S.E., AIA heads Teng's Structural Engineering Department of Teng & Associates, Inc., a Chicago-based engineering/architectural firm currently celebrating its 30th anniversary.

Project engineer for the project was Tom R. Rupert, S.E., of Teng & Associates, Inc.

Bridge Girder Design Software Now Available

The American Institute of Steel Construction is cooperating with Bridge Software Development International of Coopersburg, Pa., in an effort to provide software for computer-aided design of steel bridge girders. BSDI has developed the Line Girder System (LGS) package of computer programs, which enables the design engineer to take full advantage of today's desktop personal computers. Most software can perform quickly computations that were always required, but the LGS goes further; it permits a new level of decision making through its interactive and user control features.

Through interaction with the LGS, the user can examine the relationship between fatigue, yield stress and girder depth, or the relationship between compression flange buckling and diaphragm arrangement. This level of investigation can be performed without the uncertainty of costs and turn around associated with main-frame computing.

The LGS programs run on industry-standard MS.DOS microcomputers, which have a parallel port receiving RS232 shaped attachments. The programs are provided on 5¼-in. 360K floppy disks. All 10 executable programs of the LGS can be installed using less than two megabytes of hard disk space. If disk space is limited, the programs can be run from floppies or from a RAM drive.

BSDI also has a 3-D program suitable for the design of curved girders. However, complete 3-D analysis and design is beyond the scope of the LGS program.

For further information, call or write: AIA Publications, 400 N. Michigan Ave., Chicago, Ill. 60611 312/670-5446.

Window Wall/Curtain Wall Mockup Testing



*Wilshire/Westwood, Los Angeles
Granite and Aluminum/Glass Window Wall Mockup ready
for Dynamic Water Infiltration Test.*

SMITH-EMERY COMPANY

The Full Service Independent Testing Laboratory, Established 1904
781 East Washington Blvd., Los Angeles, California 90021
213/749-3411 • Fax 213/746-7228





SAY IT WITH STEEL . . .
See the CALL FOR PAPERS in this issue



Kansas City, Missouri
March 14-17, 1990



1989 NATIONAL STEEL CONSTRUCTION CONFERENCE

Kansas City Convention Center

Kansas City, Missouri

March 14-17, 1990

Exposed Steel Is Unique Solution For London's Broadgate Office Complex

Architectural form, expression and articulation are all based on the exposed, painted steel structure for the Broadgate Project, a major office development on the north-east edge of London. The building enclosure forms a smooth metal and glass skin background to enhance the clarity of the structure. Member proportions and joint details follow strict structural logic to express directly the functions and workings of the structure.

Broadgate was designed by the Chicago office of Skidmore, Owings and Merrill for Stanhope Properties PLC, the owner. General contractor was Bovis/Schal; the fabricator-erector was the joint venture of Hollandia, Buyck and Smallman (HBS). Hal Iyengar, SOM partner and director of structural engineering, will discuss the design and construction of the Broadgate at the National Steel Construction Conference in Nashville, Tenn. on Thursday, June 22.

The 10-story office building, which is the focal point of the Broadgate Project, faces the Liverpool Street Station train shed, an historic structure of exposed iron and steel. Because this prominent position is also heavily congested, with tracks below, three important objectives in the design of the building were established: one, the structure should efficiently clear span over the tracks to provide unobstructed operations for the trains; two, the structure should be sympathetic to the historically significant train shed; and three, the building should act as a centerpiece whose articulated expression would contrast with the neighboring complex of stone and glass clad buildings.

The office building, with approximately 550,000 gross sq. ft of office and trading-type space, is supported on four segmented, tied parabolic arches spanning the 256 ft over the railroad tracks. The two exterior arches, their ties and the columns and beams that frame into them, are located so as to create a gallery at the perimeter which permits the exterior structure to be exposed, creating a structural expression for the building. Member proportions and joint details followed strict structural logic to express directly the functions and workings of the structure.

The arch solution was selected from among several possibilities. One alternate involved a traditional, cross-braced truss, seven stories tall, which not only involved 33% more steel, but also did not create an exciting architecture—especially as it related to the historic station archways. Another alternate was a parabolic suspension system with

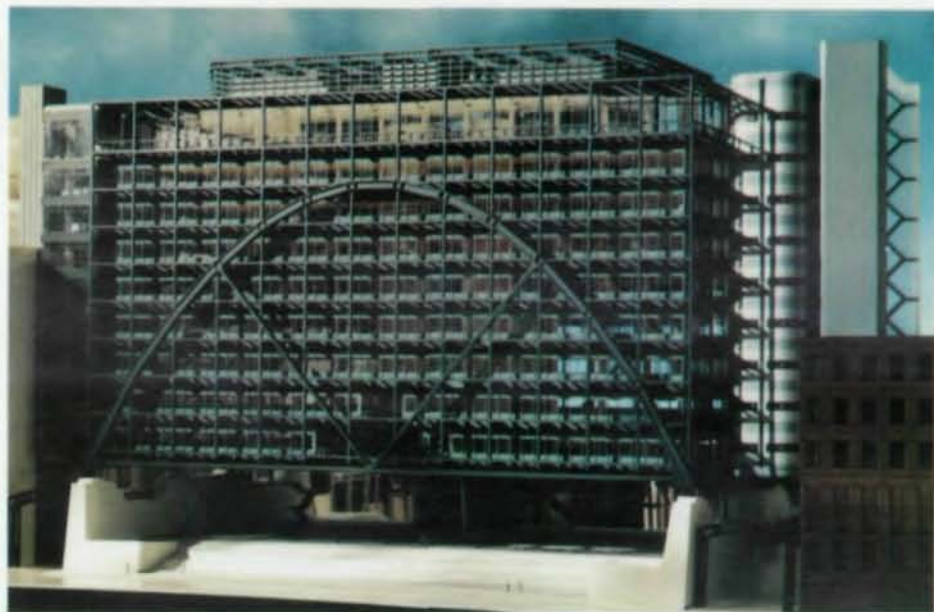

Model of 10-story office building, centerpiece of Bishopsgate project

end pylons similar to the Federal Reserve Bank structure in Minneapolis. This solution, while efficient as a structure, posed coordination and erection difficulties, and also did not provide a basis for high definition of the facades.

The primary elements of the system are the four parallel, 7-story high, parabolic tied arches which span 256 ft between the concrete buttresses. The two exterior arches are exposed and are set out from the fire-rated cladding. The two interior arches traverse through the body of the building and are partially expressed internally through atriums. The four arches form three bays, perpendicular to the arches, which are spanned by composite floor trusses. Vertical, exposed end trusses are provided in the middle bay to provide lateral stiffness for the broad side wind forces and for lateral stability of the arch system.

Vertical hanger/column elements are supported on the arches at node points, and the floor framing members are connected to the hangar/columns through a typical shear connection. The gravity load flow then occurs from the floor trusses to the column-hangers, to the arches and to their supports.

At each floor level, a continuous floor girder is provided in the plane of the arch on the interior, which together with the arch provides for lateral stiffness for the entire building in the direction of the arch. These girders also function as intermediate ties. On the exterior arch, these intermediate ties are

moved behind the cladding line and activated by diagonal struts on certain floors in the horizontal plane at the arch nodes.

The straight-segmented, parabolic shape was chosen for the arch as the most efficient shape for the primary loading configuration, a series of approximately equal point loads applied to the arch by the columns and hangars. The arch shape matches the moment diagram for uniform point loads and therefore the loads are carried as axial compression loads with a minimum of flexural bending, down the arch to the buttressed walls.

Steel Detailing

Steel details followed two basic concepts. One pertained to the character of exposed steel on the exterior; the other to the simplicity and ease of fabrication and erection.

The architectural premise was to emphasize honest and clear structural logic in the proportionality of members and joints while the aesthetics were based on expressing crisp, open, web-like forms to permit the play of daylight through the structure. This was integrated suitably with the expressions of robustness and integrity, especially at the joints. For ease of fabrication and erection, all field welding was eliminated in favor of shop welding and bolting.

The basic arch segments are linear elements with end-bearing plates connected to nodes which provide the angle change to the next linear segment. The arch members



Unique structure required high degree of dimensional control in steel fabrication.

themselves are composed of built-up channel members arranged back-to-back to permit the column-hanger members to pass between them and be connected to them. The flanges of the channel provide articulation and crispness to the otherwise solid arch shape. Regularly spaced batten plates tie the two channels together to make them function as one and provide a certain openness in the width of the members.

Fabrication and Erection

This unique structure, while simple in concept, required a high degree of dimensional control and craftsmanship in steel fabrication and erection. The basic criteria related to (a) appropriate fit of the members in the erected structure, and (b) suitable allowances for member distortions and camber to result in a level floor. A comprehensive system of tolerances for fabrication and erection was worked out to achieve those ends. This was accomplished by a creative working relationship between the designers and steel fabricators (HBS) early in the design process and prior to the actual bid.

Fire Engineering

An engineered approach was used to evaluate fire resistance and protection for the exposed steel elements. All elements interior to the window wall were fire protected conventionally according to British Standards and a sprinklered system with an emergency power hookup provided. The nature of a fire that might occur in this particular building was determined and maximum steel temperatures calculated. A structural analysis was then performed to determine deformations which could occur from thermal expansion and changing elastic properties. To limit steel temperatures while preserving shape characteristics, a fire-resistant glass window wall was used—the equivalent of having a fire-rated barrier between the fire load and the exposed steel. Two types of heat-resistant glass are available; in one, a layer of intumescent material is laminated between two layers of regular sheet glass, in the other, the chemistry of the glass is altered to toughen it against heat—similar to Pyrex.



Hal Iyengar

(NOTE: A copy of Iyengar's paper is reproduced in the Proceedings of the 1989 National Steel Construction Conference, available from AISC after July 1, 1989.)

Highway Structures Design Handbook To Be Updated

The Highway Structures Design Handbook, developed by AISC Marketing Inc., will be updated and new chapters added as one of the first projects to be approached by the Council for the Advancement of Steel Bridge Technology. The handbook has become a recognized source of information for the design of steel bridges and the Council believes it can serve as a foundation document for sharing and promoting the best of current steel bridge practices.

A priority list of chapters to be written revised includes:

- Chapter II/4A Composite: Welded-plate Girder-load Factor Design. Revise and update for new shear design and fatigue provisions.
- Chapter II/4B Composite: Welded-plate Girder and Rolled-beam—Autostress Design. New chapter demonstrating the use of autostress design procedures, and comparing rolled beam and plate girder design.
- Chapter I/8 Joints and Bearings: New chapter demonstrating design and details of deck joints and bearings. Shows how most joints can be eliminated through innovative designs practiced in Tennessee.
- Chapter II/5 Composite: Medium-span, Welded-plate Girder—Load Factor Design. Revise and update for new shear design and fatigue provisions.
- Chapter I/9 Unpainted Steel Bridges: New chapter discussing the experience with the use of unpainted steel in bridges over the last 20 years, with specific recommendations and guidelines for its use.
- Chapter I/3 Properties: New chapter will discuss material considerations in the design of structural steel bridges to ensure safe reliable material and structure performance.

M-STRU DL

The Best Selling
Civil/Structural Program
Since 1987

ANALYSIS

- 2D/3D Frame / Truss / Plate / Shell
- Static / P-Delta / Dynamic / RSA Analysis
- Capable of 1000's of joints and 100's of load cases
- Interactive geometry, deflection, mode shape, plots
- Interactive shear and moment diagram plots
- AISC Library included

DESIGN

- Interactive graphic menu driven design
- Continuous beam, section properties, frequency calculations
- AISC code check and sizing
- ACI column, beam, footing design
- Design details can be output to AUTOCAD
- Excellent in report presentations

GUARANTEE

M-STRU DL is superior in productivity and power. It has extremely flexible input/output options and supports most PC/XT/AT/PS2 hardware.

"JOIN THE WINNING TEAM"
Ask for a brochure today!

CAST
COMPUTER
AIDED
STRUCTURAL
TECHNOLOGY

P.O. Box 7326
Fremont, CA 94536-7326
(415) 795-0509

Imaginative Engineering

AIR FORCE ONE COMPLEX

Bigger than Big!

by Andrew J. Sauvage



Looking north at support complex and hangar

Aircraft hangars in general tend to be large, long-span structures. The new maintenance and support complex for the President's "Air Force One" Boeing 747 aircraft is larger than large. Standing on the taxiway at Andrews Air Force Base, one realizes superlatives are inadequate. This building is just plain big. But it is more than big! It's a commanding, award-winning architectural design given shape and support by 3,500 tons of structural steel.

Design of the complex received the Air Force Regional Civil Engineer's Award for Design Excellence in the Eastern Region and the 1987 U.S. Air Force Honor Award for concept design excellence. In addition, the design of the exterior of the entire complex, a prefinished insulated steel panel system arranged in dark and light gray horizontal bands, was commended by the National Capital Planning Commission for the scale and consistent composition this scheme provides to the very large building.

The need for this facility was based on the government's decision to replace existing Presidential Boeing 707's used as Air Force One for more than 20 years with two new Boeing 747's, scheduled to arrive in November 1988, a delivery date which dictated an ambitious design and construction schedule. The A/E completed the concept, preliminary and final design of the 145,000-sq. ft High Bay area and the 50,000-sq. ft support complex in only nine months, including reviews by the Navy, Air Force and several environmental agencies—delivering the final working drawings on Feb. 12, 1987.

The unique building shape is a result of configuring the aircraft parking with two 747's in a 90°, nose-to-nose position. The complete building footprint integrates this basic V with other essential components such as aircraft doors, "pockets" for the retracted (open) doors and fire protection systems by using three basic shapes—rectangle, triangle and circle—to form an

elongated hexagon with a circle at each corner. The hexagon is 392 ft across flats and 611 ft across the points.

Several Design Considerations

There are several design considerations related to the hangar, or "high-bay" configuration. The three front sides of the building (drawing) are aircraft doors, with column supports possible only at points B and C. Columns are spaced along the other three sides. Considering the irregular shape of the roof, the structure must span across the north-south direction from the EF side to the BC side, where a major transfer truss carries the load to points B and C. The structure also must reach out in the east and west directions from the central rectangle to form the aircraft door openings along the AB and CD sides.

The two main aircraft doors are 6-leaf, horizontal-sliding, bi-parting doors. These doors, quite impressive structures all by themselves, were furnished by AISC Mem-

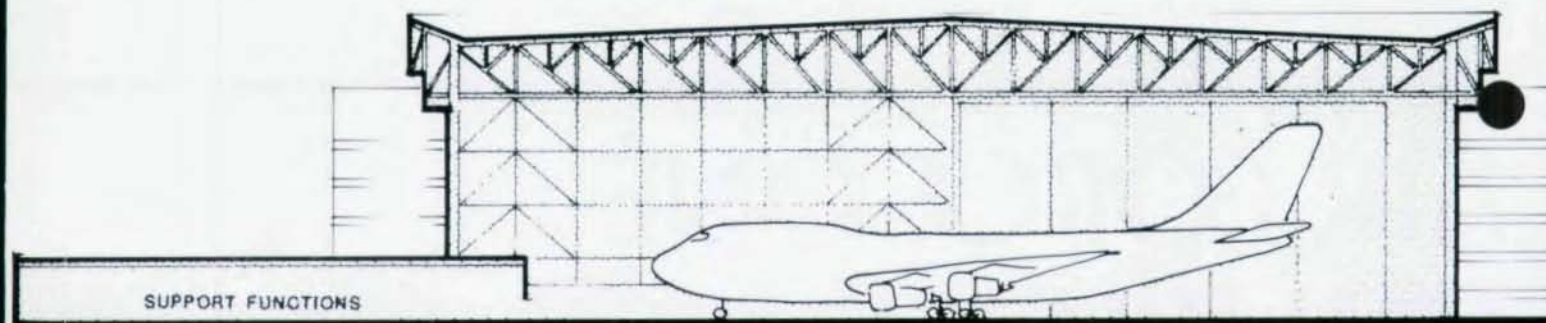

SECTION



Floor plan (above) of Air Force One hangar. Section (l.) shows immensity of project. Interior (r.) from "F," looking northeast toward CD door.

selected for design development. This system provides support and deflection control along the AB and CD lines (the main aircraft doors) and also results in a rigid, two-way horizontal structure to distribute lateral forces.

The method of analysis for this 3.7-acre roof structure was a major consideration. There are two basic possibilities. The first is to build a large computer model of the entire structure. The second is to make some basic (educated) assumptions about how the structure will behave, then isolate several planar substructures and proceed with a hand (or simplified computer) analysis. After some thought, the analysis method selected was—both! The reason for this dual analysis was a consideration of the erection process.

The roof structure was too large, heavy and complex to be built entirely on the ground and then lifted into place. How the structure would react to the dead load would depend almost completely on the erection sequence, but the complete space structure would resist future live loads as a single system. Since the space structure was the most efficient, consideration was given to requiring that the structure be erected with complete shoring, which would result in both dead and live loads being resisted by the space structure. However, after establishing the cost of the necessary shoring, this erection procedure was abandoned.

The computer analysis required building of a computer model with 1,115 nodes and 1,115 member elements. For the first analysis, member sizes were esti-

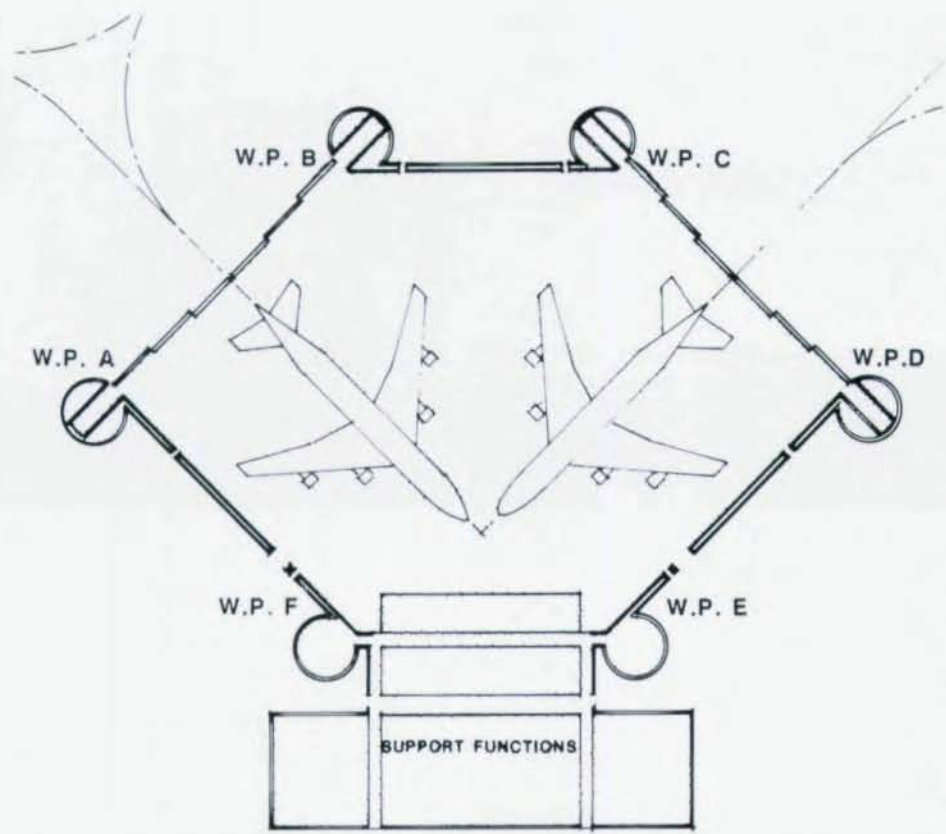

ber Fleming Steel Company. Three leafs slide each way from the center, nesting together as they reach the fully open position. The open doors require an external storage area, or pocket, appended to the main structure, with a total of four required at points A, B, C and D. In many hangar designs, these appendages are functional but uninspiring rectangles. The architect chose a cylinder shape for this structure, which helps focus attention to the corners of the hexagon without adding confusing and extraneous lines at these focal points. To balance the hexagon, two additional

cylinders were added, one for the fire-fighting foam equipment, the other to provide washrooms, locker rooms and house the aircraft washrack equipment.

The initial design effort focused on the clear-span roof structure for the high-bay area. Several options were investigated, including one-way trusses, a space truss and a cable-supported system. After considering these and other possible structures, a space truss system consisting of main trusses spanning the 354-ft (north-south) direction with secondary trusses spanning in the east-west direction was



mated, dead and live loads calculated and applied and a first analysis was produced using the GTSTRUDL program. Using member sizes obtained from this run, a second run was made, and deflections were plotted. After considering the deflections, several changes were made to the system, the most significant being an increase in truss depth from 24 to 28 ft. Then, back to the computer for another run, and then another design.

After the space structure analysis and design was completed, the second analysis began with a consideration of erection sequence. Based on this sequence (which was provided on the contract drawings), critical members and sub-systems were selected and analyzed for dead load stresses. These stresses were then added to the live load stresses obtained from the space-frame model, and the members were checked and revised as necessary.

Finally, truss assemblies identified by the erection sequence were analyzed for stresses induced during the lifting process. Since the erection process envisioned lifting one half of a truss onto temporary mid-span shoring, this involved checking members designed as tension diagonals for a relatively small compression load to insure that buckling would not occur.

Details, Details, Details

It is not enough for a structural design to be technically correct from a strength and serviceability (deflection) standpoint. Some one has to be able to build what has been designed, or the design is of no val-

ue. It was obvious from the beginning that the details of the structure would rival the analysis in complexity. The details of a complex steel job such as this are at least as important as the overall member design. Many basic decisions concerning the layout and orientation of members in the space truss were made based on the resulting joint configurations. For example, the "TS" trusses were behaving as simple-span members, so a classic diagonal configuration resulting in tension diagonals was possible. Double angles were chosen to simplify the connection at the chord-vertical-diagonal junction. The diagonals on the "TL" trusses were then configured to minimize junction with the TS diagonals.

Joint and splice details were effected by the size of the main truss chord members. The central TS truss chords, for the most part, fall into the ASTM A-6 Group 4 or 5 size classification—so called "jumbos." Bolted splices in tension members require consideration of the resulting net area and the overall member becomes larger than necessary in order to provide proper net area at the splice. For this reason, welded splices are more efficient and very appealing. It is fortunate that much attention has been given over the past few years to the problems arising from butt-welded tension splices in jumbo wide-flange shapes, because it is obvious the appeal of the welded splice is like the siren's song—jagged rocks wait. On Air Force One, all the jumbos are a A 572 Gr. 50, killed fine-grain steel and all splices in these members are bolted. (This design was carried out prior to the recent issue of Supplement

No. 2 to the AISC Specification, which presents new rules for design of jumbos subject to tensile forces.)

Another detail consideration affected the cylinders, or "pods." The major purpose of the structure of the cylinder is to form a round shape from straight metal panels, holding the panels in place against their own dead load, which is small, and wind loads, which are not. Originally, the design sought to take advantage of the inherent lateral strength of the 50-ft dia. cylinder. However, in order to make a tubular structure, it was necessary to provide extensive bracing between the vertical girt columns, since the siding panels would not provide this strength. After looking at the hundreds of small bracing members and attendant field connections for each one, the original design approach was pronounced to be elegant in theory but a lot of gingerbread (or in erector's parlance, "junk iron") in practice. The design was changed to a more mundane but practical rectangular braced core within the confines of the cylinder. The rectangular core in the A, B, C and D cylinders also lined up with the respective AB, BC and CD sides providing for an uncomplicated transfer of lateral forces from these sides.

Important Detail Decisions

One of the most important detail decisions concerned the layout and design of the joints in the structure, especially the truss joints. Two truths were evident from the start. First, the joints would be complex, and the actual joint details would have major impact on the cost of fabrication and

erection. Second, there are many acceptable details that can be conceived for any given joint, depending on which engineer, fabricator or erector (or combination of all three) looks at the joint.

The approach adopted is outlined in the ASCE "Final Report and Recommendations on Assignment of Authority and Responsibility for Design of Steel Structures." This report was endorsed by AISC in 1986. Under Sect. 3.1, the report states, "For complex steel structures, the EOR (engineer of record) may specify in the contract documents that the fabricator have a licensed professional engineer design the connections. In such cases, the EOR should still review and approve the connections."

This process worked well. The fabricator requested, and was granted, permission to use 1 1/8-in. A490 bolts in lieu of the 1 1/4-in. bolts originally specified. The contract documents permitted paint on the faying surfaces, providing a slip coefficient of 0.33 for the paint was established. The fabricator elected instead to take advantage of the requirement for SSPC SP-6 cleaning (commercial blast) and use a slip coefficient of 0.5. With these basic decisions made and approved, the joint de-

signs were made and submitted to the EOR for review and approval. All joint calculations and drawings were reviewed carefully prior to approval. Most of the joint designs were found to be satisfactory on first review. Some of the more complex joints were the subject of a face-to-face meeting between the fabricator's engineers and the EOR, where joint geometry, design approach and other concerns were discussed and agreed upon. In summary, the ASCE guidelines concerning joint design worked well on this project because both parties approached the process openly and in a professional manner. We have used this process on other projects involving other detailers and fabricators, and believe that for complex structures it is a good arrangement.

Construction Schedule Ambitions

The construction schedule was as ambitious as that for design, allowing only 20 months. Erection of the structure began with the warehouse-like support complex, which is one-story joist and beam construction, and proceeded towards the EF line. Then, the E and F cylinders and the columns and bracing between them were erected. Next, the B and C cylinders and

the BC line steel were erected. The erector then began assembling the main trusses on the floor of the high-bay area.

The final erection procedure made one change from the engineer's proposed sequence. Rather than lift single half trusses the erector chose to assemble quarter span "boxes" on the floor. These boxes consisted of quarter lengths of two north-south ("TS") trusses tied together with the appropriate sections of the east-west ("TL") trusses. They were 42 ft wide, and about 88 ft long. The first quarter was lifted and connected to the BC line columns, with the end resting on temporary 72-ft high towers. The second quarter was then lifted and supported on quarter and mid-span towers. After the quarter point splice was made up, the quarter span towers were moved to the other side (the 3/4 point) and the other two quarter span units erected in similar fashion. Finally, the mid-span splice was bolted up and the mid-span tower removed. This basic procedure was followed for most of the roof structure, with some modifications in the triangular areas.

On Jan. 12, 1989, the Navy and the Air Force jointly cut the ribbon on the new complex, as the kick-off of the Armed Forces Review and Awards Ceremony for President Ronald Reagan. The complex was presented to the President as part of a farewell exhibition by the Joint Chiefs of Staff and the Departments of the Army, Navy, Air Force, Marines and Coast Guard. □

FREE !! PLANE FRAME ANALYSIS PROGRAM

That's right, for just a nominal charge to cover materials and handling (\$19), we will send you our powerful PLANE program. This is our full-blown PLANE, not a watered down version. How can we possibly afford to do this? It is because we are convinced that once you've tried our software, you will be back for more.

You will also receive all of the required documentation, as well as information regarding our 80+ programs for concrete, steel, timber and post-tensioned concrete design, including design and graphics modules for PLANE. Our programs are developed to run on IBM-PC, -XT, -AT and most compatibles.

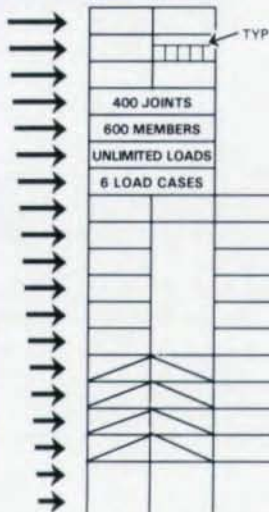

YES, Please send me PLANE @ \$19 to cover materials and handling.

NAME _____ COMPANY _____

STREET ADDRESS _____

CITY/STATE/ZIP _____

PHONE () _____ COMPUTER _____

MASTERCARD VISA ACCT. NO. _____ EXP. DATE _____ CHECK ENCLOSED

SIGNATURE _____ TITLE & DATE _____

SAI *The Most Productive Structural Design Software Since 1966*
STRUCTURAL ANALYSIS, I NC.
429 Fifth Avenue • Indialantic, Florida 32903 • (407) 727-1562 • (407) 640-6047

Architect/Engineer

Daniel, Mann, Johnson & Mendenhall

Construction Manager

Chesapeake Division,
Naval Facilities Engineering Command

General Contractor

The George Hyman Construction Company

Fabricator

Lehigh Structural Steel Company

Owner

United States Air Force

Andy Savage is the head of the structural section in the Washington, D.C. office of Daniel, Mann, Johnson and Mendenhall (DMJM).

Soda... designs your

• least-weight steel structure fast... and automatically

Finally, a practical structural engineering software package that not only analyses but automatically designs a least-weight (optimal) steel structure.

SODA represents the perfect blending of state of the art structural engineering and modern optimization research. SODA is a truly practical steel design optimization package that permits the designer to concentrate on engineering instead of routine calculations, thereby reducing design time and costs.

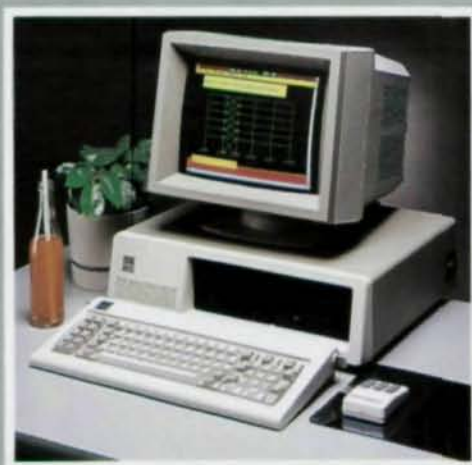

SODA automatically and completely designs a least-weight planar steel frame or truss from section databases in complete conformance with design code requirements. The design by SODA is complete, constructable and ready to implement. There is no need to re-analyse and re-size as is the case with other steel design programs. The software designs not only member by member, but by considering

the entire structure as a system. The design satisfies both strength and deflection requirements.

- Design codes supported:
 - AISC WSD 1978 Specification
 - AISC LRFD
 - Canadian CAN3 - S16.1 - M84 Limit States Design
- Microsoft® Windows environment
- Mouse or keyboard interaction
- Members selected from AISC or CISC database or from user's custom data base
- Comprehensive yet concise user's manual
- 30 day evaluation period, refund if not satisfied
- Runs on IBM PC XT/AT or compatible
- Minimum 640 KB and hard disk required

* - Microsoft is a registered trademark of Microsoft Corporation

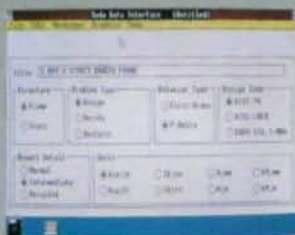

Input and editing is quick and easy.

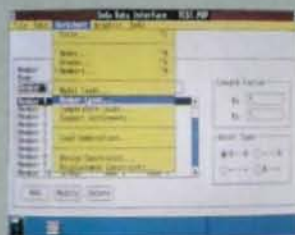

User interface is accomplished with mouse and drop down menus.

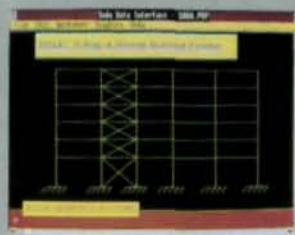

Graphics displays are accessible at any time.

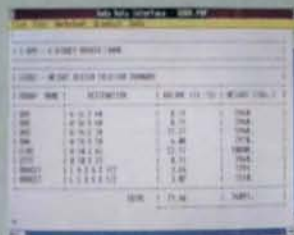

The optimal design is presented in a logical and concise manner.

TO GET MORE INFORMATION ON SODA, CALL OR WRITE:

WATERLOO ENGINEERING SOFTWARE

22 Dupont Street East

Waterloo, Ontario

Canada N2J 2G9

OR CALL COLLECT (519) 885-2450

soda

**STRUCTURAL
OPTIMIZATION
DESIGN AND ANALYSIS**

See us at the AISC National Steel Construction Conference

Bank of China invests in connection security

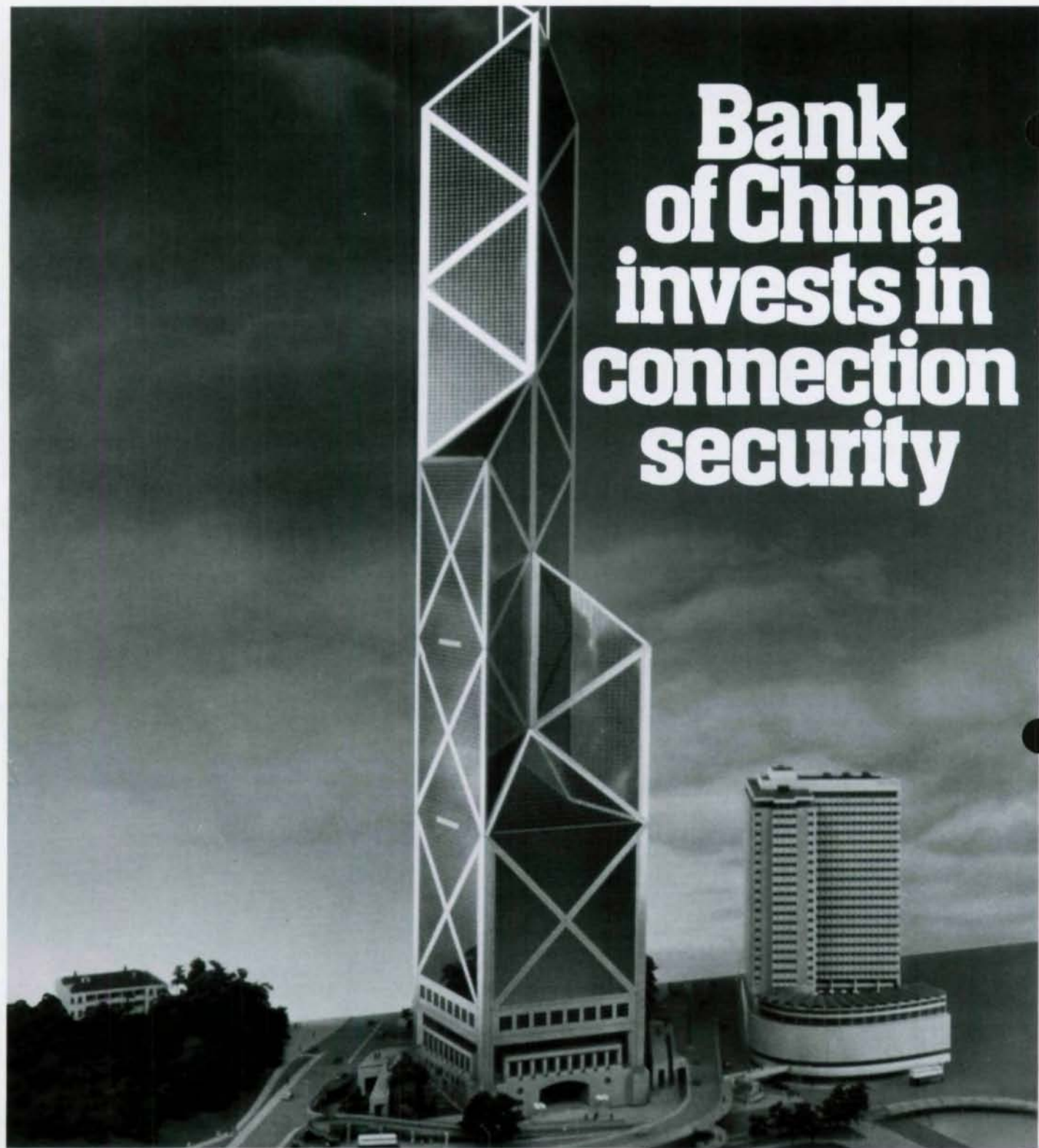

DTIs used on 1,209-foot headquarters building in Hong Kong

High, accurate clamping forces are essential in slip-critical connections of high-rise buildings. But when the building is the fifth tallest in the world and wind load requirements are extreme—two times those of New York and four times larger than the equivalent earthquake load requirement of Los Angeles—these clamping forces become all the more important.

That's why Direct Tension Indicators were specified by Leslie E. Robertson Associates

and used on the soaring Bank of China tower in Hong Kong.

Not only do Direct Tension Indicators assure proper bolt tension every time, so there's no guesswork, but they also eliminate expensive, inaccurate, and potentially hazardous torque wrench inspection. Plus, DTIs save on inspection costs.

Direct Tension Indicators from J&M Turner, Inc. An excellent investment in quality assurance. Specify American-made Direct Tension Indicators to ASTM F959-85 on your next structural steel project.

For more information, write to:
Jonathan Turner, J&M Turner, Inc.,
1300 Industrial Blvd., Southampton, PA 18966.
Or call 1-800-525-7193.



J & M Turner Inc.

The bolting quality assurance people.

See us at the AISC National Steel Construction Conference

Innovative Steel Bridge Tested in Laboratory

A large experimental test program to evaluate the behavior of an innovative two-span continuous plate-girder bridge with precast prestressed deck panels has recently been completed at the Federal Highway Administration (FHWA) Turner-Fairbank Highway Research Center in McLean, Va. The project was sponsored jointly by the American Iron and Steel Institute (AISI) and the FHWA. The bridge represented an 0.4 scale model of a two-span continuous plate girder bridge designed using Alternate Load Factor (Autostress) Design procedures.

The project was coordinated by the consulting firm of Wiss, Janney, Elstner Associates, Inc. of Northbrook, Ill. who served as a subcontractor to AISI, with assistance from AISC Marketing, Inc. of Pittsburgh, Pa. Personnel from Bethlehem Steel Corporation, USS, a division of USX Corporation, and the Armco Steel Corporation also contributed.

The project was overseen by an AISI Advisory Panel consisting of industry personnel, FHWA personnel, selected state bridge engineers and members of academia. Fabrication and erection of the model bridge was completed by Atlas Machine and Iron Works, Inc., Gainesville, Va. Precast components were fabricated by Shockey Bros. of Winchester, Va. and post-tensioning was completed by the VSL Corporation, Springfield,

Va. Load fixtures for the model bridge were fabricated by Salisbury Steel, Salisbury, Md. Laboratory testing was accomplished by FHWA personnel and data analysis is the responsibility of AISI.

Mark Moore of Wiss, Janney and Michael Grubb of AISC Marketing, Inc. will present a paper on the bridge as part of the upcoming National Steel Construction Conference at the Opryland Hotel. The paper will be presented twice Friday, June 23: from 10:30 to noon and again from 3:30 to 5:00 p.m.

Alternate Load Factor Design (ALFD) is a limit-states design approach that more realistically approximates the actual behavior of continuous steel members at higher loads than present design procedures. ALFD recognizes and takes advantage of the ability of continuous steel members to adjust automatically for effects of controlled local yielding. ALFD aims to maintain simplicity of completed steel structures to minimize total cost, including fabrication, and to provide better performing steel structures less susceptible to fatigue damage. Significant fabrication cost savings are possible over steel bridges designed using more traditional methods.

An AASHTO guide specification presently permits the use of ALFD for braced compact sections. The model-bridge study is part

of a comprehensive AISI research program to extend ALFD procedures to non-compact girders with slender webs. An equally important objective of the project was to study the behavior of a bridge with composite modular precast deck panels fully prestressed in both the transverse and longitudinal directions. Modular precast prestressed deck panels offer potential savings in bridge rehabilitation work, as well as the potential for better performing concrete decks in new bridge construction.

The model bridge consisted of three plate girders, with two 56-ft spans, transversely spaced at approximately 6 ft-9 in. and supporting 4-in. prestressed modular deck panels. This corresponded to a prototype bridge with two equal spans of 140 ft, an overall width of 48 ft and girders transversely spaced at 17 ft with 10-in. thick deck panels.

Because the prototype was designed using ALFD procedures, the girder design was clean and efficient, with a minimal number of flange transitions and plate-thickness changes. The precast deck panels permitted significantly wider girder spacings in the prototype than are traditionally used, which generally offers significant economies in steel bridge construction because of the fewer number of pieces to fabricate, ship and erect.

(continued)

Post-tensioning of precast deck



Model bridge under construction

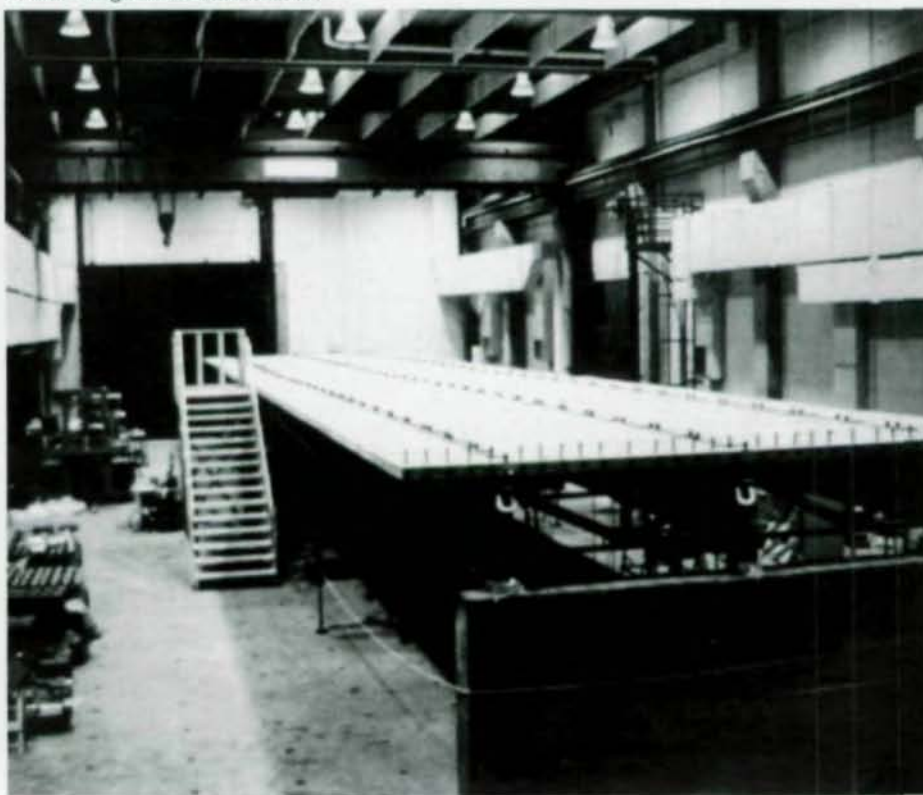



Mark Moore

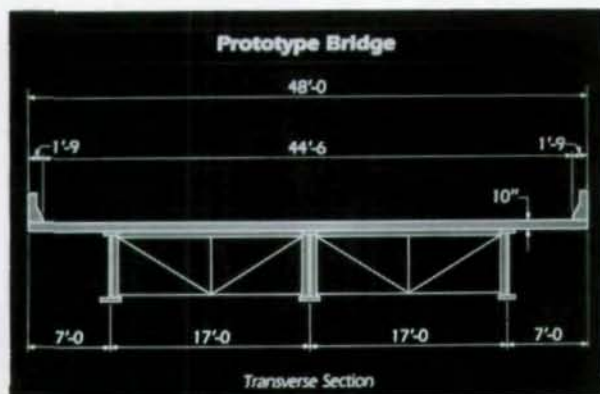

Transverse section of prototype bridge

The model bridge was subjected to a comprehensive series of tests at each of the three AASHTO factored design load levels: service load, overload and maximum load. At the service-load level, experimentally-determined elastic wheel load distribution factors were compared with factors computed from a finite-element model of the bridge and factors computed using present AASHTO procedures. Limit-state criteria introduced to continuous-bridge design in ALFD, such as the formation of automoments and the shakedown phenomenon at overload, were illustrated experimentally. The available

reserve strength at maximum load was determined and found to be significant, demonstrating the adequacy of the plastic mechanism analysis introduced in ALFD procedures at maximum load. Deck-panel behavior was also analyzed at all three load levels.

It was apparent from the test program that the ALFD limit-state criteria were sufficient to satisfy the structural performance requirements for this bridge at each load level, and that modular precast prestressed deck panels can perform satisfactorily over an entire range of loading. Data from the test will continue to be analyzed over the next year.

AISC Announces 1989 Steel Bridge Competition

AISC will accept entries until June 16, 1989 for the 1989 Prize Bridge Awards. Bridges will be judged in 10 categories: long-span, medium-span/high-clearance, medium-span/low-clearance, short-span, grade-separation, elevated highway or viaduct, movable-span, railroad, special purpose and reconstructed.

To be eligible for the 1989 contest, a bridge must be within the U.S. or its territories and be built of structural steel fabricated in the U.S. The bridge must have been completed and opened to traffic during the three year period July 1, 1986 to June 30, 1989.

Since 1928, AISC has honored outstanding bridge designs using structural steel aesthetically, imaginatively and effectively. The competition recognizes the versatility of steel as a bridge material and encourages improvement in design and construction of bridges which enrich the American landscape. In promoting a broader appreciation of the creative, functional and aesthetic excellence of steel bridges, AISC also pays tribute to the vision and skill of the persons who plan, design and build them.

Entries must be postmarked before June 16, 1989. Entry forms are now available from AISC, 400 N. Michigan Avenue, Chicago, Ill. 60611 (312/670-5422).

TRAVELIFT®

best in the long haul!

When you make an investment in material handling equipment that your entire operation revolves around, you want that investment to be there, fully operational, whenever you need it.

We call it being there for the long haul! MI-JACK TRAVELIFTS have been making the long haul for over 25 years. In industrial and construction applications throughout the world, TRAVELIFTS have improved production efficiencies as much as 400%; reduced manpower requirements by 50% and increased lift capacities in the bargain.

TRAVELIFTS outlift other types of crane, with less crew, and transport their loads virtually anywhere in a production area or yard, **WITHOUT FEAR OF TIPPING!** If you think that's a tall statement, we'll be happy to demonstrate the efficiency and ability of the MI-JACK TRAVELIFT. We can arrange a demonstration on a similar application, or bring in a movie of the TRAVELIFT making the long haul.

20' TO 60' ICW
20' TO 40' HOOK HEIGHT
20' TO 50' WHEELBASE

MI-JACK PRODUCTS

3111 West 167th Street
Hazel Crest, IL 60429

1-312-596-5200
TELEX: 27-0177

Fabrication and Erection of Minneapolis Convention Center

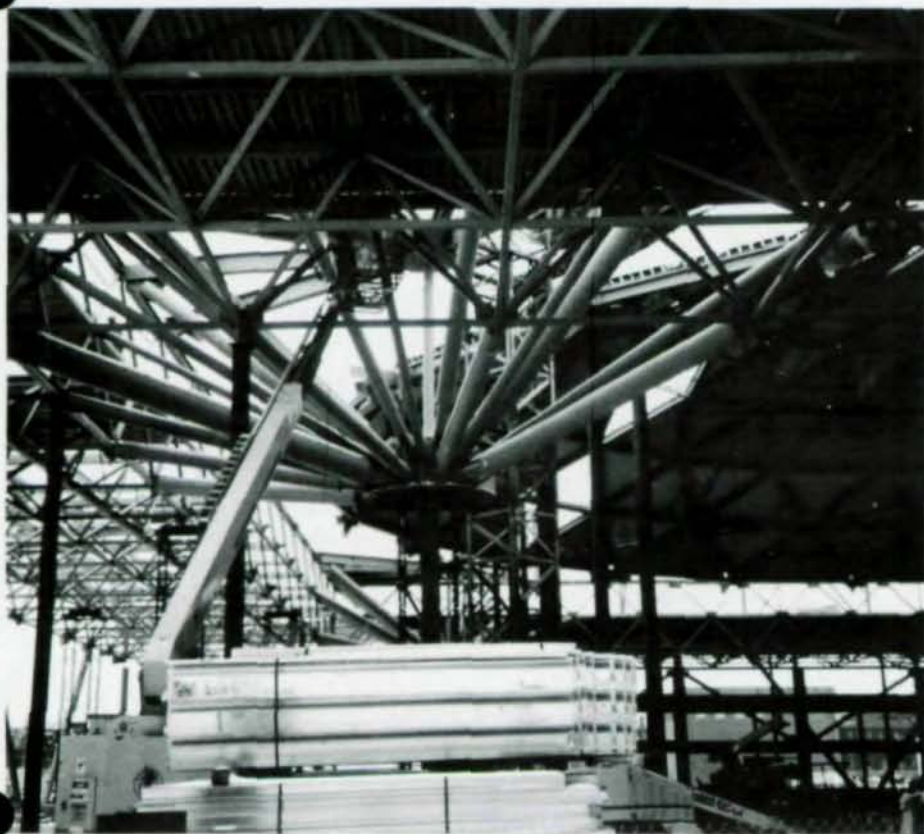

Welding of support pipes for dome

The new \$120-million dollar Minneapolis Convention Center is part of the city's plan to maintain an economically strong downtown core. It is the latest addition to a list of civic projects that include a concert hall, stadium, pedestrian mall, parking ramps, enclosed pedestrian walkways and a sculpture garden. Two major department stores and a half-dozen high-rise office buildings 20 to 60 stories tall have also been constructed recently.

The key feature in the convention center complex is the main exhibition hall, 842 x 330 ft with only 12 interior columns. The dominant architectural and structure feature is three lamella domes. Each dome, 210 ft in diameter with a 48-ft rise, is supported on four columns 45 ft above the floor.

Surrounding each dome are four 225-ft long x 15-ft deep transfer trusses. These form a transition between the domes and the surrounding triangular space truss which spans to the exterior wall columns. The entire structure, with the exception of some roof infill beams, is fully welded without any expansion joints. There are an estimated 10,000 welded connections in the structure. Longitudinal

bracing is provided at the midpoint of the long wall and transverse bracing at the end walls.

The entire structure is so complex structurally that it could only be analyzed as a single continuous frame. In an effort to optimize the structure, a least-weight approach was used. As a result, member sizes vary constantly through the structure. For example, dome members are W14 sections, varying in weight from 159 lbs./ft to 22 lbs./ft. Space frame members were either TS8x8, TS8x4 or TS5x5, but they vary from $\frac{3}{16}$ in. wall to solid steel members. Each space frame chord had an average of five welded splices even though the longest assembly was about 52 ft.

The complex geometry, the variation in member sizes and the extensive amount of welding presented a challenge to the contractor in detailing, fabricating and erecting the structure. New material specifications were needed for some of the unique heavy plate members and their connections.

Both geometry and the requirement for full-welded connections dictated that the various units be delivered in as large an

assembly as possible. With the fabrication shop only five miles from the site, it was possible to deliver the domes in diamond-shaped assemblies up to 24 ft wide, transfer trusses in 15-x 75-ft sections and the space frame assemblies—7½ ft high, 15 ft wide and approximately 52 ft long.

Material Considerations

The structural engineer for the project specified a minimum Charpy V notch value



Lawrence A. Kloiber

STATE OF THE ART
Personal Computer Software
for Structural Engineers

SAP90™ - General Analysis
& Design
ETABS® - Building Analysis
& Design
SAFE™ - Slab Analysis
& Design

Developed by Edward L. Wilson
and Ashraf Habibullah

- Internationally recognized developers & capacity
- Unmatched performance
- Thorough documentation & verification
- Extensive user support & backup
- Interactive graphical model generation

For more
information,
contact:

Computers & Structures, Inc.
1918 University Avenue • Berkeley, CA 94704
(415) 845-2177 • FAX (415) 845-4096
5101003830 CSI BERKELEY



See us at the AISC National Steel
Construction Conference

of 20 ft.-lb. at 40° F. in accordance with the ASTM A673 test procedure for material over 1½ in. thick. To meet these requirements, a cooperative effort of the structural engineer, project engineer, construction manager, producer technical representatives and fabricator at an independent testing laboratory was required. A new test procedure was devised and, based on results, the final material was furnished fully killed, vacuum de-gassed to low sulphur and fine grain practice. The plates were cross-rolled and normalized, and ultrasonically tested to ASTM A435 100% scan. No material cracking was encountered in making the various welds. Material cost was, of course, substantially higher than the published mill prices for original material specification.



Space frames in assembly fixture

Erection

Because the extensive number of welds, many of them out of position, made alignment and stabilization in mid-air difficult, safety and economy dictated the use of as much ground assembly as possible. The domes were assembled completely on the ground and jacked into place. Deflection surveys indicate the structure is performing satisfactorily.

Architect for the project is the MCC Collaborative (Setter, Leach & Lindstrom; The Leonard Parker Associates; Loschky, Marquardt & Nesholm). The structural engineer is Skilling, Ward, Magnusson and Barkshire; construction manager, Mortenson/Barton Malow; the erector, Danny's Construction; the prime steel contractor, L. L. LeJeune Company.

Fabrication and erection of the Center is the topic of a presentation by Larry Kloiber, president of L. L. LeJeune Company, at the National Steel Construction Conference in Nashville, Tenn., and the ASCE Structures Conference in May. The NSCC presentation is scheduled for Saturday morning, June 24. Kloiber's paper is also a part of the NSCC Proceedings, available after July 1.

Guess What's Coming Soon?

A NEW WORLD CLASS BOLT AND NUT MANUFACTURING PLANT TO PRODUCE DOMESTIC HIGH STRENGTH FASTENERS.

- TENSION CONTROL BOLT, 2H NUT & WASHER ASSEMBLED
 - HIGH STRENGTH HEX HEAD BOLT, NUT & WASHER ASSEMBLED
 - HIGH STRENGTH 2H NUTS

VISIT OUR BOOTH #E
AT THE 1989 NEC/COP
CONFERENCE, JUNE 21/24



NOW UNDER CONSTRUCTION

FOR INFORMATION CALL 1-800-782-4544



LOHR Structural Fasteners, Inc.

P.O. Box 1387 • Humble, Texas 77347

UNYTITE



N·R·G Flor[®] from Walker.

After 30 years, it's a better value than ever.



N-R-G Flor cellular floor is at work in buildings like Chicago's Sears Tower and Amoco Building, IBM Headquarters in New York, and the Hewlett Packard Building in Roseville, California. And its history of performance is only part of the story, because now N-R-G Flor is backed by a service package that's unique in the industry.

When you specify N-R-G Flor, you're also specifying national distribution through Walker's agent network. Single-source availability of cellular and non-cellular deck, bottomless and full-bottomed trenchduct and a wide range of service fittings. On-time delivery, sequenced however you need it. Factory labeling of every piece, with organized bundling and clear instructions. And backup service from a Walker project manager who's even available on-site if needed.

Behind every N-R-G Flor system are 30 years of structural expertise

and 60 years of experience and innovation in PLEC (power, lighting, electronics, communications) distribution systems. So your cellular floor is not only a code-approved structural element, but also a flexible, cost-efficient, engineered system of PLEC distribution.

Chances are any electrical contractor knows Walker. So ask around. You'll hear about a level of service that's more than unique—it's invaluable.

For a free copy of our N-R-G Flor Design Guide, call 1-800-222-PLEC.

U.L. classified and listed.



Walker[™]

P.O. Box 1828, Parkersburg, WV 26102 (304) 485-1611

A DIVISION OF BUTLER MANUFACTURING COMPANY

PLEC
DISTRIBUTION
ALTERNATIVES

Stronger, Faster Construction with Nelson[®] Stud Welding

Because of inherent advantages, Nelson stud welding has become the standard in many fastening applications in industrial and commercial buildings, bridges, power generating structures, military structures and rehabilitation.

Nelson studs literally anchor other members to the basic framework of structures. This design makes for maximum strength since the welds are actually stronger than the base metal.

Since stud welding is at least three or four times faster than hand welding, it impressively reduces total man hours on a job. At the same time stud welding does away with all the problems associated with holes in structural members—*weakening the main frame, sealing holes to prevent leakage, etc.*

All these factors inevitably add up to lower in-place anchoring costs. In some types of construction, most notably composite, further savings result from the use of lighter and less costly beams that also reduce building height and weight.

Call us toll free at 1.800.321.2005 and ask for our design literature, samples or application engineering assistance or write to:

TRW Nelson Stud Welding Division
7900 West Ridge Road
Elyria, OH 44036-2019

International:

England • France • Japan • Korea
West Germany • Australia

TRW

TRW Nelson Stud Welding Division
Controls & Fasteners Group

©TRW Inc. 1989 TRW is the name and mark of TRW Inc.

Applications

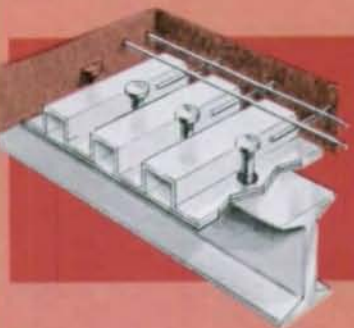

Composite Bridges – Shear connectors provide equal shear in all directions, eliminate distortion that might result from hand welding and permit more satisfactory compaction of concrete around the connectors.

Composite Buildings – Shear connector studs welded to the beam or through a permanent form steel deck result in increased live load capacity. As much as 20% less steel may be used and shallower floor sections reduce building height.



Retrofitting – Bridge retrofitting usually involves removing the old concrete and replacing it with new concrete tied to the beam with stud welded shear connectors.

Applying new facia and interior retrofitting of old buildings requiring installation of new electrical fixtures, sprinklers and piping can be accomplished by welding threaded studs to structural members.

Concrete Anchoring – Stud welded headed concrete anchors deliver specified axial tension and shear strength values and can be applied up to three times faster than hand welded anchoring devices. Other advantages include much higher yield points, elimination of costly set-up time for shearing and bending, stronger welds, reduced material handling and no distortion.



Insulation/Lagging – Stud welded fasteners secure all types of insulation material in all density ranges faster, easier, more economically and better than any other methods.



Precast/Prestressed – Because of their known values, anchor studs can be used in standardized designs for such connections as bearing plates for beams and tees, shear keys for tees, column baseplates, and various other embedded steel elements. In these applications, stud welding reduces cost per plate, ensures consistently high weld quality, frees certified welders for other jobs, eliminates long lead time and storage problems.

Electrical/Mechanical – Threaded studs and a variety of stud configurations are used to fasten conduit clamps, lighting fixtures, outlet boxes, sprinkler systems, cable runs and piping. Fast positive attachment is achieved without holes or costly clamping devices.

Other cost saving construction applications are securing concrete forming and timber shoring, wood nailers, crane and guide rails, grating, refractory and wear resistant materials.

When The Bridge Was Out, We Came Across.



Collapse tate N.Y.

erial view of Thomas E. Dewey Thruway after bridge collapsed.

Thruway Span Collapse Threatens Upstate N.Y.

15-MILE DETOURS SEEN FOR COMMUTERS

AMSTERDAM, N.Y. — There's no getting around it — without a lot of difficulty, that is. The Schoharie Creek Bridge failure last Sunday is going to be a headache for automobile commuters, as the Thruway...

that's not even counting delays to be added due to extra traffic. Because the bridge is expected to be out for nearly a year and a half, highway officials have asked businesses along the route to consider changing their hours of operation to allow motorists the extra time to increase traffic problems during rush hours.



BRIDGE COLLAPSE IN NEW YORK

All Other Bridges To Be Checked For Safety

AMSTERDAM, N.Y. — New York State Thruway faces a closure of up to a year or more following the collapse of the Schoharie Creek Bridge in upstate New York yesterday of the State Thruway Authority.



New York Thruway Extended

Few Alternatives Seen For Closing

ALBANY, N.Y. — New York State Thruway officials are in a quandary following the Sunday collapse of the Schoharie Creek Bridge in upstate New York near Amsterdam. More than 800 commuters are affected.

It was the worst flooding upstate New York had seen in thirty years.

As the swollen waters of the Schoharie Creek raged out of control, the four-lane bridge above it gave way. So, the New York State Thruway Authority faced some tough problems. They simply couldn't afford a prolonged bridge closure at this vital link of Interstate 90.

They didn't have to. The bridge fabricator responded to the urgent need with a tight delivery schedule. And Lukens backed our customer by committing to quick delivery of stripped steel plate. We both came across — two of the reasons the bridge was finished in nine months instead of the original estimate of eighteen.

Stripped plate comes from Lukens flame cut

up to 1250" long and down to 10" wide. So you don't need to invest in cutting equipment or use up valuable manpower and shop space. It's also delivered with prepared edges ready for fabrication. So it saves you time as well.

Solid reasons to consider Lukens stripped plate the next time you want to go over big. Ask for our brochure when you call Bob Wright, Application Engineering Manager, Lukens Steel Company, Coatesville, PA 19320. (215) 383-3342.

Lukens Steel

The specialist in plate steels.

WHEN CORNELL UNIVERSITY SUPER LONG SPAN JOIST

The people at Cornell had a problem. They wanted the interior of their field house to have large open spaces, but they didn't want to pay a fortune for the luxury.

Howard Alberding Field House, Cornell University

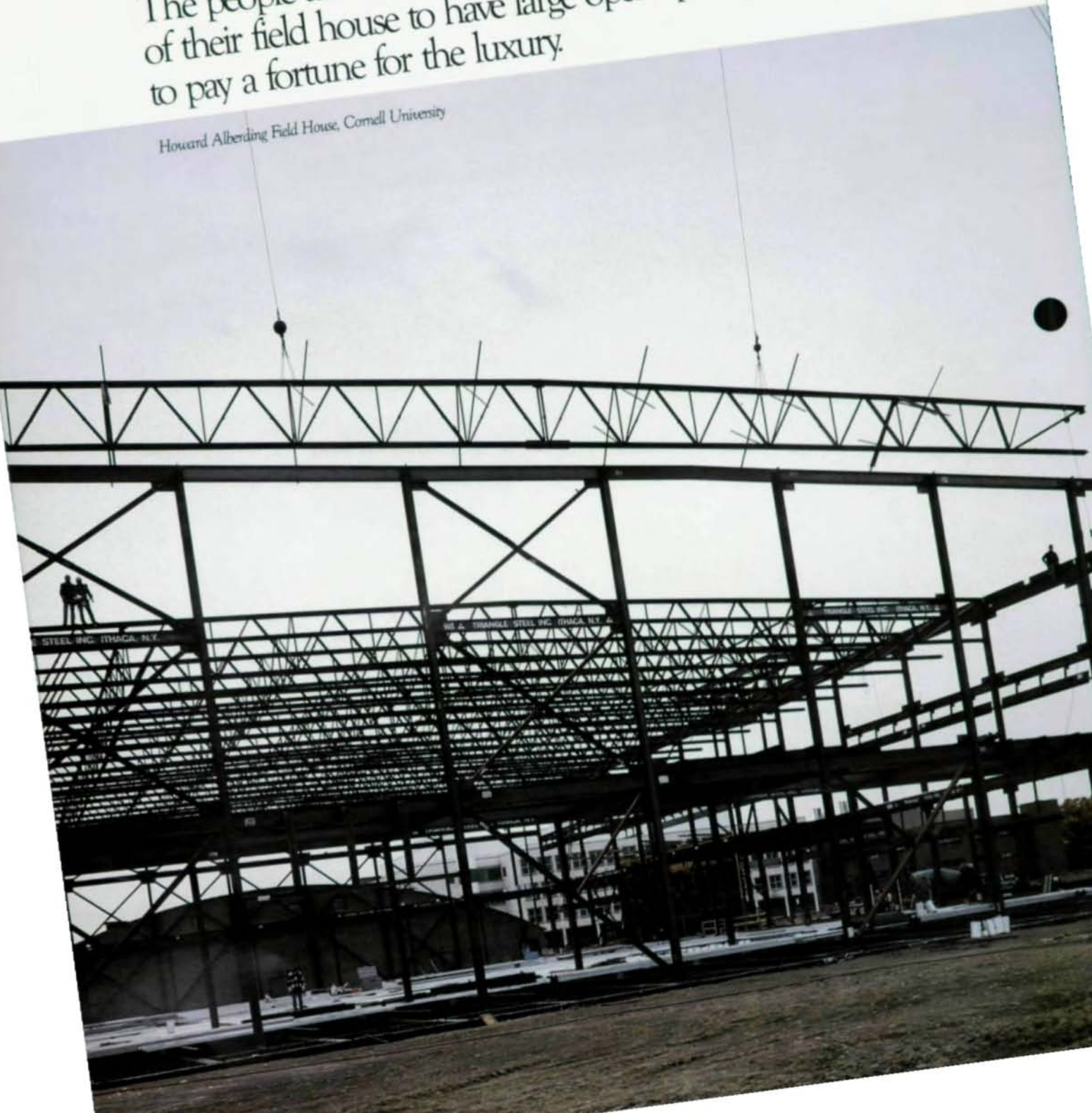

Imaginative Engineering

AIR FORCE ONE COMPLEX

Bigger than Big!

by Andrew J. Sauvage

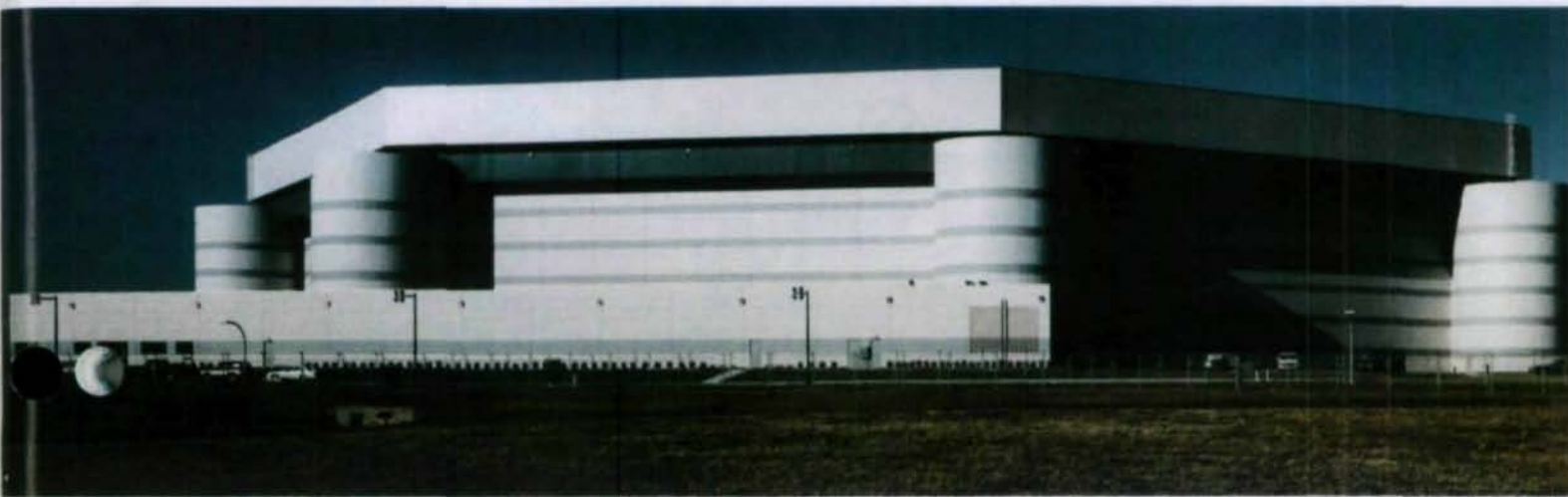

Looking north at support complex and hangar

Aircraft hangars in general tend to be large, long-span structures. The new maintenance and support complex for the President's "Air Force One" Boeing 747 aircraft is larger than large. Standing on the taxiway at Andrews Air Force Base, one realizes superlatives are inadequate. This building is just plain big. But it is more than big! It's a commanding, award-winning architectural design given shape and support by 3,500 tons of structural steel.

Design of the complex received the Air Force Regional Civil Engineer's Award for Design Excellence in the Eastern Region and the 1987 U.S. Air Force Honor Award for concept design excellence. In addition, the design of the exterior of the entire complex, a prefinished insulated steel panel system arranged in dark and light gray horizontal bands, was commended by the National Capital Planning Commission for the scale and consistent composition this scheme provides to the very large building.

The need for this facility was based on the government's decision to replace existing Presidential Boeing 707's used as Air Force One for more than 20 years with two new Boeing 747's, scheduled to arrive in November 1988, a delivery date which dictated an ambitious design and construction schedule. The A/E completed the concept, preliminary and final design of the 145,000-sq. ft High Bay area and the 50,000-sq. ft support complex in only nine months, including reviews by the Navy, Air Force and several environmental agencies—delivering the final working drawings on Feb. 12, 1987.

The unique building shape is a result of configuring the aircraft parking with two 747's in a 90°, nose-to-nose position. The complete building footprint integrates this basic V with other essential components such as aircraft doors, "pockets" for the retracted (open) doors and fire protection systems by using three basic shapes—rectangle, triangle and circle—to form an

elongated hexagon with a circle at each corner. The hexagon is 392 ft across flats and 611 ft across the points.

Several Design Considerations

There are several design considerations related to the hangar, or "high-bay" configuration. The three front sides of the building (drawing) are aircraft doors, with column supports possible only at points B and C. Columns are spaced along the other three sides. Considering the irregular shape of the roof, the structure must span across the north-south direction from the EF side to the BC side, where a major transfer truss carries the load to points B and C. The structure also must reach out in the east and west directions from the central rectangle to form the aircraft door openings along the AB and CD sides.

The two main aircraft doors are 6-leaf, horizontal-sliding, bi-parting doors. These doors, quite impressive structures all by themselves, were furnished by AISC Mem-

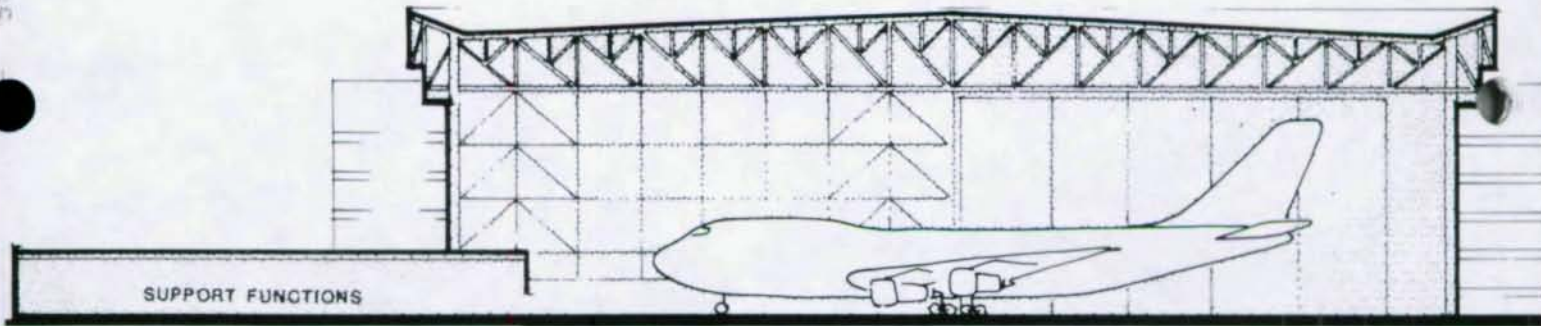

SECTION



Floor plan (above) of Air Force One hangar. Section (l.) shows immensity of project. Interior (r.) from "F," looking northeast toward CD door.

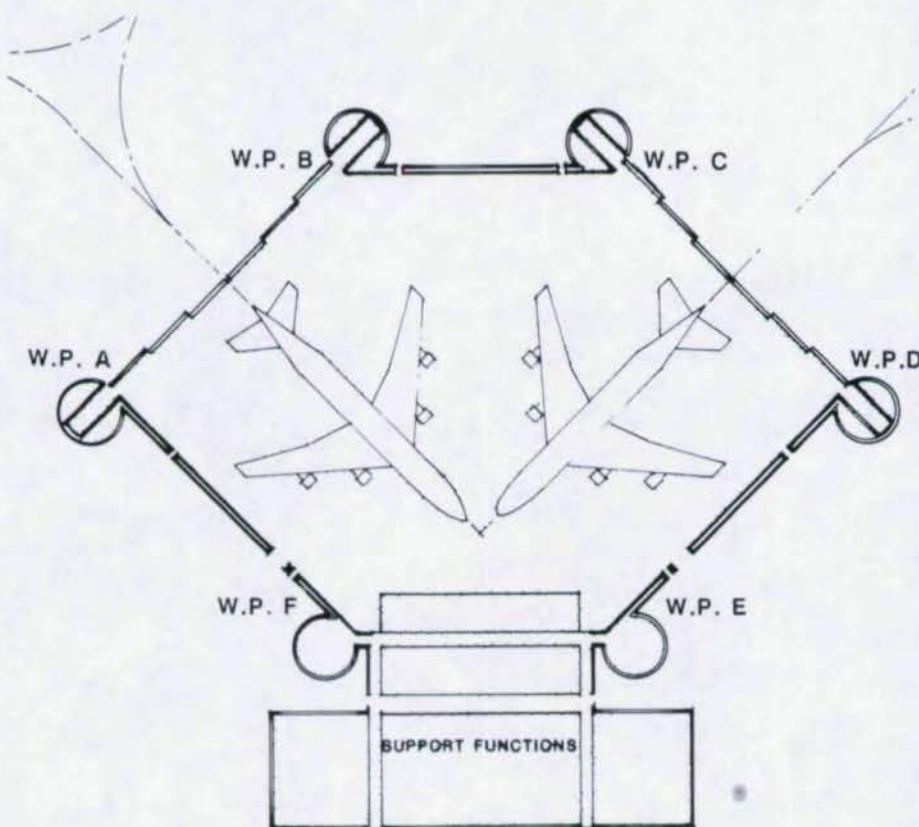

selected for design development. This system provides support and deflection control along the AB and CD lines (the main aircraft doors) and also results in a rigid, two-way horizontal structure to distribute lateral forces.

The method of analysis for this 3.7-acre roof structure was a major consideration. There are two basic possibilities. The first is to build a large computer model of the entire structure. The second is to make some basic (educated) assumptions about how the structure will behave, then isolate several planar substructures and proceed with a hand (or simplified computer) analysis. After some thought, the analysis method selected was—both! The reason for this dual analysis was a consideration of the erection process.

The roof structure was too large, heavy and complex to be built entirely on the ground and then lifted into place. How the structure would react to the dead load would depend almost completely on the erection sequence, but the complete space structure would resist future live loads as a single system. Since the space structure was the most efficient, consideration was given to requiring that the structure be erected with complete shoring, which would result in both dead and live loads being resisted by the space structure. However, after establishing the cost of the necessary shoring, this erection procedure was abandoned.

The computer analysis required building of a computer model with 23 nodes and 1,115 member elements. For the first analysis, member sizes were esti-

ber Fleming Steel Company. Three leafs slide each way from the center, nesting together as they reach the fully open position. The open doors require an external storage area, or pocket, appended to the main structure, with a total of four required at points A, B, C and D. In many hangar designs, these appendages are functional but uninspiring rectangles. The architect chose a cylinder shape for this structure, which helps focus attention to the corners of the hexagon without adding confusing and extraneous lines at these focal points. To balance the hexagon, two additional

cylinders were added, one for the fire-fighting foam equipment, the other to provide washrooms, locker rooms and house the aircraft washrack equipment.

The initial design effort focused on the clear-span roof structure for the high-bay area. Several options were investigated, including one-way trusses, a space truss and a cable-supported system. After considering these and other possible structures, a space truss system consisting of main trusses spanning the 354-ft (north-south) direction with secondary trusses spanning in the east-west direction was



mated, dead and live loads calculated and applied and a first analysis was produced using the GTSTRUDL program. Using member sizes obtained from this run, a second run was made, and deflections were plotted. After considering the deflections, several changes were made to the system, the most significant being an increase in truss depth from 24 to 28 ft. Then, back to the computer for another run, and then another design.

After the space structure analysis and design was completed, the second analysis began with a consideration of erection sequence. Based on this sequence (which was provided on the contract drawings), critical members and sub-systems were selected and analyzed for dead load stresses. These stresses were then added to the live load stresses obtained from the space-frame model, and the members were checked and revised as necessary.

Finally, truss assemblies identified by the erection sequence were analyzed for stresses induced during the lifting process. Since the erection process envisioned lifting one half of a truss onto temporary mid-span shoring, this involved checking members designed as tension diagonals for a relatively small compression load to insure that buckling would not occur.

Details, Details, Details

It is not enough for a structural design to be technically correct from a strength and serviceability (deflection) standpoint. Some one has to be able to build what has been designed, or the design is of no val-

ue. It was obvious from the beginning that the details of the structure would rival the analysis in complexity. The details of a complex steel job such as this are at least as important as the overall member design. Many basic decisions concerning the layout and orientation of members in the space truss were made based on the resulting joint configurations. For example, the "TS" trusses were behaving as simple-span members, so a classic diagonal configuration resulting in tension diagonals was possible. Double angles were chosen to simplify the connection at the chord-vertical-diagonal junction. The diagonals on the "TL" trusses were then configured to minimize junction with the TS diagonals.

Joint and splice details were effected by the size of the main truss chord members. The central TS truss chords, for the most part, fall into the ASTM A-6 Group 4 or 5 size classification—so called "jumbos." Bolted splices in tension members require consideration of the resulting net area and the overall member becomes larger than necessary in order to provide proper net area at the splice. For this reason, welded splices are more efficient and very appealing. It is fortunate that much attention has been given over the past few years to the problems arising from butt-welded tension splices in jumbo wide-flange shapes, because it is obvious the appeal of the welded splice is like the siren's song—jagged rocks wait. On Air Force One, all the jumbos are a A 572 Gr. 50, killed fine-grain steel and all splices in these members are bolted. (This design was carried out prior to the recent issue of Supplement

No. 2 to the AISC Specification, which presents new rules for design of jumbos subject to tensile forces.)

Another detail consideration affected the cylinders, or "pods." The major purpose of the structure of the cylinder is to form a round shape from straight metal panels, holding the panels in place against their own dead load, which is small, and wind loads, which are not. Originally, the design sought to take advantage of the inherent lateral strength of the 50-ft dia. cylinder. However, in order to make a tubular structure, it was necessary to provide extensive bracing between the vertical girt columns, since the siding panels would not provide this strength. After looking at the hundreds of small bracing members and attendant field connections for each one, the original design approach was pronounced to be elegant in theory but a lot of gingerbread (or in erector's parlance, "junk iron") in practice. The design was changed to a more mundane but practical rectangular braced core within the confines of the cylinder. The rectangular core in the A, B, C and D cylinders also lined up with the respective AB, BC and CD sides providing for an uncomplicated transfer of lateral forces from these sides.

Important Detail Decisions

One of the most important detail decisions concerned the layout and design of the joints in the structure, especially the truss joints. Two truths were evident from the start. First, the joints would be complex, and the actual joint details would have major impact on the cost of fabrication and

erection. Second, there are many acceptable details that can be conceived for any given joint, depending on which engineer, fabricator or erector (or combination of all three) looks at the joint.

The approach adopted is outlined in the ASCE "Final Report and Recommendations on Assignment of Authority and Responsibility for Design of Steel Structures." This report was endorsed by AISC in 1986. Under Sect. 3.1, the report states, "For complex steel structures, the EOR (engineer of record) may specify in the contract documents that the fabricator have a licensed professional engineer design the connections. In such cases, the EOR should still review and approve the connections."

This process worked well. The fabricator requested, and was granted, permission to use 1 1/8-in. A490 bolts in lieu of the 1 1/4-in. bolts originally specified. The contract documents permitted paint on the faying surfaces, providing a slip coefficient of 0.33 for the paint was established. The fabricator elected instead to take advantage of the requirement for SSPC SP-6 cleaning (commercial blast) and use a slip coefficient of 0.5. With these basic decisions made and approved, the joint de-

signs were made and submitted to the EOR for review and approval. All joint calculations and drawings were reviewed carefully prior to approval. Most of the joint designs were found to be satisfactory on first review. Some of the more complex joints were the subject of a face-to-face meeting between the fabricator's engineers and the EOR, where joint geometry, design approach and other concerns were discussed and agreed upon. In summary, the ASCE guidelines concerning joint design worked well on this project because both parties approached the process openly and in a professional manner. We have used this process on other projects involving other detailers and fabricators, and believe that for complex structures it is a good arrangement.

Construction Schedule Ambitions

The construction schedule was as ambitious as that for design, allowing only 20 months. Erection of the structure began with the warehouse-like support complex, which is one-story joist and beam construction, and proceeded towards the EF line. Then, the E and F cylinders and the columns and bracing between them were erected. Next, the B and C cylinders and

the BC line steel were erected. The erector then began assembling the main trusses on the floor of the high-bay area.

The final erection procedure made one change from the engineer's proposed sequence. Rather than lift single half truss, the erector chose to assemble quarter span "boxes" on the floor. These boxes consisted of quarter lengths of two north-south ("TS") trusses tied together with the appropriate sections of the east-west ("TL") trusses. They were 42 ft wide, and about 88 ft long. The first quarter was lifted and connected to the BC line columns, with the end resting on temporary 72-ft high towers. The second quarter was then lifted and supported on quarter and mid-span towers. After the quarter point splice was made up, the quarter span towers were moved to the other side (the 3/4 point) and the other two quarter span units erected in similar fashion. Finally, the mid-span splice was bolted up and the mid-span tower removed. This basic procedure was followed for most of the roof structure, with some modifications in the triangular areas.

On Jan. 12, 1989, the Navy and the Air Force jointly cut the ribbon on the new complex, as the kick-off of the Armed Forces Review and Awards Ceremony for President Ronald Reagan. The complex was presented to the President as part of a farewell exhibition by the Joint Chiefs of Staff and the Departments of the Army, Navy, Air Force, Marines and Coast Guard. □

FREE ! ! PLANE FRAME ANALYSIS PROGRAM

That's right, for just a nominal charge to cover materials and handling (\$19), we will send you our powerful PLANE program. This is our full-blown PLANE, not a watered down version. How can we possibly afford to do this? It is because we are convinced that once you've tried our software, you will be back for more.

Your will also receive all of the required documentation, as well as information regarding our 80+ programs for concrete, steel, timber and post-tensioned concrete design, including design and graphics modules for PLANE. Our programs are developed to run on IBM-PC, -XT, -AT and most compatibles.

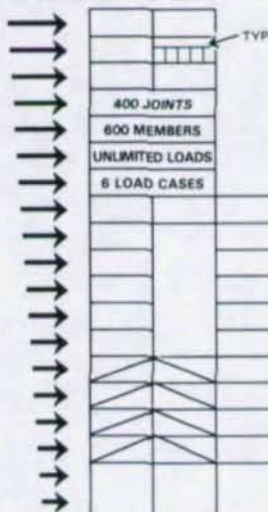

YES, Please send me PLANE @ \$19 to cover materials and handling.

NAME _____ COMPANY _____

STREET ADDRESS _____

CITY/STATE/ZIP _____

PHONE () _____ COMPUTER _____

MASTERCARD VISA ACCT. NO. _____ EXP. DATE _____ CHECK ENCLOSED

SIGNATURE _____ TITLE & DATE _____

SAI STRUCTURAL ANALYSIS, I NC. *The Most Productive Structural Design Software Since 1966*

429 Fifth Avenue • Indialantic, Florida 32903 • (407) 727-1562 • (407) 640-6047

Architect/Engineer

Daniel, Mann, Johnson & Mendenhall

Construction Manager

Chesapeake Division,
Naval Facilities Engineering Command

General Contractor

The George Hyman Construction Company

Fabricator

Lehigh Structural Steel Company

Owner

United States Air Force

Andy Sauvage is the head of the structural section in the Washington, D.C. office of Daniel, Mann, Johnson and Mendenhall (DMJM).

...TY SAW THE BID ON OUR S, THEY RAISED THE ROOF.

The construction schedule was tight. Speed was a factor too. The structural system had to go up fast.

The solution was Vulcraft super long span joists. One hundred and sixty feet long in this case. And ninety six inches deep. Vulcraft was able to manufacture and deliver them quickly and at a very reasonable price.

They arrived on the site in two sections and were easily bolted together, and hoisted into place. But time and money weren't the only reasons the architects recommended Vulcraft joists. They're super strong joists too. And they're aesthetically pleasing.

Vulcraft floor deck was also specified on the job. And to top it all off, so was Vulcraft acoustical roof deck.

A low price. A quality product. Fast delivery. Ease of assembly. Years of design experience. Those are the factors that keep Vulcraft coming out on top.

Contact your nearest Vulcraft plant or take a look at Sweet's 05100/VU and 05300/VUL product review.



Joist sections are easily assembled on site.

VULCRAFT

A Division of Nucor Corporation

PO Box 637, Brigham City UT 84302; 802/734-9433, *PO Box F-2, Florence, SC 29502 803/662-0381, PO Box 169, Fort Payne, AL 35967 205/845-2460, *PO Box 186, Grapeland, TX 75844 409/687-4665, *PO Box 59, Norfolk, NE 68701 402/644-8500, *PO Box 1000, St. Joe, IN 46785 219/337-5411, *Deck manufacturing locations. Architects: Gwathmey Siegel & Associates; General Contractor: William H. Lane Inc.; Consulting Engineer: Severud Szegedy; Steel Fabricator: Triangle Steel; Steel Erector: Binghamton Steel Erectors.



STEMFIRE

AISC Steel Member Fire Protection Computer Program

This new AISC computer program developed by Hughes Assoc. determines safe and economic fire protection for steel beams, columns and trusses. It is intended for use by architects, engineers, building code and fire officials, and others interested in steel building fire protection. STEM-FIRE is based on rational procedures developed by the American Iron and Steel Institute that extend the published Underwriters Laboratories, Inc., fire resistive designs to other possible rolled structural shapes and common protection material requirements. For a required fire rating, STEM-FIRE determines minimum spray-on thickness for various rolled steel shapes as well as the ceiling membrane or envelope protection for trusses. This methodology is recognized by Underwriters Laboratories, Inc. and has been adopted by the three national model building codes in the USA.

The software data base contains all the pertinent steel shape properties and many listed Underwriters Laboratories, Inc. *Fire Resistance Directory* construction details and their fire ratings. In this manner, user search time is minimized and the design or checking of steel fire protection is optimized. Hence, STEMFIRE is easy to use with little input effort to quickly produce specific design recommendations.

Minimum Equipment Requirements

- IBM PC, XT, AT or compatibles
- MS.DOS operating system
- One 5 1/4" floppy disk drive and hard drive
- 256K bytes of memory
- IBM compatible dot matrix printers or Hewlett Packard Laserjet

STEMFIRE Program Package

- Two 5 1/4" floppy disks containing executable software bearing AISC copyright
- Users Manual, with instructions and sample problems

Order Form

MAIL TO: AISC, STEMFIRE Order, P.O. Box 806276, Chicago, IL 60680-4124

I enclose payment of \$_____ for qty. of _____ STEMFIRE at \$96.00 each. (Member price: \$72.00. Please give AISC Membership Number _____)

Name & Title _____

Company _____

Address _____

City _____ State _____ Zip _____

Phone number (_____) _____
Area

Please enclose remittance. No C.O.D. orders. In New York, California and Illinois, add sales tax. Shipping charges prepaid in the U.S. On shipments outside the U.S., add 10% of total purchase for postage and handling. Visa and MasterCard accepted.

Check one: Visa MasterCard

Charge to my card # _____

Expiration date _____ Signature _____

See us at the AISC National Steel Construction Conference

*proudly celebrates its
10th Anniversary*

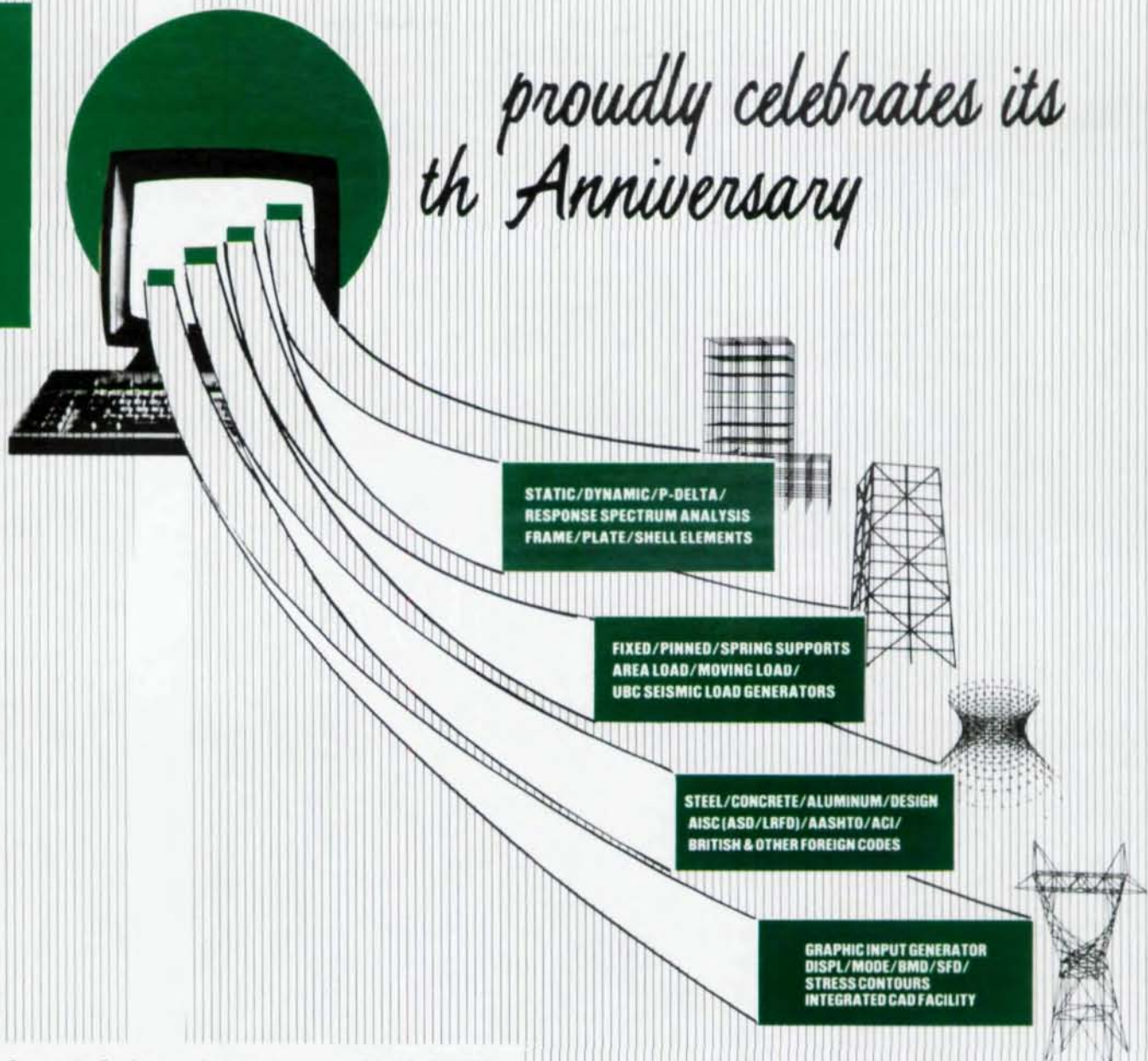

Research Engineers, Inc., creators of STAAD-III/ISDS, won't be commemorating the program's tenth anniversary with the usual fanfare. Instead, this energy will be directed towards extensive R & D and continued outstanding customer support. Striving to meet their users' needs, REI has established STAAD-III/ISDS as the leading software system of its kind. Computer-aided structural analysis and design ground is constantly being broken with STAAD. REI's mission throughout the next decade will be setting higher software standards and maintaining the leadership in the industry.



Research Engineers, Inc.

A reputation you can build on.

303 Pavilions at Greentree, Marlton, N.J. 08053, U.S.A.
Tel: (609) 983-5050 Tx: 4994385 Fax: (609) 983-3825

Steel Bridge Symposium Scheduled

The 1989 National Symposium on Steel Bridge Construction will be held Oct. 19-20 at The Shoreham in Washington, D.C. The symposium is a continuing dialogue between owners, designers and builders on state-of-the-art techniques in design, detailing, fabrication and erection of steel bridges.

First conducted in 1987, the symposium is co-sponsored by the Federal Highway Administration, American Association of State Highway and Transportation Officials, American Institute of Steel Construction and the American Iron and Steel Institute. The 1½-day meeting for owners, designers and builders targets topics to assist the industry in improving steel bridge economy, quality and reliability.

The 1989 Symposium program will deal with matters of great concern to all involved in steel bridge design, construction and maintenance. Lectures and presentations will feature leading experts on paint systems, weathering steel, bolts and bolting, design of longitudinal welds and jointless bridges. Case studies of several recent unique bridges (Staley Viaduct, Minnesota's High Bridge, Cooper River Bridge) will be headlined, as well as a discussion on the evolution of steel bridge design in the State of Maine.

The new *Bridge Fatigue Guide* and the AASHTO/AWS *Welding Code* will be reviewed, and status reports presented on the Bridge & Structures Information Center and the Council for Advancement of Bridge Technology. Another segment will consider methods for integrating efforts of the various members of the bridge team during both planning and construction.

A highlight of the 1989 meeting will be presentation of awards to the winning designers in AISC's 1989 Prize Bridge Competition. The presentations will be made at the symposium dinner Thursday evening, Oct. 19. Entries will be accepted until June 19 for the competition (write AISC, Awards Committee, 400 North Michigan-8th Floor, Chicago, Ill. 60611-4185 for entry forms).

For symposium registration information contact AISC, Membership Services Department, 400 N. Michigan, Chicago, Ill. 60611 (312/679-2400).

Photo courtesy St. Louis Screw & Bolt Co.

Snug Tight Makes Steel More Competitive

by Eddie Williams

AISC's "Supplement Number One to the Specification for the Design, Fabrication, and Erection of Structural Steel for Buildings" offers the potential of substantial savings to owners of most newly constructed steel-framed buildings.

This revision required that bolts, with a few specific exceptions, be tightened only to the snug-tight position. Potential direct savings are:

1. Fewer bolts and washers required by the fabricator.
2. Less labor and equipment required result in a reduction of 7% to 10% in the cost of tightening bolts. Bolts may be tightened by hand on small jobs or with a small air or electric-powered wrench on larger jobs.
3. Only visual inspection is required to insure the plies of the connected elements have been brought into snug contact. This eliminates the cost of checking bolts with a hand torque wrench, a practice still widely used, although not recognized by AISC.

Perhaps the most significant savings is in the overall job schedule. Time saved in initial labor (and the elimination of the possibility of the bolt crew being called back to re-tighten bolts which did not quite meet the inspector's desired torque requirement and subsequent re-inspection) translates into days saved in total job completion. This can produce a substantial savings on jobs with critical completion dates.

Engineers and independent inspectors do not fully understand the testing procedure for snug tight. Even on projects where the revision is being used, inspectors continue to use hand torque wrenches to check bolts.

An article, "Labor-saving Tactic Ignored," appearing in the Feb. 11, 1988 issue of *Engineering News-Record*, stated "a golden opportunity to make steel construction more competitive is being missed." I agree that "an opportunity is being missed," but I strongly disagree that the reason for the revision "not catching on" is the fault of steel erectors. The main reason the revision is not being used is that engineers and architects do not address the revision requirement which states: "Bolts to be tightened only to the snug-tight condition shall be clearly identi-

fied in the contract documents and erection drawings."

So that the owner can receive any savings, this requirement must be satisfied on the bid documents. At the present, this procedure is being followed on very few projects. If the contract documents do not address the revision, erectors and fabricators' only recourse is to seek clarification on each individual project. The typical response from architects and engineers is either, "I've never heard of the revision" or "I've always required my bolts to be torqued and I don't care what the revision says, I'm not changing."

On May 5, 1988, the North Carolina Chapter of American Society of Civil Engineers, Structural Technical Group co-sponsored with the Steel Erectors Association of Virginia and the Carolinas (SEAVAC) and the Virginia/Carolinas Fabricators Association a seminar on latest AISC bolt requirements. Lewis Burgett, associate director of Education of AISC, presented a very informative talk and then participated, along with an erector, fabricator, engineer and testing lab inspector, in a panel discussion. Burgett also spoke at SEAVAC's annual convention on Oct. 29, 1988.

SEAVAC has urged its members to request, prior to bid time, that the architect or engineer clarify the bolt requirements for each job. Along with the written request will be sent a copy of Supplement Number Two.

The three groups also plan to mail copies of the supplement to engineers and independent testing labs in North Carolina, South Carolina and Virginia requesting they become familiar with the new supplement and help implement its use.

I hope interested parties in other areas will take positive steps to implement use of the snug-tight revision. Use of this revision will make steel construction more competitive with concrete construction. AISC and SEAVAC will be glad to assist groups in other areas in setting up educational programs. □

Eddie Williams is president, C. P. Buckner Steel Erection, Inc., Chapel Hill, North Carolina and first vice president, SEAVAC. His address is P. O. Box 3634, Chapel Hill, N.C. 27515.

Unique Rehab

BOSTON EDISON NO. 514

Victorian Powerhouse Fires Up

by Alexander Newman

The last two decades have brought radical changes to Boston. Several major office towers have been built downtown, many new businesses, shops and hotels have displaced dilapidated and abandoned buildings.

This revitalization created many new jobs in the city—and increased vastly electricity demands. On some unusually hot summer days, the entire workforces in several buildings have been dismissed early to avoid circuit overloads from air conditioning. It became clear radical steps were needed to bring more electrical power into the city.

Power Hungry

The plan developed by Boston Edison, the city's largest power supplier, called for direct delivery of power generated in New England and Canada to downtown Boston. To accomplish this task, a new 345-kv transmission line was to be extended directly into the downtown, for the first time. Somewhere, this 345-kv power would have to be transformed to 115 kv that could be distributed throughout the city by existing high-voltage lines. To make this ambitious plan work, two huge electrical transformers and a forest of switchgear were needed.

Ordinarily, because of the weights and bulk involved, this type of equipment is placed at ground level on a 5-acre site. Not surprisingly, no such site could be found in the busy Boston downtown. One location available—and already owned by the power company—was Boston Edison's Kingston Street Station No. 514, only a decade old. This one-story facility, on a



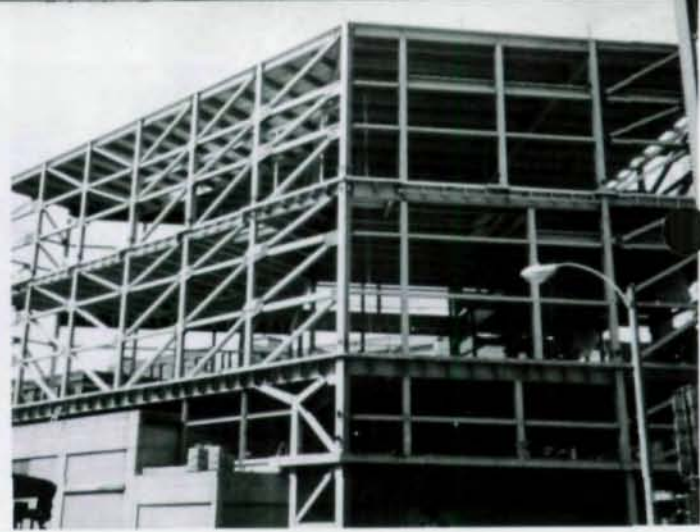

First part of truss erected (l.). . . and completed truss spans existing station.

RISA-2D

RISA-2D (R) Rev. 2.0
Copyright (c) RISA Technologies, 1997

Node	X	Y	Secondary Conditions	Node	Support	File Type
No.	Coord.	Coord.	X	Y	Stays	
5	4.00	12.00			1	58.00 P1-DIAG
6	8.00	16.00	STORY 2			58.00 P1-DIAG
7	8.00	24.00	STORY 3			58.00 P1-DIAG
8	8.00	32.00	STORY 4			58.00 P1-DIAG
9	8.00	40.00	STORY 5			58.00 P1-DIAG
10	8.00	48.00	STORY 6			58.00 P1-DIAG
11	8.00	56.00	STORY 7			58.00 P1-DIAG
12	18.00	8.00		8		58.00 P1-DIAG
13	18.00	0.00				58.00 P1-DIAG
14	18.00	16.00				58.00 P1-DIAG
15	18.00	24.00				58.00 P1-DIAG
16	18.00	32.00				58.00 P1-DIAG
17	18.00	40.00				58.00 P1-DIAG
18	18.00	48.00				58.00 P1-DIAG
19	18.00	56.00				58.00 P1-DIAG

RISA-2D breaks new ground in interactive frame and truss analysis and design. Very easy to learn and use, RISA-2D has become a preferred program for hundreds of structural engineering professionals.

- Edit your data using a unique, specially developed spreadsheet that is integrated directly into RISA-2D.
- Performs complete AISC Design, with suggestion of optimal sizes.
- Advanced graphics:
 - A SINGLE keystroke shows the entire frame, with loads and boundary conditions.
 - See the deformed frame with all members plotted in color according to their AISC code check values.
 - Fast and easy zoom windows.
 - Supports EGA, CGA, Hercules.
- Individual member analysis:
 - Loading, shear, moment and elastic curve diagrams.
 - Displays actual and allowable stresses and other values.
- P-delta effects.
- Analyze shear walls, with or without openings.
- UBC 88 lateral force calc's.
- Unparalleled speed of solution, giving displacements, reactions, end forces and AISC checks for all members.

RISA-2D is available for \$400. Call us today for a FREE demo package!

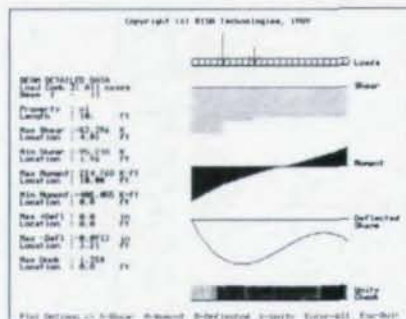
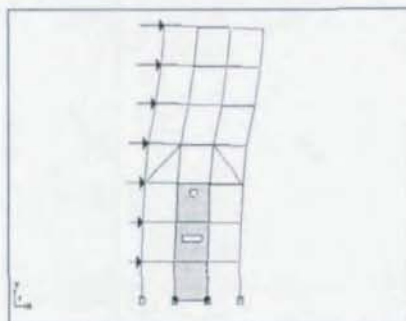

less than one-acre site, was designed to accommodate a future parking garage over it. Why not build a new substation there instead?

Preliminary studies suggested that two more floors—each 33-ft high plus a smaller equipment level—would be needed and the original first floor expanded to 67,000 sq. ft. Maguire Group, Inc., a large architectural/engineering/planning firm was selected to design the proposed facility. So as to fit in the limited floor area, special state-of-the-art, gas-insulated switchgear was specified. The switchgear, which uses an inert gas as insulator, occupies only a fraction of space required by the conventional type.

Installation of such switchgear in elevated floors is unprecedented in the U.S. Structural design was commenced with the loading characteristics still barely defined.

Design Constraints

The existing 19,000 sq. ft station occupied about half of a very tight, irregularly shaped site. Plans for future work called for:

- Construction of the new power station.
- A future vertical addition of six extra floors and construction of a new office tower adjacent to, and partially over the existing building.

The existing building is located at the property line on one side. Available space on the other two sides was minimal. A future office tower was planned for the open area on the fourth side of the building, thus allowing only one line of support for the new station. Despite all these constraints, designers hoped the perimeter of the existing station could support additional loads from the new building. However, structural analysis of the existing foundations revealed that perimeter caissons

RISA TECHNOLOGIES
3951 Acacia Street
Irvine, California 92714
In California: 1-800-332-7472
Outside California: 1-800-552-7472

RISA
TECHNOLOGIES

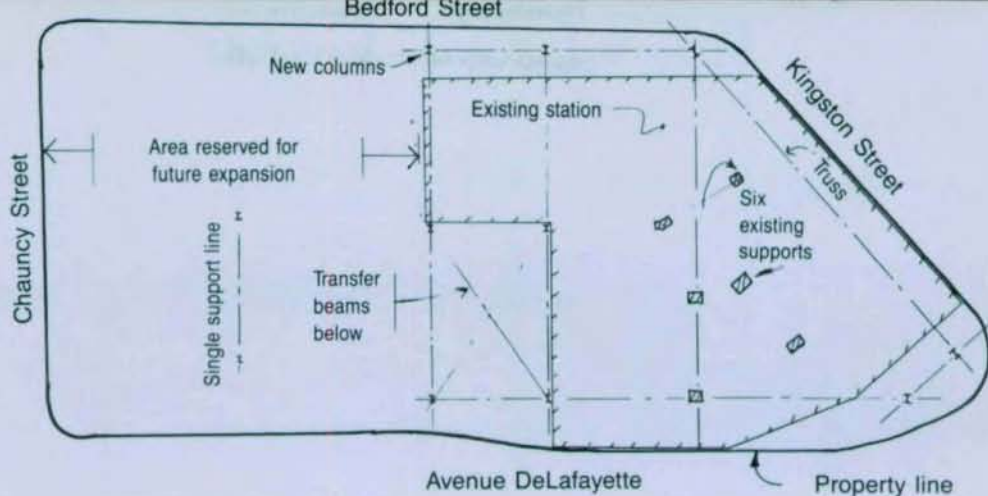

Site plan of extensive addition to Victorian powerhouse

could not take any more load. Only the six interior columns resting on caissons actually had some modest excess capacity.

The challenge was exacerbated by the fact that no work was permitted inside the old station, which was to remain fully operational during construction. Therefore, no new supports could be built inside. The only option left to designers was to locate new supports immediately outside the old station, to complement the six interior columns. In effect, the new station and all the subsequent construction had to be built over the existing building, with only partial bearing on it.

The difficulties of this approach were obvious. Typical beams would have to span up to 70 ft with some deep members spanning about 132 ft at the Kingston Street side where the existing station hugged the property line. In addition, the limited capacity of the interior supports dictated use of the lightest structure possible. Still, a live load of 20 psf had to be accommodated.

The engineers evaluated and rejected precast and cast-in-place concrete systems as too heavy and inappropriate for the loads, spans and irregular shape involved. Structural steel framing became the final choice.

Structural Steel the Choice

The floor system consists of 4½-in. concrete topping on 3-in. composite steel deck. Beams made of A572 Gr. 50 steel span between welded plate girders. The plate girders, ranging from 51 to 78 in. deep, have flanges of 50-ksi steel and webs of 36-ksi steel. Floor beams were designed originally non-composite to permit installation of heavy electrical cables embedded in the slab. The cables subsequently were placed elsewhere, but the non-composite design made the numerous floor penetrations easier to justify. The

**Compact...
Quick...
Powerful**

NEW!



846D CNC ANGLEMAX II FROM W.A. WHITNEY...

Makes your angle fabricating process profitable.

- Compact—Two 75-Ton Presses and 70-Ton Shear all mounted on one rigid frame
 - Continuous feed eliminates drop-off sections
- Quick—New ANGLEMAX II control simplifies setup programming and operation
 - Produces up to 320 3-hole clips/hour
- Powerful—Fabricates up to 6" x 6" x 1/2" A572 angle
 - Punches holes up to 1-1/2" diameter
 - Processes flat stock up to 6" x 1/2"

OPTION: Marking press and material handling for infeed/outfeed.

Talk to your local W.A. Whitney distributor. Call or write us at:



W.A. WHITNEY

AN ESTERLINE COMPANY

W.A. Whitney Corp.
650 Race Street, P.O. Box 1206
Rockford, Illinois 61105-1206
815/964-6771 • Fax: 815/964-3175



Tubular frames (top) support windows erected in front of truss. Below, opportune location for lateral bracing.

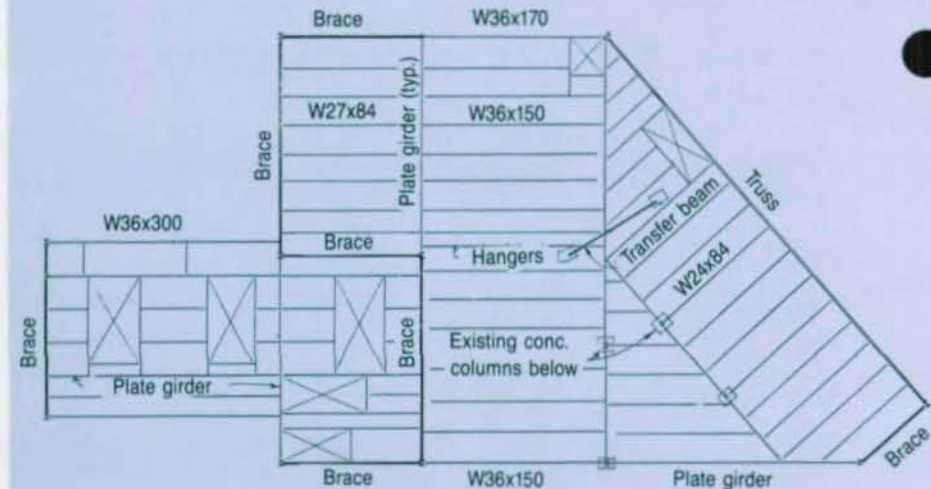
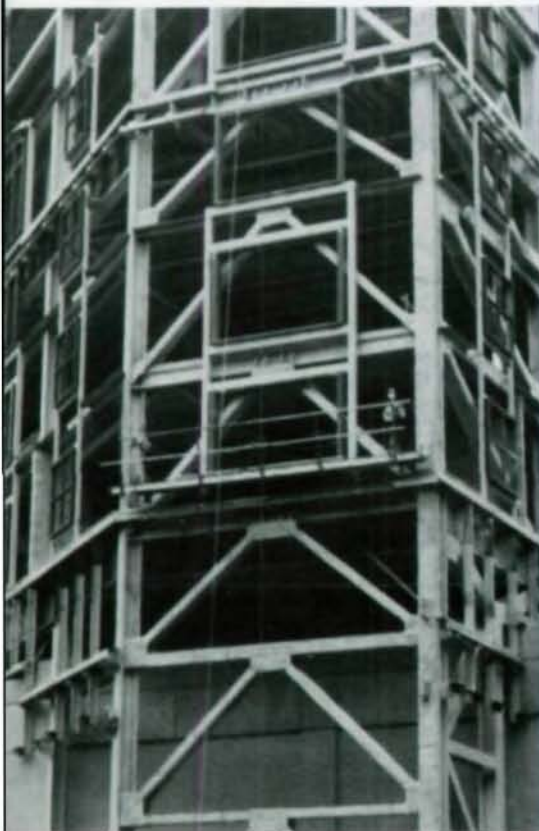

Second-floor framing plan

wide-flange A572 Gr. 50 W14 columns, range in size from W14 x 90 to W14 x 730.

It was learned later that switchgear supports would impose heavy static and dynamic concentrated loads on the floor slabs. Computer-based dynamic analysis was performed to verify that the resulting floor deflections were within tight limits specified by the switchgear manufacturer. Composite floor construction had to be used in selected areas. To facilitate erection and maintenance of the equipment, four permanent overhead cranes were used.

The lateral load-resisting system is perimeter-braced frames made completely of wide-flange members. Horizontal girts of W14 sections are spaced about 11 ft to brace the columns about the weak axis and provide support for the curtain wall. The girts and spandrel beams also act as horizontal members of the K-braces. Vertical girt-columns with slip-top connections were located between the main columns to optimize girt spans.

To span 132 ft over the existing building, a 115-ft high portal truss was designed. The truss not only carried gravity loads, but also serves as a major lateral, load-resisting element.

The truss erection was a challenge in itself. First, the erector Daniel Marr & Son had to install a mini-truss, consisting of two 25-ton legs and the first level of beams. A temporary middle column was employed. Once the first beam level was set, the rest of the truss was assembled using a wheeled crane.

Foundation System

Selection of the foundation system was governed by the fact that exterior columns were few in number and heavily loaded by both gravity and lateral loads. Legs of the portal truss produced spreading action even under gravity loads. The use of tie rods was considered briefly and rejected since in such a system it complicated tunnelling under the existing, heavily loaded spread footings. It was decided to make the foundation resist the thrust. The preliminary foundation system consisted of pile groups under each exterior column.

Eventually, the system was rejected because installation would produce too much noise and vibration.

The final design specified caissons drilled under slurry 20 ft deep into the bedrock stratum, 100 ft below grade. Lateral loads are resisted by a combination of caisson bending and tension of diagonal tie-downs. The tie-downs were made of 1½-in. steel rods drilled into bedrock through the caissons and later stressed to design values.

In one area, steel columns were too close to the existing building to place caissons under them. Massive concrete, double-cantilevered beams, 6 ft thick and 19 ft high were used to transfer the heavy column loads to caissons. These beams intersect in the middle, forming an X-shaped basement to contain any oil spillage from the transformers above.

Massive, cast-in-place concrete beam-and-slab systems were built at grade level

to accommodate two 350-ton transformers and a truck access drive. The beams span about 65 ft over what would someday become an underground parking garage for a future tower. The beams are 12 ft wide because the depth was limited to 4 ft.

Light Curtain Walls Required

Long spandrel beams and limited foundation capacity implied a lightweight exterior wall treatment. The design, developed under the guidelines established by the Boston Redevelopment Authority, echoes the appearance of Victorian mercantile buildings in the area. Huge arched windows, heavily rusticated walls and elaborate cornices consistent with the use of masonry bearing walls typical of that period. The same effect had to be achieved by brick veneer with 33-ft floor-to-floor heights.

Three sets of recessed windows 16 ft wide by 7 ft high, separated by brick spandrel panels, are located between the second and third floors. Steel tubular frames were designed to support both the windows and the spandrels with horizontal members at each head and sill. Ornate cornices were made of glass-fiber, reinforced concrete panels with steel backup.

The result is a "Victorian" substation with a large clock and flower shops at the base. Looking at this seemingly traditional building, one is completely unaware of the high-tech equipment humming inside.

This summer, employees in downtown office towers will not find themselves being sent home. □



Cornice panel supported on steel framing.

Architect/Structural Engineer

Maguire Group Inc.
Waltham, Massachusetts

Foundation Engineers

LeMessurier Consultants, and
McPhail Associates Inc.
Cambridge, Massachusetts

General Contractors

J. Slotnik Company (superstructure), and
T. O'Connor & Company, Inc. (foundation)
Boston, Massachusetts

Steel Fabricator

Montague-Betts Company, Inc.
Lynchburg, Virginia

Steel Erector

Daniel Marr & Son
Boston, Massachusetts

Owner

Boston, Edison Company
Boston, Massachusetts

Alexander Newman, P.E., is a manager of the Structural Department in the Waltham, Massachusetts office of Maguire Group Inc.

**FOR
ALL
YOUR
STRUCTURAL
FASTENER
NEEDS
SPECIFY
ST. LOUIS!**



ST. LOUIS SCREW & BOLT COMPANY

St. Louis Screw & Bolt makes a FULL range of structural fasteners. We produce Types I & III A-325 bolts, ASTM A-307 bolts, and have the capability to manufacture fasteners to YOUR specifications. At St. Louis Screw & Bolt, we practice accepted quality control methods to insure that you receive the best products available. ALL materials we use are traceable to steel melted and manufactured in the USA. And each production run, traceable to a heat lot of steel, is certified to meet ASTM specifications.

**FOR THE QUALITY SOLUTION
TO ALL YOUR STRUCTURAL
FASTENER NEEDS, SPECIFY
ST. LOUIS!**

ST. LOUIS SCREW & BOLT COMPANY
6900 N. Broadway • St. Louis, MO 63147 • 314/389-7500



Since 1887



FAX: (314) 389-7510
1-800-237-7059



THE STAINLESS

STRUCTURALS.

by

KANEMATSU

STRUCTURAL SHAPES AVAILABLE FROM ALL 5 KG LOCATIONS. CALL FOR INFORMATION, QUOTES AND PROMPT DELIVERIES! WE'RE DEDICATED TO SERVE YOU BETTER.

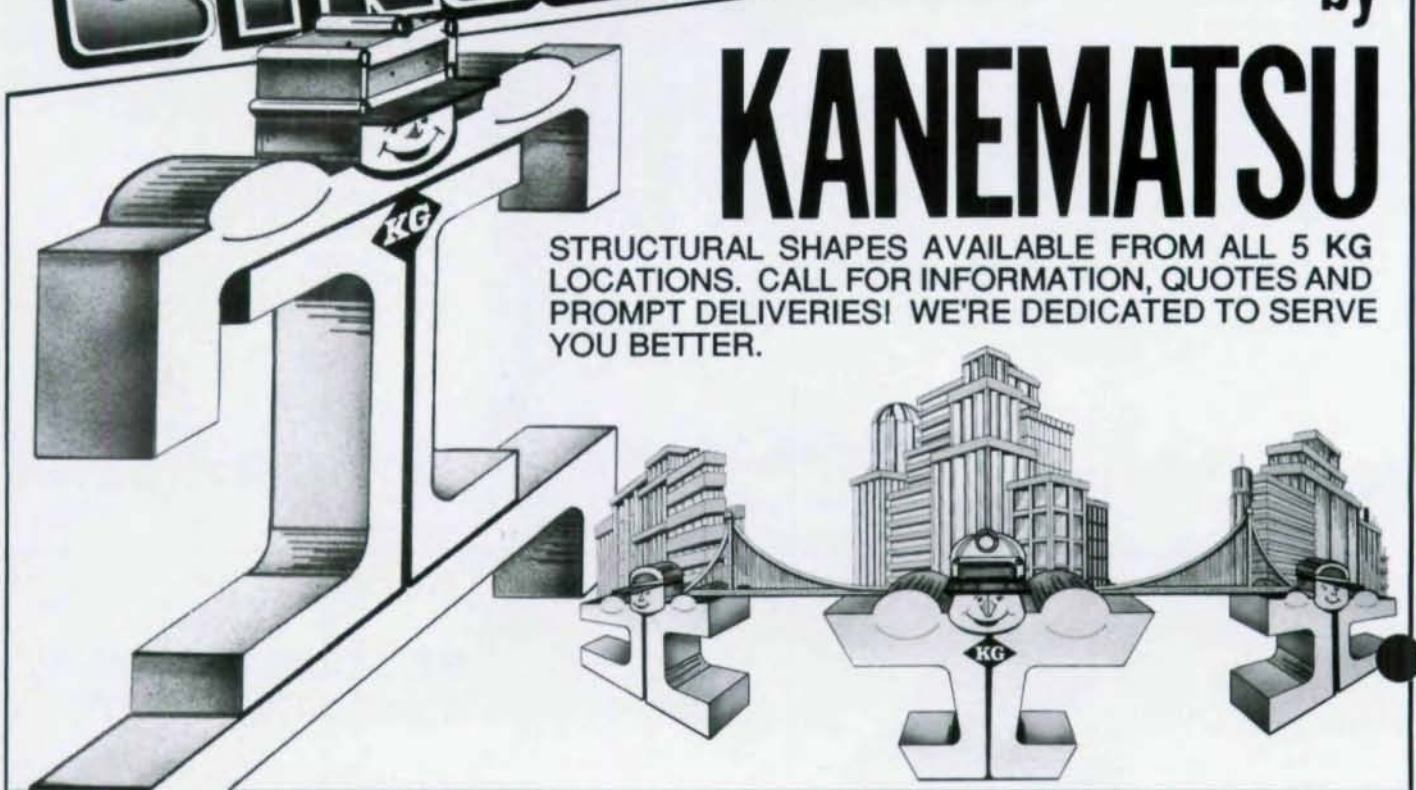

• WELDED • ROLLED • EXTRUDED • INCH AND METRIC SIZES AVAILABLE • 304-316 AND L GRADES AVAILABLE IN 20-22 FT R/L • 14 SIZES OF CHANNEL AND 31 SIZES OF ANGLE AND UNEQUAL LEG AND TEES FROM STOCK • SQUARE AND RECTANGULAR TUBING ALSO AVAILABLE FROM STOCK

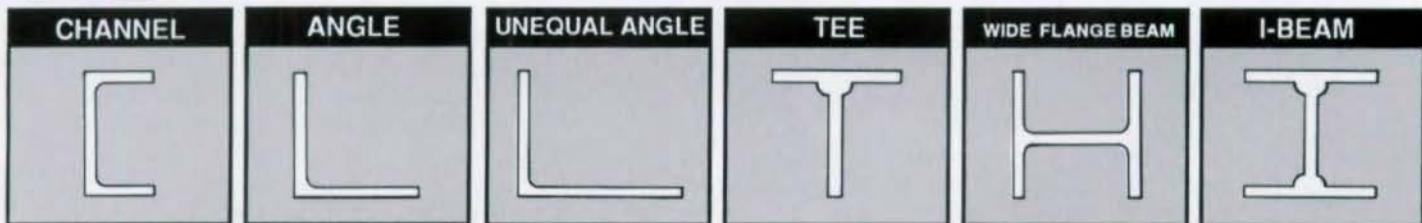

*The Largest
STAINLESS INVENTORY
in the Country for the
Service Center Industry!*

SPECIALTY STEELS KANEMATSU USA, INC.

ATLANTA, GA
2500 Northlake Drive
Suwanee, GA 30174
(404) 963-9999
Fax: (404) 963-1153

CHICAGO, IL
555 W. Algonquin Road
Arlington Heights, IL 60005
(312) 437-3760
Fax: (312) 437-3768

NORTH BRUNSWICK, NJ
2001 Elizabeth Street
North Brunswick, NJ 08902
(201) 297-9500
Fax: (201) 297-4752

LOS ANGELES, CA
17110 Jersey Avenue
Artesia, CA 90701
(213) 924-1660
Fax: (213) 860-4856

HOUSTON, TX
4711 Clinton Drive
Houston, TX 77220
(713) 671-9000
Fax: (713) 671-9355

CORPORATE OFFICE
P.O. Box 1925
North Brunswick, NJ 08902
(201) 297-9505
Fax: (201) 297-4752

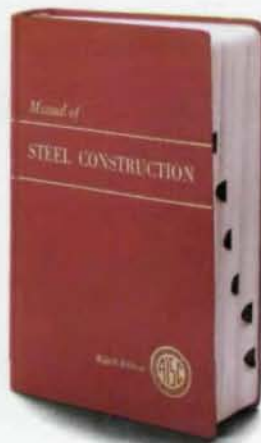

Introducing fully automated AISC spec-checking

ElmCheck™ is a new PC program that checks allowable stress levels for steel beams in a fraction of the time you now spend doing it manually.

It's the only software that does the work for you. Accurately. Thoroughly. Effortlessly. You just key in the member's AISC designation and the variables. The computer does the rest.

Mouse and menu-driven

You don't even have to know how to type. Most entries are made by pointing at menus and clicking the mouse. Built-in error checking features prompt you for corrections if you skip a step or make a

typo that causes a discrepancy. On-line help is available at every step, but you won't need much.

Built-in libraries

ElmCheck looks up the member specifications and performs the calculations in seconds. Including checking non-standard beams. Just enter their dimensions. ElmCheck will also apply Appendix C criteria for non-compact sections.

A quick reading lesson

To use ElmCheck, just point and click on a shape icon from the menu at the upper left quadrant of the screen. The cross section appears in the upper right quadrant.

The beam's dimensions are automatically looked up and displayed. You can select any member orientation with a click of the mouse. Type in the length, the K factors, the material properties and select any one or all three load types.

You're finished. Within seconds, you get a pass or fail indication. Another click of the mouse lets you review the results.

You get the whole story

ElmCheck not only tells you whether the member passed or failed, it tells you why and by how much. A comprehensive report for each member shows all the parameters. You know which load category causes the most significant stress. You can view the report on the screen, print it or save it in a disk file to edit.

Low cost

ElmCheck is now available at a special introductory price of only \$95. You'll save the price of the software the first time you use it!

PASS

a special introductory price of only \$95. You'll save the price of the software the first time you use it!

Time yourself on ElmCheck

See how much time you save. The first 1500 engineers who order ElmCheck or call for more information will receive this attractive quartz desk clock. To order, send a check including sales tax for your state, plus \$3 for shipping and handling, to the address below. Or call 800-233-1798.



Elm
Stressless Analysis

FUJITSU

Fujitsu America, Inc.
Information Systems Division
3055 Orchard Drive
San Jose, CA 95134-2022
(408) 432-1300 ext. 5043

© 1988 Fujitsu America Inc.

It's a boring book, but you'll love it on the screen.

FILE LIBRARY HELP

SHAPE INFORMATION

SHAPE	
La (inches)	I C L
Lb (inches)	T T O
t (inches)	□ ○ □

ANGLE

MEMBER INFORMATION

Member number	0
Mode i (Reference Mode)	i
Mode j	j
Length (feet)	
Yield Stress (ksi)	36
Ultimate Stress (ksi)	58
Youngs Modulus (ksi)	29000
K-Factor Y	1
K-Factor Z	1

LOADS

Force H (kips)	
Force Y (kips)	
Force Z (kips)	
Moment H(kp-ft)	
Moment Y(kp-ft)	
Moment Z(kp-ft)	

END
DIST.
CONC.

See us at the AISC National Steel Construction Conference

ARE BOLTS CAUSING YOU UNDUE TENSION



LEJEUNE SMART BOLTS KNOW "PROPER TENSION!"

A-325 or A-490 high strength bolts.
Factory mill certification-traceable to each keg.
Black or mechanically galvanized.
Full domestic or open stock.

**"THE LOWEST COST SYSTEM FOR PROPERLY
INSTALLED HIGH STRENGTH BOLTS!"**

LEJEUNE BOLT COMPANY
8330 West 220th Street
Lakeville, Minnesota 55044
For Information or Technical Assistance
Call 1-800-USA-BOLT (872-2658)
FAX 1-612-469-5893



Seismic/Wind-loading Design Subject of Four Talks at NSCC



Robert D. Hanson



Charles H. Thornton



Stanley D. Lindsey

Supplemental damping is indicated for building survival, or to minimize damage, in many buildings subject to seismic disturbance, according to research results reported by Robert D. Hanson, director of the Biological and Critical Systems Division at the National Science Foundation, Washington, D.C. (and professor of civil engineering at the University of Michigan). Hanson's report is one of three papers on the effects of earthquakes on buildings to be presented at the 1989 National Steel Construction Conference, June 21-24, at The Opryland Hotel, Nashville, Tenn.

Also scheduled are presentations on "Eccentric Braced Steel Frames EBF for Wind and Low-to-Moderate Seismic Loads" by Stanley D. Lindsey, principal, Lindsey & Associates, Nashville, Tenn.; "Tests of Long Links in Seismic-resistant Eccentrically Braced Frames" by Egor P. Popov, professor at the University of California-Berkeley, and Michael D. Engelhardt, assistant professor, University of Texas-Austin; "Optimization of Tall Steel Structures for Wind Loadings" by Dr. Charles H. Thornton, president and principal, Thornton-Tomasetti, P.C., New York.

Hanson summarizes recent analytical studies of the earthquake response of buildings with supplemental damping from 20 to 50% of critical in both elastic and inelastic regions. He then discusses several mechanical supplemental damping devices and their hysteretic energy dissipation characteristics. "Increased supplemental damping is now a viable alternative to other techniques for improved building response during earth-



Egor P. Popov

Michael D. Engelhardt

quakes for both new and rehabilitated buildings," Hanson concludes.

Popov and Engelhardt describe recent experimental results on the behavior of long, flexural yielding links in EBFs. The tests indicate that flexural yielding links supply substantially less plastic rotation and energy dissipation than shear lengths. Tests on long link-to-column connections showed that details typically used for short links are unreliable for flexural yielding links.

Based on these tests, the authors recommend that long links attached to columns should not be used in EBFs (but that long links located between two braces can provide acceptable performance). Short links are still preferred. Three different brace-to-link connection details are illustrated.

Thornton provides three case histories to illustrate a series of computer programs which "optimize" steel truss structures and assist in determining the most effective places to add material for deflection control. He notes that, for high-rise and slender buildings, a structural system with members sized for strength alone is usually unacceptably flexible. The programs provide a complete design in a seven-step process which includes: determining vertical and lateral forces on the building; finding "optimal" areas using an interactive analysis-and-deflection control program which includes the effects of load redistribution; performing a "final" analysis using more precise loadings; using an "incremental dead load" analysis to explore behavior during construction; using factors on wind, dead and live load cases to reflect the "envelope of overturning moments" and determining governing member forces from load combinations; selecting trial member sizes based on "optimal" areas and checking for strength; presenting final member selection in graphical form for ease of use.

Lindsey's focus is on the seismic behavior and design of eccentric braced frames, which he notes are a proven effective, economical method for resisting seismic forces. Lindsey believes it should be feasible to use work done on the seismic behavior of EBFs to serve as the basis for an initial set of design guidelines for EBFs subject to primarily wind and/or low seismic loads. His paper presents a suggested design approach for these types of EBFs.

FastFrame™

An essential tool for every design office

Integrated Editing, Analysis, Graphics, AISC Design, and AISC Verification of 2D Structural Frames

At Last a revolutionary application using everyone's favorite software...**Lotus 123®**. Now you can completely analyze and design 2D frames, trusses, bracing, and beams with lightening speed and superb graphics within 123. **FastFrame** also gives you on-line help, mouse support, true spreadsheet entry, single keypress control, and **exceptional speed** in a very refined package.

AISC & USER DEFINED DATABASES

- View a "Pop-up" window to scroll through and select the section you need.
- Over 2,700 sections from the 6th, 7th and 8th edition AISC handbooks, including L, LL Jr., Tees, and others.
- Build your own additional database of frequently used sections for use on all future jobs.
- Numerical accuracy maintained with all AISC values.

Beam Label	Section No.	Area	Depth	Width	T	Fy	Fu	Ix	Iy	Wpl.
W24x62	18	23.74	7.848	8.508	8.438	50	58	2100	80	24,500
W24x76	22	23.92	8.998	8.588	8.448	50	58	2100	80	32,500
W24x84	24	24.18	9.828	8.778	8.478	50	58	2270	80	34,400
W24x94	27	24.31	9.865	8.875	8.515	50	58	2280	80	34,800
W24x104	30	24.86	12.758	8.758	8.588	50	58	2100	80	25,800
W24x117	34	24.26	12.988	8.858	8.538	50	58	2100	80	27,800
W24x131	38	24.48	12.855	8.968	8.688	50	58	2100	80	30,800
W24x146	43	24.74	12.988	8.898	8.658	50	58	2100	80	31,800
W24x162	47	25.88	12.955	1.228	8.785	50	58	2100	80	44,800
W27x84	24	26.71	9.948	8.648	8.668	50	58	2850	80	18,800

STRUCTURE PLOTTING

- Press [F6] to plot the entire frame at any time. Quickly verify your frame, loads, & boundary conditions.
- Displays static & deformed shapes.
- Members are color coded per their AISC combined stress values.
- Zoom in on any portion of the frame by "drawing a box"....just like CAD systems.
- CGA, EGA, & Hercules.

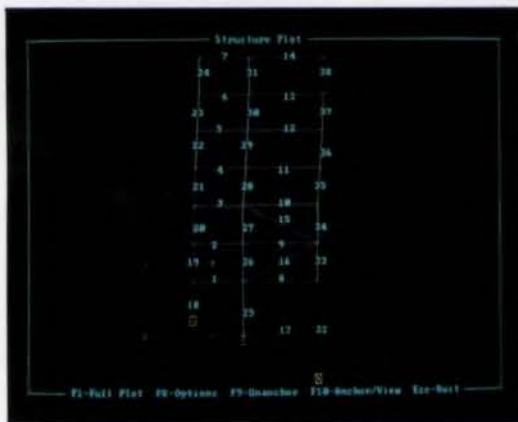

BEAM ANALYSIS & AISC VERIFICATION

- Analyze any beam by pointing to it with the cursor and pressing [F-10].
- Shear, moment, deflection, and AISC code checks @ 250 points across span. AISC check includes all sections and all appendices.
- Full color graphical plots of results.
- Allowable/actual stresses, inflection points, & more!

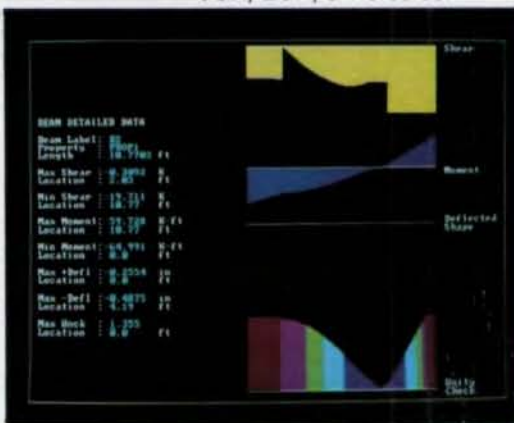

ENERCALC Engineering Software

Only \$650! Call Today
(800) 424-2252 / (714) 723-0295

3070 Bristol Street Costa Mesa, CA 92626

First came instant soup



Now, an instant steelwork connection



LINDAPTER TYPE CK CLAMP KIT

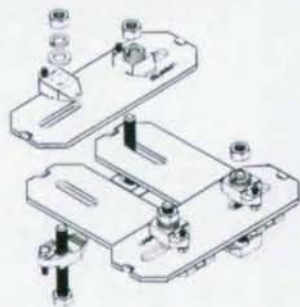

Available in 2 load capacities 3300 lb ($\frac{1}{2}$ ") and 6500 lb. ($\frac{5}{8}$ "), with factors of safety of 5:1

Slotted location plates allow connections of beams with flanges from 2 $\frac{3}{4}$ " to 8 $\frac{1}{4}$ " wide ($\frac{1}{2}$ " size) or from 4" to 10 $\frac{7}{16}$ " wide ($\frac{5}{8}$ " size)

No marking-off of steelwork
No drilling
No welding
Off-the-shelf kit
Requires only a standard wrench to install

For more information please contact
UNISTRUT NORTHEAST
55 SHAWMUT ROAD
P.O. BOX 157
CANTON, MA 02021
PHONE [617] 821-1720
FAX [617] 821-4247

Tubular Connections Subject of Two Conference Presentations



Jeffrey W. Post



Donald R. Sherman

whose primary research interests center on tubular connections.

Post's presentation will address the issues of fabrication practices and techniques, qualification of welding procedures and welders and appropriate inspections for tubular connections. Several real and hypothetical situations will be discussed in an effort to give confidence to designers, fabricators and inspectors in dealing with such connections.

Sherman's focus will be on the design of tubular connections, both round and rectangular, and will begin with a review of the AWS geometric criteria for direct connections. These are primarily for truss connections, although some criteria are included for bending.

Sherman notes there are significant changes under consideration by AWS. For round tubes, an ultimate strength design format has been proposed as an alternate to current ASD punching shear provisions. Proposed changes for rectangular tubes are significantly different from the current provisions. These would be adaptations of criteria from the International Institute of Welding that are in an ultimate load format. His discussion will show how some of these changes might affect connection design.

Another class of connections to be considered are those which use connecting elements as opposed to direct connections. Gusset plates have been used for trusses with round-member and beam-over column connections are popular for round columns. For rectangular columns, a wide variety of framed connections are possible, most of which are adaptations of connection to wide-flange columns and would be designed with similar procedures. Some procedures, particularly those for shear tabs, could be modified to account for the flexibility in the wall of a tube.

One new potential in tubular connections is the use of flow-drilled holes. This is a friction drilling process where the displaced material produces a bushing that can be tapped to obtain thread lengths similar to those in nuts used with structural grade bolts. In this manner, nuts on the inside of bolted connections in tubes can be eliminated. Results of preliminary tests evaluating the shear and tension characteristics of this type of bolting will be presented. The session on Tubular Connections is scheduled for Wednesday, June 21 (3:30-5:00 p.m.) and Thursday, June 22 (2:30-3:55 p.m.).

When architects and designers select round or box tubes for fabricated steel trusses or space-frame applications such as atriums, airport terminals or hangers, sports arenas or convention centers, there tends to be an inordinate fear about the fabrication, welding and inspection of the connections.

Consequently, many otherwise aesthetically pleasing structures result when "knife-edge" gussets or shear plates are installed in the connections.

Some of the concerns arising during the design or bid phase of the project are: design strength/efficiency of the connections; cutting and coping for proper fit-ups, qualification of welding procedures and welders in accordance with AWS D1.1, Structural Welding Code-Steel, and proper inspections. Jeffrey W. Post, a welding engineer consultant serving the structural steel fabricating industry, addresses these concerns in a session on tubular connections at the National Steel Construction Conference. Joining him will be Donald R. Sherman of the University of Wisconsin-Milwaukee,

● AISC INTRODUCES THE 9TH EDITION

ALLOWABLE STRESS DESIGN MANUAL OF STEEL CONSTRUCTION

FIRST REVISION SINCE 1980

Steady progress and improvements in the manufacture, design and fabrication of structural steel over the past nine years have made it necessary for AISC to revise the **Manual of Steel Construction**.

The 9th Edition is a major modification that includes the 1989 Specification for Structural Steel Buildings—Allowable Stress Design and Plastic Design; the 1985 Bolt Specification and the 1986 revised Code of Standard Practice. The number of design aids and examples has been expanded and updated. New easier-to-use tables, including Uniform Load Tables, improve the usability of the Manual, and tabular copy has been changed to reflect new materials.

All chapters have been modified to include results from nine years of research and development with extensive changes in rules governing connections.

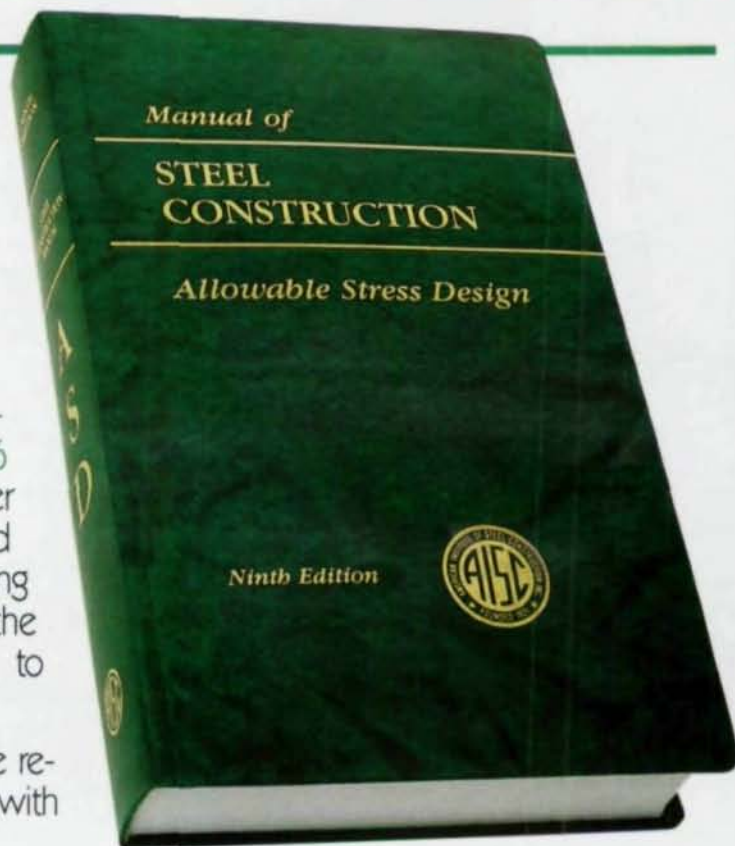

PRICE: \$60.00. AVAILABLE JULY, 1989

NEW • CHANGES

- TABLES
- DIMENSIONS
- BEAMS
- COLUMNS
- CONNECTIONS
- CODES & SPECIFICATIONS



**A MUST FOR STEEL
CONSTRUCTION!**

AMERICAN INSTITUTE OF STEEL CONSTRUCTION

P.O. BOX 806276, CHICAGO, IL 60680-4124

Member Discount 25%

I enclose payment of \$ _____ for _____ copies of the
9th Edition AISC **Manual of Steel Construction** at \$60.00 each.

NAME/TITLE _____

COMPANY _____

ADDRESS _____

CITY/STATE/ZIP _____

Please enclose remittance. No C.O.D. orders. In New York, California, and Illinois add sales tax. Shipping charges prepaid in U.S. On shipments outside the U.S., add 10% of total purchase for postage and handling.

Charge My Visa MasterCard

Card No. _____ Exp. _____

Signature _____

New Manual of Steel Construction Scheduled for Publication



The 9th Edition of AISC's *Manual of Steel Construction*, the first revision of the Allowable Stress Design Manual in nine years, is scheduled for publication in mid-1989. Based on the 1989 *Specification for the Design, Fabrication and Erection of Structural Steel for Buildings*, the Manual includes new and expanded design aids and tabular materials, easier-to-use, uniform load tables and changes that affect beams, columns and connection design. The latest *Bolt Specification and Code of Standard Practice* are included in this 1,100 page volume, a "must" for all those involved in the design, fabrication and construction of buildings.

Based on the updated 1989 *Allowable Stress Design Specification*, the 9th Edition is intended as an alternate design procedure to the 1st Edition of the *Load and Resistance Factor Design Manual*, released in 1986. In summary, the changes between the 8th and 9th Editions are:

Part 1—Dimensions and Properties

Part 1 includes expanded discussions on Brittle Fracture Considerations in Structural Steel, Lamellar Tearing and Jumbo Sections. The dimensions and properties used for design and detailing have been expanded to include 118 more W-shapes than were in the 8th Edition. The data on all rolled shapes has been updated to reflect availability and also has been revised to include the information that is most useful to designers and fabricators. New properties and dimensions were included for a large number of tubes that are now in use.

Torsion properties for M- and S-shapes, channels, single angles, structural tees and double angles were added.

Part 2—Beam and Girder Design

The popular Uniform Load Tables, which were eliminated in the 8th Edition, have been updated and returned to the new edition. New design aids have been added to reflect a new rule on the buckling of beam webs when the beam is seated. This applies to beams with quite slender webs, but can control in some cases. The rules on beam-web yielding under concentrated loads have also changed and appropriate design aids developed. Design examples have been up-

dated to reflect the changes.

New composite beam design aids, based on the elastic transformed section, are included. These will make it considerably easier for designers to take advantage of the economics of "partial" composite construction. Design examples are included.

The beam charts for unbraced beams have been updated and reformatted to make using them easier.

Plate girder examples have been slightly revised to reflect new technology.

A new table has been added which lists capacities of floor plate.

All the popular beam diagrams and formulas have been retained.

Part 3—Column Design

Column Load Tables have been updated to include new tube shapes. A new constant has been added to assist calculations of beam columns. Tables for double angles and tees have been recalculated to include, for the first time, flexural-torsional buckling. This strength limit-state governs in some cases.

The design method for "small" base plates has been changed to a more realistic model than the over-conservative procedure in the 8th Edition. Design examples have been updated.

Part 4—Connections

Design aids have been revised to include some important changes in the rules for the design of high-strength bolted connections. These include:

1. Elimination of the rule which requires that the material bearing value may be a function of the edge distance normal to the line of force.
2. Elimination of the concept that, when one bolt in a line is close to the edge and has an associated reduced material bearing value, all the other bolt values in the line are also reduced. Known as the "poison-bolt" concept, this change has a marked effect on the design of web bolted framing angles.
3. For most cases, the material bearing value of $1.5F_u$ has been reduced to $1.2F_u$. The reason is that, under a large overload, the $1.5F_u$ limit could result in an objectional hole elongation. Again, this reduction affects many types of bolted connections.
4. Although the tabulated values for seated connections (stiffened and unstiffened) have not changed, the discussion has been revised to remind the designer that the new beam-web buckling must be checked. All the design examples have been revised to reflect this.
5. One of the most significant changes in the 9th Edition has been the addition of a discussion and load tables for the design of the popular shear tab connections. This is based on a brand new procedure which is simple and easy to apply.
6. A new procedure is included for the

design of eccentric loads of fastener groups (bolted and welded) when the load is inclined to the axis of the group. This can be very useful for the case of a beam with an axial load—a design requirement which is becoming more common.

7. The discussion and design examples on one-sided connections have been completely redone to reflect modern design and fabrication practices.
8. The discussion and design examples on Hanger-type Connections (prying action) have been redone for simplification.
9. There are many changes in the design examples on moment connections. One of the most important has been to more properly treat the case for combined lateral and gravity loads. In this respect, an improved discussion of the rules for doubler plates is also included.

A new example on a field welded moment connection has been added.

The discussion and design examples on end-plate moment connections has been completely revised as a result of recent research. New rules and examples for column stiffener requirements are included, as well as a new procedure for the design of an 8-bolt connection.

10. The section on Suggested Details has been updated to reflect modern practice.
11. Assembling Clearance has been added for "twist-off" bolts.
12. The section on Prequalified Weld Joints has been updated to reflect important changes in the AWS Specification.

Part 5—Specifications and Codes

1. The Design Specification has been completely changed in format for the first time since it was originally printed in 1926. After a short period of familiarization, it is expected that users will find it much easier to use and to locate specific provisions. The Specification has also been revised to reflect the considerable amount of research that has been done since the previous edition in 1978. This includes new provisions covering material properties, splicing details, thermal cutting, and welding of jumbo W-shapes in non-column applications.
2. The Specification for Structural Joints Using ASTM A325 and A490 Bolts, updated since the 8th Edition, is included in the 9th Edition. This Specification, dated Nov. 13, 1985, includes provisions for snug-tight bolt installation in certain bearing-type connections.
3. A new Specification for Allowable Stress Design of Single-angle Members will be included.
4. The *Code of Standard Practice* has also been revised to reflect clarifications to the previous 1976 Code. In particular, certain provisions on erection tolerances that have been difficult to understand have been clarified.

706907



CALL FOR PAPERS



1990 NATIONAL STEEL CONSTRUCTION CONFERENCE

Kansas City Convention Center
Kansas City, Missouri
March 14-17, 1990

Primary Author

Name _____
(first) (middle initial) (last)

Professional Suffix (degrees) _____

() AISC Active Member () AISC Associate Member () AISC Professional Member () Non-Member

Complete Position Title _____

Place of Employment _____

Business Address _____

City _____ State _____ Zip _____

Business Phone () _____ Ext. _____

Home Address _____

City _____ State _____ Zip _____

Home Phone () _____

*Preferred Mailing Address: () Business () Home

Co-Author(s):

1. Name _____
(first) (middle initial) (last)

Professional Suffix _____

2. Name _____
(first) (middle initial) (last)

Professional Suffix _____

3. Name _____
(first) (middle initial) (last)

Professional Suffix _____

ABSTRACT FOR PROPOSED 1990 PAPER/PRESENTATION
(See Reverse Side for Abstract Guidelines, Preparation of Final Papers, etc.)

Return this form **before August 15, 1989** to:
American Institute of Steel Construction, Inc.
400 N. Michigan Avenue, Chicago, IL 60611-4185
Attention: Lona Babbington (Phone: 312-670-5432)



AMERICAN INSTITUTE OF STEEL CONSTRUCTION, INC.
Call for Papers

The 1990 National Steel Construction Conference will be held at the Kansas City Convention Center, Kansas City, Missouri, March 14-17, 1990. Participants will include structural engineers, fabricators, erectors, educators, and researchers. Potential authors are requested to submit abstracts of papers on design, fabrication, and erection of steel structures for buildings and bridges.

Guidelines for Abstract Proposals

- * Abstracts for Papers to be considered for presentation at the Conference must be submitted to AISC **before August 15, 1989.**
- * Abstracts should be approximately 250 words in length, and may be typed directly on the lower portion of the reverse side of this application, or submitted on a separate sheet of 8½ x 11" white paper attached to this submission form.
- * Authors will be informed of the Organizing Committee's decisions by October 1, 1989. Successful authors must submit their final manuscripts for publication in the official 1989 Conference Proceedings by January 1, 1990.
- * Registration fees for the Conference will be waived for the Primary Author presenting a paper at the Conference.

Preparation of Final paper

Final manuscripts for publication in the official 1990 Conference Proceedings are expected to be approximately 20 pages in length, copy (including photographs) must be camera-ready. Complete instructions for preparation of final manuscripts will be forwarded to authors upon acceptance of Abstract Proposals.

Topics of Particular Interest

- * Practical application of research results
- * Advances in steel bridge design and construction
- * Composite members and frames
- * Buildings designed by LRFD
- * Heavy framing connections
- * Steel framed high rise residential buildings
- * Partially restrained connections and frames
- * Economical fabrication and erection practice
- * Quality assurance and control
- * Case studies of unique projects
- * Computer aided design and detailing
- * Material considerations
- * Fire protection
- * Coatings and material preparation
- * Structural systems

Poster Session

- * Papers not accepted for presentation at the Conference may, at the author's expense, be presented at the Conference Poster Session. Guidelines for the Poster Session will be provided upon request.



AMERICAN INSTITUTE OF STEEL CONSTRUCTION, INC.

The Wrigley Building ■ Eighth Floor ■ 400 North Michigan Avenue ■ Chicago, Illinois 60611-4185

Forwarding and Address Correction Requested

Call for Papers

1990 National Steel Construction Conference
Kansas City, Missouri
March 14-17, 1990

Proper Procedures for Disposal Of Toxic Waste Described

There are EPA regulations for proper and safe disposal of toxic waste (i.e. paint residue, etc.). Workshops on proper procedures will be conducted as part of the program at the 1989 National Steel Construction Conference. The workshops will be conducted Thursday, June 22, 2:30—3:55 p.m. and 4:00—5:30 p.m. The speaker will be Robert Waldhauser, production manager, Fought & Company, Inc., Tigard, Ore.; moderator is Charles Peshek, Jr., director, fabricating operations and standards, AISC, Chicago.

The workshop will allot ample time for questions and an opportunity for conference attendees to share their company's efforts to solve individual problems.

MSC ADVERTISERS

American Computers & Engineers	5
Nicholas J. Bouras	2
Bristol Machine Co.	12
Cast, Inc.	18
Cleveland Steel Tool	14
Computer Detailing Corp.	55
Computers & Structures	27
Cruises Only	57
Data Management Services	15
Design Data	64
Dogwood Technologies	13
Graphical Eng. Software	45
Engineering Software	60
Epic Metals	63
Fujitsu	43
Group 2000	62
Interstate Steel Supply	7
Innovative Analysis	58
Jobber Instrument	53
KG Specialty Steels	42
LeJeune Bolt Co.	44
Levinson Steel	9
Lincoln Electric	6
Lohr Fasteners	28
Lukens Steel	31
MiJack	26
Nucor	8
Omnitech Associates	60
Pettitt Lawrence	52
Research Engineers	35
RISA	38
Smith-Emery Co.	16
Steel Deck Institute	61
St. Louis Screw & Bolt Co.	41
Structural Analysis	22
Structural Software	3
TRW Nelson	30
TradeARBED	10
J & M Turner	24
Unistrut	46
Valmont Industries	49
Vectorsoft	50
Vulcraft	32-33
Walker Manufacturing	29
Waterloo Engineering Software	23
W. A. Whitney	39

Shop and Erection Problems: Advice on How to Solve Them

Three experienced, knowledgeable steel erectors will bring to the forefront some very common erection problems—and offer very cogent advice on how to avoid both the problems and the disastrous consequences which often follow in their wake. The discussion is scheduled for workshop presentations at the 1989 National Steel Construction Conference Friday, June 23, from 1:30—3:00 p.m. and from 3:30—5:00 p.m.

Speakers will be James W. Neal, president, John F. Beasley Engineering Co., division of John F. Beasley Construction Company, Dallas, Tex. and Mark Douglas, project manager, Broad, Vogt & Conant, Inc., River Rouge, Mich. The moderator is Frank A. Becher, vice president/manufacturing, Vincennes Steel Corporation, Vincennes, Ind.

800-331-3002

Custom squares and shapes. Order squares from 12" to 24". Rectangles from 4" X 20" to 24" X 30". Single lengths from 5' to 40', spliced lengths to 60'. A500 dimensions.

No minimum quantity. Material grades ASTM A36 to A572-50. Contact John Holden.

FREE CATALOG



**VALMONT
TULSA**

Common-Sense Guidelines For Economical Connections



John W. Nagel



David T. Ricker

The lion's share of a fabricator's costs are in the steel connections he provides. The most economical connections for a given type of project will vary somewhat from one fabricator to another, but there are many general common-sense guidelines for economical connections on which most of them agree and which provide sound, cost-effective details. Those guidelines, and other tips on achieving lower fabricating costs in both welded and bolted connections, will be described in a session at the National Steel

Construction Conference. The session will be presented by John W. Nagel, chief engineer, AFCO Steel, Little Rock, Ark., and David T. Ricker, vice president/Engineering, The Berlin Steel Construction Company, Berlin, Conn. Presentations are scheduled for Thursday, June 22 from 2:30 to 3:55 p.m. and 4:00-5:30 p.m.

Nagel's presentation will focus on connections; Ricker's on design practices, and especially on the role quality structural design drawings and specifications can and should play in the construction process.

It may be easier for a designer to call for column-web stiffeners at all moment connections or specify full-penetration welds for all moment end plate welds, but these measures are probably not necessary and will add cost to the job, Nagel says. If the fabricator is to develop connections, then the end reactions, moments, axial transfer loads, etc., should be shown on the design drawings so the fabricator does not have to assume the maximum possible forces in the connections.

With computerized structural design, the minimum weight members can be selected,

which will result in a light structure. But if this is done at the expense of simplicity and repetition, it will probably not be the most economical design. It will generally be expensive to provide a clean detail which repeats throughout an area rather than to select the lightest member or connection for each different condition. If field welding is common in the construction area, welded details—particularly for moment connections—will probably be most economical (overall) than elaborate bolted moment connections, Nagel notes.

For welded construction, a fabricator's costs depend to a large extent on the type of weld details he is permitted to use. Direct tensile or compressive forces can be transferred with fillet welds or partial penetration groove welds just as they can be with full-penetration-groove welds, Nagel says. If the fabricator has a particular preference, every effort should be made to accommodate it. To avoid excessive distortion, particularly on unsymmetrical sections, shorter lengths of intermittent welds should be used rather than long, continuous welds.

Nagel states that, when working together and using common sense, the designer and fabricator can produce sound, economical connections which will enhance the efficiency and usefulness of the steel structures.

"Structural design is better than it has been, thanks to testing, better concepts of basic steel design and more thorough understanding of connection behavior," Ricker states. "However, we have witnessed a steady decline in the quality of design presentation via structural design drawings and specifications."

Ricker identifies certain design practices which have crept into the profession, assesses the consequences of these practices, pinpoints some of the causes responsible for the current dilemma and suggests palatable solutions which may ease the perceived difficulties.

He concentrates on listing items which steel fabricators feel must appear on design drawings so they can properly perform their part of the steel construction process. He also points out some statements found with increasing frequency in project specifications which, he believes, are detrimental to a fabricator's performance and which dramatically and needlessly increase fabrication costs. The role of the connection engineer is aired, particularly the manner in which design information is presented to him, and his ability to translate this information into sound, economical connections. The cloud surrounding connection design responsibility is also viewed from a different angle. □

Reduce Stress.

Vectorsoft's structural drafting system for AutoCAD® can reduce the stress of deadlines by decreasing the amount of time and expense it takes to produce drawings. **STEEL**lines has every feature to turn out structural steel details efficiently, with all dimensions from the AISC manual. **REBAR**lines draws reinforced concrete details with ease, following the bar placement standards of ACI and CRSI. In addition to the detailing features, modules are available for automated framing and foundation plans. Don't waste another stressful minute — call Vectorsoft today.



2608 WADE AVENUE
RALEIGH, NC 27607

(919) 881-0820

WORKS INSIDE AUTOCAD®

Connections: What Works— What Doesn't



James A. Fisher



John L. Gross



A. Astaneh

While it may be an oversimplification to say the central issue of steel construction is how things are connected, and why, it is still a fact of life when structural engineers get together there is almost certain to be an extensive dialogue devoted to Connections: What Works and What Doesn't. So, of course, a number of papers scheduled for presentation at the National Steel Construction Conference will focus on this favorite subject.

An overview of research on connection technology presently underway at the National Science Foundation-sponsored Engineering Research Center for Advanced Technology for Large Structural Systems (ATLSS) will be presented by Dr. John W. Fisher, ATLSS director. Among the projects currently in progress are those dealing with more efficient use of steel connections, welding of the high-strength steels, structural applications of A710 steel, improved gas cutting of steel, automated construction systems, ATLSS connections and structural systems knowledge-based systems for connection evaluation.

Fisher states significant results have

1989 National Steel Construction Conference

SCHEDULE OF EVENTS

(Note: "R" Sessions are Repeats.)

Wednesday, June 21

- 12:30-1:15 Product/Service Workshops A1 A2 A3 A4
- 1:30-5:00 Educator Session
- 1:30-5:00 AISC Professional Member Forum
- 1:30-3:00 Plenary Session—Dealing with the Shop Work Force: New Hires, Shop Rules, Productivity & Employee Relations
- 3:30-5:00 Workshop Sessions/Seminars 1 2 3
- 5:15-6:00 Product/Service Workshops B1 B2 B3 B4
- 6:30-7:30 AISC Cocktail Party

Thursday, June 22

- 7:30-8:15 Product/Service Workshops C1 C2 C3 C4
- 8:30-8:45 Plenary Session—Welcome/Announcements
- 8:45-9:15 Plenary Session—AISC Position, ASCE Manual on Quality of the Constructed Project
- 9:15-10:00 Plenary Session—Panel: Responsibility for Connection Design
- 10:30-11:15 General Session: Bishopsgate Office Complex (London)
- 11:15-Noon General Session: Major Scandinavian Bridges and Tunnels
- Workshop Sessions/Seminars 1R 2R 4
- Noon-1:15 Lunch—Exhibit Hall (Exhibits Open)
- 1:15-2:30 EXHIBIT SESSION and Product/Service Workshops
- POSTER SESSION
- 1:30-2:15 Product/Service Workshops D1 D2 D3 D4
- 2:30-3:55 Workshop Sessions/Seminars 3R 4R 5 6 7 8 9
- 4:00-5:30 Workshop Sessions/Seminars 4R 5R 6R 10 11 12 13
- 5:45-6:30 Product/Service Workshops E1 E2 E3 E4
- 7:00-10:30 OPTIONAL EVENT: General Jackson Showboat Dinner & Cruise

Friday, June 23

- 7:30-8:15 Product/Service Workshops F1 F2 F3 F4
- 8:30-9:15 Plenary Session: AISC Marketing's Design Analysis Service
- 9:15-10:00 Plenary Session: 9th Edition, AISC Manual of Steel Construction
- 10:30-Noon Workshop Sessions/Seminars 7R 10R 14 15 16 17 18
- Noon-1:30 Lunch
- 1:30-3:00 Workshop Sessions/Seminars 8R 9R 11R 12R 14R 19 20
- 3:30-5:00 Workshop Sessions/Seminars 13R 15R 16R 17R 18R 19R 20R
- 5:15-6:00 Product/Service Workshops G1 G2 G3 G4
- 7:00-9:15 OPTIONAL EVENT: Country Barbecue
- 9:30-11:00 OPTIONAL EVENT: Grand Ole Opry

Saturday, June 24

- 8:30-9:30 Plenary Session: T. R. Higgins Award and Lecture "Flexibly Connected Steel Frames"
- 10:00-11:30 Plenary Session: Material and Fabrication Considerations for Heavy Weldments: Minneapolis Convention Center
- 11:30 Drawing for Attendance Prizes
- 12 Noon Adjourn
- 2:30-5:00 OPTIONAL EVENT: "Music, Music, Music"
- 9:30-11:00 OPTIONAL EVENT: Grand Ole Opry

SPOUSES PROGRAM

Wednesday, June 21

- 6:30-7:30 AISC Cocktail Party

Thursday, June 22

- 11:00-12:45 Welcome Brunch/Speaker: Opryland's Conservatory
- 1:00-5:00 Tour of Travellers' Rest and the Upper Room

Friday, June 23

- 9:30-5:00 Tour of Cheekwood (and Lunch)/Green Hills and Bandywood

STEELCAD STEELCAD

The most powerful and flexible computerized structural steel detailing program available internationally.

Featuring:

beams • columns • horizontal bracing • cutting lists • stairs vertical bracing • C.N.C. files or punch tickets • customized title blocks • multing • girts connection design reports for beams and bracing • inventory erection plans • shipping lists production control • advance bills • moment connections customized bills of material • all connections types • input and output in imperial metric or any combination • output in French, English or Spanish.

We will make your day.

Stop by our booth for a demonstration and receive a complimentary copy of our multing program.

PETTITT LAWRENCE LIMITED
550 Alden Road, Suite 201
Markham, Ontario, Canada
L3R 6A8

Telephone 800-387-4201

already been obtained in some investigations and continuing efforts will lead to new and improved procedures for connection design, particularly semi-rigid connections; cost-effective ways to utilize the newly developed high-strength, micro-alloy steels; new flame-cutting procedures resulting in less local micro-hardening and brittleness; and automated frame erection systems incorporating self-aligning connectors and sensing devices.

ATLSS researchers will also present results of tests involving the effect of partially pre-tensioned bolts in extended end-plate and top-and-seat-angle connections. Their conclusions indicate snug-tightened end-plate connections (tightened to 30% or 40% of the ultimate strength, achieved by using an ordinary spud wrench) performed essentially the same as their fully pre-tensioned counterparts. In top-and-seat-angle connections designed to resist moment by using equally large angles attached at the top and bottom beam flanges, the snug-tight connection for multiple bolt rows behaved stiffer and

stronger than its fully pre-tensioned counterpart. According to ATLSS, the snug-tight connection also reacted less adversely to load reversal, and its load-deformation response remained linear over a larger range of loading.

John L. Gross, research civil engineer at the National Institute of Standards and Technology, Gaithersburg, Md., reports on the results of an experimental program undertaken at NIST to determine behavior of gusseted connections for laterally braced steel buildings. Tests included the influence of the members framing into the connection, with three nearly full-scale braced frame sub-assemblages tested.

Abolhassan Astaneh, Assistant Professor at the University of California, Berkeley, describes the new and comprehensive (yet simple) design procedures for single plate shear tab connections, forming the basis of new 9th Edition AISC-ASD Manual tables.

Each of the papers is included in the *Proceedings* of the Conference, available after July 1 from AISC.

Employee/Personnel Relations Subject at Steel Conference

A plenary session, "Dealing with the Shop Work Force," highlights the Wednesday afternoon program at the 1989 National Steel Construction Conference. Representatives of fabricating firms and industry consultants will discuss shop rules, evaluating and processing new employees (physical examination, hearing test, drug testing, etc.), on-the-job employee relations and effect of company personnel procedures on productivity.

The moderator will be S. W. Blaauw, vice president/operations, Paxton & Vierling Steel Company, Omaha, Neb. Speakers include James E. Self, corporate personnel manager, Cives Steel Company, Roswell, Ga. and Max Downing, president, Selway Corporation, Stevensville, Mont.

The plenary session will be followed by workshop for roundtable discussion. (The workshop will be repeated Thursday from 10:30 a.m. to noon.)

JOBBER II

FEET-INCH-SIXTEENTHS ENGINEERING CALCULATOR WITH DECIMAL & METRIC

"The calculator that does it all"

It will save you time, money & costly mistakes.

If You Work With Dimensions—You Need Jobber II.

- It is the Best and Simplest to Use of All Feet-Inch-Sixteenths Calculators.
- With Jobber II you can quickly and easily add, subtract, multiply, and divide feet, inches, and sixteenths.
- It has built in trig functions which permit easy solutions to right or oblique triangles and circles without use of charts or tables
- It is programmed to solve right triangles giving you the Bevel-Slope-Rise-Run at just the touch of a button. That means you can solve diagonals, stringer, rafter calculations, and the like instantly.

Why It Is The Best And Simplest To Use . . .

- Jobber II has the only patented 0-15 keyboard in the industry.
- This means that dimension entry is simplified to a minimum number of keystrokes. For example, **only 3 keystrokes** are required to enter a dimension like 5' 10¹⁵/₁₆" compared to as many as 9 keystrokes on other dimension calculators.

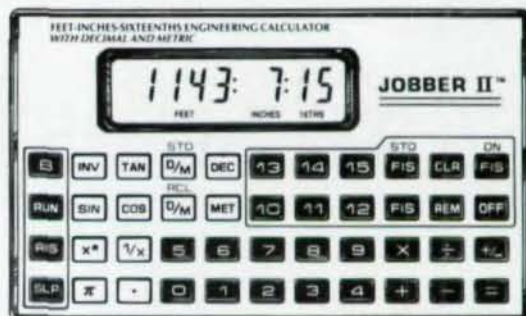

ACTUAL SIZE: 3 1/4" x 5 1/2" x 3/8"

\$89.95 Plus \$3.00 Postage & Handling
MONEY BACK GAURANTEE

For more information or to order, call toll free 1-800-635-1339.

See us at the AISC National Steel Construction Conference

Gerstle and Ackroyd to Present 1989 Higgins Lecture at NSCC



Kurt H. Gerstle



Michael H. Ackroyd

Kurt H. Gerstle, professor of structural engineering at the University of Colorado, Boulder, Col., and Michael H. Ackroyd, president of First Principles Engineering, an engineering consulting firm in Acton, Mass., will present the 1989 T. R. Higgins Award and Lecture at the Saturday morning session of the 1989 National Steel Construction Conference. Gerstle and Ackroyd were selected to receive the award jointly as a result of their collaborative and individual research on flexibly connected building frames.

The NSCC presentation, titled "Behavior and Design of Flexibly-connected Building Frames," summarizes what the authors have learned about the behavior of flexibly connected building frames over 15 years of research and development. "Although the behavior of connections in steel construction extends over the full range from near-pinned to almost-rigid, traditional engineering practice has considered only the extreme limiting cases: either perfectly pinned, as in ideal trusses, or fully rigid, as in rigid-frame con-

struction," the authors indicate. They further note that, "the neglect of real connection behavior can lead to unrealistic predictions of the response and strength of steel structures and less than optimal design in steel construction."

Gerstle and Ackroyd believe more realistic connection behavior can be included in analysis "without undue pain," and that inclusion of realistic connection behavior is fully within reach of professional office practice. Concepts and analysis/design procedures are explained in a simple fashion and several examples are used to demonstrate the benefits of a more realistic approach: the improved safety and economy which are considered the "justified reward" of such realistic analysis.

The complete text of the paper is available in the 1989 National Steel Construction Conference *Proceedings*, available after July 1, 1989 from AISC, 400 N. Michigan Avenue, Chicago, Ill. 60611.

THE MOST EXPENSIVE STEEL YOU BUY IS THE STEEL YOU CAN'T USE

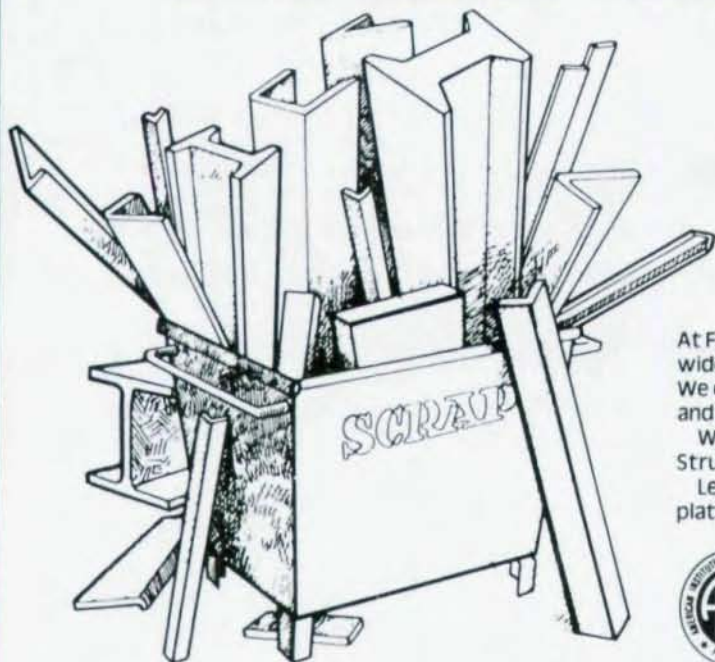

At Federal we specialize in stocking the lengths and sizes you **CAN USE**. All wide flange beams are available in 5' **MULTIPLES** from **35' THROUGH 60'**. We deliver material in stock lengths or **CUT TO SIZE** anywhere in the U.S. and Canada.

Wide Flange Beams, Standard Beams, Plate, Channel, Angle, Flats, Structural Tube and Miscellaneous Channel in stock.

Let us show you how our expertise in steel warehousing, saw cutting, plate processing and transportation can benefit you!



ASSOCIATE

For further information call:
(313) 455-4000
MICHIGAN WATTS (800) 572-0888
NATIONAL WATTS (800) 521-4444
FAX (313) 455-9120



Federal PIPE & STEEL CORPORATION

DETROIT • CHICAGO • MINNEAPOLIS • ST. PAUL

Building Seismic Safety Council Updates "Recommended Provisions"

The new 1988 edition of the *NEHRP Recommended Provisions for the Development of Seismic Regulations for New Buildings* was recently released by the Building Seismic Safety Council, the 60-member organization established under the auspices of the National Institute of Building Sciences. The goal of the Provisions is to present criteria for the design and construction of buildings subject to earthquake ground motions so as to:

- Minimize the hazard to life for all buildings;
- Increase the expected performance of higher occupancy structures as compared to ordinary structures; and
- Provide the capability of essential facilities to function during and after an earthquake.

The primary function of the Provisions is to provide the minimum criteria considered prudent and economically justified for the protection of life safety in buildings subject to earthquakes in any part of the U.S.

In the Provisions, building use-group categories are classified into seismic hazard exposure groups. They include simplified struc-

tural response coefficient formulas related to the fundamental period of the seismic resisting system of the building and more detailed consideration of seismic design requirements for architectural, electrical and mechanical systems and components than do existing seismic codes.

The Council's program is the subject of a presentation at the National Steel Construction Conference in Nashville, Tenn.; H. W. Martin of the American Iron & Steel Institute will amplify the Provisions, and implement of seismic design in sessions Thursday, June 22 from 2:30-3:55 p.m. and Friday, 10:30 a.m. to noon.

As part of the BSSC's program to encourage use of seismic safety provisions, seismic mitigation demonstration projects will be conducted in targeted geographic areas. The first such project currently is under way in Charleston, S.C. The projects are intended to "enrich the ongoing information dissemination efforts by providing tangible examples of the willingness and ability of political

jurisdictions to consider, adopt and implement the *NEHRP Recommended Provisions*."

The BSSC serves as a voluntary, independent body whose membership of nearly 60 organizations represent a wide variety of building community interests. Its fundamental purpose is to enhance public safety by providing a national forum that fosters improved seismic safety provisions for use by all segments of the building community in the planning, design, construction, regulation and use of buildings.



Mountain Enterprises, Inc.

P.O. Box 190 Shepherdstown, WV 25443

304-876-2534

Steel Detailing and ME2 Software

A Leader in Our Industry for 20 Years

Integrated CAD/Data Base Software for Steel Detailing



ASSOCIATE

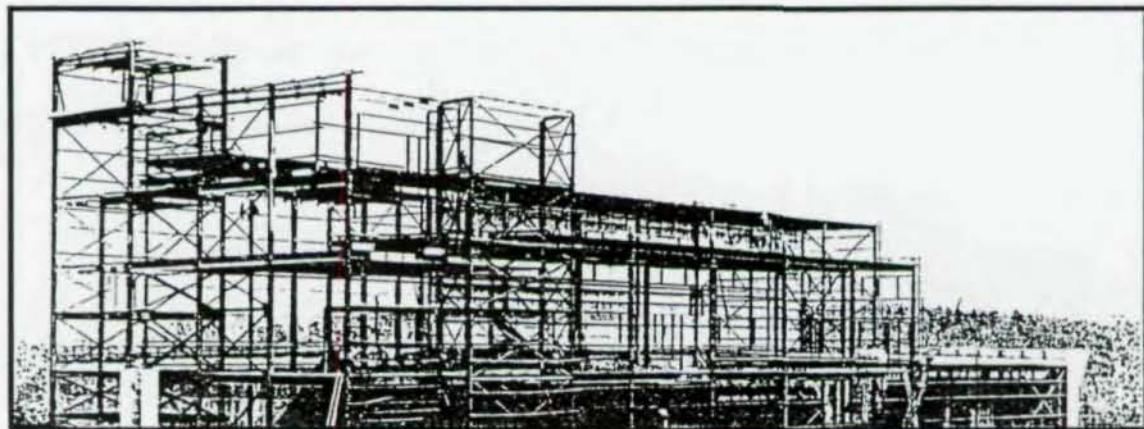

All the features you expect: "E" Drawing based • Pre-designed standard connections
Matched ends • Field bolts counted • Shop bills • Down loading to shop equipment, and more.

Plus – Open Architecture

Your detailers can create any special condition to suit the job or your shop requirements.

ME2 – The Detailer's Tool – With a Difference!

See us at the AISC National Steel Construction Conference

Bridge and Structures Information Center Formed

A new technical center which is likely to play a major role in a number of activities related to the steel construction industry has been announced. The Bridge and Structures Information Center (BASIC) will be headquartered at the University of Pittsburgh, Pittsburgh, Pa. Reidar Bjorhovde, professor and chairman of the Department of Civil Engineering at the University, has been named director of the center.

The center has been formed under the auspices of the American Institute of Steel Construction and its formation was announced by Robert P. Stupp, chairman of AISC's Committee on Bridges. "Questions and problems sometimes arise in the course of a bridge or other construction project which, unless they are promptly addressed by an independent agency or expert, may lead to costly delays or even legal action by one or more of the project partners," Stupp said. BASIC is intended to respond to those questions.

Bjorhovde, BASIC director, noted "There may be many and valid technical reasons for the problems, but a large percentage of the questions come up because there is no effi-

cient mechanism for the transfer of acquired and available knowledge. Past experience of designers, contractors and other members of the construction team is rarely known beyond a limited circle, generally because there is no practical way in which details of the project can be publicized."

The aim of BASIC is to facilitate the exchange of such information, as quickly and efficiently as possible, by making use of a steel bridge and structures database, 10 central task forces to address the myriad of practical problems, and a panel of experts who are recognized authorities in their respective fields. For example, one of the task forces will address questions related to cleaning and paint systems; another will deal with the problems related to metallurgical criteria.

The members of the BASIC panel of experts will be available to assist any agency or company that has the need for independent, expert advice in the resolution of a design, construction, inspection or other steel bridge and structures problem. Working with all parties to the dispute, BASIC will bring information to the table not readily available from usual sources. Thus, it is expected costly delays can be avoided, because complete understanding of the problems will be acquired. In particular, it is

anticipated the contentious, acrimonious disputes that sometimes evolve, and benefit no one, can be avoided.

The Advisory Council for the Center includes:

Robert P. Stupp, executive vice president, Stupp Bros. Bridge & Iron Company, St. Louis, Mo.;

Prof. T. V. Galambos, University of Minnesota, Minneapolis, Minn.;

Arthur W. Hedgren, vice president, HDR/Richardson-Gordon, Pittsburgh, Pa.;

Clendon L. Loveall, assistant executive director, Bureau of Planning and Development, Tennessee Department of Transportation, Nashville, Tenn.;

Dean C. Krouse, senior metallurgical applications engineer, Bethlehem Steel Corporation, Bethlehem, Pa.;

Neil W. Zundel, president, AISC, Chicago, Ill.;

Geerhard Haaijer, vice president, Technology and Research, AISC, Chicago, Ill.;

Fred Beckmann, director of bridges, AISC, Chicago, Ill.

For further information about the center, contact Fred Beckmann, AISC, 400 N. Michigan Ave., Chicago, Ill. 60611, or Reidar Bjorhovde, Director, BASIC.

New Design Guides, Software Available

A new Design Guide Series is now available from the American Institute of Steel Construction, intended as supplemental references to the AISC Manual of Steel Construction. The booklets were prepared under the direction of AISC's Committee on Research and sponsored by the American Iron and Steel Institute. Four of the design guides scheduled to become available in 1989 are:

- *Column Base Plates: Design & Erection*—John T. DeWolf, University of Connecticut and David T. Ricker, Berlin Steel Construction Company;
- *Load and Resistance Factor Design of W-shapes Encased in Concrete*—Lawrence G. Griffis, Walter P. Moore & Associates;
- *Building Systems: A Primer*—Horatio Allison, Consulting Engineer;
- *Extended End-plate Moment Connections*—Thomas M. Murray, Virginia Polytechnic Institute and State University.

Several additional design guides are also currently under development and scheduled for release next year.

STEEL DETAILING

with

AutoCAD[®]



"BEAMS and COLUMNS"

"PLANS and ELEVATIONS"

Other programs

"MATERIAL MANAGEMENT"

"BRACING"

Versatile and cost effective programs for detailing structural steel and miscellaneous metal.

Developed by Detailers for Detailers

COMPUTER DETAILING CORPORATION

1310 Industrial Blvd.
Southampton, PA 18966
215-355-6003

AISC Position on ASCE Manual To Be Discussed

A special session presenting AISC's position on the American Society of Civil Engineer's *Manual on Quality of the Constructed Project* is scheduled for Thursday morning (8:45-9:15 a.m.) at the 1989 National Steel Construction Conference.

AISC has issued a statement on proposed Chapter 21 of the Manual, objecting to assignment of responsibility for connection design as outlined in the proposed chapter. An AISC spokesman will explain the Institute's position in greater detail in the conference presentation.

Research Council on Structural Connections Makes Recommendations on Counterfeit Bolts

Committee No. 32 on Education, formed by the Research Council on Structural Connections to investigate and respond to allegations concerning counterfeit high-strength bolts, will issue a series of bulletins to publicize the committee's recommendations. "The intent of these bulletins is to provide the construction industry with information to achieve one common goal... to assure the supply and use of high-strength bolts, nuts and washers, meeting all the requirements of the current ASTM and RCSC for manufacture and supply and specifications, for installation and inspections," said Ted Winneberger, chairman of the committee.

The committee was formed in November 1988 to provide accurate detailed recommendations for the project specifications, purchasing, installation and inspection of high-strength bolts. While the nationwide publicity over the last year has spawned numerous studies, investigations and countless articles warning the industry of "counterfeit bolts," the committee found

some allegations were factual but many were misleading and contained unfounded information. The first two bulletins have been issued. Bulletin No. 1 suggests provisions to be incorporated in project specifications. Bulletin No. 2 calls attention to special concerns which may merit the engineer's attention. Copies of both bulletins are available from the Council (Ted Winneberger, chairman, Box 25369, Oklahoma City, Okla. 73125).

At a session at the National Steel Construction Conference, Thomas S. Tarpy, Jr., vice president/structural engineer, Stanley D. Lindsey & Associates, Nashville, will conduct a workshop offering guidelines on selection of bolt type, testing requirements and proper preparation of purchase orders. Tarpy, immediate past chairman of the Research Council on Structural Connections, will offer "how-to" instructions for determining manufacturing source by head and nut marking. The Bolt session is scheduled for Friday, June 23, 10:30 a.m.-noon, and Friday, June 23, from 3:30 to 5:00 p.m.

The splendor of... ALASKA

...so diverse, so unique, so captivating!

Explore the wild and free spirit of the land and sea aboard the REGENT SUN or REGENT SEA while cruising the spectacular Inside Passage and visit exciting cities such as Juneau, Skagway, Ketchikan, Sitka or Valdez.

• NO OTHER CRUISE GIVES YOU MORE IN ONE WEEK •
MEMBERS SAVE UP TO 25%



Ships sail weekly between Vancouver and Anchorage (Whittier) from May through September. Free or low cost air add-ons from 79 cities.

For reservations, information and brochure, call or reply with this **BONUS COUPON**

This coupon represents \$50 per cabin when you book the cruise of your choice for 7 days or longer when reserved through Cruises Only! Inc.



**Fieldston
International's
Cruises Only! Inc.**

3751 Riverdale Ave. • Riverdale, NY 10463

**CALL TOLL FREE
1 800 999-7005**

Name _____

Address _____

City, State, Zip _____

Home Phone () _____ Bus. Phone () _____

Date/Ship Departure _____ Air Gateway _____

Ships registries: Panama and Bahamas

\$50

\$50

\$50

\$50

Council for Advancement of Steel Bridge Technology Formed

The Council for the Advancement of Steel Bridge Technology, a new national not-for-profit organization dedicated to the enhancement of economical and innovative solutions to steel bridge needs, was formed Feb. 2, 1989 in Chicago at a meeting of independent industry organizations comprising the originating group.

Robert P. Stupp, who was elected chairman, stated the main purpose of the Council is "to assure that steel bridges reflect the latest developments in steel design concepts, construction technology, economical solutions and reliable service performance." Stupp is also the chairman of the Committee on Bridges of AISC, the national organization representing the fabricated structural steel industry, and executive vice president of Stupp Bros. Bridge & Iron Company, St. Louis, Mo., an Active Member company of AISC.

Thomas Heimerl was elected vice chairman of the council. Heimerl is manager, Marketing-Plate and Structural Products, USS Division of USX (a member company of the American Iron and Steel Institute).

Council membership, Stupp noted, will include active members from organizations which have a direct interest in the design and construction of steel bridges. Those comprising the organizing group are:

- American Iron and Steel Institute (AISI)
- American Institute of Steel Construction
- AISC Marketing, Inc.
- National Erectors Association (NEA)
- Steel Structures Painting Council (SSPC)
- National Electrical Manufacturers Association (NEMA)
- Industrial Fasteners Institute (IFI)

"This coalition of industry interests closes the bridge industry 'loop,'" Stupp said, "forming a continuum which includes AISI's expertise on the base material, the technical and educational resources of AISC, NEA's knowledge of construction techniques, the marketing capabilities of AISC Marketing, Inc. and the product and service support of SSPC, NEMA and IFI.

"All elements of bridge construction will be considered," Stupp continued, "including, but not limited to substructure, deck, struc-

tural support systems, corrosion protection systems, materials, shop practices, erection procedures and overall construction practices. It is anticipated other organizations representing suppliers of items such as bearings, decks, joints, etc., will be added to the council."

The council will serve as a clearinghouse for information on the most recent developments in steel bridge construction and will sponsor programs and activities to develop and support specific research and design programs as well as encourage legislation on infrastructure issues. In addition to supporting existing local organizations with the capacity to distribute pertinent information and implement new developments, the council urges the establishment of regional forums or roundtables to serve as communication links for identification and resolution of specifically regional problems.

The council will also act as a co-sponsor for the biennial National Symposium on Steel Bridge Construction, scheduled for Oct. 19-20 at The Shoreham Hotel, Washington, D.C.

"LARSA provides unique analytic capabilities coupled with a very responsive support staff."

Ronald Check, Associate
Weidlinger Associates

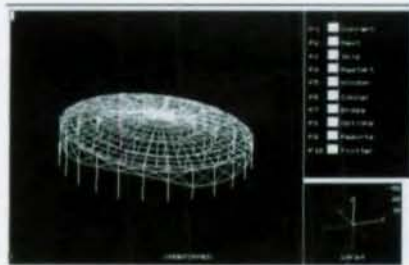

Weidlinger Associates used LARSA to perform a peer review and independent analysis of a dome in St. Petersburg, Florida.

Civil and Structural Engineers and Architects across the world are learning that LARSA has become the only program they need for Structural Analysis and Design. With its flexibility and interactive menus, LARSA gives users exceptional control over the analysis and design process.

LARSA's unique combination of power and simplicity and its use of the Finite Element Method makes it the right program for any two- or three-dimensional problem - from foundations and buildings to bridges, towers and domes.

PREPROCESSOR: Generate and modify your structural model.

ANALYZE: Perform static or dynamic analysis of linear or geometrically nonlinear models.

POSTPROCESSOR: Interactively study displacements, stresses and forces, and graphically display deformed structure and mode shapes.

DESIGN: Code check and/or design steel and concrete members.

GRAPHICS PROCESSOR: Access from any point in the process to display virtually all input and output data. Window, zoom and rotate the model. Output to plotters and printers, and interface to AutoCad™.

LARSA is available for IBM XT/AT and PS/2 and compatibles, VAX, Sun workstations.

Order the LARSA Trial Size Package for PCs or PS/2 today. Only \$50, credited to purchase.

Call 1-800-LARSA-85 (in New York state 212-736-1616) and charge on American Express. Or send a check to:

Innovative Analysis Incorporated
330 West 42nd Street
New York, NY 10036

New York residents add sales tax.
Overseas orders add \$25.

LARSA
FINITE ELEMENT ANALYSIS AND DESIGN

KOLL CENTER NORTH

Backdrop to Urban Development

by Jon Patrick Allen

When completed in 1992, the 47-acre Koll Center Irvine North promises the Irvine business population one of the most exhilarating urban spaces in California.

Comprising the northern section of the 100-acre, \$1-billion Koll Center Irvine project—one of the largest mixed-use projects in Orange County—Koll Center Irvine North is a veritable mix of functions consistently planned for maximum interrelated activity.

Borrowing metaphors from European counterparts, the architect promises an experience of excitement and richness typical of the bustle of continental Mediterranean plazas.

Bounded on all sides by major arteries, including the San Diego freeway to the south, design of the complex required a closely knit combination of elements that called for an urban planning and design mix unprecedented in Southern California.

Contributing to the unique urban design are the strong architectural definition and top quality materials used; the combination of distinctive water elements, modern art and extensive landscaping; the interplay of retail and casual eating functions with office and working spaces; the orientation of buildings to the external environment; the mix and orientation of upscale sporting facilities with theaters, hotels and restaurants and the carefully designed scale of the multi-functions.

Of the seven multi-story office towers scheduled for the complex, three are now complete. While the elegant Taco Bell building stands supremely graceful at the eastern boundary, the most recent additions to Irvine's skyline are the dramatic twin, 12-story towers. Forming a striking backdrop to the entire plaza area, these \$120-million triangular towers include 600,000 square

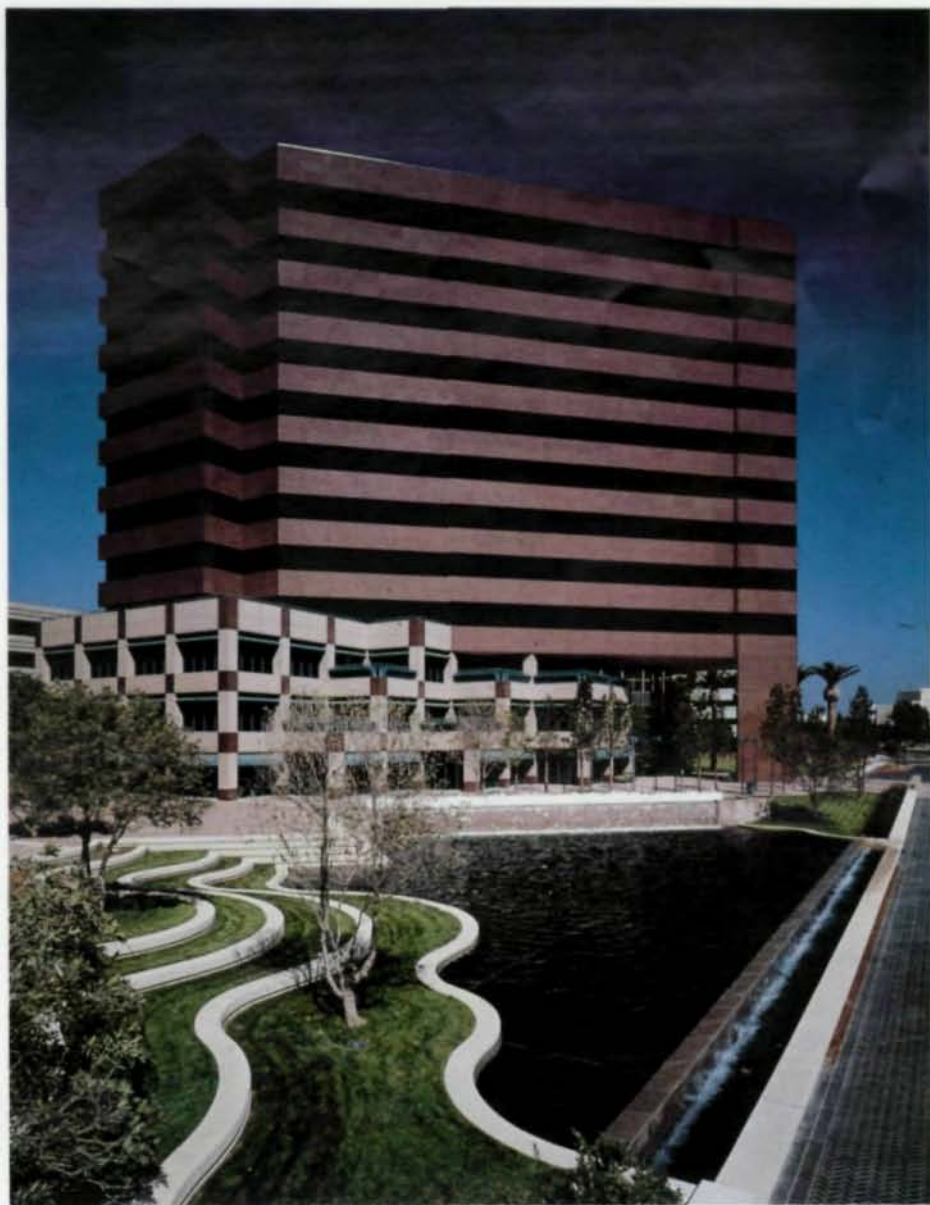

IT IS FUN TO
**DESIGN STEEL
CONNECTIONS**

USING

DESCON

AN EASY TO USE SOFTWARE PACKAGE
FOR YOUR PC

25 TYPES OF BEAM TO COLUMN
CONNECTIONS, BEAM SPLICES AND
BEAM TO GIRDER CONNECTIONS

MOMENT CONNECTIONS
SHEAR CONNECTIONS
BOLTED AND WELDED

EXTENSIVE DATA BASE OF SHAPES,
MATERIAL PROPERTIES AND
SPECIFICATION REQUIREMENTS
INCLUDED

FOR INFORMATION CALL OR WRITE TO:

OMNITECH ASSOCIATES
P.O. BOX 7581
BERKELEY, CA 94707
(415) 528-8328

Complete Structural Solutions In 30 Seconds!

Integrated Structural Design & Analysis

- Beams
- Frames
- Trusses
- Columns

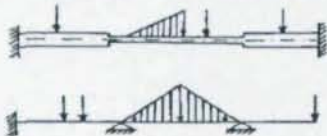

Beam Example

- Visually Oriented
- 2D or 3D Structures
- Definition Graphics in Color
- Any Load or Support
- AISC Steel Library
- Wood Library
- Cross Section Calculator

Our Software Shows What "Ease-of-Use" Really Means!



Engineering Software Company
10670 N. Central Exp., #760
Dallas, TX 75231
(214) 361-2431

"Software Recognized for Simplicity & Speed"



Steel-framed triangular structures (above) answered engineer's challenge.
Elegant buildings overlook distinctive water landscaping.

feet of office space, several restaurants and a 2,000-car parking structure.

Steel Accommodates Views

Although the triangular shape of the towers evolved from the site plan and the need to allow each building its own views without a direct view of any other building, the shape was easier to accommodate by using steel as the supporting structure. With several unusual angles in the buildings, steel facilitated the construction and provided the required strength and flexibility.

Instead of bringing the columns of the building straight down to the ground in typical fashion, the architects stopped them at the fourth level. The result is a carefully articulated street-level scale relating directly to pedestrian traffic.

However, this decision created a structural challenge for the engineers, Brandow & Johnson Associates. Their response in dealing with the additional load, which allowed a clear run of open space at the lower levels and at the plaza, was a deep Vierendeel truss. Spanning the exterior facade, the truss uses columns and beams at nine levels

welded together to form a solid rectangular shape.

The structural steel moment frames of the towers, designed to meet wind and seismic standards recommended by the Structural Engineers Association of Southern California, were chosen because of their speed of erection and economy, essential to the construction of the towers. Steel used for typical framing members was ASTM-A36 Gr. 36, while the lateral resisting welded-frame columns were ASTM-A572 Gr. 50 steel. The Gr. 50-ksi steel used for the frame columns reduced the need for web doubler plates at the column girder connection. Plus, support for the granite window walls required high tolerances and minimum deflections to accommodate the system.

The steel used was economical—14 lbs. psf—which cost less than \$1,000/per ton. While the steel was pre-bid so the construction schedule could be maintained, contractors erected the 3,000 tons of steel in just 12 weeks. Accurate detailing services by the structural steel contractor avoided the consuming field problems.

(continued)

Flexibility Key to New Tenants

The steel frame also permits flexibility to accommodate future tenants. Holes penetrating webs in major girders easily facilitate air conditioning ducts and plumbing lines. Similarly, floor penetration of electrical and telephone lines is facilitated by the 6¼-in. composite concrete/metal deck floor system. The flooring, chosen for its light weight and structurally efficient properties, is a lightweight structural concrete fill over 3-in. metal deck.

Since concrete framing would have required heavier foundations, the lightweight steel frame resulted in savings on the pile foundations. Floor beams span 40 to 45 ft in a building designed to support a live load of 100 psf.

While the erector's equipment and capabilities finished welds in record time, high-strength bolts with short-slotted bolted connections facilitated faster steel erection. And rejection rates for welds inspected by the ultrasonic method were negligible.

The steel frame supports horizontal bands of black glass and Carmen red granite contrasted with pink Spanish granite at the lower three levels. A dramatic three-story glass and bronze entry leads to the two-story main lobby overlooking the plaza, while a glass and steel bridge provides direct access to the ground and second floor from the parking structure. Colorful awnings and planters open onto an all-granite plaza accented by landscaping, waterscaping and sculp-

In this exciting urban environment, created from the challenge of concentrating large amounts of square footage on the acreage, architects have maintained both the visual aesthetics and structural integrity of the twin towers in one of Orange County's newest and most dynamic business environments.

Architect

Langdon Wilson Mumper Architects
Newport Beach, California

Structural Engineer

Brandow & Johnston Associates
Newport Beach, California

General Contractor

Koll Construction Company
Newport Beach, California

Owner

The Koll Company
Newport Beach, California

Patrick Allen, AIA, is a partner in Langdon Wilson Mumper Architects, Newport Beach, California.

1989-90 EDITION

Just Published!

**NEW
and
UP-DATED**

**EXPANDED
TO INCLUDE
SPECIFICATIONS
AND COMMENTARY FOR
CELLULAR METAL
FLOOR DECK WITH ELECTRICAL DISTRIBUTION.**

For 50 years the Steel Deck Institute has provided uniform industry standards for the engineering, design, manufacture, and field usage of steel decks.

NOW AVAILABLE—ORDER YOURS TODAY!

PRICE

\$11⁰⁰

Send checks, postal, world moneyorder, drafts
in U.S. currency.

QUANTITY

**NEW AND UP-DATED Design Manual For Composite
Decks, Form Decks, Roof Decks and Cellular Metal Floor
Deck with Electrical Distribution**

US Currency Total _____
Out of USA surcharge, 15% _____
Add on for Airmail _____
TOTAL ENCLOSED _____

STEEL DECK INSTITUTE, INC.

P.O. Box 9506 Canton, Ohio 44711 (216) 493-7886

See us at Booth 40, AISC—Nashville

GROUP 2000 SOFTWARE

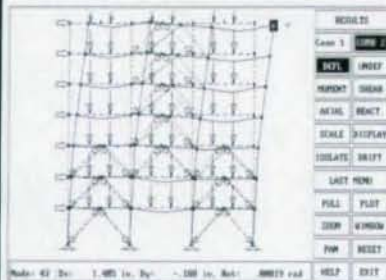

**BEST AVAILABLE
INTERACTIVE COLOR
GRAPHICS FOR
PC, AT, PS/2 AND 386**
Superb, Easy to use
Mouse driven visual interface

Visually Create your Structure
Visually Attach B/C, Sections, Materials
Visually Apply Loads and Analyze
Visually Design Steel Structures

**Fully Integrated
Static and Dynamic Analysis**

STRAND-2D \$1395

Also available: Composite Beam Design \$395,
Biaxially Loaded Steel Beam Column Design \$225

For further information contact:
Group 2000 Engineering Corp.
3520 Long Beach Blvd., Suite 213
Long Beach, California 90807
(213) 595-8041

Two Workshops on Preparation/Painting

Problems and solutions for proper surface preparation of structural steel members will be described in a session on "Surface Preparation & Painting" at the 1989 National Steel Construction Conference. Speakers are Donald A. Ziegler, vice president/engineering, Vincennes Steel Corporation, Vincennes, Ind. and Jon R. Cavallo, representative, S. G. Pinney & Associates, Inc., Eliot, Maine. Moderator is Frank A. Becher, vice president/manufacturing, Vincennes Steel Corporation, Vincennes, Ind. The workshop will be held Thursday from 4:00—5:30 p.m. and repeated Friday, 10:30—noon.

A separate session on "Use and Application of Water-base Paint" will be held Friday, June 23, from 10:30—noon, with a repeat at 1:30—3:00 p.m. The session will pose the question, "Can water-base paint solve the disposal problem and still be satisfactory from both application and maintenance standpoints?" Procedures for proper application are included in the presentation.

William G. Morrow, manager/corrosion control group and Douglas M. Jones, mana-

ger/engineering and research services, Southern Coatings, Inc. are speakers. The session will be moderated by Charles Peshek, Jr., director/fabricating operations and standards, AISC, Chicago.

Shop & Erection Problems—Advice

Three experienced, knowledgeable steel erectors will bring to the forefront some very common erection problems—and offer very cogent advice on how to avoid both the problems and the disastrous consequences which often follow in their wake. The discussion is scheduled for workshop presentations at the 1989 National Steel Construction Conference Friday, June 23, from 1:30—3:00 p.m. and from 3:30—5:00 p.m.

Speakers will be James W. Neal, president, John F. Beasley Engineering Co., division of John F. Beasley Construction Company, Dallas, Tex. and Mark Douglas, project manager, Broad, Vogt & Conant, Inc., River Rouge, Mich. The moderator is Frank A. Becher, vice president/manufacturing, Vincennes Steel Corporation, Vincennes, Ind.

State-of-the-art Review: Cable-Stayed & Jointless Bridges



Anthony F. Gee



Morad Ghali

A paper reviewing designs of cable-stayed steel bridges recently completed or currently under construction in the U.S. and elsewhere will be presented at the National Steel Construction Conference by Tony Gee of Tony Gee + Quandt, a division of Alfred Benesch & Company headquartered in Atlanta, Ga. Particular attention will be paid to certain salient features which affect the efficiency of the design and the performance of the structure. These include, among others, deck cross sections, tower configura-

tions and stay arrangements, in addition to tower and deck slab material, cable and anchorage type and, particularly, stay spacing.

From this data, an attempt will be made to identify the trends which have developed, and are still developing in the design of this increasingly popular type of bridge and finally, to predict the direction these developments might take in the future.

Morad Ghali, a structural engineer with Howard Needles Tammen & Bergendoff, notes that over the past few years many states have adopted measures in their design specifications to achieve complete elimination of expansion devices by using the jointless deck concept. "Although we have gained considerable experience in understanding the behavior of jointless deck bridges under AASHTO loads, we have yet to recognize the full potential of this type of structure under non-AASHTO loads," Ghali says.

One non-traditional application for this type of structure has been demonstrated recent-

ly with the design and construction of jointless bridges at crossings No. 1 and 2 of taxiway E at Raleigh-Durham Airport. With the opening of taxiway E in April 1989, the jointless deck bridges at crossings 1 and 2 underwent unique aircraft loads. These bridges, with welded-steel plate girders, had to resist high longitudinal forces induced by the acceleration and braking of taxiing aircraft.

The objective of Ghali's paper is to elaborate on special design and construction considerations including the longitudinal forces of aircraft on these jointless steel bridges. Detailing at the junction of abutments to steel plate girders will also be presented. Special focus will be given to the advancements achieved by the use of a jointless deck with welded steel plate girders on this project.

Ghali's presentation is scheduled for Friday, June 23; Gee will speak on Thursday, June 22 and Friday, June 23. Both papers are included in the *Proceedings* of the conference, available after July 1, 1989.

915

EPIC LONG-SPAN DECKS



E750—SPANS TO 32 FT.
E600—SPANS TO 26 FT.
E450—SPANS TO 23 FT.
E300—SPANS TO 15 FT.

AVAILABLE FOR DELIVERY—NOW

Galvanized G60-G90
Lengths to 50 ft.

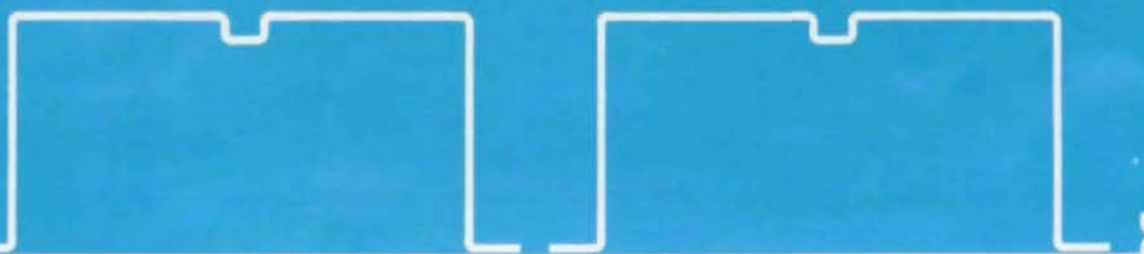

Plated Decks—Plain or perforated
Most complete line of deck products
in $\frac{5}{8}$ " to $7\frac{1}{2}$ " depths

OUR SERVICE WILL SAVE YOU TIME & MONEY

Epic has these profiles available for shipment on an A.S.A.P. Basis!

Your order will be processed in One Week in most cases. Ask about our A.S.A.P. Service.

Call (412) 351-3913 today for price and delivery information and for product advice on all types of Form Decks, Composite Decks, Long-Span and Roof Decks.

Manufacturing Plants:

- Pittsburgh, Pa.
- Chicago, Ill.
- Lakeland, Fla.

Dealer Inquiries Invited

EPIC[®]
METALS CORPORATION

Eleven Talbot Avenue, Rankin, PA 15104
PHONE: 412/351-3913
TWX: 710-664-4424
EPICMETAL BRDK

See us at the AISC National Steel Construction Conference

TAKE CONTROL.



Information shared through the Steel Fabrication Computer System from Design Data allows you to take control of the following

- Estimating
- Material Ordering
- Detailing
- Connection Design
- Inventory Control
- Production Control
- Downloading to CNC Equipment
- Job Cost

Take control with the Steel Fabrication System from Design Data. *It's time...*

**DESIGN
DATA** 

"Software For The Professional"

800-443-0782

See us at
AISC National Steel
Conference in
Nashville

DESIGN DATA