

American Institute of Steel Construction
One East Wacker Drive, Suite 3100
Chicago, IL 60601-2001 (312) 670-2400
Address Correction Requested

- A9.30-5

BULK RATE
U.S. POSTAGE
PAID
Permit No. 4
Senatobia, MS 38668

MODERN STEEL CONSTRUCTION

September-October 1990

\$3.00



Parking Structures
Seismic Review
New Coating Technology

DIAPHRAGM INFORMATION

TYPICAL FLOOR DECK WITH CONCRETE DIAPHRAGMS

GAGE	SPAN	WELD PATTERN	SHEAR p/f
28	2.0'	30/4	1780
26	4.0'	36/3	1670
24	6.0'	36/3	1700
22	6.0'	36/3	1760
22	8.0'	36/4	1710
20	8.0'	36/4	1750
20	10.0'	36/4	1750
18	8.0'	36/4	1820
18	10.0'	36/4	1820
18	12.0'	36/4	1770
16	10.0'	36/4	1890
16	12.0'	36/4	1830

NOTES

1. THE G' (STIFFNESS) VALUE OF 2450 KIPS/INCH CAN BE USED FOR ALL COMBINATIONS IN THE TABLE.
2. SIDELAPS ARE WELDED OR SCREWED (28 TO 24 GAGE) AT A MAXIMUM OF 36" ON SPANS GREATER THAN 5'; i.e. A 6' SPAN WOULD HAVE ONE SIDELAP AT ATTACHMENT, AN 8' SPAN WOULD HAVE TWO.
3. STRENGTH VALUES ARE BASED ON 2.5" COVER OF NORMAL WEIGHT CONCRETE ($f'c = 3$ ksi) OVER THE RIBS; FOR LIGHT WEIGHT (STRUCTURAL) CONCRETE MULTIPLY THE TABLE VALUES BY 0.7. DECK DEPTHS UP TO 3" ARE COVERED.
4. IT MAY BE NECESSARY TO INCREASE THE NUMBER OR STRENGTH OF THE PERIMETER CONNECTIONS TO UTILIZE THE STRENGTH SHOWN IN THE TABLE.

WELD PATTERNS



(UFS)



(UFX)



1 1/2", 2", 3" LOK FLOOR



(B)



(B)



(B)

TYPICAL ROOF DECK DIAPHRAGMS

B DECK WITH 5/8" WELDS TO STEEL AND #10 SIDELAP SCREWS.

GAGE	SPAN	SIDELAP SCREWS	36/3 PATTERN		36/4 PATTERN		36/7 PATTERN	
			q	G'	q	G'	q	G'
22	6.0'	1	165	7	180	13	240	51
20	6.5'	2	220	12	240	21	310	71
18	7.0'	2	270	22	295	38	380	95

"q" IS POUNDS PER FT. G' IS IN KIPS PER INCH.

STEEL DECK INSTITUTE DIAPHRAGM DESIGN MANUAL 2ND EDITION IS THE BASIS FOR BOTH FLOOR AND ROOF DECK TABLES.



NICHOLAS J. BOURAS, INC.

PO. BOX 662, 475 SPRINGFIELD AVE.
SUMMIT, NEW JERSEY 07902-0662 (201) 277-1617



ASSOCIATE MEMBER



**NEW!
VERTICAL
BRACING**

Structural Software Company

The steel man's computer store

Jim Bolling, President and CEO of Structural Software Company, is a second-generation steel man. His 15 years spent managing a 5,000-ton per year family fabricating shop gave him the insider's perspective.

This understanding of the steel man's needs has shaped every program the Structural Software Company markets.

Our programs speak the language of steel, instead of requiring you to become a programmer. And they are designed to work with you, the way you work, to reduce the time and the costs between the bid and the invoice.

 **Estimating** figures labor and material costs and takes into account everything else that needs to happen. The program prices the dozens of items that go into a project, from the mill to the warehouse. Plus, it lets you change almost all of the pricing levels and

labor codes to suit your needs.



FabriCAD, our computerized detailing program, is designed to cut through the steel man's most stubborn logjam--the long waits on details and shop drawings. You can gain control over your schedule and budget and smile at change orders.

Vertical Bracing works hand-in-hand with other detailing features to automatically detail X, V, K and Knee bracing with angles, double angles, and wide flange tees. It automatically details the bracing connections on the supporting beams and columns and lets you locate your working points wherever you want. Plus, it gives you an elevation view of any face.



Material Allocation lets you develop purchase orders by multing and combining your materials. Combine materials for mill or warehouse buying, and mult against your inventory, to recycle drops from previous job. Create cutting lists that will

let you mark each beam with the job numbers and piece marks of the pieces you will cut from it.



If you also sell steel over the counter, **Point of Sale** will let you offer quotes over the phone, based upon material, tax, and labor costs, as well as the client's credit standing.

All of these programs run on IBM-AT or compatible microcomputers.

Call today and talk to some people who can speak your language.

Structural Software Company

5012 Plantation Road

P.O. Box 19220

Roanoke, VA 24019

(800) 776-9118

MODERN STEEL CONSTRUCTION

Volume 30, Number 5

September-October 1990



The new 35-story 750 Seventh Ave. building in New York City is based on the ziggurat, a building form used in constructing ancient temple towers. The unusual shape resulted from the city's requirements for setbacks and the owner's desire for column-free space. Coverage of this project begins on page 24. Photo by Nathaniel Lieberman (718/797-0707).

FEATURES

- 13 **BUILDING FOR EARTHQUAKE SURVIVAL**
An in-depth look at seismic performance of buildings during five recent earthquakes
- 24 **REINTERPRETING AN ANCIENT FORM**
A unique design based on the ziggurat met N.Y.C. codes and a need for column-free space, but required 84 column transfers
- 31 **A BURNING ISSUE**
Changes in fire codes are spurring an increased interest in steel carparks
- 37 **HYBRID CONSTRUCTION**
Combining a structural steel frame with a prestressed, precast deck results in a very efficient, very economical parking structure
- 42 **TAPERED GIRDERS IMPROVE DRAINAGE**
A sloped structural system helped combat the problem of standing water
- 45 **UNIQUE STRUCTURE SOLVES PARKING HEADACHES**
The owner wanted to make a strong architectural statement with a low maintenance facility
- 48 **NEW TECHNOLOGY OVERCOMES MAINTENANCE FEARS**
Today's paints for exposed steel are designed to last more than a decade
- 50 **PARKING SPECIALISTS**
Mulach Parking Structures designs and builds parking structures from coast-to-coast
- 52 **EUROPEAN APPROACH**
Europe shares many of the same parking problems as the U.S.
- 54 **AUSTRALIAN CHALLENGE**
New rules are allowing open-deck parking structures in new locations

NEWS AND DEPARTMENTS

- 6 EDITORIAL
- 8 STEEL SEAWALL SOLVES EROSION DILEMMA
- 10 NEW SYSTEM REDUCES CONSTRUCTION TIME
- 12 NOV. SPEC. MEETING SCHEDULED
- 57 HIGH PERFORMANCE COATINGS FOR STEEL
- 62 PAINT PRODUCTS
- 66 AD INDEX

**We
Make
Steel
Detailing
a Snap!**

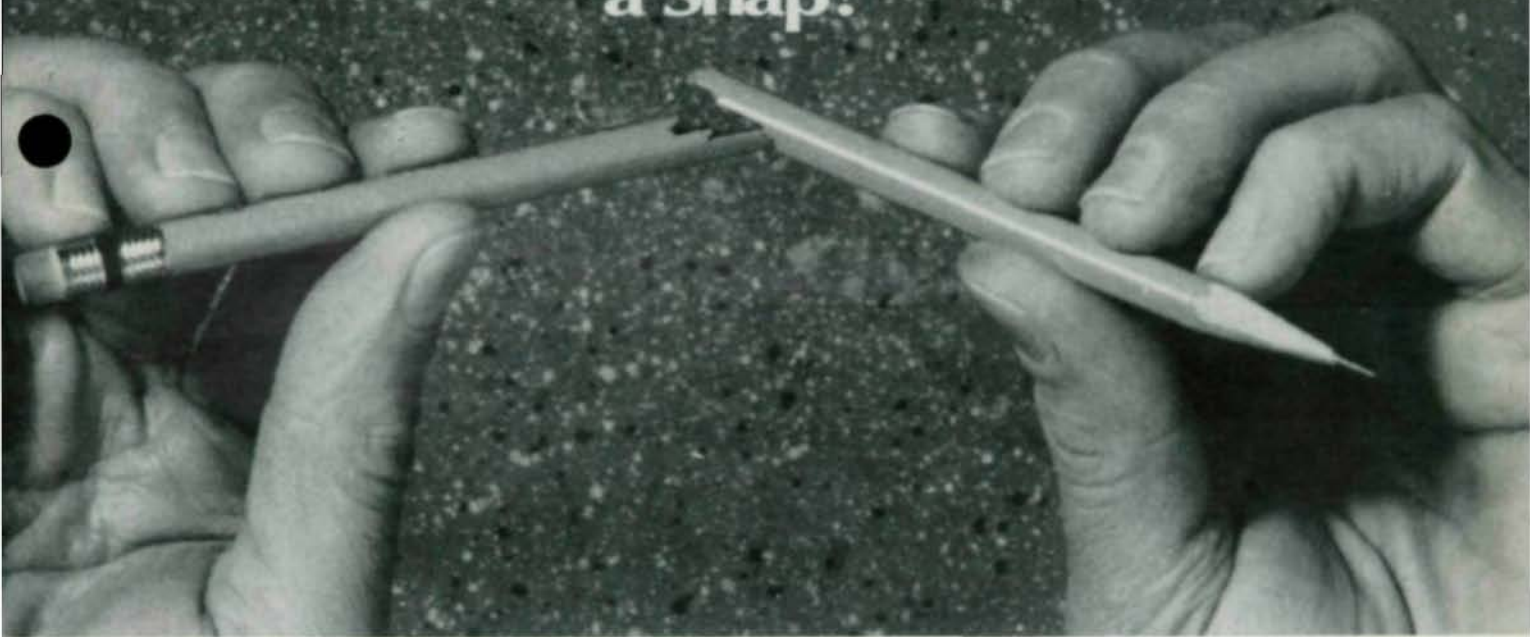

Yes, we know it's a big claim. And, yes, we understand that steel detailing is a complex and demanding process. After all, Steelcad was designed by steel detailers.

As detailers, we felt that computers could offer a solution to the traditional problems facing our business. Our goal was to increase drawing productivity through computers, at a level of operator expertise that did not require a degree in rocket science, engineering or a huge level of experience in steel detailing.

To those ends, we've succeeded. We let the computer deal with the complex or tedious issues; the math, the actual drawing, material counts, shipping, etc... and made 'talking' with the computer very easy to do.

We've succeeded so well that Steelcad is the world's best selling computer steel detailing system. And while we're not perfect, our clients tell us we're a hell of a lot closer than anyone else... and easier to use.

Steelcad II

AUTOMATIC PIECE BY PIECE DETAILING

Steelcad III

AUTOMATIC DETAILING FROM ERECTION PLANS



550 Alden Rd. Ste. 201
Markham, Ontario
Canada L3R 6A8

1-800-387-4201

Call toll free for a free demonstration

Editorial Staff

Scott Melnick,
Editor
Patrick M. Newman,
Senior Technical Advisor

Editorial Offices

Modern Steel Construction
One East Wacker Dr.
Suite 3100
Chicago, IL 60601-2001
(312) 670-5407

Advertising Sales

Eric K. Nieman, Pattis-3M
National Sales Representative
4761 West Touhy Ave.
Lincolnwood, IL 60646
(708) 679-1100
FAX (708) 679-5926

AISC Officers

Ralph H. Clarbourn,
Chairman
Stephen E. Egger,
First Vice Chairman
Frank B. Wylie III,
Second Vice Chairman
Oscar W. Stewart, Jr.,
Treasurer
Neil W. Zundel,
President
David Ratterman,
Secretary & General Counsel
Lewis Brunner,
Vice President,
Membership Services
Geerhard Haaijer,
Vice President,
Technology & Research
Morris Caminer,
Vice President,
Finance/Administration

Increased Steel Coverage

The phone rang earlier this year, and it was an engineer checking to see if I had any interest in a story idea he had sent to me. But even though it was a good idea—a little premature since the project was just underway, but still a good idea—I had to tell him we probably wouldn't be using it.

During the next few months, two or three other people involved with that same airport project contacted me. They were unaware anyone else had spoken with me; they just thought I'd be interested in a good story idea. Unfortunately, I had to repeat that same sad message: It's a good story, but we just don't have room for it.

Now, though, it looks like I was wrong. We will be writing about that project—in the April issue of 1991. Not in the March-April issue; but in the April issue. Beginning in January, *Modern Steel Construction* is going monthly.

The reason for this increase in frequency is two-fold. First, there are stories out there that deserve to be covered; stories we would be covering if we had the space. And second, both our readers and advertisers have requested the change.

The general themes that will be covered next year include: Seismic Design (January); Retail Construction (February); Foreign Construction and Structural Tubing (March); Airport Construction (April); Residential Construction and Hotels (May); Convention Centers (July); Skyscrapers (August); Educational Buildings (September); LRFD (November); and Exposed Steel (December). The June issue will include coverage of the papers presented at the National Steel Construction Conference and the September issue will feature the Steel Bridge Award winners.

In addition, *MSC* will continue its coverage of various product areas: Detailing Software (January); Steel Producers (February); Welding Products (March); Fasteners (April); NSCC Exhibitors (May); Fireproofing (June); Engineering and Construction Computer Software (July); Curtain Walls (August); Metal Decks (September); Machinery, Tools & Material Handling (October); Foundries & Grating (November); and Coatings & Paint (December).

If you have recently completed any projects that warrant editorial coverage, please drop me a note. Remember to include a brief description of the project along with the names of the major building members involved (structural engineer, architect and owner). I look forward to hearing from you. **SM**

00621



HISTAR®

**A new generation
of rolled beams
and column shapes
for economical
steel construction.**

Once again, ARBED leads the industry by featuring a trendsetting combination of mechanical, chemical and technological properties:

- HIGH YIELD STRENGTHS (up to 65 KSI) - even for ultra-heavy sections.
- OUTSTANDING TOUGHNESS PROPERTIES.
- EXTREMELY LOW CARBON EQUIVALENT — ensures excellent weldability.

A NEW PROCESS... QST.

The secret is in ARBED's revolutionary new in-line QST process.

OTHER RECENT ARBED INNOVATIONS:

ARBED-ROLLED 40", 44", and "TAILOR-MADE" (WTM) series — famous for high section moduli, great lateral buckling resistance, and big savings in fabrication costs and weights. These products are also available in the new HISTAR quality as is our standard WF series and H BEARING PILES.

NEW LITERATURE AVAILABLE:

Send now for complete data on all these ARBED products, contact Trade ARBED, INC., 825 Third Ave., New York, NY 10022. (212) 486-9890, FAX 212-355-2159/2421. In Canada: TradeARBED Canada, Inc., 3340 Mainway, Burlington, Ontario, Canada L7M 1A7. (416) 335-5710, FAX 416-335-1292.

TRADE ARBED Inc.

INNOVATORS OF STEEL CONSTRUCTION PRODUCTS.

Steel Seawall Solves Erosion Dilemma



During the past decade, the Sandbridge Beach area of Virginia suffered horrendous erosion. To solve the problem, a steel seawall is being erected. The seawall is constructed of 25'-long, 24"-wide and 0.35"-thick pilings made of ASTM A572 grade 50 steel.

Newspapers have long reported on geologists' findings that erosion is eating away at nearly 90% of the East and Gulf coasts—in some cases at the rate of 2' to 5' a year. But for some Virginia Beach, VA, residents, beach erosion has leapt from the front page to their front door.

In the Sandbridge Beach area, severe erosion was undermining existing beachfront homes. The problem had become so severe of late that the ocean had literally reached the doorstep of some homes and a major storm would have done extensive damage.

Community Effort

To protect the remaining beach and their homes, more than 100 of some 230 oceanfront property owners banded together in 1988 to determine the most cost-effective method.

The homeowners hired Waterfront Marine Construction, a local contractor, to examine various options, including wood, concrete, and steel barriers. Because the homeowners were footing the bill, cost was the prime consideration in choosing a steel seawall.

Other considerations included steel's resistance to wave action and the ease and speed of installation. Also, the seawall concept is environmentally safe, according to Randy Sutton, president of Waterfront Marine.

Depending on the width of an individual's property, each homeowner was assessed from \$40,000 to \$55,000. "In any seaside community, the most economical solution to erosion lies in getting people together to form groups," explained Sutton. "It would be prohibitively expensive for one owner to building his own seawall. By combining owners, we amortized and spread

00622

project fixed costs such as mobilization of materials and equipment and cost of the return walls that are perpendicular to the seawall."

As of early this summer, a protective seawall averaging 8'-high in exposed height has been constructed along two miles of the 4.5-mile shoreline. There are a few open spaces where homeowners opted not to participate, and a thin beach has been preserved where people can walk.

Cold-Formed Steel

The 25'-long, 24"-wide and 0.35"-thick seawall pilings are made of cold-formed, high strength/low alloy steel in ASTM A572 grade 50. The pilings were driven through ancient cypress stumps that once formed a forest behind the rapidly-eroding Sandbridge Beach.

H-Piles Form Bulkhead

One of the first steps was the construction of a 60'-long template of four H-piles, driven vertically into the sand to serve as a correctly-aligned bulkhead so that the final seawall could be erected in a straight line.

Once the steel pilings were in the ground, horizontal beams were bolted to the back of each sheet for structural support. The pilings were roll-formed by the fabricator with an interlock at each edge so that every sheet could be connected with its neighbor to form a continuous wall.

To protect the steel against salt water corrosion, every sheet was coated with either a coal tar or a high-solids epoxy paint on the face exposed to the sea. Life expectancy of the sheet pile material is approximately 50 years, with little or no maintenance required other than minimal touch-up painting. □

STAIR DETAILS WITH AutoCAD

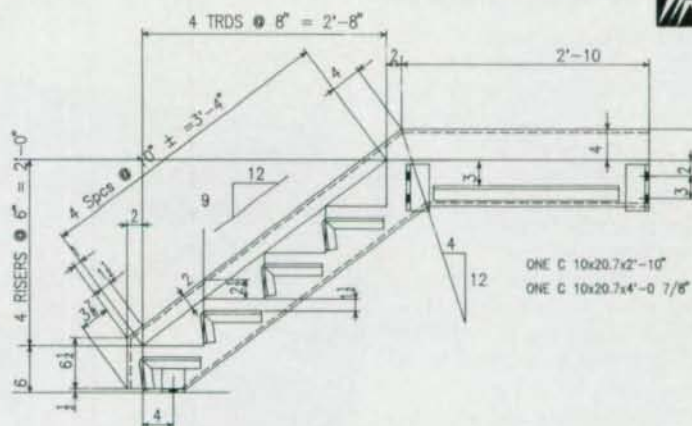

IF YOU CAN'T CREATE THIS DRAWING
IN 90 SECONDS, MAYBE YOU SHOULD
GIVE US A CALL.

OTHER PROGRAMS FOR DETAILING ARE AVAILABLE

COMPUTER DETAILING CORPORATION

1310 Industrial Blvd.
Southampton, PA 18966
215-355-6003

Window Wall/Curtain Wall Mockup Testing

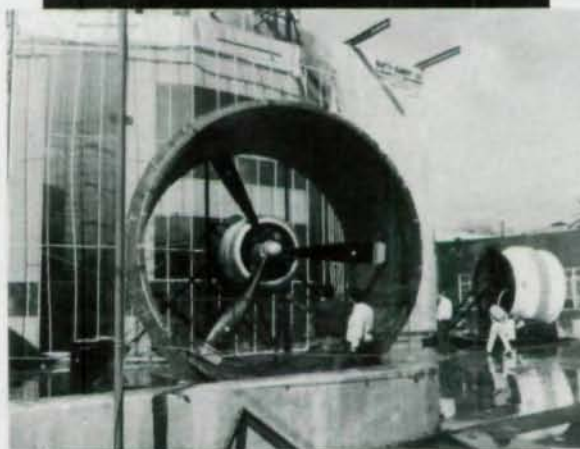

- Testing Facility is 45-foot high by 70-foot long; 300 psf loading capacity.
- Per ASTM and AAMA Specifications.
- Computer aided data acquisition with instant deflection readings +/- .001 inch.
- Dynamic Tests using 2000 HP Aircraft Engine w/13.5 foot propeller.

Wilshire/Westwood, Los Angeles
Granite and Aluminum/Glass Window Wall Mockup ready
for Dynamic Water Infiltration Test.

SMITH-EMERY COMPANY

The Full Service Independent Testing Laboratory, Established 1904
781 East Washington Blvd., Los Angeles, California 90021
213/749-3411 • Fax 213/746-7228



Time Saved Is Profit Earned.

Big profits can come in small packages. Minutes wasted in the office because of manual processing or outdated software can equate to hours or days lost in the shop or field. STEEL 2000 is the solution.

STEEL 2000 is a new, fully integrated, multi-user steel fabrication management system, created to increase your profits by decreasing the time you spend on each job. Even computer novices can become productive immediately.

Designed and implemented by fabricators, STEEL 2000 is the result of years of research and development by Steel Solutions, Inc., in conjunction with Steel Service Corporation, an operational, multi-plant steel company. Call today for more detailed information — we have your package waiting for you.

Service Center	Mill Orders	Estimating
Fabricator	Purchase Orders	Drawing Control
Inventory	Multing	Accounting

STEEL SOLUTIONS, INC.

2260 Flowood Drive
P.O. Box 1128
Jackson, Mississippi 39215
601-932-2760 FAX 601-939-9359



STEEL NEWS

New System Reduces Construction Time

A new steel foundation system that has proven successful for light and utility poles may soon be used for buildings.

The system dramatically reduces the installation time of a foundation system while providing more accurate load strengths, according to Jim Collins, vice president of Foundation & Anchors, Inc., Bridgeville, PA. "Essentially, we have replaced in-ground concrete with in-ground steel to provide patented structures that can handle virtually any load," he stated.

The system starts with the anchor, which consists of a round steel body and four pivotable steel plates. The anchor is inserted into an 8'-deep hole, and the steel plates swing upward to both affix the anchor and consolidate and compact the soil for maximum anchoring strength. "The four plates expand out into the soil through a hydraulic system," Collins explained. "A gauge on the hydraulics shows how compacted the soil is. By adjusting the blades, you can adjust the strength of the soil around the anchor. Essentially, we're prestressing the bearing media prior to construction."

The foundation is then pulled/pushed into the soil to the desired depth rather than driven in, as is the case with standard steel caissons or piles. "Pile driving breaks up the soil and weakens its load bearing capacity," Collins said. The foundation consists of a steel column with either three or four steel fins protruding from the sidewall. It supports structures by resisting all up, down, twisting and rotational motions. Column lengths and fin widths are determined by the load to be supported.

Both the foundation and anchor are made of ASTM A36 steel. Vari-

YOUR SOL-SOLUTION!

User Friendly Computers and IDC now offer the Steel-Pac Turnkey solution to Structural Steel Detailing.

- The Steel-Pac is a unique system which can be tailor fitted to your company's needs.
- Steel-Pac is based on the ARRIS CAD software.
- Hardware and software are offered in one package customized to your budget and operations.
- Operates on either Solbourne (Sun platform), Sun or '386 computers using SCO Xenix and ARRIS.

User Friendly

Personal Computers & Peripherals

User Friendly Computers

2454 30th St. Boulder, CO 80301 (303) 444-0770

ous types of corrosion protection are available, including galvanizing, coatings, and even full cathodic treatment.

In addition to accurately determining the soil's load bearing capability, the new foundation system drastically increases the speed of erection. According to Collins, the foundations usually can be installed in an hour or less, compared to the weeks of pouring and setting of concrete.

Collins added that since foundations are typically eight to 10% of a project's construction costs, the potential savings possible with this new system are substantial. He estimates sales of more than 5,000 units within two years on projects ranging from bridges and buildings to watertanks and traffic lights.

For more information on the system, contact: Foundations & Anchors, Inc., 620 Vanadium Road, Bridgeville, PA 15017.

Nov. Spec. Meeting Scheduled

Chairman Arthur P. Arndt has scheduled the annual meeting of the AISC Committee on Specifications for Nov. 14-15, 1990. The meeting will be held at the Pheasant Run Resort in St. Charles, IL, about 40 minutes from Chicago's O'Hare International Airport.

The main committee will meet on Nov. 15. The agenda includes final review of the update of the Load and Resistance Factor Design (LRFD) Specification.

The meeting is open to all persons having an interest in structural steel design, fabrication, or erection. Invitations may be requested in writing from the committee secretary. Contact: Charles Peshek, AISC, One East Wacker Dr., Suite 3100, Chicago, IL 60601-2001.

IF YOUR PRODUCTS ARE AIMED AT STEEL CONSTRUCTION...

SO ARE WE. *MODERN STEEL CONSTRUCTION* is the only magazine aimed exclusively at the steel construction industry.

• Our controlled circulation of 33,000 is made up of structural engineers, architects, contractors, steel fabricators, erectors, developers and code officials.
...whose only interest is building with steel!

• As the official publication of the American Institute of Steel Construction, our well-read editorial has impeccable credibility.

• Our readers have buying authority. 79% are involved in specifying for their company's projects.

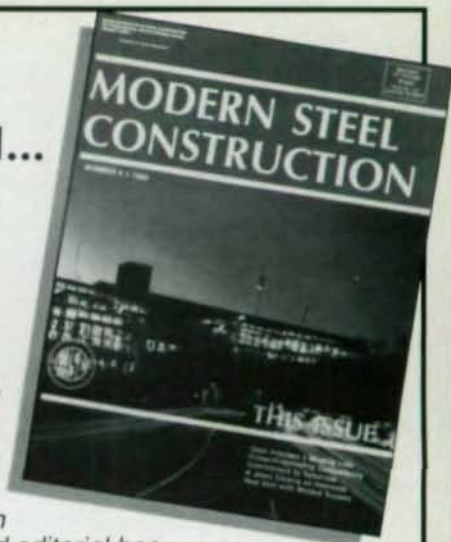

IF YOU WANT STEEL CONSTRUCTION DECISION MAKERS... YOUR AD BELONGS IN MODERN STEEL CONSTRUCTION!

MODERN STEEL CONSTRUCTION

To place your ad, or for more information, contact: Eric Nieman, Advertising Sales at (708) 679-1100.

SUMMER SALE !

- General Structural Analysis
- Concrete Analysis & Design
- Steel Analysis & Design
- Post-tensioned Concrete Design
- Masonry, Timber & Foundations

- > User friendly, integrated, with graphics
- > Simple beams to large 2D & 3D structures
- > Frame/shearwall interaction (including torsion); p-delta effects
- > Final concrete bar schedules
- > Final steel and timber shape selections



over 20 years of use
by over 2000 firms

Save up to 50% - our lowest prices ever !

The most productive structural design software since 1966

(sale ends October 31, 1990)

SAI
STRUCTURAL ANALYSIS, INC.
429 Fifth Avenue
Indianapolis, FL 32903
(407) 394-4257
FAX (407) 728-1064

Call us for additional information or complete this form and mail or fax to SAI

NAME _____ COMPANY _____
STREET ADDRESS _____
CITY/STATE/ZIP _____
PHONE () _____

Fujitsu Interview

with Dave Hutchinson, Vice President/Structural Engineer,
Buehler & Buehler Associates, Sacramento, CA

Q: "Tell me a little about your job at Buehler & Buehler."

A: "At Buehler & Buehler, we are retained by architectural firms to design structural framing for buildings. We create plans for the construction of foundations, columns, beams and bracing. We prepare calculations and material specifications showing actual versus allowable member stresses. The art of what we do is taking a building concept and converting it into practical construction documents. My job is to see that it gets done quickly and efficiently."

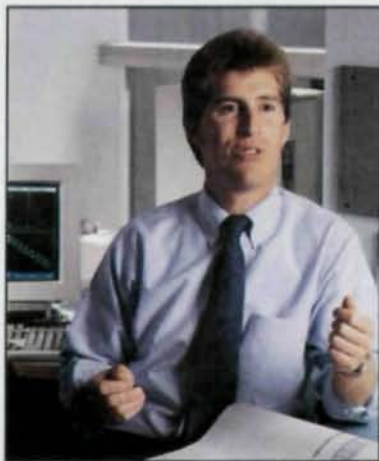

Q: "Why did you select Fujitsu's ElmAnalysis® over other FEA programs?"

A: "It was the only powerful yet easy-to-use FEA program available on the market. Plain and simple. We required a package that could be used by everyone in the office. We have other FEA programs for specialized projects, but most are so complicated that one person must use them constantly just to stay tuned."

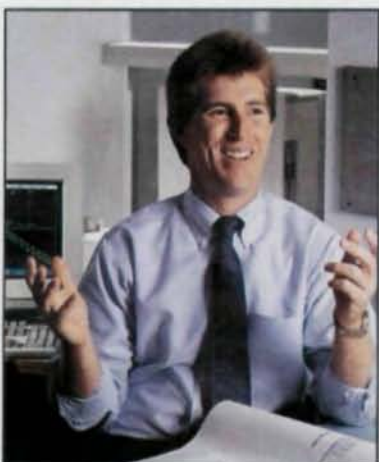

Speed was also critical. Entering data can be a painstaking process that takes hours. ElmAnalysis allows you to create a model of the structure on screen—graphically—in minutes. Which means that you can get more jobs done in less time and with more reliable results."

Q: "What do you mean by 'more reliable results'?"

A: "The fact that it gives a real, visual representation of the project greatly reduces the possibility of error. Member orientation is critical. For example, if a column entered into a program is rotated 90° off its correct axis, the structural integrity is compromised."

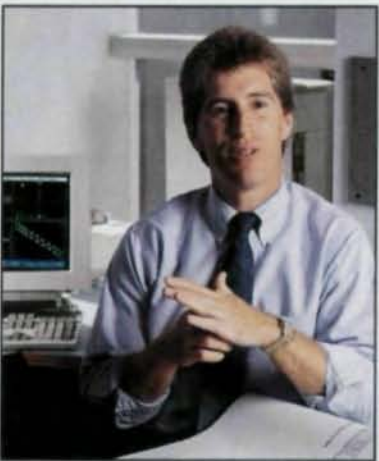

And if it isn't caught, the result can be disastrous—not to mention expensive. ElmAnalysis was the only program that gave a clear, visual representation of potential mistakes. And under the pressure of deadlines, anyone can make mistakes."

Q: "Tell me about some of the jobs you've done."

A: "Like most structural engineering consultants, about 75% of our work consists of smaller projects—schools, warehouses, and office buildings—and a few very large projects like the Memorial Auditorium being built here in Sacramento. It is a large building with some very difficult framing. Elm Analysis is the most practical solution—changes in the design can be viewed and identified graphically without compromising the schedule. And that's critical."

Q: "Do you think ElmAnalysis has improved the way structural and civil engineers work?"

A: "By making FEA programs easier, more engineers will be able to get more work done, and with ElmAnalysis' graphic interface to SAP90™, more options can be evaluated, resulting in better solutions."

Q: "How has Fujitsu's support been?"

A: "It's been great. They have experienced engineers available to answer real engineering questions, so I don't have to worry about being hung up in the middle of a job."

For your FREE ElmAnalysis evaluation disk,

call between 9AM-5PM PST, Mon. - Fri.:
1-800-233-1798 (USA), or 408-432-1300,
ext. 5030 (Canada or outside USA)

ElmAnalysis is a registered trademark of Fujitsu America, Inc. SAP90 is a trademark of Computers and Structures, Inc. Special thanks to Dave Hutchinson of Buehler & Buehler. ©1990 Fujitsu America, Inc. All rights reserved.

FUJITSU

FUJITSU AMERICA, INC.

Information Systems Division
3055 Orchard Drive, Mail Stop B2-6
San Jose, CA 95134, (408) 432-1300

Building For EARTHQUAKE Survival

R. O. Hamburger, S.E.; D. L. McCormick, S.E.; and S. Hom, P.E.

Until about 20 years ago, structural design for almost all materials incorporated the common assumption that at service level loads, the completed structure would remain in the elastic range of action.

In recent years, major design specifications have shifted from this presumption and adopted a philosophy of designing for a safe working load taken as an ultimate or yield resistance capacity reduced by a suitable factor of safety. However, regardless of the assumptions and design procedure used, it is recognized that for service level dead, live, and wind loads, the structure remains nearly elastic.

As would be expected, structural failures resulting from these load cases are quite rare and are usually the result of either gross error, deteriorated structural condition, or gross overload.

Structural design for earthquakes is not governed by the same principles. Despite the use of design procedures for "service level" earthquake loads, all modern design specifications for earthquake resistance inherently assume significant response within the inelastic range. For example, buildings designed in accordance with the *Uniform Building Code* for regions of high seismic risk are proportioned for pseudo-inertial lateral loads equivalent to 20% or less of the structure's weight. Despite well-documented evidence that in the near-field region of a strong



Strong ground motion during the Prince William Sound earthquake in 1964 caused the collapse of this concrete structure with masonry infill (top). In contrast, the steel-framed, eight-story Hill Building is still standing 26 years later.



More than 300 buildings—many of them mid- and high-rise structures, collapsed during the 1985 Mexico Earthquake, which registered 8.1 on the Richter Scale.

earthquake peak ground accelerations of 0.4g or greater are common, with structural amplification resulting in responses closer to 1.0g. Obviously, substantial inelastic response must occur in structures designed for less than 0.2g.

Good structural performance under these conditions requires that a structure possess excellent ductility as well as energy-absorptive capacity and redundant load paths. It is these same qualities inherent in well-detailed steel structures that have resulted in the excellent performance record of structural steel in past earthquakes. Unfortunately, the lack of these qualities has too often resulted in collapses and loss of life in buildings of other construction.

Investigations of the effects of nearly 40 earthquakes worldwide clearly show that life-threatening failure is far less common in steel-frame structures than in structures of other materials. This applies to nearly all classes of structures, including buildings, bridges, and in-

dustrial construction. Structural damage to steel-frame structures has typically been observed to be limited to localized and repairable buckling and yielding of steel elements, as opposed to collapse. Frequently, the most significant repair costs for steel structures are for damage to nonstructural elements, including partitions, curtain walls, ceilings, supported equipment, and similar items, damaged by the large inelastic deformations of the building frame.

Included in this article are several case studies of the performance of steel structures in recent strong ground motion earthquakes. They include a wide variety of construction ranging from modern high-rise to older low-rise industrial buildings. In each case, the steel-frame structures performed far better than nearby construction of other materials, which often experienced life-threatening levels of damage. Ground motions presented are either based on records from nearby instruments or

are estimated based on empirical relations and observation of damage to adjacent construction.

1964: Alaskan Earthquake

In March 1964, the Prince William Sound (magnitude 8.4) Earthquake caused devastating damage to Anchorage and several other Alaskan cities.

Strong ground motion lasted several minutes and resulted in many massive landslides, tsunamis, and the collapse of numerous structures. Steel-frame structures generally withstood the earthquake well.

An example includes the terminal building at the Anchorage airport, which received relatively light damage, despite the collapse of the adjacent concrete tower building. Steel-frame power plants, including the Knik Arm Plant and facilities at Fort Richardson and Elmendorf Air Base, also performed reasonably well, with structural repair costs averaging less than 10% of replacement cost. Pre-engineered steel-frame buildings, such as the Anchorage Ford dealership, also performed excellently.

The performance of the eight-story Hill Building is an excellent example of the toughness of steel construction. A rectangular building with overall dimensions of approximately 50' x 130', it had a vertical-load-carrying steel frame. This type 2 (simple connections) frame supported 5½"-thick one-way concrete floor slabs and exterior walls consisting of precast lightweight concrete panels. Lateral resistance was provided by cast-in-place concrete shear walls located around the central elevator and stair core. Neither the exterior curtain wall nor the steel frame experienced any significant damage. However, the concrete core walls pulverized at foundation level, dropping as much as 5" in elevation. The presence of the vertical-load-carrying steel frame enabled this structure to be repaired and restored to service.

Frame buildings without a structural steel lateral-load-resisting system performed less satisfactorily. An example of less than desirable performance is the Hillside Apartment Building. This five-story structure on a sloping lot had simple steel framing with concrete masonry infill walls provided for lateral resistance. Interior block partitions shattered and collapsed, and exterior walls experienced extensive shear damage, with the entire building racking. Due to the inability of the masonry construction to stabilize the building during the large inelastic response, it was necessary to demolish the structure.

In other buildings, architectural elements that were not intended to provide structural bracing did alter the stiffness and response of the structures, concentrating forces in stiffened areas and inducing torsional response. The six-story Cordova Building is an example of this problem. Rectangular in shape, with dimensions similar to the Hill Building, this structure was provided with a complete steel frame designed for moment resistance in the short direction. Concrete shear walls provided longitudinal shear resistance. Floors were constructed of concrete-filled metal deck on open-web joists. Concrete walls around the elevators, which were not intended to provide lateral resistance, initially resisted significant amounts of lateral load and then failed in a brittle manner. Stair construction in the southeast corner of the building resulted in stiffening of a single column, and the resulting stress concentrations induced severe local buckling. The damaged column and shattered concrete walls were repaired, and the building was restored to service.

Documentation of the Prince William Sound Earthquake includes the unusual report that several steel-frame warehouses, owned by the Alaska Railroad, experienced partial collapse. These were apparently of very low quality, having been constructed of sal-

vage material with very poor detailing. Roof trusses were supported off columns by seat angles, welded to the columns along the vertical sides of the seat only. During the earthquake, tensile stresses concentrated at the tops of the welds, resulting in the angles being torn from the columns and the trusses collapsing. This emphasizes the importance of careful attention to connection details, even

in a ductile material like structural steel.

1985: Mexico Earthquake

The great 1985 Mexico (magnitude 8.1) Earthquake resulted in one of the few well-documented instances of life-threatening damage to significant steel-frame structures. Although the epicenter of the earthquake was located more than 200 kilometers from Mexico

ENERCALC

Engineering Software

Serving The Profession For Over 7 Years, We Are Pleased To Announce Our New Lotus 1-2-3 Based Engineering Software.

Structural Engineering Library, Version 4.0

- This popular package of 41 programs has been completely revised and includes new programs, conforms to the latest codes, has redesigned calculation worksheets, faster calculations, and an extensive list of new capabilities.
- Provides a wide variety of integrated programs for design and analysis of building components in steel, concrete, masonry, and timber.
- Over 45,000 programs installed at 1,300 locations worldwide.

FastFrame, Version 1.2

- The only integrated, spreadsheet based 2-D frame analysis, graphics, and design system. Rigid frames, braced frames, trusses, beams, or any combination are allowed.
- Reliable and consistent 1-2-3 user interface; ultra fast graphics and design solutions, extensive on-line help, a 4,400+ steel section database, AISC code design, and even mouse operation!

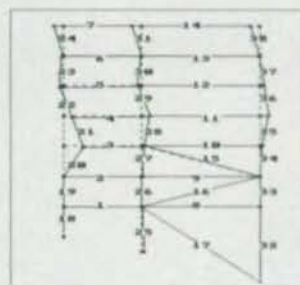

Typical FastFrame Structure Plot

RetainPRO (not based on 1-2-3)

- This is our popular *Cantilevered Retaining Wall* design program. It includes two graphic wall drawings, a database manager, and the ability to perform complete designs in just minutes.
- This detailed program can handle nearly any wall or footing shape, including screen walls, adjacent footings, sloped soil, and multiple stem sections.

@Graphics

- Adds full graphic drawing capability to your 1-2-3 worksheets. Using 31 new "@" functions, you can create complete "live" drawings using your worksheet data.
- Draw lines, circles, arcs, ellipses, colored areas, draw to multiple "windows", write text in hundreds of provided fonts, and even print your drawings! Takes only 60K.

For a FREE Demo Disk and Product Catalog, call (714) 557-9868 (in CA.)

ENERCALC Engineering Software

(800) 424-2252 (Outside)

3070 Bristol Street, Sixth Floor
Costa Mesa, CA 92626



Typical mill building construction in New Zealand uses a high-bay, moment-resisting steel frame braced in the long direction. In the mill shown at top, the castellated beams framing the building experienced some permanent deformation. Pictured above is the Tasman mill, where several masonry walls collapsed, resulting in damage to the adjacent structures and equipment. As in the other mills, the steel was in good condition.

City, the soft soil conditions in the portion of the city overlying an old lake resulted in amplification and filtration of the ground motion. Instrumentation recorded almost a perfect harmonic motion with a period of approximately two seconds and an amplitude of approximately 0.20g, which lasted almost two minutes. This motion proved extremely damaging to mid- and high-rise structures, with natural frequencies in a range that permitted resonance with the ground motion.

Over 300 buildings in Mexico City were severely damaged to a collapse or near-collapse state. Only 12 of these had steel frames, and most of these were constructed prior to the restrictive seismic design provisions adopted following a damaging earthquake in 1957. Dozens of modern steel structures, constructed in the 1960s or later and located within the soft soil zone, were undamaged.

The Conjunto Pino Suarez, a five building complex of 14- and 21-story steel-frame buildings, is noteworthy for the collapse of two of these structures and near-collapse of another. These structures were a combination of moment-resisting and braced-frame construction. Because larger hot-rolled shapes are not commonly available in Mexico, main frame members in these buildings were built-up box column and tubular truss girder sections. Beam-column joints were poorly detailed, compared to common practice in the United States, with stiffening diaphragms within the box columns opposite chords of the truss girders not properly welded. Natural periods of vibration of these buildings were almost identical to the two-second ground motion. The resulting resonance condition and very large dynamic response tore apart the non-ductile connections and led to buckling of columns.

The poor performance of these buildings serves as an important reminder of the need to detail connections for the real demand (either deformation or force) an

earthquake can produce rather than code level forces. This has been a requirement of seismic design codes in the United States for many years. The observed buckling failure of columns in the Mexico Earthquake has led to revisions in recent editions of the *Uniform Building Code*. Those revisions require columns in braced frames to be designed for seismic axial loads approximating those actually expected rather than the much lower "code level" forces used to proportion the balance of the frame.

Adoption of this practice should prevent similar failures from occurring in steel frames in the future. Unfortunately, design requirements for other construction materials, with less capacity to resist inelastic demands, do not yet require consideration of this failure mode.

1987: New Zealand Earthquake

In March 1987, the north island of New Zealand was struck by the magnitude 6.25 Edgecumbe Earthquake. That quake produced ground surface rupture along a distance of 15 kilometers, with vertical offsets in excess of 2 meters. The resulting ground motions caused wood-frame homes to slide off their foundations; overturned diesel locomotives and trucks; destroyed many light-gauge stainless steel tanks at a large milk-processing facility; ripped apart a shopping center constructed of tilt-up concrete; and severely damaged the Matahina Dam, a major earth-fill structure located about 10 kilometers away, requiring the reservoir to be drained to allow repairs.

The region around Edgecumbe is predominantly agricultural and as a result contains relatively few major structures. However, there are three large pulp and paper mills in the epicentral region. The Caxton and Tasman mills are located about 5 kilometers from the fault rupture and are estimated to have experienced peak ground accelerations in excess of 0.35g. The Whakatane mill, located about 15

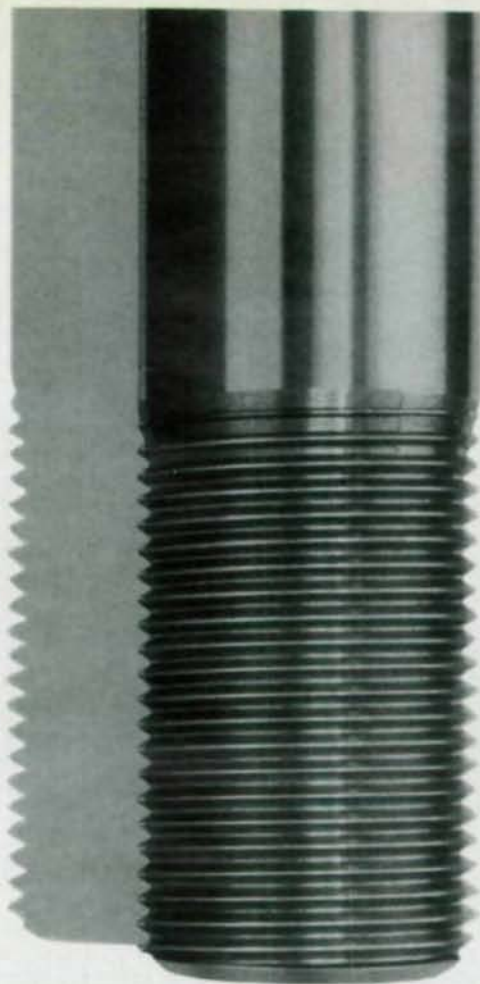

DON'T LET YOUR REPUTATION HANG BY A THREAD

The quality of your construction fasteners can make or break your reputation. At Dyson we have more than a full line of bridge pins, clevises, turnbuckles, rods, nuts and bolts. We have the engineering staff, the QA and calibration laboratories, and the complete in-house manufacturing facilities to design and produce full-integrity fasteners. Special or standard. To ASME, military, Navy nuclear and commercial specifications. For reliably joining together any type construction . . . bridges, bulkheads, piers, towers, dams and foundations. And we've been doing it for almost 100 years. The next time you're faced with a fastener challenge, let Dyson produce forged fasteners that protect your reputation. For more information call TOLL FREE 1-800-321-7058. In Ohio call 1-800-537-2658. Or write Dyson, 53 Freedom Road, Painesville, OH 44077. FAX: 216-352-2700. TELEX: 980-508.

DYSON

FORGED FASTENERS FOR THE BIG JOBS



The magnitude 5.9 Whittier-Narrows Earthquake caused the collapse of the concrete parking structure pictured above, as well as several other concrete structures.

kilometers from the epicenter, probably experienced peak ground accelerations of 0.25g.

As in the United States, mill structures in New Zealand are typically composed of a combination of moment-resisting and braced-steel-frame construction. Depending on the age of the buildings, perimeter walls are constructed of timber sheathing, concrete masonry, or asbestos-cement sheet or metal siding. Interior partitions are typically of concrete masonry. Design criteria for seismic loads are quite comparable to those historically used in the United States and provide for working stress lateral forces of approximately 10% of each structure's weight.

New Zealand codes recognize that under real earthquake loads, bracing is likely to be overstressed and therefore yield in tension and buckle in compression. To minimize damage, their codes specify the use of tension only bracing by requiring a "ductile tensile" brace member that has been necked down to ensure yielding at a known location rather than at connections. As would be expected, during the earthquake, much of this bracing did yield within the

necked-down zones. This yielding resulted in no other detrimental effects, and the bracing was simply and quickly replaced following the earthquake.

Other structural effects to steel-frame buildings at the mills were generally minor. Several tall moment-resisting frames in one of the Caxton mill buildings, constructed of deep castellated wide-flange sections, stretched their anchor bolts and locally crushed the grout beneath their baseplates. Minor permanent lateral offset accompanied this damage but resulted in no adverse effects to mill operation, once travelling crane rails were realigned. In a tall warehouse structure with concrete masonry unit walls, minor buckling occurred in the unbraced lower chords of steel truss-girder. Repairs were limited to replacement of the buckled elements.

By far the most severe damage at the mills occurred to brittle cast-iron components framing the paper-making machinery and to concrete masonry infill walls. Large sections of the cast-iron-frame paper machines at both the Tasman and Whakatane mills experienced brittle fractures. Two

machines were declared to be unrepairable, with one being abandoned and the other completely rebuilt. Machine frames constructed of structural steel experienced no damage.

At the Whakatane mill, a 10-meter-tall concrete-block wall pulled away from its ties to the steel frame and rotated about 1 meter out of plane at the top, threatening collapse. Several concrete masonry walls at the Tasman mill actually did collapse, resulting in damage to adjacent structures and equipment.

1987: WHITTIER-NARROWS, EARTHQUAKE

On October 1, 1987, the Whittier-Narrows Earthquake struck Los Angeles, CA. This moderate, magnitude 5.9 event caused structural damage throughout the greater Los Angeles area, including the collapse of several unreinforced masonry and concrete tilt-up buildings and a concrete parking structure, and the near-collapse of a concrete freeway overpass structure. Some of the heaviest concentrations of damage occurred in Rosemead, located approximately 1 mile from the epicenter.

Ground motions in Rosemead have been estimated as having peak horizontal accelerations in excess of 0.4g and Modified Mercalli Intensity VIII effects.

Several modern commercial buildings, including the California Federal Savings Service Center, were affected. An adjacent precast concrete structure approached collapse and was vacated for approximately nine months for repair and strengthening. Two nearby cast-in-place concrete structures, owned by the local electric utility, experienced significant cracking damage to concrete shear walls and crushing of concrete columns due to overturning loads from shear walls above. The braced-steel-frame Cal Fed building, however, was returned to service within one week.

The Cal Fed building is a four-

story, braced-steel-frame structure. The building is rectangular in plan, with a setback at each floor leaving progressively smaller L-shape upper floors. It was designed in 1981 to the provisions of the 1979 *Uniform Building Code*, using a base shear coefficient of 14%. Estimated response spectra for the earthquake ground motion experienced at this site indicate a peak elastic response (5% damped) of approximately 1.0g, or about seven times stronger than code design levels.

The roof and floors were typically constructed of a reinforced 2½"-thick concrete slab on 3" composite metal deck. A complete structural steel frame using type 2 connections was provided using a combination of ASTM A-36 and 50 ksi, A-572 steels. Exterior walls are precast concrete panels. Foundations consist of 90-ton precast concrete piles, driven to a depth of 48'.

The lateral-load-resisting system for the building consists of the rigid concrete-filled metal deck floor diaphragms, which distribute inertial loads to several vertical braced steel frames. Braced frames typically use chevron or inverted chevron patterns. Braces are either W12 x 58 or W12 x 79 sections, with high-strength bolted end connections. Slenderness ratios for braces are typically less than 120.

Structural damage was limited to the buckling of a single brace on each of the second, third, and fourth floors. Damage was concentrated at the southeast corner of the building, where torsional response of the structure resulted in the largest structural demands. Only the fourth-floor brace was damaged severely enough to warrant replacement. Connections of precast panels at the southeast and northwest corners of the building also experienced some damage, allowing a few panels to rotate outward from the building. The relatively large accelerations and displacements experienced within the building resulted in extensive damage to windows, suspended ceiling systems, sprinkler piping, ductwork, and partition walls.



Several major structures in Rosemead, CA, were damaged during the 1987 Whittier-Narrows Earthquake. The four-story Cal Fed Service Center, however, was returned to service within one week. Structural damage was limited to the buckling of a single brace on each of the second, third, and fourth floors. In addition, there was damage to ceilings and other nonstructural elements.

Many of these components were not properly anchored to the building, contributing to the damage. Such extensive nonstructural damage can be expected in buildings with excessive flexibility and inadequate provision for nonstructural components to withstand large deflections and accelerations.

Despite the intense ground motions experienced by the building, this structure was restored to service within one week following the earthquake. This loss of service was mainly due to nonstructural

damage. It is interesting to note that the chevron pattern of bracing incorporated in the building has a history of experiencing damage in past earthquakes. This is largely due to the tendency of the compression braces in the chevrons to buckle when subjected to the high loads that result from real earthquake response as opposed to code level design loads, and the inability of the tension brace to continue to function effectively following loss of the compression side. This condition leads to low post-buck-

**THIS IS NOT THE TIME
TO FIND IT DOESN'T FIT**



Having trouble getting good detailers?

Testimonials from our overseas clients verify our competency and ability to deliver on schedule

"they have submitted prices consistently which are economic and which have aided us to obtain a substantial share of the market"

"they are used to working with companies at a fair distance away from their (BDS) home base"

For complete steel detailing



BDS STEEL DETAILERS
4849 Manzanita Ave. #81
CARMICHAEL, CA 95608
Ph: 916 332 0987 Fax: 916 332 1758

M-STRU DL®

**The Best Selling
Civil/Structural Program Since 1987**

ANALYSIS

- 2D/3D Frame / Truss / Plate / Shell
- Static / P-Delta / Dynamic / RSA Analysis
- Capable of 1000's of joints and 100's of load cases
- Moving load generator
- Interactive geometry, deflection, mode shape, plots
- Interactive shear and moment diagram plots
- AISC Library included

DESIGN

- Interactive graphic menu driven design
- Continuous beam, section properties, frequency calculations
- AISC code check and sizing including LRFD
- ACI column, beam, footing, retaining wall design
- Design details can be output to AUTOCAD
- Excellent in report presentations

SATISFACTION GUARANTEED*

*See our brochure for details
Supports DOS/OS2 operation systems

**"Ask for a brochure today!"
You'll be glad you did.**



P.O. Box 7326
Fremont, CA 94536-7326
(415) 795-0509
Fax (415) 795-0918

ling strength and rigidity and the types of damage observed in the Cal Fed building.

An alternative to the conservative design now required for chevron pattern bracing is the eccentric braced frame (EBF) concept. In EBFs, the load induced in compression braces is limited by the yield capacity of ductile link beams, which are designed to absorb excessive demands with minimal damage. EBFs therefore have the advantage of being stiff like conventional (concentric) braced frames, while maintaining ductility characteristics of moment frames. Although this construction type has become quite popular in California, few such structures have yet been tested by real earthquakes. (For more information on EBFs, see two articles in the July-August issue of *Modern Steel Construction*: "Vertical Steel Addition Cures Hospital's Space Woes" and "Improved Earthquake Performance.")

1989: LOMA PRIETA EARTHQUAKE

The October 17, 1989, Loma Prieta Earthquake was the strongest event experienced by an urban California area since 1906, and the most costly natural disaster yet to affect the United States. This magnitude 7.1 event was strongly felt more than 100 miles away, and caused severe damage to and collapses of buildings and transportation structures throughout the Monterey and San Francisco Bay areas. Financial losses have been estimated in excess of \$6 billion.

Some of the heaviest concentrations of damage occurred in the city of Oakland, located more than 60 miles from the epicenter. Oakland experienced strong levels of ground motion, with instrumentation located throughout the city recording peak ground accelerations in the range of 0.2g to 0.26g [8]. Within Oakland, damage resulting from this motion included the collapse of over a mile-long segment of the elevated Interstate 880 (Cypress Structure) freeway, a non-ductile concrete-frame structure;

partial collapse of many unreinforced masonry structures; and in total, the red-tagging (condemnation as unsafe) of more than 400 buildings. Major new structures in the city were typically constructed of ductile moment-resisting steel frames and had little significant damage. Most reopened within a few days following the earthquake.

The Emporium-Capwell department store, a major anchor for the downtown commercial district, was perhaps one of the most severely damaged steel-frame structures. Constructed circa 1927, this seven-story building occupies almost an entire city block. It incorporates a complete vertical-load-carrying steel frame with concrete floor slabs and unreinforced infill masonry walls. This is typical of major California construction during the early twentieth century, following the observed good performance of such buildings in the great San Francisco Earthquake of 1906. Most of these buildings, designed prior to the adoption of reliable seismic-resistive code provisions, have no significant system of lateral load resistance with capacity comparable to current standards.

The steel frame for the Emporium-Capwell is composed of hot-rolled steel shapes and riveted built-up plate girder, truss girder, and "H" sections. Interior framing connections of beams to columns are semirigid construction incorporating riveted clip angles at the webs, and top and bottom flanges. Perimeter spandrel beams frame to the outer flanges of columns with direct riveted connections from the beam web to the parallel flange. A system of wind bracing was provided in the perimeter frames consisting of "L" shaped sections framed in a diamond pattern around the many large window openings. All beams and interior columns are encased in concrete for fire protection purposes, while the exterior columns are encased in brick.

Floors of the building are of heavy construction consisting of an

18"-deep concrete pan-joint system, supported by steel beams located along the column lines. The floor slabs are interrupted along one side of the building by a large bank of elevators sweeping in a wide arc across most of the building width.

Perimeter walls of the building are of unreinforced infill brick masonry with extensive terra-cotta trim. Wall thickness is variable, ranging from 13" to 25". On three sides of the building, the walls were interrupted by very large window openings on all levels, while the fourth side, constructed adjacent to other structures, was predominantly solid, resulting in a highly torsional condition.

Like most department stores, the building has relatively few interior partitions. These are mostly limited to fire barriers around stairwells and separations between stock and sales areas. Partitions typically consisted of unreinforced hollow clay tile masonry.

During the earthquake, a large portion of the induced inertial lateral load was initially resisted by the weak, but relatively rigid, hollow clay tile partitions, which experienced brittle failure in the form of shattering and crushing. Debris from these failed partitions blocked many of the stairwells and emergency exits. Following failure of the clay tile walls, lateral loads were resisted by the perimeter masonry walls, the next most rigid elements. These experienced extensive cracking of the clay brick as well as crushing and spalling of the terra-cotta trim. Large lateral shear cracks spread across several of the concrete floor diaphragms in the vicinity of the elevator penetrations.

Despite the heavy damage to concrete and masonry elements, the structural steel frame remained intact, plumb and serviceable. Although the building was judged not to be in danger of collapse, it was red-tagged due to the blockage of emergency exits by masonry debris and the potential for falling debris from the damaged masonry facade. Most of the interior of the



One of the more severely damaged steel-frame structures in Oakland was the Emporium-Capwell Store, shown above and at left just following the Loma Prieta Earthquake in 1989. Extensive damage occurred to hollow clay tile brick masonry and terra-cotta trim on the building. The steel frame, however, was undamaged.

building remained in good condition, and repairs and seismic strengthening were accomplished on the perimeter of the building by removing loose masonry and installing new shear walls. In addition, weak floor diaphragms were strengthened, and damaged clay tile partitions were replaced with dry wall backed by steel studs. The repaired structure should provide many continued years of safe service as a landmark for downtown Oakland.

Earthquake damage to build-

ings is not always a result of the structure's response to the ground motion. Sometimes severe damage can result from the response of the contents within a building. A total of eight warehouse structures in the epicentral region of the Loma Prieta Earthquake were severely damaged by collapsing stacks of inventory (cans of tomato paste) within the buildings.

Seven of these structures are concrete tilt-ups and experienced partial collapse as a result of the wall panels being pushed out by

the contents. One of these buildings was a pre-engineered steel-frame structure. Despite extensive damage to the metal skin of the building and buckling of several steel elements, this building resisted collapse, again demonstrating the toughness of structural steel.

In summary, investigation of damage occurring in past major earthquakes serves as a reminder that the engineers design for only a small fraction of the real demand an earthquake places on a structure. Poorly designed or constructed structures, and buildings fabricated using brittle materials cannot and do not perform properly under such conditions.

Suitability of performance must be judged first in terms of the life-safety protection afforded occupants and second by the feasibility of structural repair and restoration to service. Structural steel build-

ings and structures have consistently outperformed construction of other materials. Some of the major reasons for this are:

- Structural steel is inherently ductile and can continue to carry load even after experiencing very large inelastic deformations, continuing to protect life safety when other materials would collapse.
- Steel structures have a low weight-to-strength ratio, with the result that designers have historically been able to provide very sound structures with minimal increase in materials cost.
- In past earthquakes, steel-frame structures that were not specifically designed for seismic resistance have outperformed comparable construction of other materials.
- The engineering properties of structural steel are well defined and can be reliably used to provide economical structures that will behave as expected.

• Steel structures have frequently proven to be amenable to rapid and economical repair, involving the replacement and reinforcement of isolated damaged elements, without resorting to large-scale demolition.

Earthquakes will continue to occur in the future, throughout the United States and the world. Engineers have all of the tools they need to confidently and economically design steel structures that will survive these earthquakes, protect the safety of occupants, and continue to provide service for many years.

R.O. Hamburger, D. L. McCormick, and S. Hom are with the firm of EQE Engineering, a San Francisco-based structural engineering consulting firm specializing in earthquake risk assessment and mitigation. Together, the authors have personally investigated the effects of more than 10 strong earthquakes.

SDS/2— THE TOTAL SOLUTION

for computer
integration

Take control...

The SDS/2 Estimating Module puts better and more complete information into your hands *before* you submit your bid. Now you can price materials by the job and identify labor by individual work centers. Fast, accurate estimates that reflect how your shop really fabricates steel

mean more profitable operations.

The SDS/2 Production Control Module lets you organize and track fabrication operations through your entire production cycle. This includes managing physical inventory, tracking open purchases, and scheduling shop labor and equipment. Timely status reports identify bottlenecks before they happen.

Take control. The total computer solution is here today and it has a name—SDS/2.

"Software for the Professional"
800-443-0782

DESIGN DATA

"It's nice to get a breather once in awhile, but in this business you can't stand still for long."

"Installing the SDS/2 Detailing and CNC Interface Modules solved my most pressing problems. Now that I've broken the shop-drawing logjam, I can move work into production faster and fabrication errors are reduced to the vanishing point. The business is more productive and profitable, but there's still room for improvement."

"Now I'm ready to extend computerization into estimating, inventory control and shop scheduling. Then I'll have the whole operation running at the same level of efficiency and productivity. By putting the same information to work all down the line, I'll really be in control of the entire process."

© 1990 Design Data Corporation

Steel joists are integral part of structural frame...

New Pyramid Arena Built with Custom-Designed Steel Joists from Canam Steel.

Recreating the ancient design of the Pyramids is a monumental engineering and construction feat. The architecture of the new Pyramid Arena in Memphis, Tenn., called for new materials and methods. The steel fabricator had to find

"Canam remained an integral part of the team that succeeded in detailing, fabricating and erecting a beautiful, yet very difficult structure ahead of schedule."

John F. Kirse, Jr., Project Manager
Havens Steel Company, Kansas City, Mo.

a joist manufacturer willing and able to tackle a difficult engineering and manufacturing project.

Canam Steel Joins the Team

Havens Steel of Kansas City, Mo., was the steel fabricator who selected Canam Steel to design and manufacture the custom joists for the new Pyramid Arena. Canam Steel worked closely with Havens Steel's engineers and site personnel in determining the detailed design requirements.



The Pyramid Arena in Memphis is a unique steel framed structure. Joists were used as part of the support system for the skin of the building.

Project Manager Commends Canam

Havens Steel was pleased with Canam's performance, and said so. "Canam participated as a team member from the very beginning during planning. Bar joists were utilized on the sloped sidewalls as the supporting element for the exterior skin system... Canam's production control people responded with a high degree of cooperation and communication..."

"Since the bar joists were an integral part of the horizontal bracing design, there were

unusual requirements for the joist design including the joist bridging. Canam's engineering staff was intimately involved with Haven's engineering and site personnel..."

"Your engineering and customer service staff remained 'at our side' in arriving at solutions to avoid down time and delays."

The Pyramid Arena is an awe-inspiring tribute to teamwork and modern technology. Canam Steel is proud to have served the builders and fabricators of this new wonder of Western civilization.



canam steel
corporation

Open Web Joists—Longspan Joists—Deep Longspan Joists—Trusses—Girders

Plants: Lafayette, IN (317) 477-7764—Washington, MO (314) 239-6716—Point of Rocks, MD (301) 874-5141

Sales Offices: Boling Brook, IL (708) 759-7800—Batavia, OH (513) 752-3543—Parma, OH (216) 888-4922—Blue Springs, MO (816) 224-3353—
Memphis, TN (901) 763-0266—Flint, MI (313) 230-8090—Delano, MN (612) 972-6135—Needham Heights, MA (617) 444-5504—Towson, MD
(301) 494-1400—Findley Lake, NY (716) 769-7121—Virginia Beach, VA (804) 479-1828—Chambersburg, PA (717) 263-7432—Centerville, VA (703) 803-9371

Reinterpreting An Ancient Form

A unique design that met N.Y.C. codes and a need for column-free space required 84 column transfers

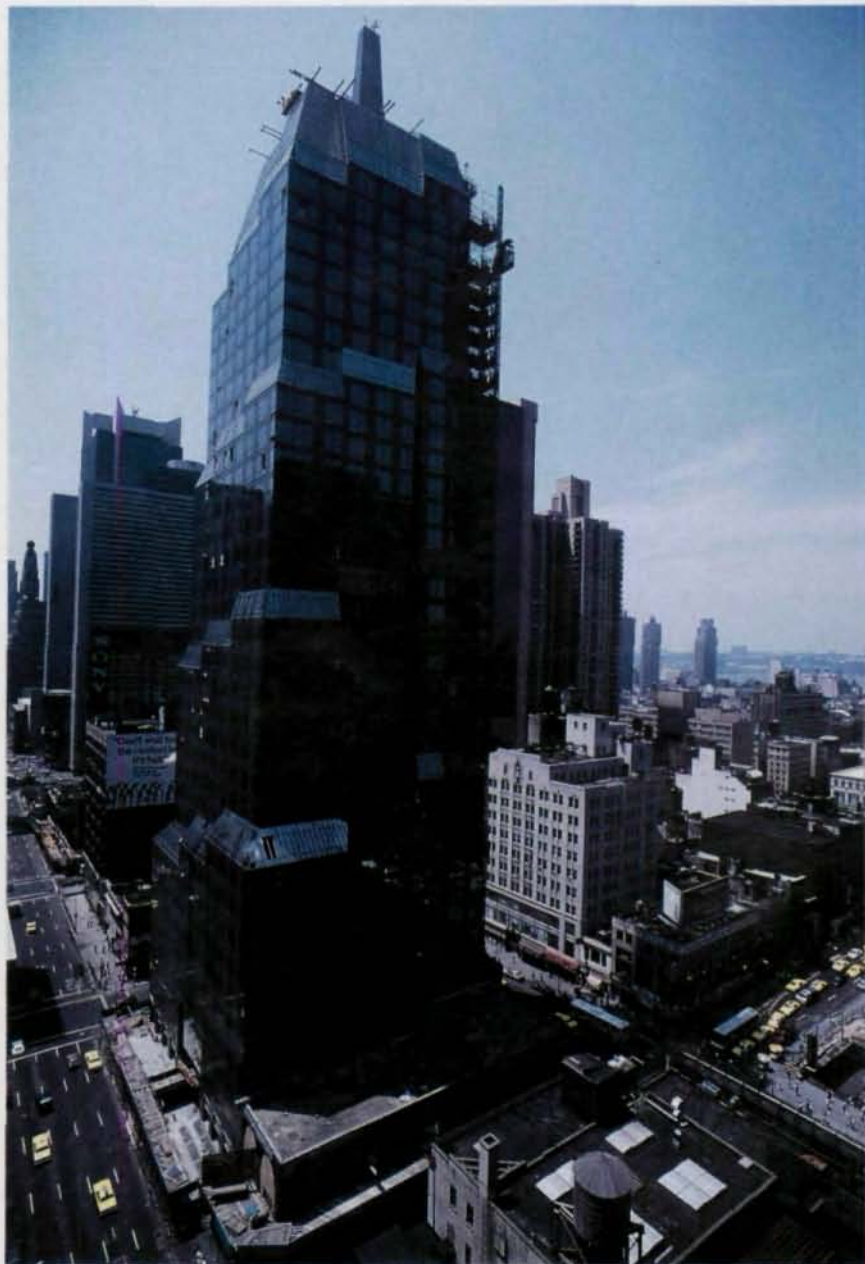

The progressively stepped levels of 750 Seventh Ave. in New York City create a unique architectural image. Above photo by Michel Legrand; right photo by Nathaniel Lieberman (718/797-0707)

If Postmodernism was successful by drawing on Classical references, then the soon-to-be-complete 750 Seventh Ave. building in New York City should be extremely well received. In order to satisfy zoning demands for setbacks, architect Kevin Roche John Dinkeloo & Associates, Hamden, CT, reached all the way back to ancient Mesopotamia for their latest design.

The new 35-story tower is based on the ziggurat, an ancient building form used in constructing temple towers. In form, it narrows as it increases in height, and is marked by spiraling outside staircases or ramps. In the modern New York version, the glass-clad tower gradually steps back along three sides, creating the illusion of giant steps ascending the structure's face.

"The building was creatively sculpted in order to meet a number of design criteria resulting from the New York City building code," explained John G. Shmerykowsky, P.E., partner with Weiskopf & Pickworth, New York, the project's structural engineer. "The site is bordered by three streets, and the building code requires setbacks on all streets. To add visual interest, the architect made these stepping setbacks spiraling around the building, and he designed them as slopes." The spiraling form creates a more dynamic image than a static shape of stacked, diminishing boxes.

84 Column Transfers

However, while visually fascinating, the unusual design creates numerous structural headaches.



TOP OF PARAPET
EL. 550.29
ROOF
COOLING TOWER
35th FLOOR
MECHANICAL
34th FLOOR

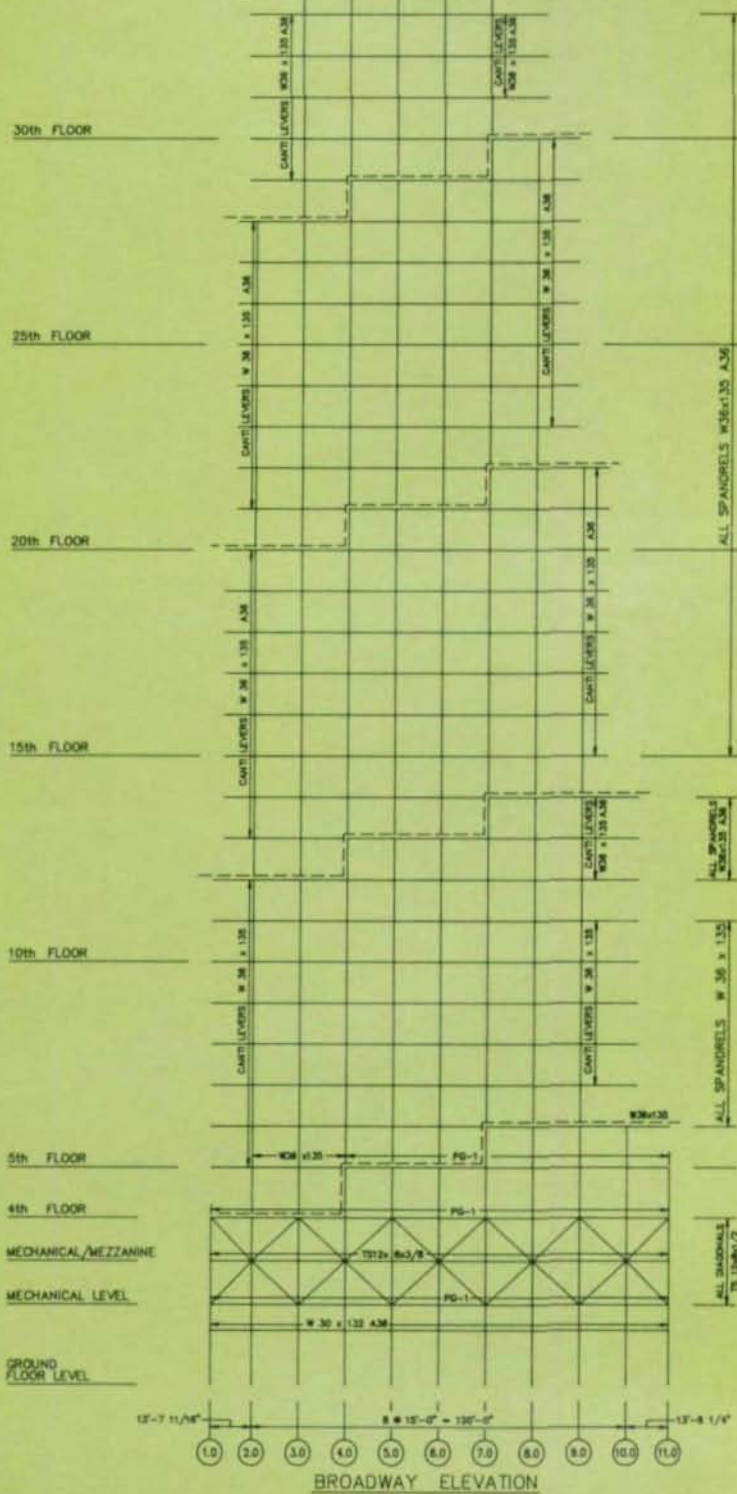

On the lower levels the setbacks are as large as 10', but become progressively smaller, reaching 3'-6" at the upper level. Adding to the complication was the owner's desire for column-free space. "We couldn't carry the column straight down because of the need for column-free space, and we couldn't have sloping columns because the setbacks are at a different location on each floor," Shmerykowsky explained. Had sloped columns been used, very large, unbalanced horizontal forces would have been introduced, especially at the lower floors.

"The only way to satisfy the architectural design and the owners requirements was to use transfer girders," he stated. Project developer was Solomon Equities, Inc., New York.

While three or four or even six or seven transfer girders are not uncommon, 750 Seventh Ave. may have set a record for a building of its size by having 84 column transfers on 26 perimeter columns. Some of the columns are offset as many as four times. Because the column-transfer girders are typically restricted to 42" in depth to fit within the ceiling construction, at the lower levels they have flanges up to 4" thick. "The transfer girders had to be within the depth of the ceiling, which was typically 4' from finish floor to finish ceiling," Shmerykowsky said. "Any ductwork had to pass through the girders." Weiskopf & Pickworth use an in-house program to design for beam penetrations.

Large Wind Loads

"What complicated the structural design is that wind tunnel testing indicated much larger overturning forces than New York City code requires," Shmerykowsky said. "We had to use the exterior of the building as a wind system, so we designed the structure almost as a 'telescoping tube' and the girders get heavier at the bottom." The telescoping tube that Shmerykowsky describes is the overall structure, not the use of

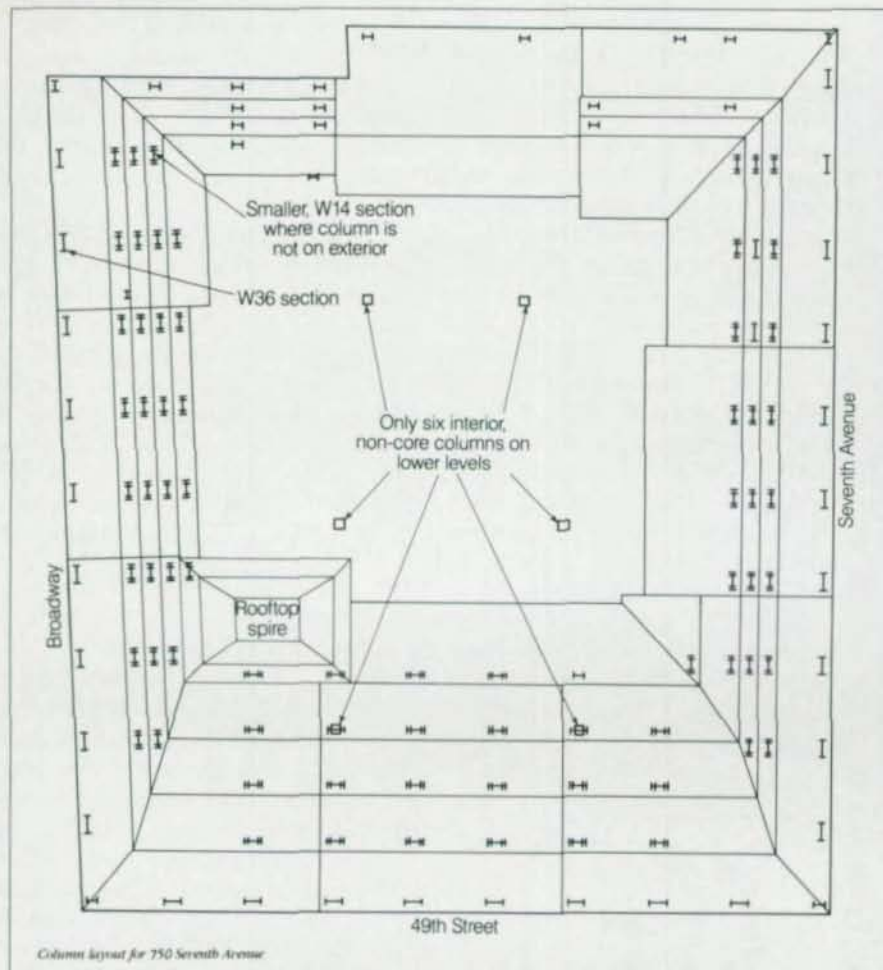

The combined floor plan of 750 Seventh Ave. in New York shows the location of both the interior and exterior columns and a composite view of the setbacks. (Construction photo by Michel Legrand.)

hollow structural sections. In plan, Shmerykowsky's tube is similar to an old sailor's telescope. As each section of the "telescope" resists the wind load, it transfers the load to the larger section below.

The column spacing is 15' on center on the exterior. The closely spaced columns on the exterior combine with the spandrel beams to create a tube system, he explained. The braced core system helps transfer wind shear at the setbacks from one section to another. To further complicate the wind system, the architectural design did not allow corner columns. This led to a modified tube system with cantilevers at each corner, according to Shmerykowsky.

While the exterior columns are W36 sections, behind the sloping curtain wall—where the setbacks occur—the columns become W14 sections. For that one floor, at each

setback, the column is at the interior. "We had to reduce the size of the column, so a W14 section had to be married to a W36 section," Shmerykowsky explained. "This is also where the braced core picks up wind shear, and it helped that the setbacks step up so that only two or three columns are transferred on each side of the floor."

Although there was a considerable penalty in steel tonnage due to column transfers, the structural engineers economized the use of steel through efficient design of long span composite beams with high strength, 40 ksi composite metal deck. The beams were typically spaced 15' on center. This spacing and spans up to 48' made it possible to take the maximum advantage of the live load reduction allowed by New York City Code and minimized the number of steel pieces.

Great care was needed during construction to accommodate the sloped walls, said Thomas McCloskey, project manager with Tishman Construction Corp. of New York, the project's construction manager. "The sloped portions were more difficult to erect, and they were more difficult to seal," he said. The glass is structurally glazed and a lot of attention was paid to the caulking used to make the structure watertight.

Structural Glazing

The building's curtainwall is a combined glass and aluminum system and is one of the first uses of structural glazing in New York City. In structural glazing, the glass curtainwall is not mechanically fastened or retained with a mullion. Instead, it is held in place with a silicon adhesive bead, which doubles as a wind and

water barrier. Even tenants in offices without the sloping sections will have dramatic views due to 10'-wide, 10'-high, floor-to-ceiling windows. The windows are separated by opaque grey glass bands that closely shadow the location and dimensions of the structure's exterior columns. The horizontal bands are 3' deep and equal the depth of the floor-ceiling sandwich, while the vertical bands are 5' wide and slightly wider than the 36"-wide columns that are spaced 15' on center along the building perimeter.

The setbacks also created a difficult erection problem. The contractor and steel erector had to carefully monitor the design and construction of the transfer girders, McCloskey explained. "If they were off by an inch, it would create a problem at the transfer point," he said. Coordination was further

hampered by the site dimensions. Because the surrounding streets are not at right angles to each other, it was more difficult for the surveyors to ascertain whether or not the columns were correctly located. Also, the large number of column transfers resulted in a lot more welded connections than is typical in a structure of this size.

Steel erector on the project for the superstructure was AISC-member American Steel Erectors, Inc., South Plainfield, PA., and steel fabricator was AISC-member PDM Inc., Pittsburgh. Below-grade steel fabricator was AISC-member Bethlehem Contracting Co., Bath, PA, and erector was Expressway Industries, New York. The project used 7,450 tons of steel.

Additional bracing was provided on the third story mechanical floor. Because there were no office windows that would be

affected, the engineer designed full-story transfer trusses.

Most of the exterior columns and girders were wind controlled and are A36 steel. All of the interior steel—the girders, beams, and interior columns—are A572 Grade 50.

The unusual design resulted in a different framing plan for each floor. At the base of the building, floor size is 22,000 sq. ft., but it is only 10,000 sq. ft. at the top floor. As a result, and because the setbacks are in different locations at each floor, more than 2,000 structural detail drawings were needed—about twice the usual number for a 35-story building.

Difficult Steel Erection

The design—as well as the tight sight—also complicated the steel erection. "The site is bordered on three sides by Broadway, 7th Avenue, and 49th St., and Broadway and 49th St. are both bus thoroughfares," McCloskey said. As a result, the streets couldn't be blocked off during construction. To build the cribbing and foundation walls a base was erected on the site. "We brought the crane in over the weekend and only shut a street for one day." That crane was used during the erection of the first few floors. On the 7th Avenue side a climbing tower crane was placed on the sixth floor setback, while on the Broadway side, a climbing tower crane was located on the ninth floor setback.

The tight site also made unloading difficult. "We were restricted to one lane of 7th Avenue and the sidewalk of 49th Street," McCloskey noted.

A final complication was the purely decorative 125'-tall spire on the roof of the building. "It was tall and skinny and there was no place to work," McCloskey explained. As a result, it was difficult to ensure that the spire and the cladding material matched perfectly. To erect the spire above the southwest corner of the roof, the tower crane needed to climb about 50' above the roof level. □



CST
Punches & Dies

Better Than They Have To Be

- 24 Hour Shipments
- Lowest Prices

Call 1-800-446-4402
THE CLEVELAND STEEL TOOL CO.
474 E. 105th Street • Cleveland, Ohio 44108
A-1742



Before We Ship Our Structural Bolts And Nuts, They Have To Earn Their Stripes.

When bolts and nuts come from Nucor Fastener, you can have absolute confidence in their performance. That's because they're American made—and made to meet the toughest standards.

For starters, all the steel used in our structural bolts and nuts comes from Nucor Steel and other domestic steel mills. Plus, we provide raw material origin on all our certifications, and we can supply original steel certification for traceability requirements.

Our product line includes A325, A490 and A307 structural bolts and A563 grade C and heat treated grade

DH structural nuts. And we've recently added mechanically galvanized structural nuts, bolts and washers along with ASTM Type 3 corrosion resistant/weathering products.

Our fully equipped laboratory lets us meet all ASTM quality standards. We provide proof tests and wedge tensile tests for all structural bolt products. And we can full-size tensile test our entire product size range instead of using machined samples.

What's more, we can meet special federal and state highway testing and certification requirements including

rotational capacity testing.

All our fasteners are identified with a lot number on each container which allows traceability to materials, dimensions, processing and testing.

And because we maintain a 7,000-ton inventory of fasteners we can always supply what you need. So call us at 800/334-8397 (in-state 219/337-5611), FAX 219/337-5394 or write us at PO Box 6100, St. Joe, IN 46785. And give us the chance to earn your business.

NUCOR FASTENER

A Division of Nucor Corporation

THE **soda** CHALLENGE!

ON BOTH PERFORMANCE AND PRICE

THE PERFORMANCE CHALLENGE

Test SODA against your inhouse structural steel software package. If you can produce a steel framework design that weighs less than that determined by SODA, we'll give you the SODA package absolutely FREE (with 90 days free support).

Order a SODA package for a 30 day trial evaluation period and take us up on our challenge on both performance and price (orders are accepted from only bona fide businesses). We are convinced that you will then give serious consideration to purchasing SODA and becoming another one of our very satisfied users.

THE PRICE CHALLENGE

The retail price for SODA is \$2,500.00. Compare the cost of SODA with that for any other comparable structural steel software package on the market. If you can show us a competitive software package that is regularly priced lower than SODA, we'll sell you the SODA package at the lower price (with 90 days free support).

This new release of the structural steel software package SODA (Structural Optimization Design and Analysis) has expanded capabilities to handle space (3D) frameworks, including 3D analysis (first-order and P-Delta) and 3D design (American and Canadian steel codes).

SODA is the only PC-based software on the market with a whole-structure optimization capability that enables it to determine truly least-weight designs of steel frameworks in complete conformance with all

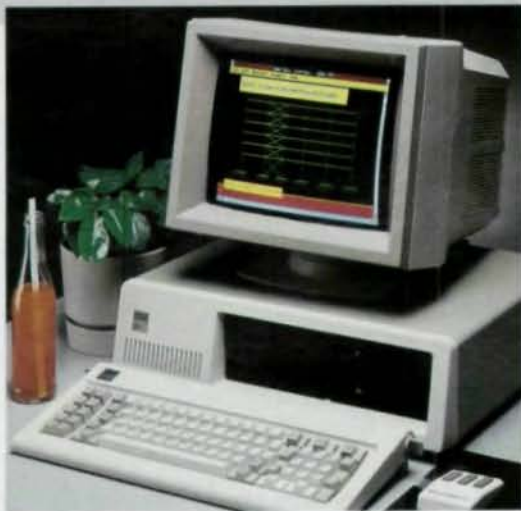

building code requirements that pertain to strength and stiffness.

Simply stated, SODA determines a more cost-effective design than any other comparable software package on the market. For example, the SODA design for a typical framework involving 100 members under strength and stiffness constraints represents a saving in steel costs of approximately \$1,000 versus the design produced by any other competitive software package (ETABS, SCADA, STAAD, etc.)

To get more information on SODA, contact the Distributor in your geographical region:

UNITED STATES
Acronym Software Inc.
4050 Williston Road
South Burlington
Vermont 05403
U.S.A.
Tel. (519) 885-6800
Fax. (519) 746-7931

EASTERN CANADA
Acres Intertel Limited
5259 Dorchester Road
P.O. Box 1001,
Niagara Falls, Ontario
Canada L2E 6W1
Tel. (416) 374-2161
Fax. (416) 374-1157

WESTERN CANADA
A. Edward Smith and Assoc. Ltd.
405, 525-11 Avenue S.W.
Calgary, Alberta
Canada T2R 0C9
Tel. (403) 264-4155
Fax. (403) 269-7799

PUERTO RICO AND CARRIBEAN ISLANDS
C & H Systems Inc.
P.O. Box 7384, Ponce
Puerto Rico 00732
Tel. (809) 840-0303
Fax. (809) 840-2119

soda
WATERLOO ENGINEERING SOFTWARE

A Burning Issue

Changes in fire codes are spurring increased interest in steel parking structures

While many trends often originate on the West Coast, in at least one area California lags far behind usually staid New England: The use of steel for parking structures.

Since 1987, structural steel has been the preferred framing system throughout New England. But as recently as two years before, steel accounted for only 20% of the market in that region. And while New England engineers have been the most enthusiastic to embrace steel parking structures, the structures are rapidly gaining greater acceptance throughout the U.S.

The impetus for this rapid change was the acceptance by a growing number of engineers and local code authorities of the results of the Scranton Fire Test in 1972 and several Australian tests in the late 1980s. Before these tests were conducted, there was a widespread attitude—reflected in almost all building codes—that steel parking structures needed expensive fireproofing.

The Scranton Test was a full-scale fire test conducted in a modern, multi-story open-air parking structure in order to study the effects of an uncontrolled fire in an automobile on the integrity of an exposed steel frame. The then two-year-old, 554-car parking structure, in Scranton, PA, included five levels of parking and some retail stores on the ground level.

Three automobiles were parked adjacent to each other and a fire was set in the center vehicle and allowed to burn unrestricted for 48 minutes. All three cars were modern, American-made full-size sedans with 10 gallons of gas in each tank. Windows in all cars were left partially open.

The test results showed that open-air parking structures represent an extremely low fire hazard and that exposed steel framing provides an adequate degree of safety against structural collapse. Maxi-

mum temperatures and deflection of the structural steel remained far below critical levels throughout the entire test and none of the structural steel was damaged.

Because today's automobiles have more plastic parts than their 20-year-old counterparts, and because today's parking structures tend to be more enclosed than their older siblings, new tests conducted in Australia by BHP's Melbourne Research Laboratories have proved valuable.

In 1985, open parking deck tests demonstrated to the satisfaction of the Australian building regulatory authorities that fire protection of steel in such buildings was not necessary. Again, temperatures reached were well below critical levels. This first series of tests showed that no fireproofing was necessary in open structures, a recommendation that was adopted by the new Building Code of Australia.

Two years later, additional research was conducted on closed parking structures. The research program involved 20 cars and nine tests. The effect of minimum sprinkler and ventilation systems on temperatures developed in the air, cars and steel structure, and the smoke and combustible products



Passaic County, NJ



Becton Dickinson Garage, Franklin Lakes, NJ

PARKING STRUCTURES

generated was investigated and a report was issued.

This second series of tests showed that fireproofing was unnecessary as long as there was an adequate sprinkler system. Again, this recommendation has been adopted by Australia's building code. A paper delivered by Arthur Firkins of the Australian Steel Institute and Ian R. Thomas of BHP's Melbourne Research Laboratories at the 1988 National Steel Construction Conference summarized these findings. They concluded that: "In a closed carpark with a functioning sprinkler system there is no need for fire protection of the steelwork."



Albert Ave. Parking Structure,
East Landing, MI

The three national building codes in the U.S. also allow open parking structures without fireproofing within set height and area limits:

- BOCA National Building Code (1987) allows up to nine levels with 50,000 sq. ft. when two sides are 50% open or 75' in height with unlimited area per level when all sides are 50% open;
- SBCCI Standard Building Code (1988) allows eight levels with 400,000 sq. ft. when two sides are 50% open and exit conditions are met;
- ICBO Uniform Building Code (1988) allows nine levels at 30,000 sq. ft. when 40% of the perimeter is at least 50% open or 75' in height with unlimited area per level when all sides are 50% open.

Fireproofing is needed, with some exceptions, with an enclosed structure and where there is an occupancy above the structure, such as office, retail or residential space. However, the added cost of the fireproofing is often recouped through the savings in construction financing realized

The Software Solution for Structural Engineers & Detailing Professionals

The most complete, integrated software programs available for producing engineering plans, details and fabrication drawings

The Structural Designer

- Powerful application programs for framing & foundation plans, elevations, sections & details
- Produce full engineering design drawings
- Comprehensive industry standard material libraries for steel, concrete, masonry and timber
- Bi-directional Analysis/Design interface
- Stick frame to 3D shape modeler



The Structural Designer and The Steel Detailer operate inside AutoCAD® and are available for personal computers and Sun® workstations.

The Steel Detailer

- Programs for detailing beams, columns, bracing & anchor bolts
- Routines for erection & anchor bolt layout plans
- Steel databases for US, Canadian, British & European countries
- Complete control over drawing composition
- Bill of material weights calculated automatically



D.C.A. Engineering Software, Inc.

AutoCAD is registered in the US Patent and Trademark Office by Autodesk, Inc.

Unifying the AEC World with a Single Source for Solutions
P.O. Box 955, Henniker, NH 03242 (603) 428-3199 FAX (603) 428-7901

Sun is a registered trademark of Sun Microsystems, Inc.

PARKING STRUCTURES

by the faster speed of erection with a steel frame compared to a concrete frame.

Also, some Australian tests now are revealing that an automatic sprinkler system is all the fire protection needed for an enclosed steel parking structure. According to a recently released report, there was little or no damage to cars or structure when an automatic sprinkler was operative.

Today, steel use in parking structures is on the rise, not just in New England, but in the Southeast, and in Midwestern states such as Michigan, Iowa and Nebraska.

Steel's advantages for parking structures include the same factors that make it popular for other building types—faster construction time, greater design and aesthetic flexibility, longer open spans, improved seismic performance, lower life-cycle costs, ease of expansion or conversion, lower weight, and greater quality control—and an additional issue critical to parking structures: resistance to deterioration and corrosion.

Especially in northern areas, many

streets and highways are kept free of snow and ice through the liberal use of chemicals such as deicing salts. Chlorides attack the snow, but also can easily penetrate and damage a concrete structure—and its reinforcing steel.

Even if chlorides aren't used in a garage, they will still be brought in by automotive traffic.

One measure of the corrosion problem is the huge number of products on the market today to reduce concrete permeability, waterproof or seal deck surfaces, and improve the durability and stability of concrete, as well as protecting the reinforcing steel.

The advantage of an exposed steel structural system is that any corrosion can be easily spotted and repaired, either through welding or building up sections. And if there is a problem with the deck, it will not effect the stability of the entire structure. (For information on coatings and paint for steel, refer to the product section beginning on page 57 in this issue.) □

THIS IS WHAT IT TAKES TO BE A BOLT MANUFACTURER IN THE 1990s:

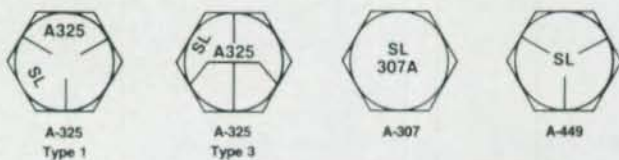

Registered Head Markings on all structural and machine bolts from 5/8" to 3" diameter, all lengths



Countersunk



Bent anchor

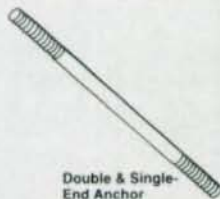

Double & Single-End Anchor

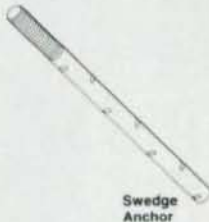

Swedge Anchor

Special Products from 1/2" to 3" diameter

- U.S. made steel
- Wide-range manufacturing capabilities
- Weathering steel: CORTEN X
- Guaranteed full traceability
- In-house lab testing
- Certification

ST. LOUIS SCREW & BOLT COMPANY

6901 N. Broadway/St. Louis, MO 63147/(314) 389-7500



FAX, (314) 389-7510
Toll Free, 1-800-237-7059



NONSTANDARD DE REQUIREMENTS AT DESERT

*Bow Spring Steel Joists
Desertare Elementary School
El Paso, Texas*



SIGN IS ONE OF THE FAIRE ELEMENTARY SCHOOL.

Bow string steel joists were the order of the day for the designers of Desertaire Elementary School. They wanted a multi-purpose room that was not only functional but architecturally interesting and attractive as well.

We filled the order for those joists. We're the largest supplier of steel joists in the country and we provide more than a dozen nonstandard designs, the most in the industry.

That's a lot. But then we've been making nonstandard joists for a long time. And the manufacturing expertise we've developed over the years, plus our large inventory of steel, enables us to make them quickly and economically.

And the earlier we get involved in the design stages the better for the project. Because our experienced engineers can assist the building's designers, and bring the end product in at less cost and more quickly than could be done with traditional methods.

So when you're designing your next project, think of Vulcraft nonstandard joists. They give you the opportunity to expand your design possibilities while retaining the advantages of steel joist construction. And those advantages are many.

Vulcraft joists are strong, yet lightweight and easy to erect. And they can be delivered to your site when you need them. In short, they meet all the requirements for a truly outstanding product.



Gable



Scissor



Offset Double Pitch



Arched Chords

PO Box 637, Brigham City UT 84302 801/734-9433; PO Box F-2, Florence, SC 29502 803/662-0381; PO Box 169, Fort Payne, AL 35967 205/845-2460; PO Box 186, Grapeland, TX 75844 409/687-4665; PO Box 59, Norfolk, NE 68701 402/644-8500; PO Box 1000, St. Joe, IN 46785 219/337-5411. Architect: Alvidrez Associates, Inc., Structural Engineer: Robert Navarro and Associates, General Contractor: Arrow Building Corporation. Steel Fabricator: Ramsey Steel; Steel Erector: River Bend Crane & Rigging, Inc.

VULCRAFT
A Division of Nucor Corporation

The American Institute of Steel Construction, Inc., in cooperation with the Research Council on Structural Connections, is pleased to make the Guide to Design Criteria for Bolted and Riveted Joints, 2nd Edition, available to all designers of bolted joints.

This comprehensive and authoritative reference and design guide will benefit steel designers, fabricators, inspectors, erectors, educators, students and others involved with bolted steel connections.

The current AISC Specification requirements for the design, installation and inspection of high-strength bolted joints are based, in large measure, upon the recommendations of the Research Council on Structural Connections, under whose guidance this book was written.

The 2nd edition incorporates the wealth of research results published since the 1st edition more than a decade ago. Additional information on topics such as slip-resistant connections, fatigue, and beam-column connections will be of particular interest to many steel designers.



Guide to
Design Criteria
for Bolted and
Riveted Joints
Second Edition

Geoffrey L. Kulak, John W.
Fisher and John H.A. Struik

Order Form

Name _____

Company _____

Street/P.O. Box _____

City _____

State _____ Zip _____

Phone _____

AISC Membership No. _____

P633 (\$69.95 x number ___) = \$ _____

Subtotal = \$ _____

Sales Tax
(NY-CA-IL Residents) = \$ _____

TOTAL AMOUNT ENCLOSED = \$ _____

UPS Service Available, Please Specify

Method of Payment: (Please enclose payment with order, no C.O.D. orders, American currency only)

Visa Mastercard Check or Money order

Card Number _____

Expiration Date _____

Signature X _____

Phone orders: AISC, 312/670-2400 x433

Mail to: AISC, P.O. Box 806276, Chicago, IL 60680-4124

(Please have credit card ready)

Hybrid Construction



28 years of experience shows that combining a structural steel frame with a precast, prestressed deck creates the most economical and efficient system

By Michael J.A.H. Jolliffe, P.E.

Zaldastani Associates in Boston has a long history of designing long-span parking facilities. In 1962, the firm designed its first parking structure, a precast, prestressed concrete structure as part of a residential project for Harvard University. Since that time, the firm has designed more than 25,000 parking spaces.

But during the past several years, Zaldastani Associates has been redeveloping its approach to the structural framing of open parking structures.

In developing any design, it is imperative that the parameters to which that design must respond are clearly defined. These parameters will reflect not only the performance of the finished structure or

building, but also the manner in which it is constructed.

Usually, a principle consideration will be cost. For a parking facility, additional parameters relate to the performance of the structure, including: durability in the chloride ion environment of the parking deck; ease and speed of erection; ease of maintenance; drainage performance; visual security; and ease of parking. Structural issues that can affect design include: the ability of a structure to resist lateral loads from wind and seismic forces; the weight of the structure and its effect on the magnitude of those seismic forces and on the foundation; and the effect of the large temperature changes which occur in the open exposed environment.

During the past 28 years, our experience shows that the best material for parking decks is precast concrete, while the best material for the structural support system is exposed steel. Precast concrete has a greater potential for high strength, high durability than poured-in-place. And steel which is exposed to view is much more easily maintained than rebar buried in concrete that has lost its ability to protect the steel when its alkaline environment has been changed by the intrusion of acidic ions.

The exterior of the Becton Dickinson Parking Facility utilizes brick, natural stone, wood, copper and steel on the exterior to match adjacent buildings. Photo by George E. Peirce

PARKING STRUCTURES

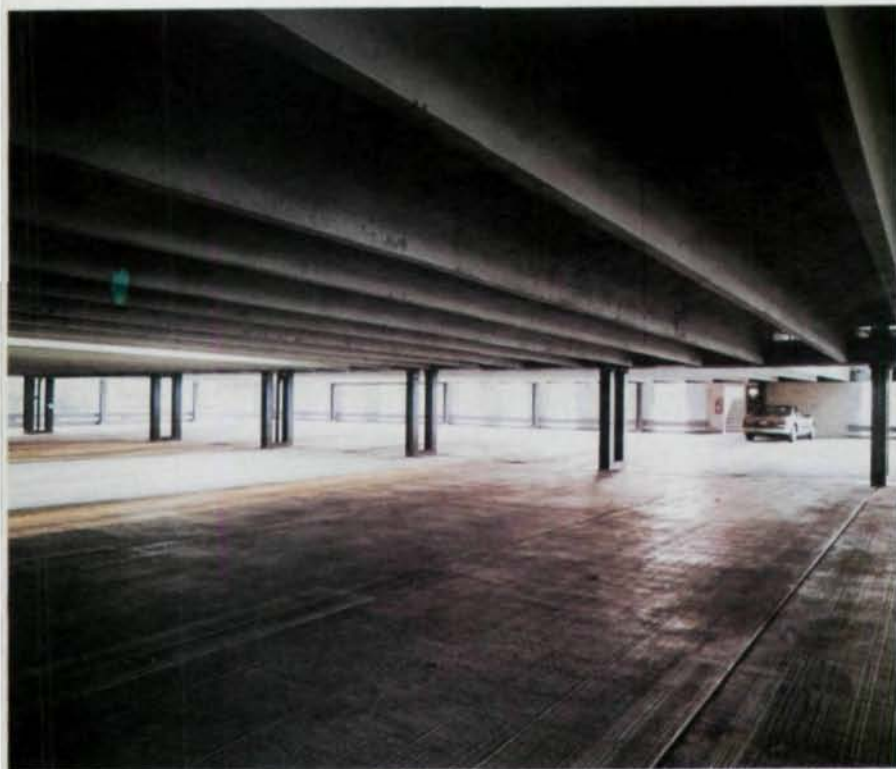

Becton Dickinson utilizes paired steel columns at 10' on center spacing. Using paired columns results in several advantages. It results in a very open, visually uninterrupted floors with no hidden areas. And, drainage and fire protection lines can be protected in the chase between the columns.

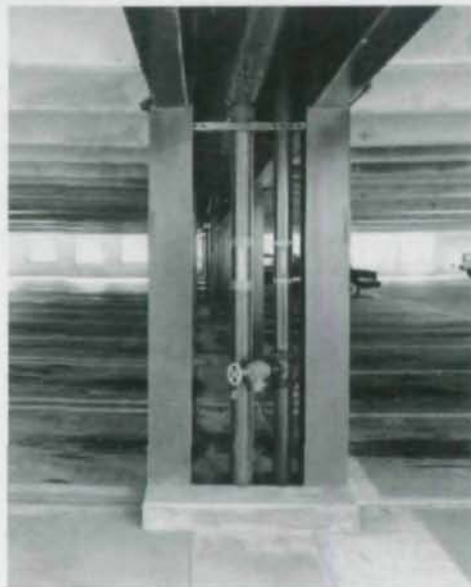

While arriving at this conclusion, we studied not only parking structures, but other building types. For example, Zaldastani recently undertook the design of the structural rehabilitation of Harvard Stadium, which was built in 1903. The seating for 25,000 spectators was constructed of precast concrete "seat"-shaped elements supported on structural steel beams. The deterioration of the precast concrete that had been exposed for 80 years and subject to weathering and the effects of carbonation, but not chloride ions, required its replacement. The structural steel supports, which occurred in line with the open joints of the precast, had to be replaced only where back-to-back channels had been used. The single-span precast units were replaced with precast elements with the joints located away from the main steel and the structural steel was cleaned and painted.

The same phenomenon can be observed on bridges. Even when they are not being maintained, the steel—and even the steel barrier adjacent to the outside lanes where there is significant salt build-up—is in much better condition than adjacent reinforced concrete elements.

Economic Considerations

Another consideration is the cost of the structural system. While precast concrete plants benefit from their efficient production of long line items such as precast, prestressed double tees, the production of individual columns and girders to support the floor deck is less efficient and less economical than the fabrication of such elements in structural steel.

Erection considerations also point to structural steel. At the site, it is very evident that the assembly of the typical structure composed entirely of precast elements is not inherently stable during erection, and must be carefully braced until connected to the permanent lateral load resisting system. This permanent lateral load resisting system frequently is provided by shear walls, which add mass to the structure, interfere with sight lines within the facility, and require the adoption of higher seismic coefficients than with a steel-framed structure. This is particularly disadvantageous in higher seismic zones where lateral load systems are normally governed by seismic rather than wind forces.

In assessing the type of structure that

PARKING STRUCTURES

would best respond to the identified criteria in a facility in which non-combustible, non-fire-rated construction is permissible, the advantages of combining a steel column and girder system with a precast, prestressed long span floor deck become obvious. Based on this initial assessment, we have been progressively refining this "hybrid" structure during the past few years.

The character of the structure is such that it is readily adaptable to different organizations of parking garage layouts, as has been demonstrated by its use to date on sloped-floor, external ramp, and split-level garages.

Becton Dickinson & Company

Although our first-generation use of a hybrid structure was adopted for a municipal parking facility in Cambridge, MA, the principal features discussed above were not all evident until the second-generation with the construction of the Phase I parking facility for the Becton Dickinson & Company Headquarters in Franklin Lakes, NJ.

The Becton Dickinson structure is founded on spread footings. Paired steel columns interconnected by paired plates at 10' on center vertically were first erected to the full height of the structure and the columns were then interconnected at each floor with steel girders at each of the two column lines. This arrangement provided lateral stability in the transverse direction by the ladder frame cantilevering from the ground in the longitudinal direction by conventional frame action. It immediately provided a permanent and stable support system on which to rapidly erect the precast double tees that were welded to the top flange of the girders.

The flanges of the double tees were welded together in the manner normally provided for pre-topped tees, and a connection made between the end of the tees in a shaped cast-in-place concrete infill that incorporated the floor and roof drains. This approach eliminated the structural irregularities normally associated with such ramps.

One of the benefits of the paired column is the very open, visually uninterrupted floors with no hidden areas. This provides a sense of security to the user. Another benefit is that the plumbing and fire protection piping and the electrical conduit can be protected from automobiles by

being located in the chase between the pair of columns. At the Becton Dickinson facility, steel also was used extensively for automobile and pedestrian barrier elements at the perimeters in a manner that ensured the visual integrity of the design. All structural steel, which was so configured and arranged as to make surfaces readily accessible for repainting in the future, was provided with a three-part coating consisting of a zinc-rich primer, epoxy second coat, and urethane finish to ensure a durable and long-lasting finish. Structural steel fabricator was AISC-member Leonard Kunkin Associates, Line Lexington, PA.

Subsequent to the completion of this facility, a number of refinements were introduced, including the elimination of all field welding associated with the structural steel. It was determined that this would improve the manner of assembly of the several structural elements and retain the integrity of the coating system.

University of Massachusetts Medical Center

Two of the parking structures adopting the third-generation approach are those at the University of Massachusetts Medical Center in Worcester and the second garage for the Becton Dickinson & Company Headquarters.

The Medical Center garage provides 1,498 spaces on six levels and was built for just over \$8.5 million, or \$5,688 per space. In this structure, connections of the steel columns and girders were all bolted with the moment connections being made after the erection of the precast floor members



Shown at top is a detail of the barrier elements at the Becton Dickinson Parking Facility. Pictured above is University of Massachusetts Medical Center garage in Worcester. The medical center garage provides 1,498 spaces on six levels for just over \$8.5 million.

PARKING STRUCTURES

on each of the girders. The connection of the precast to the top of the supporting girder also was made by installing a bolt into an insert in the precast member. The benefit of these changes was the increased speed of erection, which enabled as many as 29 pieces of precast deck—61' x 10'—to be erected in one working day, and the entire project to be erected in two months.

The parking facility was located adjacent to a number of buildings that comprise the Medical Center and Medical School, and that have exterior skin of granite panels combined with bronze col-

\$9 million budget.

Though the second phase of the Becton Dickinson project has very much the same appearance as Phase I in the use of brick, natural stone, wood, copper and steel on the exterior to match the adjacent buildings, the structural system incorporates the improvements developed successfully in the University of Massachusetts Medical Center Garage described above.

Interstate 91

In Springfield, MA, an 1,800 car parking facility has been constructed under Interstate 91 adjacent to the central business district. At this location, Zaldastani Associates adopted the hybrid system not only because of its durability and economy, but also in response to the geometric demands of the site.

Since the roadway above curved in a section of the project and the ground and roadway elevations changed in others, segments of the hybrid structure were built between the lines of piers supporting the roadway above. The use of the structural steel for the primary support structure enabled infill segments of the structure comprised of structural steel beams supporting a cast-in-place concrete slab to provide the segmental or sloped transitions required to the site conditions imposed by the Interstate.

In this project, the relatively light weight of the system reduced the demand on a difficult foundation. An exposed aggregate precast panel proved the most appropriate facade treatment to integrate with the neighboring buildings and the highway above. The introduction of the garage below the highway also has had a most salutary effect by reducing the highway's visual and psychological impact on the adjacent neighborhood.

What has become apparent in our use of this hybrid approach to garage construction is that the combination of materials has enabled us to take best advantage of each of them. It has speeded erection and made the construction more economical. Their combination in the finished garage has provided advantages for the aesthetics, performance, and long-range durability of the facilities created.

Michael Jolliffe is president of Zaldastani Associates, a 50-year-old consulting engineering firm located in Boston. □

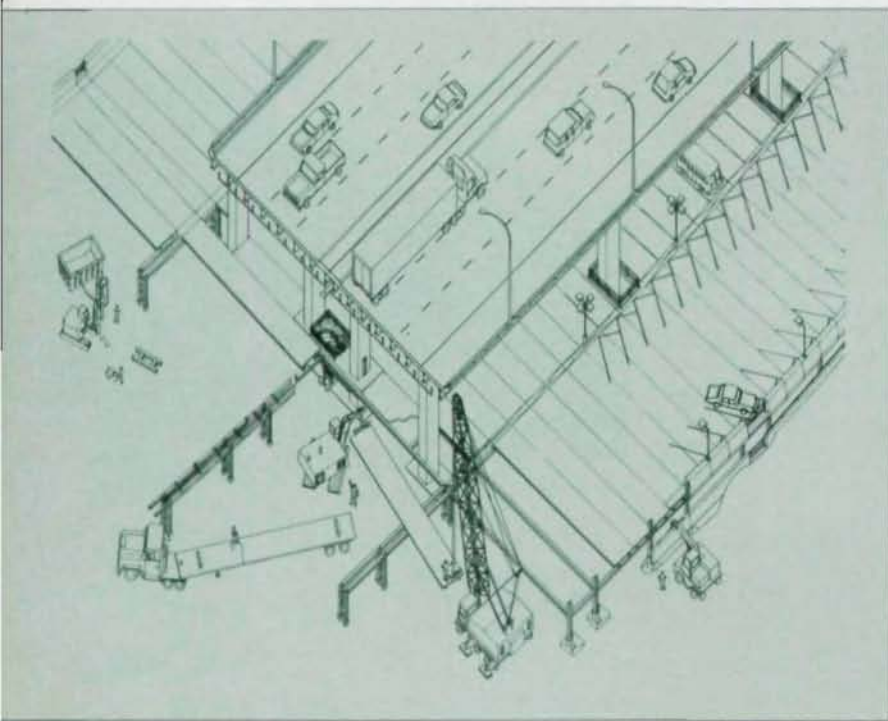

An 1,800-car parking facility was built beneath Interstate 91 in Springfield, MA. A steel-framed structure with precast deck was chosen both for durability and economy and in response to the geometric demands of the site.

ored metal windows and louvers. The exterior of the garage was made to respond to this setting by the use of exposed aggregate precast panels that matched the granite in appearance and by painting the exterior steel a color that matched the metal windows. The ability to fit into almost any setting is another advantage of a structural steel setting, and separates it from the architectural constraints imposed by all-precast structures.

Considering the extensive landscaping and vertical transportation provided, this facility is extremely economical. The delivery in 1988 of a 1,498-car garage for \$8.52 million improved on the owner's original expectation of a 1,300-car garage within a

LRFD/ASD Computer Data Base For Structural Shapes

The AISC Computer Data Base contains properties and dimensions of structural steel shapes, corresponding to data published in Part I of the 1st Edition, *LRFD Manual of Steel Construction* as well as the 9th Edition, *ASD Manual of Steel Construction*.

LRFD related properties, such as X1, X2, and torsional properties, are included in addition to ASD related values.

The program includes the Computer Data Base in ASCII format for the properties and dimensions of the following shapes: W Shapes; S Shapes; M Shapes; HP Shapes; American Standard Channels (C); Miscellaneous Channels (MC); Structural Tees cut from W, M and S shapes (WT, MT, ST); Single & Double Angles; Structural Tubing and Pipe.

Steel Connection Design Software (CONXPRT)

CONXPRT is a knowledge-based PC software system for the design of steel building connections. Three basic types of connections are included in Version 1.0: double framing angles, shear end-plates, and single-plate shear connections. More than 80 configurations are possible.

All designs are according to procedures in the AISC 9th Edition (*ASD*) or latest available references. CONXPRT includes complete data bases for standard shapes, the structural steel, weld and bolt materials listed in the 9th Edition *ASD Manual of Steel Construction*. All strength and serviceability limit states and dimensional requirements for each design are checked. Help menus are included.

Provisions are available to set default values for particular project or shop needs, for example, detailing dimensions.

Steel Member Fire Protection Computer Program

STEMFIRE determines safe and economic fire protection for steel beams, columns, and trusses. It is intended for use by architects, engineers, building code and fire officials, and others interested in steel building fire protection. The software data base contains all the pertinent steel shape properties and many listed UL *Fire Resistance Directory* construction details and their fire ratings. In this manner, user search time is minimized and the design or checking of steel fire protection is optimized. (5 1/4" disks only)

WEBOPEN

This state-of-the-art software package is based on and includes the new AISC *Design of Steel and Composite Beams with Web Openings*. The program is designed to enable engineers to quickly and economically design beam web openings. The easy-to-use color coded input windows provide a clear, logical data entry system.

WEBOPEN was written by practicing engineers and incorporates "expert" design checks and warning messages that enhance the application of the AISC Design Guide to your design problems.

The versatile system designs unreinforced or reinforced openings in steel (non-composite) or composite steel beams.

Professional engineers can design web openings in minutes with WEBOPEN, saving hours of structural design time.

Name _____	Please send:
Firm _____	<u>Quantity</u>
Address _____	___ LRFD/ASD
City _____	computer data
State _____ Zip _____	base @ \$60 each
Telephone _____	___ CONXPRT
Circle one: Check Visa Mastercard	@ \$300 each
Card number _____	___ WEBOPEN @
Expiration Date _____	\$495 for the first
Signature _____	and additional
Preferred diskette size (circle one)	copies for the
5 1/4" or 3 1/2"	same site @\$100
(IBM Compatible Computers Only)	___ STEMFIRE @
	\$96 each
	Total number
	ordered _____
	Total Amount Enclosed:
	\$ _____

Make checks payable to AISC. In New York, California, and Illinois, please add sales tax. On shipments outside the U.S., add 10% for postage and handling. Mail to AISC, P.O. Box 806276, Chicago, IL 60680-4124 or call (312) 670-2400.

Tapered Girders Improve Drainage

To combat the problem of standing water, the designers of a Des Moines parking garage built a slope into the structural system



Construction of the seven-level 9th Street Parking Garage began in October 1989 and is expected to be completed in December 1990. The "skyway" connection shown in the model only will be built as needed.

Before beginning the design of the 9th Street Parking Garage in Des Moines, Gene Arnold and Terry Schuck of the structural engineering firm of Schuck Britson Inc., Des Moines, examined literally hundreds of existing garages.

"The biggest problem in our climate is standing water—both due to the freeze/thaw cycle and chlorides seeping into the concrete slab," explained Terry Schuck, P.E., a partner with the firm. To ensure the structure's durability, the design team realized that good drainage was essential.

The solution was to use a tapered steel girder.

"In Des Moines, there are several older paper-wrapped post-tensioned parking ramps," explained Gene Arnold, P.E., project engineer. "Often the tendons are corroded. The city likes that with steel, the structure is exposed and if any maintenance is needed, it is apparent, not hidden. Time will tell which is easier to maintain, but it's clear that steel will last longer."

Two alternative designs were bid—one of steel and one a concrete prestressed precast double-tee. However, no one bid on the concrete alternative. "The costs would have been similar," according to Arnold.

The 1,200-space garage has girders that span 59'. Instead of parallel flanges, the top flange slopes $\frac{1}{4}$ " per foot with the center of each span forming a "crown". "We have a lot of salt on the streets during the winter in Des Moines and proper drainage is essential," explained Ken Kendall, AIA, a principal with Kendall Griffith Russell Artiaga, Des Moines, the project's architect. One problem with concrete is that during construction tolerances are greater than with steel. As a result, slope is not as rigidly controlled and there can be problems with ponding water. "With steel, you can see a problem developing."

PARKING STRUCTURES

In addition to the positive drainage, corrosion protection included: epoxy-coating the rebar; using 5,000 p.s.i. topping with limestone aggregate and a low water/cement ratio; using a Tnemec epoxy paint on the structural steel; galvanizing the steel for the barrier rails; and using a sealer on the concrete deck.

The girders are spaced 24' on center. I-beams, spaced 10' on center, support the girders. The overall size of the structure is 236' X 256', with typical bay sizes of 16' X 59', 20' X 59', and 24' X 59'. Steel fabricator is AISC-member PKM, Salinas, KS.

In addition to the positive drainage that the tapered girders provided, structural steel was chosen for its ease of maintenance and repair, lighter weight, and faster speed of erection, according to Arnold.

On top of the girders are 2½" pre-tensioned, prestressed concrete slabs and on top of the slab are 3½" of poured concrete. "The slabs act as a composite compression flange for the steel girders," Schuck said. The slabs span 30' in the same direction as the girders.

At first glance the parking structures price tag of \$12,477,000 seems high, but on closer examination numerous contributing factors become apparent. One very expensive feature is a skywalk around the entire third level. Des Moines has an elevated walkway system similar to Minneapolis'. The skyway hadn't previously extended to where the parking structure is located, but the city is trying to encourage development in that area and felt the presence of the skyway would be a boon. Because of the skyway, the building also has four elevators—one in each corner—which further increased the structures cost. The structure is designed to accept future skywalk bridges at all four corners.

Another expensive item is the architectural finish. The city wanted an attractive garage and the architect specified precast panels with embedded pieces of granite around the perimeter.

And finally, the building's site contributed to the price tag. "The old buildings on the site had 20'-deep basements, and they had to be backfilled and the building needed to be put on pilings," Schuck explained.

The \$12.5 million cost includes: \$1.55 million for cast-in-place concrete; \$1.57 million for structural precast planks; \$2.99 million for 1,950 tons of structural steel, including 254 tons for barrier curb tubes; and \$267,000 for auger cast pilings. □



The top flanges of the steel girders are tapered to provide positive drainage. The flanges slope ¼" per foot with the center of each span forming a "crown". In addition to the positive drainage, corrosion protection is provided by: epoxy-coating the rebar; using 5,000 p.s.i. topping with limestone aggregate and a low water/cement ratio; using an epoxy paint on the steel; galvanizing the steel for the barrier rails; and using a sealer on the concrete deck.

The reasons fabricators call Chaparral are as strong as our steel.

Broad Product Line. Chaparral's beams, rounds, channels, flats and angles enable us to be your best source for one-stop shopping.

Availability—What you need when you need it. Chaparral offers innovative roll-and-hold programs to match your delivery requirements.

Knowledgeable Shipping / Central Location. Our centrally located mill allows us to ship with ease throughout North America. In fact, some of Chaparral's shipping innovations have become industry standards.

Sales Force—The strongest in the industry. Our sales teams are responsive to your needs. One phone call to any of our qualified professionals will take care of your complete order.

Price. We're competitive. Prices are quoted on a delivered basis. Give us a chance to meet or beat your current source. Just call us at 1 (800) 527-7979.



CHAPARRAL STEEL

Toll Free (800) 527-7979 In Texas (800) 442-6336
Local (214) 775-8241 Metro 299-5212 Telex 73-2406
300 Ward Road, Midlothian, Texas 76065-9651



Unique Architecture Solves Parking Headaches

The city wanted to make a strong architectural statement with a low-maintenance facility

Urban areas almost always are notoriously short on parking, and East Lansing, MI, the home of Michigan State University, is no exception.

To help alleviate the problem, the city opted to build a 628-car municipal parking garage on a tight site—a location that also would house a bus shelter/passenger transfer point for a local transit company and 10,000 sq. ft. of retail space.

"The city has three other parking structures and it examined them before designing the new one," explained Michael S. Dimitri, a partner with Ramp Engineering Associates, a Manhasset, NY, structural engineering firm specializing in parking structures. The oldest of the existing structures has a poured-in-place concrete frame. "It has been a very serious ongoing maintenance problem because road salt has done damage to the frame," Dimitri said. A second garage has a precast, prestressed concrete frame, and also has had some maintenance problems. The third garage is underground.

To avoid the same maintenance problems, Ramp recommended a steel-framed structure. "We've learned from experience that even if the owner neglects them, they're still relatively easy to repair. It's usually just a case of doing some welding or building up some sections," he said.

"The new paint coatings developed during the past few years also has made steel more practical," Dimitri added. The structural steel was cleaned to SSPC SP-6, Commercial Blast Clean, surface preparation. It was painted at the factory with four mils of a zinc rich primer and top coated with four mils of a high-build Tnemec epoxy.

"Since the structural steel had its final coat of paint applied in the shop, it was necessary to handle all of the steel with

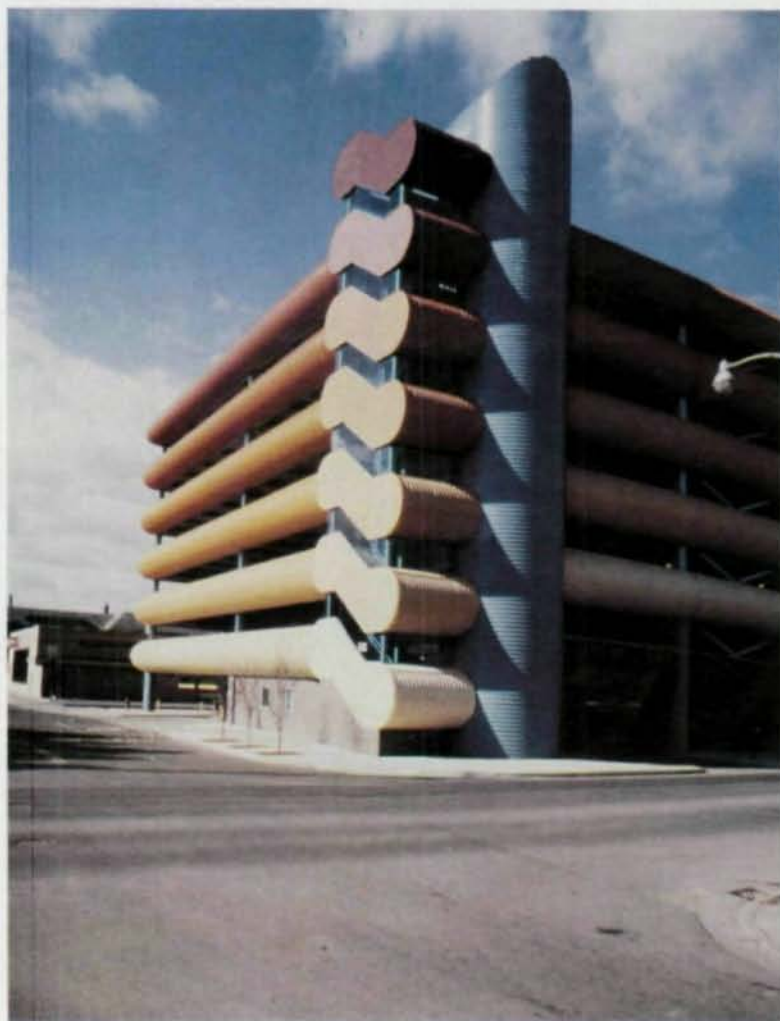

To create an unusual design, the architect clad the garage in curvilinear metal panels of varying hues.

PARKING STRUCTURES



A steel frame was chosen both to achieve the desired 58' clear spans, for ease of maintenance, and to meet the unusual site requirements. The seven-story structure required nearly 1,000 tons of A572 Grade 50 and A36 steel.



nylon slings to prevent abrasions to the painted surface," explained Lawrence F. Kruth, P.E., project manager with AISC-member Douglas Steel Fabricating Corp., Lansing, MI, the project's fabricator and erector. "It also was necessary to detail and fabricate the structure with connections that would minimize the touch up of abraded areas in the field."

The entire seven-story structure was framed with approximately 1,000 tons of A572 Grade 50 and A36 steel. The use of steel girders allowed the designer to achieve the desired 58' of clear spaces that fit the selected functional design. The deck is cast-in-place concrete with shear connections. The functional design developed was a double helix ramp system that permitted all traffic circulation to be one-way in both the "up" and "down" directions, and allowed angled parking for customer convenience. The western portion of the garage was reserved for retail space on the grade level.

Unusual Architectural Design

"We considered a precast frame, but the city wanted this to be something special architecturally, and a steel frame gave us greater flexibility on the choice of architectural finishes," Dimitri said. In a slightly unusual move, the city hired the engineers first and had them design the basic structure before an architect, The WBDC Group, Grand Rapids, MI, was selected.

"With a steel frame we ended up with a thin spandrel panel at the edge of the building," Dimitri said. "That gave the architect maximum flexibility in designing the exterior skin."

The architect chose a curved metal panel applied to the outside of the building as the facade. The curvilinear shape eliminated sharp edges and de-emphasized the large scale of the building. The corrugated steel gives the panel texture which plays off the light, resulting in a chameleon effect as the environment changes. In addition, the use of brightly colored metal ties thematically with automobiles. The colors chosen are all found in nearby buildings.

The panels were designed to be self-supporting and rigid enough to withstand snow and wind loads and rugged use. "The skin was connected with light gauge metal frames and steel studs attached to the structural frame," Dimitri said. Also, the panels had to be large enough to meet

PARKING STRUCTURES

code and safety requirements for pedestrian blockage. The joints needed to be water-tight to allow runoff between panel sections, which meant it was necessary to design special miters at the four corners of the building to achieve a perfect fit between the connecting tubular sections. The sloping floor design of the garage required special flashings and transition panels.

The site itself also contributed to the choice of a steel frame. "This site has poor soil conditions. The garage is supported on caissons and we wanted as light a structure as possible," Dimitri said. Also, the frame was designed to accommodate the addition of an eighth story in the future.

Another site constraint was its being surrounded on three sides by city streets and on the fourth side by a utility alley, none of which could be utilized during the construction process. "Since the site is surrounded by highly traveled city streets, it was necessary to erect the structure with the crane located within the garage," explained Kruth. "The early planning enabled the entire structure to be hoisted and bolted in just 16 working days. This reduced the construction schedule by four weeks, allowing the concrete [deck] pours to begin early."

All of the girders were fabricated with lifting lugs welded to the top flange so the girders could be hoisted without wrapping a sling around the girders. The construction manager on the project was R.E. Dailey & Co., Southfield, MI. "The girders and beams were fabricated with 'knife' end connections to minimize damage to the adjacent framing members," Kruth explained. "The girder end connections were fabricated and erected as AISC Type 3, Semi-Rigid Connections, which resisted the wind loading allowing for interior clear spans by eliminating X-bracing."

The composite design required that shear studs be welded to the top flange of the beams and girders after forming and before the pouring of the concrete. All of the girders and beams were cambered by up to 4" which eliminated the need for most of the shoring of the structure.

Turnkey price on the project was \$7.2 million. "The higher-than-usual cost for a parking structure was due to the bus shelter and 10,000 sq. ft. of retail space," Dimitri said. Also, the cost included the additional stiffening of the frame to allow for future vertical expansion, site work, and some street improvement.

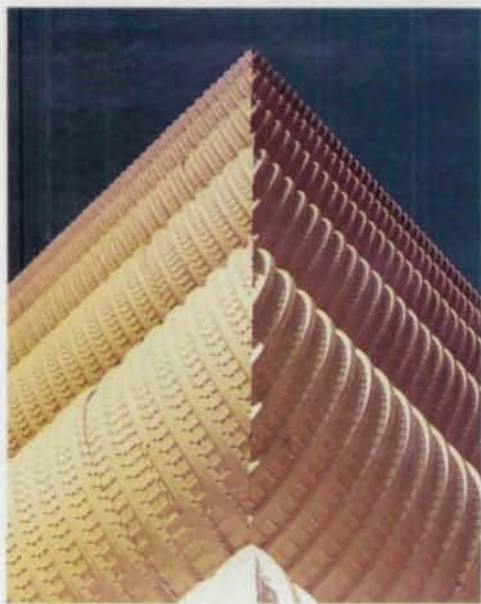

The metal panels on the exterior of the garage are made of corrugated steel. The colors were chosen to complement the colors found on neighboring structures.

New Technology Overcomes Maintenance Fears

Today's paints for exposed steel are designed to last more than a decade with minimal maintenance



The architect of the 550-car Passaic County Garage in Paterson, NJ, wanted a steel frame to convey a light, airy image. He had some concerns, however, about the maintenance requirements of steel. But after investigating recent improvements in paint technology, he was satisfied that a steel-painted structure would be maintenance-free for at least 10-15 years.



When Larry Tromeur, AIA, a partner with Associated Architects in Paterson, NJ, began designing a new 550-car, seven-story parking structure for Passaic County, NJ, he was faced with a dilemma.

"We wanted steel as opposed to concrete to achieve a lighter structure visually," he explained. "From an economic standpoint, steel is highly competitive. The drawback with parking structures has always been the maintenance problem—we didn't want to have to paint the structure every three years." He considered using weathering steel, but decided he wasn't happy with the "rust" color.

Fortunately, Tromeur investigated some of the newer coatings and learned that they have a much longer life expectancy than the older paints. "With the Tnemec paint we specified, we anticipate that the steel will be maintenance free for 10 to 15 years," he said.

Also, steel doesn't discolor the way concrete does, Tromeur explained. "Especially in an urban setting with its smoke and soot, concrete discolors rapidly. You also get better control of the end product with steel. When you build with precast or poured-in-place, it can spall or discolor."

Another reason to use steel was due to site constraints and the desire for long spans, explained Jesse Schwartz, P.E., a partner with Jesse Schwartz & Gabriel Senes Consulting Structural Engineers in Emerson, NJ. "It was a very tight project—the structure comes right out to the property line."

The garage is 198' long and 127' wide column-to-column with an elevator structure in front. It was designed with composite beams and girders—all rolled

PARKING STRUCTURES

shapes—to reduce height and weight. “Non-composite construction would have been about 20% heavier and much deeper,” Schwartz said.

Most of the steel is Grade 50, though some A36 steel was used for some of the short girders. “We had to hold the height of the structure down, and with Grade 50 we came up with a 27” beam. The architect wanted the same depth with the short girders, so we went to A36 steel.” In addition, using Grade 50 steel proved more economical. The beams span 13’ on center. There is a 6½” poured concrete deck with a ½” grooved liner.

Because the structure is situated in a Seismic Zone 2 region, it was designed with diagonal bracing in the four corners. “Another advantage of steel is that it resulted in less weight than concrete, which is a positive in earthquake design,” Schwartz said.

“All of the connections are designed to be easily painted,” he added. “For example, there are no double-angle connec-

tions.” There are end plate connections between the beams and columns, and stiffener plates where the beams are framed into the girders. “That way, the end of the beam is open to be painted,” Schwartz explained. “Steel that is properly painted and maintained will last a very long time.”

Because aesthetics were so important on this job, great care was taken with the steel painting. “Usually, when you put studs on a beam, you don’t paint the flange,” Schwartz said. “But we were worried about rust leaking through, so before the beam was painted we put a 3” wide tape on the top flange. After it was painted, the tape was removed and the studs were put in.” Because the top flange is 10” wide, painting on both sides of the tape gave an additional 3½” of protection to the top flange on both sides.

A final aesthetic touch was the addition of flower planters along the perimeter of the structure. “The planters are supported on the steel railings along the perimeter,” Schwartz said. □

It's good to have a choice . . .

Choose Experience

- Detailing expertise
- Engineering expertise
- Computer expertise
- Service expertise

Choose Solutions to

- Massive design revisions
- Fast track jobs
- Connection design responsibility
- Heavily architectural jobs
- Necessary shop optimization

Choose Variety

- Beams & Columns
- Connection Design
- Templates
- Ladder Systems
- Bracing
- Plate Work
- Pan and Grating Stairs
- Shop Management Reports
- Girt Walls and Door Frames

. . . it's GREAT to make the right one!

Make the profitable choice in Automated Detailing . . . choose PDS



Dogwood Technologies, Inc. 1900 Winston Road Suite 401 Knoxville, TN 37919
 (615) 531-4073 (800) 346-0706

IPDS Procedural Detailing System

Parking Specialists

Mulach Parking Structures designs and builds parking structures from coast-to-coast



Castellated beams substantially reduce the weight of the steel while at the same time providing a more open and airy look.

An open and airy look is the result of using high strength steel and castellated beams in Mulach Parking Structures (MPS) custom garages.

Mulach, which is headquartered in Bridgeville, CT, and has sales offices in West Orange, NJ, and Los Angeles, has been designing and building parking structures since 1976. While all Mulach garages share certain common features, the company does not take a "cookie cutter" approach; rather, each garage is custom designed to meet site and regional variations.

The MPS system includes: the use of a steel superstructure with high-strength composite castellated beams for clear span girders; a reusable form support system consisting of steel joists, special brackets and coated steel decking; two-way post-tensioning system for the concrete slab; concrete admix, penetrating sealer and traffic-resistant expansion joints; and a long-life steel coating system. In addition, the concrete slab is guaranteed for 10

years against leaks and the expansion joints are guaranteed for five years.

Because the concrete slab used in open parking structures undergoes continuous volume changes, resultant movement must be absorbed by the frame to prevent cracking and buckling of the slab. Steel frames have more flexibility than concrete frames.

"The use of castellated beams just about cuts the weight in half," according to Edwin L. Mead, P.E., president of MPS. "We use Grade 60 steel, and our castellated beams weigh between 60 and 70 lbs/ft., while an equivalent rolled flange would weight about 118 lbs/ft. But a castellated beam puts more steel in the tension area."

The lighter weight is an advantage both in seismic design and in reducing the amount of deadload on the foundation, and thus reducing foundation costs.

The castellated beams also provide an aesthetic advantage. "The openings allow light to pass through. The hexagonal holes

PARKING STRUCTURES

are very decorative," Mead explained. In addition, the openness of the system translates into savings on the amount of light fixtures needed.

Lafayette Square

A project recently completed by MPS is the eight-story, 878-car Lafayette Square parking garage in Bridgeport, CT. "Lafayette Square presented MPS with a unique design problem," according to Mead. "Because of the size of this garage, the client wanted a double-threaded helix concept to minimize the number of circuits the driver would have to make. Also, the double-threaded helix would provide one-way traffic for more efficient traffic flow."

Compounding the problem was the site's small footprint of 174'-wide-by-207'-long. "The solution was to provide a three-bay structure with two 56' exterior bays and a 62' center bay," Mead explained. "By ramping all four sides of the structure, we were able to keep the slope of the ramps to an acceptable 5%."

In contrast, most double-helix garages only ramp two sides, primarily due to drainage problems. "When you ramp all four sides, you create a flat area. We tapered the top flange of our beams so it slopes 1/4"/ft," Mead said. The supporting castellated beams were fabricated with a horizontal bottom flange and a top flange sloping from 32" deep on each end to 29" deep at the center of the flat area. "With a precast concrete structure you're dealing with a plane that can't be warped. And with poured-in-place concrete, it would be very difficult and very expensive to create a slope."

680 Tons Of Steel

The \$6.7 million structure required 680 tons of steel. Structural steel fabricator on this project, and most MPS structures, was AISC-member Mulach Steel Corp., Bridgeville.

According to MPS, the concrete slab is the major problem area in parking structures. While a 4,500 p.s.i. concrete mix is recommended by the Portland Cement Association when de-icer is present, MPS opts for a minimum 7,000 p.s.i. concrete mix, including silica fume admix for all supported deck slabs.

"This mix greatly enhances the durability of the concrete by strengthening it, adding to its electrical resistivity, and preventing the passage of water and de-icing



The exterior of Lafayette Square was designed to blend in with neighboring buildings.

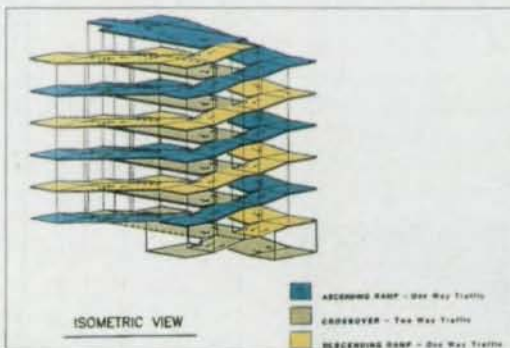

The double-helix design is best illustrated by an isometric view.



These castellated beams weigh between 60 and 70 lbs/ft.

chemicals into it."

Further durability is provided by using a two-way post-tensioning system. If hair-line cracks should occur, they are then kept tightly closed by the compressive stresses of the post-tensioned tendons. Post-tensioning also reduces the required slab thickness to 5" at 18' spans. After the concrete slab has cured, a penetrating sealer is applied, producing a moisture repelling surface that hardens to resist abrasion.

The steel also is coated and the paint has a life expectancy of at least 15 years. This long life is accomplished first by shot-blast cleaning the steel and applying 2.5 dry mils of zinc-rich epoxy in the shop, then 3 to 5 dry mils of epoxy polyimide in the field for the finish coat. The coating is provided by Tnemec. □

European Approach

Europe shares many of the same parking problems as the U.S. and a look at their solutions can help American designers

By Gerry Stoll, C.E.; George Keipes, C.E.;
and Frank van Rest, C.E.

Although there is a considerable interest in alternate transportation solutions, the automobile is still the most popular way to get around Europe. In fact, traffic density is increasing in most European cities—along with a concurrent need for additional parking facilities.

Unfortunately, the construction of parking facilities is not an easy task since free areas are scarce and the older cities usually are not laid out to best accommodate modern day traffic. As a result of this scarcity of space, the construction of multi-story and underground parking structures is on the rise.

Especially in the United Kingdom, West Germany and Switzerland, steel has been used extensively for this type of construction. Not only has it proven to be advantageous from a technical and cost point of view, but it also has a long lifespan. Parking structures share many similarities with both public and private development. The three main criteria in planning a parking structure are:

- Optimization of the rate of usage through the creation of a pleasant environment for the customer;
- Commercial viability throughout the lifespan of the building from the

developer's point of view;

- Fitting the project into the town or municipality planning scheme.

These requirements can be easily met with a steel structure. In addition, steel provides flexibility for design changes during construction and future expansion.

Design

The basic dimensions for parking bays are shown in table 1 for various parking angles. When the parking bays are slanted at 45°, the width of the building can be reduced to approximately 46'. This will create unusable space, however, so perpendicular parking is preferred (figure 2).

German Standards prescribe a live load of 73 p.s.f. France and the United Kingdom require 52 p.s.f., which seems more reasonable. Approach lanes and ramps have to be designed for a load of 104 p.s.f. and its supporting structure to 73 p.s.f.

The ramp layout depends on the duration of the usage (short-term, long-term or permanent decking) and the timing of usage (peak periods or continuous flow). Ramps can be internal or external, straight or curved. Spiral ramps are faster than straight ones. The up-circuit leading into the car park should lead past the parking bays. The down-circuit leading to the exit should be as short as possible.

The ramp slope should be less than 15%. When it is limited to 12% no transitional slope or curved section is necessary to keep the required clear headroom.

Ramp lengths can be shortened by further decreasing the construction height and the clear headroom. A further possibility of decreasing the ramp length is offered by the split level construction type, whereby bordering parking areas are displaced by half a story (figure 3).

Steel Framework

The steel framework in European parking structures is usually a very simple beam and column design using rolled sections. Spandrels should be avoided, mean-

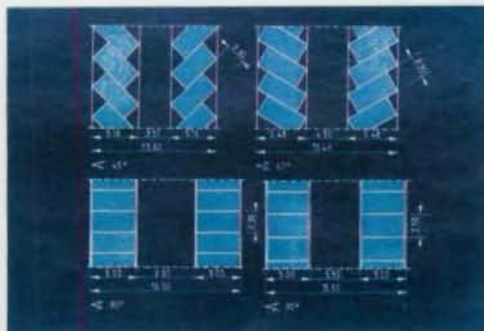

Table 1.

	Parking angle	Bay width parallel to aisle	Building width	Required bay space	
	°	m	m	m ²	%
a	45°	3.253	13.620	22.48	118
b	60°	2.656	15.460	20.53	108
c	90°	2.500	15.500	19.38	102
d	90°	2.300	16.500	18.96	100

Figure 2.

PARKING STRUCTURES

ing the column spacing should correspond to the spacing between floor beams. Often a column spacing of one parking bay is chosen since it presents the advantage of optically separating parking bays.

The floor beams are usually designed for a clear span of 46' to 52', allowing for easy maneuverability in the aisles and a column-free parking area.

The design of the floor beams depends on the floor type used.

- With conventional reusable formwork the spacing between beams—not to exceed 16' for economic reasons—can be chosen according to floor strength. Composite action, ensured by welding shear studs on top of the girders, results in a 20% reduction of either steel consumption or construction height.
- Corrugated steel sheets or precast concrete planks present the advantage of not having to use formwork supports plus a shorter construction time. Normally they are used for beam spacings up to 8'.
- An even shorter construction time can be obtained by using precast concrete slabs. They are erected at the job site with the same crane used for the structural steel erection. This system can be designed either as composite construction or as conventional structural steelwork.

In order to save material and keep the size of the steel sections down to a minimum, many designers are specifying at least Fe 355 steel (comparable to ASTM A572-Grade 50). Further savings can be obtained by using high-strength steel such as FeE 460 (Grade 65).

Corrosion Protection

Corrosion protection in Europe consists basically of shot-blasting the steel surface and applying several coats of paint, the last coat being site-applied. The modern anticorrosive treatments will guarantee protection for 10 to 20 years, depending on location. After this period, only the top coat needs to be retouched—which provides the an opportunity for giving the structure a new look.

Corrosion protection is sometimes further improved by hot dip galvanizing or spray galvanizing the steel and applying one coat of paint on the jobsite.

Fire Protection

Open parking structures in which the

facade openings constitute at least 1/3 of the external wall area per floor and are distributed in such a way that a constant transverse ventilation is guaranteed do not need any fire protection in most parts of Europe. For underground and enclosed parking structures, fire protection is required, usually to 90 minutes.

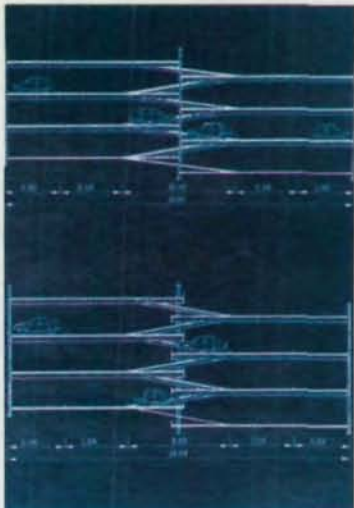

Figure 3.

The Bottom Line

The construction cost of steel parking structures in Europe varies from \$3,500 to \$8,000 per car space with an average of \$5,500, depending on location and the choice of finishing material.

Steel is a popular material for parking structures because it creates an easily accessible building with a light, transparent environment that fosters a feeling of safety. A filigree-type steelwork with a column-free parking area and wide aisles meets this need very well.



Also, steel structures offer a good return on investment for developers due to a shorter construction period. In an urban area with a poorly accessible building site and no space to store building materials or install a heavy crane, it's a clear advantage to build with steel.

Gerry Stoll and George Keipes are civil engineers with ARBED S.A. in Luxembourg. Frank van Rest is a civil engineer with TradeARBED, Inc., New York. For a free parking structure brochure, write or phone:

TradeARBED, Inc., 825 Third Ave., New York, NY 10022 (212) 486-9890. □

Stuttgart Airport (FRG)



Precast concrete slabs in composite actions

Australian Challenge

New rules are allowing open-deck parking structures to be built without passive fire protection beneath office buildings

A new 16-story office building in Melbourne, Australia, has broken new ground by using steel without passive fire protection in an open-deck parking structure on the lower levels.

Permission for the innovative construction resulted from a series of tests carried out by BHP Melbourne Research Laboratories. The tests showed that fires in open-deck parking structures do not result in temperatures in the steelwork that are high enough to cause structural problems. According to BHP Steel, "It is the fire load in the compartment under consideration that is critical, not in the floors above."

Steel was chosen for the 98,000-sq.-ft. building for its flexibility, competitive cost, and speed of construction. To further increase the speed of construction and minimize disruptions on the site, the beams for the office floors were fire sprayed off-site.

This was only the second time that fire spraying has been done off-site in Australia. BHP Melbourne Research Laboratories have conducted a number of tests that showed there is no difference in adhesion of fire spray materials between the samples transported and the control samples that were not transported. □

STRUCTURAL ANALYSIS SOFTWARE

Fast, accurate, inexpensive and easy-to-use software for the analysis of 2D or 3D frames and trusses. Runs on IBM Personal Computers and Compatibles.

BEAMS AND FRAMES

An interactive computer program that quickly performs structural analysis of continuous beams and 2D multi-bay/multi-story frame structures.

- Mechanical and thermal loads.
- Fast modify and reanalysis.
- Monitor and printer output.

Cost: \$99.00

FRAME 3D

A general purpose structural program for analysis of 2D or 3D frames, trusses, floor systems, towers, etc.

- 2000 nodes, 2000 elements max.
- 50 load cases, 10 combinations.
- Plots model/displaced shape

Cost: \$99.00

The comprehensive user's manual for each program contains theoretical background, descriptions of input and output, and numerous example problems.

For more information, call or write
Compu-Tec Engineering
300 Chesterfield Center, Suite 205
Chesterfield, MO 63017
(314) 532-4062

RISA-2D

Rapid Interactive Structural Analysis

- Very Easy to Use
- Extensive Graphics
- Braced Frames
- Moment Frames
- Trusses
- Continuous Beams
- Shear Walls

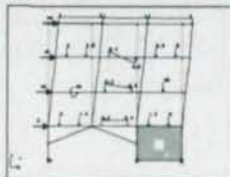

Here's what our users are saying:

"We looked at 20+ frame analysis programs and RISA-2D had the best combination of features, ease of use and price. RISA-2D isn't the only program we have, but it's the only one we use."

— Ed Triece
Jose I. Guerra, Inc.
Austin, Texas

"You have produced an excellent and very useful product. Our compliments to the chef!"

— Milton Alpern, P.E.
Alpern and Soifer Consulting Engineers
Bellmore, New York

"This is the '1-2-3' of engineering programs."

— Mark Jakerst
Forell/Eisesser Engineers, Inc.
San Francisco, California

For a Demo, call: 1 (800) 332-7472

17900 Sky Park Circle, Suite 106
Irvine, CA 92714



KOPE-ING

The company with the turnkey answer to your Steel Detailing Needs!

KOPE-ING and Mountain Software LTD have designed a complete system based on Sun platforms, Sun compatibles such as Solburne Computers, as well as 486 and 386 computers using Sun OS, SCO Xenix, and Arris software.

Steel-Pac features include:

- A wide variety of connection types
- Automatic determination and verification of all connectivity relationships
- All standard AISC and CISC materials are supplied
- Over 40 software switches to allow the user to tune the system to their needs
- Direct interface to NC equipment
- Hardware or Software can be purchased separately

For more information call or write:

KOPE-ING, 3970 Broadway,
Suite 201A, Boulder, CO 80302
Tel (303) 449-2251
Fax (303) 444-7656
An Authorized Arris Dealer

SIMPLE SHEAR CONNECTIONS

S337 Allowable Stress Design of Simple Shear Connections (AISC, 1990)
\$16.00

This booklet contains design aids for shear-connections using Allowable Stress Design. Aids not previously published include double-angle web-bolted connections, structural tee single shear connections and single-angle connections welded to the support. Design aids for other connections are reprinted from the 9th Edition ASD Manual. They include double-angle web-welded connections, single-angle connections bolted to the support, end plate shear connections, shear tabs, unstiffened and seated connections.

S388 Load and Resistance Factor Design of Simple Shear Connections (AISC, 1990)
\$16.00

Utilizing Load and Resistance Design, this booklet contains design aids for shear connections. Aids not previously published include double-angle web-bolted connections, structural tee single shear connections and single-angle connections welded to the support. Design aids for other connections are reprinted from the 1st Edition LRFD Manual. They include double-angle web-welded connections, single-angle connections bolted to the support, end plate shear connections, shear tabs, unstiffened and seated connections.

Order Form

Name _____

Company _____

Street/P.O. Box _____

City _____

State _____ Zip _____

Phone _____

AISC Membership No. _____

1. S337 (price x number ___) = \$ _____

2. S338 (price x number ___) = \$ _____

Subtotal = \$ _____

Sales Tax (NY-CA-IL Residents) = \$ _____

TOTAL AMOUNT ENCLOSED = \$ _____

UPS Service Available, Please Specify

Method of Payment: (Please enclose payment with order, no C.O.D. orders, American currency only)

Visa Mastercard Check or Money order

Card Number _____ Expiration Date _____

Signature X _____ Phone orders: AISC, 312/670-2400 x433

Mail to: AISC, P.O. Box 806276, Chicago, IL 60680-4124

(Please have credit card ready)

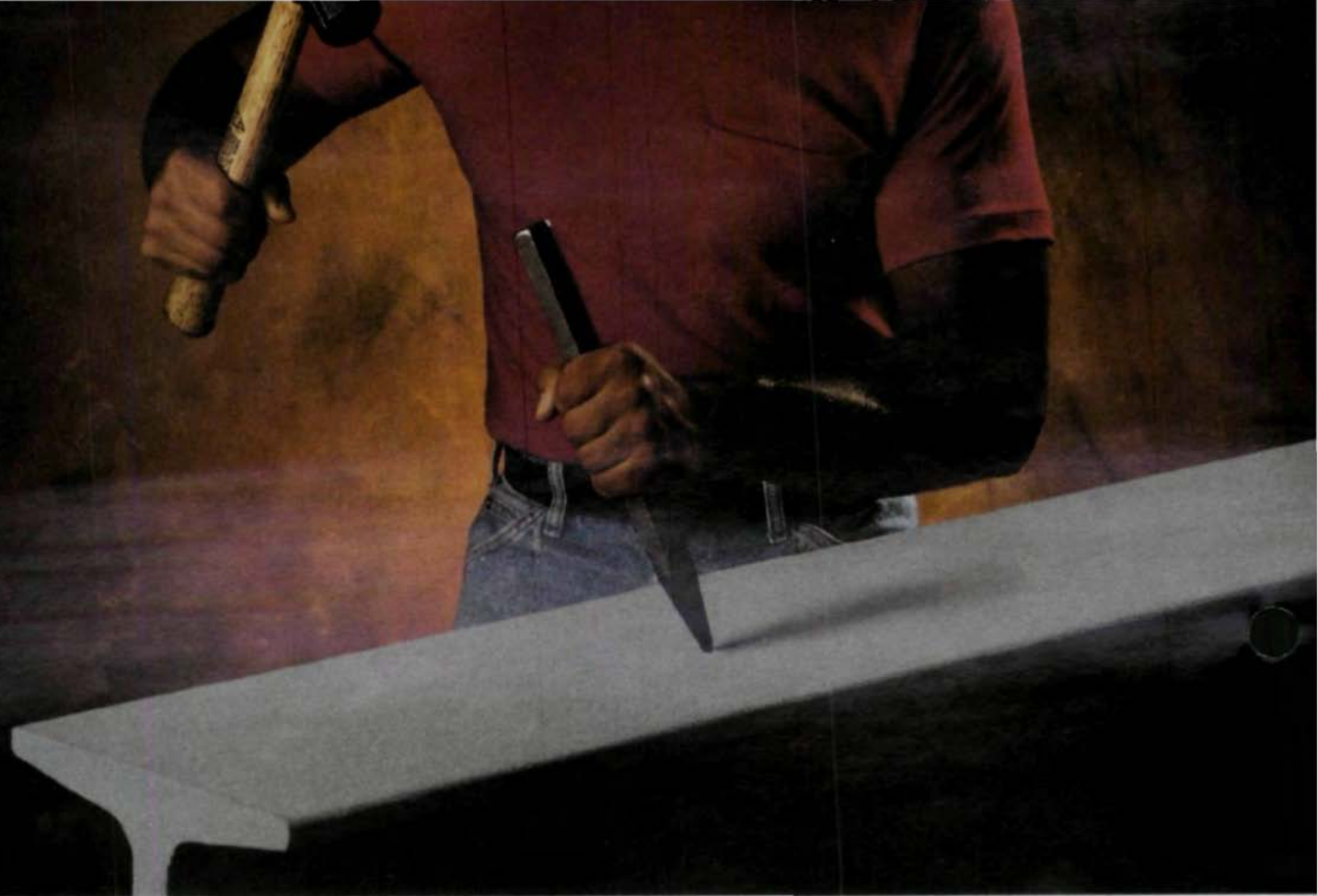

Try Our Hammer and Chisel Test... It Makes the Pencil Test Obsolete

Because in 30 minutes, IC 531 high-ratio zinc silicate is rock hard and stuck for good. It's chemically bonded to over 1000 lbs. psi pull strength. IC 531 rapidly becomes a permanent barrier that protects from salt, acid rain and UV for decades. And, because it bonds to itself, can be



repaired or maintained indefinitely.

So forget pencils. They're no match for IC 531... this zinc is tough.



**Inorganic
Coatings, Inc.**

500 Lapp Road · Malvern, Pennsylvania 19355
215/640-2880 · 800/345-0531 (USA) · 800/522-0531 (PA)

High Performance Coatings For Steel

The best paint system is the one that gives the highest return on invested dollars upon exposure

By Simon Boocock, Ph.D.

Because of the wide variety of environmental conditions in which steel is erected, the choice of a correct coating system is essential. And as with choosing a set of clothes to wear, it is important not just to consider the topcoat, but also a fully compatible system including primer, intermediate coat and topcoat.

The primer provides corrosion protection to the metal and promotes adhesion of subsequent coats and provides primary adhesion to the steel surface. The intermediate coat is composed of a resin system that must be fully compatible with the primer, and which provides additional chemical or physical protection of the steel. And finally, the topcoat provides overall durability, an attractive finish, and additional protection. In addition, it also is crucial that the correct surface preparation is specified.

The Steel Structures Painting Council, a non-profit research organization sponsored by several major industry associations, defines various environmental zones and uses an alphanumeric identifier to classify each zone type. Generally, the higher the letter or number, the more severe the environment. Table 1 describes each environmental zone and the generic coating type and paint specification number associated with it.

Correct surface preparation is often referred to as the cornerstone of a correctly applied coating sys-

tem. Specifications are available in the SSPC Painting Manuals that describe all the commonly employed types of surface preparation. These documents also describe the varying degrees of cleanliness that can be achieved. Cleanliness ranges from a minimum level achievable using hand or power tools (SSPC-SP2 "Hand Tool Cleaning") in which only loose millscale, paint or rust is removed, to the highest grade of abrasive blast cleaning (SSPC-SP5 "White Metal Blast Cleaning"). Also available is a visual standard: *SSPC Visual Standard No. 1*.

Choosing A Paint System

Coating systems are usually chosen to provide the highest return on invested dollars. As the severity of the environment increases, so must the sturdiness of

The best paint system is the one that is most economical in terms of cost per year of coating life

the paint system. Care must be taken, however, not to over-specify. In addition to the higher base cost of the sturdier paints, they often require more extensive surface preparation, which further raises the cost.

Fortunately, Gordon Brevoort and Al Roebuck regularly publish convenient guidelines to determine the life expectancy of a wide variety of coating systems. For more information on these guidelines, write: Materials Performance, c/o National Association of Corrosion Engineers, P.O. Box 218340, Houston, TX 77218.

These guidelines can be used to help gauge the economic effectiveness of various coating systems. The bottom line is that the best coating system is not always the costliest to apply; rather, it will be the one that is most economical in terms of cost per year of coating life. A "Cadillac" system such as inorganic zinc with epoxy intermediate and Urethane finish coats may not be justified when a less expensive system may provide a higher return on invested capital or maintenance dollars.

Changes in coating technology also will effect paint choice. Note, though, that the specifications given in Table 1 do not always represent the state-of-the-art in coatings. Some contain lead or other potentially hazardous pigments, and others have high volatile organic contents (VOCs) and therefore may not be universally acceptable for use. For example, in locations with Air Quality Management Districts, coatings such as PS4 Vinyl with high VOC may not be usable at all.

Material Choices

- Oil/Alkyd:
These materials are character-

A project designed for the future deserves a coating with a future: Tnemec.

A great idea is worth protecting, whether it's a new structure or an older building that's being renovated.

Our high-performance coatings for specialized architecture are the best protection you can specify. Their long service eliminates frequent repainting and lowers life-cycle cost.

And they're beautiful. Give your building a bright future. Give it Tnemec. Call us today.

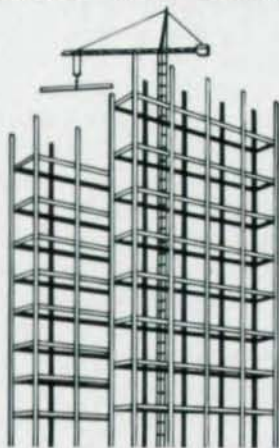

Call your nearest Tnemec representative or us direct at:

Tnemec Company, Inc.
Post Office Box 411749
Kansas City, MO 64141-1749
TEL: 816/483-3400
FAX: 816/483-1251

ized by ease of use and can be applied with a variety of tools, including brush, roller or spray equipment. They do not require the surface to be prepared by abrasive blast cleaning, so cleaning costs are reduced—though applying over blast-cleaned surfaces may double the system life. Oil/Alkyd systems are widely specified as shop primers for structural steel particularly when the intended service is mild. They have reasonable atmospheric resistance, but poor resistance to immersion and chemical attack. Heat resistance is average, about 250 degrees F.

- Latex:

These coating materials are not the same as the house paints that can be purchased at a local store. They have comparable service characteristics and surface requirements as Oil/Alkyd paints. Again, application over a blast-cleaned surface can considerably increase service life.

- Epoxy:

These coating materials are less forgiving of surface defects than Oil/Alkyd or Latex paints. Epoxies vary greatly in their resistance to specific chemicals, but in general they have good alkali resistance, and can perform well in contact with halogens and gasoline. Also, they generally are recommended for immersion in water only when applied to a scrupulously clean surface such as that produced by SSPC-SP10 "Near White Metal Blast Cleaning." Heat resistance is average, about 250 degrees F, though modified epoxies, commonly termed epoxy phenolic, can achieve a higher dry heat resistance of 400 to 450 degrees F.

- Vinyl:

The minimum level of cleaning suggested for these materials is SSPC-SP6 "Commercial Blast Cleaning." Coating lifetime is increased when applied over an SP10 blasted surface and this is the minimum required for immersion in water. Vinyl cannot be placed in contact with many organic solvents as this causes them to dissolve or soften. Resistance to dry heat is

poor, about 160 degrees F. Similar characteristics are shared by Chlorinated Rubber coatings. The use of both of these coatings for new construction has diminished greatly because they are high VOC materials.

- Zinc-Rich Coating Systems:

These are often specified in conjunction with the use of epoxy intermediate and either epoxy or urethane topcoats. The systems are costly, but their long life spans can defray the expense. Surface preparation is crucial, and a minimum of an SSPC-SP6 is required, though an SSPC-SP10 is recommended. The function of the added topcoats is to make the steel more attractive and prolong the usefulness of the sacrificial zinc pigment. Resistance to chemical attack and heat will be a function of the topcoat employed, with an epoxy topcoat system resisting up to 300 degrees F. Zinc-rich coatings are frequently specified for use in exterior exposure. Inorganic Zinc primers have excellent handling characteristics as one-coat shop systems, which reduces the need for touch-up in the field. Low VOC versions have recently been introduced. While most of the Inorganic Zinc primers are based on Ethyl Silicate, there are a range of newer water-based Inorganic Zinc primers. These primers have very rapid drying and recoat times and are ideally suited for shop application.

Advancements In Coating Technology

New coating technology typically falls into three distinct categories: Water-Borne; High Solids; and Surface Tolerant.

New water-borne coatings encompass all of the generic types discussed above. However, while a water-borne solvent has the same attributes of its generic solvent forbear, many have little in the way of track records.

- Water-Borne Coatings

The latex coatings described above are water borne. They are the most widely accepted water-borne coatings to date.

Water-borne alkyds did not per-

TABLE 1:

ENVIRONMENTAL ZONES	ZONE CONDITIONS	PAINTING SYSTEM SUGGESTIONS
0	Dry interiors where structural steel is imbedded in concrete, encased in masonry, or protected by a membrane or non-corrosive contact-type fireproofing	Leave unpainted
1A	Interior, normally dry (or temporary protection); very mild (oil-based paints now last 10 years or more)	Leave unpainted or PS18 Latex or PS7 One-Coat if needed
1B	Exteriors, normally dry (includes most areas where oil-based paints now last six years or more)	PS1 Oil Base or PS18 Latex
2A	Frequently wet by fresh water; involves condensation, splash, spray or frequent immersion (oil-based paints now last five years or less)	PS4 Vinyl, PS11 Coal Tar Epoxy, or PS13 Epoxy
2B	Frequently wet by salt water; involves condensation, splash, spray or frequent immersion (oil-based paints now last three years or less)	PS12 Zinc-Rich, PS4 Vinyl, PS11 Coal Tar Epoxy, or PS13 Epoxy
2C	Fresh water immersion	PS4 Vinyl or PS11 Coal Tar Epoxy
2D	Salt water immersion	PS4 Vinyl or PS11 Coal Tar Epoxy
3A	Chemical exposure—acidic (pH 2.0 to 5.0)	PS4 Vinyl, PS11 Coal Tar Epoxy or PS15 Chlorinated Rubber
3B	Chemical exposure—neutral (pH 5.0 to 10.0)	PS12 Zinc-Rich, PS15 Chlorinated Rubber or PS4 Vinyl
3C	Chemical exposure—alkaline (pH 10.0 to 12.0)	PS11 Coal Tar Epoxy or PS15 Chlorinated Rubber
3D	Chemical exposure, presence of mild solvents; intermittent contact with aliphatic hydrocarbons (mineral spirits, lower alcohols, glycols, etc.)	PS13 Epoxy
3E	Chemical exposure—severe; includes oxidizing chemicals, extreme pHs, or combinations of these with high temperatures	Use Specific Exposure Data

JUST PUBLISHED!

LRFD

DESIGN MANUAL

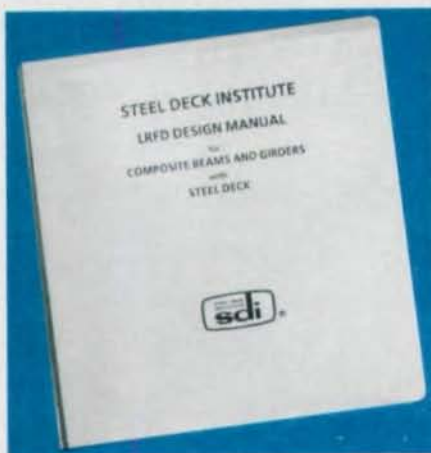

Design for the 21st Century in the 1990's

- Composite Design—Steel Beams with Steel Deck
- Example Problems
- Quick Selection Charts
- Look-Up Charts

LRFD Design Simplified

Every Design Professional
Should Have a Copy!
Be Competitive.

ORDER YOURS TODAY!

Send checks, postal, world money-
orders, drafts in U.S. Currency.

Quantity @ \$75.00 ea.

_____ All New LRFD Design Manual
for Composite Beams and
Girders With Steel Deck

US Currency Total _____

Out of USA Surcharge 15% _____

Add on Airmail _____

TOTAL ENCLOSED _____

STEEL DECK INSTITUTE

P.O. Box 9506 • Canton, Ohio 44711 • (216) 493-7886

form as well as their solvent-based counterparts in testing beginning in 1979 sponsored by FHWA and other major user agencies. However, the formulations tested were from the mid- to late-1970s and since that time manufacturer's and resin suppliers have spent time and money to enhance the material's performance. Even so, only time will tell if water-borne alkyds will approach the long-term performance expected of high VOC alkyds.

Water-borne epoxies also did not perform as well in tests as their solvent-based counterparts. Again, however, great strides have been made by manufacturers in improving formulations.

Water-borne vinyls are actually a halogenated vinylidene terpolymer latex. These coatings have been given considerable publicity by the paint industry and have performed well in accelerated testing of salt fog exposure. Muting this finding, however, is that salt fog exposure testing does not adequately represent the anticipated performance of a coating system under actual outdoor exposure.

In testing, some water-borne acrylics performed close to or equal to traditional oil/alkyd systems in testing.

Water-borne inorganic zinc-rich coatings have similar performance characteristics of solvent-based systems.

• High Solids Coatings

Except for vinyl and chlorinated rubber, all of the solvent-borne coating systems previously referred to are now available as high solids, low VOC materials corresponding to their low solids, high VOC brethren. SSPC's experience has been that performance is critically dependent on the individual formulation, which is one reason why SSPC is promoting the future issuance of performance specifications. Nonetheless, when well formulated, the low-VOC equivalents perform close to or equal to the level of performance found in a traditional system.

• Surface Tolerant Coatings

This category has become some-

thing of a buzzword in the protective coatings community during the past decade. Surface tolerant coatings are usually low-VOC coatings and epoxy based. The common characteristic of these materials is that they can be applied over minimally prepared surfaces. The combination of low VOC and "surface tolerance" makes them doubly attractive.

Unfortunately, the potentially vast savings obtainable from lower surface preparation resulted in misuse of this coating category. As a result, there were coating failures and consumer disillusionment. But despite their checkered past, surface tolerant coatings remain a good choice in some applications.

The most common generic type, Epoxy Mastics, vary considerably from company to company, so it is important to ensure the pedigree of the material specified. As a class, epoxy mastics exhibit greatly reduced immersion resistance compared to epoxy coatings.

Moisture Cured Urethane is totally unlike any other organic paint vehicle described above because it requires moisture to cure. The supposition of the manufacturer is that as tightly adherent rust always contains some water of hydration, this helps ensure the adhesion of the paint to the metal/rust surface. Moisture cured urethanes have long track records of successful use.

The vast majority of Rust Converters/Inhibitors are based upon tannic acid dispersions that react with the rust to form a blue-black iron oxide complex. This is touted as being a suitable substrate for painting. In reality, the organic acid does not generally penetrate layered rust sufficiently well to permit complete reaction. Therefore, some surface preparation is often required. SSPC's best experience with these materials involves instances when it is applied over steel from which all loose rust has been removed and compatible topcoats have been applied.

Simon Boocock is the director of research with SSPC, 4400 Fifth Ave., Pittsburgh, PA 15213-2683 (412) 268-3326. □

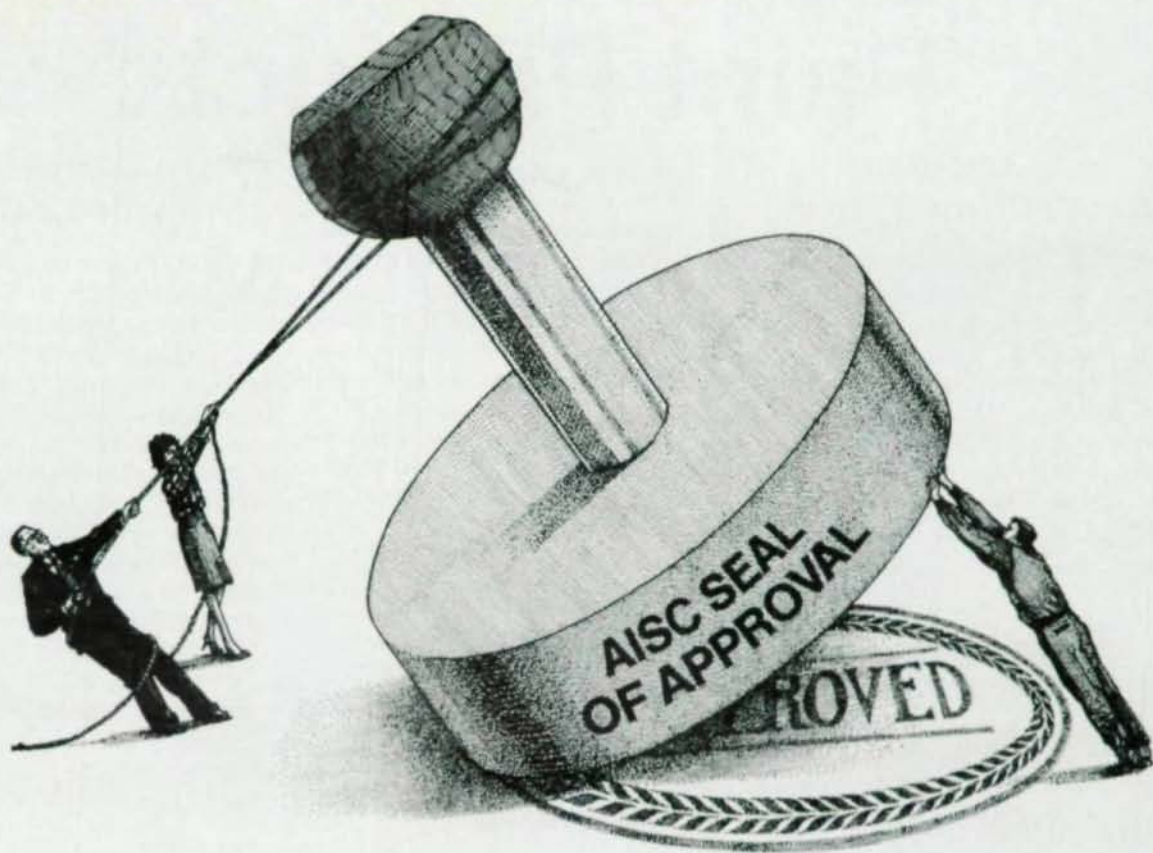

AISC has given its seal of approval to only one business insurance program.

The American Institute of Steel Construction has given its seal of approval to the business insurance program from the CNA Insurance Companies. The reason is our proven ability to respond to the specialized insurance needs you have because of the specialized nature of the work you do.

This business insurance program provides a comprehensive package that can meet virtually all your business insurance needs, including commercial property, commercial liability, commercial auto, workers' compensation and commercial umbrella. The program also offers you the oppor-

tunity to be eligible for a safety group dividend* based on the efficient control of losses.

With the program's comprehensive approach to coverage — plus specialized loss control services and responsive claims handling — you can be assured of receiving the best value an association-endorsed program can offer. You can be confident about the stability of your program, too. It's backed by the experience and financial strength of one of the nation's largest and most respected insurance organizations.

For more information, call 1-800-CNA-6241.

*Safety group dividends, available in most states, are declared by CNA's Board of Directors and cannot be guaranteed.



CNA

For All the Commitments You Make®

The CNA Insurance Companies underwriting CAM programs will vary according to the coverage. These companies include: Transportation Insurance Company, Valley Forge Insurance Company, Continental Casualty Company, National Fire Insurance Company of Hartford, American Casualty Company of Reading, Pennsylvania or Transcontinental Insurance Company, CNA Plaza, Chicago, IL 60685.

Paint Products



MEMBER

Zinc-Rich Urethane Primer

Tnemec Company, Inc., has introduced Series 90-97 Tneme-Zinc, a zinc-rich aromatic urethane primer used primarily for protecting steel. Because this moisture-cured polyurethane primer is electrically conductive, it offers better galvanic protection than previously available organic coatings. The coating contains 83%

metallic zinc dust by weight, and meets the requirements of SSPC-PS 12. Tneme-Zinc cross-links in the presence of moisture—even at very low temperatures—to form a hard, durable barrier that can be rapidly recoated with a wide range of high-performance, chemically-resistant coatings.

For more information, contact: Tnemec Company, Inc., 6800 Corporate Dr., Kansas City, MO 64120-1372 (816) 483-3400.

Polyamine-Epoxy Mastic Coating

M.A. Bruder & Sons has introduced M.A.B. Ply-Mastic, a two-part, corrosion resistant, polyamine-epoxy mastic coating. It forms a tenacious bond to blast cleaned or firm rusted steel where abrasive blasting is restricted or impractical. The high solids formulation (90% by volume) is VOC compliant and meets environmental regulations. Easy application at 5 mils D.F.T. or more makes it suitable as a one-coat maintenance finish or as a primer/intermediate coat beneath high performance topcoats. Ply-Mastic is available in a variety of colors. Activators allow application at temperatures from 30 to 90 degrees F.

For more information, contact: Technical Department, M.A. Bruder & Sons, Inc., 600 Reed Road, P.O. Box 600, Broomall, PA 19008 (215) 353-5100.

We've got the handle on power!

Grab on to one of W.A. Whitney's profitable presses that go to the job!

Punch where it counts, on the job site, with W.A. Whitney's complete line of flange and web portable presses. Capabilities of these portable presses include:

- 20-250 tons punching capacity.
- Full stroke hydraulic punching.
- Positive workpiece stripping.
- Easy tool change and operation.
- Cycle time and operating mode options.
- Rugged construction assures years of dependability.

Write or call for a free Portable Press catalog, and get the power to the job with a W.A. Whitney portable hydraulic press.



650 Race Street
Rockford, IL 61105
Phone: 815/964-6771



W.A. WHITNEY

AN ESTERLINE COMPANY

High-Ratio Zinc Silicate

Inorganic Coatings, Inc., has introduced IC 531, a high-ratio zinc silicate for the protection of structural steel. This NASA-developed formula is based on water-based zinc silicate technology introduced in the 1940s. While these early low-ratio formulas offered unparalleled corrosion protection—many applications are still in place today and in excellent condition—they required post-cures or long self-cures and application was often difficult. The new high-ratio formula provides the same permanent corrosion protection, but without the curing and application problems. When IC 531 is dry, it is cured. It is insoluble, has exceptional hardness, and can exceed 1,000 p.s.i. pull testing. Whether topcoating or shipping it as a single-coat system, it provides previously-unheard-of production. In addition, the coating is water-based, has zero VOCs, cleans up

IMPROVE YOUR SHOP CLEANING AND PAINTING OPERATIONS

Attend



SIGHTS, SOUNDS AND VISIONS OF THE FUTURE

STEEL STRUCTURES PAINTING COUNCIL
1990 National Conference and Exhibition

Opryland Hotel ■ Nashville, Tennessee ■ December 2-7, 1990

SOME OF THE 44 PAPERS YOU CAN HEAR

- Cold weather application in the fabricating shop
- Coating inspection in the fabricating shop
- Dealing with multi-coat paint systems in the shop
- Water-based inorganic zincs
- Advances in surface preparation
- VOC-compliant coatings for bridges
- Testing slip-coefficient of coatings
- Requirements for handling and disposal of hazardous wastes

SOME OF THE 13 CLASSES YOU CAN ATTEND

- Inspection instruments workshop
- Specifications for new construction
- Paint failure analysis
- Surface preparation methods and standards
- Properties and performance of low-VOC coatings
- Lead paint removal
- Quality control and safety
- Resolution of coating failures

OTHER FEATURES OF THE CONFERENCE

- 200 booth exhibit of equipment and materials
- Outdoor equipment demonstrations
- National painters' competition
- Receptions
- Banquet
- Spouse and family program

Free exhibit passes are available from SSPC on request to fabricators, contractors, and qualified end users.

Steel Structures Painting Council ■ 4400 Fifth Avenue ■ Pittsburgh, PA 15213-2683
Main Office: 412-268-3326 ■ Meetings and Exhibits: 412-268-2980 ■ FAX: 412-268-7048

PAINT PRODUCTS

with water, and does not generate toxic chemical waste.

For more information, contact: Inorganic Coatings, Inc., 500 Lapp Road, Malvern, PA 19355 (215) 640-2880.

Water-Borne Primer/Topcoat

Carboline's D3358 (primer) and D3359 (topcoat) is a high-performance, chemically-resistant, water-borne acrylic system, applied at 7-9 mils D.F.T. in two or three coats. Great for areas where a water-based, low VOC system and high chemical resistance is required. The system may be used over power tool cleaned steel, and it is easily applied by brush, roller or spray. A fast recoat time of two hours at 75 degrees F. reduces intercoat contaminants. D3359 can be applied over a variety of primers, including inorganic zincs, alkyds, epoxies, vinyls and urethanes. The water-borne system provides the high-performance characteristics usually associated with solvent-based systems.

For more information, contact Carboline Co., 350 Hanley Industrial Court, St. Louis, MO 63144 (314) 644-1000, attn: Mitch Braun, ext. 2326.

Lead-Free Primer

Southern Coating's Enviro-Guard is a heavy duty primer free of lead and chromate hazards that offers superior protection for steel in normal environments where severe or extended exposure puts unusual demands on the shop-applied primer. Applications include steel bridges, skyscrapers, and marine exposures. In salt spray tests, panels painted with 2 mils D.F.T. withstood 500 hours exposure to 5% salt spray without any sign of film failure. It also showed no film failure after 500 hours of exposure in a water resistance test and a humidity cabinet test. Enviro-Guard meets Rule 66 and similar air pollution requirements.

For more information, contact:

Southern Coatings, Inc., P.O. Box 160, Sumter, SC 29151 (803) 775-6351.

Self-Priming Topcoat

Republic Powdered Metals' Alumanation 301 is an aluminum-pigmented, asphaltic self-priming topcoat designed to encapsulate rust and prevent corrosion on metal surfaces. It is primarily used for metal roofs, but can be used for structural steel. An economical, energy saving protective coating, its bright aluminum finish reflects 55 to 60% of the sun's ultra-violet rays.

For more information, contact: Nick Hecei, Dir. of Mktg., Republic Powdered Metals, Inc., 2628 Pearl Road, Medina, OH 44256 (216) 225-3192.

Sulfonate-Based Coating System

Environmental Systems Corp. has introduced Oxi-Block, a high-performance, sulfonate-based protective coating system that requires minimal surface preparation and is ideal for renovation projects. It utilizes a new generation of SACI rust-preventative concentrates from Witco Corp.'s Sonneborn Division. Applied by brush, Oxi-Block seals existing loose material. The coating has a viscosity and thickness similar to that of a one-coat alkyd enamel paint. Steelwork requires only a simple washing to remove loosely clinging dirt and other contaminants before application. This high-solids SACI concentrate is designed to cure and crosslink to permanent and flexible films that are durable, solvent-resistant and non-toxic. It effectively displaces water while forming strong bonds with metal, which makes the finished coating resistant to undercutting and blistering near damaged surface area.

For more information, contact: Paul Morrison, Sonneborn Division of Witco Corp., 520 Madison Ave., New York, NY 10022 (212) 605-3916 or Environmental Systems Corp., 248 Plaza Dr., Lexington, KY 40503 (606) 277-0014.

INERTIA

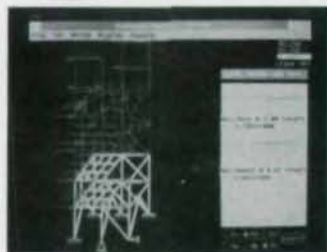

- Graphical Modeling
- Finite Element Analysis & Design
- Heat Transfer (Thermal)
- Kinematics & Dynamics (Mechanism)
- Structural Design (AISC)
- Spring Design (ASME)
- Available on all PCs and Macs

MCAE, Inc.

Tel 1-800/444-6223 • FAX 1-317/463-7166

IT IS FUN TO DESIGN STEEL CONNECTIONS

USING

DESCON

AN EASY TO USE SOFTWARE PACKAGE
FOR YOUR PC

25 TYPES OF BEAM TO COLUMN
CONNECTIONS, BEAM SPLICES AND
BEAM TO GIRDER CONNECTIONS

MOMENT CONNECTIONS
SHEAR CONNECTIONS
BOLTED AND WELDED

EXTENSIVE DATA BASE OF SHAPES,
MATERIAL PROPERTIES AND
SPECIFICATION REQUIREMENTS
INCLUDED

FOR INFORMATION CALL OR WRITE TO:

OMNITECH ASSOCIATES
P.O. BOX 7581
BERKELEY, CA 94707
415-658-8328

WOULD YOU RATHER DO THE STRUCTURAL DESIGN OF THIS BUILDING BEAM-BY-BEAM – OR FLOOR-BY-FLOOR?

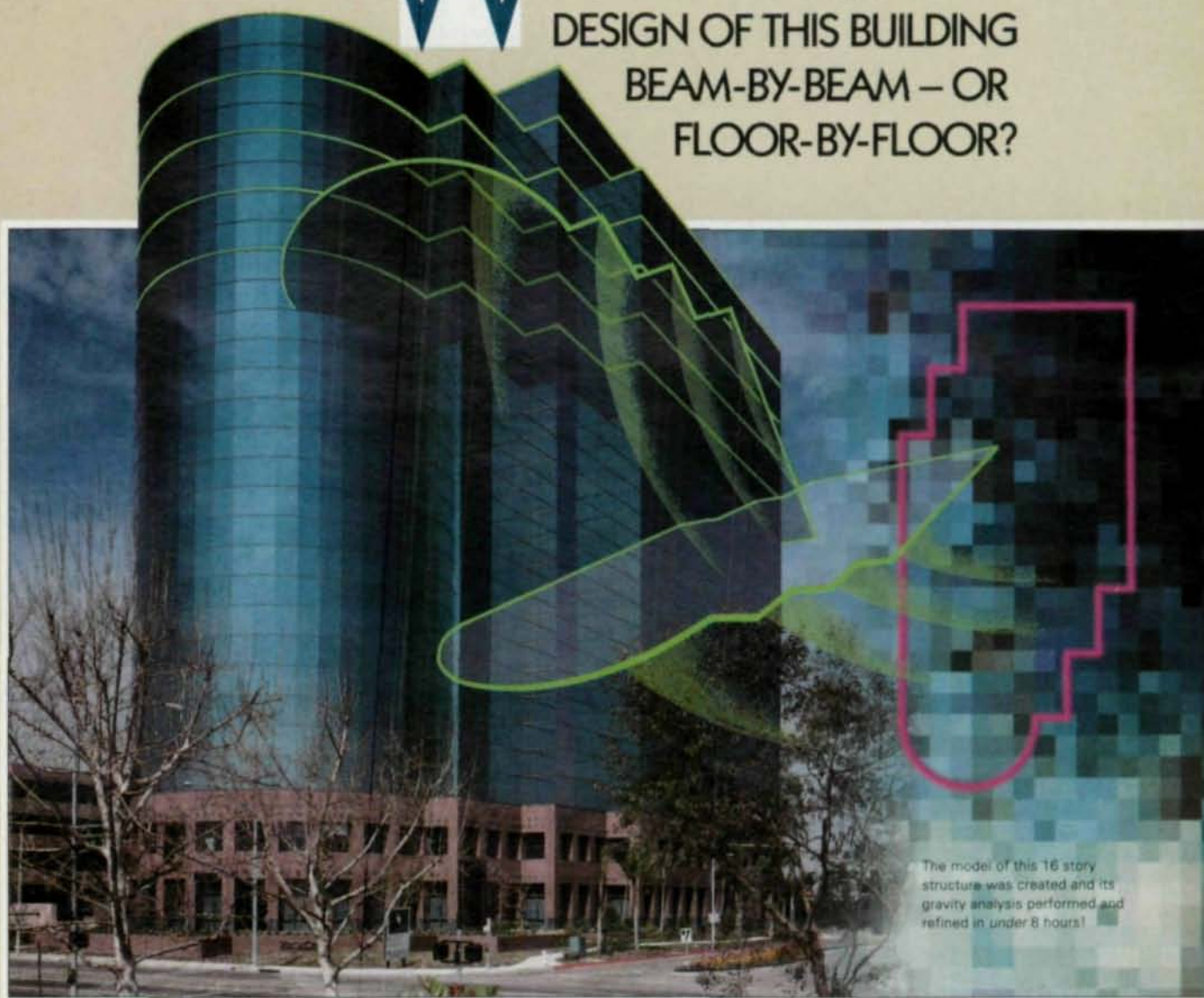

The model of this 16 story structure was created and its gravity analysis performed and refined in under 8 hours!

NOW!

With **RAMSTEEL's™** integrated floor-by-floor analysis, one engineer can design an entire building in one day.

Starting at the roof and working to the base, **RAMSTEEL** integrates the results of the analysis of each successive floor, automating nearly the entire design process.

RAMSTEEL:

- Runs on Your PC
- Has a Windows 3.0™ based Interactive Graphical Modeler
- Automatically distributes surface, line, and point loads to supporting members
- Calculates and applies live load reduction factors

- Optimizes beam (composite or non-composite) and column design per ASD or LRFD
- Calculates quantity take-offs by member type
- Permits interactive output editing
- Automatically incorporates applicable requirements of major building codes

For complete state-of-the-art analysis of all lateral elements **RAMSTEEL** automatically interfaces with **ETABS®** or supplies a tabularized printout of all gravity loads to members of the lateral frames. An automatic interface with your CAD software generates floor framing plans.

Now is the time to find out more about the power of **RAMSTEEL**.

1-800-726-7789
FAX: 916-895-3544



RAM Analysis
Integrated Structural
Software
55 Independence Circle
Suite 201
Chico, California 95926

All trademarks are the sole property of their respective companies.

Advertisers' Index

A

AISC Computer Software	41
AISC Connection Guides	55

B

BDS.....	20
Bouras, Nicholas J.....	Cover II

C

C.A.S.T.....	20
CNA Insurance	61
Canam Steel.....	23
Chaparral Steel.....	44
Cleveland Steel Tool.....	28
Compu-Tec.....	54
Computer Detailing	9
Computers & Structures.....	Cover IV

D

DCA Engineering Software	32
Design Data	22
Dogwood Technologies.....	49

E

Elite Equipment	11
Enercalc.....	15
Epic Metals	Cover III

F

Fujitsu America.....	12
----------------------	----

I

Inorganic Coatings	56
--------------------------	----

K

Kope-Ing	54
----------------	----

M

MCAE.....	64
-----------	----

N

Nucor Fasteners.....	7
----------------------	---

O

Omnitech	64
----------------	----

R

RAM	65
RISA Technologies	54
Research Council On Structural Connections	36

S

St. Louis Screw & Bolt Co.	33
Smith Emery.....	9
SteelCAD	5
Steel Deck Institute.....	60
Steel Solutions.....	10
Steel Structures Painting Council	63
Structural Analysis, Inc.	11
Structural Software	3

T

Tnemec.....	58
TradeARBED.....	7

U

User Friendly.....	10
--------------------	----

V

Vulcraft.....	32-33
---------------	-------

W

Waterloo Engineering Software/SODA.....	30
W.A. Whitney	62

For advertising information contact:

Eric K. Nieman
 Pattis/3M
 7161 North Cicero
 Lincolnwood, IL 60646
 (708) 679-1100
 FAX (708) 679-5926

EPIC LONG-SPAN DECKS



E750—SPANS TO 32 FT.
E600—SPANS TO 26 FT.
E450—SPANS TO 23 FT.
E300—SPANS TO 15 FT.

AVAILABLE FOR DELIVERY—NOW

Galvanized G60-G90
Lengths to 50 ft.

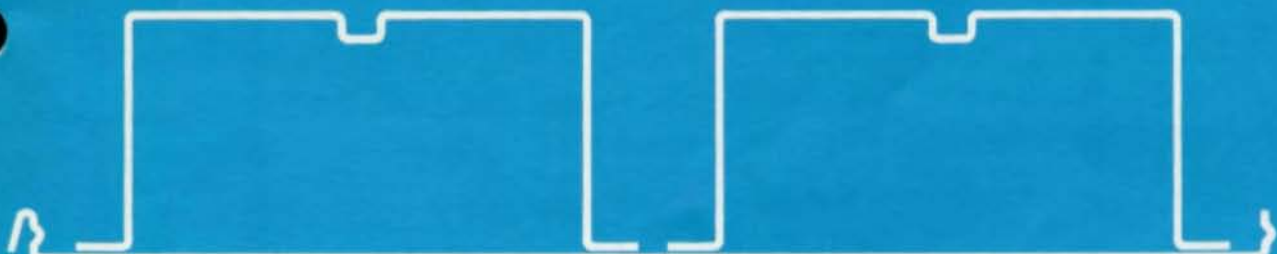

Plated Decks—Plain or perforated
Most complete line of deck products
in $\frac{5}{8}$ " to $7\frac{1}{2}$ " depths

OUR SERVICE WILL SAVE YOU TIME & MONEY

Epic has these profiles available for shipment on an A.S.A.P. Basis!

Your order will be processed in One Week in most cases. Ask about our A.S.A.P. Service.

Call (412) 351-3913 today for price and delivery information and for product advice on all types of Form Decks, Composite Decks, Long-Span and Roof Decks.

Manufacturing Plants:

- Pittsburgh, Pa.
- Chicago, Ill.
- Lakeland, Fla.

Dealer Inquiries Invited

EPIC[®]
METALS CORPORATION

Eleven Talbot Avenue, Rankin, PA 15104
PHONE: 412/351-3913
TWX: 710-664-4424
EPICMETAL BRDK

State of the Art

Personal Computer Software for Structural and Earthquake Engineering

Developed by Edward L. Wilson & Ashraf Habibullah



Building Analysis

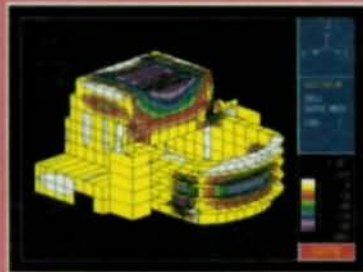

Dynamic Analysis

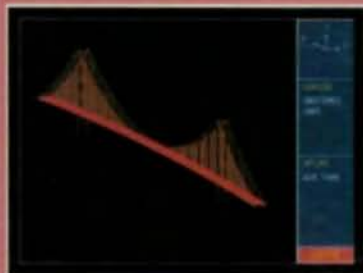

Bridge Analysis

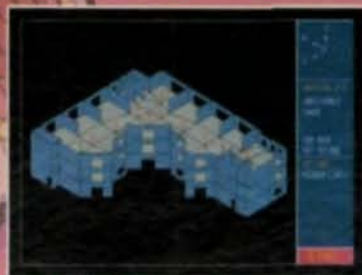

Shear Wall Design

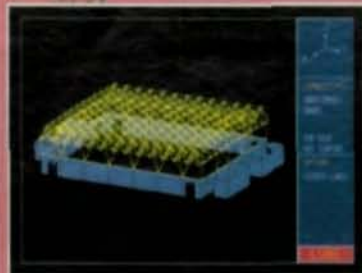

Space Frame Design

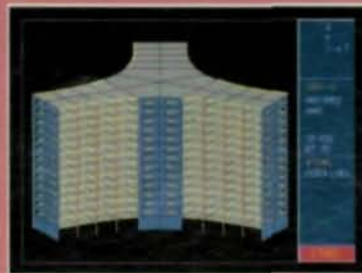

Shearwall/Frame Interaction

ETABS[®]
Building Analysis
& Design



Complex Slab Design

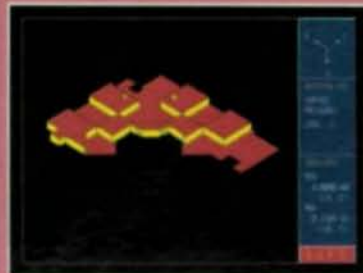

Pattern Loading



Slab Deflection Contours

SAFE[™]
Slab Analysis
& Design

CSI COMPUTERS & STRUCTURES INC.

For more information:
Computers & Structures, Inc.
1995 University Avenue
Berkeley, California 94704

TEL: (415) 845-2177

FAX: (415) 845-4096

TWX: 5101003830 CSI BERKELEY

CELEBRATING 20 YEARS OF INNOVATION •
SAP90[™]
1970-1990

SAP90[™]
General Analysis
& Design