

American Institute of Steel Construction, Inc.  
One East Wacker Drive, Suite 3100  
Chicago, IL 60601-2001 (312) 670-2400  
Address Correction Requested

A9.31-4-

BULK RATE  
U.S. POSTAGE  
PAID  
Permit No. 4  
Senatobia, MS 38668

# MODERN STEEL CONSTRUCTION

April 1991

\$3.00

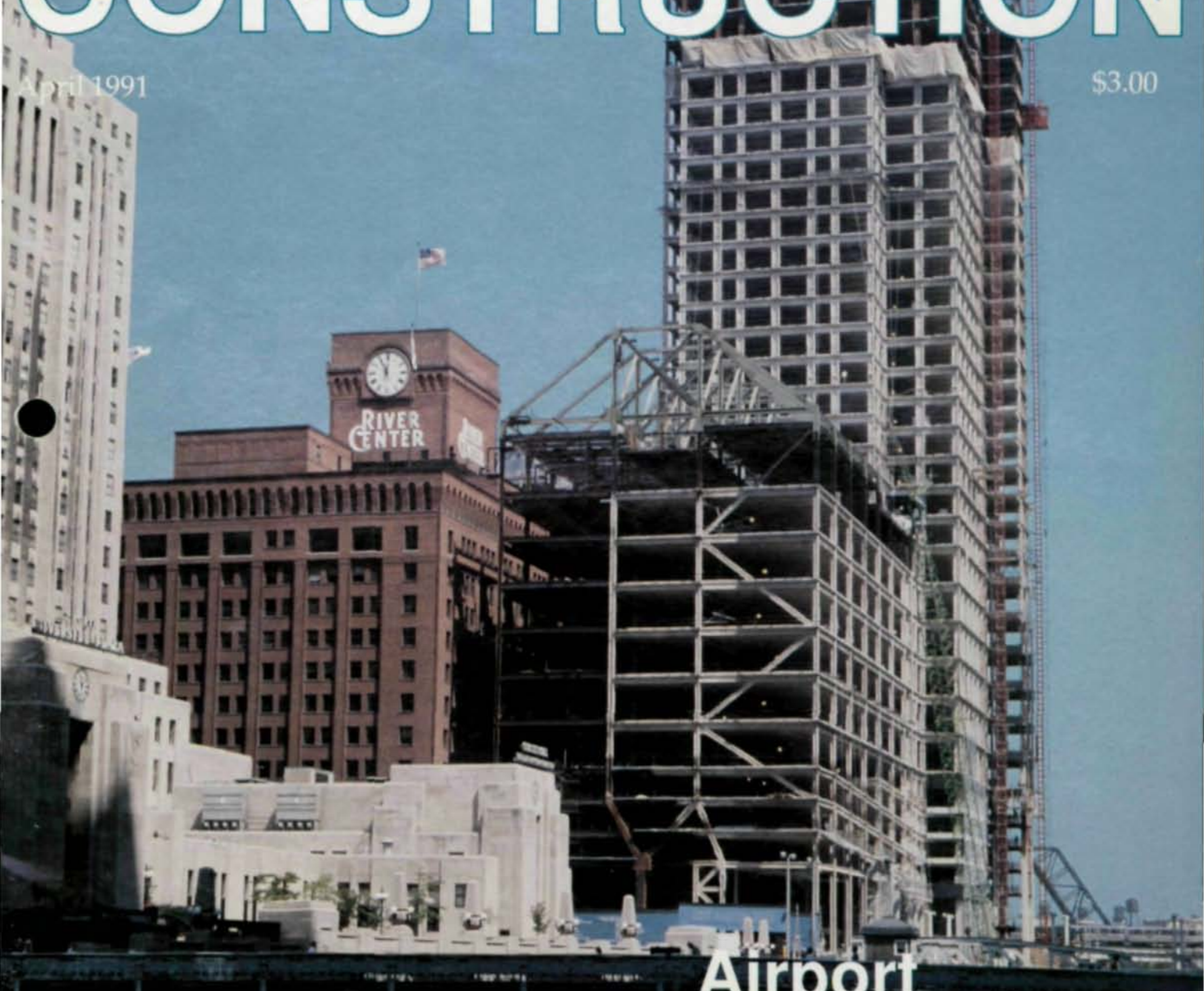

## Airport Construction

944030  
Pamela Brent  
Secretary  
American Inst. of Steel Constn.  
One East Wacker Drive #3100  
Chicago, IL 60601-2001



# POUR STOP SELECTION CHART

SLAB DEPTH (Inches)	OVERHANG (INCHES)												
	0	1	2	3	4	5	6	7	8	9	10	11	12
4.00	20	20	20	20	18	18	16	14	12	12	12	10	10
4.25	20	20	20	18	18	16	16	14	12	12	12	10	10
4.50	20	20	20	18	18	16	16	14	12	12	12	10	10
4.75	20	20	18	18	16	16	14	14	12	12	10	10	10
5.00	20	20	18	18	16	16	14	14	12	12	10	10	
5.25	20	18	18	16	16	14	14	12	12	12	10	10	
5.50	20	18	18	16	16	14	14	12	12	12	10	10	
5.75	20	18	16	16	14	14	12	12	12	12	10	10	
6.00	18	18	16	16	14	14	12	12	12	10	10	10	
6.25	18	18	16	14	14	12	12	12	12	10	10	10	
6.50	18	16	16	14	14	12	12	12	12	10	10	10	
6.75	18	16	14	14	14	12	12	12	10	10	10	10	
7.00	16	16	14	14	12	12	12	12	10	10	10	10	
7.25	16	16	14	14	12	12	12	10	10	10	10	10	
7.50	16	14	14	12	12	12	12	10	10	10	10	10	
7.75	16	14	14	12	12	12	10	10	10	10	10	10	
8.00	14	14	12	12	12	12	10	10	10	10	10	10	
8.25	14	14	12	12	12	10	10	10	10	10	10	10	
8.50	14	12	12	12	12	10	10	10	10	10	10	10	
8.75	14	12	12	12	12	10	10	10	10	10	10	10	
9.00	14	12	12	12	10	10	10	10	10	10	10	10	
9.25	12	12	12	12	10	10	10	10	10	10	10	10	
9.50	12	12	12	10	10	10	10	10	10	10	10	10	
9.75	12	12	12	10	10	10	10	10	10	10	10	10	
10.00	12	12	10	10	10	10	10	10	10	10	10	10	
10.25	12	12	10	10	10	10	10	10	10	10	10	10	
10.50	12	12	10	10	10	10	10	10	10	10	10	10	
10.75	12	10	10	10	10	10	10	10	10	10	10	10	
11.00	12	10	10	10	10	10	10	10	10	10	10	10	
11.25	12	10	10	10	10	10	10	10	10	10	10	10	
11.50	10	10	10	10	10	10	10	10	10	10	10	10	
11.75	10	10	10	10	10	10	10	10	10	10	10	10	
12.00	10	10	10	10	10	10	10	10	10	10	10	10	

TYPES	DESIGN THICKNESS
20	0.0358
18	0.0474
16	0.0598
14	0.0747
12	0.1046
10	0.1345

This chart is a repeat of our first DECK DESIGN DATA SHEET; the format has been revised to make the type (gage) selection easier.

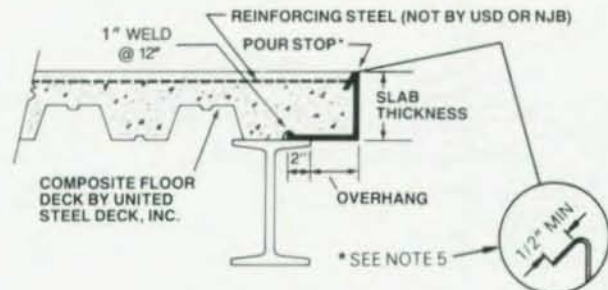

**NOTES:** THE ABOVE SELECTION TABLE IS BASED ON THE FOLLOWING CRITERIA:

1. NORMAL WEIGHT CONCRETE (150PCF).
2. HORIZONTAL AND VERTICAL DEFLECTION IS LIMITED TO 1/4" MAXIMUM FOR CONCRETE DEAD LOAD.
3. DESIGN STRESS IS LIMITED TO 20 KSI FOR CONCRETE DEAD LOAD TEMPORARILY INCREASED BY ONE-THIRD FOR THE CONSTRUCTION LIVE LOAD OF 20 PSF.
4. POUR STOP SELECTION TABLE DOES NOT CONSIDER THE EFFECT OF THE PERFORMANCE, DEFLECTION, OR ROTATION OF THE POUR STOP SUPPORT WHICH MAY INCLUDE BOTH THE SUPPORTING COMPOSITE DECK AND/OR THE FRAME.
5. VERTICAL LEG RETURN LIP IS RECOMMENDED FOR TYPE 16 AND LIGHTER.
6. THIS SELECTION IS NOT MEANT TO REPLACE THE JUDGEMENT OF EXPERIENCED STRUCTURAL ENGINEERS AND SHALL BE CONSIDERED AS A REFERENCE ONLY.



NICHOLAS J. BOURAS, INC.

P.O. BOX 662, 475 SPRINGFIELD AVE.  
SUMMIT, NEW JERSEY 07902-0662 (201) 277-1617



ASSOCIATE MEMBER



MEMBER

# BUY YOURSELF ACCURACY



STRUCTURAL SOFTWARE Fabrication Summary Sheet		
Job: 100	SAMPLE JOB	Page: 1
Date: 02-07-91	ROANOKE VA	Time: 14:14:29
		EST Ver: 3.04
104,279.200	Total Material Cost	\$127,476
50 Miles	Inbound Freight	\$7,483
184 lbs.	Jobite Freight	\$2,782
180 gal/ton	Total Mill Material	\$158
600	Paint Cost - Type #1	\$7,930
1,244 Mbs.	Shop Bolts	\$330
100 #	Detailing Cost	\$4,000
	Total Shop Labor	\$14,941
	Shop Overhead	\$18,941
*****		
	Total Job Cost	\$174,240
	SA 10%	\$17,424
	Total Including SA	\$191,664
	Profit 10%	\$19,166
	Total Including Profit	\$210,830
*****		
Std Date	02-04-91	
Time	12:14:29	
Labr	14.56 M/Time	
Shop \$/T	150.04	

## THE ONLY THING LEFT TO CALCULATE IS YOUR SAVINGS

The Estimating Program from Structural Software. An accurate bid can mean the difference between a healthy profit and an unwelcome surprise. Our Estimating program correctly prices all the items that go into a job, from the mill to the warehouse. What's more, it reflects the actual cost of labor at your shop. Almost all of the pricing levels and labor codes can be changed to suit your needs. In fact, Estimating's flexibility makes it the best estimating program on the market today.

Written by steel fabricators, Estimating is easy to use. You're able to bid more jobs using the same personnel. And because Estimating is designed for IBM computers and compatibles, no special training is necessary.

In these days of declining profit margins, Estimating gives you the accuracy you need to stay competitive. Call or write today for more information on Estimating and other Structural Software programs, including:

- FabriCAD II—Detail faster with more accuracy.
- Inventory Control, Production Control and Purchase Order—Material Allocation programs that link purchasing with production to cut waste and boost profits. Structural Software Company, 5012 Plantation Road, P.O. Box 19220, Roanoke, VA 24019, (800) 776-9118



**STRUCTURAL SOFTWARE CO.**  
SOFTWARE FOR THE STEEL INDUSTRY

# MODERN STEEL CONSTRUCTION

Volume 31, Number 4

April 1991



Site constraints greatly complicated the design and construction of the Morton International Building in Chicago. The structure is built over existing rail tracks that disallowed foundation placement underneath the structure's southwest corner. The story behind this building begins on page 32. Photo by McShane & Fleming Studio

## FEATURES

- 12 **SERVICING THE MOUSE THAT ROARED**  
*Disney World's phenomenal popularity is a major reason for the need to expand Orlando's airport*
- 18 **THE FUTURE FOR REGIONAL AIRLINES**  
*A state-of-the-art facility for a southeast commuter airline maintenance company utilized the LRFD Specification to realize a 10% savings in truss steel*
- 24 **CURING TERMINAL ILLNESS**  
*An exciting design was needed to create a high-profile image for a new operator at Nashville's growing airport*
- 28 **GIANT CLEAR SPAN FOR JUMBO JETS**  
*A 412' clearspan was needed to create a hangar big enough for three planes at once*
- 32 **TRAIN TRACKS DETOUR BUILDING'S FOUNDATION**  
*Building over train tracks meant that the southwest corner of an otherwise ideally located site was inaccessible for foundation placements*
- 40 **GYM INFILL REQUIRES STRUCTURAL STRENGTHENING**  
*The 73,000-sq.-ft. Denver Place Athletic Center is partially built on top of an existing pedestrian bridge*

## NEWS AND DEPARTMENTS

- |   |                         |    |                                     |
|---|-------------------------|----|-------------------------------------|
| 6 | EDITORIAL               | 9  | NSCC PROGRAM AND REGISTRATION FORMS |
| 8 | STEEL NEWS              | 44 | BOLTS AND FASTENERS                 |
|   | •New Seismic Provisions | 50 | AD INDEX                            |
|   | •New Design Guide       |    |                                     |
|   | •T.R. Higgins Winner    |    |                                     |



# HISTAR<sup>®</sup>

**A new generation  
of rolled beams  
and column shapes  
for economical  
steel construction.**

Once again, ARBED leads the industry by featuring a trendsetting combination of mechanical, chemical and technological properties:

- HIGH YIELD STRENGTHS (up to 65 KSI) - even for ultra-heavy sections.
- OUTSTANDING TOUGHNESS PROPERTIES.
- EXTREMELY LOW CARBON EQUIVALENT — ensures excellent weldability.

#### A NEW PROCESS... QST.

The secret is in ARBED's revolutionary new in-line QST process.

#### OTHER RECENT ARBED INNOVATIONS:

ARBED-ROLLED 40", 44", and "TAILOR-MADE" (WTM) series — famous for high section moduli, great lateral buckling resistance, and big savings in fabrication costs and weights. These products are also available in the new HISTAR quality as is our standard WF series and H BEARING PILES.

#### NEW LITERATURE AVAILABLE

Send now for complete data on all these ARBED products, contact Trade ARBED, INC., 825 Third Ave., New York, NY 10022. (212) 486-9890, FAX 212-355-2159/2421. In Canada: TradeARBED Canada, Inc., 3340 Mainway, Burlington, Ontario, Canada L7M 1A7. (416) 335-5710, FAX 416-335-1292.

**TRADE ARBED** Inc.

**INNOVATORS OF STEEL CONSTRUCTION PRODUCTS.**

### Editorial Staff

Scott Melnick,  
Editor  
Patrick M. Newman, P.E.,  
Senior Technical Advisor  
Cynthia J. Zahn,  
Senior Technical Advisor

### Editorial Offices

Modern Steel Construction  
One East Wacker Dr.  
Suite 3100  
Chicago, IL 60601-2001  
(312) 670-5407

### Advertising Sales

Eric K. Nieman, Pattis-3M  
Ed Sreniawski, Pattis-3M  
7161 North Cicero  
Lincolnwood, IL 60646  
(708) 679-1100  
FAX (708) 679-5926

### AISC Officers

Ralph H. Clarbour,  
Chairman  
Stephen E. Egger,  
First Vice Chairman  
Frank B. Wylie III,  
Second Vice Chairman  
Oscar W. Stewart, Jr.,  
Treasurer  
Neil W. Zundel,  
President  
David Ratterman,  
Secretary & General Counsel  
Lewis Brunner,  
Vice President,  
Membership Services  
Geerhard Haaijer,  
Vice President,  
Technology & Research  
Morris Caminer,  
Vice President,  
Finance/Administration

## Solid Knowledge For Serious Designers

As regular as a notice from the taxman, April brings a slew of announcements about upcoming conventions and seminars. With a little ingenuity, an adventurous soul could easily avoid his office during the entire months of April, May and June.

But as interesting (or as draining) as it might be to hit the road for three solid months, very few businesspeople can afford that luxury.

Choosing which trade shows to attend can be an arduous and difficult task. Read through the packets sent out by the show producers and you're promised the moon—but how many actually deliver even one piece of information usable in your everyday business?

That's why I was so impressed last year when I attended my first National Steel Construction Conference. The show doesn't feature a lot of razzle-dazzle. There aren't acres of hospitality suites at night. There aren't pretty girls handing out party favors. And there aren't magicians in the aisles.

Instead, the NSCC features a series of solid seminars and a small exhibit hall for serious fabricators and engineers on June 5-7.

Interested in seismic design? Check out Peter I. Yanev's talk on "Building for Earthquake Survival" on Thursday, June 6. Yanev is vice president and chairman of EQE Engineering, one of the country's most respected seismic design firms. And you can follow that session with a technical seminar on seismic connection design.

Not interested in earthquakes? How about a session on "Economic Comparison of ASD and LRFD for Buildings"? Or maybe you'd appreciate some information on "Simple Connections in Tubular Construction"? And every engineer can benefit from "Innovations in Fire Protection".

And if the huge quantity of raw information available at the NSCC doesn't excite you, you can still benefit from hobnobbing with some of the industry's top designers and fabricators who long ago realized the value of attending this annual event.

Registration forms are on pages 10-11 in this issue. I look forward to seeing you in June. **SM**



## Our Galvanized Nuts, Bolts And Washers Are Not Your Average Run Of The Mill.

At Nucor Fastener, our nuts, bolts and washers are not only mechanically galvanized, they also meet the toughest standards anywhere. As a result, you get maximum corrosion protection, excellent uniformity and no hydrogen embrittlement or detempering. Fact is, our products meet or exceed ASTM-B-695, AASHTO M298 and MIL-C-81562 requirements, and our nuts are coated with a blue dyed lubricant to meet ASTM, FHWA and state DOT standards for optimal torque and tension. *What's more, we manufacture our nuts and bolts in the same facility, so you know they'll give you a compatible fit.*

When you add up all these advantages, you get fasteners that are way above average. You get superior, consistent performance that saves you time and trouble on the job and ensures quality long after the

job is done. And on top of all this, we can test for your special requirements, we guarantee traceability, and our prices are competitive with hot-dipped galvanized products. Even better, all the steel used in our bolts and nuts comes from Nucor Steel and other domestic steel mills. Which is one more reason they're not your average run of the mill.

So find out more about our line of galvanized products including A325 structural bolts, A563 heavy hex nuts and F436 washers. We maintain an inventory of popular sizes for immediate delivery.

Call 800/955-6826, FAX 219/337-5394. Or write Nucor Fastener, PO Box 6100, St. Joe, Indiana 46785.

**NUCOR FASTENER**  
A Division of Nucor Corporation

## AISC Issues LRFD Seismic Provisions

Seismic design is addressed in a newly available addendum to the Load & Resistance Factor Design Manual of Steel Construction. "Specification of Seismic Provisions for Structural Steel Buildings" also includes an extensive commentary.

Sections include: Load and Load Combinations; Material Specifications; Column Requirements; Requirements for Ordinary Moment Frames; Requirements for Special Moment Frames; Requirements for Concentrically Braced Frames; Requirements for Eccentrically Braced Frames; and Inspection.

"The new Specification complements the AISC LRFD Manual with special provisions required for design in buildings in Zones 3 and 4 and for buildings with an Importance Factor greater than 1.0 in

Zone 2," explained Clarkson Pinkham, S.E., president of S.B. Barnes Associates, Los Angeles, and secretary of Specification Task Committee 113, which developed the new provisions. "Similar information has been available in the model codes on the West Coast; however, it has not been available in the LRFD format."

The seismic provisions will be included in the First Revised Edition of the LRFD Manual of Steel Construction, which is scheduled to be available this summer. Individual copies of the seismic provisions are available for \$5 + \$4 shipping and handling (plus sales tax in Illinois, California, or New York) from: AISC Publications Dept., P.O. Box 806276, Chicago, IL 60680-4124 (312) 670-2400 ext. 433.

---

### Seismic Provisions for Structural Steel Buildings— Load and Resistance Factor Design

---

November 11, 1990

AMERICAN INSTITUTE OF STEEL CONSTRUCTION, INC.  
One East Wacker Drive, Suite 5100, Chicago, IL 60601-2001

## New Design Guide: Extended End-Plate Moment Connections

The fourth in a series of Steel Design Guides, "Extended End-Plate Moment Connections," is now available from AISC. The use of moment end-plate connections in multi-story, moment resistant frame construction is on the upswing as more engineers become aware of its economic advantages.

The new Design Guide includes information on four-bolt extended end plates as well as eight-bolt extended end plates. Design Guide chapters include: Recommended Design Procedures; Unstiffened,

Extended End-Plate Connection Design; Stiffened, Extended End-Plate Connection Design; and information about ASD and LRFD Design Aids and Nomenclature.

The guide presents complete design procedures and examples for extended moment end-plate connections suitable for fully restrained (or continuous frame) construction.

Previous AISC Design Guides include: "Column Base Plates," a compilation of existing information on the design of base plates for steel columns; "Design of Steel and Composite Beams with Web Openings," a summary of design concepts for practicing engineers; and "Serviceability Design Considerations for Low Rise Buildings," a comprehensive review of information on serviceability design criteria.

Each Design Guide is available for \$16 + \$4 shipping and handling (plus sales tax in Illinois, California and New York) from AISC Publications Department, P.O. Box 806276, Chicago, IL 60680-4124 (312) 670-2400 ext. 433.

## 1991 T.R. Higgins Award

Thomas M. Murray, Montague-Betts professor of structural steel design at the Virginia Polytechnic Institute and State University, Blacksburg, VA, is the winner of the 1991 T.R. Higgins Lecture-ship Award. The AISC award recognizes an author whose technical paper or papers have made an outstanding contribution to the fabricated structural steel industry.

"Building Floor Vibrations", Murray's honored paper, advances state-of-the-art techniques for controlling floor movement in residential, office and commercial environments.

Murray will give a presentation at the National Steel Construction Conference in Washington, DC, on June 5. He will make six additional presentations during the next 12 months.



# National Steel Construction Conference (NSCC)

Washington, DC June 5-7  
Advance Program and Registration

## Tuesday, June 4

11:30 a.m. - 4:30 p.m.  
Welcome to Washington Tour  
(optional event)

8:00 - 11:00 p.m.  
Washington After Dark  
(optional event)

## Wednesday, June 5

8:30 - 10:30 a.m.  
Professional Member Forum

9:00 a.m. - noon  
Experience Capitol Hill  
(Spouses optional event)

1:00 - 5:00 p.m.  
Corcoran Gallery of Art, Embassy  
Row & the National Cathedral  
(Spouses optional event)

1:00 - 1:15 p.m.  
Welcome and Introductions

1:15 - 2:00 p.m.  
General Session: T.R. Higgins Lec-  
ture: *Building Floor Vibrations*  
Prof. Thomas M. Murray, Virginia  
Polytech Institute and State University

2:00 - 3:00 p.m.  
Keynote Address: *Motivating Your  
Staff and Work Force*  
Dorman Conklin, Principal, Employee  
Development Services, Jackson, MS

3:00 - 5:00 p.m.  
Exhibits Open  
No technical sessions are offered at  
this time, giving attendees an opportu-  
nity to visit the 100-plus exhibit booths.

5:15 - 6:00 p.m.  
Exhibitor Workshops  
Specialized sessions introducing the  
latest in new products and techniques

6:30 - 8:00 p.m.  
AISC Welcome Cocktail Party  
All conference attendees and their spouses  
are invited

## Thursday, June 6

8:30 - 9:15 a.m.  
General Session: *Building for Earth-  
quake Survival*  
Peter I. Yanév, EQE Engineering, San  
Francisco

9:15 - 10:15 a.m.  
General Session: *Troubleshooting Struc-  
tural Steel: BASIC Offers Practical Solu-  
tions*  
Dr. Reidar Bjorhovde, BASIC, Univer-  
sity of Pittsburgh  
Professor Stanley T. Rolfe, University  
of Kansas at Lawrence

10:00 a.m. - 3 p.m.  
Exhibits Open

10:00 a.m. - 3:00 p.m.  
George Washington Slept Here  
(Spouses optional event)

11:00 a.m. - 12:30 p.m.  
Technical Seminars  
1. *Troubleshooting Structural Steel:  
BASIC offers Practical Solutions*  
2. *Practical Engineering in Shop Fabrica-  
tion*  
3. *Simple Connections in Tubular Con-  
struction*  
11. *Economic Comparison ASD and  
LRFD for Buildings*  
12. *Seismic Building Design Specificatoin*  
13. *Rehabilitation of Existing Buildings*

Noon - 1:45 p.m.  
Lunch Service Provided  
In Exhibit Hall

2:30 - 4:00 p.m.  
Technical Seminars  
4. *Plant Automation*  
5. *How to Get Shop Drawings Ap-  
proved—On Time*  
6. *Undesirable Clauses in Contracts*  
14. *Recent Research Results—I*  
15. *Recent Research Results—II*  
16. *Recent Developments in Steel Fabrica-  
tion and Material Selection: Electroslag  
Welding & Weathering Steel Structures*

4:10 - 5:30 p.m.  
Technical Seminars  
7. *EPA—Right to Know Legislation  
SARA, Title III, Section 313*  
8. *Advances in Welding for the Steel Fab-  
rication Industry*  
9. *Application of Multiple Shop Coatings*  
17. *Innovations in Bridge Design*  
18. *Seismic Connection Design*  
19. *Innovations in Fire Protection*

5:30 - 6:15 p.m.  
Exhibitor Workshops

7:00 - 7:45 p.m.  
Reception (Cash Bar)

7:45 - 10:00 p.m.  
Dinner & Entertainment  
Capital Steps and Dancing  
(Optional event)

## Friday, June 7

7:30 - 8:15 a.m.  
Exhibitor Workshops

8:30 - 9:15 a.m.  
General Session: *Steel Construction Sys-  
tem for Low-Rise Commercial and Residen-  
tial Building*  
P.O. Thomasson, Swedish Institute of  
Steel Construction, Stockholm, Sweden  
Session highlights a special construc-  
tion system that minimizes floor-to-  
floor height.

9:15 - 10:00 a.m.  
General Session: *The Great American  
Pyramid: Ancient Shape, Modern Design*  
Lawrence G. Griffis, Walter P. Moore  
& Associates, Houston

10:00 a.m. - 2:30 p.m.  
Exhibits Open

10:30 a.m. - 4:00 p.m.  
A Special Tour  
(Spouses optional event)

10:45 a.m. - 12:15 p.m.  
Technical Seminars  
20. *Codes & Ethics*  
(1, 4, 7, 14, and 15 repeat)

Noon - 1:45 p.m.  
Lunch Service Provided  
In Exhibit Hall

2:30 - 4:00 p.m.  
Technical Seminars  
(2, 5, 8, 11, 12, and 13 repeat)

4:10 - 5:30 p.m.  
Technical Seminars  
(3, 6, 9, 16, 17 and 18 repeat)

8:00 - 11:00 p.m.  
Washington After Dark Tour  
(Optional event)

T.B.A.  
The Phantom of the Opera  
(Optional Event)

## Saturday, June 8

Optional Tours:  
Tour of Bridge Shop (8:00 - 11:30 a.m.  
and 9:00 a.m. - 12:30 p.m.)  
Arlington Cemetery and Mt.  
Vernon (10:00 a.m. - 4:00 p.m.)  
Air and Space/American History Mu-  
seum (1:00 p.m. - 5:00 p.m.)

# ***NSCC HOTEL RESERVATION FORM***

**RESERVATIONS MUST BE ACCOMPANIED BY ONE NIGHT'S ROOM DEPOSIT INCLUDING 11% TAX AND \$1.50 OCCUPANCY TAX. THE HOTEL ACCEPTS CHECKS, MONEY ORDERS, AMERICAN EXPRESS, VISA, MASTER CARD, DINERS CLUB, CARTE BLANCHE, & DISCOVER.**

If reserving rooms by phone, advise hotel you are attending the **AISC National Steel Construction Conference** and wish the conference rate.

All Conference activities take place at the historic Sheraton Washington Hotel, 2660 Woodley Road at Connecticut Ave. NW (near the National Zoo) Washington, D.C. 20008 Phone: (202) 328-2000.

**Circle room rate requested:** Rooms vary in price based on location and size of room. If rate selected is not available, next available rate will be confirmed. The Wardman Tower Rooms are elegant rooms in the historic Wardman Tower.

## **Single Room Rates:**

**\$109\***

**\$119\***

**\$129\***

## **Wardman Tower Rate: \$140\***

### **Special Requirements:** \_\_\_\_\_

Note: \*Rate quoted is for single occupancy, if additional person in room, add \$20.00. Rates do not include room tax of 11% or \$1.50 per day occupancy tax.

The hotel will honor and guarantee reservations received by May 1, 1991. Reservations received after this date will be on a space available basis. So mail this form promptly.—Reservations are subject to cancellation at 4:00pm if not guaranteed.—Failure to cancel your reservation 72 hours prior to arrival will result in forfeiture of your one night's deposit. Please reserve the accommodations indicated above for:

Guest Name: \_\_\_\_\_ # Adults \_\_\_\_\_ # Children \_\_\_\_\_

OR sharing room (dividing bill) with: \_\_\_\_\_

Organization or company: \_\_\_\_\_

Mailing Address: \_\_\_\_\_

City: \_\_\_\_\_ State: \_\_\_\_\_ Zip: \_\_\_\_\_

Phone Office: ( ) \_\_\_\_\_ Home ( ) \_\_\_\_\_

Arrival Date: \_\_\_\_\_ Approx. Arrival Time: \_\_\_\_\_ Departure Date: \_\_\_\_\_  
(Check-in time is 3:00pm. Check-out time is 1:00pm)

I enclose check for \$ \_\_\_\_\_ **payable to the Sheraton Washington Hotel. OR**

Please charge one night's deposit including tax & \$1.50 occupancy tax to my

Credit Card # \_\_\_\_\_

(Circle card used:) American Express    Visa    MasterCard    Diners  
Discover    Carte Blanche

Expiration Date: \_\_\_\_\_ Signature: \_\_\_\_\_

**(For information only, call David G. Wiley, Phone: 312/670-5422)**

# NSSC REGISTRATION FORM

**Registration Fee:** (Please circle appropriate fees)

**AISC Member Fee:** \$290.00 (before April 19)  
\$335.00 (after April 19)

(Includes AISC Active Associate & Professional Members)

**Non-Member Fee:** \$340.00 (before April 19)  
\$385.00 (after April 19)

**Educator Fee:** \$100.00

(Employed full-time at accredited architectural or engineering college or university.)

**Student Fee:** \$75.00

(Letter from faculty advisor or equivalent required)

**Exhibitor, in Booth** (no charge)

**Added Exhibitor:** \$75.00

**Spouse's Fee:** \$100.00

## Partial Registration Fees

(You may also pre-register for one day or half day.

**Circle your choice below.)**

**Half Day Sessions:** (Lunch not included)

Wednesday Afternoon	\$ 55.00
Thursday Morning	\$ 70.00
Thursday Afternoon	\$ 70.00
Friday Morning	\$ 70.00
Friday Afternoon	\$ 70.00

**One Day Sessions:**

Thursday (includes Lunch)	\$160.00
Friday (includes Lunch)	\$160.00

**Exhibit Floor Pass**

(included in full & partial registrations) \$ 5.00

**Total Partial Registration Fees** \$ \_\_\_\_\_

**Registration Fees Include** all General and Plenary Sessions, workshops, seminars, coffee breaks, luncheons Thursday and Friday, the Get-acquainted Cocktail Reception Wednesday evening and a printed, bound copy of the Proceedings. Exhibitors are entitled to one registration for each 8 ft x 10 ft or 10 ft x 10 ft exhibit space reserved. "Added Exhibitor" fee is payable **ONLY** if in excess of one person per 8 ft x 10 ft or 10 ft x 10 ft.

**Registration Cancellation Policy:** Cancellations received before May 22, 1991, 100% of pre-paid registration fees will be refunded; after May 22, 50% will be refunded. (Those cancelling after May 22 will receive their copy of the Conference Proceedings.)

## Registration for Optional Events

Event	No Tickets	Total Price
#1— Welcome To Washington (Tues. 11:30am)	___ @24.00	\$ _____
#2— Washington After Dark (Tues. 8:00pm)	___ @22.00	\$ _____
#3— Washington After Dark (Fri. 8:00pm)	___ @22.00	\$ _____
#4— A State Dinner/Capitol Steps (Thurs. 7:45pm)	___ @65.00	\$ _____
#5— Phantom of the Opera (Fri. TBA/pm)	___ @65.00	\$ _____
#6— Tour Bridge Shop (Sat. 8:00am)	___ No Fee	\$ _____
#7— Tour Bridge Shop (Sat. 9:00am)	___ No Fee	\$ _____
#8— Arlington Cemetery/Mt. Vernon (Sat. 10:00am)	___ @34.00	\$ _____
#9— Air & Space/American History Museums (Sat. 1:00-5:00pm)	___ @24.00	\$ _____
#A— Experience Capitol Hill (Wed. 9:00am)	___ @22.00	\$ _____
#B— Corcoran Gallery/National Cathedral (Wed. 1:00pm)	___ @22.00	\$ _____
#C— George Washington Slept Here Tour (Thurs. 10:00am)	___ @30.00	\$ _____
#D— A Special Tour (Fri. 10:30am)	___ @34.00	\$ _____
<b>Total Optional Event Fees</b>		<b>\$ _____</b>

## PLEASE REGISTER (Type or Print)

Name \_\_\_\_\_ Nickname (for badge) \_\_\_\_\_

Company \_\_\_\_\_ Title \_\_\_\_\_

Mailing Address \_\_\_\_\_

City and State/Zip \_\_\_\_\_ Bus. Phone \_\_\_\_\_ Home Phone \_\_\_\_\_

If spouse or other guest is registering for Complete Spouses' Program, or individual Spouses' or Optional Events, please complete next line for badge:

Name of Individual Registering for Other Events \_\_\_\_\_ Nickname (for badge) \_\_\_\_\_

## Conference Fees Payable:

Registration Fee	\$ _____
Spouse's Fee	\$ _____
Partial Registration Fees	\$ _____
Optional Events	\$ _____
<b>Total Registration Fees:</b>	<b>\$ _____</b>

## MAIL COMPLETED FORM AND CONFERENCE FEES TO:

**American Institute of Steel Construction, Inc.**

1991 National Steel Construction Conference

P.O. Box 806286

Chicago, Illinois 60680-4124

Phone inquiries and information: 312/670-5422 Fax 312/670-5403

\_\_\_\_\_ I enclose check (U.S. funds) payable to AISC in amount of total fees.

\_\_\_\_\_ Please charge my credit card — Visa or MasterCard Only

# \_\_\_\_\_  
Circle one      VISA      MasterCard

Signature (if any credit card charges): \_\_\_\_\_

Expiration Date (Month and Year) \_\_\_\_\_

Name on Card: \_\_\_\_\_

# Servicing The Mouse That Roared

Disney World's phenomenal popularity is a major reason for the need to expand Orlando's airport

By Michael C. Head, P.E.

As a result of more and more attractions enticing an ever-growing number of visitors, America's fastest growing airport, the Orlando International Airport, has embarked on an ambitious expansion program.

The 500,000-sq.-ft. composite steel Delta Airlines Orlando Flight Center is the third airside terminal to be completed as part of an anticipated four-terminal expansion. And as befits a terminal near Disneyworld, departing travellers approach the futuristic structure from the main terminal building via a high speed automated ground transportation (AGT) system.

The Flight Center includes a central hub with a 140' clear span, glass-clad structural steel dome rising 43' above the concourse level, a large mezzanine level suspended from its roof and a 100'-

high control tower. As the AGT nears the Center, travellers can see two of its three 400'-long concourses, each with eight gates. The hub is shaped like a triangle with its corners cut off. Where the corners normally would be, the concourses extend out.

The AGT station is a separate building along one of the legs of the triangle between two concourses.

## Space-Age Appearance

The center's rounded ends present a sleek, modern appearance, almost as if the design was lifted from a cinematographer's rendering of a space station. Architect for the project was KBJ Architects, Inc., Jacksonville, FL, and structural engineer was O'Kon and Company, Inc., Atlanta.

The concourses each have two levels, while the central hub has two levels plus a mezzanine.

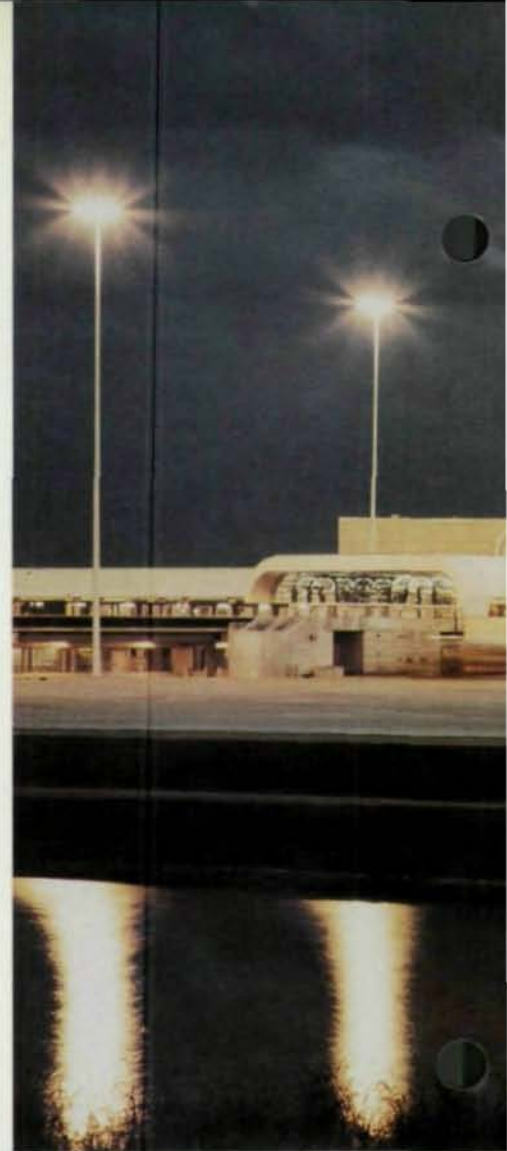

Perimeter framing for the central hub consists primarily of W24 columns and W40 girders, with the bottom flange of the curved columns attaching to the bottom flange of the girders. On the other end, the major girders frame into the dome columns.

The vertical W24 column is connected to the W40 girder with a curved 24"-deep section of the same size column. For ease of fabrication, the curved section was built as a plate girder instead. The transition between the 24" plate girder and W40 girder was formed with stiffener plates with a top flange extension 5' into the W40.

The W40/plate girder assembly was shipped as one piece. The girder's large size was needed to satisfy architectural requirements regarding the location of the W24 curved section and still provide support for the roof structure. Openings were provided in the



W40 sections for ductwork to pass through.

Perimeter framing for the concourse area consists of W18 and W12 columns with a bar joist roof.

The 163'-long AGT station has a post-tensioned concrete floor. It's arched ceiling consists of 10 curved plate girders resting on the concrete floor and spanning 89'. The ceiling is 3'-4" deep at the center and 1'-5" at the ends. Due to their size, each girder was shipped to the site in three sections. The sections consist of a straight 63' section, and two sharply curving sections for each end.

### Central Hub

Perhaps the most dramatic feature of the Flight Center is the wide-open space in the central dome. The delicate structure of the dome is designed to be almost invisible as sunlight floods through 12,750 sq. ft. of skylight and bathes



*Delta Airlines Orlando Flight Center features a modern, sleek design and includes three 410'-long concourses surrounding a central hub. Top photo by Steven Brooke*



*Delta's passengers are dazzled by the central hub, which includes a 12,750-sq.-ft. skylight covering a 140'-wide, column-free space. The massive skylight is supported on two compression rings, which, in turn, rest on 12 built-up tubes emerging from a series of cluster columns. Top photo by Steven Brooke*

the entire hub in dazzling light.

The dome is an integral part of the roof framing and the lateral load resisting system.

The dome consists of two compression rings, one made up of curved W21 wide flange sections and one of W24 sections. The rings are connected with 1"-thick plates every 15198 along their perimeter. Extending out from the 36' diameter ring are 12 built-up tubes framing out to cluster columns.

The cluster columns consist of three wide flange columns connected by a series of horizontal plates at the top and bottom. Interestingly, the built-up tubes are larger than they need to be in order to meet the architectural design.

#### **Column-Free Design**

Stretching along one side of the dome are two mezzanine areas. To provide the spacious, column-free space required by the architect, the mezzanine levels are suspended from roof members. The mezzanine is supported on one side by two



92'-long plate girders over the AGT station, and is suspended from the roof girders by W24 hangars. The plate girders span the width of the AGT station.

Towering 50' above the terminal's roof is a Delta Control Tower with a 45' clear span domed roof. The control tower is partially supported by columns extending to the foundation and partially by the hub roof structure.

#### Glare Control

Radiating out from the central hub are three concourses. To continue the spacious, bright feeling of the hub, huge skylights extend down the spine of each concourse, with each culminating in a large semi-circular skylight. In addition, as with the hub area, the concourses' walls feature sizable arrays of glazing.

The large expanses of glazing, combined with Florida's strong sun, made shading a critical concern.

In the hub area, sun shading

was achieved by using fritted glass and a system of horizontal steel pipes supported at the glazing line by W24 vertical and curved column sections. A second, smaller diameter network of pipes follows the same profile as the glazing and appears to "float" above the exterior. The pipes are supported by W8 column sections and a system of slit pipes and steel plate beams. As the sun moves overhead, the closely-spaced pipes block the heat while providing unhindered views.

Sun shading for the concourse area is different, though equally effective. In those areas, three parallel 12" x 12" steel tubes extend 7' out from the building to create a sun screen.

#### Lateral Load Resisting System

The entire Flight Center was designed to resist hurricane-force winds, and each discrete part was individually considered for wind resistance.

*The modern appearance of the terminal's exterior is echoed by the sleek lines of the 410'-long concourses. Glass and brass combine with a horizontally-oriented ceiling to provide visual reference points within the huge space. In addition, a strip of skylighting runs down the center of each concourse (not shown). Photo by Steven Brooke*

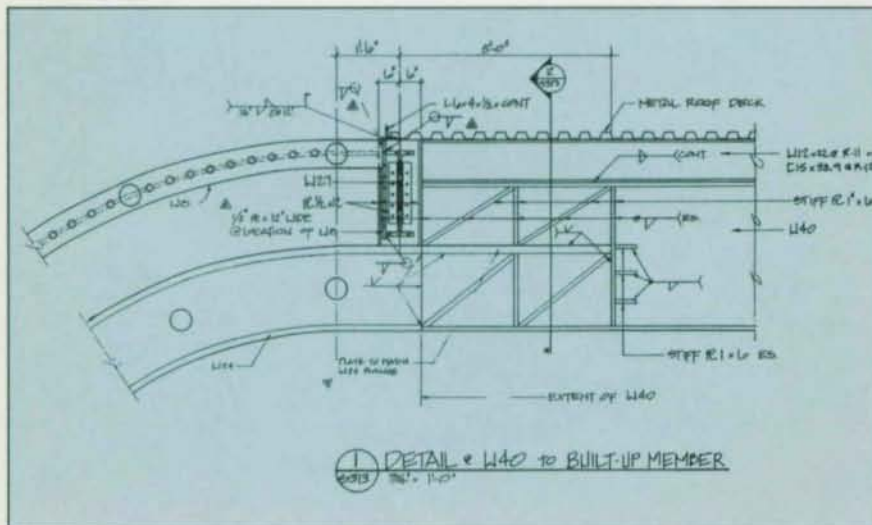

The Flight Center's large expanses of glazing made sun control a crucial element. In the hub area, sun shading was achieved with a system of horizontal steel pipes, while in the concourses, sun shading was provided with three parallel 12" x 12" steel tubes extending 7' out from the building. Top photo by Steven Brooke

The diagram at left shows the connection between the curved columns and girders.



Each of the three concourses have two transverse expansion joints plus a third at the hub interface. The concourses were designed with partially fixed connections along their lengths and as a rigid frames across the width. Membrane action of the deck was used to transfer the hurricane force winds to the wind resisting elements.

The three mechanical areas, which are located at the interface between each concourse and the hub, were braced with diagonal X-bracing with the wind forces on the dome and glass wall perimeter being transferred to the foundation via rigid frames and X-bracing at the lower level. A similar design was used for the control tower dome.

### Time Constraints

To realize the Greater Orlando Aviation Authorities 1990 opening date, the design period for the structural steel package was shortened to allow bid to be accepted in February 1989, two months before the architectural and mechanical/electrical/plumbing package was completed. The 3,800 tons of steel were supplied by AISC-members Steel, Inc., Scottdale, GA, and Qualico Steel Co., Webb, AL. Erector was Williams Erection Co., Smyrna, GA.

To further speed the construction process, in January 1989 the foundation and underground tunnel system were awarded to the already mobilized general contractor for the Main Landside Terminal, Great Southwest Corporation. This enabled the foundations to be completed in time to allow the steel contractor to erect the steel as it arrived on the site.

General contractor for the rest of the project was ACI/Mitchell, Atlanta.

*Michael C. Head, P.E., is a project manager with O'Kon and Company, Inc., the project's Atlanta-based engineers.*

## M-STRU DL®

The Best Selling  
Civil/Structural Program Since 1987

### ANALYSIS

- 2D/3D Frame / Truss / Plate / Shell
- Static / P-Delta / Dynamic / RSA Analysis
- Capable of 1000's of joints and 100's of load cases
- Moving load generator
- Interactive geometry, deflection, mode shape, plots
- Interactive shear and moment diagram plots
- AISC Library included

### DESIGN

- Interactive graphic menu driven design
- Continuous beam, section properties, frequency calculations
- AISC code check and sizing including LRFD
- ACI column, beam, footing, retaining wall design
- Design details can be output to AUTOCAD
- Excellent in report presentations

### SATISFACTION GUARANTEED\*

\*See our brochure for details  
Supports DOS/OS2 operation systems

"Ask for a brochure today!"  
You'll be glad you did.



P.O. Box 7326  
Fremont, CA 94536-7326  
(415) 795-0509  
Fax (415) 795-0918

## RISA-2D

Rapid Interactive Structural Analysis  
Two Dimensional

Whether designing multistory buildings

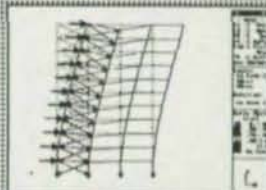

or just checking a single member,

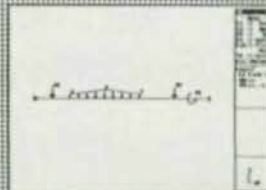

RISA-2D is the best tool for the job.  
Give us a call and see for yourself!

For a demo, call: 1 (800) 332-7472  
FAX: (714) 863-0244

17900 Sky Park Circle, Suite 106  
Irvine, CA 92714



# FREE!!

## PLANE FRAME ANALYSIS PROGRAM

That's right, for just a nominal charge to cover materials and handling (\$19), we will send you our powerful PLANE program. This is our fullblown PLANE, not a watered-down version. How can we possibly afford to do this? It is because we are convinced that once you've tried our software, you will be back for more.

You will also receive all required documentation, as well as information regarding our 80+ programs for concrete, masonry, steel, timber and post-tensioned concrete design, including design and graphics modules for PLANE. Our programs are developed to run on IBM-PC, -XT, -AT and most compatibles.

OVER 20 YEARS  
OF USE BY OVER 2000 FIRMS!



400 JOINTS  
600 MEMBERS  
UNLIMITED LOADS  
6 LOAD CASES  
LOAD COMBINATIONS  
MEMBER FORCES  
c 1/10 pts.

THE MOST PRODUCTIVE STRUCTURAL DESIGN SOFTWARE SINCE 1966

SAI

STRUCTURAL  
ANALYSIS, INC.  
555 S. Federal Hwy.  
Suite 210  
Boca Raton, FL  
33432  
(407) 394-4257

YES, Please send me free PLANE (\$19 to cover materials and handling.)  
(Offer valid in the U.S.A. and Canada only) - (Expires June 30, 1991)

NAME: \_\_\_\_\_ COMPANY: \_\_\_\_\_  
STREET: \_\_\_\_\_  
CITY/STATE/ZIP: \_\_\_\_\_  
PHONE: \_\_\_\_\_ COMPUTER: \_\_\_\_\_  MASTERCARD  VISA  
ACCT. NO.: \_\_\_\_\_ EXP. DATE: \_\_\_\_\_  CHECK ENCLOSED  
SIGNATURE: \_\_\_\_\_ DATE: \_\_\_\_\_

# The Future For Regional Airlines

A state-of-the-art facility for a southeast commuter airline maintenance company utilized the LRFD Specification to realize a 10% savings in truss steel



By Socrates A. Ionnides, P.E.,  
and William F. O'Donnell, P.E.

All of the talk of failing airlines always concentrates on the major players and neglects to consider one of the fastest growing segments of the market: the regional/commuter airlines.

Just 12 months after groundbreaking, construction was completed last month on a new center for regional/commuter aircraft at the Nashville International Airport. Funded by the Metropolitan Nashville Airport Authority, the new facility for FFV Aerotech, Inc., includes approximately 10,000 sq. ft. of office space, 32,000 sq. ft. of aircraft maintenance shops, and 34,000 sq. ft. of high-bay hangar area—large enough to accommodate up to six SAAB 340 series aircraft. The center, which is the first U.S. facility for the Swedish company, is referred to by its owner as "The future today in regional airport support."

The new high-tech facility provides complete support for both airframe modification/maintenance and aircraft component/accessory repair and overhaul under a single roof, a concept used extensively by FFV in Sweden and the United Kingdom.

"Already a hub for American Airlines, completion of the FFV facility represents another milestone for Nashville toward their goal of becoming the center of aviation for the United States," according to



*The hangar area for the new FFV Aerotech maintenance facility is 226'-wide by 150'-deep and provides space for three airplanes simultaneously.*

90242

Robert C. Mathews, Jr., chairman of the Metropolitan Nashville Airport Authority. Architect on the project was Barge, Waggoner, Sumner & Cannon, Nashville. Construction manager was D.F. Chase, Inc., Nashville.

### High Bay Hangar

The hangar area of the center is 226'-wide by 150'-deep, providing three distinct service bays and a 10'-wide service aisle around the perimeter. The clear doorway height is 28' and the clear height inside the hangar is 32', which allows the jacking of aircraft.

In order to design the most efficient structure, the structural engineer first had to study the facility's operational procedure. Required information includes:

- The specifications of the aircraft to be maintained, including: dimensions, weights, wheel loads, and jacking loads;
- Method of maintenance of the wings, fuselage, tail and stabilizer;
- Type of maintenance platforms and whether they're hanging or floor mounted;
- Fire suppression method and equipment.

The primary structural element for this structure is the main truss, which spans 226' across the front door of the hangar, providing clear-span opening to the hangar from the runway apron. Four additional trusses span 150' perpendicular to and bear on the main truss. Steel joists spanning between the perpendicular trusses complete the roof framing.

All of the trusses were comparatively checked using both the Allowable Stress Design (ASD) and Load and Resistance Factor Design (LRFD) Specifications. The trusses were designed to the LRFD Specification to realize a 10% material savings.

The top chord members of the main truss range in size up to W12x170 and the bottom chord members up to WT7x141.5. The top chord members of the four perpendicular trusses range in size up

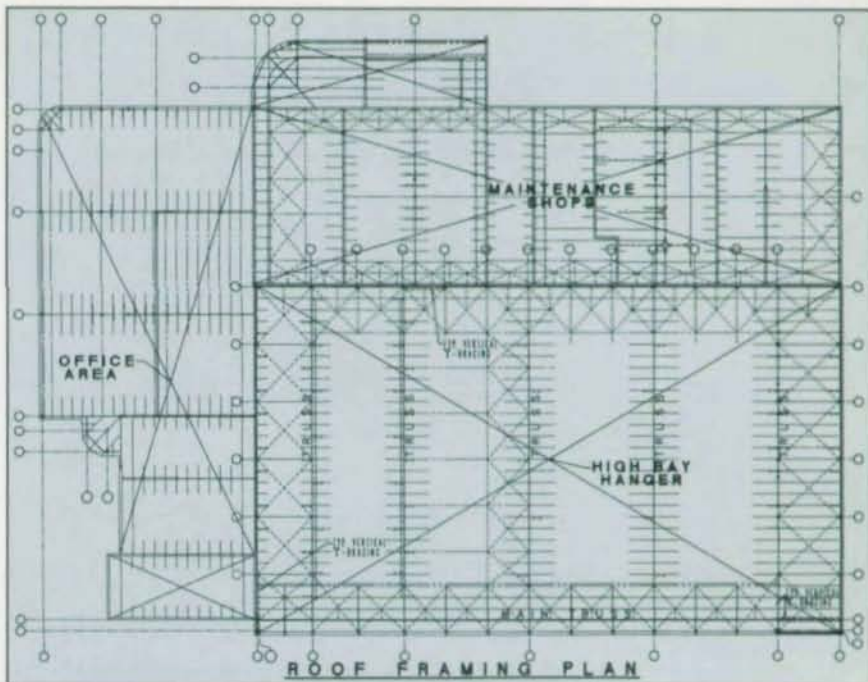

The primary structural element for the hangar is a 226'-long truss. Additionally, there are four more trusses spanning 150' and bearing on the main truss. The trusses were designed to the LRFD Specification after a comparative analysis showed it would produce a 10% material savings compared with ASD.

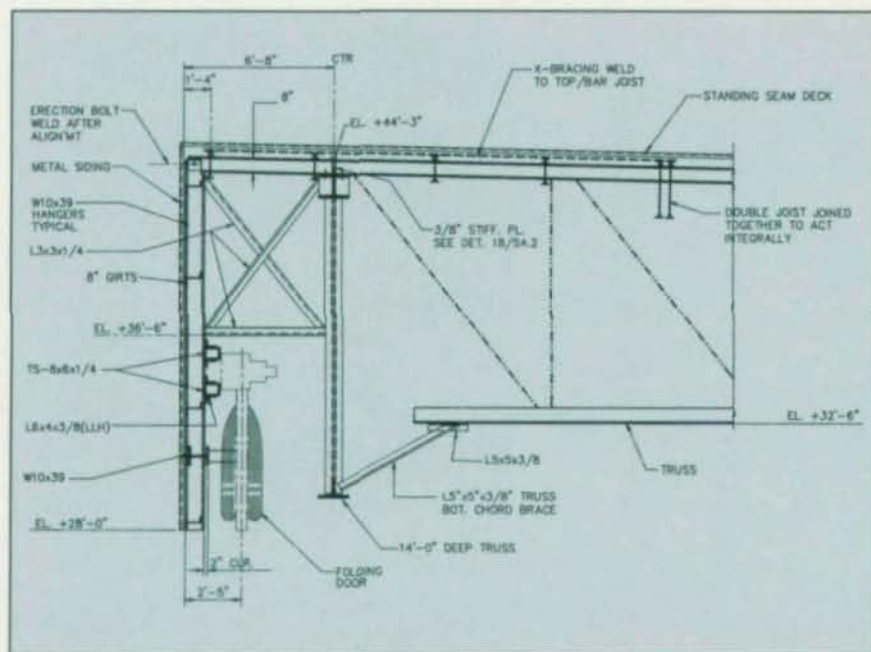

*By cantilevering the top chords of the perpendicular truss—as well as additional W8 beams located between the trusses—about 6' beyond the main truss, the engineers were able to create a "pocket" for the retracted main hangar door and its support equipment.*



to W8x58 and the bottom chord members up to WT7x45. Most of the truss chords are of A572-Grade 50 steel. Web members consist of double angles using A36 steel. To account for the dead load deflection of the trusses, dead load correction camber curves were provided for each truss.

To maximize shop fabrication while still permitting easy shipping and handling, the main truss depth was limited to 14' and field splice locations were coordinated with the fabricator/erector. The truss was fabricated in three sections and assembled on site. A total of three cranes were used to erect the truss. After setting the truss, one crane was left in place to stabilize the truss until the perpendicular trusses were erected and permanent bracing was installed. Steel fabricator was AISC-member Allen Iron and Steel Corp., Franklin, TN, and steel erector was Al-Tenn Steel Erectors, Inc., Franklin.

The perpendicular trusses were located to coincide with the overhead traveling bridge crane girder locations. The crane girders are attached to the bottom chord of the trusses at panel points. To provide roof drainage, the top chord of the trusses are sloped so that the truss depth varies from 7'-9" to 11'-9".

The roof system consists of a standing seam metal roof over rigid insulation and a metal liner panel. Since the standing seam roof does not provide adequate lateral support, horizontal roof X-bracing consisting of thin flat plates was used to create a diaphragm for the roof and to tie the compression chords of the joists and trusses.

Lateral load resistance is provided by vertical X-bracing, consisting of three tiers of steel tubes, strategically located in each wall around the perimeter of the hangar. Bracing is located in the first bay directly behind each of the main truss bearing points. Bracing for the front wall of the hangar is provided in the additional bay adjacent to the hangar door and main truss that contains the mezzanine area. An additional set of bracing is located along the back wall of the hangar.

An expansion joint separates the high bay structure from the adjacent maintenance shop and office areas.

The hangar wall system is primarily metal siding over steel Z-shaped girts with a metal liner panel on the inside. The wainscot around the lower portion of the hangar is constructed of split-faced masonry. Liner panels were used for the roof and walls to enhance the interior appearance. The structural steel and joists were painted white both for appearance and to maximize lighting efficiency in conjunction with the light reflective floor hardener used on the concrete slab-on-grade.

#### Hangar Door

A unique element on this project is the hangar door, which is made of two layers of polyester fabric reinforced with horizontal aluminum ribs. Rather than a conventional horizontal-sliding door, the door opens vertically, folding into pleats. Manufactured by MegaDoor, Inc., the door consists of five sections that can be opened independently or concurrently. To provide unobstructed entrance to the hangar, the vertical millions located between door sections swing up and out of the way after the door has been raised.

When opened, the door is totally concealed behind the front fascia of the hangar. This was accomplished by cantilevering approximately 6' beyond the main truss, creating a pocket for the retracted door, mullions and the retracting mechanism. To create the pocket, the top chords of the perpendicular truss, as well as additional W8 beams located between the trusses, were cantilevered over the main truss. The fascia and door assemblies were then suspended and braced from the cantilevered ends.

The structural engineer coordinated the structural framing with the hangar door supplier to ensure proper clearances and support for the door assembly. Additionally, deflections resulting from the door, which were critical to the installation, were calculated and provided

# ARE BOLTS CAUSING YOU UNDUE TENSION



## LEJEUNE SMART BOLTS KNOW "PROPER TENSION!"

A-325 or A-490 high strength bolts.  
Factory mill certification-traceable to each keg.  
Black or mechanically galvanized.  
Full domestic or open stock.

**"THE LOWEST COST SYSTEM FOR PROPERLY  
INSTALLED HIGH STRENGTH BOLTS!"**

LEJEUNE BOLT COMPANY  
8330 West 220th Street  
Lakeville, Minnesota 55044  
For Information or Technical Assistance  
Call 1-800-USA-BOLT (872-2658)  
FAX 1-612-469-5893



# SAVE

**S**ave big with Design

Data's SDS/2 steel fabricating software.

Save valuable time. Save money. Save yourself the hassle of refabrication and re-works. Save back charges. Save your apologies—deadlines are met.

SDS/2 saves the day. Call Design Data—1-800-443-0782. It's time.

**T**he Design Data **I**ntroducing

## Family of Steel Fabricating Software: SDS/2

- Estimating Module
- Detailing Module
- Production Control Module
- CNC Interface Module

DesignLINK—electronic communication from engineers to fabricators.

800-443-0782  
402-476-8278

*First In... Software, Solutions, Service*

**DESIGN DATA**

© 1991 Design Data Corporation

to the supplier.

More than \$5 million worth of state-of-the-art equipment will be installed throughout the maintenance shop areas surrounding the main hangar.

The roof system for the maintenance shops consists of a standing seam metal roof over rigid insulation and metal liner panel with horizontal roof bracing similar to the hangar roof. For maintenance purposes and durability, the exterior walls and the numerous interior partitions are constructed of reinforced masonry. To minimize cost, the roof is framed using steel joists bearing on a combination of the reinforced load-bearing masonry walls and continuous steel beams.

A number of the shops are located below a mezzanine in the high-bay portion of the building. The mezzanine is framed using steel joists bearing on steel beams and supporting a 3"-thick concrete slab on metal form deck.

### Office Area

The office area accommodates executive, engineering, sales and marketing, and finance and administration personnel. Amenities include an employee cafeteria, exercise room, lockers and showers.

To maximize flexibility, the office is a combination of fixed partitions and open office landscaping. Security is an important feature, and the public enters a controlled reception area incorporating natural light provided by a curved glass exterior wall. This motif is repeated in the executive waiting area and the food service area.

Similar to the maintenance shops, the roof framing is steel joists bearing on load-bearing masonry walls and continuous steel beams. The roof is a rubber membrane over insulation and metal roof deck. Reflecting the high-tech environment, the exterior walls are split-faced masonry with Alucobond fascia and soffits.

*Socrates A. Ionnides is president and William F. O'Donnell is a structural engineer at Structural Affiliates International, Inc., Nashville.*

## Structural Material Sorter Ver. 3.0

A series of programs designed to help steel fabricators manage material.



- Reduces labor — Increases accuracy.
- Automatically computes weights, surface areas, bolt counts and lineal totals.
- Quickly sorts lists into proper order.
- Produces optimum length-cutting lists from in-house stock, vendor's stock or the best combination of each.
- Provides shipping lists based on piece-mark sequence.
- Tallies material costs, shop hours and field hours for easy estimating.
- Uses simplified terms so non-tech personnel can operate with ease.
- External Data Interface can import existing computer-based material lists.
- Call today for a FREE demo kit, including the full system's operator's manual!

E.J.E. INDUSTRIES, INC.

COMPUTER SOFTWARE FOR STEEL PROFESSIONALS

287 Dewey Avenue

Washington, PA 15301

(412) 228-8841

# The reasons fabricators call Chaparral are as strong as our steel.

**Broad Product Line.** Chaparral's beams, rounds, channels, flats and angles enable us to be your best source for one-stop shopping.

**Availability—What you need when you need it.** Chaparral offers innovative roll-and-hold programs to match your delivery requirements.

**Knowledgeable Shipping / Central Location.** Our centrally located mill allows us to ship with ease throughout North America. In fact, some of Chaparral's shipping innovations have become industry standards.

**Sales Force—The strongest in the industry.** Our sales teams are responsive to your needs. One phone call to any of our qualified professionals will take care of your complete order.

**Price. We're competitive.** Prices are quoted on a delivered basis. Give us a chance to meet or beat your current source. Just call us at 1 (800) 527-7979.



## CHAPARRAL STEEL

Toll Free (800) 527-7979 In Texas (800) 442-6336  
Local (214) 775-8241 Metro 299-5212 Telex 73-2406  
300 Ward Road, Midlothian, Texas 76065-9651



# Curing Terminal Illness

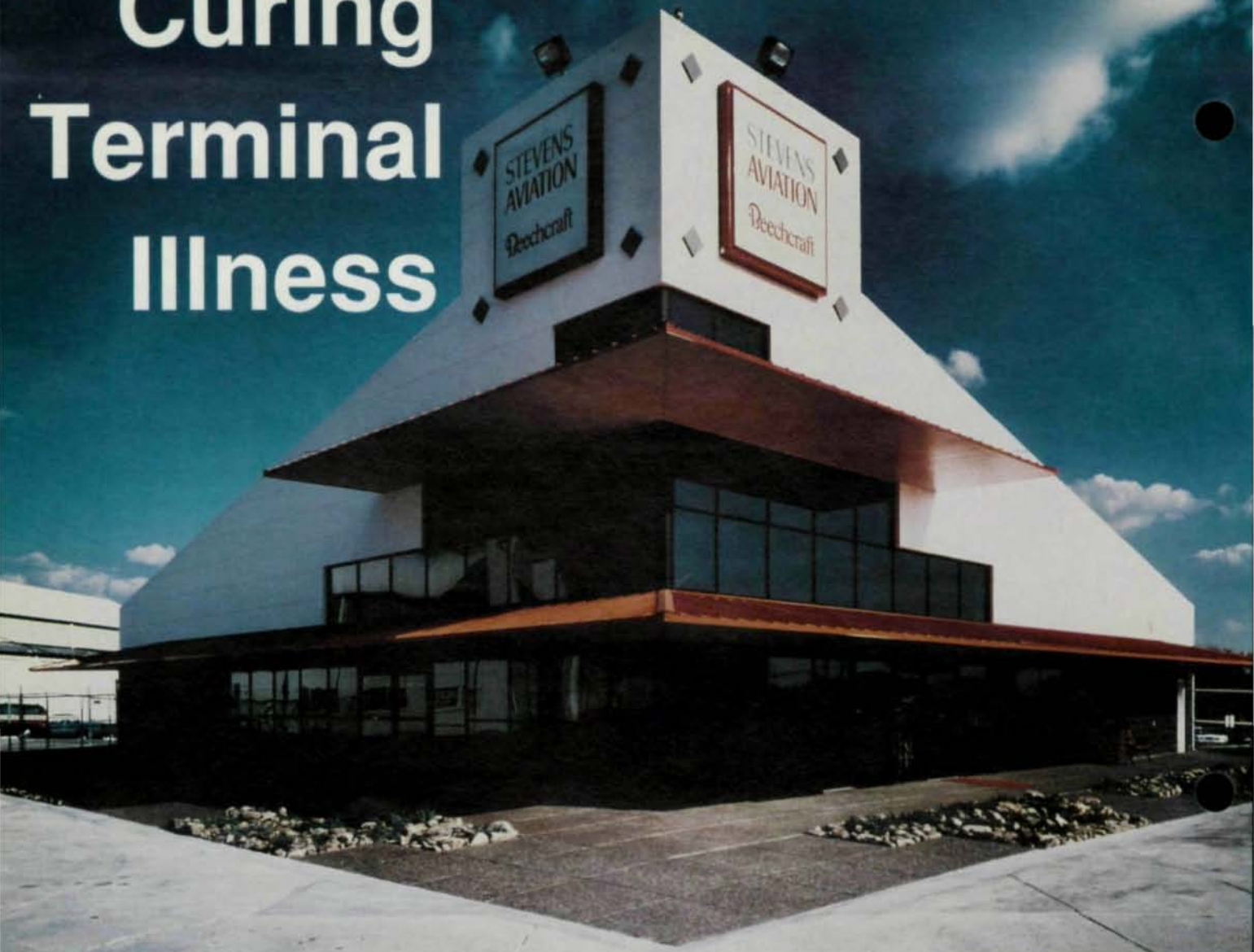

An exciting design was needed to create a high-profile image for a new operator at Nashville's Growing Airport

By Socrates A. Ioannides, P.E.  
and William F. O'Donnell, P.E.



Designing the "cure for terminal illness" was the goal for Steven's Aviation's new corporate aviation center at Nashville International Airport. It needed to be futuristic and high-profile, but at the same had to streamline operations.

The \$750,000 building, which opened in October 1990, provides for the special needs of the pilots and passengers with a state-of-the-art pilots lounge, flight planning room with color radar, pilot's "snooze" room, sales and management offices, and a comfortable conference room. It's designed to "pamper the people who really make corporate travel fly—the pilots." The operations areas flank a large open waiting area that provides a 180° view of the airfield and general aviation runway.

"The key to the efficiency of this design is providing separate pilot and passenger spaces while maintaining direct visual interaction and creating a stream-lined path for passenger flow between automobile and airplane," according to Eric Powers, the building's designer with Edwards + Hotchkiss Architects, Inc., Brentwood, TN. "The exterior dynamics are achieved by using thin floating canopies that provide weather and sun protection and reflect the light floating characteristics of aeronautical design."

### Entrance Canopy

The structural highlight of the 5,400-sq.-ft. facility is a 50' x 50' drive-thru entrance canopy suspended from a single steel column using eight steel rods. To achieve the appearance desired by the architect, the total depth of the canopy was restricted to 24". Special consideration, including a three-dimensional analysis, was given to providing redundancy in the structure to ensure the canopy would remain serviceable, even if one of the rods failed.

The canopy is framed using eight W14 beams that extend radially out from the central column. The beams are connected to the

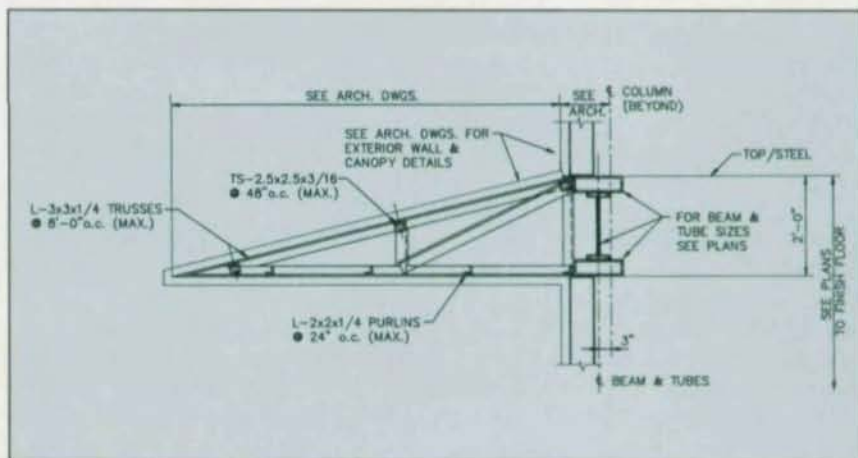

A series of "eyebrow" canopies provide protection from the sun and other weather. The canopies are framed using a series of cantilevered trusses spaced at 8' on center with 2½" x 2½" steel tubes spanning between the trusses to support a standing seam roof.

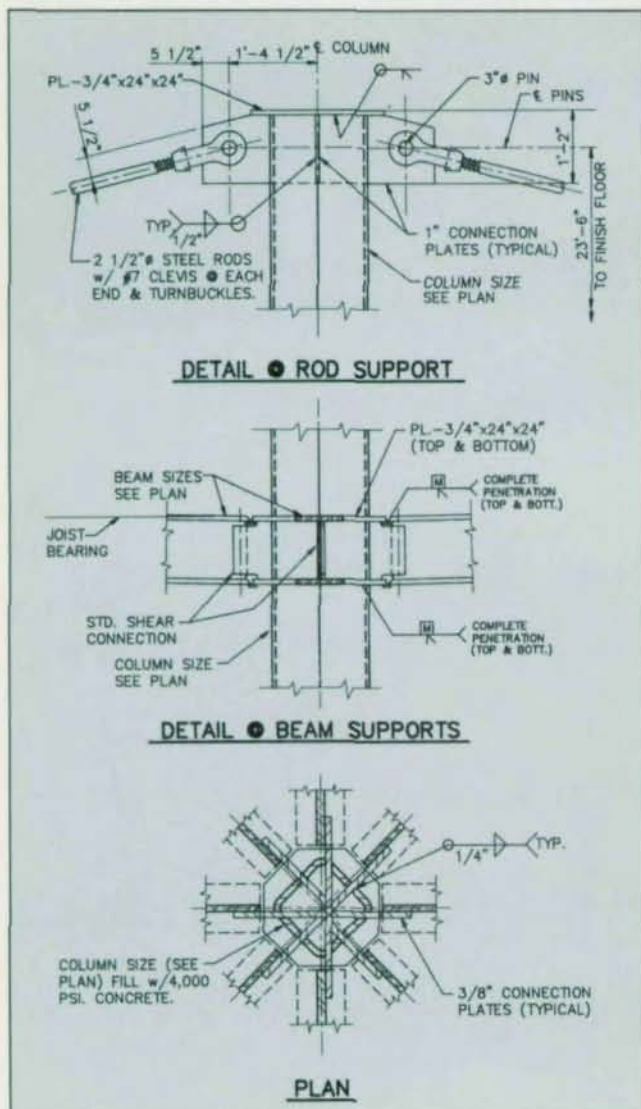

The facility's 50' x 50' drive-thru entrance canopy is suspended from a single steel column by eight steel rods. For architectural reasons, the canopy was limited in depth to 24".

column on one end using full-penetration welded moment connections and are suspended from 2 1/2"-diameter rods on the other end. The beams carry a significant amount of axial load due to the relatively shallow 1-in-4 slope of the tension rods in relation to the radial beams.

The beams behave as propped cantilevers under service load conditions, which allowed shallower beams to be used to meet the depth restraints, while still meeting deflection criteria. If a rod should fail, the beam below the failed rod becomes a cantilever and the continuous edge beams will redistribute load to adjacent beams and rods, providing the redundancy necessary to ensure a

serviceable structure. The center column, a 16" x 16" square tube, was filled with concrete to help reduce deflections due to the unbalanced loading that could be caused by a failed rod.

The remainder of the canopy is framed with steel bar joists of varying lengths spanning between the radial beams. The roof of the canopy consists of an adhered membrane roof over a 3" concrete slab on metal form deck. The concrete slab was used to provide additional dead load to overcome wind uplift and to provide diaphragm stiffness to transfer torsional forces back to the main building structure.

The terminal building, and consequently, the framing, is oriented

on a 45° angle in relation to the general aviation runway, providing 180° visibility of the runway for the ground crew and waiting passengers. Additionally, the skewed building provides more efficient passenger flow as well as increasing the visibility of the structure to passengers arriving both by aircraft and automobile.

The ridge line of the roof runs across corners of the building, perpendicular to the runway, further complicating the framing. The roof system consists of a red standing seam metal roof over rigid insulation and 1 1/2" steel roof deck. The steel roof deck serves as a diaphragm, eliminating the need for bracing in the roof. Additionally, by using the steel deck, the roof

framing was oriented so that the joists could span from the ridge line along the slope of the roof, which simplified and reduced the cost of the framing.

The roof framing consists of steel joists with special seats to accommodate the steep roof slope, bearing on a combination of steel beams and trusses. Steel tubes were used for the columns. Only two interior columns were used to accommodate the open interior of the building.

The exterior wall system consists of a dark-gray split-faced masonry veneer up to 8' with a light-gray exterior insulation finish system on metal studs above 8'. A store-front window system extending to a height of 24' provides the panoramic view of the runway sides of the building. Lateral load resistance is provided by braced frames incorporated into the exterior walls with the framing members strategically located to avoid the window and

door openings.

### Window Canopies

Another interesting element of the structure is a series of "eyebrow" canopies located over the windows on the runway side that provide protection from the sun and weather. The canopies are 2' in depth at the face of the building and taper to a point at the end of the 8' cantilevered length. The canopies are framed using a series of cantilevered trusses spaced at 8' on center with 2½" x 2½" steel tubes spanning between the trusses to support the standing seam roof deck.

Since the interior of the building is open, kickers could not be used to resist torsional loads induced by the cantilevered canopies. This problem was solved by sandwiching a W16 beam between two horizontal 12" x 4" steel tubes. The beam and tube assembly resists torsion from the canopies, supports

gravity loads due to the wall and window systems, resists wind load and jet blast pressures, and serves as an integral part of the braced frames that provide lateral load resistance. General contractor on the project was BACAR Constructors, Inc., Nashville.

The use of structural steel provided the flexibility to create this unique building, while the team concept provided the avenue for creating an efficient, economical and attractive structure.

*Socrates A. Ioannides is president of Structural Affiliates International, Inc., Nashville. He is a registered professional engineer in 17 states, a member of AISC, ASCE and the Structural Stability Research Council. Also, he serves as an adjunct professor at Vanderbilt University. William F. O'Donnell is a structural engineer at Structural Affiliates International, Inc. He is a registered professional engineer in Tennessee and a member of ASCE.*

## THIS IS WHAT IT TAKES TO BE A BOLT MANUFACTURER IN THE 1990s:

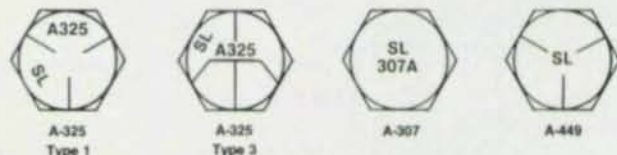

Registered Head Markings on all structural and machine bolts from ½" to 3" diameter, all lengths



Countersunk



Bent anchor

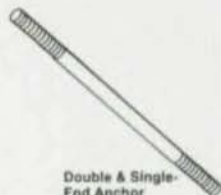

Double & Single-End Anchor



Swedge Anchor

Special Products from ½" to 3" diameter

- U.S. made steel
- Wide-range manufacturing capabilities
- Weathering steel: CORTEN X
- Guaranteed full traceability
- In-house lab testing
- Certification



SINCE  
1887

### ST. LOUIS SCREW & BOLT COMPANY

6901 N. Broadway/St. Louis, MO 63147/(314) 389-7500



FAX, (314) 389-7510  
Toll Free, 1-800-237-7059



# Giant Clear Span For Jumbo Jets

A 412' clearspan was needed to create a hangar big enough for three planes at once

By Ron Younker, P.E.

As a result of increased air travel out of the Indianapolis International Airport in the late 1980s, the Indianapolis Airport Authority decided to build additional east/west runways. However, a USAir maintenance facility stood in the way of a needed connectionway between the new runways.

Fortunately, this proved a blessing-in-disguise, as USAir was able to replace its 1940s building with a larger, more modern facility.

The new structure is a three-bay maintenance hangar featuring a 412' clearspan and is large enough to simultaneously park a 767-300 and two MD-80s inside. Hangar space totals 89,000 sq. ft., with other uses adding another 51,000 sq. ft.

The geometry and framing of the hangar can best be described as "large scale, but simple." Although truss member loads and connections were large, the design approach was to keep connections as simple as possible and pay particular attention to areas with differential rigidities and corresponding deflections. Connections were simplified by using repetitive, conventional details, which simplified fabrication and erection.

The maintenance complex is designed for 75 mph winds, 20 lbs. per sq. ft. snow loads, and Seismic Zone 1 criteria. Work on contract drawings began in February 1989 and project completion is scheduled for Spring 1991.

A study was made to determine the most efficient structural framing arrangement for the hangar.



USAir Maintenance Facility  
Indianapolis, Indiana

*The new USAir Maintenance Facility at Indianapolis International Airport features a 412' clearspan and is large enough to hold three large aircraft aircraft. Grade 50 steel was used on the project both for its cost advantages and for the reduction in weight it can provide compared with A36 steel.*



Concepts included: a "super" truss at the front of the hanger with transverse roof trusses; long-span trusses as rigid frames; and a space structure.

The long-span concept was chosen for economics and ease of constructability. It required smaller lifts and less complicated placement for erection.

The hanger structure's column free area is approximately 211' x 412' in plan. The structure consists of eight 412'-long Pratt trusses. The trusses are attached at the top and bottom chord levels to 36"-deep wide flange columns forming long-span rigid frames. These frames are interconnected with conventional bottom chord plan bracing and sway frame bracing between trusses to stabilize truss top chords. Vertical bracing in the side walls transfer north/south loads to the foundations. Hangar roof trusses are 26½' deep along the eave of the structure and 32' deep at the truss centerline (ridge). Building height is 99' at the ridge.

The rigid frames/trusses were analyzed using a planar (two-dimensional) model, as was the interaction between individual frames and the hangar backwall for lateral loading parallel to frames (east-west). Hangar columns were modeled with partial base fixity to account for the 36" column bases. Columns and base details were designed for 25% maximum base fixity.

The non-hanger area is conventional post and beam construction with an eave height of 26'.

Steel erector was AISC-member Derr Construction Co.

### 2,200 Tons Of Steel

Hangar truss members are all 14"-deep wide flange sections with the weak axis oriented horizontally to simplify connections. Individual trusses weigh more than 100 tons each and the total structure used more than 2,200 tons of structural steel. Wide flange shapes were used for all truss members, which simplified connections for easier fabrication and erection.



*The hanger's structure consists of eight 412'-long Pratt trusses, with a depth of 26½' along the eave and 32' at the truss centerline.*

Maximum truss camber for dead load is 12½" and maximum truss deflection due to uniform roof liveload is 5½". Except for roof and side wall struts and sway frame bracing, all structural steel in the hangar, including connections angles and plates, is A572 Grade 50. Grade 50 steel was selected for the hangar because of the cost advantage and reduction in weight it provides. Truss dead load was reduced by approximately 15% by using Grade 50 steel with cost savings realized from reduced tonnage for fabrication, shipping and erection.

Connections were designed by the engineer, which provided continuity in design throughout the structure and reduced the time required for shop drawing review. Truss constructions were scheduled by joint on the design drawings (see figures 1 and 2).

The largest member size used in the hangar roof truss top and bottom chord members was W14 x 193. Although these sections are not classified as "jumbo" sections, all truss connections still were slip-critical field bolted with 1" diameter A490 bolts. Field bolting eliminated additional concerns—such as toughness requirements, preheat and inspection requirements—for welding of the heavy sections.

Maximum design chord loads were approximately 1,300 kips.

The non-hanger areas used A36 steel. The slip-critical connections in that area were made with ¾" diameter A325 bolts.

For the entire project, the erector opted to use tension control fasteners.

### Vertical And Horizontal Considerations

The structures back wall presented both vertical as well as horizontal design considerations. The truss at the adjacent frame can deflect up to 7½" due to different live load conditions, while the support steel at the back wall columns will see no deflection. Actual pinned connections were used in the last bay (back wall to first truss) to accommodate these differential deflections. Two bays of vertical bracing allows the back wall to be much stiffer than the individual rigid frames.

Crane runways extend to the back wall, but are directly supported only from hangar roof trusses. Calculated horizontal and vertical deflections at the roof level are provided on the contract drawings to aid in the design of crane runway and roofing systems. The hangar roof supports a 5 ton and a 10 ton crane. Three work platforms,

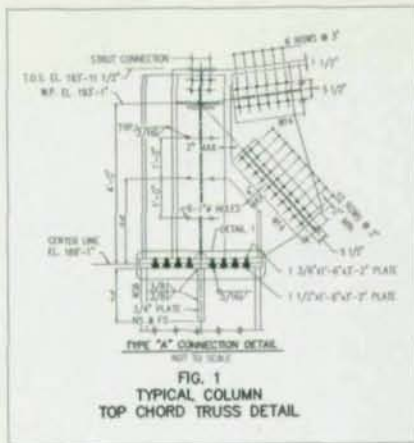

End sections of the truss were set at the columns by simultaneously lowering the top chord detail onto the column cap plate while guiding the truss bottom chord end member inside connecting gusset plates on the W36 column.

supported at the bottom chord level of the hangar roof trusses, provide mechanical and electrical services.

Hangar roof trusses were field bolted with the longest chord sections approximately two panels (55') long. The erector opted to assemble the trusses in three sections. The first section of each truss was lifted and stabbed at the W36 column chord connections. End

sections were set at the columns by simultaneously lowering the top chord detail onto the column cap plate while guiding the truss bottom chord end member inside connecting gusset plates on the W36 columns.

The center section and other end section were then lifted, positioned, and supported on two shoring towers per truss. The shoring towers were removed sequentially

after the erection of at least three adjacent trusses.

Hangar truss deflections were measured after the shoring towers were removed and joists and roof liner panel were placed. Truss centerline elevations were approximately 2" above theoretical elevation. This differential was reduced after placement of the total roof system, catwalks, piping and crane support steel.

# T.S.® Bolts & Tools

**I.C.B.O. Listed**  
Full range of certified A325 and A490 bolts and complete complement of tools for installation, including "Tone" tools and the new TSW 60LC high speed, swivel head tool.

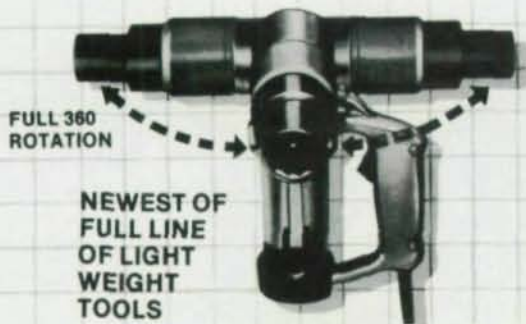
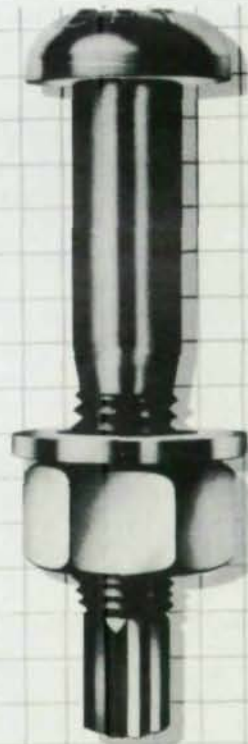

**BRISTOL** MACHINE COMPANY

Construction Fastener  
Systems Division

After the end sections were put in place, the center section and other end section were then lifted, positioned and supported on two shoring towers per truss. The shoring towers were removed sequentially after the erection of at least three other trusses.

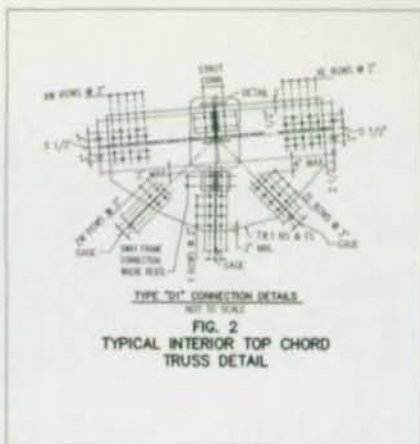

Steel detailing was completed over a scheduled period of 14 weeks. The hangar trusses were the longest for which the steel detailer had ever contracted.

The building is sided with 22 gage preformed metal panel, 26 gage liner panel and 2" glass fiber batt insulation with vinyl backing. To reduce radar interference, non-metallic siding (fiberglass reinforced panels) is required at the

north elevation, which includes the hanger doors. The roof system is a standing seam metal roof over a 26 gage liner panel and 1 3/4" rigid insulation with vapor barrier.

Hanger doors consist of eight electrically powered independently operated leaves. The doors provide a 62'-high opening. Door leaves are supported on embedded rails at finish floor elevation and are supported on embedded rails at finish

floor elevation and laterally at the top by telescoping roller guides.

When USAir occupies the structure this spring, more than 200 maintenance personnel will work inside a sheltered environment supported by extremely long-span steel trussed frames.

Ron Younker, P.E., is a structural engineer with Burns & McDonnell, a Kansas City-based engineering/architecture firm.

# WE KNOW SOME OF YOUR COMPETITORS WHO ARE PRODUCING SHOP DRAWINGS 10 TIMES FASTER THAN IS POSSIBLE FOR YOU

Call 1-800-456-7875  
to receive our free brochure and video explaining how.

STEELCAD INTERNATIONAL • 200 E. ROBINSON ST. • SUITE 250 • ORLANDO, FLORIDA 32801

# Train Tracks Detour Building's Foundation

Building over train tracks meant that the southwest corner of an otherwise ideally located site was inaccessible for foundation placements

By Charles Anderson, AIA, S.E.,  
and John Karabatsos, S.E.

While the site of the new Morton International Building in Chicago was ideal for leasing, it created numerous headaches structurally. After careful consideration, the engineers designed a steel-framed building set upon a concrete platform and utilizing a modified tube structure. For lateral load resistance, numerous transfers occur throughout the structure to facilitate design considerations and site constraints.

General program requirements from the building's owner, Rubloff, Inc., consisted of a 36-story building containing approximately 700,000 sq. ft. of rentable office space and 20,000-25,000 sq. ft. of retail space with 9'-high ceilings.

The lower floors would utilize the entire site, providing 42,000 sq. ft. plans ideally suited for data center operations. In addition, Rubloff specified that the floors intended for data center use would have heavier-than-normal live load capacity and electrical and HVAC loads, and 15' floor-to-ceiling heights to accommodate an anticipated 2' raised-access computer floor.

## Air-Rights Site

The building's site at 100 N. Riverside on the edge of Chicago's downtown area is bordered by a roadway to the north, a bridge to the south, a cantilevered roadway

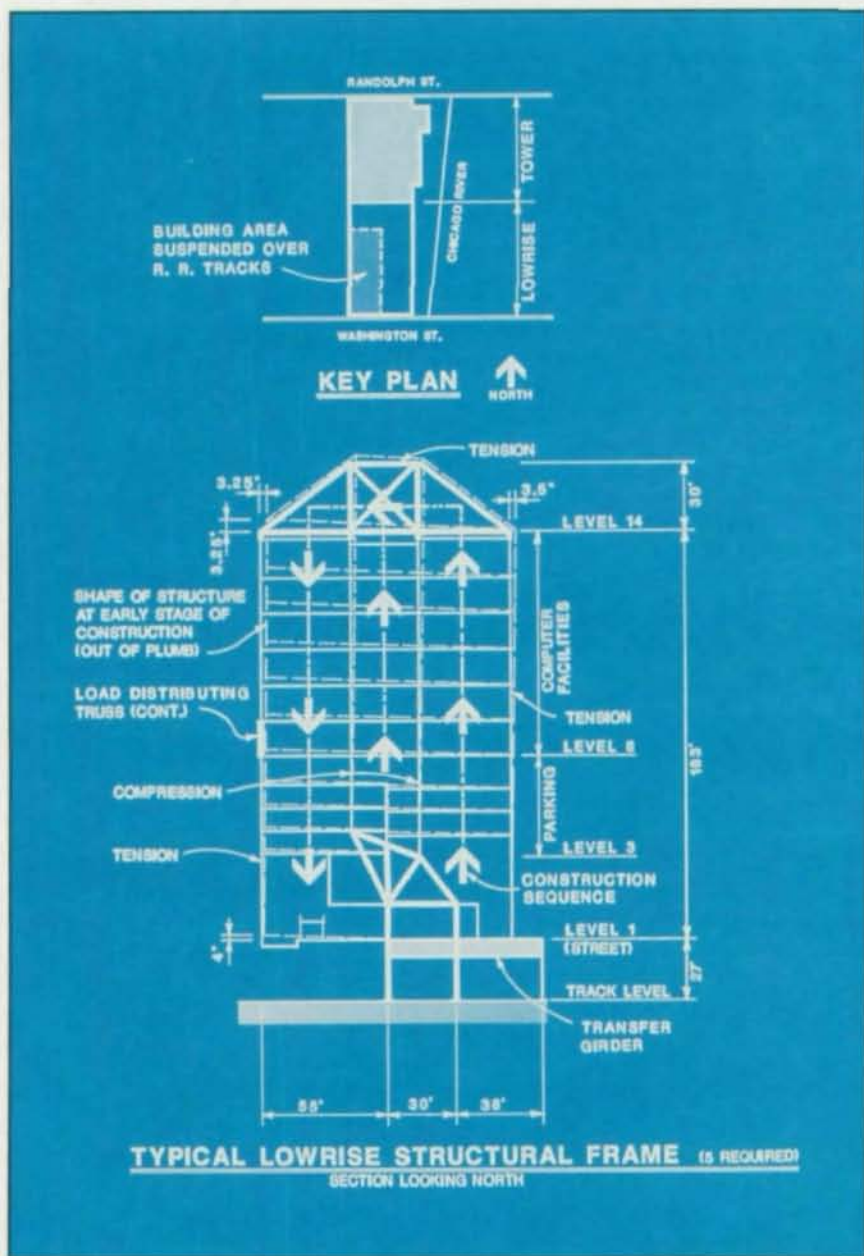
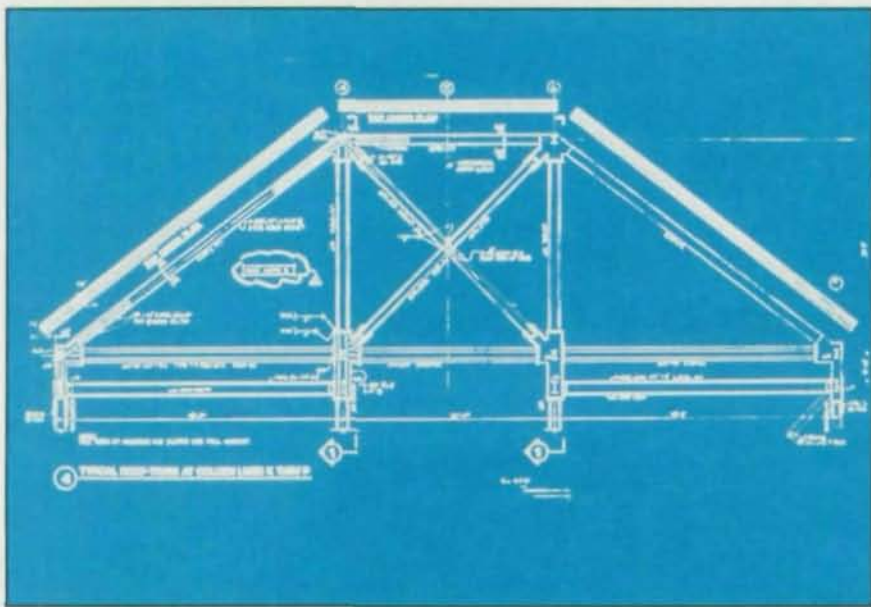

Photo opposite by Gregory Murphey







The truss members are built up from standard structural shapes and plates, with the major truss members built up from six 4" x 24" plates. The bolted connections are made with 1 3/8"-diameter ASTM A490 bolts and special paint was used to increase friction between the plates at the connections. Truss photo by McShane & Fleming Studio

to the west, and a City park and the Chicago River to the east. Additionally, it's an air rights site located above the active Metra and Amtrack Railroad tracks, which lead to nearby Union Station, a major commuter rail station. The air rights site lease included a caisson location diagram that depicted the only allowable locations for the building to touch the ground.

The site provided numerous advantages for leasability, including: proximity to major commuter rail stations; a prime location in an economically expanding area; and an enviable view of the Chicago River.

### Site Constraints

The site, however, also posed several problems. Readily apparent from the caisson location diagram and the railroad track layout was that the southwest corner of the site is inaccessible for foundation placements. At this location, the tracks curve and switch to make their final alignment to the station. In accordance with published railroad safety clearance requirements, there wasn't room for even the smallest foundation or supporting column in the southwest corner of the site.

The second foundation problem was that due to the multiple tracks, switches, and signal lines, a grade beam system tying the individual caissons together could not be installed. Since the building is on an air rights site, conditions precluded building a basement. This required the caissons to transmit all lateral wind loads from the structure to the soil.

Soil borings indicated that a caisson system typical for Chicago could be constructed. In this particular system, foundations extend to the hardpan soil layer (approximately 70' below existing grade), at which point the caisson is bell-shaped to allow bearing of the vertical loads. Based on recommendations made by the owner's soil consultant, STS, Northbrook, IL, lateral loads were resisted through the passive pressure of the soil. The structural engineers analytically

modelled the caisson shafts using horizontal springs to simulate the elastic spring constant of the soil. The first tier of concrete columns and the first floor slab were also modelled. Lateral wind loads were applied from all directions to the first floor slab. These were very complex loading patterns due to the building's asymmetry. Caisson diameters as well as the elastic properties of the soil springs were adjusted to limit the maximum caisson drift to less than  $\frac{1}{12}$ ".

Due to the inability to place foundations in the southwest corner, initial schemes for the parking levels and the data center floor plates had a notch in the corner. However, this open area resulted in restricted and narrow floor plans, creating awkward space for planning a data center, and especially for planning a parking garage.

During this time, a prospective data center tenant indicated that he would only be interested in the building if the notch were filled. An interior truss system was considered to fill in the notch, but was eventually rejected due to the disadvantage in space planning for the parking facilities and data center created by having large sloping columns running through the building.

### Exterior Overhead Truss

However, from these analyses emerged the concept for an exterior overhead truss.

The earliest designs for the overhead truss envisioned the use of cables similar to a suspension bridge. Unfortunately, discussions between the general contractor, Schal Associates, Inc., Chicago, and the structural engineers concluded that the connections of the cable members would be difficult.

It was then determined that the trusses should be built up from standard structural shapes and plates. Bolts were used for all tension connections and welding for compressive connections. The major truss members are built up from six 4" x 24" plates. The bolted connections are made with 1 $\frac{3}{8}$ "-di-

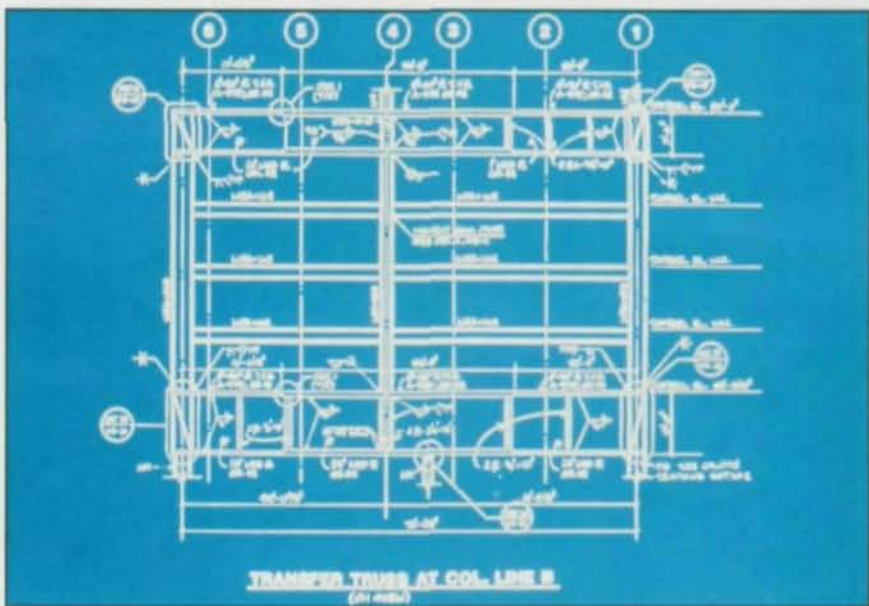

The building's transfer system consists of two 10'-deep plate girders, one at Level 2 and one at Level 8. Vertical and horizontal members between the girders are fully welded, forming a six-story deep vierendeel truss. Photo by McShane & Fleming Studio



Shown above is the construction of the trusses and connections. Photo by McShane & Fleming Studio

iameter ASTM 490 bolts. Special paint was used to increase friction between the plates at the connections.

Typical connection knuckles were prefabricated and erected. These knuckles were used for both the overhead trusses and for the lower trusses near Level 1. The knuckles in compression were built up from four 6"-thick plates welded together. Vibratory stress relaxation techniques were used on the steel plates to minimize stress fractures and lamellar tearing of the plates during welding.

Analysis of many load combinations indicated that the entire vertical load be carried by the center columns. This compressive load of some 4,000 tons was transmitted to the platform through 13"-thick base plates. The easternmost columns under certain load conditions had a tendency to have uplift. To resolve that problem, the

columns were anchored with 3"-diameter, 9'-long anchor bolts. The concrete columns and caissons below also were designed and detailed for tensile forces.

#### Unbalanced Floor Loads

The overhead trusses cantilever 55' and suspend 14 floors of data center and parking garage operations. Due to the unbalanced load condition created by the suspended floors, the vertical frames that support the overhead trusses were designed as cantilevered frames.

The construction sequence of the frame was to build it  $3\frac{1}{2}$ " out of plumb, towards the river. As the overhead trusses and floor structure were suspended on the west, the unbalanced loads caused the vertical frames to drift into a vertical plumb condition under dead load and partial live load.

During construction, column

## New Domestic Bolts... At The Head Of The Class!



FOR INFORMATION CALL 1-800-782-4544

**LSF**™ LOHR Structural Fasteners, Inc.



shafts were assembled on the ground and put into place by a crane. Once the hanging columns were in place, the floors were erected from the ground up—no different than a normal construction sequence. This construction sequence afforded safety for the construction crews by placing the floor decking below. Also, the trains were protected from potential falling objects.

To equalize deflections and minimize differential movement, a load distributing truss was installed in the north-south direction at Level 8 between the suspended columns.

This distribution truss served two purposes: First, it equalized and distributed loads to the overhead trusses; and second, it transferred the load to adjacent overhead trusses in the unlikely event of a single overhead truss failure. Each of the overhead trusses has

redundant capacity and is capable of supporting the loads of an adjacent truss. The overhead trusses and the lower level trusses are supported by a transfer girder system at the Level, which is the level of the adjacent street bridges.

#### Transfer System

The east portion of this Level 1 transfer system includes 7'-6"-deep concrete girders spanning east-west. The girders are spaced 30' on center in the north-south direction. Concrete columns extend from the caissons to the underside of the concrete girders. The east-west spacing of these columns varies and is governed by accessible locations between the active railroad tracks.

The platform is part of the diesel exhaust system, which has a cement plaster ceiling suspended below it. The space between the platform and ceiling is a diesel ex-

haust plenum that is connected to the massive concrete. A benefit of the massive concrete was its ability to dampen vibrations created by the trains. Although the platform is primarily concrete, several spans required the installation of plate girders encased with concrete to carry the imposed loads. A total of 250 tons of structural steel is embedded in the platform.

The platform's western portion is a combination of steel in the southwest portion and concrete in the northwest portion. The north portion of the platform has spans of 65' to 70'. In this area, the concrete was suspended by hangers connected to a six-story steel transfer system above.

This six-story system transfers the 40' core-to-window wall depths for the 36-story office tower to the caisson locations that require spans varying from 65' at the south end of the tower to 72' at the north end. This transfer system consists of two

**You can always  
spot the leader in  
the crowd...  
everyone  
is  
following  
them!**



Dogwood Technologies, Inc. ♦ P.O. Box 52831 ♦ Knoxville, TN 37950-9928  
615-531-4073 • 800-346-0706

If you are watching the computerized detailing marketplace, you can't miss announcements. One company is adding stairs; another, bracing. One is moving their product to Unix and yet another is introducing a "unique" approach allowing a single member or sheet to be detailed independent of the rest of the structure.

And if you are watching the computerized detailing marketplace, you know that these companies are struggling just to catch up. And while they struggle, Dogwood is developing the next generation of detailing system. A system that not only works *for* you...it works *like* you.

**IPIDS** Procedural  
Detailing System

10'-deep plate girders, one at Level 2 and the other at Level 8. Vertical and horizontal members between the girders are fully welded, forming a six-story deep vierendeel truss. These trusses transfer the interior columns from above, which carry loads of approximately 2,500 tons. Hangers were installed from the bottom of this truss to support the loading dock and parking garage ramps below.

Typically, an economical lateral system for a 36-story building would be a braced core. The railroad tracks, however, prohibited the use of that system. Further, there was no way to distribute the concentrated wind loads a braced core to the platform and eventually to the caissons.

Instead, a tube structure, with the exterior columns spaced 15' on center, was selected for the tower of the building. Exterior columns and spandrel beams were fabricated fully welded at the column/beam connection with a shear plate connection and at the mid-span of the beam. These "trees" were fabricated with two-story columns.

Original designs had the perimeter columns spaced 30' on center, but subsequent design modifications and owner concessions allowed the structural design to have 15' on center spacing. This modification reduced the quantity of structural steel by more than 1,500 tons.

Including the concrete platform transfer system, there are five major load transfer systems in the project. The building structure contains approximately 11,500 tons of A36 and A572 Grade 50 structural steel and encloses just over 1,030,000 gross sq. ft. Fabricator on the project was AISC-member Pitt-Des Moines, Inc., Melrose Park, IL.

The building, which was completed in mid-year 1990, is now 70% occupied. The project recently received an award for Most Innovative Design of 1990 from the Structural Engineers Association of Illinois.



*In addition to engineering marvels, the Morton International Building features beautiful interior spaces. Photo by Nick Merrick, Hedrich-Blessing*

*Charles Anderson is an Associate Principal and John Karabotsos is a senior project engineer with Perkins & Will, an architecture, engineering, interiors and planning firm headquartered in Chicago, and with offices in New York and Washington.*

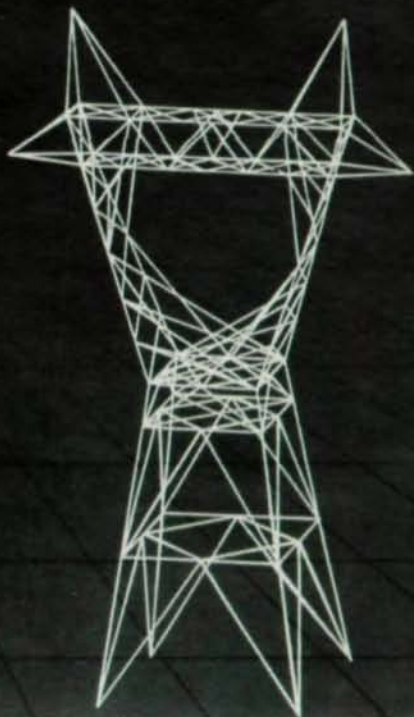
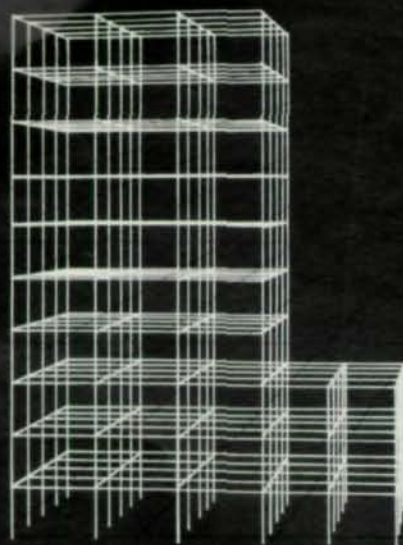

## STAAD-III/ISDS - Ranks #1 in America.

A recent ENR/McGraw Hill survey of the Architectural/Engineering/Construction industry has ranked STAAD-III/ISDS, from Research Engineers, as the #1 structural engineering software in the market today.

The choice of engineers since 1978, STAAD-III/ISDS is being used worldwide as an everyday companion in the design office. The first truly integrated structural engineering software, STAAD-III/ISDS combines geometric layout, analysis, design and drafting in a single software system.



Simple to use, yet sophisticated in application, STAAD-III/ISDS offers the most comprehensive solution to your structural engineering needs. Today, Research Engineers, with six offices in four continents, is setting the structural engineering standard worldwide.

STAAD-III/ISDS - #1 For a Reason.



*Research  
Engineers, Inc.*

A reputation you can build on.

For Information Call: 1-800-833-ISDS

**Main Office:** 540 Lippincott Drive, Marlton, NJ 08053  
Phone: (609) 983-5050 Fax: (609) 983-3825 Telex: 4994385  
**West Coast:** 1592-1A N. Batavia St., Orange, CA 92667  
Phone: (714) 974-1864 Fax: (714) 974-4771

**RESEARCH ENGINEERS WORLDWIDE:**

**UK:** Research Engineers (Europe) Ltd., 19 Lansdowne Court, Brighton Road, Purley Surrey CR8 2BD Phone: (081) 763-1393 Fax: (081) 763-1379 Telex: 929181  
**France:** Research Engineers, 18 rue de Moresville, 28800 FLACEY Phone: 37.47.51.63 Fax: 37.47.44.63

**W. Germany:** Research Engineers, Wilhelm-Busch-Str.23, 6140 BENSHEIM 3 AUERBACH Phone: 06251/79577 Fax: 06251/75437  
**India:** Research Engineers Pvt. Ltd. 40 B Darga Road, Calcutta 700 017 Phone: 448914 Telex: 214102



# Gym Infill Requires Structural Strengthening



## The 73,000-sq.-ft. Denver Place Athletic Center is partially built on top of an existing pedestrian bridge

By Ben Nelson, P.E.

The past decade has seen radical changes in the construction climate of metropolitan Denver. During the oil boom of the early 1980s, development occurred as fast as structures could be built. But when the energy bust hit, construction screeched to a halt.

Today, with a recently completed convention center, design underway on a new airport (for more information, see the upcoming April 1991 issue of MSC), and a rebuilding economy, the city is poised to make a commercial and retail comeback. Included in this resurgence is the Denver Place Athletic Center.

The Athletic Center is part of the Denver Place Complex, a mixed-use development encompassing two city blocks in the downtown area and owned by Amerimar Realty Company, Denver. The development contains nearly 1.5 million sq. ft. in three office towers, an apartment/hotel tower, a hotel conference center, and underground parking. The 73,000-sq.-ft. Athletic Center is the latest addition to the complex and infills a portion of the existing courtyard and also "piggybacks" on top of an existing pedestrian bridge spanning Curtis Street.

Completed last spring, the \$5.6 million Athletic Center houses a gym, racquetball and squash courts, swimming and whirlpools, locker rooms, aerobics facilities, and administrative offices.

The five previously existing structures of Denver Place presented an extremely tight site on which to build the new center. When the architect, Murata Out-

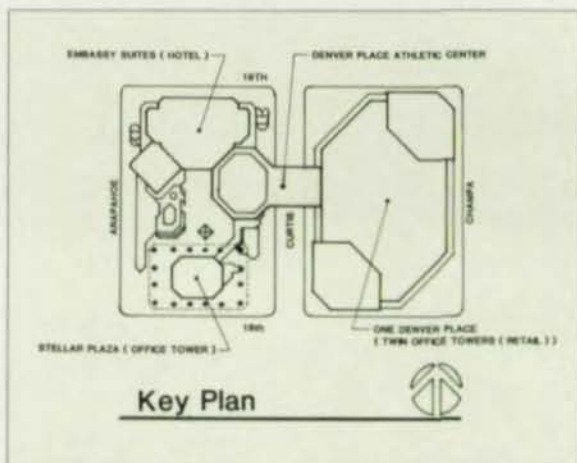
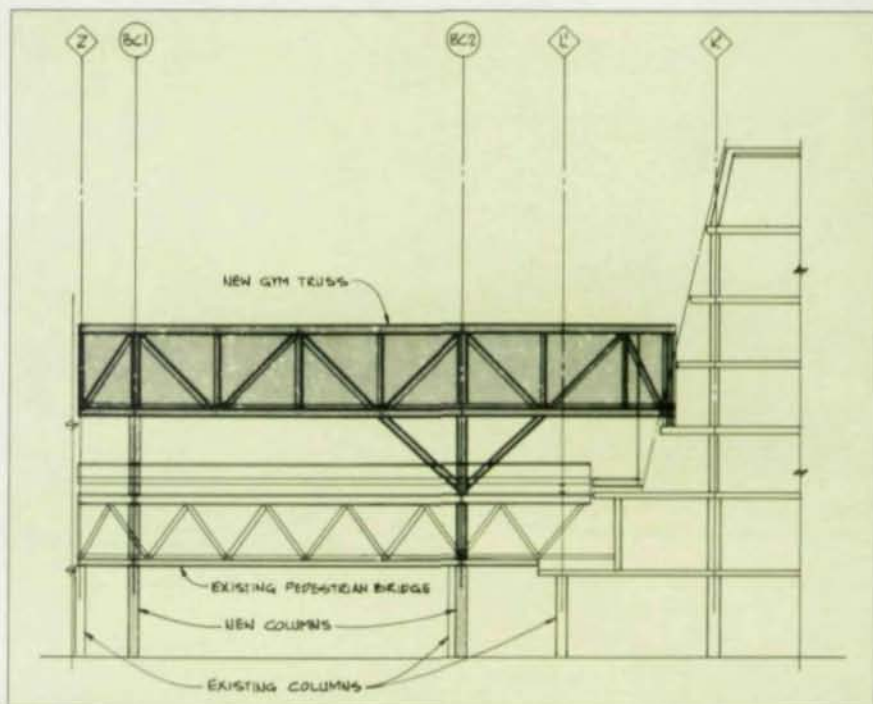

*The Denver Athletic Center is built, in part, on top of a pre-existing pedestrian bridge.*

land Associates, Inc., Denver, first studied the site, they suggested placing a portion of the project within the existing courtyard, thus providing approximately 50,000 sq. ft. of the 73,000 sq. ft. required to house the project's functions.

The remaining needed space was gained by building a second level on top of an existing pedestrian bridge that links the complex's two city blocks. Fortunately, the city granted approval for the use of 23,000-sq.-ft. of the public right-of-way space.

Since the new structure would be supported on existing structural

elements within the overall complex, design alternatives were considered primarily on how they would affect building dead loads.

Composite high strength steel beams with light weight concrete slabs were the obvious choice to minimize the dead load and the strengthening of the existing foundations. Resistance to lateral loads is provided using a combination of conventional steel X and chevron braces. But even with the structure's light weight, cost estimates furnished by the general contractor—Pinkard Construction Company, Lakewood, CO—

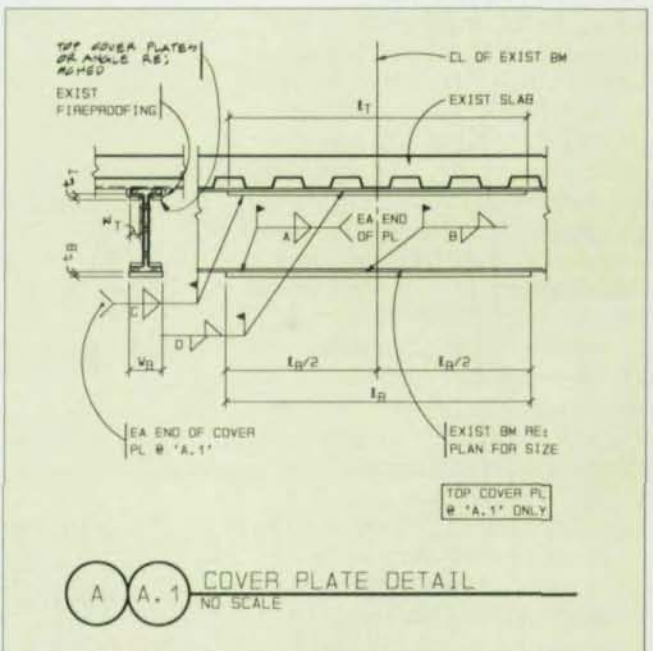
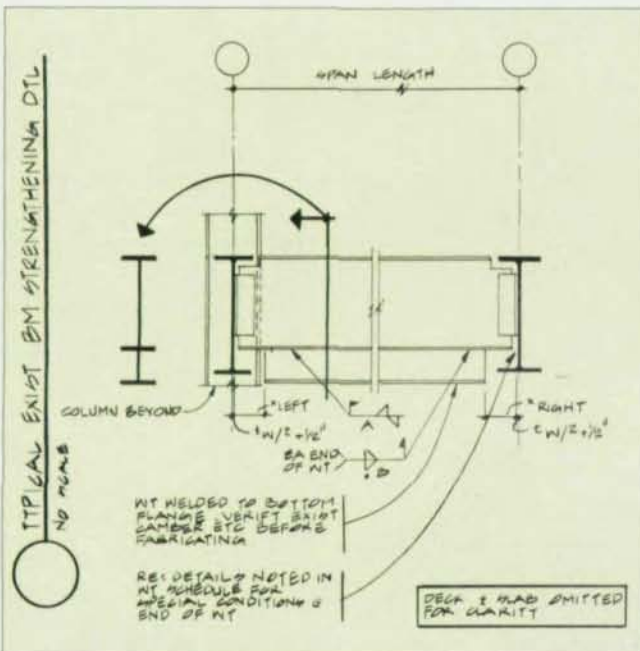
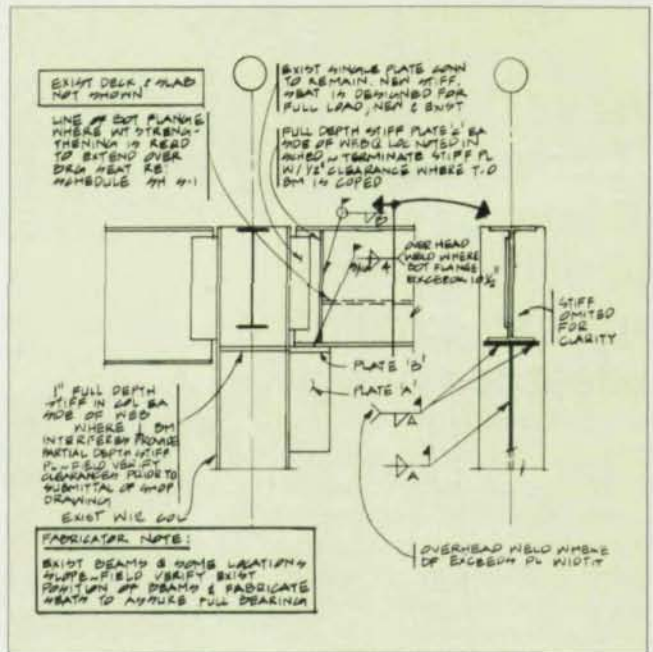
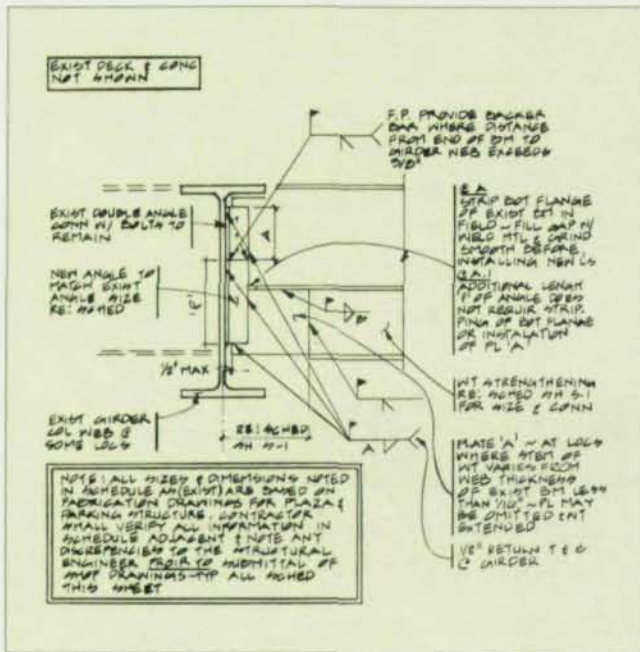

showed that the cost for the structure's three levels was only slightly higher than the cost for strengthening the existing structure to support the addition.

The Athletic Center is supported by four different existing structural systems. These systems include: an elevated outdoor plaza constructed of composite steel beams; a two-way banded post-tensioned concrete flat plate; a cast-in-place concrete pan joist slab; and steel trusses supporting the pedestrian bridge. The primary challenge for

the structural engineer, Martin/Martin, Wheat Ridge, CO, was the significant strengthening of these systems and their connections.

Most of the existing Denver Complex elevated plaza is constructed of structural steel beams and columns supported by concrete columns through an underground parking garage and founded on drilled caissons. Much of the new Athletic Center is supported on these existing steel members.

Interior space allocation permit-

ted roughly one-half of the Athletic Center's columns to be aligned with the column grid of the existing structure. The remaining new columns did not align and were supported either by adding new steel transfer members framing into existing floor beams or by strengthening existing members to serve this function. Steel columns that required additional capacity to support the new loadings were fitted with flange and/or web coverplates.

The structural strengthening

needs were two-fold: Much of the existing structure, as well as a majority of existing connections, required significant strength upgrading. Where possible, the existing beams were strengthened using conventional steel coverplating of the bottom flange. The existing concrete columns and caisson foundations were found to have sufficient capacity without strengthening.

The use of bottom flange coverplates only was sufficient in many instances because the existing steel beams were originally designed based on fully composite shear transfer between the beam and concrete slab. The coverplate essentially "balances" the concrete compression flange. Other floor beams supporting higher loads required strengthening beyond what an economical cover plate could provide. In these situations, a steel "T" (WT) section was welded to the beam bottom flange to provide the necessary capacity.

The strengthening of existing connections was much more difficult, particularly for existing beams supporting new columns. These transfer beams required connections of almost double their original capacity. A variety of connection strengthening techniques were used including addition of stiffened seats, knife (shear) plates, and extending the length of existing double angle connections.

Structural steel also provided an economical solution for the support of the new swimming and whirlpools above an existing concrete floor structure that did not have sufficient capacity to carry these heavy loads. The new pools were supported with a steel grid bearing on the concrete floor only near existing columns, thus eliminating the need for expensive concrete strengthening. A new steel truss also was added to support plaza structure where two existing steel columns needed to be removed to permit an increased lap-pool width.

The Athletic Center's gym floor is a double structure supported on coverplated roof beams of the existing enclosed pedestrian bridge. The gym is constructed of steel bar joists supported by a pair of new



*Steel erection was complicated by tight working conditions. Shown is the topping out of the new bridge trusses "piggybacking" the existing elevated pedestrian bridge.*

15'-deep trusses spanning 90' parallel to and above the bridge.

The erection of the large trusses required the closing of a major downtown street and careful construction coordination.

Four new steel columns and caisson foundations were added to support the gym roof trusses, a most difficult task considering the below grade congestion of existing building foundations and site utilities.

The project challenged the design team with its complexity due

to the tight site and numerous locations requiring structural modification. Steel's flexibility—both in its ability to be readily strengthened and its light weight—resulted in substantial cost savings for the owner. Through the cooperation and coordination of the entire project team the structure was built economically, on a short schedule, and with limited field problems.

*Ben Nelson, P.E., is a project engineer with Martin/Martin, Inc., Consulting Engineers, Wheat Ridge, CO.*

# UPDATED COMPREHENSIVE DIAPHRAGM DESIGN MANUAL



SECOND  
EDITION

A reference source that  
contains the answers to all  
of your questions!

**FOR PRACTICING  
ENGINEERS & ARCHITECTS!**

*Organized For Easy Use/Explicitly Illustrated*

## EASY REFERENCE TO

- Diaphragm Strength
- Diaphragm Stiffness
- Connections
- Concrete Filled Diaphragms
- 62 Pages Filled with Shear Diaphragm Examples
- Complete Guide to Symbols and References
- Complete set of Load Tables for Typical Panel Configurations and Connector Types
- Typical Fastener Layout
- Warping Factor Development
- D-Values for Warping



**DON'T DELAY—ORDER YOURS TODAY!**

Send checks; postal, world money orders, drafts, in U.S. currency.

### Quantity

_____ 2ND. EDITION DIAPHRAGM DESIGN MANUAL, \$45.00 ea.	_____
_____ 1st. Edition Diaphragm Design Manual, \$30.00 ea.	_____
_____ Steel Deck Design Manual, \$11.00 ea.	_____
_____ US Currency Total	_____
_____ Out of USA surcharge, 10%	_____
_____ Add on for Airmail	_____
_____ Total Enclosed	_____

**STEEL DECK INSTITUTE, INC.**

P.O. BOX 9506, CANTON, OHIO 44711 ■ (216) 493-7886

## T C Bolt Supply Co., Inc.

A new brochure describes installation procedures, mechanical requirements, fastener tension requirements, shapes and dimensions, and weights of the companies line of high-strength, tension control bolts. Also included is a chart for determining bolt length. Other products include: swaged anchors; double expansion shields; threaded and plain cinch; hook anchors; crane rail anchors; hook anchors; tie rods; cinch drive sleeves; square and round bend U's; self drilling shields; eye bolts; toggle bolts; drift pins; arc weldments; and coupling nuts.

For more information, contact: T C Bolt Supply Co., Inc., Forest Road, P.O. Box 197, Greenfield, NH 03047 (603) 547-6371.

## Le Jeune Bolt Co.

The Le Jeune Tension Control Bolting Systems combine a unique high-strength bolt design with a precision delayed-fracture material and are manufactured under strict quality standards. Because tension control is built into the bolts, installation and inspection costs are minimized. Also available are a full line of domestic hex structural bolts. Le Jeune also offers "in-house" mechanical galvanizing on any of the above, to ASTM B695 class 50.

For more information, contact: Le Jeune Bolt Co., 8330 West 220th St., Lakeville, MN 55044-9106 (612) 469-5521 or (800) 872-2658.

## Jos. Dyson & Sons, Inc.

A new bulletin describes fully traceable bolts made in sizes 5/8" through 4" diameters and lengths to 30". These bolts are traceable throughout each step of the manufacturing process from die design and construction through forging, heat treating (Dyson furnaces are calibrated to MIL-H-6875 and MIL-STD-1684A standards), descaling and mechanical testing. The bulletin also details the Dy-

Trace Data-Pac, a document that includes a copy of the original certified mill test report, the mechanical test report, and the Dyson certified test report/compliance and heat charts.

For a free copy, contact: Dy-Trace Bulletin, Jos. Dyson & Sons, Inc., P.O. Box 228, 52 Freedom Road, Painesville, OH 44077 (800) 321-7058.



## Nucor Fastener

Nucor Fastener offers mechanically galvanized fasteners using the most advanced process available. As a result, the fasteners offer maximum corrosion protection, excellent uniformity and no hydrogen embrittlement or detempering. All galvanized products meet or exceed ASTM B695, AASHTO M298 and MIL-C-81562 requirements. All of the steel used in the nuts and bolts comes from Nucor Steel and other domestic steel mills.

For a free brochure, contact: Nucor Fastener, P.O. Box 6100, St. Joe, IN 46785 (800) 334-9397.

## DECO Manufacturing Co.

DECO Adjustable Anchors are machined to exact tolerances and approved according to the most stringent quality assurance standards. The company's column anchor is designed to be installed flush with the foundation. Column

## A 325, A 490 "RAPID TENSION" BOLTS

**A "BOLT" FROM THE RED,  
WHITE AND BLUE.**

American-made **Rapid Tension** structural bolts from NSS, meet the highest industry standards and have the **lot identification** stamped on each and every one of them for complete traceability. **Rapid Tension** bolts from **NSS** are the best bolts you can buy in America... or anywhere else.



**MADE IN THE U.S.A.**

**NSS**  
INDUSTRIES

9075 GENERAL DRIVE  
PLYMOUTH, MI 48170  
313-459-9500  
800-221-5126  
FAX-313-459-4830

Anchor Studs are machined from ASTM A36 hot-rolled steel, yielding a tensile strength of 55,000 lbs. per sq. in. minimum. Couplings are mill-tested, C1144, cold-rolled steel and deliver a minimum yield strength of 90,000 psi.

For more information, contact: DECO Manufacturing Co., 519 East William St., Decatur, IL 62523 (217) 428-4991 or (800) 637-5861.

### Pneutek, Inc.

Three new brochures describe the company's systems for fastening: steel roof and floor deck; steel to concrete; and plywood to structural framing. The system consists of fully-automatic low velocity fastening tools that require no pre-drilling.

For more information, contact:

Pneutek, Inc., 29 Flagstone Dr., Hudson, NH 03051 (603) 883-1660.

### Mid South Bolt and Screw Co., Inc.

The company's line of bolts are roll thread, which tests have shown to be considerably stronger than cut thread. According to a Pittsburgh Testing Laboratory report, when you cut away material, the stock is weakened considerably, whereas when you roll thread the material is compressed and actually strengthened.

For more information, contact: Mid South Bolt and Screw Co., Inc., 499 Cave Road, Nashville, TN 37210-0884 (615) 889-8341.

### TRW Nelson Stud Welding

A new brochure from TRW describes fastening techniques with stud welding. Stud welding is essentially an electric arc welding process with the stud itself serving as the electrode. Included is information about the process of stud welding, composite construction, and retrofitting.

For more information, contact: TRW Nelson Stud Welding Division, Controls and Fasteners Group, 7900 West Ridge Road, P.O. Box 4019, Elyria, OH 44036-2019 (216) 329-0400.

### Struct-Fast, Inc.

Fastening systems from Struct-Fast are designed to fasten to structural steel without welding or drilling. The systems are designed to work with bar, fiberglass, stainless steel or aluminum bar grating and metal floor plate. The company also offers a system for turning a standard A-325 structural bolt into a hook bolt for fastening secondary beams to the primary members without welding or drilling.

For more information, contact: Struct-Fast, Inc., 20 Walnut St., Suite 101, Wellesley Hills, MA 02181 (617) 235-6734.

## CUSTOM TUBULAR SECTIONS

### Tubular Sections Manufactured To Meet Your Specific Shape & Size Requirements

ASTHETICALLY APPEALING

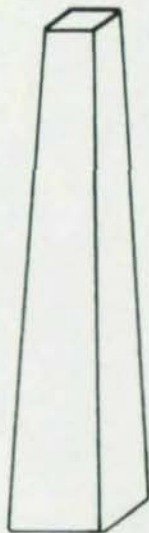

PROPERTIES TAILORED TO SPECIFIC NEEDS

EXCELLENT TORSIONAL PROPERTIES

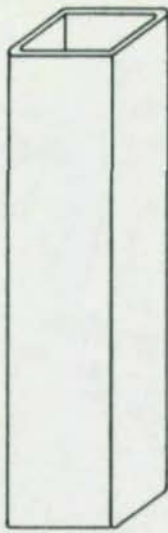

EXCELLENT COLUMN STRENGTH

LARGE SIZES 14" TO 30"

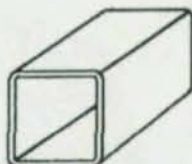

SQUARES

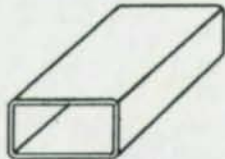

RECTANGLES

HEAVY WALL THICKNESS 3/8" - 1"

- Sizes up to 30" square
- Tapered or straight sections

- Section properties available on request
- No minimum order size

VALMONT TULSA • P.O. BOX 2620 • TULSA, OKLAHOMA 74101  
ATTN. RICK WEITKEMPER • CALL TOLL FREE: 1-800-331-3002

Please send additional information about fabricated tubular sections.

NAME \_\_\_\_\_ TITLE \_\_\_\_\_

FIRM \_\_\_\_\_

ADDRESS \_\_\_\_\_

CITY \_\_\_\_\_ STATE \_\_\_\_\_

PHONE \_\_\_\_\_ ZIP \_\_\_\_\_



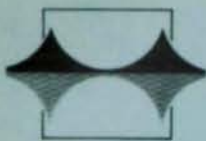

# AISC 1991 Prize Bridge Competition



## Eligibility

To be eligible, a bridge must be built of fabricated structural steel, must be located within the United States (defined as the 50 states, the District of Columbia, and all U.S. territories), and must have been completed and opened to traffic from July 1, 1986 through May 1, 1991.

## Judging Criteria

Will be based primarily upon aesthetics, economics, design and engineering solutions. Quality of presentations, though not a criterion, is important.

## Award Categories

Entries will be judged in one or more categories, but may receive only one award.

**Long Span** One or more spans over 400 ft. in length.

**Medium Span, High Clearance** Vertical clearance of 35 ft. or more with longest span between 125 and 400 ft.

**Medium Span, Low Clearance** Vertical clearance less than 35 ft. with longest span between 125 and 400 ft.

**Short Span** No single span greater than 125 ft. in length.

**Grade Separation** Basic purpose is grade separation.

**Elevated Highway or Viaduct** Five or more spans, crossing one or more traffic lanes.

**Movable Span** Having a movable span.

**Railroad** Principal purpose of carrying a railroad, may be combination, but non-movable.

**Special Purpose** Bridge not identifiable in one of the above categories, including pedestrian, pipeline and airplane.

**Reconstructed** Having undergone major rebuilding.

## Entry Requirements

All entries must contain an entry form, photographs and a written description of the project.

1. *Entry form:* All information requested on the form must be completed in full.
2. *Photographs:* Professional quality 8x10 color prints of various views showing the entire bridge, including abutments. 35 mm slides should also be submitted if available. All photographs must be cleared for use by AISC.
3. *Description:* Explanation of design concept, problems and solutions, aesthetic studies, project economics and any unique or innovative aspect of the project. Include no larger than 11x17 drawings showing elevation, framing system and typical details.

## Method of Presentation

Each entry should be submitted in an 8½" x 11" binder, containing transparent window sleeves for displaying inserts back to back. The entry form included in the brochure must be easily removable, so that the identification of the entry can be concealed during judging. All information requested on the entry form must be included.

## Awards

The winners will be notified shortly after the June judging. Public announcements of the winners will be made in the September issue of *Modern Steel Construction* magazine. Award presentations will be made to the winning designers during the National Steel Bridge Symposium, September 16, 1991, in St. Louis, MO.

## Deadline for Submission

Entries must be postmarked on or before **May 24, 1991**, and addressed to: American Institute of Steel Construction, Inc., Attn: Awards Committee, One East Wacker Drive, Suite 3100, Chicago, IL 60601-2001. For further information, call 312/670-2400.

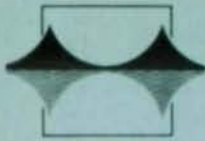

# AISC 1991 Prize Bridge Competition



Entry Date \_\_\_\_\_

Name of Bridge \_\_\_\_\_ Completion Date \_\_\_\_\_

Location \_\_\_\_\_ Date opened to traffic \_\_\_\_\_

Category in which entered \_\_\_\_\_ Approx. total cost \_\_\_\_\_

Span lengths \_\_\_\_\_ Roadway widths \_\_\_\_\_ Steel wt./sq. ft. of deck \_\_\_\_\_

Vertical clearance \_\_\_\_\_ Steel tonnage \_\_\_\_\_ Painted: Yes \_\_\_\_\_ No \_\_\_\_\_

Structural system(s) (describe briefly here) \_\_\_\_\_

Innovative Concepts \_\_\_\_\_

Descriptive data: Attach separate sheets (see entry requirements)

No. of photographs enclosed: Color prints \_\_\_\_\_ 35 mm slides \_\_\_\_\_

---

**Design Firm:** \_\_\_\_\_

Address: \_\_\_\_\_ Phone \_\_\_\_\_

Street: \_\_\_\_\_ City and State \_\_\_\_\_ Zip \_\_\_\_\_

Person to contact: \_\_\_\_\_ Title \_\_\_\_\_

**Consulting Firm (if any):** \_\_\_\_\_

Address: \_\_\_\_\_ Phone \_\_\_\_\_

Street: \_\_\_\_\_ City and State \_\_\_\_\_ Zip \_\_\_\_\_

Person to contact: \_\_\_\_\_ Title \_\_\_\_\_

**General Contracting Firm:** \_\_\_\_\_

Address: \_\_\_\_\_ Phone \_\_\_\_\_

Street: \_\_\_\_\_ City and State \_\_\_\_\_ Zip \_\_\_\_\_

Person to contact: \_\_\_\_\_ Title \_\_\_\_\_

**Steel Fabricating Firm:** \_\_\_\_\_

Address: \_\_\_\_\_ Phone \_\_\_\_\_

Street: \_\_\_\_\_ City and State \_\_\_\_\_ Zip \_\_\_\_\_

Person to contact: \_\_\_\_\_ Title \_\_\_\_\_

**Steel Erecting Firm:** \_\_\_\_\_

Address: \_\_\_\_\_ Phone \_\_\_\_\_

Street: \_\_\_\_\_ City and State \_\_\_\_\_ Zip \_\_\_\_\_

Person to contact: \_\_\_\_\_ Title \_\_\_\_\_

**Owner:** \_\_\_\_\_

Address: \_\_\_\_\_ Phone \_\_\_\_\_

Street: \_\_\_\_\_ City and State \_\_\_\_\_ Zip \_\_\_\_\_

Person to contact: \_\_\_\_\_ Title \_\_\_\_\_

---

This entry submitted by:

Name: \_\_\_\_\_ Title \_\_\_\_\_

Firm: \_\_\_\_\_

Address: \_\_\_\_\_ Phone \_\_\_\_\_

Street: \_\_\_\_\_ City and State \_\_\_\_\_ Zip \_\_\_\_\_



### AISC



Two new 120-page books from

AISC contain design aids for shear connections not previously published. Presented in easy-to-use tabular form, the books include designs for double-angle web bolted connections, structural tee single shear connections and single-angle connections welded to the support. The books are available in both ASD and LRFD formats.

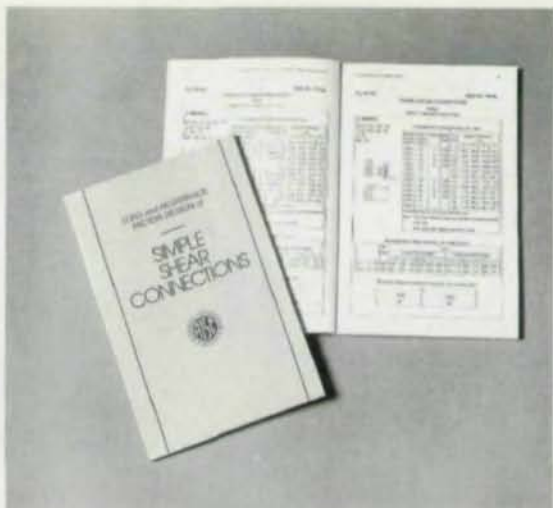

For more information, contact: Publications Dept., AISC, One East Wacker Dr., Suite 3100, Chicago, IL 60601 (312) 670-2400 ext. 433.

### Haydon Bolts

The company manufactures anchor bolts, sag rods, sag bolts, U-bolts, and crane rail anchors. Sizes range from 1/2" to 4" diameters. In addition, Haydon has a complete line of A325, A490, and positive tension shear bolts.

For more information, contact: Haydon Bolts, Adams Ave and Unity St., Philadelphia, PA 19124 (215) 537-8700.

### Bristol Machine Co.

The company offers a full range of certified A325 and A490 bolts and a complete complement of tools for installation, including "tone" tools and the new TSW 60LC high speed, swivel head tool.

For more information, contact: Bristol Machine Co., 630 E. Lambert Road, Brea, CA 92621 (714) 598-8601.



### St. Louis Screw & Bolt Co.

The company makes a full range of structural fasteners, including Types I and III A325 bolts and ASTM A307 bolts. In addition, St. Louis Screw & Bolt will manufacture fasteners to a customer's individual specifications. All materials

are traceable to steel melted and manufactured in the U.S., with each production run traceable to a heat lot of steel. All bolts are certified to meet ASTM specifications.

For more information, contact: St. Louis Screw & Bolt Co., 6900 N. Broadway, St. Louis, MO 63147 (314) 389-7500.

### LOHR Structural Fasteners, Inc.

LOHR's domestic bolts are mill certified, fully assembled and tested, readily available and of the highest quality. The firm produces high-strength fasteners (A325 and A490), as well as tension control, hex head and 2H nuts.

For more information, contact: LOHR Structural Fasteners, Inc., P.O. Box 1387, Humble, TX 77347 (713) 821-3509.

### NSS Industries

American-made Rapid-Tension structural bolts from NSS meet the highest industry standards and have the lot identification stamped on each of them for complete traceability.

For more information, contact: NSS Industries, 9075 General Dr., Plymouth, MI 48170 (313) 459-9500 or (800) 221-5126.

### KOPE-ING

The company with the turnkey answer to your Steel Detailing Needs!

KOPE-ING and Mountain Software LTD have designed a complete system based on Sun platforms, Sun compatibles such as Solburne Computers, as well as 486 and 386 computers using Sun OS, SCO Xenix, and Arris software.

Steel-Pac features include:

- A wide variety of connection types
- Automatic determination and verification of all connectivity relationships
- All standard AISC and CISC materials are supplied
- Over 40 software switches to allow the user to tune the system to their needs
- Direct interface to NC equipment
- Hardware or Software can be purchased separately

For more information call or write:

**KOPE-ING**, 3970 Broadway, Suite 201A, Boulder, CO 80302  
Tel (303) 449-2251  
Fax (303) 444-7656  
*An Authorized Arris Dealer*

### IT IS FUN TO DESIGN STEEL CONNECTIONS

USING

### DESCON

AN EASY TO USE SOFTWARE PACKAGE FOR YOUR PC

25 TYPES OF BEAM TO COLUMN CONNECTIONS, BEAM SPLICES AND BEAM TO GIRDER CONNECTIONS

MOMENT CONNECTIONS  
SHEAR CONNECTIONS  
BOLTED AND WELDED

EXTENSIVE DATA BASE OF SHAPES, MATERIAL PROPERTIES AND SPECIFICATION REQUIREMENTS INCLUDED

FOR INFORMATION CALL OR WRITE TO:

**OMNITECH ASSOCIATES**  
P.O. BOX 7581  
BERKELEY, CA 94707  
415-658-8328

# Advertisers' Index

## A

AISC Prize Bridge Competition ..... 47-48

## B

Bouras, Nicholas J. .... Cover II

Bristol Machine ..... 30

## C

CAST ..... 17

Chapparral ..... 23

Computers & Structures ..... Cover IV

## D

Design Data ..... 22

Dogwood Technologies ..... 37

## E

EJE Industries ..... 22

EPIC Metals ..... Cover III

## K

KOPE-Ing ..... 49

## L

Lohr Fastener ..... 36

## N

NSS Industries ..... 45

Nucor Fastener ..... 7

National Steel Construction Conference ..... 9-11

## O

Omnitech ..... 49

## R

RISA ..... 17

Research Engineers ..... 39

## S

St Louis Screw & Bolt ..... 27

Steelcad ..... 31

Steel Deck Institute ..... 44

Structural Analysis, Inc. .... 17

Structural Software Co. .... 3

## T

TradeARBED ..... 5

## V

Valmont Industries ..... 38

---

For advertising information, contact:

Eric K. Nieman  
Pattis/3M  
7161 North Cicero  
Lincolnwood, IL 60646  
(708) 679-1100  
FAX (708) 679-5926

For advertising information in OK, NE, KS, SD, ND, MN, CA, MT, WY, CO, NM, AZ, UT, ID, WA, OR, HI, AK, and Canada, contact:

Ed Sreniawski  
Pattis/3M  
7161 North Cicero  
Lincolnwood, IL 60646  
(708) 679-1100  
FAX (708) 679-5926

# LONG-SPAN DECK

## THERE'S AN EPIC DECK FOR EVERY SPAN

SCHOOLS  
CANOPIES  
AIRPORTS  
CONVENTION CENTERS  
STADIUMS  
INSTITUTIONS  
AUDITORIUMS  
CHURCHES  
SWIMMING POOLS  
PRISONS  
THEATRES

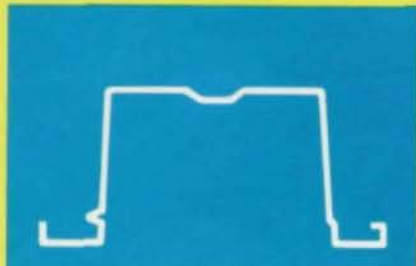

- Provide structural and ceiling material all in one architectural element
- Provides long spans without mid-span fastening
- Wide choice of depths and design thicknesses
- Ideally suited to any type construction
- Presents a uniform ceiling with no irregular gaps
- Design with our acoustical treatment to achieve state-of-the-art solutions to sound control
- Blend control—use acoustic and non-acoustic panels together

### ECONOMY THROUGH SELECTION

- Roof Deck
- Plated Deck
- Composite Deck

### MINIMUM MAINTENANCE

### FAST ERECTION

### THE CHOICE IS YOURS!

FOR INFORMATION, CONTACT

**EPIC**<sup>®</sup>  
METALS CORPORATION

Eleven Talbot Avenue, Rankin PA 15104  
PHONE: 412/351-3913  
FAX: 412/351-2018

# STATE OF THE ART

COMPUTER SOFTWARE FOR  
STRUCTURAL & EARTHQUAKE  
ENGINEERING

Developed by Edward L. Wilson  
& Ashraf Habibullah

CELEBRATING 21 YEARS OF INNOVATION  
SAP90  
1970-1991



Dynamic Analysis



Shell Analysis



Highway Engineering

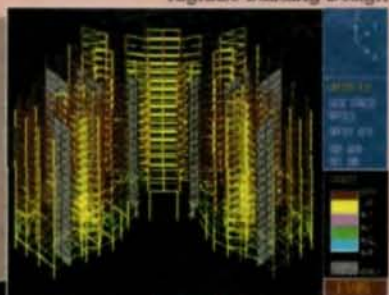

Highrise Building Design

Space Frame Design

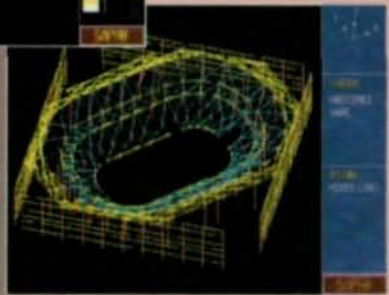

Complex Frame Analysis

**SAP90™**  
General Analysis  
& Design

**ETABS®**  
Building Analysis  
& Design

COMPUTERS &  
STRUCTURES  
INC.  
**CSI**

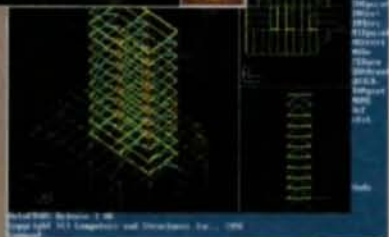
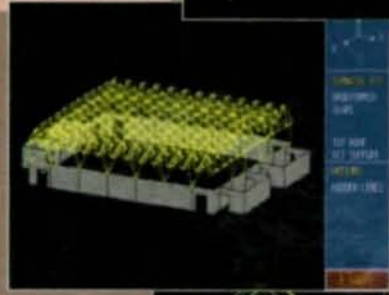

Integration with CAD



Flat Slab Design

Foundation Mat Design



**SAFE™**  
Slab Analysis  
& Design

For more information:

**Computers & Structures, Inc.**  
1995 University Avenue  
Berkeley, California 94704

TEL: (415)845-2177  
FAX: (415) 845-4096  
TWX: 5101003830 CSI BERKELEY