

MODERN STEEL CONSTRUCTION

September 1992

\$3.00

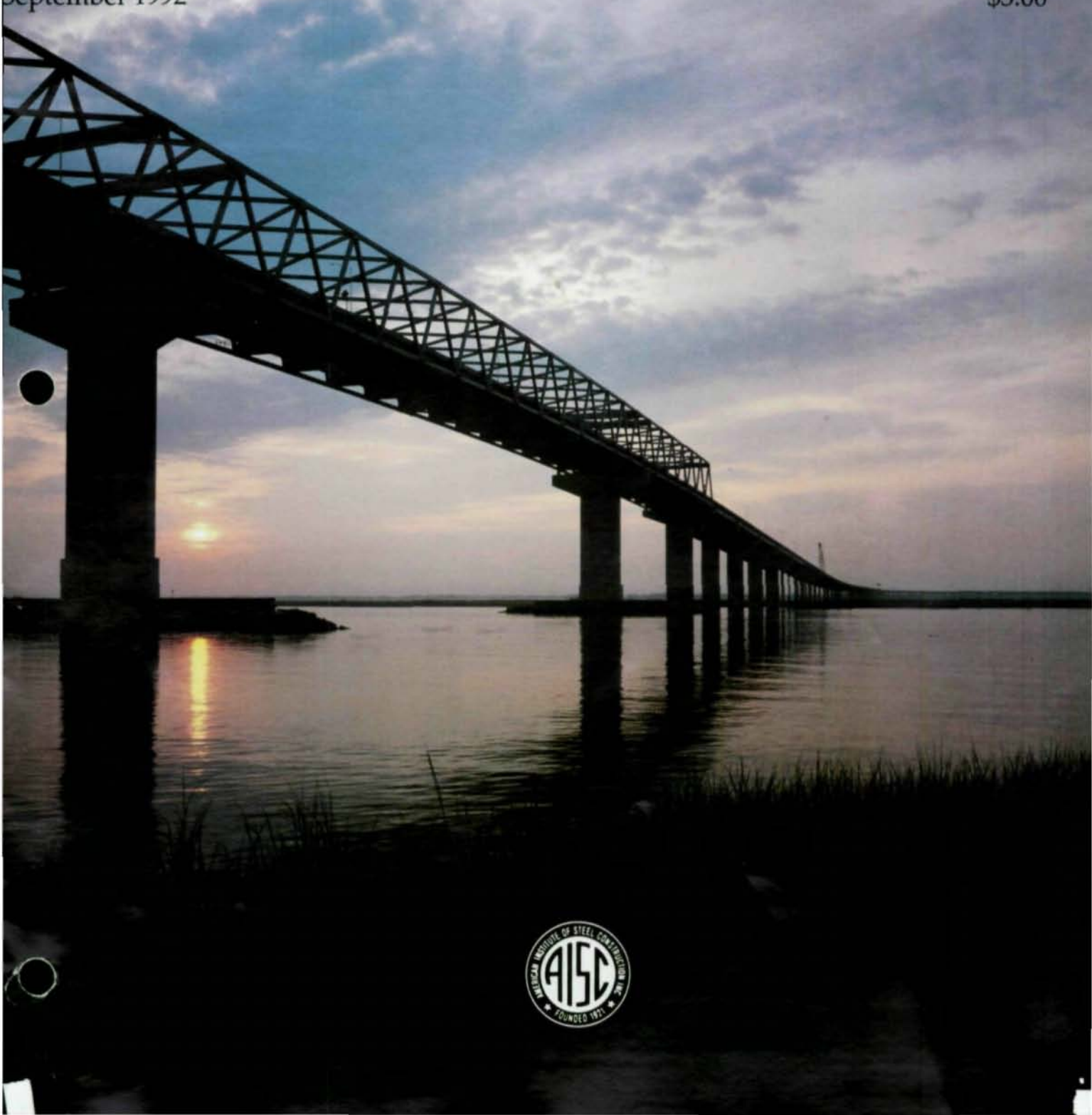

ANNOUNCEMENT



SDI P.O. Box 9506

Canton, OH 44711

The Steel Deck Institute announces a new expert system for the design of composite beams and girders with steel deck. This software, called **SDI FLOOR**, was developed by Structural Engineers, Inc. of Radford, Virginia in cooperation with the AISC and SDI and sponsored, in part, by the AISI.

The knowledge bases in **SDI FLOOR** use LRFD rules for the design of composite or non-composite beams and girders, complete bay design, and design table generation.

The beam (deck ribs perpendicular to the beam centerline) and girder (deck ribs parallel to the beam centerline) knowledge bases can be used to find the least cost composite and/or non-composite design for a specified range of beam depths. Final costs are calculated using user input fabrication, steel and shear stud unit costs. Deflection limits for dead, live and construction loadings can be specified. Tributary area loading, linearly varying line loads, and concentrated loads can be specified in any combination. Stud layouts are also generated.

The bay design knowledge base provides cost optimized design alternatives for an entire bay. The only required input is the bay size, material properties, and uniform loadings. Optimization is based on user input unit costs. Beam spans in both directions along with beam spacing are considered in determining the final design. A vibration analysis is also provided for the final design.

The table generation knowledge base can be used to print design tables in the same format as currently published by the SDI. The user can specify any permitted combination of material properties. This allows office practice to be combined with design requirements.

Detailed reports showing all calculations are provided.

SYSTEM REQUIREMENTS:

1. An IBM Personal Computer or Compatible with 640 Kbytes of Random Access Memory (RAM) and a hard disk drive. DESIGN ADVISOR plus DOS requires a full 640 Kbytes of RAM. Resident programs which decrease this availability may cause execution problems.
2. DOS 3.3 or higher.
3. A 5.25 in. or 3.5 in. floppy disk drive.
4. A color monitor is strongly recommended.
5. DESIGN ADVISOR will run considerably faster if a math co-processor is available.

DESIGN ADVISOR and **SECTIONS** are provided free with the first purchase of a knowledge base module such as **SDI FLOOR**. No other software purchase is needed to make **SDI FLOOR** run.

DESIGN ADVISOR is an expert system shell developed exclusively for use by structural steel designers. Modules containing knowledge bases for the ASD and LRFD design of connections are available from the AISC as is **SECTIONS**. **SECTIONS** provides all of the AISC manual tabulated cross-section, flexural, buckling, and torsional properties for a user selected W, M, S, or HP shape.

TO ORDER SDI FLOOR MODULES @ \$295.00 each (add \$45 for Rush order - 2 to 3 days):

Send your order to : SDI P.O. Box 9506 Canton, Ohio 44711 . If you order by credit card (VISA or Master Card only) include your card number, expiration date and the name as it is shown on the card. You may also phone in or fax credit card orders. The telephone (and fax) number is 216-493-7886. Checks or money orders are also acceptable. Please indicate the disk size you require -- 5.25" or 3.5".

The space for this ad has been donated by United Steel Deck, Inc. to the SDI



NICHOLAS J. BOURAS, INC.
P.O. BOX 662, 475 SPRINGFIELD AVE.
SUMMIT, NEW JERSEY 07902-0662 (201) 277-1617



Estimating

Gives you unrivaled accuracy - and an accurate bid is money in your hand



In these days of declining profits, Structural Software's computerized **Estimating** gives you the accuracy you need to stay competitive. An accurate bid can mean the difference between a healthy profit and an unwelcome surprise. Plus, you're able to bid more jobs using the same personnel. Our **Estimating** program correctly prices all items that go into a job, from the mill to the warehouse. The only thing left for you to calculate is the savings! Almost all of the pricing levels and labor codes can be changed to suit your needs. In fact, our customers agree that **Estimating's** flexibility makes it the best estimating program on the market. And **Estimating's** unique modular design for IBM computers lets you easily add on our other programs, like **Mulging**, **Inventory** and **Production Control**, to give you even greater accuracy and control over shop production.

"The Structural Software system enabled us to bid and run more projects through. Our estimates are more accurate. And because **Production Control** tracks everything in a job, you can keep full control of a project in the office from the time you bid it to the time it goes out to the site."

*Greg Householder
Griffith-Custer Steel*

"Our estimates are faster and more accurate now. We are providing more estimates than ever before. We all had a basic understanding of the system soon after it was installed. Within a few weeks, we were totally used to the system and wondering how we'd ever gotten along without it."

*Phil Griggs
Topper & Griggs, Inc.*

"The computer saves so much compilation time and analysis time, since it groups the pieces automatically. We can bid a lot more work now, and that's really important in today's competitive market. Using the computer saves us hours, or days, on turning estimates around."

*Greg Lewis
Elwell Iron Works, Inc.*

"Estimating saves us the cost of one person per year. We also appreciate the consistency that computerized estimating adds to our operation. Since this program was written by a structural steel fabricator, and for a structural steel fabricator, we don't have to rethink anything to use it."

*Jack Holcomb
Berlin Steel Construction Co.*

"We're extremely satisfied. Estimating has enabled us to do another 20 to 35 percent more quotes and increased our accuracy tenfold. The computer eliminates the tallying errors that creep in sometimes when you're totaling up the weights. We've had our system for close to five years, and we're very happy with it."

*Dave Fritzer
Coastal Steel Corp.*

Call (800) 776-9118 for details on Estimating and other Structural Software programs, including:

***FabriCAD** - A total unit detailing process that includes shop drawings

***Inventory Control, Production Control and Purchase Orders** - Material

Allocation programs that link purchasing with production to cut waste and boost profits. Structural Software Co., 5012 Plantation Road, Roanoke, VA 24019.



STRUCTURAL SOFTWARE CO.
SOFTWARE FOR THE STEEL INDUSTRY
(800) 776-9118

MODERN STEEL CONSTRUCTION

Volume 32, Number 9

September 1992

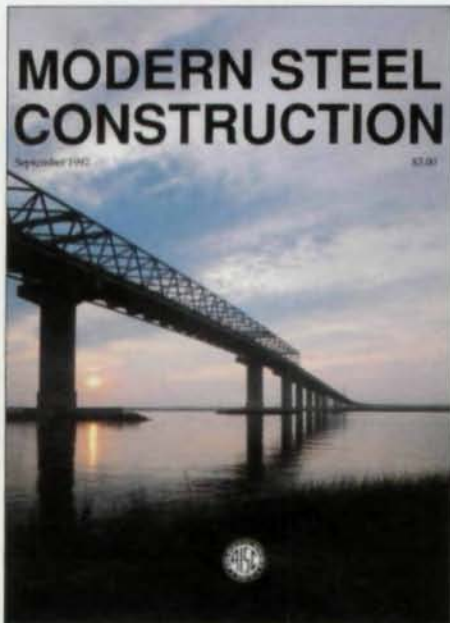

The 5.1-mile long Cooper River Bridge is both the longest bridge and most expensive construction project ever undertaken in South Carolina. The complete story behind this fascinating structure begins on page 32.

Modern Steel Construction (Volume 32, Number 9). ISSN 0026-8445. Published monthly by the American Institute of Steel Construction, Inc. (AISC), One East Wacker Dr., Suite 3100, Chicago, IL 60601-2001.

Advertising office: Pattis/3M, 7161 North Cicero, Lincolnwood, IL 60646.

Subscription price:
Within the U.S.—single issues \$3; 1 year \$30; 3 years \$85.
Outside the U.S.—single issues \$5; 1 year \$36; 3 years \$100.

Postmaster: Please send address changes to Modern Steel Construction, One East Wacker Dr., Suite 3100, Chicago, IL 60601-2001.

Second-class postage paid at Chicago, IL and at additional mailing offices.

FEATURES

- 18 BRIDGE SUPERSTRUCTURES: A COMPARISON OF STEEL AND SEGMENTAL CONCRETE
The true cost of bridge construction must take into account probable cost overruns and construction time
- 24 REDUCING BRIDGE FABRICATION COSTS
Modern Steel Construction presents a special report on cutting bridge fabrication costs
- 28 WHAT DESIGN ENGINEERS CAN DO TO REDUCE BRIDGE FABRICATION COSTS
A compilation of comments from experienced fabricators and detailers across the country
- 32 LINKING CHARLESTON
Steel proved the most economical material for South Carolina's largest bridge
- 39 DECISION CRITERIA FOR BRIDGE SELECTION
Both life cycle costs and life cycle performance must be considered in choosing a structural system
- 47 INNOVATIONS IN COMPOSITE BRIDGES
The combined use of steel and concrete can result in cost-competitive short- and long-span bridges
- 53 BRINGING BRIDGE DESIGN INTO THE NEXT CENTURY: THE ROIZE BRIDGE

NEWS AND DEPARTMENTS

- | | |
|--|--|
| 6 EDITORIAL | 12 CORRESPONDENCE |
| 9 STEEL INTERCHANGE | • Eliminating the guesswork in connection design |
| • Are there concerns about bending of the tube wall in shear tab type connections? | • Software Reviews |
| • How do you assess steel that has been exposed to fire? | • Call for Papers |
| | 14 STEEL CALENDAR |
| | 55 PRODUCTS |
| | 58 STEEL MARKETPLACE |



HISTAR[®]

**A new generation
of rolled beams
and column shapes
for economical
steel construction.**

Once again, ARBED leads the industry by featuring a trendsetting combination of mechanical, chemical and technological properties:

- HIGH YIELD STRENGTHS (up to 65 KSI) - even for ultra-heavy sections.
- OUTSTANDING TOUGHNESS PROPERTIES.
- EXTREMELY LOW CARBON EQUIVALENT — ensures excellent weldability.

A NEW PROCESS... QST.

The secret is in ARBED's revolutionary new in-line QST process.

OTHER RECENT ARBED INNOVATIONS:

ARBED-ROLLED 40", 44", and "TAILOR-MADE" (WTM) series — famous for high section moduli, great lateral buckling resistance, and big savings in fabrication costs and weights. These products are also available in the new HISTAR quality as is our standard WF series and H BEARING PILES.

NEW LITERATURE AVAILABLE

Send now for complete data on all these ARBED products, contact Trade ARBED, INC., 825 Third Ave., New York, NY 10022. (212) 486-9890, FAX 212-355-2159/2421. In Canada: TradeARBED Canada, Inc., 3340 Mainway, Burlington, Ontario, Canada L7M 1A7. (416) 335-5710, FAX 416-335-1292.

TRADE ARBED Inc.

INNOVATORS OF STEEL CONSTRUCTION PRODUCTS.

Editorial Staff

Scott Melnick,
Editor
Patrick M. Newman, P.E.,
Senior Technical Advisor
Charlie Carter,
Technical Advisor

Editorial Offices

Modern Steel Construction
One East Wacker Dr.
Suite 3100
Chicago, IL 60601-2001
(312) 670-5407

Advertising Sales

Pattis-3M
7161 North Cicero
Lincolnwood, IL 60646
(708) 679-1100
FAX (708) 679-5926

AISC Officers

Stephen E. Egger,
Chairman
Frank B. Wylie, III,
First Vice Chairman
Robert E. Owen,
Second Vice Chairman
Robert H. Woolf,
Treasurer
Neil W. Zundel,
President
David Ratterman,
Secretary & General Counsel
Lewis Brunner,
Vice President,
Membership Services
Geerhard Haaijer,
Vice President,
Technology & Research
Morris Caminer,
Vice President,
Finance/Administration

Chronological Confusion

Writing a monthly magazine is a chronological nightmare. I'm writing this in July for a September issue, and at the same time I'm busily at work on the October and November issues, and, of course, planning various issues for 1993. Without constant glances at a calendar, it's easy to lose track not only of what day it is, but also what month.

Fortunately, the engineers, architects and fabricators I work with everyday often have the same problem, or even worse. Most designers are busily working on projects that won't be completed for years, and fabricators often think of a project as complete when the steel is up, even though it won't be occupied for many months.

So since we're all in this state of chronological confusion together, and since this issue is devoted to bridges, I hope no one will consider it odd that it's time to start thinking about the Fourth Biennial National Symposium on Steel Bridge Construction, to be held in Mid-September in 1993. Specifically, the Symposium planners are looking for papers to be presented in Atlanta, the conference's site.

Appropriate topics include: new bridge construction technology; unique, novel and innovative structures; new design concepts; and economical design considerations. Also, papers on a wide variety of bridge issues, such as paint, fatigue, details, and welding inspection, will be considered.

The papers will be presented during a one-and-a-half day symposium, which will be preceded by a day of workshops on such subjects as economical design considerations, erection considerations, and bolting methods. Also, the 1993 AISC Prize Bridge Awards will be presented.

Last year's Symposium in St. Louis attracted more than 200 bridge designers, builders and state and federal officials and, with the increased interest in bridges generated by increased federal highway construction funding, next year's Symposium is expected to be even more successful.

If you're interested in submitting a paper for the 1993 Symposium, send an abstract to: Fred Beckmann, Director of Bridges, AISC, One East Wacker Dr., Suite 3100, Chicago, IL 60601-2001. Deadline for submitting abstracts is November 15. If you have any questions, drop Fred a note at the above address or call him at (312) 670-5413 or fax him a message at (312) 670-5403. **SM**

STAAD-III/ISDS - Ranks #1 in Earthquake Engineering

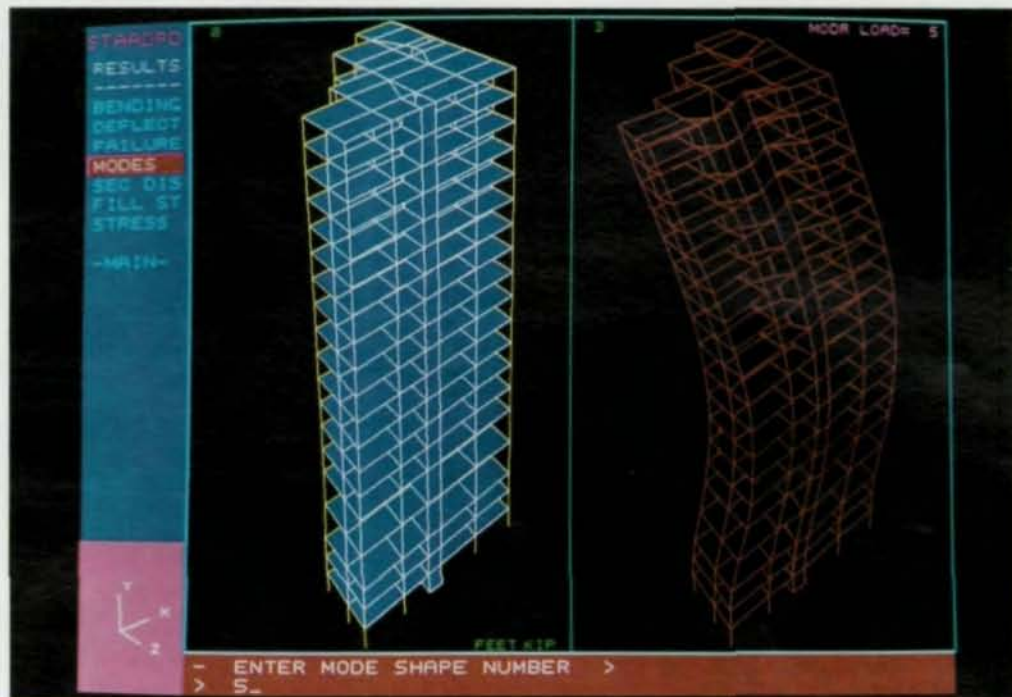

A recent (October, 1990) ENR/McGraw Hill survey of the Architecture/Engineering/Construction industry ranks STAAD-III/ISDS, from Research Engineers, as the #1 structural engineering software today.

Whether it is a single beam or analysis of a 3D multistory structure for seismic response, STAAD-III/ISDS has been the engineer's # 1 choice - since 1978.

Today, Research Engineers, with six offices on four continents, is making the world's knowledge available to the industry - with continuous implementation of the latest technology.

State-of-the-art dynamic/earthquake engineering facilities include the world's fastest and most accurate eigensolution algorithm, response spectrum capabilities with SRSS and CQC modal combinations, numerically efficient plate finite element to model shear walls and rigid diaphragms, automatic generation of UBC loading, static/animated mode shape plots, direct combination of static/dynamic analysis results with fully integrated implementation of STEEL/CONCRETE/TIMBER Design based on American and ten other Foreign Codes.

STAAD-III/ISDS - #1 For a Reason.

Also introducing AutoSTAAD - structural drafting, model generation and STEEL/CONCRETE/TIMBER detailing within AutoCAD.



**Research
Engineers**

A reputation you can build on.

For Information, call 1-800-FOR-RESE
1570 N Batavia Street, Orange, CA 92667
Phone: (714) 974-2500 Fax: (714) 974-4771

RESEARCH ENGINEERS WORLDWIDE

UK: Research Engineers (Europe) Ltd., 19 Lansdowne Court, Brighton Road, Purley Surrey CR8 2BD Phone: (081) 763-1393 Fax: (081) 763-1379 Telex 929181
FRANCE: Research Engineers, 18 rue de Moresville, 28800 FLACEY Phone: 37 47 51 63 Fax: 37 47 44 63
GERMANY: Research Engineers, Wilhelm-Busch-Str. 23, 6140 BENSHEIM 3 AUERBACH Phone: 06251 79577 Fax: 06251 75437
INDIA: Research Engineers Pvt. Ltd., 408 Darga Road, Calcutta 700 017, Phone: 448914 Telex: 214102



The specs on our plate are better.

Carbon Steel Plate.

It's all we make. So we have to make it better: We roll it with exceptional flatness and surface quality. To the tightest tolerances in the industry.

And we believe no one will match the extra effort you'll get from CitiSteel USA. We'll work closely with you to pro-

vide what you want when you want it.

We offer carbon and HSLA plate in a wide range of types and sizes: From structural grades to pressure vessel and hull grades. In plate thicknesses of 3/8" to 3"; widths of 60" to 148"; lengths up to 1000".

Call now and tell us your needs. We'll go flat out for you.

1-800-677-3769

CitiSteel USA Incorporated
4001 Philadelphia Pike
Claymont, DE 19703
Phone: (302) 792-5400
Fax: (800) 374-1561



CitiSteel USA.

CARBON PLATE. IT'S ALL WE MAKE.

Steel Interchange

Steel Interchange is an open forum for *Modern Steel Construction* readers to exchange useful and practical professional ideas and information on all phases of steel building and bridge construction. Opinions and suggestions are welcome on any subject covered in this magazine. If you have a question or problem that your fellow readers might help to solve, please forward it to *Modern Steel Construction*. At the same time feel free to respond to any of the questions that you have read here. Please send them to:

Steel Interchange
Modern Steel Construction
 1 East Wacker Dr.
 Suite 3100
 Chicago, IL 60601

Answers and/or questions should be typewritten and double spaced. Submittals that have been prepared by word-processing are appreciated on computer diskette (either as a wordperfect file or in ASCII format).

The opinions expressed in *Steel Interchange* do not necessarily represent an official position of the American Institute of Steel Construction, Inc. It is recognized that the design of structures is within the scope and expertise of a competent licensed structural engineer, architect or other licensed professional for the application of principles to a particular structure.

Information on ordering AISC publications mentioned in this article can be obtained by calling AISC at 312/670-2400 ext. 433.

The following responses to questions from previous *Steel Interchange* columns have been received:

Are there concerns about bending of the tube wall in shear tab type connections? When should the shear plate be carried through the tube section?

Two potential concerns pertaining to shear tabs used with tube columns are:

- › 1. The strength of the tube wall in a yield line mechanism failure mode in the connection.
- › 2. The effect that local distortion may have on the column strength.

Recent experimental studies have shown that due to the self limiting nature of the end slope of a simply supported beam, neither of these concerns justify the use of through-plates.

The results of a connection study were presented at the 1991 National Steel Construction Conference. (Sherman, D. R. and J. M. Ales, *The Design of Shear Tabs with Tubular Columns*, Proceedings 1991 National Steel Construction Conference, AISC) Thirteen tests were reported that included a range of b/t from 5 to 45 with fully tensioned and snug-tight bolts in the beam web connections. The failure mode was in the tube wall in only two of the tests where the wall was thin enough to produce a punching shear failure. The design guidelines presented in the paper include a criteria to prevent this failure mode. Excessive distortion of the tube wall was never a critical factor.

The design guideline included in the paper recommends that shear tabs be limited to b/t limits of 16. This was due to the limitations of previous tests on the column strength that did not include tubes with higher b/t . In the previous program, four T6x3x $\frac{5}{16}$ " columns were tested with shear tabs, through-plates, fully tensioned bolts and snug-tight bolts. Beams framed into the tube on both 6" walls at the midheight of a 20' column. The ultimate loads

were within 10 percent with the bolt tightness being a greater factor than whether the connecting element was a tab or a through-plate.

Within the last few months a similar column test program was conducted with T8x3x $\frac{1}{4}$ " and T8x3x $\frac{3}{16}$ " columns using snug-tight bolts in all connections. For the $\frac{1}{4}$ " tubes the difference in the strength of the columns with tabs and through-plates was 2 $\frac{1}{2}$ percent. The difference was 20 percent for the $\frac{3}{16}$ " tube columns. All failures were local or general column buckling in the lower half of the column. There was no noticeable local failure at the connection. This study also included columns with the beam connected to one side only. In these cases the failure was by excessive bending of the column and there was no clear distinction between the tabs and through-plate connecting elements.

Although the detailed data from the most recent tests are still being evaluated, it appears that through-plates are not required for tubular columns that do not exceed the b/t limit of $253/F_y$ defining a thin walled section. This conclusion is based on tests where the end rotation of the beam does not exceed that of a uniformly loaded simply supported beam.

Donald R. Sherman
 University of Wisconsin-Milwaukee
 Milwaukee, WI

What procedures should be followed when assessing steel that has been exposed to a fire?

The following is taken from "Technical Committee No. 8: Fire and Blast, Discussion No. 4, *Repair of Steel Structures after Fire*" presented at the International Conference on Planning and Design of Tall Buildings:

The post-fire repair of a steel-framed structure is a situation that many designers have not been faced with. The following brief discussion of the subject provides some general recommendations, as well as an appraisal of the conditions under which structural

Steel Interchange

damage can be expected.

Fires are unique; their effect on a building and the extent of required repairs is a special situation that has to be considered and handled for each particular circumstance. The following checklist outlines several, but not necessarily all, of the parameters that should be investigated by any designer.

- › 1. An appraisal should be made of those members that have been subjected to potential damage. For convenience, this appraisal should be conducted on members grouped as to their importance:
 - » a. Columns.
 - » b. Primary Horizontal Members, such as girders and trusses.
 - » c. Secondary Floor Members, such as beams, fillers and floor deck.
- › 2. After identifying those members of potential damage, each structural member in a fire damaged area should be evaluated for individual damage. This evaluation should also include connections.
- › 3. On the basis of the damage evaluation, an economic evaluation of repair or replacement of the structure should be considered.
- › 4. If it is decided to repair the structure, damaged members should be divided into three categories:
 - » a. Members having nominal damage and adequate structural capacity for continued service without further repair.
 - » b. Members having light damage and repairable in place.
 - » c. Members with severe damage that should be replaced.
- › 5. Throughout all of these steps, the designer must recognize that expediency will often dictate the approach. Fires usually mean a temporary loss of business and rental income; owners and occupants will insist on a very rapid restoration of building service and availability, a situation that may lead to costly, but quick, solutions.

Fortunately, steel is a material with a very high tolerance for fire. All of the processes of its manufacture, from smelting the ore to rolling the structural shape, are done at temperatures above those that are likely to occur in an accidental building fire.

At this point, the designer needs only some guidance on evaluating the degree of structural damage. Fortunately, in steel, the rule is very simple:

Any steel member which has been distorted by fire so that it has a permanent deflection, crippled web or flange area, or damaged end connections should be considered for either in-place repair or replacement.

In practice, it may be easier to apply the corollary:

Any structural steel member remaining in place, with negligible or minor distortions to the web, flanges or end connections shall usually be considered satisfactory for further service.

There are only two exceptions which should be considered by the designer. Quenched and tempered structural steels, of which relatively small tonnages have been used, may undergo a change in properties during the heating and cooling cycle of a fire. A second area of possible departure from the above rule pertains to high strength fasteners. Under certain conditions it is possible that their properties may be altered by prolonged fire exposure. But should there be any question, it is relatively easy to remove individual fasteners for test purposes and, should replacement be necessary, to replace those that are suspected of damage.

R. H. Wildt
Bethlehem Steel Corp.
Bethlehem, PA

New Questions

Listed below are some questions that we would like the readers to answer or discuss. If you have an answer or suggestion please send it to the Steel Interchange Editor. Questions and responses will be printed in future editions of Steel Interchange. Also if you have a question or problem that readers might help solve, send these to the Steel Interchange Editor.

1. What can an erector and engineer do when anchor bolts are too short and the nuts are not fully engaged?

2. Can one weld to an existing structure? How does one determine if the steel is weldable?

3. Are both mechanical galvanizing and hot-dip galvanizing appropriate for bolts?

09853

1 GUIDE TO LRFD

Supplies background information from ASD to LRFD and introduces LRFD philosophy. Provides simplified versions of several equations for design of simple structures or components. Intended for those not yet familiar with LRFD, or who need clarification.



2 QUALITY CRITERIA AND INSPECTION STANDARDS, 3RD EDITION (1988)

This commentary discusses the commonly accepted standards of workmanship for fabricated structural steel framing which assure satisfactory fit and appearance at minimum cost for the vast majority of buildings and bridges. AISC recommendations for clarification and solution of common problems involving fabricating tolerances and procedures are provided.

3 DESIGN OF MEDIUM-RISE STEEL BUILDINGS

The design of medium-rise steel buildings is consolidated in one booklet as a reference for all designers of these structures. This guide includes rules for economic design for engineers. Load requirements are discussed as are joist and composite floor systems.

3 FREE DESIGN AIDS WITH PURCHASE OF 1 MANUAL ASD OR LRFD

AISC Manuals of Steel Construction are essential references for engineers, architects, detailers, draftsmen, contractors and building officials. Two design methods—Allowable Stress Design or Load and Resistance Factor Design—provide expanded design aids and examples which reference every phase of steel construction. Also contains the latest *Bolt Specifications, 1986 Code of Standard Practice*, comprehensive index, and thumb-indexing convenience.

BOTH INCLUDE:

- ▼ Dimensions and Properties
- ▼ Beam and Girder Design
- ▼ Column Design
- ▼ Connections
- ▼ Specifications and Codes
- ▼ Miscellaneous Data and Mathematical Tables

YOUR CHOICE \$60 SAVE \$26!

9TH EDITION ALLOWABLE STRESS DESIGN (ASD)

Based on the provisions of the 1989 *AISC Specification for Structural Steel Buildings—Allowable Stress Design and Plastic Design*. 1144 pages. \$60.00.

1ST EDITION LOAD AND RESISTANCE FACTOR DESIGN (LRFD)

Based on the 1986 *Load and Resistance Factor Design Specification for Structural Steel Buildings*, LRFD provides more uniform structural reliability and better economy than ASD specifications. Design aids are updated in the LRFD format. Includes a special section for composite beams and columns 1192 pages. \$60.00.

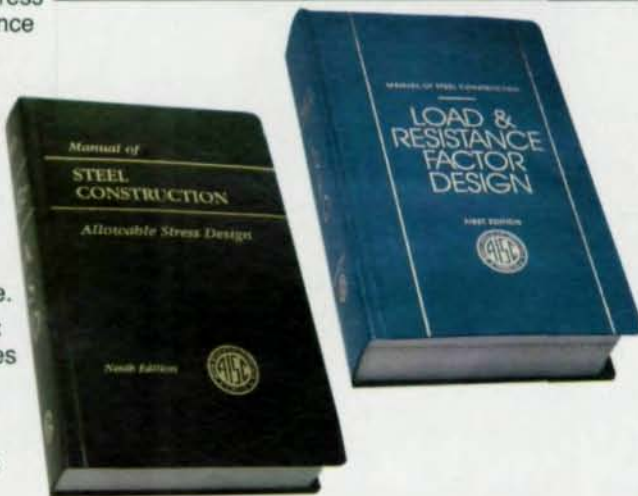

LIMITED TIME OFFER

___ 9th Edition ASD Manual of Steel Construction—\$60 each.
___ 1st Edition LRFD Manual of Steel Construction—\$60 each

25% discount to AISC members

RETURN TO:
AISC MANUAL OFFER
PO BOX 806276
CHICAGO, IL 60680-4124
ALLOW 4-6 WEEKS FOR DELIVERY

NAME/TITLE _____
 COMPANY _____
 ADDRESS _____
 CITY/STATE/ZIP _____
 PLEASE ENCLOSE REMITTANCE. NO COD ORDERS. ADD \$5 FOR UPS CHARGE.
 FOREIGN ORDERS: ADD 10%. \$10 MINIMUM FOR SHIPPING.
 ___ CHECK FOR \$ _____ ENCLOSED ___ CHARGE MY ___ VISA
 ___ MASTERCARD ACCT # _____
 SIGNATURE _____ EXP. DATE _____

ORDER BY OCT. 31, 1992



Eliminating The Guesswork In Connection Design

Dear Editor:

Re: The article by M.E. Hursey, P.E., (pages 24-26, June 1992) on "Reducing Fabrication Costs by Indicating Actual Forces On Selected Building Joints."

Apparently our Eastern colleagues still haven't learned any

lessons from their building failures. The design of proper connections in major structures is the most important aspect of our work, and is usually the responsibility of the senior personnel in the office.

Earthquakes have taught us that details make or break the job. Subtle changes in the design of a connection can introduce eccentricities or other unwanted changes. I am sure you are not going to ask the detailer for the steel company to do a finite element analysis of a com-

plex detail and if he did, how are you going to review it?

I worked in responsible charge for four years in a large midwestern city and always designed all my own details. We never had a budget problem and I always was able to sleep well at night.

In conclusion I would ask again, How can you delegate the most important part of your work to strangers outside your office?

John E. Paquette, S.E.

J. Albert Paquette & Associates
San Francisco

Custom Hollow Structural Sections

Tubular Sections Manufactured To Meet Your Specific Shape & Size Requirements

ASTHETICALLY
APPEALING

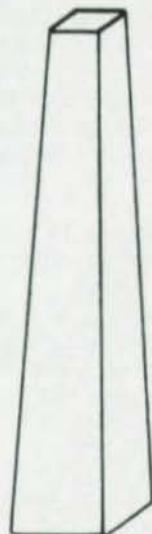

PROPERTIES TAILORED
TO SPECIFIC NEEDS

EXCELLENT TORSIONAL
PROPERTIES



EXCELLENT
COLUMN STRENGTH

LARGE SIZES
14" TO 30"

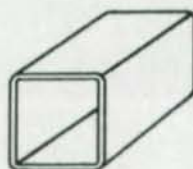

SQUARES

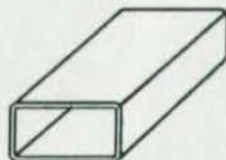

RECTANGLES

WALL THICKNESS
5/16"-5/8"

- Sizes up to 30" square
- Tapered or straight sections

- Section properties available on request

- No minimum order size

VALMONT TULSA • PO BOX 2620 • TULSA OKLAHOMA 74101
ATTN: GARY HANEY • CALL TOLL FREE: 1-800-331-3002

Please send additional information about Custom Hollow Structural Sections.

NAME _____ TITLE _____

FIRM _____

ADDRESS _____

CITY _____ STATE _____

PHONE _____ ZIP _____



**VALMONT
TULSA**

Dear Editor:

I enjoyed reading the article titled "Communication Of Design Requirements Between Fabricator And Engineer Is Crucial For A Safe And Economic Structure" (pages 27-31, June 1992) by W.A. Thornton, and feel that point he makes for increased communication between detailers and designers with regard to design loads is very valid. However, in the traditional design-drafting cycle, getting member reactions from the engineer's calculation pad onto the design document requires a substantial amount of effort and time—certainly something that the average design firm has precious too little of. Thus, although this information has most likely been calculated, it is not always in a format that may readily be shared with other parties who would benefit from its use.

The advance of computer technology in the design-drafting industry, however, provides an opportunity to improve the information sharing process. Computer Aided Design and Drafting (CADD) software now exists that integrates engineering calculations with drafting operations, making design documents "smart" in the sense that design parameters such as loads, deflections and forces are all available directly from within the electronic drawing. Our Auto-FLOOR program, for instance, which is for the analysis, design and drafting of steel floor framing systems in AutoCAD, calculates

and stores all member end reactions on a layer in AutoCAD, which may be printed as part of the framing plan. The member reactions displayed on the drawing are the very same ones used by the program to optimize the design selection.

Providing connection design forces on drawings is a practice that Dr. Thornton feels makes good sense, a view, no doubt, shared by many. The newest CADD tools now offer the average design office a cost effective method for sharing this type of information.

Randall C. Corson, S.E.
Computers and Structures, Inc.
Berkeley, CA

Software Reviews

Dear Editor:

Further to your review of Multiframe, our structural analysis software, in the May 1992 issue of *Modern Steel Construction*, I would like to clarify a couple of points which were raised in the review.

The reviewers stated that "the assignment of member properties, end releases and loading were cumbersome" due to the fact that members could only be selected "one at a time, sloping members, all horizontal members or all vertical members." In fact, it is quite simple to select any arbitrary group of members in Multiframe either by shift clicking on the members or shift-dragging a box enclosing the members using the mouse. This is a standard part of the Macintosh user interface and is described in the Multiframe manual. This considerably simplifies the process of assigning properties to members, even with very large structures. As we realize that it is easy for users to overlook procedures covered in the manual, our technical support hotline is provided as part of the purchase price of the software to help users more easily solve this type of problem.

Regarding the provision of design capabilities, your readers may be interested to know that we will be releasing an additional module to the Multiframe suite named

Steel Designer this summer. Steel Designer will perform code checking and design optimization in accordance with AISC requirements.

Sharon A. Alger
Graphic Magic
Santa Cruz, CA

Call For Papers

Is Your Structure Suitably Braced" is the theme of a confer-

ence scheduled for April 6-7, 1993 in Milwaukee. Those wishing to have a paper considered should submit a one-page abstract by October 15 to the Structural Stability Research Council, Fritz Engineering Lab No. 13, Lehigh University, Bethlehem, PA 18105 (215) 758-3522. Presented papers will be published in a printed post-conference proceedings. For more information on submitting a paper or registration, contact the SSRC.



The BURCO STUD PAK

TOWABLE ARC STUD WELDING SYSTEMS
STANDARD AND XL 100
With
SW 3000 POWER SUPPLY

An innovative Engine Drive Concept with capacities to handle up to 7/8" Stud.

UP TO 600 FT. EXTENSION CABLE LENGTH POSSIBLE.

OUR TRADEMARK —
DURABILITY, QUALITY
AND RELIABILITY!

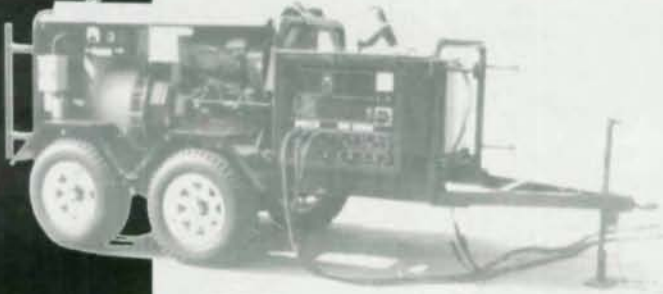



STANDARD



The BURCO STUD PAK XL 100 provides 110kVA continuous power output for 6 and 8 post welding applications including inverters.

- **Low Profile** - Only 56" High
- **Low Weight** - Only 4,400 lbs.
- **Convertible** to skid mounted at the job site.
- **Cost** about 30% lower than conventional systems.

Air Cooled Deutz Diesel
LIMA Alternator
Fully Equipped for User Comfort

BOX 2115 • 530 CHAPEL HILL ROAD • TEL. 919-227-2737 FAX NO. 919-228-0780
BURLINGTON NORTH CAROLINA 27215 U.S.A.

LRS
LEVINSON
REGISTERED
STEELS

LEVINSON STEEL CO.

100% Domestic Inventory Mill Traceable
18,000 Ton On-Hand Inventory



For the office serving you call:

1-800-538-4676

Birmingham
FAX (205) 328-4427
Pittsburgh
FAX (412) 266-7656

CALENDAR

September 17. **Steel Bridge Forum**, Richmond, VA. Contact: Camille Rubeiz, Steel Bridge Forum, c/o AISI, 1101 17th St., N.W., Suite 1300, Washington, DC 20036 (202) 452-7190.

September 22-24. **Fracture & Fatigue Control in Structures** short course, Lawrence, KS. Contact: The University of Kansas, Division of Continuing Education, Attn: Management Programs, Continuing Education Building, Lawrence, KS 66045-2608 (913) 864-3968.

October 1. **The Rational Use Of Composite Concrete and Steel Construction**, Chicago. Keynote speaker will be Ceasar Pelli of Ceasar Pelli and Associates. Contact: S.P. Asrow Associates, Ltd. (312) 939-2150.

September 24. **Third Bi-Annual SSFNE New England Steel Bridge Conference**, Boxborough, MA. Topics include the development of state specifications for coating systems and shop inspection requirements. Contact: Structural Steel Fabricators of New England, P.O. Box 191, Canton, MA 02021 (617) 828-9408.

October 5-6. **Central Fabricators Meeting**, Union League Club, Chicago. General topic: fabrication and operations. Contact: LaVerne Duckrow, 7227 W. 127th St., Palos Hills, IL 60463 (708) 361-2332.

October 12. Deadline for submission of papers for **Practical Solutions for Bridge Strengthening And Rehabilitation**, Des Moines. Contact: Bridge Engineering Center, Dept. of Civil and Construction Engineering, Iowa State University, Ames, IA 50011 (515) 294-8763; Fax (515) 294-8216.

October 22. **Steel Bridge Forum**, Atlanta. Contact: Camille Rubeiz, Steel Bridge Forum, c/o AISI, 1101 17th St., N.W., Suite 1300, Washington, DC 20036 (202) 452-7190.

October 13-14. **Welding Structural Design two-day seminar**, Houston. Designed to provide engineers and welding inspectors a greater understanding of weld mechanics and welded engineering structures. Contact: AWS, 550 N.W. LeJeune Road, P.O. Box 351040, Miami, FL 33135 (800) 443-9353.

October 15. **Higgins Lecture Breakfast Meeting**, Kansas City. Featuring Prof. William Maguire. Contact: Gordon Finch (816) 373-1203.

October 16. **Higgins Lecture at the 4th Annual Conference of Structural Engineers of Texas**, San Antonio. Featuring Prof. William Maguire. Contact: Jim Anders (214) 369-0664.

November 10-11. **Welding Structural Design two-day seminar**, Atlanta (See August 18-19 listing).

November 10-12. **Fourth Biennial Symposium on Movable Bridges**, Ft. Lauderdale, FL. More than 40 sessions on various aspects of moveable bridges. Contact: Andrew W. Herrmann at (904) 575-1970.

FREE!! FREE!! FREE!!

Announcing . . . SAI-DRAW

❖ New CADD Software!! ❖

SAI is excited to announce SAI-DRAW. A powerful, new program that works within AutoCAD™ (Release 10 and 11) that **draws and dimensions** beams, columns, footings and walls ⇒ ⇒ **AUTOMATICALLY!!**

Simply enter pertinent design results into a menu and have SAI-DRAW produce a completed drawing ⇒ ⇒ **AUTOMATICALLY!!**

OR,

Use SAI software to perform the structural analysis and design, then watch SAI-DRAW take these results and produce a completed drawing ⇒ ⇒ **AUTOMATICALLY!!**



IMPROVE YOUR PRODUCTIVITY!!

Call NOW for more information and details on getting a **FREE SAI-DRAW** program.

THE MOST PRODUCTIVE STRUCTURAL DESIGN SOFTWARE SINCE 1966

YES, Please send me more information on getting a **FREE SAI-DRAW** program. (Offer valid in the U.S.A. and Canada only, expires November 30, 1992) 013

NAME _____ COMPANY _____
STREET ADDRESS _____
CITY/STATE/ZIP _____
PHONE _____ MASTERCARD VISA
ACCT. NO. _____ EXP. DATE _____ CHECK ENCLOSED
SIGNATURE _____ DATE _____

SAI
STRUCTURAL
ANALYSIS, INC.
555 S. Federal Highway
Suite 210
Boca Raton, FL 33432
(407) 394-4257



Before We Ship Our Structural Bolts And Nuts, They Have To Earn Their Stripes.

When bolts and nuts come from Nucor Fastener, you can have absolute confidence in their performance. That's because they're American made — and made to meet the toughest standards.

For starters, all the steel used in our structural bolts and nuts comes from Nucor Steel and other domestic steel mills. Plus, we provide raw material origin on all our certifications, and we can supply original steel certification for traceability requirements.

Our product line includes A325, A490 and A307 structural bolts and A563 grade C and heat treated grade

DH structural nuts. And we've recently added mechanically galvanized structural nuts, bolts and washers along with ASTM Type 3 corrosion resistant/ weathering products.

Our fully equipped laboratory lets us meet all ASTM quality standards. We provide proof tests and wedge tensile tests for all structural bolt products. And we can full-size tensile test our entire product size range instead of using machined samples.

What's more, we can meet special federal and state highway testing and certification requirements including

rotational capacity testing.

All our fasteners are identified with a lot number on each container which allows traceability to materials, dimensions, processing and testing.

And because we maintain a 7,000-ton inventory of fasteners we can always supply what you need. So call us at 800/955-6826, FAX 219/337-5394 or write us at PO Box 6100, St. Joe, IN 46785 for more information. And give us the chance to earn your business.

NUCOR FASTENER

A Division of Nucor Corporation

Weather.



Rugged. Tough. Beautiful. Enduring.

We're talking about Maine's weather. And the kind of bridges that can stand up to it.

Since 1967, Maine's first choice has been weathering steel. For lots of reasons.

First, economy. Besides the initial construction cost saving, The Maine Department of Transportation (ME DOT) enjoys a 30% savings in maintenance costs when compared to painted bridges.

Second, maintenance. An important consideration with the northeast's short maintenance season. Just by following the basic guidelines, ME DOT has been able to cut back substantially on overall maintenance. And because weathering steel's dense oxide coating is self-healing and impervious to corrosion, it virtually eliminates the need for painting.

Third, nature. Weathering steel blends with its

5906-0985

Or not.



surroundings, and minimizes disturbance to the natural environment.

In a state with so much weather and so much natural beauty, it's no wonder that Maine already has built 80 weathering steel bridges, and has more on the drawing boards, specifying ASTM A588.

Find out more about the advantages of weathering steel for yourself. To get a copy of our Product Booklet No. 3790 and our latest Technical Bulletin TB-307

on "Uncoated Weathering Steel Structures," contact your nearest Bethlehem Steel sales office or call (215) 694-5906. Bethlehem Steel Corporation, Construction Marketing Division, Bethlehem, PA 18016.

Bethlehem 

Bridge Superstructures: A Comparison of Steel And Segmental Concrete

By Andy Johnson

During the past decade, interest in segmental concrete has grown, and this interest has been magnified by the recent passage of the Intermodal Surface Transportation Efficiency Act of 1991. Unfortunately, along with this interest has come much misinformation.

For example, many of the myths about the economy of segmental concrete were repeated in a recent article by the manager of the American Segmental Bridge Institute ("Sizing Up Segmentals") in the July 1992 issue of *Civil Engineering*.

Part of the problem comes from an examination of first costs, which is often the most important criterion for material choice. With segmental concrete, past experience has shown that very often, the bid price and final construction cost are far apart with final cost being significantly higher. This has been commonly attributed to lack of experience with the segmental concrete concept on the part of designers, contractors and owners. Today, however, after much more experience, we continue to see large overruns in budget as well as in time of construction. The current experience with the Jamestown Bridge in Rhode Island as shown in the table at right is a good illustration.

The estimated final cost of \$130,000,000 for the Jamestown Bridge does not include any potential claims on the current contract. Nor does it include the opportu-

Cost Overrun For Jamestown Bridge

Engineers low estimate for steel/concrete alternate.....	\$70,000,000
Low bid for segmental concrete alternate (12/84).....	64,000,000
Theoretical savings.....	6,000,000
Original contractor paid \$20,000,000 and released from contract (2/88).....	20,000,000
Site winterized summer of '88 at cost of.....	8,000,000
Project re-bid spring of '89 for completion at low bid.....	102,000,000
Total completed cost estimate.....	130,000,000
Original completion time per bid.....	3-1/2 years
New estimate of completion.....	(12/92) or 8 years
SUMMARY	
Estimated cost overrun.....	\$66,000,000
Additional Construction Time.....	4.5 years

Job still not complete.

nity cost to the taxpayers of not being able to use the bridge for an additional four and one-half years.

The constructibility of segmental concrete bridges has been a major problem in the U.S. and a significant factor in the cost overruns. Robert J. Desjardins, Vice Chairman of Cianbro Corporation in Portland, ME, in a paper presented at the National Symposium on Steel Bridge Construction in 1991, commented on this very fact (see "Bidding Alternate Designs For Bridge Construction," in the March 1991 issue of *MSC*). In essence, he said that complexity and incompleteness of designs, difficulties with constructibility and inexperience of inspection personnel have all contributed to the problem.

Due to the complexity of the

concept, segmental concrete bridges require much higher inspection costs to the owner during construction than a comparable bridge in steel. Although rarely done, it would seem logical to include such costs in the initial price of a bridge for the purpose of comparing bids.

Obviously, initial cost is greatly affected by the design and in the past, steel designs have not been as cost effective as they could have been, largely due to lack of updated design practices by consultants and owners. Our industry is working hard to help designers and owners achieve the most efficient designs possible. Two major engineering firms with recent experience in both steel and segmental concrete bridges made the comment that with a free hand to design the most cost-efficient brid-



The Jamestown Bridge, as shown in this recent photograph from the Providence Journal-Bulletin, is still far from completion despite being more than four years late and more than \$66 million over budget.

ges, steel would win.

These same two designers went on to make five additional points about structural advantages of steel:

- One of the biggest advantages of steel is weight savings which translates to lower erection costs, inasmuch as pieces can be handled with lighter equipment.
- Steel members are made to closer tolerances which often translates to faster erection.
- If the substructure and superstructure are designed properly, the lighter weight of steel will allow lighter foundations than for concrete.
- Further structural efficiencies can be obtained by the fact that it is easier to make spans continuous and it is easier to develop composite action with steel designs than with segmental concrete.
- For major water crossings, protection of the superstructure

against impact is often an issue. In the case of steel or concrete, integral pier caps can be designed in such a way to protect the superstructure.

Deck Replacement

Decks have historically been the most vulnerable part of a bridge and it is much easier to repair or replace the concrete deck on a steel bridge than on segmental concrete. This is a result of the fact that for the latter, the top flange of the box is both a critical structural component as well as the riding surface. The deck cannot be removed because the structure would have to be supported with false work. Even then, the effects of prestressing must be offset. Furthermore, a compromised deck can mean a compromised structure. For some segmental designs, the deck can theoretically be removed, but in order to maintain structural stability, the entire bridge must be

closed to normal traffic. As a practical matter, the replaceability of decks on segmental concrete has never been proven. This contrasts with steel

bridges where deteriorated decks are commonly replaced one lane at a time, thereby assuring reduced, but nevertheless uninterrupted, traffic flow.

There are two other options for deck replacement on segmental concrete bridges. One is to add an additional deck in which case the substructure and superstructure must have been designed accordingly. The other option is to remove and replace the top layer only. The problem is that deck deterioration often goes deeper, attacking the reinforcing steel.

Life-cycle cost is something we are hearing a lot about now, especially with the provision in the new Surface Transportation Act that owners consider life-cycle costs in their selection of materials.



The New River Gorge Bridge in Fayette County, WV, is the world's longest steel arch span at 1,700'. It was constructed of weathering steel to minimize maintenance requirements and enhance its appearance. It was completed in 1977 at a cost of \$35.2 million. Photo courtesy of Michael Baker Jr., Inc., a subsidiary of Michael Baker Corp.

In a draft of a study being done for the American Iron & Steel Institute by David Veshosky of Lafayette College and Carl R. Beidleman of Lehigh University, attention is brought to the difficulty in using life-cycle cost analysis with bridges.

The authors point out that there are many factors which affect the life of a bridge beyond whether or not the superstructure is of steel or concrete. A bridge's service life is affected by its design, type and frequency of traffic, environment, weather, maintenance and changes in usage and conditions over time. In effect, each bridge is a unique case reflecting the above factors and the state-of-the-art at the time it was built. It would appear that no one has collected sufficient data at this time to allow meaningful and reliable life-cycle cost analysis as a means of making choices of materials.

Any future attempts at con-

structing a model for life-cycle analysis should also include full and complete first costs such as budget overruns, opportunity costs of time delays and inspection costs during construction, as previously mentioned.

Steel Durability

On the other hand, life-cycle performance and the long term durability of steel bridges has been clearly documented.

This has been called into question recently in an article entitled "Highway Bridge Type and Performance Patterns" by Kenneth F. Dunker and Basile G. Rabbat, in which the authors tried to show that durability of steel bridges is less favorable than for concrete structures. This was done through analysis of data taken from the National Bridge Inventory as maintained by the Federal Highway Administration. In one table of the study, twelve common types of

bridge construction are listed — two steel, one timber and nine concrete. The table also shows the percentage of bridges rated structurally deficient for each type. The most common sources of deficiency were deck and substructure, both concrete elements. Superstructure as a source of deficiency was not listed for either steel type. It was, however, listed for five of the nine concrete types. This seems to refute the authors' claim that concrete bridges outperform steel bridges.

The long term durability of concrete in bridges is still an open question; the oldest major prestressed highway bridge has already been replaced after a service life of approximately 40 years. Corrosion and breakage of prestressing strands in existing prestressed concrete members continues; the lack of corrosion protection for existing reinforcing and prestressing steel in pre-

stressed girders including segmental has to be of grave concern to bridge owners who expect 50-100 years of service life.

Epoxy coating has been called into question in New York and Florida. For example, the Florida Keys bridges, among the first segmental concrete designs in the U.S., are already experiencing corrosion of epoxy coated reinforcing steel in substructure elements. It is not beyond suspicion that this condition may eventually manifest itself in the superstructure.

It is reasonable to say that with a steel structure, it is far easier to make inspections and determine the structural state of the bridge than with concrete where the true condition may be hidden.

The long-term durability and cost effectiveness of steel bridges

will be further enhanced by the use of state-of-the-art paint systems. There are those now which are water borne and give a minimum of 25 years of guaranteed service life. In addition, the use of weathering steel in accordance with FHWA Guidelines is proving very

industry is fully aware of how to properly deal with the issues of aesthetics and durability with weathering steel and its use in bridges continues to grow.

At one time or another, much has been made of problems with fatigue in steel bridges. The fact of the matter is that many older steel bridges were designed and built before we had full understanding of fatigue behavior. What is often overlooked is that these bridges have been repaired with simple bolted field splices without reduction in load capacity or remaining service life. The issue of fatigue of prestressed concrete members

as well as corrosion is just beginning to be addressed. What problems lie ahead for owners of these structures?

There are two additional points which are often overlooked but

The long-term durability and cost effectiveness of steel bridges will be further advanced by the use of state-of-the-art paint systems

effective. Even though the overall experience with this material has been excellent, there were instances in the past where it had been used improperly and did not perform as well as expected. Today, our in-

The All New Actual Size 3 1/4 "x 5 1/2 "x 3/8 "

Jobber III

Dimensional Calculator

The Calculator that does it All !

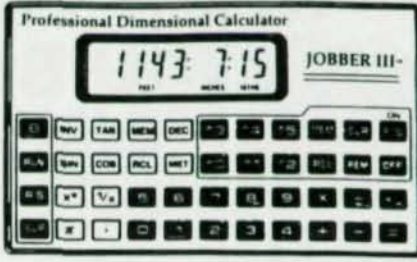

The Indispensable Tool for Everyone Who Works with DIMENSIONS Detailers, Fabricators, Foreman, Crewleaders, Layout Men, Engineers & Architects. The Worlds BEST Feet/Inches/Sixteenths Engineering Calculator that also works in Decimals & Metric (millimeters) with Instant Conversion at the touch of a button !

New Features Include:

- * Built-in Trig. Functions That Automatically Solve Bevel, Rise, Run & Slope in all Modes. Makes Calculating Beams, Columns, Frames, Stairs, Rails, Braces, Roof Slopes & Circles Easy.
- * The only Calculator with the Jobber III patented 0/15 Keyboard that cuts keystrokes by 66 %. Saving You time & entry errors over "old fashion calculators" & that Means Money to YOU !
- * 4 Memories that automatically retain your data even when the Jobber III is off.
- * Everyone who works with Dimensions needs the Power of the **Jobber III.**

Special Price
\$ 99.95 + \$4.50 S&H

Jobber Instruments
P.O. Box 4112 -C
Sevierville, TN, 37864

Order Toll-Free
1-800-635-1339

which deserve comment—aesthetics and the environment. Bridges are usually significant structures which have the power to add or detract from the landscape. At their worst, they are “permanent” eyesores and at their best can be soaring pieces of engineering poetry. This has less to do with material selection than with overall design, i.e., geometry, proportion, structural concept and integration with the site. Further, a utilitarian but well-designed urban railroad bridge can be as beautiful in its own way as a bridge which soars gracefully over a mountain canyon. A well-designed steel structure either painted with newer long term paint systems or done in weathering steel which has been blasted for uniform weathering or partially painted if the overall appearance dictates, need not take a backseat to any other material. Who can say that the Brooklyn, Golden Gate or West Virginia’s New River Gorge

steel bridges are not monuments to the engineering profession?

Environmental Concerns

Regarding environmental concerns, steel is the most environmentally friendly material used in bridge construction. Paint systems are now proven and available which have either greatly reduced quantities of volatile organic compounds (VOC’s) or none at all. Clearly, the trend is toward use of paints with no VOC’s. In addition, the raw material itself (rolled beams and plates) uses a high percentage of scrap steel as its principal ingredient. This phenomenon has been stimulated by increasing use of electric furnaces in steel making. There is such a demand that virtually all steel scrap—whether from buildings, bridges or household appliances—is recycled instead of being sent to landfills. As an example, when Comisky Park was razed in 1990, all of the

structural steel was remelted in about one and a half days to make more beams. The recyclable nature of steel touches each of us daily; one mill alone consumes annually about 300,000 old cars which would otherwise mar the landscape.

After one hundred years of experience, steel for bridges continues to be a desirable choice. The material, produced under tightly controlled mill conditions, is homogeneous and consistent in quality. Its behavior is predictable and dependable. Steel designs are well tested in terms of constructibility, serviceability, durability and longevity. Steel bridges will be even more cost effective in the future through use of weathering steel, modern high performance paint systems and proper design procedures. ■

Andy Johnson is vice president of marketing with AISC Marketing, Inc.

WHEN YOU BUY ST. LOUIS, YOU BUY AMERICAN!

- AND YOU GET: • FULL TRACEABILITY
• LOT CONTROL
• CERTIFICATIONS

Registered Head Markings on all structural and machine bolts:



A-325
Type 1



A-325
Type 3



A-307-A



A-449



A-307-B

Products from 1/2"–3" diameter include:



COUNTERSUNK



SQUARE
MACHINE



BUTTON
HEAD

ST. LOUIS SCREW & BOLT COMPANY

6900 N. Broadway • St. Louis, MO 63147

(314) 389-7500 • 1-800-237-7059 • Fax (314) 389-7510

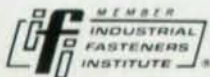

Grade School.

A36

A572 Grade 50

Economical and readily available

Mill certified 50,000 minimum yield

A36/A57250

Economical Readily available Mill certified 50,000 minimum yield

Introducing the one steel for North America: Chaparral Steel's A36/A57250 steel. This mill-certified steel satisfies multigrade requirements in the U.S., Canada and Mexico. The A36/A57250 steel meets all the specifications of our A36, A572 Grade 50, 44W and 50W. It's everything you like about these grades rolled into one. Plus, it costs the same as the A36, and has the same carbon equivalent range, an important factor for welding and formability. It's also just as easy to get, thanks to our innovative shipping techniques and central location. Call your Chaparral representative today and order the structural steel that makes the grade a number of ways: Chaparral's A36/A57250.

**CHAPARRAL
STEEL®**

300 Ward Road Midlothian, Texas 76065-9651
Toll Free (800) 527-7979 U.S. and Canada
Local (214) 775-8241 Fax (214) 775-6120

Reducing Bridge Fabrication Costs

In February, *Modern Steel Construction* presented a Special Report on how design engineers could reduce building fabrication costs. This month we're taking a look at cutting bridge fabrication costs.

Figure 1

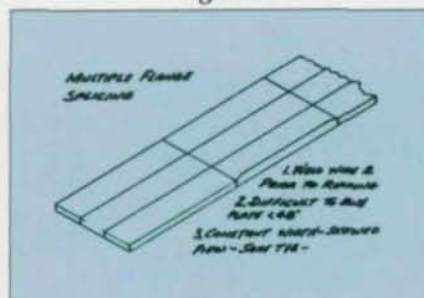

Figure 2

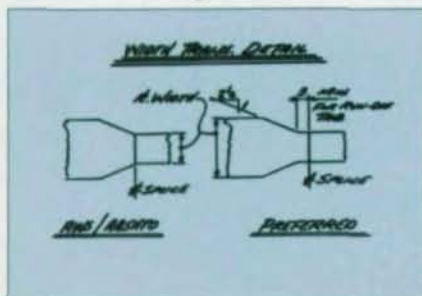
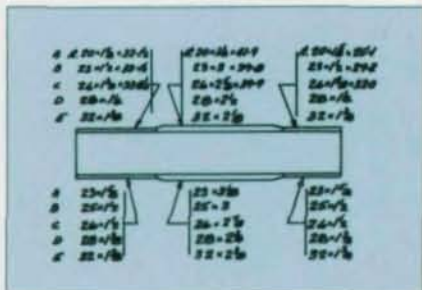

Figure 3



By Thomas P. Guzek and John R. Grzybowski

At one time, it was sufficient to determine a least weight solution and develop a set of plans for competitive bidding. Today, however, with the alternate bidding practices in a very competitive market, it is imperative that the bridge designer consider shop fabrication factors in order to produce a cost-effective steel design.

Material vs. Labor Costs

It is of utmost importance for every designer to realize that material and labor costs have changed radically during the past few years. Over the past four years, material costs have decreased approximately 10%, while labor costs have increased nearly 20%. That means reducing fabrication costs can result in substantial cost savings. It also means that sometimes its counterproductive to attempt to obtain greater economy by using less materials if it results in increased fabrication costs.

The most economical design is not necessarily the one with the least amount of weight, but rather the one with the lowest cost after all the fabrication and erection factors have been evaluated. It is necessary to compare all of the costs and to select fabrication details that are the least complex to achieve the required function.

Flange Plates

Plates purchased for use as

flanges can represent a significant portion of material costs. However, the labor costs involved in fabricating flange plates can vary greatly as a result of a combination of design, purchasing, and shop practices.

For example, Figure 1 shows how plates of varying thicknesses are welded together as slabs received from the mill. After welding and non-destructive testing are complete, the individual flanges are cut from the fully welded slab. Had these flanges been individually spliced, fitting would have had to occur three times as opposed to the one fitting in this example. Individual run-off tabs to both stop and start welds would be required for each weld.

In addition, it is possible to reduce the number of required X-rays. If the example flange is 18" in width, an X-ray zone of 15" mandates two shots per flange if spliced individually, or a total of six X-rays. Spliced as a slab, the three 18" flanges total 54" and thus only require four X-rays to accomplish the same testing.

In Figure 2, flange width transition details, as per AWS D1.5, show the transition starting at the splice. The preference is to move the splice approximately 3" from the transition for ease in fitting run-off tabs.

While the sketch in Figure 2 looks good, accomplishing the work and insuring quality is no simple matter. Note that the set back from the transition area allows the run-off tabs to be cleanly fit. And depending on the plate

thickness, the welding process may require multiple passes. Also, non-destructive testing must be completed and the run-off tabs are removed before the flange is acceptable for assembly in the girder.

A more economical approach, where possible, is to use constant widths, which can eliminate these single welds as well as reduce the chance for errors caused by singular fitting and welding.

Another advantage of using constant widths is that it increases a fabricator's purchasing options. Figure 3 shows a common—and expensive—design.

A minimum width of 48" is usually needed to purchase plate economically. And in this example, many of the plates shown can be grouped by thickness to exceed the 48" purchasing requirement—except for the thicker plates in the center, which do not allow combinations.

Also, with the exception of the 3" thickness, each individual plate is unique to the structure. As a result, additional material costs have been incurred to bring this plate into the shop and each splice needs to be individually welded as opposed to slab spliced.

Figure 4 shows a similar situation and how a fabricator corrected it. As designed, the material was consistent in thickness, but changes in width would have forced each splice to be individually fabricated. In this case, the fabricator suggested the flanges be changed to obtain a uniform width yet retain the same section. As a result, the first flange, which was designed as a PL 22" x 1 1/4" was changed to a PL 26" x 1 1/16". The second flange remained unchanged, and the center plate was changed from a PL 30" x 2 3/8" to a PL 26" x 2 3/4". As a result, the plates can now be purchased in their most economical price range and spliced as slabs before being ripped into individual flanges.

Also, the varying web thicknesses were made constant by increasing the two end plates by 1/16" to 1 3/16". By doing so, two of the four web splices were eliminated,

which resulted in substantial savings.

While the solution of increasing to a thicker section is obviously practical, many designs carry the note: "Any changes in material require submittal of calculations reflecting changes in deflections and cambers." While the designer is under the impression he has reduced job costs by reducing the weight of steel, in fact s/he has increased costs either by requiring the purchase of more expensive material or the submittal of design calculations.

Stiffener Design

Web design is an area that can have significant impact on the cost of plate girder fabrication. As previously stated, labor costs are rising while material costs are decreasing—and applying stiffeners is one of the most labor intensive operations in plate girder fabrication.

An obvious recommendation is that transverse stiffeners should only be placed on one side of the web, with the exception of diaphragm connections, where they are required on both sides. Transverse stiffeners should not bear on both the top and bottom flanges unless this is an absolute design requirement. Fitting transverse stiffeners is a very time-consuming operation because each stiffener has to be individually cut and ground to fit each location.

Longitudinal stiffeners, which often are used in conjunction with transverse stiffeners on longer spans with deeper web girders, should be placed on the opposite side of the web from the transverse stiffeners. This will eliminate the transverse stiffeners intersecting the longitudinal stiffeners, which causes additional shop labor costs. Studies have shown that longitudinal stiffeners are not economical for spans less than 300'. Bethlehem Steel, U.S. Steel and AISC have developed formulas and guidelines to evaluate the economical use of transverse and longitudinal stiffeners. In many cases, eliminating transverse and longitudinal stiffen-

Figure 4

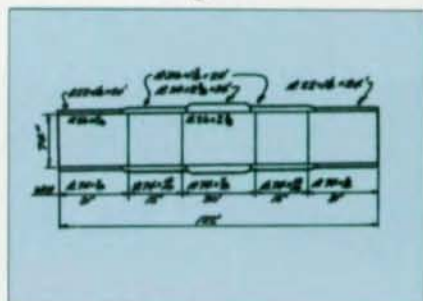

Figure 5

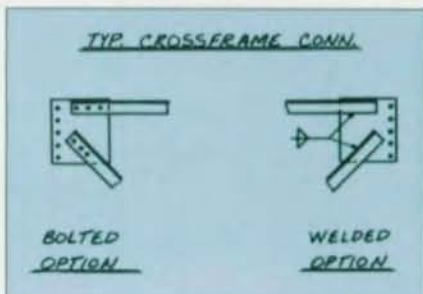

Figure 6

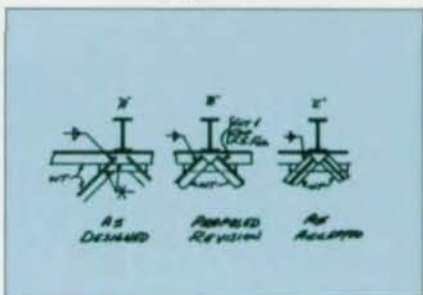

Figure 7

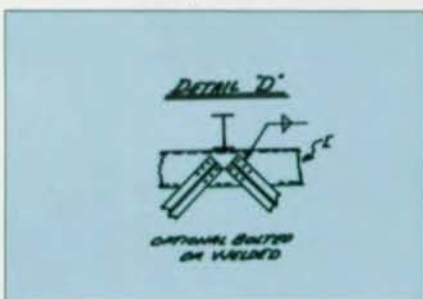

Figure 8

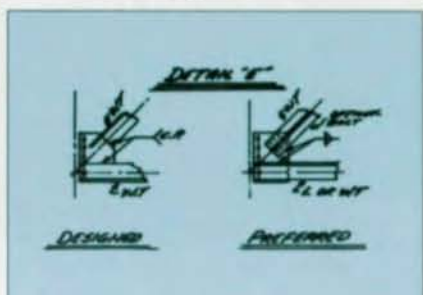

Figure 9

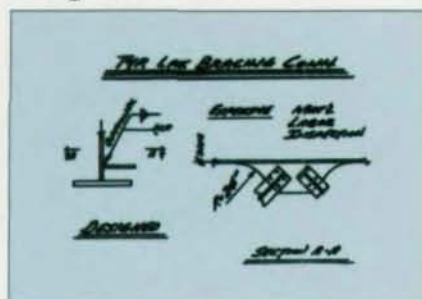

Figure 10

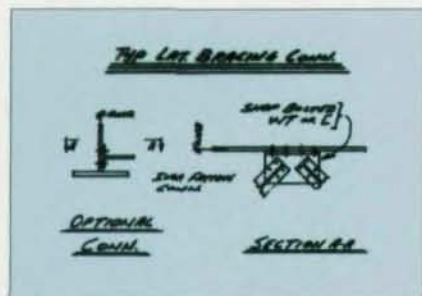

Figure 11

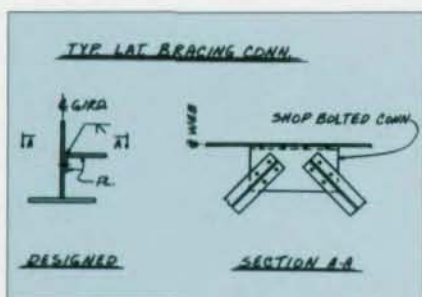

Figure 12

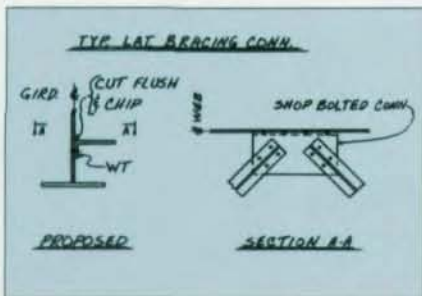
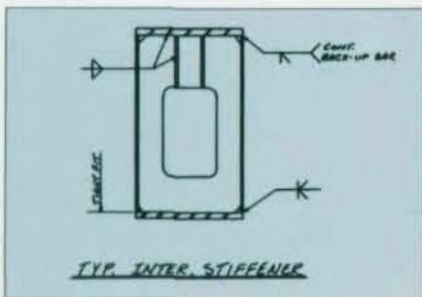

Figure 13



ers and replacing them with a heavier web is far less expensive than the fabrication costs of applying stiffeners.

Design Detail Options

- Because each fabricator has different equipment, some are better equipped to more economically handle welded connections while some prefer bolted connections. Figure 5 is a crossframe example of how an owner or designer can give the option to either bolt or weld the diagonals and struts to a gusset plate.

The welded option would allow a fabrication shop to assemble cut to length members to pre-cut gusset plates. This assembly would be fit in a fixture to insure the proper dimensions, and then welded.

The optional method allowed by the owner would be to bolt the assembly as shown. Using this method, crossframe members would be pre-cut to length with holes either punched or drilled. All pre-cut and pre-punched members are then fixture assembled and bolts are torqued to complete the shipping piece.

- Secondary members, such as crossframes, represent approximately 10% of a structure's weight and therefore often are given much less attention than the girders. Because of this, their design frequently incorporates a disproportionate amount of shop labor for the weight (Figure 6).

"As Designed", the top strut consists of a WT section with a gusset plate butt welded using a double bevel complete penetration weld. The diagonal also is a WT requiring the stem at each end be cut and the flange notched, custom fitted and welded to the gusset plates. Each end of each diagonal requires four fillet welds per flange and one full penetration butt weld. Non-destructive testing of the butt weld also would be required.

The "Proposed Revision" calls for the far side flange of the diagonal to be cut and chipped flush to allow a flat web member in full contact with the strut.

"As accepted", the diagonal has

been rotated 90 degrees. As a result, the flange no longer needs to be cut flush, but simply must be in contact with the top strut web. Welding also is reduced to two fillet welds per end of each diagonal. The "As Accepted" condition represents a substantial reduction in costs for grinding, fitting, welding and inspection of the details.

- Figure 7 shows a crossframe diagonal framing into a top strut. Again, both a bolted and welded option have been shown to allow the fabricator to choose based on individual efficiencies. Figure 8 shows a diagonal WT requiring the stem to be cut out and custom fit. By rotating the WT 90 degrees, the expensive stem cut, fitting, complete penetration weld and non-destructive testing of this weld could be eliminated.

Lateral Bracing Connections

Lateral bracing connections are another example of details subject to cost savings. Figure 9 shows a gusset plate requiring more time for layout and burning than that required for a rectangular plate. The gusset plate would be fillet welded through the center and full penetration welded at the ends. The end of the plate needs to be at least 1/2" or more wide to attain proper fusion prior to grinding the radius.

Figure 10 shows an optional connection that requires a piece of a WT to be bolted to the girder web to act as the gusset plate. The expensive welding, grinding and non-destructive testing requirements have been eliminated.

Figure 11 presents still another lateral bracing gusset designed as two plates joined utilizing a complete penetration groove weld. The alternative, shown in Figure 12 consists of using a piece of a WT with the top section of flange cut flush with the web. The end result is nearly identical, yet joint preparation, welding and non-destructive testing have all been eliminated.

Box Girders

Economy in shop labor is the

goal of every fabricator and in many cases finding a practical method of fabrication is a challenge. The box girder shown is approximately 70' long and carries welded plate girders over the top flange. All material used in the box was designated as fracture critical.

Figure 13 shows the normal procedure of building a four plate box by fabricating a three-sided trough using stiffeners milled on four sides so they act as squaring diaphragms. In this case, the web to bottom flange welds are complete penetration groove welds. The webs to top flange also utilized groove welds but allowed the use of continuous back-up bars; therefore, the box should be fabricated using the top flange as the closure piece. However, because the stiffeners are welded to the top flange a welder would need to enter the box after it was closed to complete these fracture critical welds. The box is 3' wide by 5' high and the spacing between stiffeners is 7'-6". The owner on this project required all fracture critical welds to be witnessed by their inspector, which meant both the welder and inspector would be confined to a small, closed space. Also, fracture critical welds require a pre-heat of 300 degrees, making safety an obvious concern.

The most economical way to close the box would be to use the back-up bar welds on the bottom flange. This would allow the three-sided trough to be built, complete with all welding in this condition and close with the back-up bar welds. Further entry into the box would not be required.

After much discussion with the owner, the back-up bars would be allowed only at the compression flange where originally designated. However, all stiffener welding to the top flange could be eliminated if a mill to bear condition could be obtained (Figure 14). The need to enter the closed box was therefore eliminated.

Shop Assembly

Shop assembly is often required when there is no need. Some speci-

fications require assembly on any "difficult" structure, which can greatly add to a project's cost because of the time and space involved.

For example, curved girder bridges are frequently the exception to the "web horizontal" assembly and are often required by specification to be vertically assembled. Because of fabrication tolerances and the surprising flexibility of curved girders, except in extreme cases this assembly requirement is unnecessary.

Likewise, assembly of flared structures frequently is specified. If the center-to-center dimension of girders, for example, is 7' on the left end of the structure and 9' on the right side, crossframes will be made to accommodate each of the varying intermediate dimensions. Shop assembly in this case is therefore a waste of money.

Super elevated bridges and ramp tie in structures fall into the same categories. By fabricating individual girder lines within tolerances, assembly becomes unnecessary.

Another frequently misinterpreted specification is the check assembly vs. the drill assembled requirements.

By assembling all pieces in their final position and then drilling and reaming all connections, the need to drill in difficult to reach places does not allow the fabricator to take full advantage of his equipment. The set-up and blocking to accomplish this assembly, in addition to the inefficient drilling, is very time consuming.

On the other hand, fabricating all pieces in an efficient manner in the shop and then performing a check assembly to insure fit is certainly a faster and more economical operation.

The cost of shop assembly can add to a job and should only be required in truly difficult situations.

When in doubt about a specific design or fabrication practice, seek assistance. Fabricators are willing to share their knowledge. Communication is the key to sustaining and expanding the steel bridge industry.

Figure 14

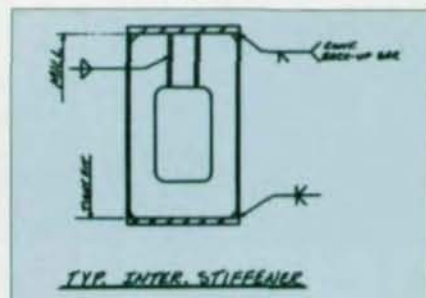

Thomas P. Guzek is a regional sales manager with the Chicago Heights, IL, office of AISC-member Trinity Industries, Inc. and John R. Grzybowski is a vice president of sales with AISC-member Phoenix Steel, Inc., Eau Claire, WI.

M-STRUDL®

The Best Selling
Civil/Structural Program Since 1987

ANALYSIS

- 2D/3D Frame / Truss / Plate / Shell
- Static / P-Delta / Dynamic / RSA Analysis
- Capable of 1000's of joints and 100's of load cases
- Moving load generator
- Interactive geometry, deflection, mode shape, plots
- Interactive shear and moment diagram plots
- AISC Library included

DESIGN

- Interactive graphic menu driven design
- Continuous beam, section properties, frequency calculations
- AISC code check and sizing including LRFD
- ACI column, beam, footing, retaining wall design
- Design details can be output to AUTOCAD
- Excellent in report presentations

SATISFACTION GUARANTEED*

*See our brochure for details
Supports DOS/OS2 operation systems

"Ask for a brochure today!"
You'll be glad you did.



P.O. Box 14676
Fremont, CA 94538-4676
510/226-8857
Fax 510/226-7328

What Design Engineers Can Do To Reduce Bridge Fabrication Costs

A compilation of comments from experienced fabricators and detailers across the country

Robert P. Stupp, president, AISC-member Stupp Bros. Bridge & Iron Co., St. Louis:

1. Increase the use of A588 weathering steel. Painting is very expensive and the new FHWA Guidelines have approved the use of A588 for bridges.

2. Eliminate the narrowing of flanges for small weight savings. The increased labor costs incurred by splicing often more than offsets the material cost savings. However, since the break point is different for each fabricator, and also will vary from job-to-job, the best solution is to give the fabricator options.

3. Use fillet welds wherever possible. Full penetration welds are much more expensive and often are used unnecessarily.

4. Eliminate the requirement for edge grinding. Studies have found that rough edges do not need to be ground smooth to a radius to ensure paint adhesion.

5. Limit girder length to 120' in length and 15' in depth. Anything larger makes shipping from the fabrication shop to the job site too expensive and difficult.

6. Be sure that only material that must be fracture critical be labeled FCM. Diaphragms, for example, usually don't need to be fracture critical and this requirement merely raises costs.

7. Allow the fabricator the option of omitting splices. For example, where a 60' girder continues into a 40' and then into another 60', allow the fabricator to put the 40' and 60' lengths together if the fabricator determines it to be more economical.

8. Wider girder spacing will reduce fabrication costs.

9. Specify quick drying paints. More and more bridge steel requires second and third coats in the shop. It's time consuming and expensive for the fabricator to wait for the paint to dry.

Frunk Mikita, manager of engineering/estimating, AISC-member Harris Structural Steel Co., Inc., South Plainfield, NJ:

The increasing reliance by design engineers on computer software programs for bridge design is adding to the cost of fabrication. Often, bridge software designs emphasize least weight options, which means the design mixes a wide variety of sizes and shapes and a spaghetti bowl design—such as 1½", 1⅞" and 1" flanges on different girders. The result is that the fabricator can't economically buy material and also has increased labor costs.

Designers are increasingly isolated from the people who build the structures. In New Jersey, for example, designers are banned from talking to the fabricator directly. They have to go through the contractor, and that causes delays and communication problems.

Fabricators and designers cannot be in an adversarial relationship. Bridge design and construction is a team effort and communication is key to a successful project.

J. Randall Foil, P.E., director of engineering, AISC-member Trinity Industries, Inc., Houston:

• The lightest structure is not necessarily the most economic structure.

1. Adding shop splices to reduce flange thicknesses by small amounts will increase the overall cost.

2. When flanges have to be spliced, keep the widths the same whenever possible. This allows for slabbing (splicing the flanges for several girders before cutting to width). Also, allow some flexibility in shop splice locations. Some shops can efficiently handle plates over 100' while others are limited to 80' or less. The capacity of mills in the area of the shop also can affect lengths.

3. Flange plates must be nested to obtain widths that can be ordered from a mill. For plate over 1" up to 2" thick, keep sizes in ⅛" increments. Over 2", keep sizes in ¼" increments. Remember, if there are only one or two flange plates of the same thickness on a job, additional material must be ordered to obtain these plates. Typically, there is a 48" minimum order width.

4. Keep minimum flange thicknesses in the ¾" to 1" range. Thinner flanges will increase the cost due to problems with heat distortion during welding.

• Keep diaphragms and cross frames as simple as possible.

1. Avoid gusset plates butt welded to the stems of WTs and angle legs.

2. Use lap joints with fillet welds wherever possible.

3. Have as few cuts on gusset plates as possible.

4. Use oversize holes.

• Use flat bar sizes for stiffeners to reduce cutting, grinding, and material cost.

• Instead of full penetration welds on bearing stiffeners, use finish to bear, or finish to bear with fillet welds. This will prevent the distortion in the bottom flange

caused by full penetration welds, which must be straightened.

Tom Calley, president, Trevian Projects, Ltd., Winnipeg, Manitoba, Canada (a detailer working extensively with fabricators in the Chicago and Minneapolis areas):

The quotes for detailing costs on two similar bridges designed by different engineers can vary by as much as 100%, based on the detailer's past experience with an engineer. Some factors taken into account by detailers include:

1. Errors on design drawings. A decade ago it was rare to find errors on bridge design drawings. Today, errors are common.

2. Missing and inaccurate data on horizontally curved bridges with reverse and/or flare curves. Most engineers give the data for the radii, P.I.'s, P.C.'s and P.T.'s to two decimals, and give approximate angle rounded to the software they are using. While this is sufficient for the contractor to lay out the structure to survey accuracy, it is not accurate enough to create an accurate database with geometric closure. To find the centers of all the curves, the initial data is required to three or four decimal places. It would also be helpful if engineers provided the coordinates of the center of the curves. This data can be easily pulled out of computer files.

3. Rehab jobs with notes that place all responsibility for verifying dimensions and site conditions on the contractor need to also establish a control mechanism to verify that the general contractor complies. Fabricators and detailers have many horror stories of trying to get reliable site information from contractors.

4. Some engineers will not answer questions, even when there are errors on their design drawings. they request the detailers to "note" the problem on the approval submittals, which simply slows down the work process and adds to the price of the job.

SHOP DETAILS
THE EASY WAY

Beams, Columns, Plans, Elevations, Stairs, Handrail, Grating Layout, Ladders, Bracing, Roof Frames, Floor Frames, Kickers, Hangers, Relieving angles, Roof angles, Pipe racks, Breeching supports, Stack framing, Access platforms, Gussets, Tubes, Trusses, Towers or anything else you can fabricate.

without using a pencil.

If you want to get rid of your pencil we can show you how.

COMPUTER DETAILING CORPORATION
A service company for steel fabricators and detailers
1310 Industrial Blvd.
Southampton, PA 18966
215-355-6003

ONE STRINGER - SS1 (As Shown)

Structural Material Sorter Ver. 4.0

A series of programs designed to help steel fabricators manage material.



- Reduces labor — Increases accuracy.
- Automatically computes weights, surface areas, bolt counts and lineal totals.
- Quickly sorts lists into proper order.
- Produces optimum length-cutting lists from in-house stock, vendor's stock or the best combination of each.
- Provides shipping lists based on piece-mark sequence.
- Tallies material costs, shop hours and field hours for easy estimating.
- Uses simplified terms so non-tech personnel can operate with ease.
- External Data Interface can import existing computer-based material lists.
- Call today for a FREE demo kit, including the full system's operator's manual!

E.J.E. INDUSTRIES, INC.

COMPUTER SOFTWARE FOR STEEL PROFESSIONALS
287 Dewey Avenue Washington, PA 15301 (800) 321-3955



Where do we st

There are enough things to keep you from completing a project on time. Waiting for steel shouldn't be one of them.

That's why, whether it's a bridge, a skyscraper or any other steel project, you should call on Lukens. Thanks to a new Customer Satisfaction program, supported by new facility and systems

improvements, our on-time performance record has never been better.

Our new ladle refining unit produces high quality steel with remarkable consistency. And our automated mills turn that steel into smooth, flat plate, precisely rolled to the dimensions ordered. Time after time. Resulting in more steel

and on deadlines?

that's on target and ready for delivery.

We've also installed a new computerized order system. In minutes, we can give you a quote, determine the shipping week, and place your order.

So call us. Because, while late may be better than never, at Lukens it's never good enough.

For more information, call Mike Markward,

Marketing Manager, at (215) 383-2291. Lukens Steel Company, Coatesville, Pennsylvania 19320-0911.

**LUKENS
STEEL**
— A LUKENS COMPANY —

The specialist in plate steels.

Linking Charleston

Steel proved the most
economical material for South
Carolina's largest bridge

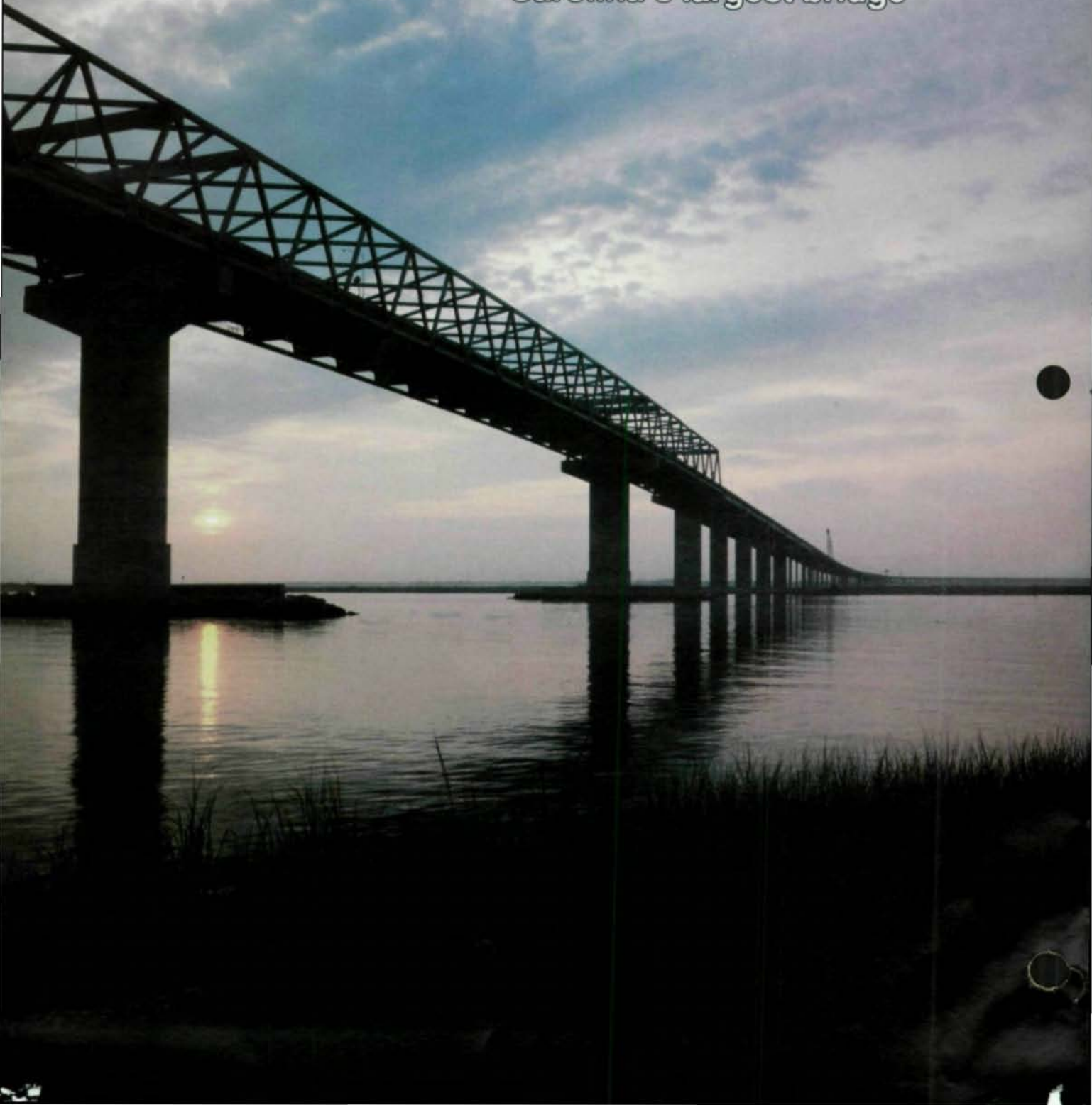

By Raymond McCabe, P.E., and
Walter Sharko, P.E.

The recently completed, 5.1-mile long Cooper River Bridge is both the longest bridge and most expensive construction project ever undertaken in South Carolina. It is a vital link in the six-lane I-526 Mark Clark Expressway that will ultimately encircle Charleston and connect the city with many neighboring areas.

The main truss spans of the Cooper River Bridge and elevated approach structures comprise much of the northeast quadrant of this loop freeway. Because of its tremendous size and to foster competition, the project was built under two separate construction contracts—the 3.1-mile Cooper section, which includes the east approach, and the 2.0-mile Urban section on the west side of the river. The contracts totaled \$141 million.

Alternate Design Studies

In 1982, Howard Needles Tammen & Bergendoff (HNTB) was retained by the South Carolina Department of Highways and Transportation to prepare a steel alternate design for the Cooper River Bridge. Preliminary studies for the main river unit included a parallel chord continuous truss, a tied arch, and a variable depth continuous truss. The tied arch was found to be the most economical, with the parallel chord truss and variable depth truss costing 9% and 16% more, respectively. The parallel chord truss was selected as the final steel alternate, however, because of the small cost differential between it and the tied arch and the FHWA's concerns regarding the arch's non-redundant tie girders.

Bids on the Cooper section were received in November 1986 on the steel alternate and a concrete, cable-stayed alternate. At \$89.4 million, the low steel bid was \$17 less than the low concrete alternate.

HNTB prepared the preliminary and final designs, plans and specifications, as well as construction engineering and inspection ser-



VOSS ENGINEERS THE RIGHT BEARING PAD FOR YOU!

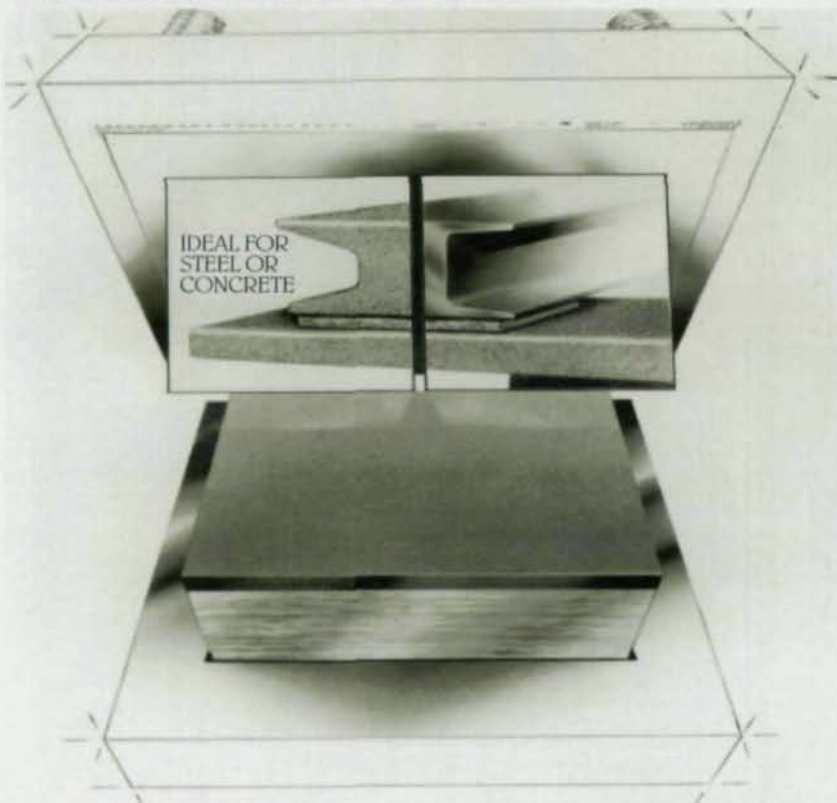

SORBTEX Expansion Bearings

- High Load
- Seismic and Thermal movement control
- Low Friction
- Low Deflection
- Rotation Capabilities
- AASHTO Approved

FIBERLAST

A new choice in a

structural bearing pad which meets today's higher load requirements while remaining cost effective.

VOSS Slide Bearings

Steel backed PTFE accomodates structural movements due to thermal expansions - can also be bonded to other Voss Bearings to allow for misalignment or rotation.

NEW CRITICAL BEARING PAD DATA!

Write for your **free** Design Manual and software Design disc. Also available: Fiberlast conventional manual & disc.



VOSS ENGINEERING, INC.
6965 N. Hamlin Ave.
Lincolnwood, IL 60645
ph: 708 673 8900
fax: 708 673 1408



vices.

General Bridge Features

The Cooper River Bridge is a two-way, four-lane structure with the capability of being expanded to six lanes. Minimum navigational clearance is 155' above a mean high water over a clear channel width of 700'.

The bridge deck consists of two 44' roadways separated by a 2'-2" concrete median barrier with 1'-5" parapets. Except where widened for ramps, the total deck width is 93'-3". In the Urban section, the roadways are separated by an open median varying in width from 14' to 40'.

While the main span of the bridge crosses the Cooper River, the 3.1-mile Cooper section also crosses Spoil Island, Daniel Island and Clouter Creek. The 2.0-mile Urban section crosses several local streets, an arterial highway and two railroads. There also are 2.3 miles of ramp structures feeding the mainline roadways in both sections.

The main river truss unit consists of a 1,600' parallel chord truss. The approach structures immediately next to the truss use continuous A572 steel girder units consisting of six spans at 197' each on the west side and five spans at 232' each on the east side of the river.

For the intermediate and low-



level approach spans, which comprise the remainder of the 5.1-mile structure, prestressed concrete beams (AASHTO Type 3, 4 and 5) and concrete slab spans are used.

Main Truss Unit

Key Design Aspects:

The superstructure of the Cooper River Bridge consists of a three-span continuous parallel chord steel truss with a main span of 800' and side spans of 400' each. A Warren Truss without verticals was designed to ensure a very clean appearance. Load factor design was used to calculate the size of all elements of the truss span.

Rather than vary the truss depth to follow the bending moment distribution, the depth was held constant while the yield strength was varied. The optimum truss depth was found to be 55' and the steel use was distributed as such: 30 percent A36 (Fy = 36 ksi); 55 percent A572 (Fy = 50 ksi); and 15 percent A514 (Fy = 100 ksi). The overall width of box was kept constant at 30".

Truss compression members are box-shaped and tension members are H-shaped. Fillet welds were used to join the plate elements.

The decision to held the truss depth constant was made for aesthetic reasons and for simplicity in construction. The lower, flatter design also took into consideration

the high-wind location of the bridge.

While most truss bridge incorporate unsightly sway bracing that many motorists view as a jumble of crisscrossing steel elements, this was eliminated on the Cooper River Bridge. The main purpose of sway bracing is to equalize the deflection of the trusses under asymmetrical live load to reduce distortional stresses. Instead, full moment connections at the floor beam diagonal connection and a stiff upper and lower bracing system were designed.

Roadway Deck System:

The most common form of deck system for truss bridges in the United States has been the use of a concrete slab spanning transversely over steel stringers, which in turn span longitudinally over floor beams. The longitudinal carrying elements of the deck are designed independently of the main longitudinal trusses by incorporating stress-relief joints that significantly reduce participation stresses.

However, these relief joints are prone to maintenance problems. Their lack of watertightness often results in the corrosion of steel supporting members.

For the Cooper River Bridge, the roadway deck is fully continuous from end-to-end for a length of 1,600'. The stress-relief joints were

ARKANSAS

SAVES YOU

■ TIME

■ LABOR

■ MONEY

WITH WF BEAM
CUSTOM SERVICES:



CAMBERING



TEE-SPLITTING



DRILL & COPE



END MILLING



CUT-TO-LENGTH



STORAGE, TRANS-SHIP

FREE

LATEST DETAILED
INFORMATION:
PRICE,
SPECIFICATIONS,
CAPABILITIES,
SERVICES,
AND MORE...
WRITE OR CALL:
ARKANSAS STEEL
PROCESSING, INC.,
17W697 BUTTERFIELD RD.,
OAKBROOK TERRACE, IL 60181,
(708) 495-8600 Toll-Free 1-800 255-8601
Fax (708) 620-6394



ARKANSAS STEEL PROCESSING, INC.
ARMOREL, AR 72310

A FULL-SERVICE STRUCTURAL
STEEL PROCESSING CENTER

HIGH STRENGTH WEATHERING STEEL

STRUCTURAL & PLATE
GRADE SPECIFICATIONS

A588/A572

• ANGLES • BEAMS • SQUARES
• FLATS • PLATES • ROUNDS
• CHANNELS

A606 - TYPE 4

• SHEETS • COILS

A242 - TYPE 1

PLATES

AR360

PLATES

MATCHING MILL TEST CERTIFICATIONS
ON ENTIRE INVENTORY AVAILABLE



P. O. BOX 326 • PELHAM, AL 35124 • 205/664-2950

WATS: 800/868-6798

FAX: 205/663-3391

SAVE TIME AND MONEY CALCULATE CONNECTIONS with CONNECT[®] version 3.5

Software and Data Base
for IBM PCs and Compatibles
Proven, easy to-use, moderate price

DETAILERS, STRUCTURAL ENGINEERS
design, document, check:

Framed Beam Connections
Seated Beam Connections
Eccentric Connections
Connections in Tension
Moment Connections
Hip and Valley Details
Oblique bracing with Setbacks
Web Stiffeners
Triangulation
and more.

Print a hard copy of calculations
and/or save on disk.

Updated to AISC 9th Ed.

Demo package available.

Write or call today:

Hess Technical Services

2389 Mill Grove Road
Pittsburgh, PA 15241

(412) 831-2010 or (412) 833-7525

eliminated by proper detailing and by calculating the stresses resulting from their elimination. The deck is fixed longitudinally to the truss at the center line of the main span. From that point to either expansion joint, all but the center stringers are allowed to move on top of the floor beam. The bridge deck is an 8"-thick reinforced concrete slab with lightweight concrete used in the center span and normal weight concrete used in the end spans to reduce dead load effects.

Shop Fabrication:

The box members of the Cooper River Bridge were coated prior to fabrication with an inorganic zinc primer to protect against corrosion. Shop connections were welded and tested with non-destructive radiographic, magnetic particle and ultrasonic tests. The welds of the boxes are only at the four outside corners, except at the end where there is a return weld approximately 3' to the diaphragm. Primer was applied inside the box and masked off in the area to be welded. Holes for field connections were pre-drilled full-size in the shop using computerized drills.

Fabrication of the steel trusses was performed by AISC-member Pitt-Des Moines, Inc., while AISC-member Sheffield Steel Products, Inc., handled the fabrication of the steel girders. Erector for the truss and girder spans was AISC-member John F. Beasley Construction Co. Construction of the Cooper section of the project was performed by Cooper River Constructors, a joint venture of S.J. Groves Construction Co. of Minneapolis and Monterey Construction Co., a division of Guy F. Atkinson of San Francisco.

Construction engineer for the truss span was Tylk, Wright and Gustafson of Matteson, IL. The Urban Section was constructed by Traylor Bros., Inc., of Baton Rouge, LA.

Pre-Assembly:

Prefabricated members were shipped to a pre-assembly plant near the bridge site by rail or truck. The members then were pre-assembled into larger pieces and shipped to the construction site by

barge. The pieces were lifted into place by barge-mounted cranes and no falsework was used.

Truss Erection:

Individual prefabricated panels of each truss were erected on main channel piers using the balanced cantilever method. The panels were stayed by cables anchored at the base of the piers. Field connections were made using structural ASTM A325 bolts.

When the cantilevers reached about halfway from the main channel piers to the end piers, pre-assembled, 230'-long fill-in pieces of truss were erected in one piece to complete each end span.

Over the main channel, the cantilevers were extended 285' from the piers until a gap of about 230' existed between the two. The final sections of each truss, which tied the cantilevers together, were erected in one piece. Each piece weighed 176 tons.

Erection of the trusses was followed by completion of the floor beams, stringers, lateral bracing, and then the concrete slab deck was cast. Finally, the trusses received two additional coats of paint—an intermediate coat of high-build epoxy and a top coat of blue urethane.

Bridge Completion

The Cooper River Bridge sustained about \$5.2 million of damage from Hurricane Hugo in 1990. About 250 prestressed girders were blown down on the bridge's east approach and there was some damage to the substructure bents.

The damaged girders were all replaced and the bents were repaired. However, the partially erected truss was braced with cables and went undamaged. Unfortunately, due to hurricane damage and other related factors, completion of the bridge was delayed about a year, and finally opened early in 1992.

Raymond McCabe, P.E., and Walter Sharko, P.E., are associates with HNTB, a multi-disciplinary consulting firm with office throughout the country. ■

998006



New steel bridge proves that cost-effective reasons are often the strongest.

When the Iowa Department of Transportation specified the new U.S. 61/Peosta Channel Bridge, it needed a material that met precise strength, budget and scheduling criteria. No surprises there.

The solution it found should come as no surprise, either: ASTM A572 Gr. 50 (USS EX-TEN 50) High Strength Low Alloy Steel. With its relatively quick fabrication and erection, steel beat out other construction alternatives. With an

overall length of 4200 feet and a maximum span length of 258 feet, the ASTM A572 Gr. 50 was perfect for the job, and the new bridge went up on schedule, and within budget.

U.S. Steel's Gary Plate Mill has the world's most modern dimensional control capability and is supported by sophisticated melting and continuous casting facilities. Consider using steel for your next design. We can give you some strong reasons.

OWNER :
Iowa Department of Transportation

DESIGNER:
Alfred Benesch and Company

PRIME CONTRACTOR:
Shappert Engineering Company

FABRICATION:
Trinity Industries, Inc.
Structural Steel Division
Pitt-Des Moines, Inc.
PDM Structural Group Division



U. S. Steel Group
a Division of USX Corporation



How to get from here



Estimating Module



Engineering, Analysis
and Design Module



Detailing Module



Production Control
Module



CNC Interface
Module

to here.



Design Data's SDS/2 Steel Fabrication System.

SDS/2 gives you the flexibility to integrate all aspects of your business with one software system. That concept is called Information Management. Each module by itself will save you time and money and by combining products to implement Information Management you receive more than twice the benefit in savings and productivity. So whether you need one SDS/2 software module or all these tools working together, Design Data can provide the most productive system for you.

For more information about SDS/2, information management in the steel industry or future product demonstrations call **800-443-0782**.

**DESIGN
DATA**

"First in...software, solutions, service"
402-476-8278 or 1-800-443-0782

© 1992 Design Data Corporation

90867

Life Cycle Cost vs Life Cycle Performance: Decision Criteria For Bridge Selection

By R. L. Nickerson and
David Veshosky, Ph.D.

This paper was originally presented at the 9th Annual International Bridge Conference, June 15-17, 1992, Pittsburgh.

Life Cycle Costs

While life cycle cost analyses are considered valuable in the making decisions involving bridge construction, at present only initial costs are typically considered in the evaluation of alternatives for superstructure material.

Recently, however, interest has been expressed in the use of life cycle costs as part of the decision criteria in evaluating such alternatives. Sections 134 and 135 of the 1991 Intermodal Surface Transportation Efficiency Act say that state-wide and metropolitan planning processes shall consider "life cycle costs in design and engineering of bridges, tunnels, and pavements."

However, implementing models for evaluating the life cycle costs for bridge material alternatives is virtually impossible at this time due primarily to the lack of reliable, consistent data on which to base an analytical model.

It is also due to significant variations among bridges that are currently in service, in terms of structural characteristics, usage and environment. Major changes in design criteria, construction methods and materials, inspection, maintenance and usage have occurred over the lives of bridges that are currently in service which also complicates a model. Such changes

would invalidate the applicability of life cycle cost models, since historic costs might be inappropriate as the basis for future decisions.

The difficulties in applying life cycle cost analysis to highway projects were reflected in a recent Federal Highway Administration (FHWA) decision concerning the use of life cycle cost criteria in evaluation of pavement types. The FHWA determined that reliance on life cycle costs in selecting pavement types was "unacceptable because the designs are not compara-

being placed on the need for bridge owners to develop and implement comprehensive bridge management systems, reliable data may become available in the future, making the use of life cycle cost criteria more appropriate.

Because of the lack of data on maintenance and repair costs, previous studies have had to rely on generic costs of typical structures or on the subjective, albeit expert, opinions of bridge industry professionals.

Prototype Life Cycle Cost Model

Life cycle cost models are based on the concepts associated with discounted cash flow analysis, wherein all the costs expected to occur throughout the life of a bridge are estimated and converted to an equivalent uniform annual cost (EUAC) for purposes of comparison. Costs which might be expected to occur during the life of a bridge and should, therefore, be considered in life cycle cost analysis, include:

- initial design, construction, and construction inspection;
- periodic inspection and preventive maintenance, such as washing, patching, and corrosion control;
- scheduled maintenance and repair, such as painting and resealing concrete surfaces under bridge joints;
- breakdown maintenance, such as repair of damaged members and expansion devices;
- rehabilitation, such as deck re-

Table 1:
U.S. Bridge Inventory
(as of January 1989)

Total Bridges.....	577,710
Deficient	42%
Structurally Deficient	24%
Functionally Obsolete	18%

ble, and the maintenance and rehabilitation costs are not supported by actual performance data" (*Civil Engineering News*, May, 1991). This would apply to selection of bridge types.

Use of life cycle cost criteria in evaluation of bridge construction alternatives could introduce as much uncertainty as it is intended to resolve, and might be used to justify decisions based on other considerations. Since evaluation using initial cost should be based on actual project costs rather than speculative estimates of costs, introduction of life cycle cost criteria at this time may not represent an improvement over the current system. However, with the emphasis

COMPOSITE STEEL BRIDGE GIRDER DESIGN

by
MDX software

MDX'S PC-based programs are currently being used under license by many of the largest ENR Top 500 Design Firms, as well as smaller firms and state DOTs.

- Generates and loads influence lines for up to twelve continuous spans, then designs on the first pass with a powerful optimization method (one that works!)
- Designs so that AASHTO specifications are satisfied, including fatigue stress ranges
- Latest AASHTO specification and interims
- Analysis or design mode, free-form input language
- Box girder, plate girder, rolled shapes
- All types of web haunches
- Horizontal (variable radius) curvature capability
- Automatic shear connector spacing
- Sequential slab placement studies for constructibility
- Dead and live load deflections
- Stress plotting on screen, printer, or plotter
(And many more)

To request a free trial of the program send fax with company cover sheet specifying:

- (1) Load Factor or Working Stress
- (2) 5.25" or 3.5" disks

or for more information, contact:

MDX software

Fax: (314) 446-3278

Ph: (314) 446-3221

- placement and repair or replacement of superstructure;
- upgrades, to improve the level of service;
- traffic delay costs attributable to maintenance, repair, rehabilitation or total replacement; and
- demolition, restoration of the site, and, if appropriate, replacement, net of any salvage value, of the existing bridge at the end of its useful life.

Many of these costs would be the same for all bridge construction alternatives. A valid life cycle cost model for comparing alternatives need only consider differential costs. However, information on these costs does not exist, rendering creation of a life cycle cost model inappropriate at this time. In addition, very few, if any, bridge owners consider traffic delay or increased inspection costs as part of the true cost of a bridge.

Life Cycle Performance

Bridge owners must still make decisions regarding the choice of structural materials. In the absence of reliable cost data, the records of past performance of the existing inventory of bridges is the only guidance that can be used to predict the life expectancy and cost-effectiveness of highway bridges. Owners may have to look beyond their own inventory to gauge this performance, keeping in mind that design practices may differ substantially, especially if their bridge population is "young".

Climate is the biggest factor affecting bridge performance. In the relatively benign climate of the southwestern United States, most materials will provide long and satisfactory performance, if properly designed. In these cases, the proper decision could be based only on first cost, including traffic delay costs. In the more severe climate of the northeast, where roadway deicing chemicals attack unprotected structures of any type, the material with proven ability to withstand these effects provides the basis for selecting the alterna-

■ Bateman™ ■ Buffalo™ ■ Davco (Bully)™
■ Dvorak™ ■ Edwards™ ■ Enerpac™ ■ Fabriline™
■ Ficep™ ■ Franklin™ ■ Gairu™ ■ Geka™
■ HMI™ ■ Hendley & Whittemore™ ■ Hill-Acme™
■ Ironcrafter™ ■ Kingsland™ ■ Kling™

■ Metal Fabricating Systems™ ■ Metal Muncher™ ■ Mubea™
■ Nitto-Kohki™ ■ Omera™ ■ Promoco/Omes™
■ Peddinghaus™ ■ Pels™ ■ Piranha™ ■ Scotchman™
■ Thomas™ ■ Uni-Hydro™ ■ W.A. Whitney™

**We've got your name,
now you've got our number.
1-800-446-4402**



When you need a punch, die, coupling nut or other tooling for your ironworker, there's only one name and number you need to know. Cleveland Steel Tool consistently ships standard in-stock items the same day or special shapes and sizes within 48 hours. And, we've made it easy for you to order with our "800" number - The Punchline. So call us today. There really is a difference.

THE CLEVELAND STEEL TOOL CO

474 East 105th Street • Cleveland, OH 44108

Table 2
ASCE Journal of Performance of Constructed Facilities
Vol. 4, No. 3, August 1990
Percent Structurally Deficient and Source

Bridge Type	Percent	Source
Simple Span Steel.....	23	Substructure
Continuous Span Steel.....	11	Deck
Prestressed Concrete Stringer.....	4	Deck
Prestressed Concrete Multiple Box.....	5	Substructure*
Prestressed Concrete Slab.....	3	Substructure*
Prestressed Concrete Tee.....	5	Superstructure*
Reinforced Concrete Slab.....	11	Substructure
Continuous Reinforced Concrete Slab.....	4	Deck
Reinforced Concrete Stringer.....	10	Substructure
Reinforced Concrete Tee.....	6	Substructure*
Continuous Reinforced Concrete Tee.....	3	Deck*

*Superstructure deficiencies

tive with the best proven performance record, without consideration of first cost.

Dominant structural types often change dramatically as state boundaries are crossed. What leads one state bridge owner to select a different structure than that used in an adjoining state? Obviously each owner is satisfied that they are providing the best solution based on available funds. But, are they making decisions based on comparison of performance of equal structures in exactly the same climate, loading and maintenance situation over a period long enough to truly evaluate performance? Since this cannot occur, decisions tend to be biased based on the individual owners cumulative experiences during their professional careers.

Evaluations Using National Bridge Inventory

Recently, papers by Dr. Kenneth Dunker, of Iowa State University, and Dr. Basile Rabbat, of the Portland Cement Association, were published in the *ASCE Journal of Performance of Constructed Facilities* and *Concrete International*. Both papers relate to the performance of the nation's bridges.

The authors used a portion of the Federal Highway Administration's National Bridge Inventory (NBI) as the basis for their analysis. The "headline" of the *CI* article is "Concrete Tops Other Materials in National Bridge Inventory". What better advice does a bridge owner need than that drawn from the NBI? However, this conclusion cannot be obtained from the NBI data, because it does not contain enough detailed information.

The NBI includes data indicating the condition of various elements (deck, substructure, superstructure) of a bridge, as well as an overall judgement on the structural condition. But, the fact that the bridge deck on a steel bridge is deficient cannot be an indictment of the "steel" bridge, especially in light of a recent survey of State Bridge Owners by the Chairman of the AASHTO Bridge Subcommittee, concerning bridge deck cracking.

Thirty of the 36 states that responded indicated cracking of new decks is a problem, and should be studied. Eleven of these responses indicated that the type of superstructure was a potential cause of cracking; seven of the eleven indicated decks on both steel and concrete bridges crack; one of these seven states indicating that steel bridges cracked more severely, and

MERLIN DASH NEW VERSION 4.5

Design & Analysis of Straight Steel Girder Bridges

- ✓ AASHTO — 1991 Interim
- ✓ FHWA — Endorsed and Used by
- ✓ DOT's — Used by Most States
- ✓ Design — New Capability
- ✓ Menu-Driven Input — Very Easy
- ✓ Graphics Display of Output
- ✓ Output Report Selection

IBM-PC Compatible
Free Trial Period

MICROBARS

Micro-Computer Bridge Analysis & Rating System

- ✓ Derived from Original BARS Program
- ✓ Compatible with DOT's Structural Databases
- ✓ Rates All Conventional Member Types
- ✓ Considers All Construction Materials

DESCUS I & II

CURVED GIRDER ANALYSIS & DESIGN
 ...and other quality bridge software and time-sharing services

Available Exclusively Thru:

(215) 867-4077



PTI-MATE

P. O. Box 9097, Dept. A, Bethlehem, PA 18018

DESCON

DESIGNS AND DETAILS
 STEEL CONNECTIONS

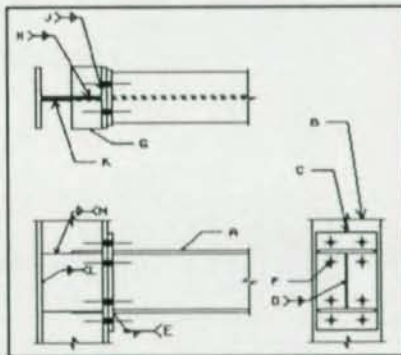
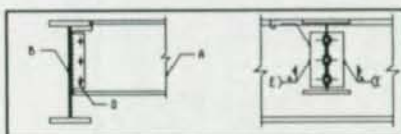

FOR A FREE DEMO DISK
 CALL OR WRITE TO

OMNITECH ASSOCIATES

P.O. BOX 7581
 BERKELEY, CA 94707
 (510) 658-8328



Apply metal coatings to resist abrasion, corrosion, erosion, fretting, friction, or galling. Salvage improperly machined parts, rebuild worn areas, or apply wear resistant coatings to finished parts that will outwear the originals by factors of two, three or more.

We are a full-line manufacturer of thermal spray equipment and products. Let us help you save money by solving your coating equipment needs. Write or call us today for more information on our complete line of thermal spray products and equipment.

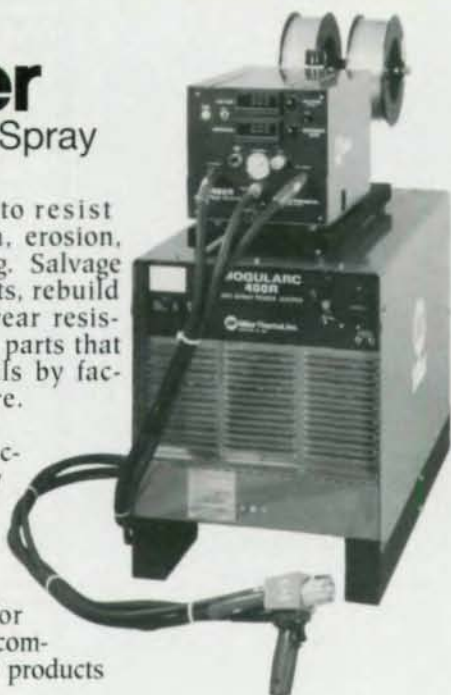

- Arc Spray
- Flame Spray
- HVOF
- Plasma Spray

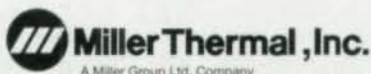

555 Communication Dr. • P.O. Box 1081 • Appleton, WI 54912
Tel. 414-731-6884 • Fax: 414-734-2160

one of the seven indicating that concrete cracked more severely. Three states indicated that only decks on steel bridges cracked and one state indicated only concrete bridges experienced deck cracking. The NCHRP currently has a contract underway to further explore the causes of deck cracking nationwide. If cracking of concrete is an indication of deficiency, very few concrete structures could be coded otherwise.

The portion of the NBI database used by Dunker & Rabbat (ASCE Table 2) indicates that 22% of steel and concrete bridges have decks designated as the most common source of deficiency. (Timber bridges are excluded from this discussion). Of these, half are steel and half are concrete. However, it is unlikely the deck condition on either type of bridge is an indictment of the material used in the superstructure.

Similarly, the condition of substructures under either steel or concrete superstructures is not an indicator of the bridge's performance. Dunker and Rabbat note (ASCE Table 2) that 58% of the steel and concrete bridges have substructures designated as the most common source of deficiency. Of the bridges with substructure deficiencies, 40% were steel bridges and 60% were concrete. Yet virtually 100% of the substructures are concrete. This does not mean steel bridges are outperforming concrete bridges. What it may mean is that leaking bridge joints are a major factor that adversely influences the long-term performance of substructures on all types of bridges.

Complicating the matter even further is the NBI coding instructions, which are to assign a single condition rating for each element of the bridge (e.g. deck, superstructure, substructure) to represent the condition of that element on the entire bridge. Thus, if one beam in one span of a bridge containing 50 spans had a structural problem, the entire bridge would be classified as deficient! Some bridge owners recognize this short-coming of the NBI in trying to make performance decisions. One example of this is

ATTENTION STEEL & BRIDGE FABRICATORS

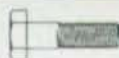

ANCHOR BOLTS, PLATE & SLEEVE ASSEMBLIES, TIE RODS, STUDS, SWEDGE BOLTS, U-BOLTS, HEX BOLTS & EYE BOLTS



Custom fabricated to exact specifications from certified domestic steel up to 4-inch diameter and 40-foot lengths in steel & alloy.

STRUCTURAL BOLTS, NUTS & WASHERS in A325, A490 & TENSION CONTROL BOLTS, WELD STUDS, CONCRETE ANCHORS, B-7 STUDS, CLEAVISES, TURNBUCKLES and all types of fasteners in various grades and materials; plain, plated and galvanized.

Stocked for immediate shipment

**★ SAME DAY SHIPPING ★
OVERNIGHT TO MOST U.S. CITIES**

MID-SOUTH BOLT & SCREW

Central States
499 Cave Road
Nashville, TN 37210
615-889-8341
FAX: 615-885-6542
1-800-251-3520

East Coast
59 Liberty Road
Emporia, VA 23847
804-634-0240
FAX: 804-634-0541
1-800-366-BOLT

Gulf Coast
ALLIED BOLT
1763 Wooddale Court
Baton Rouge, LA 70806
504-926-5600
FAX: 504-926-5996
1-800-375-7775

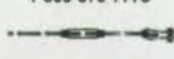
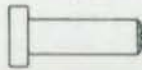

New York City, which instructs their bridge inspectors to code the number of deficient spans. They have approximately 840 bridges, consisting of 5,500 spans. Thus, deficient spans is a more meaningful number in their case.

If it were possible to use the NBI to analyze deterioration rates of bridges, it would have to be limited to the superstructure elements. Table 2 of the *ASCE Journal* article notes that only 5% of the bridges have superstructure problems classified as the most common source of deficiency. Since the only bridge types noted in Table 2 with deficient superstructures are of reinforced or prestressed concrete, it is difficult to understand the conclusion drawn: "Concrete Tops Other Materials..." This prospect is even more difficult to understand when one recognizes that the data clearly show that the concrete elements, deck and substructure, on steel bridges are the source of deficiency, not the steel superstructure.

Work is underway at Lehigh University to better quantify deterioration rates of America's bridges. This work will be available soon. FHWA is also sponsoring development of a Bridge Management System model, called PONTIS, that will provide for the first time a nationwide, uniform system to assess deterioration of each bridge component. Thus, if one beam of 100 on a bridge is deficient, only one percent will be coded deficient, not the entire bridge or even the entire span. PONTIS will also provide deterioration models to predict future needs, based on documented past performance.

in-service experience

On-site repair capability: Neither the Dunker/Rabbat paper, nor the above analysis should be interpreted to mean that there are not deficient steel superstructures on bridges included in the nation's inventory. The technical literature has many pictures and articles related to deficiencies of steel bridges, going to great lengths to por-

tray extreme rusting or fatigue cracking and/or fracture of steel members. Unfortunately these articles usually fail to point out that steel deficiencies have been repaired by simple bolted or welded field splicing, or by drilling a hole, or that the number of these instances has occurred on only a very small fraction of the total number of steel members.

After repair, which is often accomplished without taking the bridge out of service, these steel bridges do not require any reduction in load capacity or projected remaining service life. Thus, a major advantage of a steel superstructure is *they are repairable*, and at reasonable costs.

Experience with deteriorated concrete bridge elements has not been as good. Many substructure concrete repairs (for both steel and concrete bridges) have not been successful and require continual repair until replacement of the concrete element is completed. If the deterioration is related to corrosion of the reinforcing steel, cathodic protection, although still in the research stage, offers some hope to enable permanent repairs to be effected. However, this then requires continuous maintenance over the remaining life of the concrete element.

The Organisation for Economic Cooperation and Development (OECD) published a report in 1989 entitled "Durability of Concrete Road Bridges". The Executive Summary notes in part:

"The analysis of the causes and mechanisms of deterioration fully supports the notion that the decay of concrete structures is a very complex, irreversible physico-chemical process involving a number of interactions constantly changing over time during the life of the structure."

The report describes the consequence of inadequate bridge design and construction in an adverse environment and deals with the deterioration processes caused by external as well as internal actions....

"Ancillary bridge components

Joist in Time!

The new SJI 1992 catalogue for steel joists and joist girders is here.



It's bigger and better than ever before, making it even easier to specify and use steel joists and joist girders.

All 1992 revisions are listed in front so changes can be reviewed quickly and easily. And the section on fire-resistive assemblies has been expanded and completely revised. It now lists criteria for using K-Series Joists in an assembly and includes a simple, five-step procedure for selecting the proper and most economical joist. In addition, the catalogue lists over 70 floor and roof assemblies, with specific UL designations. You'll find specs for the welding of Longspan Joists, Deep Longspan Joists, Joist Girders and much, much more.

Order yours today. It's joist what you needed.

1992 EDITION!

Standard Specifications, Load Tables and Weight Tables for Steel Joists and Joist Girders. \$10.00 per copy.

Number of copies: _____

VIDEO SEMINAR AVAILABLE.



This 28-minute learning tool shows how to specify the right steel joist for each job, quickly and correctly. \$34.95 charge includes all shipping.

Managing Director
Steel Joist Institute
Division A-1
1205 48th Avenue North
Myrtle Beach, SC 29577



Total enclosed _____
Payment includes first class postage and handling and must accompany order.

Name _____

Firm _____

Address _____

City _____

State _____ Zip _____



Durability of concrete is an increasingly serious issue. The decline of the load carrying capacity of deteriorating concrete road bridges is not yet fully understood.

have always played a major role in the maintenance of structures and Chapter III deals with a number of the most important details and their effect on durability. They include joints, bearings as well as surfacings, overlays, waterproofing, parapet beams and socles, safety systems, gutters, drains, discharge pipes, etc.

"The decline of the load carrying capacity of deteriorating concrete road bridges is a very important problem that is not yet fully appreciated or understood ..."

The OECD comments regarding the influence of ancillary components on deterioration are equally applicable to steel bridges, as is the concern for "external and internal actions" which affects the integrity of the concrete components of a steel bridge. An understanding of the deterioration of the concrete load carrying capability is important for all types of structures.

Design influence: In general, the performance of bridges, both concrete and steel, are influenced more by the designers selection of details than by the behavior of the material itself. The ASCE Manual "Quality in the Constructed Project", notes that 70-80% of the influence on a project's quality and cost is determined at the design phase. A bridge joint included at the design stage that leaks salt water, will cause a reduced service life of any element below. Likewise, the designer including fatigue-prone details on a steel girder will cause a need for retrofit at some point in its service life.

Table 3:
Estimation Of Mean Service Life
Belgium Method

Country	Avg. Life, Years		
	Steel	Concrete	
		R/C	PS/C
Belgium	68	72	42
Japan	47	47	21
	50	57	35
Sweden	76	73	
Finland	75	86	

Effects of corrosion: The influence of chlorides on reinforcing steel, especially in bridge decks, is well understood. The effect on prestressing steel is not. There is little doubt that chlorides can penetrate through even uncracked prestressed concrete. The presence of chlorides has caused a few instances of broken prestressing steel. Unfortunately, the state-of-the-art for concrete "member" inspection is not very good in the area of nondestructive evaluation (NDE) to be used to assess internal concrete or prestress steel conditions. This should be a consideration by those responsible for selecting bridge type.

The FHWA has a major research initiative underway on "Prestressed Concrete Protection", to identify protection strategies for prestressing steel in new and existing prestressed concrete bridges. Similarly, reduction in performance of the concrete matrix itself, as indicated above by the OECD report, is virtually impossible to predict with current NDE techniques.

In contrast, the load carrying capacity of steel superstructure members can be readily determined using currently available NDE and analytical techniques.

International Survey: Another very recent source of information on performance of steel and concrete bridges is the 1992 OECD publication "Bridge Management". Data contained in a chart titled: "A Posteriori Estimation of Mean Service Life of Steel and Concrete Bridges According to Belgium

Method", is partially reprinted in Table 3.

A cursory review of this information indicates steel has outperformed prestressed concrete in bridges, and almost matched the performance of reinforced concrete bridges.

U.S. Experience: The relative performance of prestressed concrete and steel bridges can be compared in the area near Philadelphia. This is the location of the first major prestressed concrete highway bridge in the U.S., namely the Walnut Lane bridge over Fairmount Park, which was built in 1950, and replaced in about 1990. Just across the Delaware River, in New Jersey (only about 7 miles away), is the oldest known all-welded highway bridge in the U.S., over Rancocas Creek, located in the town of Riverside. This bridge was put into service in 1934, and is still carrying traffic today. It is restricted to a 15T load limit, probably because that was the design load of the 1930s. (The 1931 AASHTO Specifications included only H10, H15 and H20 as design live loads).

Conclusions

Selection of superstructure material should only be made after careful consideration of all factors that will influence life-cycle performance, including life-cycle costs. It is clear that the latter cannot be quantified at this time.

The NBI cannot be used to draw conclusions on relative performance of materials because the data are not sufficiently detailed. Therefore, factors such as the ability to inspect and repair, to replace decks, and traffic delays during rehabilitation are only some of the factors a bridge owner must consider carefully and should be based on observations of actual case histories, before the decision on material is made.

R.L. Nickerson is a consultant with N B E, Ltd., in Hampstead, MD, and David Veshosky, Ph.D., is an assistant professor of civil engineering at Lafayette College in Easton, PA.

(0.6") tendons. The tendon deviators of the lower flange are welded to the hexagonal steel tube. At the top, over the intermediate piers, the tendon deviators are welded to the transverse floor beams which here are stiffened. The typical 12-strand external tendon used consists of individually sheathed greased monostrands placed in a polyethylene tube filled with cement grout prior to stressing. This technology was used because it enables the stressing operation to be phased very gradually and limits the size and weight of the tensioning equipment.

Future Applications

The composite truss used to construct the Roize bridge is both lightweight and very stiff in resisting vertical loads. These favorable characteristics have led to applying this structural system to cable-stayed spans.

Figure 4a shows an overpass bridge where cable-stays are anchored in the transverse center of the cross section. Here, a vertical member is placed between the bottom chord and transverse beam of Figure 2 to transfer the stay uplift of load onto the bridge.

The stays are anchored at the apex of a four-legged pylon, providing a unique appearance. The pylon legs are constructed of welded steel tubes that are filled with concrete after they are placed in their final position. The entire bridge deck is constructed on conventional falsework prior to receiving the cable stays. External longitudinal post-tensioning is stressed as required to maintain compression in the truss under superimposed loads.

A similar bridge as the one described above is the recently completed Aire de Farges Bridge over the A71 Highway between Bourges and Clermont-Ferrand in central France (Figure 4b). This bridge is approximately 200' in length between abutments. Here, the superstructure consists of a concrete slab and the pylon is composite.

The composite space truss also can be used for long span projects, such as Jean Muller's proposed de-

SLUGGER® by Jancy Engineering Co. 
 Manufacturer of Portable Magnetic Drilling Systems

2735 Hickory Grove Road, Davenport, Iowa, USA
 Phone 319-391-1300 FAX 319-391-2323
 Ask for Pat, Steve or Jeff

Call for a
 Demonstration
 Today

Lightweight-Accurate
 Durable-Convenient
 Affordable

Made in
 America's
 Heartland



IOWA



Available Exclusively Through the Best Stocking Distributors

A Quick Quiz For Structural Engineers

The more a computer program costs, the better it is. TRUE FALSE

A program that solves complex, difficult problems must be complex and difficult to use. TRUE FALSE

Structural engineering software can never be fun to use. TRUE FALSE

If you answered *TRUE* to any of the above, or you would like to know more about a truly innovative software program, call us!

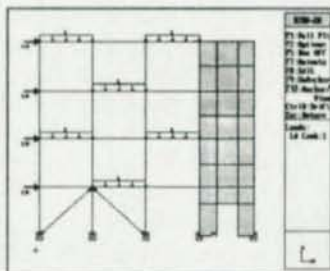

RISA-2D

Your complete solution for
 frames, trusses, beams,
 shear walls and much more!



26212 Dimension Drive, Suite 200
 Lake Forest, CA 92630
 1-800-332-7472

IT'S HERE!
A Brand NEW
Publication
For Safe
Construction
Practice in
Steel Floor
and Roof Deck
Installation



"SDI MANUAL OF CONSTRUCTION WITH STEEL DECK"

is a new and complete guide to safe construction. It covers responsibilities for Design, Specification, Bundling, Loading, Unloading, Hoisting, Placing, Attaching, Placement of Construction Loads. It serves as a safety primer for Contractors, Erectors, Architects, Engineers and Inspectors who are responsible for safe and proper field installation of Steel Deck.

PRACTICAL...
EASY TO READ...
EASY TO FOLLOW...
EASY TO TAKE TO THE JOBSITE...

BRAND NEW - FIRST PRINTING
SDI MANUAL OF CONSTRUCTION
WITH STEEL DECK - No. MC01

Quantity @ \$18.75 each

U.S. Currency Total

Out of Continental U.S. Add 15%

Call SDI for Special Shipping such as Express Mail, Air Mail, etc. - additional

TOTAL ENCLOSED

NAME

ADDRESS

CITY

STATE ZIP

ALLOW 3 TO 4 WEEKS FOR DELIVERY

STEEL DECK INSTITUTE

P.O. Box 9506 Canton, Ohio 44711 (216) 493-7886

THE EBRON BRIDGE

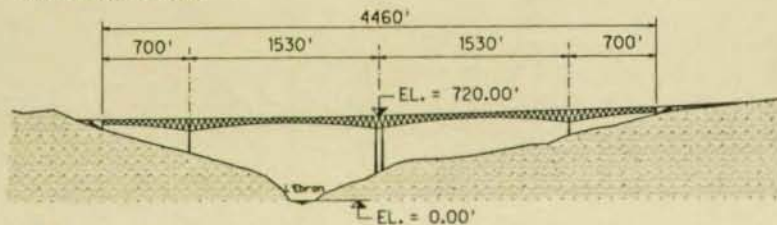

Fig. 6. General Elevation

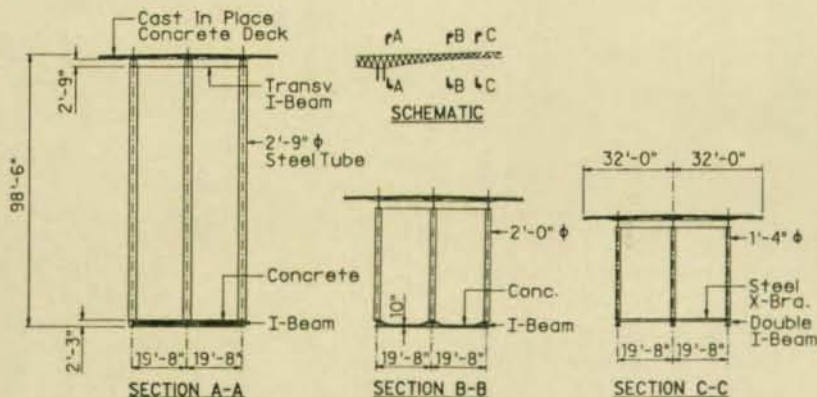

Fig. 7. Cross Sections

sign of the Normandy bridge in France (Figure 5). Here, the composite truss was designed for a cable-stayed mainspan of 2,870'.

For wider bridge decks, parallel triangular truss structures may be placed adjacent to one another and connected together transversely at the bottom chord members.

The Ebron Bridge

This composite haunched truss was designed for the A51 motorway between Grenoble and Sisteron, France. It is currently under review by the Highway Administration to transverse the Ebron Valley. The unstable soil conditions beneath the structure required a minimum span length of 1,530'. The bridge consists of four spans (Figure 6) of 700', 1,530', 1,530', and 700' and is continuous between abutments. The piers are cast-in-place and slender to accommodate deck movements. The 4,460'-long bridge carries four lanes of traffic 720' over the valley floor.

The bridge is composed of composite top and bottom slabs connected by steel truss members. The truss members are tubes located in

three vertical planes (Figure 7) so as to efficiently distribute the dead load and live load shear forces. The bottom slab geometry follows a circular intrados resulting in a structure depth of 40' at midspan and 98' adjacent to the pier.

The structural elements of the haunched truss are summarized as follows:

- The three vertical Warren type trusses consist of steel tubes varying in outside diameter from 2'-9" adjacent to the pier to 1'-4" at midspan. The tube wall thickness averages 3/4".
- The composite top and bottom flanges are composed of steel I-beams and concrete. In the top chord, the concrete slab is placed above the steel I-section and carries the local bending in composite action. In the bottom chord, the concrete is cast between the I-section except in the middle third of the bridge. In this region, the steel I-beams are doubled and carry both the compression and tension resulting from imposed forces due to live load, superimposed dead load, creep and shrinkage. Both the top and bot-

Innovations In Composite Bridge Structures

The combined use of steel and concrete can result in cost-competitive short- and long-span bridges

By Jean Muller and James D. Lockwood, P.E.

Three unique composite bridges have recently been designed by J. Muller International. These bridges feature different construction methods and structural systems and have spans ranging from 120' to 10,000'.

The Roize Bridge

This two-lane prestressed composite truss was recently constructed over the Roize River on the A49 motorway between Valence and Grenoble, France. It was selected by the French Highway Administration as an experimental bridge as a result of its original design concept to lighten bridge decks of medium span bridges. Their study included both fatigue and ultimate load testing on a separate full scale bridge section.

The structure consists of three spans of 118', 131' and 118' (Figure 1) and is continuous between abutments. The bridge follows a 1,755' radius and the transverse slope of the deck varies from zero to 3.5%.

The Roize bridge superstructure consists of a precast, pretensioned concrete deck slab supported by a steel space truss (Figures 2 and 3 show a typical cross section and an elevation detail, respectively). The composite system is post-tensioned both transversely and longitudinally.

The space truss is comprised of the following elements:

- A single hexagonal lower flange made of two bent steel plates

THE ROIZE BRIDGE

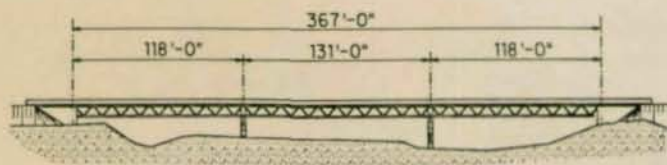

Fig. 1. General Elevation

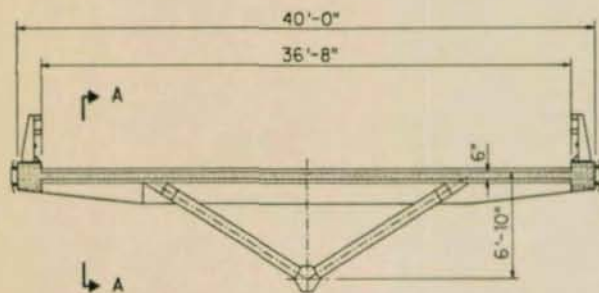

Fig. 2. Typical Cross Section

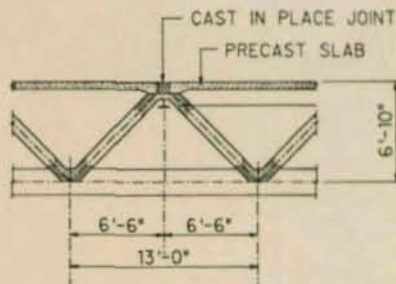

Fig. 3. Elevation Detail



The top photo shows the completed Roize bridge, while the second photo is a CAD rendering of a potential future application (Figure 4a). Shown is a cable-stayed bridge where the cable-stays are anchored in the transverse center of the cross section. The stays are anchored at the apex of a four-legged pylon, creating a unique appearance.

varying in thickness from $\frac{3}{4}$ " to $1\frac{3}{16}$ ". The two plates are joined by continuous longitudinal welds. The steel tube is stiffened by four internal diaphragms located at the intersection with the truss diagonals.

- Two inclined Warren type trusses carry the longitudinal shear. The diagonal members are assembled using four steel plates to form a rectangular cross section. The plates vary in thickness from $\frac{5}{8}$ " to $1\frac{3}{16}$ ". The diagonals are welded at 13' intervals to the hexagonal tube at the bottom and to the transverse floor beams at the top.
- Transverse floor beams spaced 13' apart are made of I-shaped steel sections. The top flange of these floor beams bear the edges of the precast deck slabs and are used as formwork for the cast-in-place transverse closure joint between deck elements. At the intersection with the Warren truss diagonals, the webs and top flange of the truss members are extended through the floor beams to create a rigid node. This node is filled with concrete when the closure joint is cast and assists in the transmission of transverse forces.

The precast concrete deck elements are 40' wide and 12'-4" in length (average). The elements actually are trapezoidal shaped to accommodate the bridge curvature. The deck slab varies from a $5\frac{1}{2}$ " typical thickness to $8\frac{5}{8}$ " over the floor beams. The 28 day characteristic strength of the concrete is 11,500 psi, but for the calculation, a 28 day design strength of 8,700 psi was used. The precast elements are pretensioned longitudinally by 54 0.5" bonded strands. This not only assists in carrying the local bending forces between floor beams but also reduces the overall creep affects by pre-compressing the concrete. Two 4-strand tendons (0.6") located on either side of the floor beam are post-tensioned transversely after concreting the closure joints.

After the deck is entirely assembled, it is prestressed longitudinally using five external 12-strand

HERE'S THE HUCK DIFFERENCE.

TENSION/TENSION

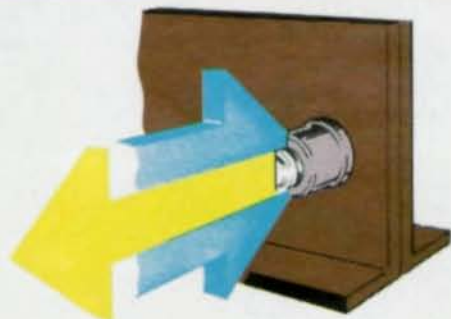

Huck Lockpin & Collar fastening is secured by applying direct, straight-line tension to a grooved fastener against a metal collar to pull workpieces together. This collar is then swaged ("squeezed") to cold flow the metal into the grooves and elongated in the process to create a precise clamp load.

The Huck Lockpin & Collar fastener has a controlled predetermined clamp force that is built into the design of the fastener and cannot be altered by the installer.

Workpieces are pulled together and clamped during the swaging action without applying torque. On completion of collar swage, the gripping pintail separates, leaving a permanent, vibration resistant fastener. Huck Lockpin & Collars are fully capable of being snugged to remove gap prior to final swaging.

Lockpin & Collar fastening is a well-known, modern concept which is gaining added acceptance in many tough applications for its simple, accurate installation, dependability, and performance.

(1) Workpieces, members to be joined, are put into position for fastening with the Lockpin inserted.

(2) The collar slides easily and freely over the Lockpin grooves up to the workpiece prior to swaging action.

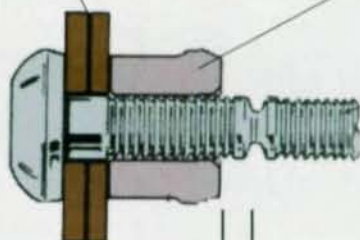

Before

(3) This pintail is the gripping surface for the installation tool that parts company with the fastening at a tension point predetermined by metallurgy and dimension.

Elongation = Clamp

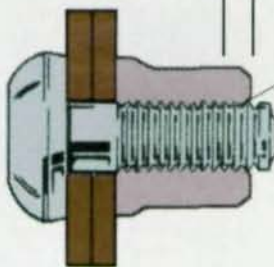

After

(4) When installed, the tool pressure cold flows the collar metal sequentially into the grooves and elongates the collar against the work piece for positive tension - there's no back-off. Inspection after the fastening is visual, quick and simple. If it's fastened, it's fastened right!

TORQUE/TENSION



A nut and bolt is installed by applying torque to the nut; first, the torque to pull the workpieces together, then tension is added by torquing to create clamp force.

A torque wrench does not read tension. It indicates torque of the nut against a surface friction.

In addition, torque/tension sufficient to create proper clamp force creates a torque stress in the bolt, in varying degrees, dependent upon size, application and surface condition.

The thread of the bolt also provides a ready back-off path for the nut in any vibratory environment.

Nut and bolt fastening is a familiar, traditional method which is not reliable or permanent.



Huck International, Inc.

Industrial Fastener Division
8001 Imperial Drive
Waco, TX 76714-8117
817-776-2000, Telex 73-0985
Fax 817-751-5274
800-285-HUCK



The Future Of Fastening Technology.™



See Us At The
AEC Expo
October 19-21

With MicasPlus, Analyze And Design Up To 4 Times Faster.

Gain the competitive advantage. Boost your productivity with MicasPlus.

Unparalleled integration. Only MicasPlus integrates modeling, analysis, design, and drawing production into one package.

Tasks that used to take days now take only hours. Single point-and-click interface. One-to-one relationship between physical and analytical models. No translation. No redrawing.

Comprehensive capabilities. At last, a system that lets you design projects your way. Because MicasPlus works the way you do, you

always model in true scale – placing steel and concrete members in 3D space as they would actually be built in the field. A column needs to be moved? Move it – and watch connected framing adjust associatively. Just as easily, you evaluate alternative framing schemes. Define an unlimited number of load cases and combinations. And rely on MicasPlus to help keep each phase of the project on track.

It's no wonder some customers have seen productivity gains of up to 4-to-1.

For details, call 800-826-3515. Or contact your Intergraph representative.

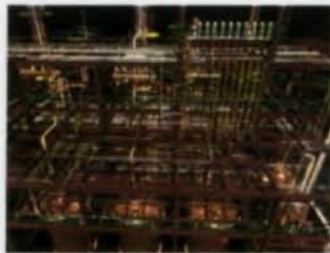

INTERGRAPH
Everywhere you look.

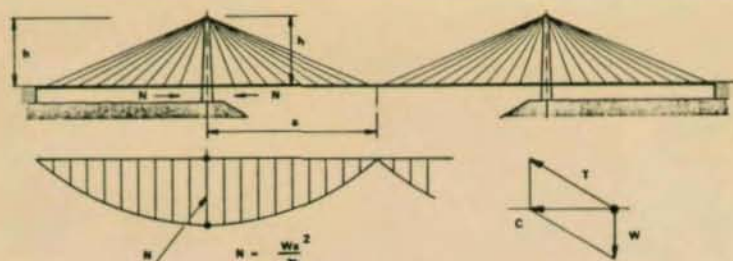

Fig. 8 Generalized cable-stayed bridge schematic

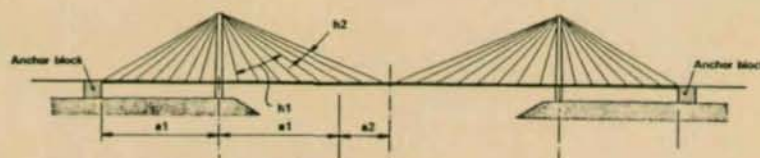

Fig. 9 Generalized bi-stayed bridge schematic

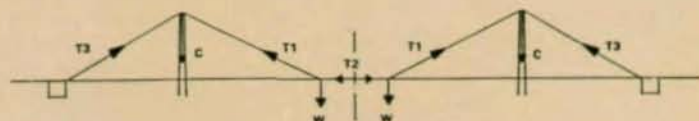

Fig. 10 Force distribution placing tension at midspan

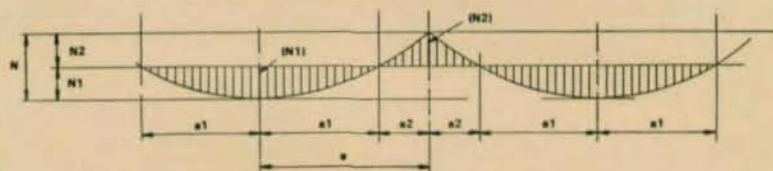

Fig. 11 Axial forces in deck without prestress

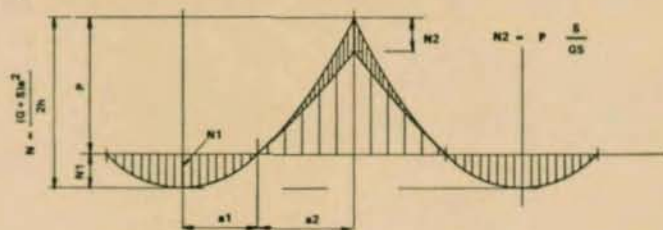

Fig. 12 Axial forces in deck with prestress

THE BI-STAYED BRIDGE

tom concrete slabs are post-tensioned transversely. The vertical tube members are welded to the top and bottom chord I-sections.

All concrete used in the superstructure is cast-in-place and has a strength of 9,000 psi. The deck width is 64' and cast in 50' increments. The longitudinal post-tensioning is external and consists of 19 (0.6") and 12 (0.6") strand tendons placed in cantilever. The use of continuity post-tensioning at midspan is minimal and only necessary to ensure compression in the concrete deck slab.

The Bi-Stayed Bridge

A new bridge concept using both self-anchored and earth-anchored stays was developed that demonstrates the possibility of extending the limit of the maximum clear span of a stay supported deck to 10,000'—using available materials and the usual proportion between dead and live loads. The bi-stayed bridge features inherent deck rigidity under traffic loads and a low construction cost that rivals the economics of long-span suspension bridges. Conventional

construction methods can be used for this innovative bridge system.

In developing the principles of the bi-stayed system, the load-carrying characteristics of the cable-stayed bridge were reviewed (Figure 8). In this case, the deck is suspended from multiple stays spread uniformly along its length more or less symmetrically on either side of the pylon. For a deck supporting a total load w per unit of length, and assuming that all stays are anchored at the top of the tower, the axial load in the deck varies parabolically from zero (at midspan and extremity of lateral span) to a maximum value N around the pylon equal to $wa^2/2h$. To simplify, the weight of the stays is not included. The span range of the cable-stayed bridge is therefore determined by the capacity of the deck to resist this axial compressive force.

In its simplest form, the bi-stayed bridge (Figure 9) is an extension of the cable-stayed bridge in that the entire mainspan is supported by stays. The cable-stays consist of both self-anchored and earth-anchored cables. The self-anchored stays (h_1) are located in the sidespans of the bridge and are distributed over a nearly equal length (a_1) away from the pylons in the mainspan. The earth-anchored stays (h_2) are of greater length and anchor into the deck over the remainder of the mainspan (a_2) at equal distances away from the center keystone. The earth-anchored stays bend over the pylon tops and anchor into a separate anchor block located immediately beyond the extremity of the structure. These stays, therefore, cause no further compression in the bridge deck near the pylons.

However, the balance of axial loads between the stays and the deck in the central part of the bridge (Figure 10) creates a series of tensile forces such as T_2 , which accumulate to cause a total axial force of N_2 (Figure 11) starting at the keystone in the central span.

The total axial force N in the deck of the mainspan created by the horizontal components of the earth-anchored stay forces consists

of a compressive force N_1 at the pylon and the tensile force N_2 at the midspan. Assuming that the vertical loads are constant along the deck and neglecting any influence of the non-uniform weight of the stays, it can easily be found that if $a_1=0.7$ so that $a_2=0.3a_1$, the result is $N_1=N_2=N/2$. It is therefore possible, with the same material components, to increase the length of the mainspan in a ratio of $1/0.7$ or 1.4.

The mainspan length may be increased further using a second innovative device. In the bridge deck, the tensile force T_2 can be compensated by an internal deck prestress so that when the deck bears all its loads (live loads included), the axial force at the keystone of the central span is zero. The maximum force at the keystone will therefore occur when the deck only bears its permanent loads and is compressive. In other words (Figure 12), the resulting compressive force N_2 under stay forces and internal prestress is only produced under permanent loads while the force N_1 in the deck at the pylon is produced under all loads, including live load. In a bridge with spans over 3,000', the permanent loads G are three times greater than the live loads S , so that $G=3S$ or $G+S=4S$.

From the diagram in Figure 12, it is shown that the total reference force N now consists of $N=N_1+P$, with P being the prestress force calculated to balance the total load $G+S=4S$. Therefore, the remaining force at the keystone in the mainspan is only $N_2=P/4$. The optimum equilibrium will be obtained when $N_1=N_2=P/4$, so that $N=N_1+P=5P/4$ and $N_1=N/5$. Theoretically, the maximum span of the bi-stayed bridge is 2.2 times that of a conventional cable-stayed bridge, thereby making it possible to attain span ranges comparable to those of suspension bridges.

Figure 13 compares the deformational behavior of the 4,000' main span bi-stayed bridge and a similar suspension bridge, with design loads placed in the most unfavorable position for maximum de-

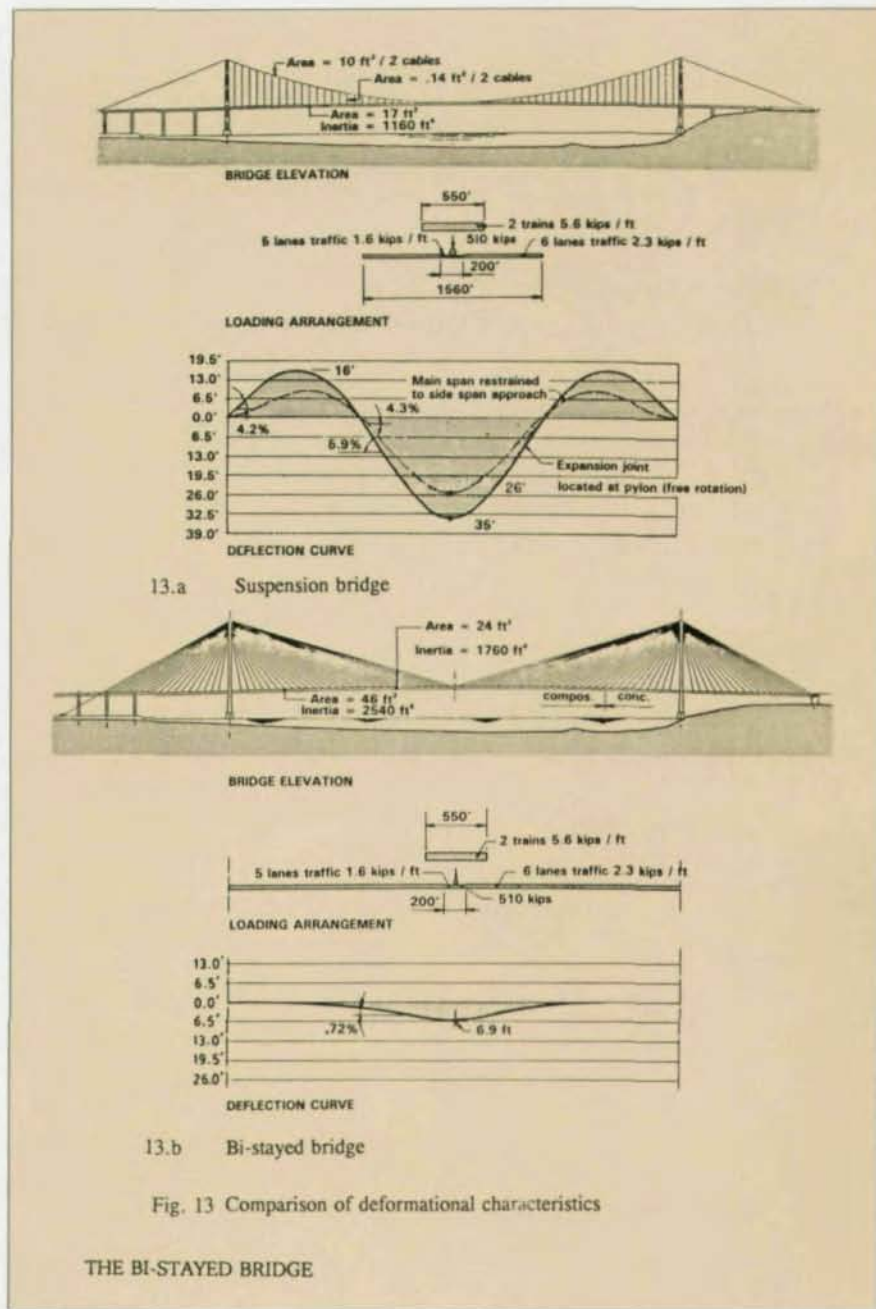

Fig. 13 Comparison of deformational characteristics

THE BI-STAYED BRIDGE

flexion. In the suspension bridge, the maximum deflection occurs when 40% of the mainspan is loaded. Under these conditions, the midspan deflects 35' and the maximum change in longitudinal slope is 5.9%. For the bi-stayed bridge, the maximum deflection occurs when the entire mainspan is loaded. In this case, the midspan deflects only 6.9' and the maximum change in longitudinal slope is 0.72%. From these calculations, the rigidity of the bi-stayed bridge is obvious.

The bi-stayed bridge offers the engineer the span range of the suspension bridge with the long-span qualities of the cable-stayed bridge. Because both the construction methods and materials used are conventional, this new system will offer economic advantages as well.

Jean Muller and James D. Lockwood, P.E., are principles with J. Muller International, an internationally renowned bridge engineering firm with offices in Paris, Chicago, San Diego, Tallahassee, FL, and Bangkok.

00874

Bringing Bridge Design Into The Next Century: The Construction Of The Roize Bridge

By Serge Montens and David O'Hagan, P.E.

Few travelers crossing the Roize River on the A49 motorway near Grenoble, France, realize they are riding on an experimental bridge designed with the next century in mind. The superstructure for the bridge is the result of almost 10 years of research by various engineers on reducing the weight of medium-span bridges. And while designed as a medium span bridge with the largest span stretching only 131', this post-tensioned steel space truss can also be used for long-span cable-stayed bridges.

General Arrangement

The experimental ramp crosses both the river and two buried natural gas pipelines.

While the river is normally slow moving, a dam located upstream from the bridge site results in occasional heavy flooding. Also, the pipeline locations dictate a 118'-131'-118'.

The roadway geometry of the ramp places the structure on a spiral horizontal curve, a superelevation transition and a convex vertical curve. The typical section requires a 3.3' inside shoulder, two 11.5' lanes and an 8.2' outside shoulder.

Superstructure

Because other reduced-weight experimental bridges in France have been constructed with steel webs replacing the heavy webs of concrete box girder construction, the designers of the Roize bridge tried an alternate lightening approach of replacing the concrete webs with steel trusses. Additionally, weight reduction was achieved by using precast, biaxially prestressed, high-strength concrete deck panels.

The deck is a prestressed composite truss consisting of the following key elements:

- A single bottom flange made into a hexagonal tube;
- Two inclined Warren truss planes
- Transverse floor beams;
- Precast high-strength concrete deck panels; and
- Continuous draped longitudinal post-tensioned tendons.

The steel frame is composed of mass produced, factory welded tetrahedrons. Each tetrahedron consists of one floor beam, four diagonals and a 13' section of bottom flange.

The floor beams are I sections fabricated from A441 plate. Shear connectors welded to the floor beams consist of angle sections onto which U-shaped bars have been welded. This configuration permits the transmission of shear due to transverse bending while improving the fastening of the precast slabs against lifting.

The truss diagonals are welded box sections. These diagonals are connected to the floor beams and top slab by a steel node. The steel node consists of two thick triangular plates that continue the diagonals' webs and are eventually embedded in the concrete slab. Various A441 plates welded to the nodes complete the composite action of the system.

The hexagonal bottom flange is fabricated from two folded metal plates assembled by continuous longitudinal welding. It is stiffened by four diaphragms located under the diagonal connection points. A633 Grade D material is utilized here because A441 steel would make folding a much more delicate operation and would probably require considerable pre-heating.

Each tetrahedron module is fab-

ricated on two jigs. X-ray testing of all welds and a shop fit of adjacent modules also occurs prior to shipping to the site.

The precast slabs were made with a concrete with a 28 day strength of 11,600 psi; however, only 8,700 psi was required by the design. The slabs are cast in 40' (full deck width) long segments and with a width varying from 12.2' to 12.5' to accommodate the horizontal curvature of the ramp. The deck superelevation requires each slab to be constantly warped. Slab thickness varies, increasing from 5.5" to 8.7" at the floor beams.

The biaxial prestressing of the slabs consists of 53-T13 longitudinal pretensioned strands and two 4-T15 transversely post-tensioned tendons.

The slabs are fabricated in a form located in the fill approaches to the bridge. The form is equipped to cast pairs of slabs between anchoring abutments for the pretensioned strand. All slabs are cast with female shear keys and blockouts for the connecting nodes. Following casting, the slabs are stored along the road alignment.

Erection

Although originally designed to be erected using an assembly beam, the contractor elected to use standard scaffolding founded in the river.

During erection, each tetrahedron was supported under the floor beams by hydraulic jacks atop erection scaffolding. The jacks enable very precise adjustments to the frame geometry to accommodate the camber and superelevation requirements of the deck. The bottom flanges of the tetrahedrons are penetration welded together following the placement of all the deck slabs in a span.

The deck slabs rest directly on the floor beams with only a com-

AUTOTRAXX™

AUTOMATED SYSTEM



CONSISTENT METAL DECK FASTENING

AutoTraxx Stand-Up Installation Tool

STRUCTURAL APPLICATION
Up To 1/2" Thick Steel



Deck and
Structural
Steel are
"Clamped"
Together

CONSISTENCY

ICH Traxx self-drilling fasteners are driven to a pre-determined torque for consistent connections every time.

ELIMINATES BURN-THROUGHS

Traxx fasteners never burn-through or mar undersurface of deck. No touch-up or repainting is ever necessary.

VISUAL INSPECTION

Traxx fasteners can be easily and quickly inspected for secure attachment. You can be sure of measurable shear and pull out values.

REDUCES COSTS

AutoTraxx System saves time and reduces in-place costs.

Positive
Attachment



SIDELAP APPLICATION
For 18-22 Gauge Decks

• No Burn-Throughs

See ICBO ES Evaluation Report No. 3056 for allowable values and/or conditions of use.

Factory
Mutual
System
Approved

City of
Los Angeles
Approved

sd
Approved

ITW Buildex

For further information on AutoTraxx, technical assistance, or your nearest distributor, call toll-free
1-800-323-0720.

Itasca, IL 60143

© 1992 Illinois Tool Works Inc.

pressible joint material between them. Therefore, the floor beams and slabs together create the forms for the final composite action pours. Once these pours achieve strength, the scaffolding can be removed and the span becomes self supporting.

A longitudinal prestressing is applied at the conclusion of span erection. A total of five tendons are required and they run the entire length of the superstructure. Each tendon consists of 12 T15 strands each of which is sheathed in a greased duct. All twelve strands are then bundled into a common polyethylene duct, which is finally grouted. Deviations in the tendon profiles are achieved by metal pipes welded to locally strengthened areas of the floor beams and bottom flange.

Future Applications

The composite truss presented and used to construct the Roize Bridge is both lightweight—approximately half that of an equivalent concrete structure—and very stiff in resisting vertical loads.

These favorable characteristics have led to applying this structural system to much larger spans, including cable-stayed structures. One such application was for the Normandy bridge in France where Jean Muller used this system in his proposed design of a cable-stayed bridge with a mainspan of 2,870'. The triangular cross-section of the composite truss makes it simple to widen the deck by placing parallel structures adjacent to one another and connecting together transversely the lower chord members. As a result, the Roize bridge is a prototype for the many applications of this innovative structural system.

Serge Montens and David O'Hagan, P.E., are structural engineers with J. Muller International/JMI Engineers, Inc., bridge structural engineering firms with offices in Paris, San Diego, Tallahassee, FL, and Chicago.

Custom Metal Deck

United Steel Deck has enhanced its ability to produce custom deck systems by networking with the affiliated companies of Nicholas J. Bouras, Inc. Special finishes, such as plasticol, or materials such as stainless steel, are being used to produce custom decks and panels that solve durability and environmental problems caused by some industrial atmospheres. Special finishes combined with the roll forming and bending capabilities of United Steel Deck, Inc., can provide solutions to most unique decking demands.

For more information, contact: United Steel Deck, Inc. (Nicholas J. Bouras, Inc.), 475 Springfield Ave., Summit, NJ 07902-0662 (908) 277-1617; fax (908) 277-1619.

LRFD Expert System

The Steel Deck Institute has released a new expert design system, based on LRFD, for composite and non-composite beams and girders with steel deck. This software is part of the design Advisor expert system developed for the AISC and the SDI by Structural Engineers, Inc., of Radford, VA. Complete bay design as well as individual beams and girders can be investigated and optimized for the least cost. Design tables in the SDI format can be produced using any combination of material properties. Detailed reports are produced showing vibration analysis and provide stud spacing. Concentrated loads and line loads can be applied in addition to uniform loading. Cost is \$295.

For more information, contact: Steel Deck Institute, P.O. Box 9506, Canton, OH 44711 (216) 493-7886.

ITW Buildex

The Autotraxx ICH Deck Fastening System is used to attach steel deck in a stitch or structural steel application. The system has two components: a stand-up tool that includes a screwgun, special fastener guidance system, depth sensitive nosepiece and unique

drive socket; and Traxx fasteners with an ICH (Internal Cone Head) design.

The fasteners have either a Traxx/1 point for stitch applications or a Traxx/5 point for structural attachments. The design allows the tool drive pin to engage securely with the fastener for consistent drilling.

For more information, contact: ITW Buildex, 1349 West Bryn Mawr Ave., Itasca, IL 60143 (708) 595-3549.

Power Distribution

Walker Division of Butler Manufacturing has introduced a new concept in PLEC distribution for steel-framed buildings—one that combines the triple-service capacity and aesthetic appeal of an in-floor system with the up-front economy of a poke-thru system. The new, low-cost Presource III bottomless activation modules are installed in a grid pattern on standard steel deck before the concrete pour, providing access to services in a predetermined pattern. Activation costs are deferred until the time of fit-out, and activations are accomplished in much the same way as with a poke-thru, except that no core drilling through structural concrete is required.

For more information, contact: Mary Williams, Walker, P.O. Box 1828, Parkersburg, WV 26101 (800) 222-PLEC.

Fastening System

Hilti Inc. has designed a new powder actuated fastening system for the fast, economical attachment of metal roof and floor decking. The DX 750 fastening system offers such features as single-handed operation, a power regulator and an optional fastener magazine. While 15% more powerful than the DX 650, the new introduction is 10 lbs. lighter and can be used in temperatures ranging from -13 degrees to 113 degrees F. It also features a silencer to reduce noise levels.

For more information, contact:

Hilti Customer Service (800) 879-8000.

Bridge Decking

Grid Reinforced Bridge Decks, comprised of both a fabricated steel grid and concrete, are lighter than traditionally reinforced decks and are still strong enough to withstand high traffic volumes over long periods of time (some applications are already in their sixth decade of service). The Bridge Grid Flooring Manufacturers Association maintains a computerized data base of grid related research and welcomes inquiries. The association can provide design recommendations and also publishes a newsletter.

For more information, contact: BGFMA, 231 South Church St., Mt. Pleasant, PA 15666 (412) 547-2660.

Bridge Deck Form

Epic Metals Corp. has introduced MAXSPAN BRIDGE DECK FORM, an entirely new concept in the design of permanent metal deck forms for bridge deck slabs. The forms are designed to accommodate today's wider girder spacing with greater efficiency at spans ranging from 10' to 18'. They provide a flat top surface, which reduces concrete usage and slab dead load. This results in allowing virtually all the concrete to contribute to the structural strength of the slab.

For more information, contact: Robert Paul, Product Engineer, Epic Metals Corp., Eleven Talbot Ave., Rankin, PA 15104 (412) 351-3913.

PMD Form

Bowman Metal Deck offers permanent metal deck forms for bridge construction. According to the manufacturer, PMD forms offer three distinct advantages: time savings; cost reduction (\$4/sq. ft. estimated savings compared to wood forms); and increased safety (installation of a PMD form provides an immediate and safe working platform for all crews). In addition,

PMD forms provide a lower cost means of using more widely spaced girders, which results in more cost effective steel framing. Some research also indicates that stay-in-place forms may slightly decrease deck cracking.

For more information, contact: Bowman Metal Deck Division, ARMCO Inc., P.O. Box 260, Pittsburgh, PA 15230-0260 (412) 429-7560; Fax (412) 276-6057.

Bridge Bolts

Mid-South Bolt and Screw, a distributor of all types of fasteners for the structural steel industry, is a specialist in the manufacture of anchor bolts. The company has worked closely with several DOTs, the FHWA and various bridge fabricators to develop expertise in fasteners for bridges. Mid-South supplies domestic bolts with full traceability, lot heat certification, lot integrity and in-house testing.

For more information, contact: Tim Weaver at (800) 366-BOLT or Randy Graves at (800) 251-3520.

Inspection Walkways

Heavy Duty Grip Strut bridge inspection walkways are suspended beneath bridge deck to enable close inspection of load-carrying members. The well-made catwalks span 24' openings with minimal deflection, which reduces the need and expense of extra supports. Also, gravel, mud, snow and ice fall through large diamond-shaped openings. Choices include 9, 10, or 11 gauge grating with serrated or non-serrated steel, and widths up to 36" with 5" integral toeboards, which eliminate extra welding.

For more information, contact: GS Metals Corp., R.R. 4, Box 7, Pinckneyville, IL 62274 (800) 851-9341 or (618) 357-5353 inside Illinois.

Bridge Analysis

The SAP90 Bridge Analysis Module from Computers and Structures, Inc., enables the SAP90 program to analyze bridge structures for the weight of moving vehicle loads. The user only needs to specify the types of vehicle loads, the geometry of the traffic lanes and the desired combination of traffic loads with static and seismic loads. The program will generate influence lines for each frame element, and will automatically determine the most severe element forces throughout the structure due to placement of different vehicle loads in different traffic lanes. Influence lines and the maximum-minimum envelope of element forces for each load case may be plotted; the maximum-minimum envelope for the combination of all case loads also may be displayed.

For more information, contact: CSI, 1995 University Ave., Berkeley, CA 94704 (415) 845-2177.

LOHR Structural Fasteners meet the new FHWA guidelines for Bridge Bolts including rotation capacity tests.



LOHR Fasteners make the grade every time!



LOHR Structural Fasteners, Inc.

P.O. Box 1387, Humble, Texas 77347

For Information Ph. **1-800-782-4544**

Truss Analysis

Version 4.2 of TRAP-jr., an MS-DOS-based product for truss rating and analysis is now available from the University of Maryland's Bridge Engineering Software (BEST) Center. The program will perform an analysis or rating group loading of a simply supported or continuous span truss having up to six spans, in accordance with the 1983 AASHTO Specifications and the 1984-88 Interims.

For more information, contact: Pat Johnson, The BEST Center, Dept. of Civil Engineering, Univ. of Maryland, College Park, MD 20742 (301) 405-2011.

MERLIN DASH

Version 4.5 of MERLIN DASH (Design Analysis of Straight Highway Bridge Systems) is now available from OPTI-MATE. The program is fast with an extremely

user-friendly menu driven input. Output is complete, tabular and well organized. The program will consider welded plate and rolled beam sections, non-composite or composite, continuous up to 10 spans. Automatic live loading includes HS and multiple user defined vehicles (which may be stored in a truck file). AASHTO destruction and impact factors are computed but may be overridden. A Code Check is performed for both LFD and WSD.

Also available is DESCUS On The PC For Curved Bridges. These programs are identical to the DESCUS programs used for years by many state DOTs and consultants for the analysis and design of curved "I" and "Box" girder bridge systems—except they run on 386/486-based PCs rather than on mainframes accessed through timesharing. Live loading is automatic, structures may be skewed, bifurcated, non-composite or composite, and continuous up to 8

spans. An AASHTO Code Check is performed at each design point indicating compliance with specifications.

For more information, contact: Ollie Weber, OPTI-MATE, Inc., P.O. Box 9097, Dept. A1, Bethlehem, PA 18018 (215) 867-4077.

Composite Steel Girder Design

In addition to existing capabilities for designing and rating multispans girders, Version 5.0 of MDX's AASHTO Composite Steel Girder Design program includes interactive graphical output for viewing and plotting stresses and deflections. MDX licenses both load factor and working stress versions of its DOS-based bridge girder design programs. Qualified bridge design firms may receive a free four month trial.

For more information, contact: MDX at (314) 446-3221; fax (314) 446-3278.

OUR COMPETITORS CALLED IT
"MICKEY MOUSE"

OUR USERS CALL IT
FAST, EFFICIENT AND PROFITABLE

OUR COMPETITORS' USERS CALL IT
THEIR NEXT PURCHASE

STEELCAD - 800-456-7875
DESIGN INTERFACE - DETAILING - PRODUCTION CONTROL

STEEL MARKETPLACE

AutoSTEEL

AutoSTEEL is a 3-D frame analysis program for steel structures.

Specially developed for industrial plants, AutoSTEEL offers a unique member re-sizing and optimization capability. This enables you to group members for standardization and procurement, and lowers design costs. For more information, call:

Engineering Design Automation
1930 Shattuck Ave., Berkeley, CA 94704
ph: (510) 848-7080 fax: (510) 486-1245

Multiframe—3D Structures for Macintosh

Multiframe offers you a revolutionary approach to structural analysis and design, so easy to use that you almost won't need the manual.

Whether you create small, simple structures or large, complicated structures, you'll be in control.

Advanced modeling and visualization features let you explore more design alternatives, more quickly.

ASD code checking and a built-in AISC Steel Library give you fast, easy access and more flexibility in your design. International code checking and libraries are also available.

See for yourself. Call for a \$20 working demo.

Graphic Magic
2-1645 East Cliff Dr., Suite 6, Santa Cruz, CA 95062
Phone: (408) 464-1949 Fax: (408) 464-0731

Research Engineers, Inc.

STAAD-III/ISDS is the most powerful and versatile FRAME and FINITE ELEMENT, 2D/3D Structural Analysis and Design software for steel, concrete, timber and aluminum structures per standard U.S. and International Design Codes.

AutoSTAAD is the most powerful, fully integrated program to STAAD-III/ISDS that performs Structural Model Generation, Automated Drafting, and Detailing inside AutoCAD

Call for literature and demo (offer #SM-09)

Research Engineers, Inc.
1570 N. Batavia; Orange, CA 92667
Tel: 714/974-2500 Fax: 714/974-4771
See our ad on Page 7.

CUSTOM DECK SOLUTIONS

We can provide custom designed deck for unusual applications. Long-spans, heavy loads, or special finishes are not new to us. Call us to provide an engineered design for your unique needs.

Nicholas J. Bouras, Inc.
475 Springfield Ave.
Summit, NJ 07902-0662
ph: 908-277-1617 fax: 908-277-6789

Free Software Catalog For Structural Steel Detailers & Fabricators

Quality - Affordable - PC Software

Steel Detailing with or w/out a CAD interface, 10 integrated calculator programs designed for detailers & checkers, job estimates, bills of materials, length cutting lists, shipping lists & nesting, residential and light commercial structural design, analysis of continuous beams (steel, wood or concrete), finite element analysis, project management, accounting.

NES, Inc., P.O. Box 2014, El Segundo, CA 90245
800-637-1677 (phone) - 310-546-7158 (fax)

CLASSIFIED ADS

Reach 35,000 engineers, fabricators, architects, contractors, bridge officials and building owners inexpensively with a classified advertisement in Modern Steel Construction. It's fast and easy—we'll even do the typesetting for you at no charge.

For rate and placement information, call:
Marci Lynn Costantino or Greg Poland at (708) 679-1100.
Or fax them a note at (708) 679-5926.

ELITE BEAM COPING MACHINE

The CM-2044/3 Beam Profile Cutting Machine is the economical alternative to much higher priced CNC machinery with the advantage of 90's technology. With over 80 machines sold in 17 countries worldwide, and a price below \$40,000.00, this machine not only produces all your end operations, but also can be used in place of a saw for cut-to-length operations. We also stock a large quantity of used equipment.

For further information, shop-layout and consulting services, contact:

ELITE EQUIPMENT INC.
P.O. Box 3417, Tustin, CA 92681
Tel: 714/569-1050 Fax: 714/569-1009

3D Bridge Analysis/Design Software—CBridge

CBridge, the Syracuse University 3D Analysis/Design for curved or straight girder bridges, includes graphic geometry generator, user-defined vehicle loads to 30 axles, AASHTO design, providing a rigorous 3D analysis for both simple and complex highway and rail bridges.

Telos Technologies
1201 E. Fayette St.
Syracuse, NY 13210
(315) 471-0113

Advertiser's Index

AISC Software.....	CIII
AISC Manual.....	11
Arkansas Steel.....	35
Bethlehem Steel Corp.....	16-17
Nicholas J. Bouras, Inc.....	CII
Burco.....	13
ITW Buildex.....	54
CAST.....	27
Central Steel Service.....	36
Chaparral Steel.....	23
CitySteel.....	8
Cleveland Steel Tool.....	40
Computer Detailing.....	29
Computers & Structures, Inc.....	CIV
Design Data Corp.....	38
EJE Industries.....	29
Hess.....	36
Huck.....	45
Intergraph.....	46
Jancy.....	49
Jobber III.....	21
Lohr Fastener.....	56
Lukens Steel.....	30-31
MDX.....	40
Mid South Bolt.....	42
Miller Thermal.....	42
Nucor Fastener.....	37
Omnitech.....	41
Optimate.....	41
RISA.....	49
Research Engineers, Inc.....	7
St. Louis Screw & Bolt.....	22
Steelcad.....	57
Steel Deck Institute.....	50
Steel Joist Institute.....	43
Structural Analysis, Inc.....	14
Structural Software Co.....	3
TradeARBED.....	5
USS.....	15
Valmont.....	12
Voss Engineering.....	34

AISC Database

The AISC Database contains properties and dimensions of structural steel shapes, corresponding to Part 1 of the 1st edition *LRFD Manual of Steel Construction* and the 9th edition *ASD Manual of Steel Construction*. Two versions, one in U.S. customary units and one in metric units, are available. Please specify.

The computer database, in ASCII format, contains W, S, M, and HP shapes, American Standard Channels (C), Miscellaneous Channels (MC), Structural Tees cut from W, M, and S shapes (WT, MT, ST), Single and Double Angles, Structural Tubing, and Pipe

An explanation of variables specified in each data field is included as are a BASIC read/write program and a sample search routine by which the database may be manipulated, and a routine to convert the file to Lotus 1-2-3 format. Additionally, the metric version includes a text file which cross references the ASTM designations in SI units to U.S. customary units.

Available on 3" or 5" disk. **\$60.00**

AISC for AutoCAD

Save time! Have AISC shapes drawn at your command with AISC for AutoCAD (Release 10 and above). It draws shapes and lists properties corresponding to data published in Part 1 of the 1st edition *LRFD Manual of Steel Construction* and the 9th edition *ASD Manual of Steel Construction*.

The program will parametrically draw to full scale the end, elevation, and plan views using the design dimensions of the shapes shown below.

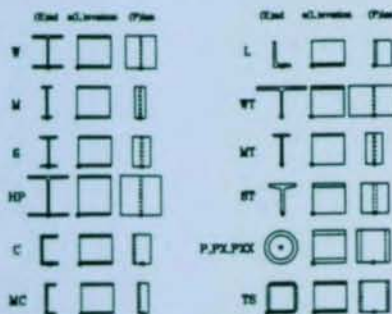

Available on 3" or 5" disk. **\$120.00**

AutoCAD is a registered trademark in the US Patent and Trademark Office by Autodesk, Inc.
AISC for AutoCAD is copyrighted in the US Copyright Office by Bridgfarmer and Associates, Inc.

AISC Software



to place an
order, call
(312)670-2400

STEMFIRE

STEMFIRE determines safe and economical fire protection for steel beams, columns, and trusses. STEMFIRE is based on rational procedures developed by AISI which extend the published UL fire resistive designs to other possible rolled structural shapes and common protection material requirements. For a required fire rating, STEMFIRE determines the minimum spray-on thickness for various rolled shapes as well as the ceiling membrane or envelope protection for trusses. This methodology is recognized by UL and has been adopted by the three national model building codes in the USA.

The software database contains all pertinent steel shapes and many listed UL *Fire Resistance Directory* construction details and fire ratings. In this manner, user search time is minimized and the design and checking of steel fire protection is optimized. Hence, STEMFIRE is easy to use with little input effort to quickly produce specific design recommendations. Two 5" disks containing executable software bearing AISC copyright and a users manual with instructions and sample problems are included with purchase.

Available on 5" disk only. **\$96.00**

CONXPRT

CONXPRT is a knowledge based PC software system for steel connections. Expert advice from long-time fabricator engineers is used to augment the design rules. CONXPRT incorporates provisions to set dimensional and material defaults for a particular project or general shop needs. Additionally, CONXPRT is menu driven and incorporates help screens designed for easy use.

Module I: Shear Connections

Available in either 1st edition LRFD or 9th edition ASD format. Designs more than 80 configurations of double framing angles, shear end plates, and single plate shear connections is possible.

Module II: Moment Connections

Available in 9th edition ASD format only. Provides a set of four knowledge bases for the design of strong axis moment beam-to-column flange connections; direct welded, flange welded-web bolted, flange plate welded-web bolted, and flange plate bolted-web plate bolted connections. Additionally, a knowledge base for the column side design of web stiffener plates and doubler plates is a part of the module.

Available on 3" or 5" disk.

Module I ASD or LRFD **\$300.00**

Module I ASD & Module I LRFD **\$550.00**

Module II ASD **\$400.00**

WEBOPEN

WEBOPEN is designed to enable engineers to quickly and economically design beam web openings. An expedient tool, WEBOPEN uses state of the art criteria and features a clear and logical data entry system with easy to use color coded input windows. Furthermore, WEBOPEN accesses a shape database allowing the selection of any W, S or M shape for use in the design procedure.

WEBOPEN was written by practicing engineers for engineers and incorporates expert design checks and warning messages which enhance the application of the AISC Design Guide to specific design problems. Using this software, unreinforced or reinforced, rectangular or round openings, concentric or eccentric, in both composite and non-composite steel beams may be designed. The design is complete with stability and proportioning checks. Additionally, the design is optimized through user interaction during the design sequence. Included with purchase are the WEBOPEN program, the WEBOPEN Users Manual and the AISC Design Guide *Steel and Composite Beams with Web Openings*

Available on 3" or 5" disk. **\$495.00**

STATE OF THE ART

**INTEGRATED ANALYSIS AND DESIGN SOFTWARE
FOR STRUCTURAL AND EARTHQUAKE
ENGINEERING**

Developed by Edward L. Wilson
& Ashraf Habibullah



For further information:

Computers & Structures Inc.
1995 University Avenue
Berkeley, California 94704

TEL: 510/845-2177
FAX: 510/845-4096

ETABS is a registered trademark of CSI.
SAP90 & SAFE are trademarks of CSI.
© 1992 Computers & Structures, Inc.

SAP90™
General Analysis & Design

ETABS®
Building Analysis & Design

SAFE™
Slab Analysis & Design