

MODERN STEEL CONSTRUCTION

May 1993

\$3.00

Earthquake
Design



NEW COLUMBIA JOIST CO.

P.O. Box 31 • New Columbia, PA 17856-0031
717-568-6761 • 717-568-1001 (FAX)

JOIST DESIGN DATA SHEET

No. 1

HOW TO SPECIFY SPECIAL JOISTS

To obtain correct and competitive bids the specifying professional must show any special loading on the structural drawings. Special loadings could include concentrated loads and any non-uniform load distribution such as:

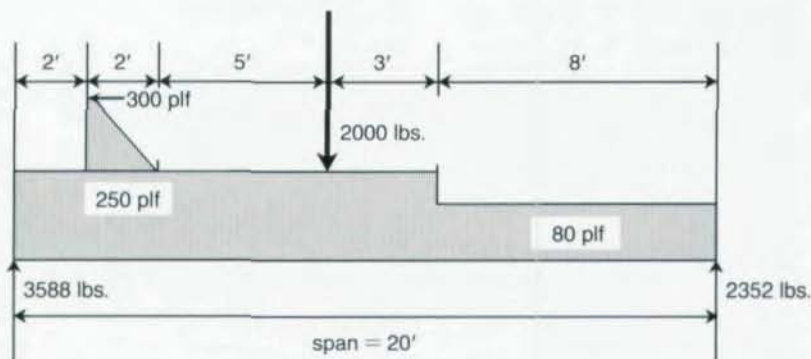

The maximum moment for this loading is 20267 lb. ft. The equivalent uniform load to produce this moment would be 405 lbs. per ft.

The maximum end reaction is 3588 lbs. The equivalent uniform load to produce this reaction would be 359 lbs. per ft.*

The K series joist tables show a 16K3 (with a 20' span) has a total load capacity of 410 lbs. per ft. The designer should show a 16K3SP on the drawings.

The SP indicates special requirements for the joist. The joist manufacturer will review the designated joist for its ability to carry the special loads shown.

Joist Girders with unequal panel point loads must also be defined by showing the load diagram on the structural drawings.

*For all standard K series joists the maximum end reaction is 8700 lbs. If more reaction capacity is needed, consider using two (or more) joists to share the load. For LH and DLH joists a conservative end reaction can be found by dividing the tabulated SAFE LOAD by two.



NICHOLAS J. BOURAS, INC.
P.O. BOX 662, 475 SPRINGFIELD AVE.
SUMMIT, NEW JERSEY 07902-0662 (908) 277-1617

00451
75400



HISTAR [®]

**A new generation
of rolled beams
and column shapes
for economical
steel construction.**

Once again, ARBED leads the industry by featuring a trendsetting combination of mechanical, chemical and technological properties:

- HIGH YIELD STRENGTHS (up to 65 KSI) - even for ultra-heavy sections.
- OUTSTANDING TOUGHNESS PROPERTIES.
- EXTREMELY LOW CARBON EQUIVALENT — ensures excellent weldability.

A NEW PROCESS... QST.

The secret is in ARBED's revolutionary new in-line QST process.

OTHER RECENT ARBED INNOVATIONS:

ARBED-ROLLED 40", 44", and "TAILOR-MADE" (WTM) series — famous for high section moduli, great lateral buckling resistance, and big savings in fabrication costs and weights. These products are also available in the new HISTAR quality as is our standard WF series and H BEARING PILES.

NEW LITERATURE AVAILABLE

Send now for complete data on all these ARBED products, contact Trade ARBED, INC., 825 Third Ave., New York, NY 10022. (212) 486-9890, FAX 212-355-2159/2421. In Canada: TradeARBED Canada, Inc., 3340 Mainway, Burlington, Ontario, Canada L7M 1A7. (416) 335-5710, FAX 416-335-1292.

TRADE ARBED Inc.

INNOVATORS OF STEEL CONSTRUCTION PRODUCTS.

MODERN STEEL CONSTRUCTION

Volume 33, Number 5

May 1993

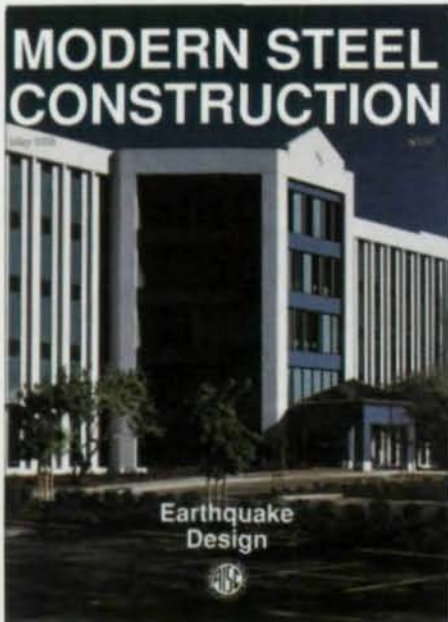

Four steel buttress towers were added to this concrete-framed structure in order to bring it up to current seismic standards. In addition, the addition added 26,000 sq. ft. of usable space. The story behind this innovative renovation begins on page 22. Photo by Mert Carpenter Photography, Los Gatos, CA (408) 370-1663.

FEATURES

- 14 **FABRICATORS, ENGINEERS AIM FOR CONSENSUS**
Despite differences in views on authority and liability, industry-wide agreement on design responsibility is close to becoming a reality
- 22 **SEISMIC UPGRADE FOR A CONCRETE FRAME**
Four steel buttress towers were added to a concrete-framed building to bring it up to current seismic standards
- 28 **ACTIVE BRACING SYSTEMS**
A recent full-scale mockup showed the practicality of "smart" bracing systems for seismic design
- 34 **WEST COST QUAKES SEND TREMORS THROUGHOUT THE EAST**
It used to be that only building out West needed to meet strict seismic codes; but now building codes along the Eastern seaboard have been drastically amended

NEWS AND DEPARTMENTS

- 6 EDITORIAL
- 9 STEEL INTERCHANGE
- Design of a bracket connection carrying moment
 - Welding nuts to bolts to prevent backing off
 - Connecting wide-flange beams to tube columns
- 12 STEEL NEWS
- Steel Calendar
 - New Computer Program For Moment Rotation Curves
- 43 FASTENER PRODUCTS
- 50 STEEL MARKETPLACE

Modern Steel Construction (Volume 33, Number 5). ISSN 0026-8445. Published monthly by the American Institute of Steel Construction, Inc. (AISC), One East Wacker Dr., Suite 3100, Chicago, IL 60601-2001.

Advertising office: Pattis/3M, 7161 North Cicero, Lincolnwood, IL 60646.

Subscription price:
Within the U.S.—single issues \$3; 1 year \$30; 3 years \$85.
Outside the U.S.—single issues \$5; 1 year \$36; 3 years \$100.

Postmaster: Please send address changes to Modern Steel Construction, One East Wacker Dr., Suite 3100, Chicago, IL 60601-2001.

Second-class postage paid at Chicago, IL and at additional mailing offices.

00453

There are those who have seen the future.

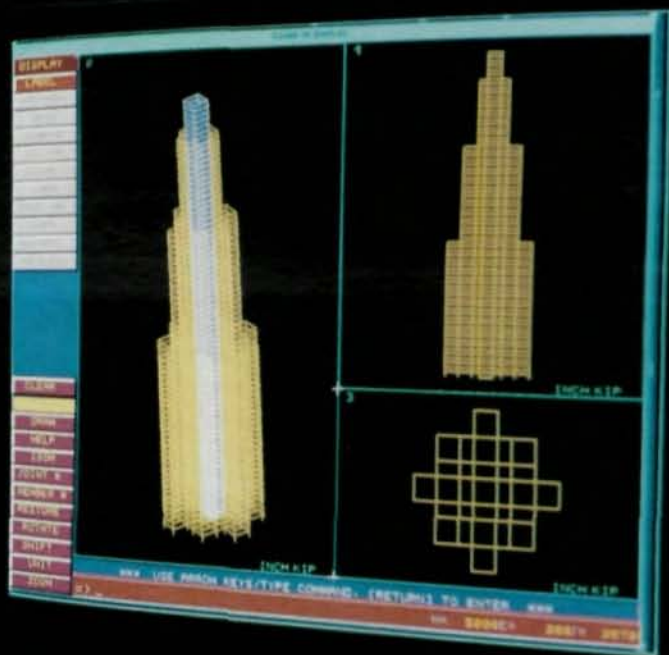

Announcing the arrival of **STAAD-III/ISDS - Release 17**. Once again, Research Engineers, has made the technology of tomorrow available to you today.

Use newly introduced facilities like NON-LINEAR analysis, TIME HISTORY analysis, user-controlled multiple iteration P-Delta analysis, steel design for transmission towers (ASCE Pub. 52) etc. in addition to 14 different steel, concrete, and timber codes, to explore the widest possible range of design solutions.

Release 17's powerful printer plotting capabilities allow you to generate the industry's sharpest and most comprehensive run output. For the first time, you can combine numerical output with graphical output - all in the same run document. Yes, we support the widest possible range of printers - from sophisticated lasers to down-to-earth dot-matrix printers.

On the graphics front, Release 17 features an enormously enhanced graphics input generator with unparalleled speed and power. In addition,

Release 17 marks the debut of **AutoSTAAD/MAX** - the world's first integrated structural software system that works entirely *within* AutoCAD.

All these powerful capabilities coupled with the industry's most knowledgeable and experienced support staff, makes STAAD-III/ISDS the ultimate productivity tool you've been waiting for.

STAAD-III/ISDS Release 17 - there are those who have seen the future ... have you?

**Research
Engineers, Inc.**

1570 N. Batavia, Orange, CA. 92667.

CALL TOLL FREE (800) 367-7373

Tel: (714) 974-2500 FAX:(714) 974-4771

Research Engineers Worldwide

U.S.A. • U.K. • JAPAN • GERMANY • FRANCE • NORWAY • CANADA • INDIA

Pet Peeve #2

While computers and their ilk have simplified our daily business activities—and cut costs—they've also added a lot of aggravation.

For example, we're always trying to keep Modern Steel Construction's circulation as up-to-date as possible. As such, we send readers renewal cards every year. When a reader hasn't responded to a renewal card in a while, we send a "last chance" notification. Unfortunately, our instructions to our computer system were not clear enough, and letters went out to everyone with a stop date in February, whether they had renewed or not. My apologies to those I harangued unnecessarily.

But I know I'm not alone in Computer-Aided Failure. I've already mentioned my dislike for poorly conceived voice mail systems. Just as bad are Fax Abusers.

The latest example of fax abuse to cross my desk came in the form of a press release from a huge, East Coast-based corporation. To start with, there was no reason for the press release to be faxed. It contained no information of shocking urgency—rather, it was a run-of-the-mill new product announcement. In fact, it wasn't even a product related to the steel industry. Yet this company felt the need to tie up my fax machine with the equivalent of junk mail. But to add insult to injury, they have not yet mastered the automated fax technology they are using, and included with my copy was a two-page listing of their mail list.

Customer service is another area where technology has all-to-often proven a failure. I recently purchased a piece of mail-order software that, unfortunately, came with a defective floppy disk. I called the company's customer service number, but of course it was busy. I called back. It was busy. I called back and got through to a voice mail system. But when I tried to leave a message, I was informed that the system was "full" and I should call again. Which I did, with the same result. Finally I resorted to faxing them a note (which was not easy in itself, since their fax machine was almost continuously busy). To their credit, however, I did receive a replacement disk in less than three weeks (though no other acknowledgement was sent).

The problem seems to be that the people who implement systems based on new technology never have to experience the frustrations of actually using the system. The solution, which few executives seem willing to implement, is to put yourself in the position of your customer. Not just on a theoretical basis, but in practice. Call your company one day and see what an outsider goes through. Place an order. And finally, sit down at a computer terminal and see what actually goes on with your inventory and order input system. **SM**

Editorial Staff

Scott Melnick,
Editor and Publisher
Patrick M. Newman, P.E.,
Senior Technical Advisor
Charlie Carter,
Technical Advisor

Editorial Offices

Modern Steel Construction
One East Wacker Dr.
Suite 3100
Chicago, IL 60601-2001
(312) 670-5407

Advertising Sales

Pattis-3M
7161 North Cicero
Lincolnwood, IL 60646
(708) 679-1100
FAX (708) 679-5926

AISC Officers

Stephen E. Egger,
Chairman
Frank B. Wylie, III,
First Vice Chairman
Robert E. Owen,
Second Vice Chairman
Robert D. Freeland,
Treasurer
Neil W. Zundel,
President
David Ratterman,
Secretary & General Counsel
Lewis Brunner,
Vice President,
Membership Services
Geerhard Haaijer,
Vice President,
Technology & Research
Morris Caminer,
Vice President,
Finance/Administration

00454

**Our breakthrough 3-D
technology can't be shown
in a 2-D ad.**

**Call for your first hand
demonstration of the SDS/2
Detailing System.**

Break through time-consuming 2-D, line-by-line graphics with the 3-D technology of the SDS/2 Version 5.4 gives you the ability to automatically produce shop drawings and other information about a structure never before possible. The benefits are invaluable to design engineers, steel fabricators and detailers...or anyone who is involved in the conception and production of steel.

The SDS/2 Software Solutions are the ultimate steel fabrication tool. All information created in SDS/2 or transferred through DesignLINK from third-party design software, can be used throughout all phases of design and fabrication. The SDS/2 Software Solutions include:

- Engineering Analysis and Design Module
- Production Control Module
- Estimating Module
- Detailing Module
- CNC Interface
- DesignLINK

Call Design Data to arrange your personal demonstration or to request additional information.

**DESIGN
DATA** 

"First in...software, solutions, service"
402-476-8378 or 1-800-443-0782

Grade School.

A36

A572 Grade 50

Economical and readily available

Mill certified 50,000 minimum yield

A36/A57250

Economical Readily available Mill certified 50,000 minimum yield

Introducing the one steel for North America: Chaparral Steel's A36/A57250 steel. This mill-certified steel satisfies multigrade requirements in the U.S., Canada and Mexico. The A36/A57250 steel meets all the specifications of our A36, A572 Grade 50, 44W and 50W. It's everything you like about these grades rolled into one. Plus, it costs the same as the A36, and has the same carbon equivalent range, an important factor for welding and formability. It's also just as easy to get, thanks to our innovative shipping techniques and central location. Call your Chaparral representative today and order the structural steel that makes the grade a number of ways: Chaparral's A36/A57250.

**CHAPARRAL
STEEL®**

300 Ward Road Midlothian, Texas 76065-9651
Toll Free (800) 527-7979 U.S. and Canada
Local (214) 775-8241 Fax (214) 775-6120

Steel Interchange

Steel Interchange is an open forum for *Modern Steel Construction* readers to exchange useful and practical professional ideas and information on all phases of steel building and bridge construction. Opinions and suggestions are welcome on any subject covered in this magazine. If you have a question or problem that your fellow readers might help to solve, please forward it to *Modern Steel Construction*. At the same time feel free to respond to any of the questions that you have read here. Please send them to:

Steel Interchange
Modern Steel Construction
 1 East Wacker Dr.
 Suite 3100
 Chicago, IL 60601

Answers and/or questions should be typewritten and double spaced. Submittals that have been prepared by word-processing are appreciated on computer diskette (either as a Wordperfect file or in ASCII format).

The opinions expressed in *Steel Interchange* do not necessarily represent an official position of the American Institute of Steel Construction, Inc. and have not been reviewed. It is recognized that the design of structures is within the scope and expertise of a competent licensed structural engineer, architect or other licensed professional for the application of principles to a particular structure.

Information on ordering AISC publications mentioned in this article can be obtained by calling AISC at 312/670-2400 ext. 433.

The following responses to questions from previous *Steel Interchange* columns have been received:

Can you show a design of a bracket connection carrying moment (February 1993)?

One solution can be arrived at by visualizing that the beam and bracket act together as a single unit. The problem now is similar to a haunched beam-to-column connection which is a more familiar moment type connection. In order to design a rigid connection using the above assumption, an end plate can be utilized to which both the beam and bracket are fully welded. For the same reason, it is advantageous to weld the bottom flange of the beam to the top plate of the bracket rather than bolting them. This sub-assembly can be fabricated in a shop with relative ease and efficiency. It can then be bolted the column in the field later.

The vertical web stiffener, defining the critical area of the web, will create a web panel with an aspect ratio between 0.75 and 1.50. This web panel should be able to resist moment M_o without excessive shear deformation (no yielding or buckling). Otherwise, additional diagonal stiffeners will be required to carry the balance of flange tensile/compressive force via truss action.

The bracket shall be designed for vertical forces, V_m and V_o , applied at point A (Case I). The end plate should be proportioned to resist the same load, i.e. $V_m + V_o$, in tension. However, prying of the column connection bolts may control the end plate thickness requirement. In situations where the connection between the bottom flange of the beam and the bracket top plate is rendered through bolts in bearing, the end plate shall provide resistance against a portion of the shear force acting between the two surfaces. This is in addition to the tensile forces mentioned earlier and tends to complicate the end plate design.

The column connection bolts shall resist the fixed-end moment of the beam, M_f , and its end shear, V_f , for the clear span between columns. Column flange stiff-

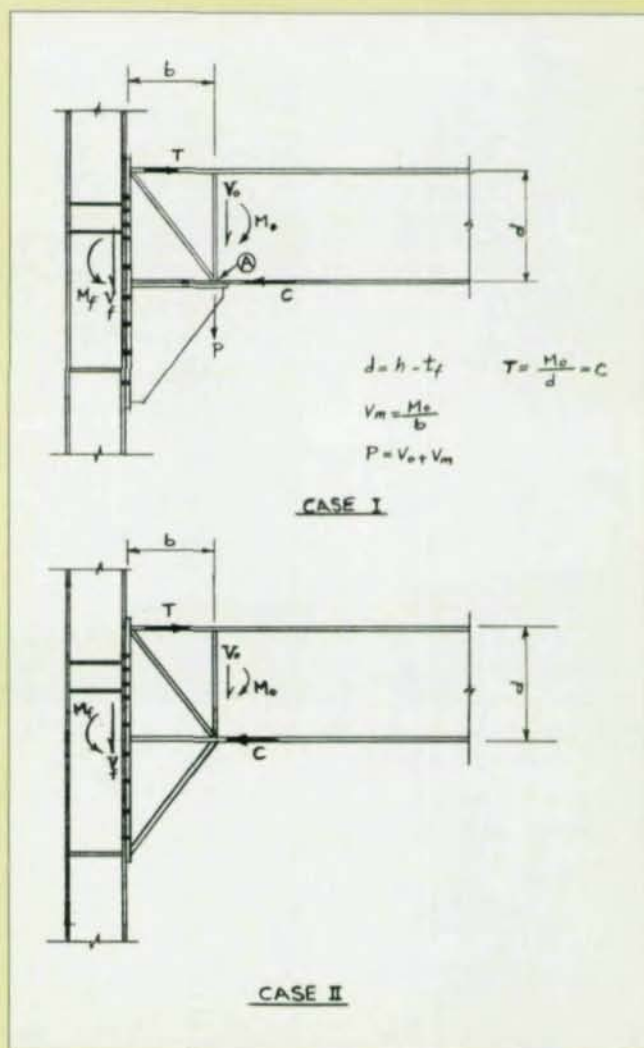

eners shall be provided similar to any other bolted connections.

If the flange area of the gusset plate is within the same order of magnitude of the beam flange area, it is preferable to use the same width for both flanges and eliminate the bracket top plate (Case II).

Abbas Pourbohloul
 Consolidated Rail Corporation
 Philadelphia, PA

Steel Interchange

Is it permissible to weld nuts to bolts to prevent them from backing off? Are any special welding procedures required? Is bolt or nut strength affected?

While it is not considered desirable to weld a nut to a bolt, it is not uncommon to encounter situations where loosening of nut could pose a real threat for structural failure. In a recent case involving

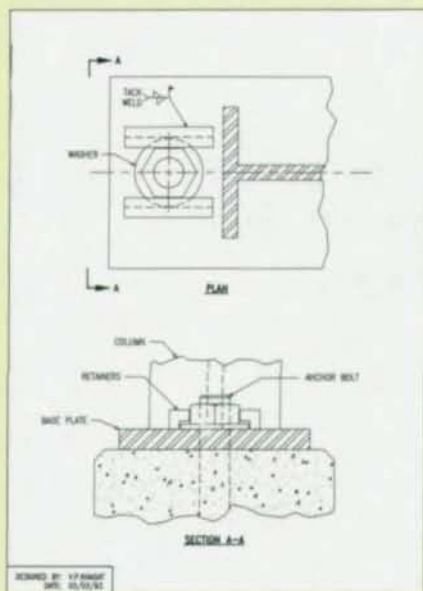

the base of a tall tower, the undersigned was faced with a similar situation where the columns were subjected to mild but continuous vibrations and loosening of the nuts had to be prevented. This was accomplished by tack welding retainer bars to the column base plate adjacent to each of

the two anchor bolts as shown in the figure. This was done because the anchor bolts did not have sufficient projection for a second (locking) nut.

Vijay P. Khasat, P.E.
Ohio Edison
Akron, OH

How can you connect wide-flange beams to tube columns?

The figure below shows a different concept of connecting wide-flange beams to all four faces of a structural tube column to transfer moment and shear than has previously been offered in *Steel Interchange*. The end stiffener plates, connection plates and other connection material can be shop welded and the beam can then be bolted to the column in the field.

George Chiang, P.E.
The Port Authority of NY and NJ
New York

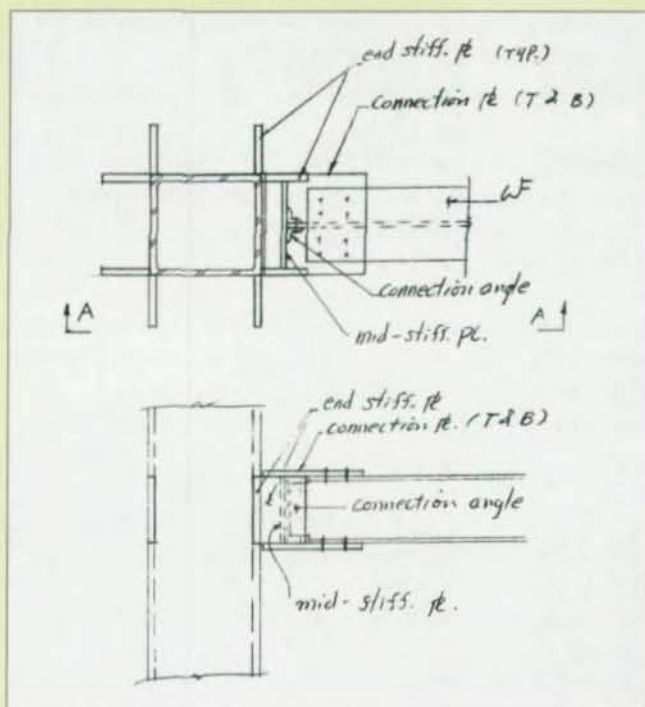

New Questions

Listed at right are questions that we would like the readers to answer or discuss.

If you have an answer or suggestion please send it to the Steel Interchange Editor, Modern Steel Construction, One East Wacker Dr., Suite 3100, Chicago, IL 60601-2001.

Questions and responses will be printed in future editions of Steel Interchange. Also, if you have a question or problem that readers might help solve, send these to the Steel Interchange Editor.

Under what circumstances does the designer have to consider torsion in the design of a beam?

Are there any design aids that will help an engineer design a steel arch or a communications tower?

How can one take into account blast effects in the design of steel structures?

ROBOT V6

TOOLS FOR STRUCTURAL ANALYSIS AND DESIGN

- EASE OF USE • SIMPLE DESIGN PROCESS • SPEED AND ACCURACY • UNIFIED WORK ENVIRONMENT •

**TEST DRIVE SOFTWARE THAT WORKS AS GOOD AS IT LOOKS!
TO SEE WHAT THE EXCITEMENT IS ALL ABOUT,
VISIT OUR BOOTH AT THE A/E/C SYSTEMS® '93 IN ANAHEIM.**

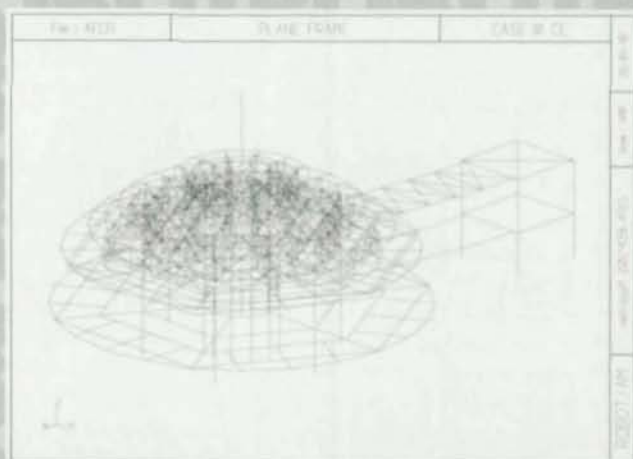
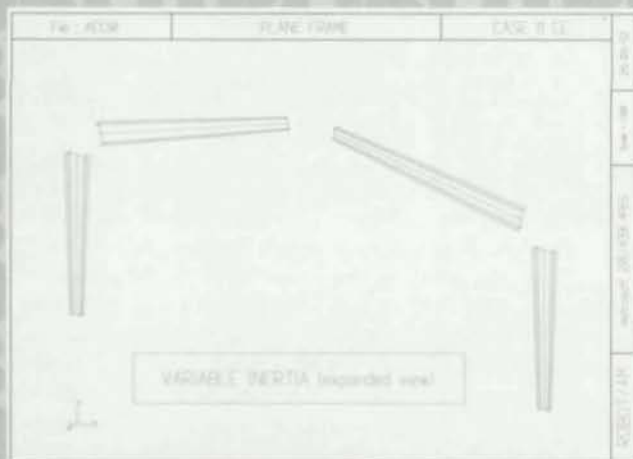

FAST AND POWERFUL

- easy modeling of simple frames and powerful tools for large and complex structures
- high speed, leaves competition behind: 3D roof, 735 nodes, 4 load cases, 2901 beams, 4296 DOF, computed in 2'27" on a notebook Toshiba T 4400

UNEQUALLED INTEGRATION

- in linear static, dynamic, seismic, non linear, buckling
- for beams, plates, shells, cables
- in 2D and 3D
- for steel and concrete design
- on PC compatible computers
- universal network solution (NetWare, Lantastic and all NetBIOS compatibles)

COMPREHENSIVE AND INTUITIVE

- easy to use even for the new or occasional user
- user friendly: menu driven, guided logic, instant access to all resources, rapid Hypertext help system, integrated macros
- all input data and results can be processed in text or in full graphic mode (loading, boundary conditions, materials,...)
- interfaces with most CAD software (DXF, HPGL, IGES)

metrosoft

332 Paterson Ave
East Rutherford, NJ 07073

DEMO AVAILABLE (LIMITED VERSION OF PROGRAM WITH SELF-RUNNING EXAMPLES)

OVER 1200 USERS WORLDWIDE. FOR MORE INFORMATION CALL 201-438-4915 OR FAX TO 201-438-7058

AISC Lecture Series: New Ideas In Structural Steel

AISC Marketing, Inc. is now presenting a new lecture series focusing on innovations in structural steel design. *New Ideas In Structural Steel* will present practical design concepts for engineers and fabricators.

The four-part seminar covers:

- Low-rise buildings.
- Design of connections.
- Eccentric braced frames.
- Partially restrained connections.

Registration fee is \$60 (\$45 for AISC members). Included in the

registration fee are a dozen handouts and publications plus a meal. For information, contact: Colleen Hays, AISC, Inc., One East Wacker Dr., Suite 3100, Chicago, IL 60601-2001 (312) 670-2400.

WEST	Date	MIDWEST	Date	NORTHEAST	Date
Los Angeles	5/4	Detroit	5/11	Newark	6/22
Irvine	6/10	Indianapolis	5/13	Rochester	9/22
Sacramento	6/22	Minneapolis	5/25	Albany	9/23
San Francisco	6/24	Milwaukee	5/27		
		Chicago	6/3		
SOUTHWEST	Date	SOUTH	Date	MID-ATLANTIC	Date
Dallas	5/6	Birmingham	9/9	Baltimore	5/18
San Antonio	6/1	Miami	9/14	Washington	5/20
Houston	6/8	Orlando	9/16	Philadelphia	6/23
		Atlanta	9/28	Cleveland	10/19
		Richmond	9/30	Cincinnati	10/21

11th Annual Construction Law Seminar (May 7 in Chicago) sponsored jointly by Chicago-Kent College of Law and the Construction Law Institute. Workshop highlights include: "Shifting from the Private Sector to Public Sector Projects" (the session will focus on the new Capital Development Board Service Agreement and Construction Agreement); "Are Your Lawyers Making You Crazy" (a panel discussion of ways to control legal costs while also improving the quality of legal service); "Project by Project Insurance" (workshop will offer practical guidelines to help construction professionals identify the kind of coverage they need, such as owner-funded project insurance, wrap-ups, OCP policy, and coverage for pollution or hazardous materials); "The Mentor/Protege Program" (offering information on affirmative action requirements); and "The Americans with Disabilities Act". For more information, contact: Bruce J. Schulte, Chicago-Kent College of Law, 565 West Adams St., Chicago, IL 60661-3691 (312) 906-5250; fax (312) 906-5363.

Symposium on Project Management (May 13-14 in Chicago) sponsored by Association for Project Managers in the Design Profes-

sions. Topics include: state of the art project management techniques; the emerging concept of partnering; creating a Total Quality Management component to each design project; making effective project decisions; new project management directions for the economy of the '90s; and case studies including managing quality on the new International Complex at O'Hare Airport. Contact: APM at (312) 472-1777; Fax (312) 525-0444.

Lasers in Fabricating Conference (May 18-20 in Schaumburg, IL) sponsored by the Fabricators & Manufacturers Association. Topics include: equipment selection and cost justification; precision laser cutting techniques; YAG, fiber-delivered processing; laser/punch combination machines; high-energy thermal processing; programming laser cutting systems; CO₂ multi-axis processing; material handling equipment; equipment specifications; maintenance; and safety. For more information, call (815) 227-8202.

Structural Engineers Association of Southern California Computer Show (June 7-10 in Anaheim, CA) held in conjunction with A/E/C Systems '93. Seminar series targeted at practicing structural engineers. Sessions include: practical aspects of dynamic analysis using standard finite element analysis software; benefits of marketing an automated structural engineering office; and spreadsheet software. For more information, contact: SEAOSC, 2550 Beverly Blvd., Los Angeles, CA 90057 (213) 385-4424; fax (213) 389-7514.

1993 Symposium on Computer Integrated Building Sciences (June 10-11 in Anaheim, CA) sponsored by the International Council for Building Research and Documentation. Topics will include: automated construction (using no people); automated fabrication; robotic tools for construction; and 3D modeling. An additional session will feature the new Disney Concert Hall Project, which has been designed on 3D CAD and has used NC for the cutting of stone and structural steel. For more information, contact: Harold Jones, SCIBS'93, 1700 Asp Avenue, Norman, OK 73037-0001 (405) 325-1947; Fax: (405) 325-7968.

Finding Moment Rotation Curves

One drawback to designing partially restrained connections has been finding a reliable source of moment rotation curves. That problem has been relieved, however, by a new computer program from RMR Design Group, Inc. called PRCONN. As its name indicates, the program is designed specifically for generating moment rotation curves for partially restrained connections.

The program, which runs on IBM-compatible personal computers with MS-DOS, offers 31 connection options, including: top and seat angle; single web angle; double web angle; header plate; single plate; and welded double web angle. All of the former also can be specified with top and seat connections. The program also allows the use of any of the connection options in a composite connection. The connection library also includes the option of bolting or welding and constant or variable load beam lines giving beam end moments and rotations. Also, it offers uniform and concentrated load options with midspan deflections.

The experimental data used for PRCONN development and verification were obtained from tests reported in archival journals, conference proceedings, and university theses and reports.

The program "builds" a given connection based on the strength and force-deformation properties of connector elements that are typically 3" in length. Connector elements are bolted or welded single and double angles and bolts in single or double shear. Connector strength and force-deformation properties in tension, compression, and shear were obtained from laboratory tests.

The output includes all inputted material and configuration information along with deflection and moment-rotation curves and beam-lines.

For more information or a free manual, contact: RMR Design Group, Inc., 4421 E. Coronado Dr., Tucson, AZ 85718 (602) 621-8251.

4-BOLT: COMPOSITE, SINGLE PLATE CONNECTION

13:48:11 2-24-1993

DEPTH OF BEAM (IN) =	18.00	BEAM X-SECT AREA (IN**2) =	2.00
BEAM YIELD STRENGTH (KSI) =	60.00	DISTANCE BEAM - BEAM (IN) =	2.00
SYMMETRY ADJUSTMENT (IN) =	.00	BOLT TYPE (A325 / A490) =	A325
ANGLE/PLATE THICKNESS (IN) =	.38	BEAM WEB THICKNESS (IN) =	.50
STEEL GRADE (KSI) =	36.00	ANGLE OR PLATE GAGE (IN) =	.00
4 BOLTS - DIAMETER (IN) =	3/4		

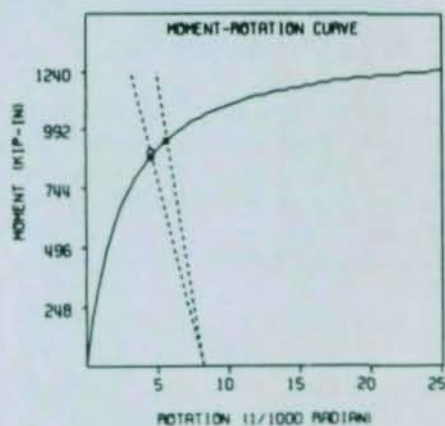

LENGTH OF BEAM (FT) =	32.00
BEAM INERTIA (IN**4) =	1600.00
UNIFORM LOAD (KIP/FT) =	2.00

RICHARD CURVE PARAMETERS:

K =	4.7617E+05
KP =	3.5696E+02
RO =	1.3352E+03
N =	1.10

BEAM LINE RESULTS:

0	4.6	806
*	5.7	948
0 R/R _e =	.432	
0 R/R _e =	.568	
* R/R _e =	.308	
* R/R _e =	.692	

MID-SPAN DEFLECTION (IN) = .643

BEAM SPAN / 360 (IN) = 1.067

IN ADDITION TO ANGLE, RAIL, PIPE, CHANNEL,
AND BEAM ROLLING CAPABILITIES, WE
ROLL TUBES, CHANNELS, AND
BEAMS THE HARD WAY.
IF WE CAN BE OF SERVICE
PLEASE CALL OR FAX.

WHITEFAB INC.

Birmingham, AL

Phone (205) 791-2011

FAX (205) 791-0500

Fabricators, Engineers Aim For Consensus

Despite differences in views on authority and liability, industry-wide agreement on design responsibility is close to becoming a reality

Nearly 300 structural engineers and fabricators listened raptly to arguments over who has the ultimate responsibility—and liability—for designs at a special session immediately preceding the start of this year's National Steel Construction Conference on March 17. Although few—if any—minds were completely swayed even after 12 speakers and nearly four hours, participants did appear to be moving closer together.



Richard Tomasetti, P.E.

"I've been fighting this battle since 1984. I want to try to look for more solutions instead of going over the old arguments," stated Richard Tomasetti, P.E., principal, Thornton & Tomasetti Engineers, New York City, a structural engineer advocating

shared responsibility. Tomasetti's position, in a nutshell, is that if the fabricator is only doing detailing, then he need not take any responsibility or liability for the connection design. But if the fabricator's services extend to design, then his responsibility also extends to that design.

"I want to change the question [from who is responsible for design] to who is responsible for the services a given party provides," he stated.

Leonard Ross, president, L.N. Ross Engineering Co., Atlanta, and former president of the National Institute of Detailing, countered Tomasetti's argument by citing D.B. Steinman's remarks that there must be a clear-cut demarcation between engineers and non-engineers. "Let's be wise enough to prevent some of the future mishaps by rejecting attempts to improperly and unlawfully shift responsibility from the design professional to another party," Ross added. "A P.E. is licensed to perform and protect the public from harm.

The engineer of record is the captain of the ship and cannot and must not abrogate any responsibility for the safety of his ship."

While the question of design responsibility has simmered for more than a decade, it came to a boil in 1991 with the issuance of the "Fernandez Memorandum." According to the memorandum, issued by Henry A. Fernandez, deputy commissioner of the professions for the New York Education Department, "...the practice of delegating design responsibility to unauthorized firms constitutes unprofessional conduct under the Rules of the Board of Regents and New York State Education Law." Among these unauthorized firms are construction contractors, such as steel fabricators. (See accompanying story for more on this subject.)

James Stori, president of AISC-member STS Steel, Inc., Schenectady, NY, began his presentation by reminding the audience that the Fernandez Memorandum did not change the rules; rather, its purpose was to remind engineers of the already established rules.

Unfortunately, there has been increasing pressure



Leonard Ross, P.E.



James Stori

from the design community to alter these rules.

Among the reasons for the desire to shift responsibility are: pressure from lawyers and insurance companies; increased project complexity; a reduction in the quality of structural drawings produced by fabricators; and tighter budgets and time frames for project completion. As a result, Stori explained, many engineers have deleted the word "approved" from their review of shop drawings. Also, engineers are increasingly requiring fabricators to submit calculations on drawings and to have a P.E. among their fabrication staff.

"I like to think of engineers and fabricators as partners," Stori stated. The fabricators know what it takes to put a building together in the field—what is safe and practical, while the engineer of record has more theoretical knowledge. The fabricator has seen a wide range of details from a variety of engineers, while the EOR only has access to his firm's work. However, the fabricator does not have access to all of the design information for a given project. In the long run, it is the engineer of record who has his name and reputation on the line, according to Stori.

Rather than delegating responsibility, Stori believes the EOR must insist on quality. "He can require submission of details ahead of time," Stori opined. "He can require a P.E. in supervision of the detailing and connection selection process. He can stipulate drawing turn-over times so that he's not rushed and he can also stipulate AISC certification [for the fabricator] or its equivalent."

However, not all fabricators agree that the sole responsibility for design rests with the engineer of record.

"The present code requires the engineer to accept responsibility for hundreds, sometimes thousands of connections that he sees for the first time one day and then, two weeks later, he must return them approved or approved as noted," according to Sophus Thompson, president, AISC-member Austin Steel Co., Inc., Dallas. "These are drawings that we as a fabricator have worked on for weeks and weeks. We've designed them, we've drawn them, and we've checked them. It is our feeling it is impractical for the engineer to be fully responsible for all of the connections shown on the shop drawings given the time pressure that is associated with the approval project on every project." He favors a clear division of responsibility, where the fabricator would be responsible for three types of connections:

- Where the shear, axial load, and moments are shown on the design drawings;

The Fernandez Memorandum

Its stated subject, "Unlawful Delegation Of Design Responsibility By Design Professionals," says it all. In August of 1991, Henry A. Fernandez, a deputy commissioner for the New York State Education Department, sent shockwaves through the design and construction community.

The memo states, unequivocally, that ultimate design responsibility rests with the engineer of record. "In recent years, however, there has been a trend to shift responsibility for final approval of the "shop drawing" to persons other than the principal design professionals," Fernandez wrote. "Frequently, general construction contracts for buildings contain language pertaining to written specifications that have been interpreted to require unlicensed persons, such as subcontractors to provide professional design services. In other cases these contracts require the work to be performed by a licensee, as either an employee or consultant to the subcontractor. The end result is that the completed structure has parts designed by several parties, with an absence of responsibility on the part of the principal design firm or firms to ensure that the entire structure will function properly and safely as an integrated system. The purpose of this memorandum is to inform and remind all licensed design professionals that the practice of delegating design responsibility to unauthorized firms constitutes unprofessional conduct under the Rules of the board of Regents and New York State Education Law."



Robert Rubin, P.E.

Robert A. Rubin, counsel for the American Society of Civil Engineers and a licensed engineer himself, brought suit to declare the memorandum null and void. Rubin's argument, essentially, is that Fernandez misinterpreted New York law and was not merely reminding the engineering profession of an existing regulation but instead was creating a new rule.

The lawsuit was recently dismissed in part because "Since the Memorandum is neither a rule or a regulation, it has no legal effect." Also, since no attempt has been made to enforce the Memorandum, there is no legal dispute on which to base a lawsuit.

However, the battle is not over. Rubin has appealed the decision to the Appellate level and expects a ruling in 1994. "The problem is that the piece of paper is still there," Rubin stated during the Design Responsibility session at this year's National Steel Construction Conference. By appealing, Rubin hopes to force the State Education Department to deal with the issue directly and issue rules that will supersede the memo.



Sophus Thompson

- For shear connections of beams, where the shear force is not shown on the design drawings, but where the reaction can be calculated from AISC tables.

- For moment connections where full moment ca-

capacity of the member is indicated on the design drawings.

The engineer would be responsible for all other connections.

"Allow the fabricator to design connections that fit his expertise," Thompson stated. "Put the work with the corresponding responsibility or liability where it fits naturally."

Not everyone agrees with Thompson's interpretation, however. According to D. Kirk Harman, P.E., a principal with Cagley and Harman, King of Prussia,

PA and a representative from the Coalition of American Structural Engineers (CASE), the fabricator may be choosing a connection from an AISC source but is not actually designing it. "We retain responsibility," he stated.

Abraham J. Rokach, P.E.,

AISC senior staff engineer, spent several minutes naming various AISC sources, and the list was impressive. The list included: Volume II Connections; LRFD and ASD Manuals of Steel Construction; LRFD and ASD Design of Simple Shear Connections; ASD and LRFD Specification for Structural Joints using ASTM A325 or A490 Bolts; AISC Design Guides; the CONXPRT computer program; and *Engineering Journal*. "It's wrong for professional people to try to reduce their responsibility," Rokach stated. He then compared the medical and engineering professions,



D. Kirk Harman, P.E.

Celebrating Our 2nd
Decade of Service!

SCADA The state-of-the-art Structural Engineering System



The SCADA structural engineering software system represents an integrated design-analysis environment. It includes complete reinforced concrete and steel design capabilities. The design procedures are closely coupled to the SCADA analysis methods. SCADA includes an efficient 3-D finite element structural analysis module with a large element library and a wide range of analysis capabilities.

It offers the choice of three preprocessing model definition procedures - spreadsheet style, drafting style and advanced geometric and solid modeling style.

The SCADA display capabilities are powerful and efficient, including shaded image, continuous

color contour and line contour plotting.

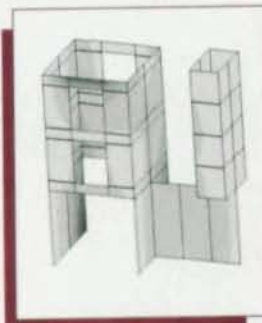
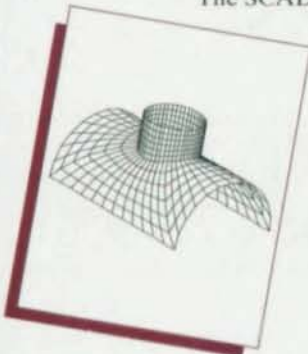

Capabilities:

- ◆ Statics
- ◆ Dynamics-Time History
Dynamics-Response Spectrum
- ◆ P-Delta
- ◆ Buckling
- ◆ Nonlinear Statics and Dynamics
Geometric and Material Nonlinearity
- ◆ Complete Element Library
Truss, Beam, Kirchhoff Plate, Shear Plate, Plane Stress, Plane Strain, Axisymmetric, Shell, Solid
- ◆ Steel and Concrete Design
- ◆ CAD Translators
- ◆ Geometric and Solid Modeling
- ◆ Mesh Generation
- ◆ SQL Relational Database Reporting

For information contact:

SCADA Software Corporation
12021 Wilshire Blvd., Suite 676
Los Angeles, CA 90025
Tel: (310) 576-1540 Fax: (310) 576-1541





Richard Horner

which both are experiencing rising insurance costs. "There are the same problems, but doctors take additional, not less, responsibility."

Added Harman, "Over the years, we have found that there is still a significant amount of risk for the

structural engineer even if we delegate the connection responsibility. If there's a connection failure, we all will be sitting at the table—the architect, the structural engineer, the contractor, the fabricator, and probably anybody else who walked by the site during construction. Why don't we just solve the problem now and avoid all of that time and effort."

Part of the question revolves around insurance. Richard Horner, with the Victor O. Schinnerer & Co., Inc., a leading insurer of architects and engineers, noted that his firm has not pushed the shop drawing

issue with their clients. He did add, however, that most engineering insurance policies contain an exclusion where the engineer manufactures a building component. Mike Holcomb, with CNA Insurance, a leading insurer of fabricators, stated that

most fabricators carry a general liability policy that does not cover professional liability. What that means is that most fabricators are not covered for preparing designs or plans. However, he added, at least one insurance company is currently working on a new program that would offer professional liability coverage to fabricators.

Building owners add another dimension to the question and some have specific guidelines. As with the New York Education Department, the military clearly states that the EOR has the ultimate design re-



Mike Holcomb

Production Control

Get unrivaled control over every piece in your shop, every step of the way

How would you like to be able to punch a few keys on your computer and get instant, detailed tracking reports on the status of individual pieces or entire jobs in your shop? That's exactly what Structural Software's new Production Control Tracking System can do for you. Shipping tickets, loading reports and other status reports show what shop stations a piece passed through on what date, who did the work, how many manhours the work took and what still needs to be done to that piece. Bar graphs, like the one shown, give the number and percentage of completion on any piece mark, sequence or job. The new tracking system gives you the power to see exactly what shop work remains to finish a given piece mark, sequence or job. Sorted lists show individual piece weights, assembly weights, even weight of all steel on a drawing. Production Control interfaces with our Purchase Orders program to generate cutting lists that give you the added capability of tracking material from the time it's ordered to the time it's cut. The cutting lists show shop employees exactly which pieces to pull, which pieces to cut from them and which pieces to scrap or return to inventory. Production Control also works with our new Combining program to optimize your material cutting for even more savings.

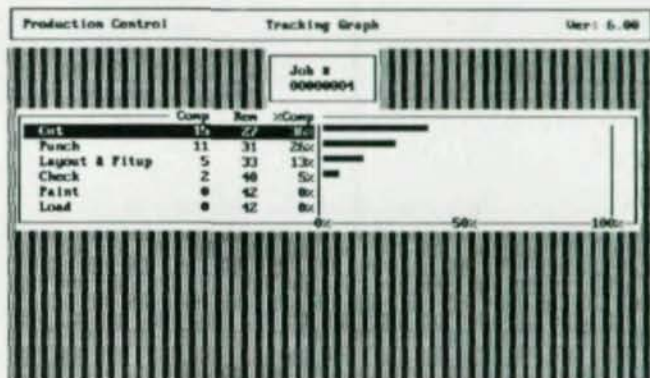

For a free demo disk, call Structural Software today at (800) 776-9118

SSC
STRUCTURAL SOFTWARE CO.
SOFTWARE FOR THE STEEL INDUSTRY
P.O. Box 19220, Roanoke, Va 24019

Survey of Building Code Officials

1. Are you aware of the issue of "shared design responsibility" with regard to the design of structural steel connections?

Only 20% of the respondents were aware of the issue by name. 46% of building officials were aware of the practice of shared responsibility.

2. Under the current code in your jurisdiction, do you require steel connections to be designed on the construction documents prior to your approval?

50% of participants do require connection design prior to approval. Of this 50%, 22% indicated that conditional permits, partial releases, or complete waivers are sometimes applied. 17% of the participants indicated that no structural review is performed at all.

3. Does the current code address the issue of shared responsibility specifically?



Rebecca Burluson

12% of the participants believed that their code directly addressed shared responsibility.

4. Are there any revisions regarding shared responsibility being pursued at the

present time in your area?

100% responded "no".

5. Does your code now allow the engineer of record to delegate the responsibility for steel connection design to the fabricator or contractor?

60% responded "Yes." (Many of these—36%—added "but the engineer is ultimately responsible for the work done on his/her design.")

6. If the EOR requires the contractor (or fabricator) to employ a licensed professional to prepare and stamp shop drawings for later review by the EOR, has the EOR shifted any of his/her responsibility to the contractor's engineer?

26%—Yes, responsibility rests with the seal on the design.

50%—No, ultimately the engineer of record must be responsible for the acceptability of the entire system.

24%—The courts will have to decide.

responsibility, according to Charles Gutberlet, Jr., a structural engineer with the U.S. Army Corps of Engineers. "Design responsibility remains with the Corp of Engineer designer. Transfer is not permitted." Simple connections—those found in the AISC Manual of Steel Construction—are not required to be on drawings. Also, all fabricators working on Corp projects must be AISC certified.



Abraham Rokach, P.E.

In contrast, Peter Schultz, a vice president with

Lehrer McGovern Bovis N.J. in Princeton, NJ, believes that "fabricators must be responsible for their work." However, he also stated that both engineers and fabricators need to be more complete in their drawings. One problem he noted is the lack



Charles Gutberlet, Jr.

of experience of the engineers doing the actual review of shop drawings. Typically, he explained, they are less experienced engineers. "There's a need for additional training programs in this industry," he concluded.

There's also a need for a national consensus, according to Harman. Engineers who do not assign design responsibility to their fabricators are at a disadvantage since their costs will be higher. "There needs to be a level playing field," he ex-



Peter Schultz

plained.

Currently, there is little agreement on where design responsibility rests. Rebecca Burleson, a professor at Auburn University, recently conducted a survey of building officials and their reaction to the question of design responsibility. While 60% of the respondents indicated that the engineer of record could delegate connection design responsibility, nearly a third of those officials indicated that "ultimately the engineer is responsible for the work done on his/her design." Interestingly, while all of the 138 surveyed building code officials were invited to the design responsibility session at the NSCC, none showed up. "The codes do not deal with this topic [design responsibility]," Burleson explained. "It's open to the interpretation of the code official." But ultimately, she hoped, the solution would come from within the design and fabrication industry.

Towards this end, a two-day session, "Critical Is-



Pictured at the podium: David Ratterman

Top row: D. Kirk Harman; Richard Horner; Richard Tomasetti; Robert Rubin; Charles Gutberlet, Jr.; Abraham Rokach

Bottom Row: Mike Holcomb; Peter Schultz; Rebecca Burleson; James Stori; Sophus Thompson; Leonard Ross

sues In Design Liability: Emerging Risks And Liability In The Shop Drawing And Submittal Process" will be held by the Georgia Institute of Technology in Atlanta on September 30 and October 1. For more information, contact: Saeid Sadri, College of Architecture, Georgia 30332-0155 (404) 894-4875.

(To purchase a copy of a complete transcript of the four-hour session, contact: AISC at (312) 670-2400.)

ATTENTION TO DETAIL

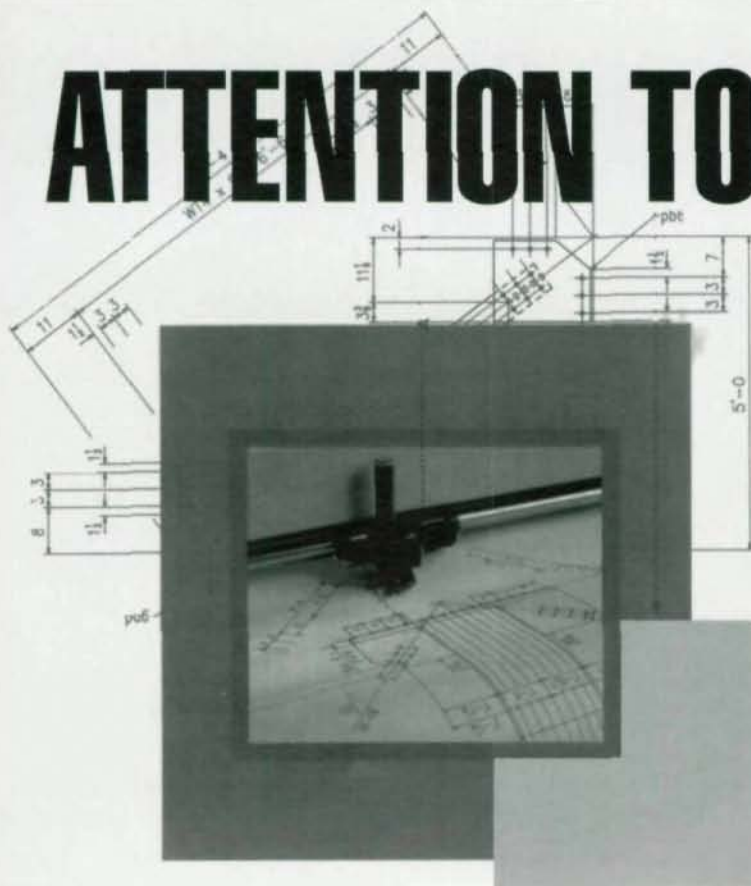

Computer Detailing Systems, Inc. introduces a state of the art structural steel detailing system which allows fabricators and detailers to meet the demands of the future with the ability to generate connection calculations, download to CNC equipment and interface with major design firms through the Steel Detailing Neutral File.

A practical, flexible system requiring minimal training, CDS is capable of producing intelligent 3D models, floor plans and elevations as well as shop drawings of unsurpassed quality using your standards and paper.

CDS is currently used by fabricators and detailers throughout the US and in Canada.

CONTACT COMPUTER DETAILING SYSTEMS today FOR A FREE INFORMATION PACK.

CDS

Structural Steel Detailing System

Computer Detailing Systems, Inc. • 7280 Pepperdam Avenue • Charleston, South Carolina 29418 • (803)552-7055

“Down the road, weathering steel



The Pennsylvania Turnpike is considered one of the safest and best maintained roads in the nation.

But improvements were badly needed near Pittsburgh to provide better access to the city's airport and I-80.

The Mahoning River Bridge, the largest of the 21 bridges being built on the new Beaver Valley Expressway, is a dual-lane, continuous-span, welded plate structure. The five interior spans are 258 ft with end spans of 182 ft and 228 ft for an overall length of 1,700 ft.

WHY WEATHERING STEEL?

The bridge is built with 4,600 tons of Bethlehem's ASTM A588 weathering steel. According to Kempf, the PTC finds weathering steel a very cost-effective bridge material for a number of reasons.

For example, its high strength permits longer spans, thus reducing the number of piers required. And that leads to foundation cost savings.

OTHER STRONG REASONS.

For another, it can be easily inspected, measured and evaluated. If necessary, it can be readily repaired. It's also highly adaptable to redecking, widening and performing other structural modifications.

Weathering steel also eliminates the need for both initial and maintenance painting. What's more, it's as attractive as it's environmentally sound.

Kempf comments, "The PTC's principal criteria for selecting materials for bridges and other Turnpike applications aren't based on price alone but also include long-term serviceability and durability. And with environmental restrictions being what they are today, it's only prudent to use

00481

will save us more than money.”

Frank J. Kempf, Jr., P.E. Bridge Engineer, Pennsylvania Turnpike Commission.



weathering steel wherever possible.”

Quite simply, weathering steel is a natural for a broad variety of bridge applications.

Including yours. Especially if you want to save more than money.

TECHNICAL LITERATURE AVAILABLE.

We would like to tell you more about weathering steel for bridge applications. For a copy of our Product Booklet No. 3790, and our latest Technical Bulletin, TB-307 on “Uncoated Weathering Steel Structures,” get in touch with your nearest Bethlehem sales office. Or call: Brian Walker at (215)694-5906. Bethlehem Steel Corporation, Construction Marketing Division, Bethlehem, PA 18016-7699.



Bethlehem



Owner: Pennsylvania Turnpike Commission, Harrisburg, PA
Fabricator: High Steel Structures, Inc., Lancaster, PA
Weathering Steel Supplier: Bethlehem Steel Corporation, Bethlehem, PA

Seismic Upgrade For A Concrete Frame

Four steel
buttress towers
were added
to a
concrete-framed
building to
bring it
up to current
seismic
standards

By Andrew T. Merovich, S.E.



The four steel towers were skillfully designed to meet the project's seismic needs while not disturbing the building's aesthetics. Top photo by Mert Carpenter Photography, Los Gatos, CA (408/370-1663)

When Sun Microsystems, Inc., decided to purchase a non-ductile concrete frame building in California dating back to the early 1960s, they knew going in it would require substantial renovation. The Palo Alto Hazardous Building Ordinance had already identified the structure as hazardous and in need of upgrading.

In addition, the company was planning on locating both administrative and research functions in the five-story building and the existing mechanical and electrical systems needed to be upgraded to handle the increased use of elec-

tronic equipment.

And finally, the company's spatial needs required an extensive reconfiguration of the existing space, including the demolition and replacement of partition walls.

Structural Concerns

The 120' x 384' (36.5m x 117m) structure has a poured-in-place reinforced concrete frame with 8¼"- (21cm) thick waffle slabs for floor and roof diaphragms. The columns for the five-story, 233,000-sq.-ft. (21646m²) building are set in a grid fashion, spaced 24' (7.3m) in both the north-south and east-west directions. The waffle coffer at the

grid lines were filled in with concrete, forming the beam sections of the frame. The typical columns are 20" x 20" (50.8cm x 50.8cm) and the building is clad with glass and precast concrete.

A structural analysis of the building's capability to survive an earthquake revealed two major concerns: a lack of ductility and a lack of strength in the columns.

About 15 retrofit schemes were developed by the project's structural engineer, Dasse Design Inc., San Francisco. Most of the retrofit options involved the addition of interior concrete shear walls. These methods were rejected for three

reasons: high cost; lengthy construction time; and an overall negative impact on building functionality.

The alternate to interior shear walls was to reinforce the structure using exterior buttresses. Various schemes—using both steel and concrete and either four or eight towers—were considered before the decision was made to add four braced steel towers.

10% Increase in Usable Space

Analysis showed that four towers were the minimum number required to brace the existing buildings. But more importantly, grouping the exterior braces into just four towers allowed the space within the towers to be useable, which added approximately 26,000 sq. ft. (2415m²) to the building. Unfortunately, this addition violated Palo Alto's recently established 50' (15.2m) height limit for occupiable space. However, since it fell within the allowable 0.50 allowable floor/area ratio (FAR) and would substantially increase the seismic safety of the structure, the city council accepted the proposed design. The computer analysis was performed using the ETABS program from Computers & Structures, Inc.

Steel braced frames were chosen over concrete systems because of their light weight, ease of erection, rigidity, ductility, and flexibility for window placement.

Architects on the project were Matarazzi Associates and Williams & Tanaka, both of San Francisco. General contractor was Koll Construction, San Jose, CA. The steel detailer and erector was AISC-member Reno Iron Works Co., Inc.

Tying It All Together

Substantial ties, or collectors, were provided to connect the existing structure to the new buttress towers. Steel plates, welded to the buttresses, were anchor-bolted to the concrete floor and roof beams, reaching into the center of the building. In addition, steel plates were added to strengthen the existing diaphragms at the roof and diagonal steel bracings were added

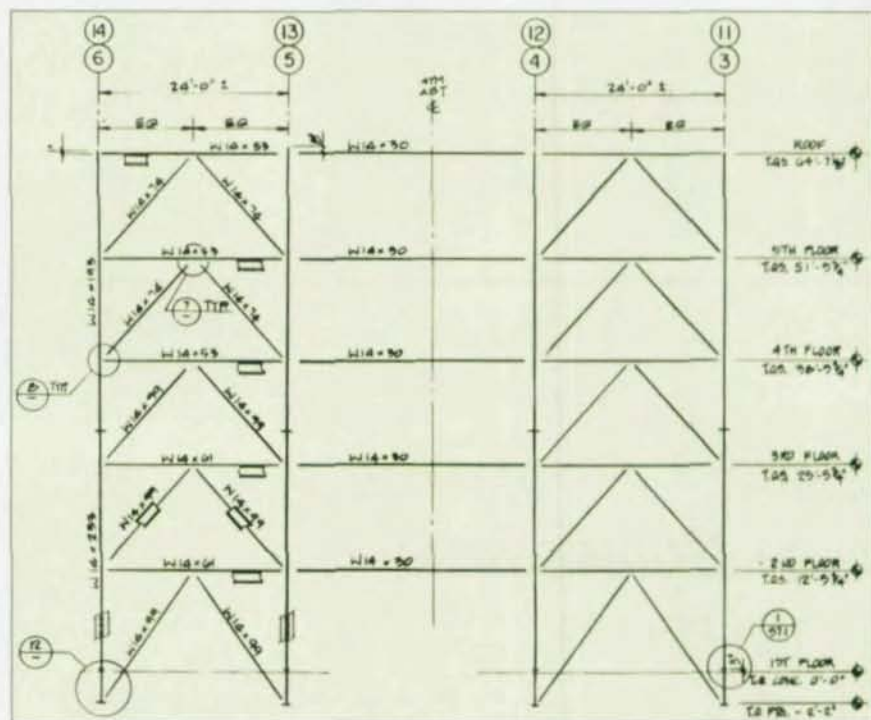
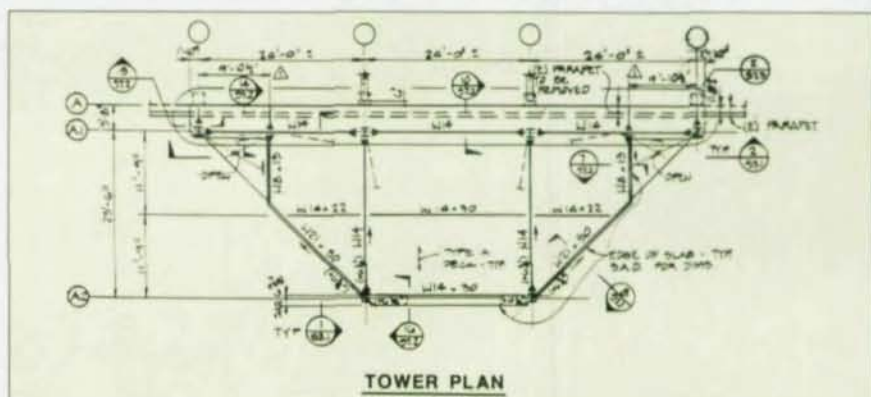
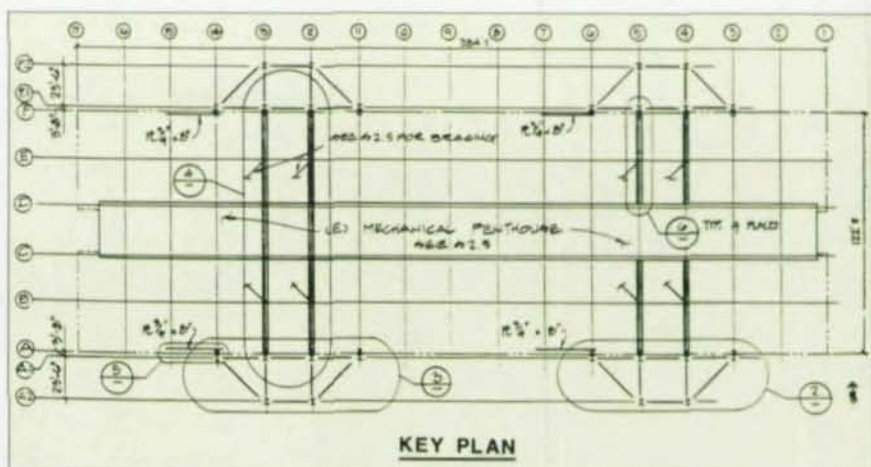

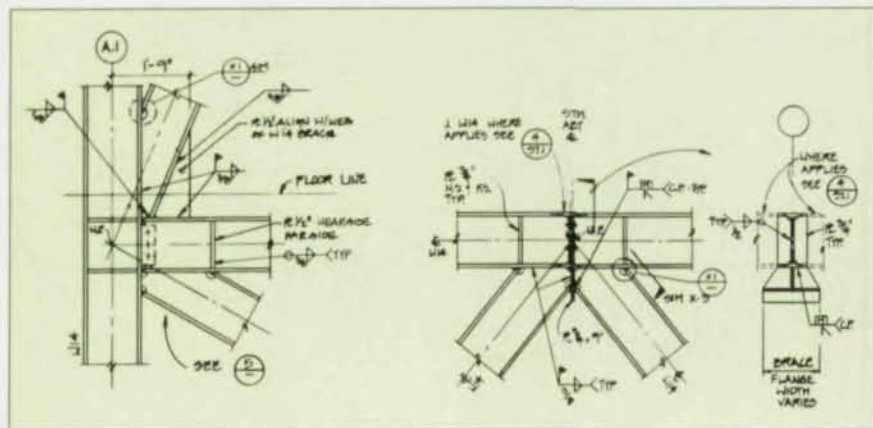

The addition of the four new steel towers not only added 26,000-sq.-ft. to the building's usable area, but brought it up to current seismic standards.

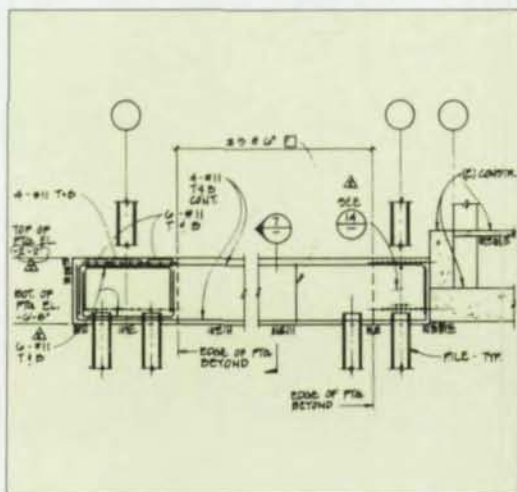

at the mechanical penthouse and tied to the buttress towers. To transfer the loads from the buttress towers to the pilings, large concrete

grade beams and pile caps were constructed.

Typical beam sizes ranged from W14x61 to W14x145, and typical

columns were W14x193 to W14x233. The diagonal bracing ranged in size from W14x74 to W14x193 and utilized fully welded moment connections.

New foundations were needed to support the buttress towers. Because of the large uplift forces, pilings and caisson footings were used to prevent tower rotation or rocking. An additional problem—a stream of contaminated ground water 10' (3m) under the structure—necessitated the use of steel piles because they are less apt than concrete piles or caissons to mix water from groundwater streams and thus cross-contaminate them.

Paying For Success

The seismic portion of the 14-month renovation project required six months and cost \$3 million, or approximately \$13/sq. ft. (\$140/m²). Approximately 70% of this cost was for the buttress towers, 10% was for the collectors and penthouse bracings, and 20% was for the new footing. The cost of the entire project was approximately \$14 million.

A. T. Merovich, S.E., is a principal with Dasse Design Inc., a structural engineering firm headquartered in San Francisco.

"PROTECT YOUR BUILDING FROM EARTHQUAKE DAMAGE WITH **BRIDGESTONE** MULTI-RUBBER BEARINGS (MRB)"

BRIDGESTONE
ENGINEERED PRODUCTS CO.

Seismic Protection

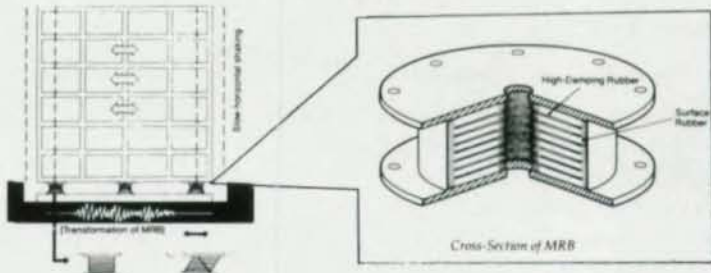

Nashville: P.O. Box 140993-T, Nashville, TN 37214-0993
Los Angeles: P.O. Box 6147-T, Huntington Beach, CA 92615-6147

Tel: (615) 872-1425, Fax: (615) 872-1437
Tel: (714) 962-1666, Fax: (714) 968-3441

1994 NATIONAL STEEL CONSTRUCTION CONFERENCE

David L. Lawrence Convention Center
Pittsburgh — May 18-20, 1994

Title Of Paper: _____

Primary Author's Name: _____
(First) (Middle Initial) (Last) (Professional Suffix-Degree)

Position/Title: _____

Place Of Employment: _____

Address: _____

City: _____ State: _____ Zip: _____

Business Phone: _____ Ext.: _____ Fax#: _____

Home Address: _____

City: _____ State: _____ Zip: _____

Home Phone: _____ Preferred Mailing Address: () Business () Home

Co-Author(s):

1. Name: _____
(First) (Middle Initial) (Last) (Professional Suffix-Degree)

2. Name: _____
(First) (Middle Initial) (Last) (Professional Suffix-Degree)

Invitation/Call For Papers:

The 1994 National Steel Construction Conference will be held at the David L. Lawrence Convention Center in Pittsburgh from May 18 through May 20, 1994. Participants include structural engineers, fabricators, erectors, educators, and researchers. Potential authors may submit abstracts of papers on design, fabrication and erection of steel-framed buildings and bridges.

Topics of interest include:

- Practical application of research;
- Advances in steel bridge design and construction;
- Composite members and frames;
- Heavy framing connections;
- Steel-framed housing;
- Partially restrained connections;
- Eccentrically braced frames;
- Economical fabrication and erection

- practice;
- Quality assurance and control;
- Innovative management techniques;
- Case studies of unique projects;
- Computer-aided design and detailing;
- Material considerations;
- Fire protection;
- Coatings and material preparation;
- Innovative structural systems.

Guidelines for abstract submittals:

Abstracts for papers must be submitted before July 15, 1993. They should be approximately 250 words in length and should be submitted on a separate sheet of 8½" x 11" white paper attached to this form.

Authors will be informed of the Organizing Committee's decisions by October 1, 1993. The selected authors

must then submit their final manuscripts, in a form suitable for publication in the 1994 Conference Proceedings, by February 1, 1994.

Preparation of paper:

Final manuscripts for publication in the official 1994 Conference Proceedings are expected to be approximately 20 pages in length. Copy (including photographs and drawings) must be camera-ready. Complete instructions will be forwarded to authors upon acceptance of Abstract Proposals.

Poster Session:

Papers not accepted for presentation at the Conference may, at the author's expense, be presented at the Conference Poster Session. Guidelines for the Poster Session will be provided upon request.

Return your abstract with this submission form before July 15, 1993 to:
American Institute of Steel Construction, Inc., One East Wacker Dr., Suite 3100,
Chicago, IL 60601-2001 Attention: 1994 NSCC Abstracts
Phone: 312/670-2400; Fax: 312/670-5403

MAKING THIS BUILDING S WOULD GIVE MOST CO

But not Vulcraft. We saw it as one of our greatest challenges ever. Because we not only supplied steel joists and joist girders for the project, we also helped design the framing system so that only limited structural damage could be expected from an earthquake measuring up to 7.5 on the Richter scale.

The Evans & Sutherland building, which contains millions of dollars worth of sensitive computer equipment, is located within a mile of the Wasatch Fault in Salt Lake City.



SAFE FROM EARTHQUAKES COMPANIES THE SHAKES.

That was essential because the building, which was constructed for Evans & Sutherland Computer Corporation, is located within a mile of the Wasatch Fault in Salt Lake City. What's more, Evans & Sutherland is a leading designer of special-purpose digital computers, software systems and display devices — products extremely vulnerable to damage from seismic tremors.

To plan for maximum protection, Vulcraft was asked to join with the architects and engineers at the design stage of the project. Already, they'd decided to use a "base isolation" system, the most advanced buffering method available. But using our steel joists and joist girders was also an important decision. The joists and joist girders are much lighter in weight than wide flange beams, so the entire building required less steel, lighter columns and less foundation. And this not only lightened the load for the base isolators, it saved appreciably on building costs.

Throughout construction, Vulcraft remained constantly involved, tailoring our delivery of materials to the exact erection schedule and meeting deadlines without fail. What's more, our joists and joist girders helped the steel erectors meet their deadlines. That's because our products are fast and easy to erect — a fact that saves time and money on virtually any job where they're used.

So whether you need Vulcraft's help to protect your building from earthquakes or you want to stay out of the hole when it comes to construction costs, contact any of the plants listed below. Or see Sweet's 05100/VUL.



The design team chose a "base isolation" system to accommodate seismic loads. They also specified Vulcraft steel joists and joist girders for the building.

VULCRAFT

A Division of Nucor Corporation

P.O. Box 637, Brigham City, UT 84302 801/734-9433; P.O. Box F-2, Florence, SC 29502 803/662-0381; P.O. Box 169, Fort Payne, AL 35967 205/845-2460; P.O. Box 186, Grapeland, TX 75844 409/687-4665; P.O. Box 59, Norfolk, NE 68701 402/644-8500; P.O. Box 1000, St. Joe, IN 46785 219/337-5411. Architect: Erlich-Rominger Architects AIA; Structural Engineer: Reaveley Engineers & Associates, Inc.; General Contractor: The Bettyon Corporation; Steel Fabricator: D&H Steel Supply, Inc.; Steel Erector: Steel Deck Erectors, Inc.

Active Bracing Systems

A recent full-scale mockup showed the practicality of "smart" bracing systems for seismic design

By Andrei M. Reinhorn
and T.T. Soong



Figure 1: Experimental test building in Tokyo featuring "smart" braces

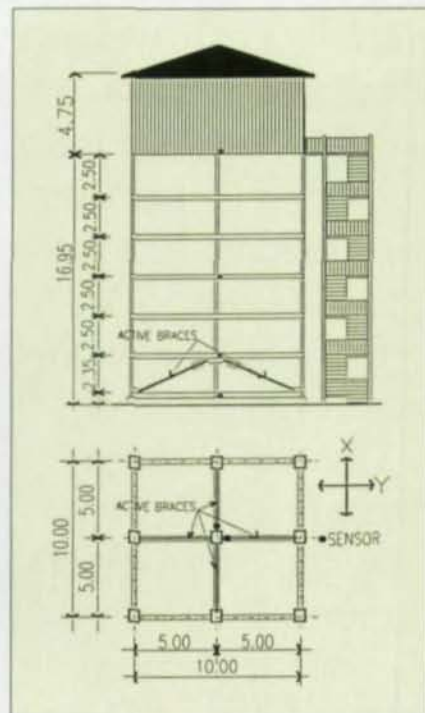

Slender structures, such as tall buildings and long-span bridges, are prone to excessive lateral sways that can lead to structural and non-structural damage and even to collapse during earthquakes and windstorms.

Traditionally, structural engineers have dealt with vibration by increasing the strength and stiffness of the structure. During the last few years, some engineers have begun using passive energy dissipation systems such as base isolation systems where structural members rest on a device designed to dissipate energy. Other protective systems dissipate energy via plastic deformation, viscous fluids or heat transfer.

Researchers are now working on a new generation of protective systems. These active systems possess some kind of intelligence that allow it to direct the energy dissipation in an efficient way. The idea behind the "smart" system is that it can sense what the building is experiencing and, through electronic and hydraulic feedback, activate braces to counteract the vibrations.

Tests have recently been conducted on a six-story building in downtown Tokyo that was equipped with "smart" braces to control vibrations. The tested system was designed and developed at the State University of New York at Buffalo and transferred, assembled and tested in an experimental building of Takenak Construction Co. (see Figure 1). While several active mass dampers have been implemented in full-scale structures during the past few years, the Tokyo test is the first to be tested under actual ground motions. During the test period, Tokyo experienced three moderately strong earthquakes.

The system is designed to "flex its structural muscles" to adapt to excessive vibrations. The "smart" bracing system reacts with enough speed and accuracy to prevent excessive vibration in a tall building, making 300 complete cycles of correction on one second (see Figure 2).

The active control system uses structural braces and tendons. It consists of a set of diagonal braces or prestressed tendons connected to a structure, with electrohydraulic servomechanisms controlling their tensions. Such mechanisms also have applicability for retrofit, since tendons and bracings are already existing members of many structures.

The preliminary evaluation of this active bracing system demonstrated several key advantages:

- A full-scale efficient active structural control system can be developed within the limits of current technology using off-the-shelf components.
- It can be used on buildings of any height.
- It can be used on both new buildings or retrofit projects.
- The bracing system improves the response of active mass dampers, which were also evaluated on the structure.
- It allows more architectural flexibility.

Full-Scale Experimental Implementation

The active bracing system was tested in an unclad, symmetric, six-story building (see Figure 1). It was constructed of rigidly connected steel frames made of A36 rectangular tube columns and W-shaped beams with reinforced concrete slabs at each floor. The details of a typical bay construction are shown in Figure 3. In order to simulate a typical high-rise building, the 600-metric-ton (600-ton) structure was designed as a relatively flexible structure with a fundamental period of 1.1 seconds in the strong direction and 1.5 seconds in the weak direction. It was constructed without cladding except for the top story (sixth floor), which housed an experimental mass damper.

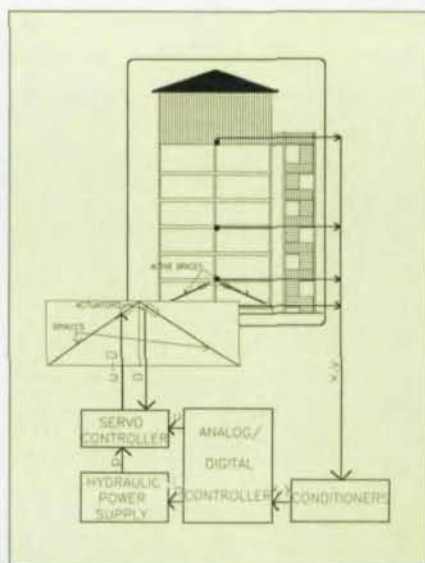
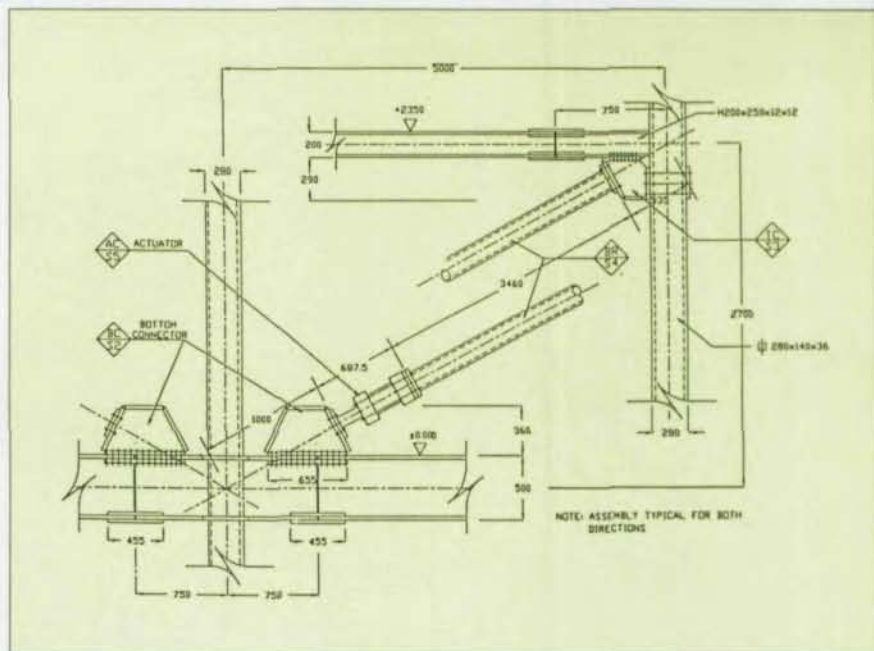

Figure 2 (Left): A schematic of the bracing control mechanism shows the process involved in the system's reaction to vibration.

Figure 3 (Below): The details of a typical bay are exposed in this diagram. The active protective system is composed of solid diagonal tube braces, which were attached at the building's first story after the main structure was built.



Side access stairs were built without connection to the main structure to preserve the symmetry of the system. Because there was no cladding and because of the simple connections, the structure had a very low damping in the dominant modes (less than 1%).

The active protective system is composed of solid diagonal tube braces, which were attached at the building's first story after the main structure was built (see Figure 3). The control system enables longitudinal expansion and contraction of the braces via hydraulic servocontrolled actuators, which were inserted along the brace ele-

ments and formed an internal part of the bracing system.

Braces were designed for the maximum control force and the anticipated stiffness to assure that buckling would not occur under actuator actions. Circular steel tubes were used as bracing members with the following specifications:

Length.....360.5 cm (11.8')
Diameter.....165.2 mm (6.5")
Thickness....4.5 mm (.18")
Strength564 kN (127 kips).

A hydraulic power supply, an analog and digital controller, and

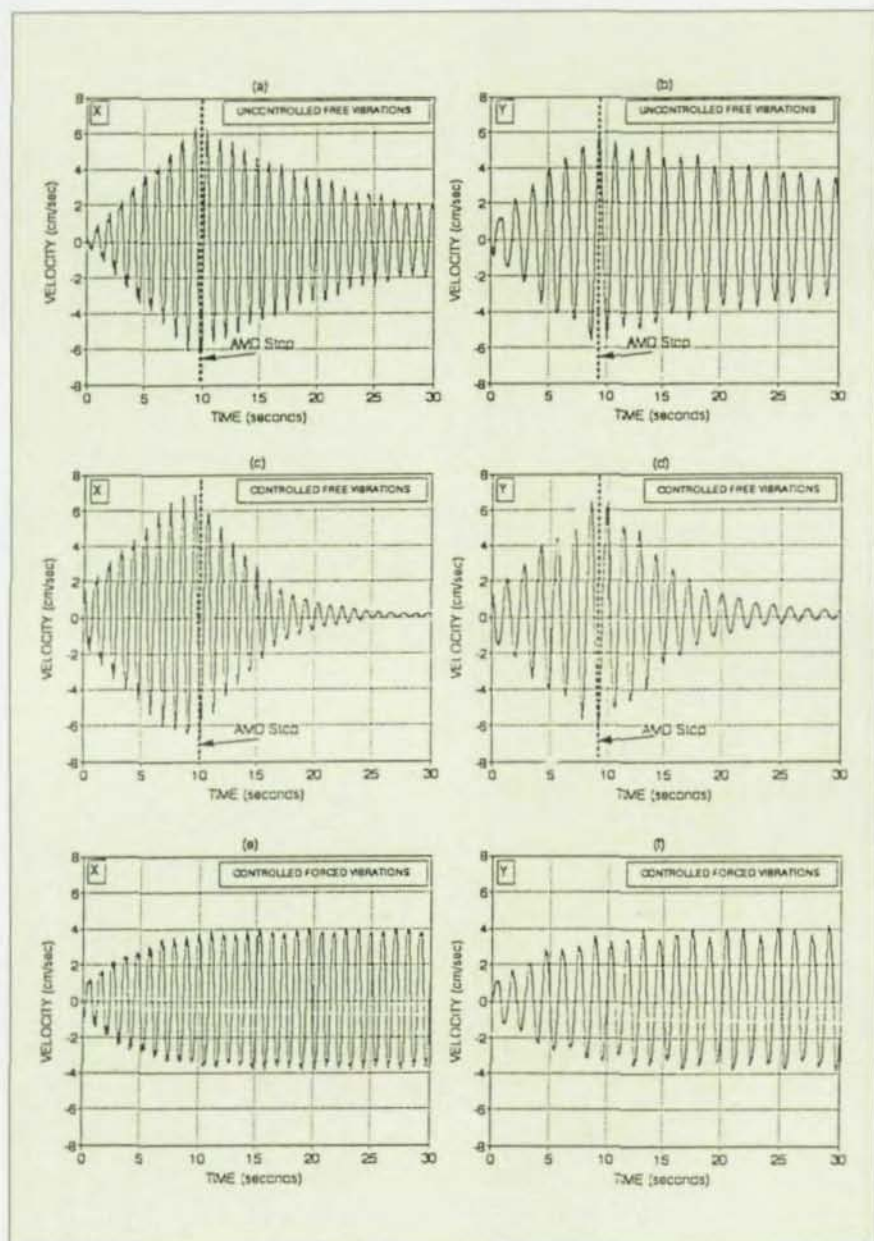

Figure 4: Response during free and forced vibrations.

an analog sensor also were utilized in the system.

Four units of Parker, heavy-duty hydraulic cylinder series 2H-style TC (NFPA style Mx2) were selected as actuators with an average capacity of 344 kN (77 kips). Although the expected movement in the actuators was only plus/minus 12 mm (0.47"), larger stroke actuators were chosen for the experiment to enable length corrections during construction. In future applications, a much shorter stroke actuator would be sufficient. The physical size of the actuator can be

reduced further by increasing the working pressure of the hydraulic oil.

Maintaining Full Power Reserves

The final design of the system allows the active system to remain ready for full power controlled operation, while requiring a hydraulic pump to operate for only a few seconds each hour to keep the system fully charged. For this purpose, hydraulic accumulators are placed between the pump and a hydraulic manifold (a complex

valve), and are kept fully charged by the hydraulic pump. This stored power is used when the active control is first started so that full hydraulic pressure is instantly available.

The accumulators can supply enough power to allow the hydraulic pump to reach full pressure operation, and can drive the actuators for approximately one minute—longer than most earthquakes—in the event of a power failure.

Control System

An analog/digital controller was chosen to drive the hydraulic system based on the requirement that the analog controller must be compatible with the hydraulic service manifold and with the servovalves, and be capable of simultaneously controlling the two sets of servovalves. Moreover, the controller has a series of fail-safe circuits designed to properly shut down the entire system if any problems are detected. As built, the controller was designed to allow a digital computer to monitor the status of the controller and the hydraulic system linked to the controller, and to adjust some operating parameters of the system, including triggering the fail-safe circuits.

A microcomputer executes the control algorithm, monitors the status of operation of various hydraulic components through the analog/digital controller, and monitors the status of the structural system via sensors connected to the structure. The software algorithm is designed to start operation upon detection of an event or shut-down in case of malfunctions. The system consists of a 80386-based 25 MHz IBM-compatible computer equipped with conversion boards to provide interface for up to 16 channels of differential input from sensors and four channels of analog output to the controllers. In addition, 16 LSTTL, digital logic channels are available on the computer boards. The analog channels are used to interface with the sensors (conditioners) and with the analog servoloop. The digital logic

channels are used to monitor the state-of-the-controller and adjust its operations.

The sensors are an integral part of the "smart" system. This control system has four servovelocity seismometers of type Tokyo Sokushin VSE11 for each principal direction of the building with an output range of plus/minus 100 cm/sec (39"/sec). The velocity sensors are located on the ground at the first, third and sixth floors. The same sensors can provide acceleration information up to plus/minus 1000 cm/sec² (394"/sec²). Additional transducers are mounted at each floor to monitor building behavior. Each actuator is equipped with a displacement transducer (LVDT) (see Figure 4) and each has a range of plus/minus 12 mm (0.47"), which is used to adjust the length of the brace via a servovalve loop.

System Performance

The building structure was subjected to a series of excitations to

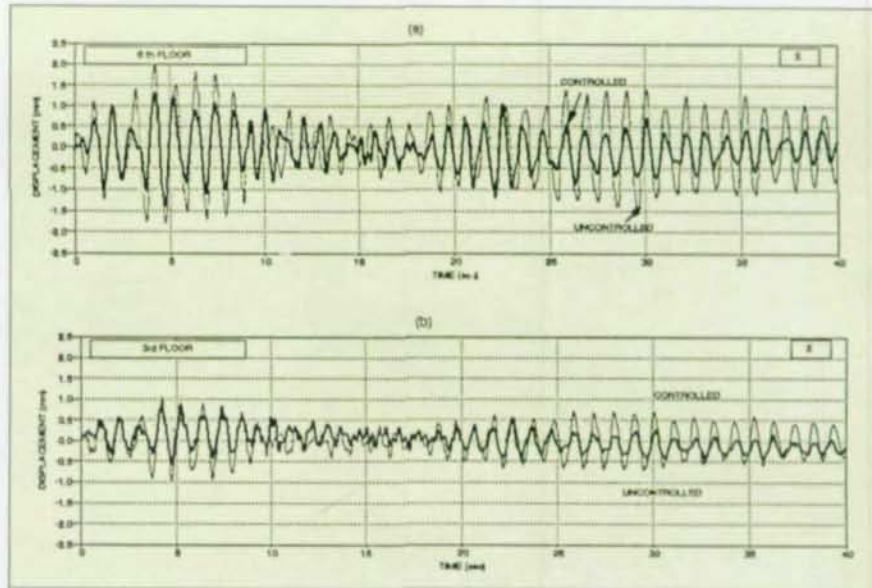

Figure 5: Structure displacements during April 14, 1992 earthquake

MOMENT ROTATION CURVES FOR PARTIALLY RESTRAINED CONNECTIONS USING **PRCONN**

Runs on IBM compatible PCs with wide choice of printer and/or plotter graphics ♦ Connection library includes 31 types: single angle, double angles, single plates, end shear plates, top and seat angles, and combinations of these ♦ Composite and non-composite beams with bolted and/or welded connections ♦ Constant and variable load beam lines giving beam end moments and rotations ♦ Uniform and concentrated load options with midspan deflections ♦ Based upon research published in archival journals, conference proceedings, and University reports.

For free manual, call or write to:
RMR DESIGN GROUP, INC.
4421 E. Coronado Drive
Tucson, AZ 85718
(602) 577-2191

A Quick Quiz For Structural Engineers

The more a computer program costs, the better it is. TRUE FALSE

A program that solves complex, difficult problems must be complex and difficult to use. TRUE FALSE

Structural engineering software can never be fun to use. TRUE FALSE

If you answered *TRUE* to any of the above, or you would like to know more about a truly innovative software program, call us!

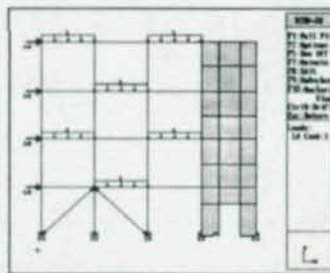

RISA-2D

Your complete solution for
frames, trusses, beams,
shear walls and much more!

RISA
TECHNOLOGIES

26212 Dimension Drive, Suite 200
Lake Forest, CA 92630
1-800-332-7472



COMPLETE THE LOOP AND INCREASE YOUR PROFITS WITH STEEL 2000.

Find out why some of the top fabricators in the United States and Canada have chosen Steel 2000. Call 601-932-2760.

STEEL SOLUTIONS INC. P.O. Box 1128 • Jackson, MS 39215



ORDER YOUR SOFTWARE TODAY!

A knowledge-based system for designing Composite and Non-Composite beams and girders with Steel Deck using documented AISC rules.

Design a Complete Bay. Incorporate the use of all grades of steel or concrete. Specify live loads, dead loads, line loads, tributary area loading and concentrated loads. Set deflection limits. Specify code area reductions. Obtain vibration analysis for final design. Print complete design calculations. Print design tables.

STEEL DECK INSTITUTE LRFD FLOOR DESIGN SOFTWARE NEW UNIQUE and RELIABLE

- OPERATES ON IBM OR COMPATIBLE WITH 640 KBYTES OF RAM
- SAVES HOURS IN DESIGN TIME
- PRODUCES A COMPLETE DESIGN WITH ALL NECESSARY CALCULATIONS
- DEVELOPED BY STRUCTURAL ENGINEERS, INC.
- SPONSORED BY SDI and AISC COOPERATING WITH AISI

NO. UNITS ORDERED _____

\$295⁰⁰ ea.

NAME _____ COMPANY _____
 ADDRESS _____ CITY _____
 STATE _____ ZIP _____ PHONE _____
 METHOD OF PAYMENT:
 VISA _____ MASTER CARD _____ CHECK/MO _____
 CARD NO _____ EXP. DATE _____
 NAME ON CARD (PRINT) _____
 SIGNATURE _____

Steel Deck Institute



P.O. BOX 9506, CANTON, OHIO 44711 • TELEPHONE/FAX: 216/493-7886

identify its dynamic properties and to verify the performance of individual components as well as of the overall system.

Mass Damper Simulates Seismic Conditions

For the identification studies, the structure was monitored during ambient vibrations created by heavy traffic and during self excitation tests. Free vibrations and forced vibrations were generated using the 6 metric ton (6.6 ton) active mass damper (AMD) located at the top of the test structure operated in reverse action of its usual function.

Note that the presence of the AMD in the same test structure also allows a performance comparison of active mass dampers with the active bracing system.

Seismic Activity

In addition, the system was tested during three strong ground motions that occurred on April 10, April 14, and May 11, 1992. The three earthquakes of magnitude 4.9, 5.0, and 5.6 respectively had peak accelerations of approximately 10 cm/sec^2 ($3.9"/\text{sec}^2$) (approximately 1% of gravity).

For free and forced vibration studies the AMD was activated in both directions using harmonic (sinusoidal) excitations that produced vibrations in the building. Free vibration observations were obtained from measurements of the structural response made after abruptly stopping the mass damper movement. The responses of the sixth floor (see Figure 4) indicate large increases in damping, more pronounced in the decay in the y-direction, and a successful brake in the build-up in the resonate response (Figures 4c. and f.)

The performance of the structure shows a substantial increase in the equivalent damping ratio and a substantial reduction of the resonant amplitude. Control results from non-resonant forced vibrations also indicated good amplitude reductions in all affected modes.

The main tests were done while the control system was automati-

cally activated during the aforementioned earthquake episodes. The ground motion was simultaneously recorded and is used with an analytical model to estimate the probable response of the structure in the uncontrolled mode. The analytical model was carefully calibrated prior to its use for earthquake response estimates by comparing the structural response in various tests with the one computed. A typical response is shown in Figure 5. More detailed results are available in "Active Bracing System—A Full Scale Implementation of Active Control," Technical Report #NCEER-92-0020, National Center for Earthquake Engineering Research, SUNY/Buffalo, August 1992.

Future Applications

The active bracing system is based on commonly used braces that provide increased stiffness and strengthening to lateral force resisting systems. The active system is therefore an extension of a well understood function. The "smart" technology provides, in addition to strengthening, additional damping that dissipates the vibratory effects of lateral loading such as earthquakes, wind gusts, and waves. Therefore, wide applications of this system may be considered for such structures as bridges, buildings, towers, and off-shore platforms. The system also can be used to retrofit existing structures.

Steel structures naturally possess low damping, as in the system tested in Tokyo. For such structures excessive lateral sways can be easily controlled using active systems, thus reducing the necessity for lateral strengthening using heavy structural members and therefore opening the way to taller construction at a reduced cost.

Andrei M. Reinhorn is a professor of structural engineering in the department of civil engineering at SUNY/Buffalo. T.T. Soong is the Samuel P. Capen Professor of Engineering in the civil engineering department at SUNY/Buffalo.

VOSS ENGINEERS THE RIGHT BEARING PAD FOR YOU!

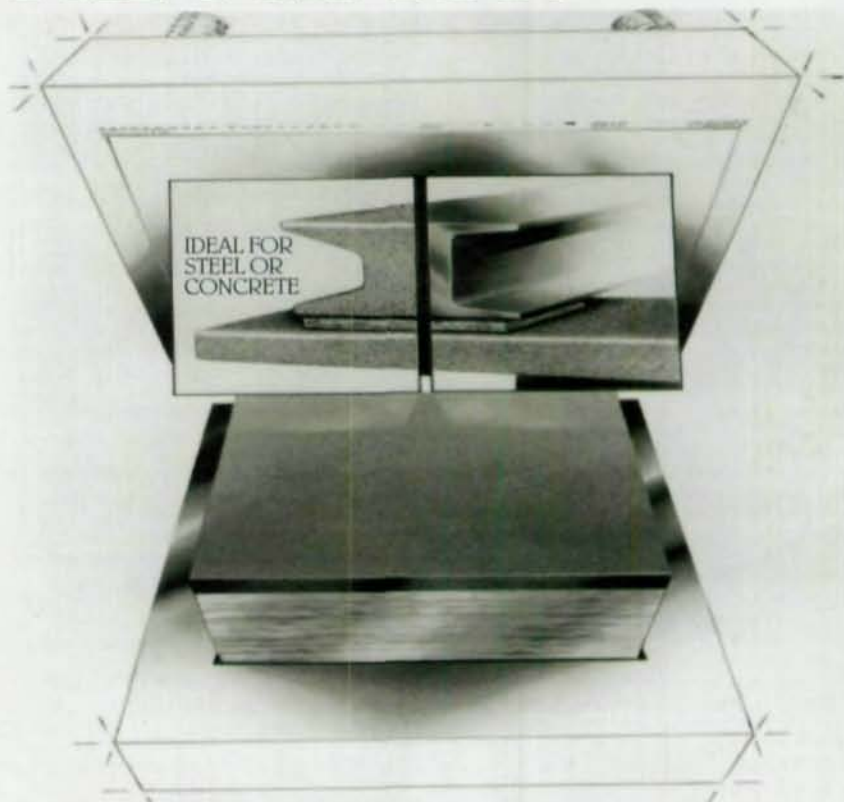

SORBTEX Expansion Bearings

- High Load
- Seismic and Thermal movement control
- Low Friction
- Low Deflection
- Rotation Capabilities
- AASHTO Approved

FIBERLAST

A new choice in a

structural bearing pad which meets today's higher load requirements while remaining cost effective.

VOSS Slide Bearings

Steel backed PTFE accomodates structural movements due to thermal expansions - can also be bonded to other Voss Bearings to allow for misalignment or rotation.

NEW CRITICAL BEARING PAD DATA!



Write for your **free** Design Manual and software Design disc. Also available: Fiberlast conventional manual & disc.

VOSS ENGINEERING, INC.
6965 N. Hamlin Ave.
Lincolnwood, IL 60645
ph: 708 673 8900
fax: 708 673 1408

West Coast Quakes Send Tremors Throughout The East

It used to be that only buildings out West needed to meet strict seismic codes; but now building codes along the Eastern seaboard have been drastically amended

By Richard A. Esslinger, P.E.

In many parts of the United States—especially the Eastern seaboard—building codes had long ignored the severity of earthquakes and the damage they can cause. Yet, research has revealed that earthquakes and earth tremors are a threat in a far greater percentage of the country than most people commonly believe.

While documentation shows that earthquakes have not resulted in loss of life or costly damage along the East Coast, cataloguing of this kind of information—including where earthquakes have occurred, when, what size and the extent of damage—has been sporadic and inconsistent. It was not until 1900 that instruments were used to record and locate this activity. Ever since then, information has been gathered and more uniformly recorded by such organizations as the International Seismological Center in England, the U.S. National Earthquake Information Service, the National Ocean Survey and the U.S. Geological Survey.

Minimum Requirements

Designers of building codes nationwide have used this catalogue information to define the minimum structural design requirements for withstanding the lateral forces of earthquakes. These forces are generated from the movement of the ground due to seismic activity and converted into horizontal and vertical loads. Building frames, architectural components and mechanical and other equipment must be designed to withstand these forces.

In areas where quakes have oc-

curred more recently and caused extensive damage and loss of life, these design parameters have long been incorporated into structural design. Elsewhere, though, the building codes are just beginning to reflect the potential damage of devastating seismic activity.

Recent Changes

Up until quite recently, the general practice amongst Eastern design professionals has been to ignore or conduct a minimal check of design loads for seismic resistance. This practice continued until 1987, two years after the disastrous quake which shook Mexico in 1985. At that time, building codes were updated and seismic requirements were redefined. The codes were also expanded to include a ranking of building types required to be designed to withstand the lateral loads of an earthquake.

Nevertheless, it was not until October 17, 1989—the earthquake in San Francisco that shocked the nation—that code officials embarked on a major effort to enforce seismic regulations nationwide. The disaster was real, live on television during the World Series and very explicit with all of its media coverage. People across the country saw first-hand the catastrophic loss of life, tragedy and extensive damage. This made laymen and design professionals alike aware of the need to further prevent this type of disaster.

As a result, local and national building code officials scrambled to review their current building codes. They immediately incorporated requirements increasing the

design criteria necessary for the protection of the public through the advancement of current technologies. In addition to structural specifications, requirements for the lateral stability of certain architectural, mechanical, plumbing and electrical building components were also included.

Changing Codes Poses Problems

Since then, the building codes have changed their design requirements annually. These constant amendments have made it difficult for design and construction professionals to incorporate the appropriate code provisions when designing buildings that will undergo future expansion.

While these revisions to the building codes are important and necessary, the process of change is confusing and costly. An owner designing for current needs and anticipating future growth by allowing for vertical expansion must now predict space functions and design load requirements for the future. During design, an engineer can accommodate future vertical or horizontal expansion by incorporating gravity and lateral loads into the design of the foundations, building columns and bracing systems. Older buildings that were planned for vertical expansion will most likely require extensive restoration work to satisfy newer and future building codes.

Specialty Hospital Faces Code Challenges

Deborah Heart and Lung Center, a specialty hospital in Browns Mills, NJ, has been facing this dilemma during its current expansion project. The original hospital buildings were constructed in the 1940s and 1960s. Two major additions were completed in the late 1970s.

Currently, additions of a five-story office building, one-story parking deck, three-story hospital annex and two-story (to be expanded to four) new hospital building are under construction. During the master planning phase for these additions, Deborah was

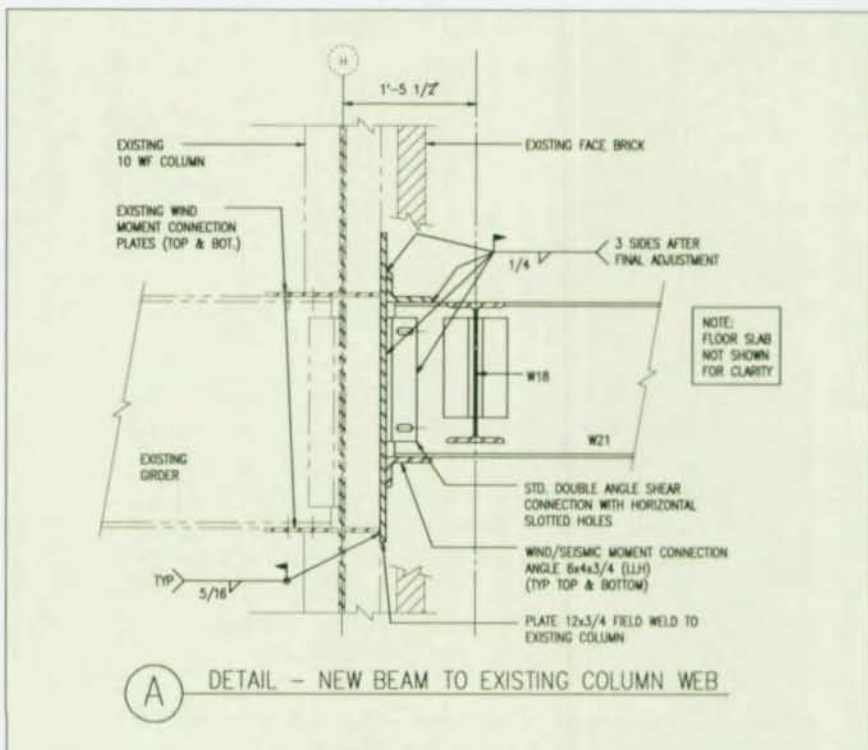

A five-story addition at the Deborah Heart and Lung Center (top) in Browns Mills, NJ, was designed to resist seismic loads. The lateral loads slightly exceeded code-required wind loads because of the light structural steel framing. Pictured above is the connection between a new three-story addition and an existing hospital building. The beam-to-column connections were designed for the new loads and detailed similar to those of the existing building.



Semi-rigid beam-to-column connections, such as those shown above and opposite, were used on the new two-story hospital addition at the Deborah Heart and Lung Center.

able to determine the capability of each major structure to meet seismic building codes. This information helped administrators and designers zone each building—existing, new and future—for their space functions and ability to withstand an earthquake.

Light-Weight Steel Framing

The office building and parking deck were designed in accordance with current building codes without provisions for future expansion. Lateral loads due to earthquakes have been incorporated into the design. For the office building, the lateral loads slightly exceeded code-required wind loads because of the building's light structural steel-frame construction. The precast concrete parking deck—because of its concrete weight—also was governed by seismic lateral loads. They, too, were minimal and easily accommodated. The detailing of member connections was enhanced to make



SHOP DETAILS

for

STRUCTURAL STEEL & MISCELLANEOUS METAL
with AutoCAD®

Beams, Columns, Plans, Elevations, Stairs,
Handrail, Grating Layouts, Ladders, Lintels,
Bracing, Bins, Base Plates, Roof Frames, Grillage, Gussets,
Floor Frames, Kickers, Hangers, Relieving Angles, Stack Framing,
Access Platforms, Tubes, Trusses, Towers
or anything else you can fabricate.

Beams and Columns, Plans and Elevations - Version 5
English or Metric

COMPUTER DETAILING CORPORATION

A service company for steel fabricators and detailers

1310 Industrial Blvd.
Southampton, PA 18966
215-355-6003

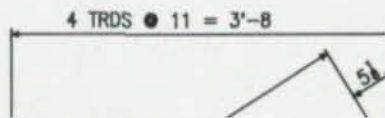
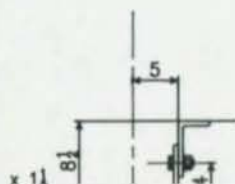

DESCON DESIGNS AND DETAILS STEEL CONNECTIONS

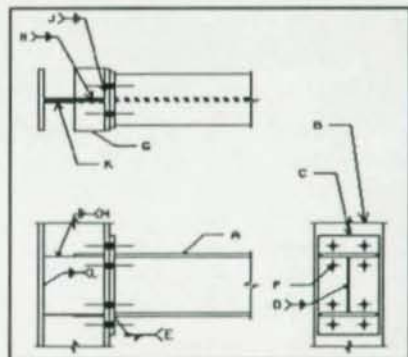
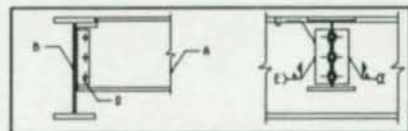

FOR A FREE DEMO DISK
CALL OR WRITE TO

OMNITECH ASSOCIATES

P.O. BOX 7581
BERKELEY, CA 94707
(510) 658-8328

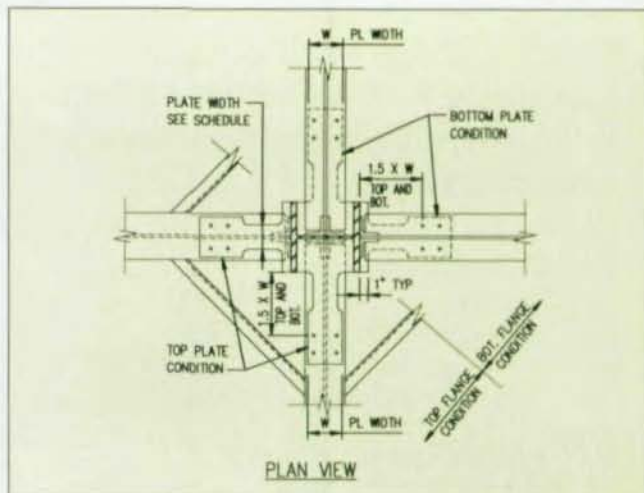
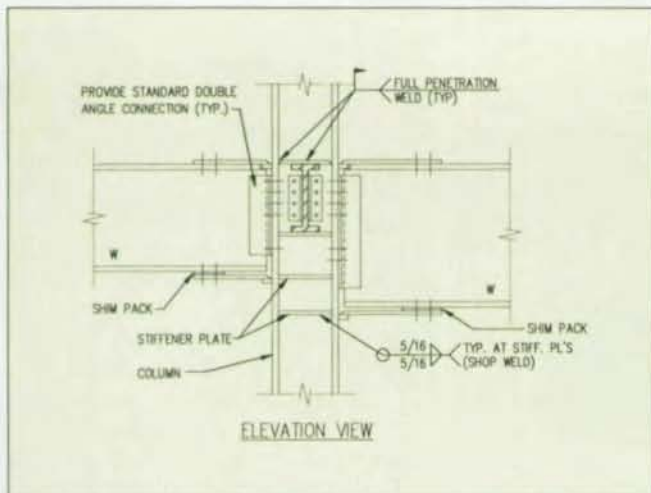

them more ductile.

The structural steel, three-story hospital addition will house an expansion of mechanical and electrical services on the ground floor, radiology on the first floor and critical care support functions on the second floor. The present services and functions of this new addition and the adjacent existing

building were categorized as critical by seismic importance factors. Therefore, the new facility was attached directly to the adjacent existing steel-frame structure, and the lateral loads were accommodated by the structural frame of the entire new and existing building. The beam-to-column connections for the new addition were designed

for the new loads and detailed similar to those of the existing structure.

Planning For Future Expansion

The new two-story hospital building with future vertical expansion to four stories is to be constructed over an existing ground-

For the BEST in Bridge Software...

DESCUS-PLUS

Design of Curved Girder Bridges

NEW FEATURES:

- Live Load Distribution - Automatic (Longitudinal & Transverse)
- Mesh Generation - Automatic
- Rating - Auto Rating Factors
- Influence Line Output (From Influence Surfaces)
- Metric Conversion
- Uses AASHTO 15th Edition
- Lease or License
- Timesharing

Free Trial...
FULL Program!

MERLIN DASH

Design & Analysis of Steel Girder Bridges

- AASHTO - Uses New 15th Ed.
- FHWA - Endorsed and Used by
- DOT's - Used by 35 States
- Design - Cost Optimized
- Friendly - Menu-Driven Input
- Graphics Display of Output
- Output Report Selection
- Quality and Performance

MICROBARS

Bridge Analysis And Rating System

- Derived from Original BARS Program
- Compatible with DOT's Structural Databases
- Rates All Conventional Member Types
- Considers All Construction Materials

Available Exclusively Thru:

OPTI-MATE, INC.

P.O. Box 9097, Dept. A, Bethlehem, PA 18018
(215) 867-4077

Structural Material Sorter Ver. 4.2

A series of programs designed to help steel fabricators manage material.



- Reduces labor — Increases accuracy.
- Automatically computes weights, surface areas, bolt counts and lineal totals.
- Quickly sorts lists into proper order.
- Produces optimum length-cutting lists from in-house stock, vendor's stock or the best combination of each.
- Provides shipping lists based on piece-mark sequence.
- Tallies material costs, shop hours and field hours for easy estimating.
- Uses simplified terms so non-tech personnel can operate with ease.
- External Data Interface can import existing computer-based material lists.
- Call today for a FREE demo kit, including the full system's operator's manual!

E.J.E. INDUSTRIES, INC.

COMPUTER SOFTWARE FOR STEEL PROFESSIONALS
287 Dewey Avenue Washington, PA 15301 (800) 321-3955

FACT:

RAMSTEEL was the highest rated of all Structural Engineering Software on the market today according to the 1992 *Modern Steel Construction Magazine* user software survey.

"RAMSTEEL allowed us to meet a very tight schedule with a smaller, more efficient design team. The savings in man hours quickly paid for the cost of the program."

Nabih Youssef, S.E., President,
Nabih Youssef & Associates, Inc. Los Angeles, CA

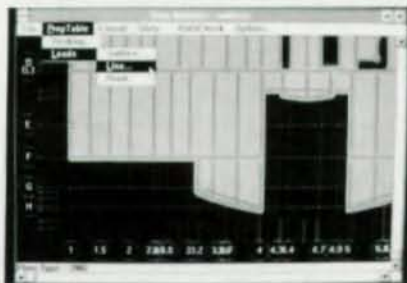

RAMSTEEL provides user interaction like you've never seen before!



Break into the LRFD competitive edge with full ASD vs. LRFD comparisons at the click of a button.

RAM
STEEL

INTEGRATED ANALYSIS, DESIGN
AND DRAFTING OF STEEL BUILDINGS

For more information or an in-house demonstration, call 800-726-7789

Ram Analysis
5315 Avenida Encinas, Suite M
Carlsbad, CA 92008
Fax: 619/431-5214
800/726-7789

STEEL BRIDGE DESIGN on your PC

MDX's steel bridge girder design program is licensed by many of the largest ENR Top 500 Design Firms, as well as smaller firms and state DOTs. Now this program interacts with a **grid analysis module** that loads user-defined lanes with standard or custom trucks.

Integrated Grid Analysis & Bridge Girder Design

- Non-prismatic I girders and box girders, rolled shapes
- Up to 12 continuous spans, horizontal curvature, skewed supports
- Generates geometry for girders and bracing
- Generates influence surfaces, loads lanes for live load forces
- User may specify ranges for (or fix) any of the design variables
- Designs girders with a powerful optimization method (one that works!)
- Generated designs satisfy the 1992 AASHTO Specification
- Allowable Stress and Load Factor versions
- Excellent for analyzing existing structures for specification compliance
- Full control of composite action
- Either free form or menu driven input, comprehensive output
- Graphical output of stresses and deflections on screen or printer

And many more!

For more information, or to request a free trial, contact:

MDX software

Phone (314) 446-3221
Fax (314) 446-3278

level loading dock. The first floor of the new building will house outpatient services; the first floor of the existing facility which also houses similar services will be renovated. The second floor will consist of critical care/intensive care units and other surgery-related functions. The future third floor will contain patient rooms or medical/surgical units. The future fourth floor will accommodate patient rooms or the expansion of high-technology catheterization laboratories.

The present and future critical functions place this building in the highest seismic importance category because of its need to be functional during and after an earthquake disaster. Hence, the new addition will be constructed with a seismic expansion joint between the two buildings which will permit horizontal, vertical and rotational building movement.

The new addition will be constructed of structural steel framing and lightweight concrete slabs. By using these materials to decrease the weight of the building, the foundations and the lateral seismic forces will also be reduced. Because of the loading dock at the ground floor level, a lateral bracing system consisting of cross bracing will be used. Semi-rigid beam-to-column connections of top and bottom plates will be utilized to develop the lateral forces and ductility needed to resist the seismic loads of current building codes.

Hopefully, when the future addition is designed, the in-place building codes will not have changed significantly. That way, the facility will be able to be built without incurring considerable re-design and costs.

Richard A. Esslinger, P.E., is director of structural engineering at the Philadelphia-based architectural, engineering, interior design and planning firm of Ewing Cole Cherry. Ewing Cole Cherry services commercial, industrial and institutional clients nationwide.

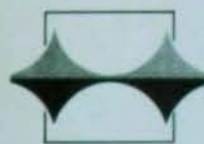

Rules

Eligibility

To be eligible, a bridge must be built of fabricated structural steel, must be located within the United States (defined as the 50 states, the District of Columbia, and all U.S. territories), and must have been completed and opened to traffic between *May 1, 1988* and *April 30, 1993*.

Judging Criteria

Judging will be based upon aesthetics, economics, design and engineering solutions. Quality of presentations, though not a criterion, is important.

Award Categories

Entries may be judged in one or more categories, but can receive only one award.

Long Span One or more spans more than 400 ft. in length.

Medium Span, High Clearance Vertical clearance of 35 ft. or more with longest span between 125 and 400 ft.

Medium Span, Low Clearance Vertical clearance less than 35 ft. with longest span between 125 and 400 ft.

Short Span No single span greater than 125 ft. in length.

Grade Separation Basic purpose is grade separation.

Elevated Highway or Viaduct Five or more spans, crossing one or more traffic lanes.

Movable Span Having a movable span.

Railroad Principal purpose of carrying a railroad, may be combination, but non-movable.

Special Purpose Bridge not identifiable in one of the above categories, including pedestrian, pipeline and airplane.

Reconstructed Having undergone major rebuilding.

Entry Requirements

All entries must contain an entry form, photographs and a written description of the project. A separate binder must be submitted for each entry. No entry fee is required; submission materials will not be returned. The use of any entry's submitted data, detail and/or photographs by AISC shall be unrestricted. **Note:** Projects not receiving an award still may be used in *Modern Steel Construction* magazine or other AISC marketing materials.

1. **Entry form:** The complete and accurate entry form and one copy must be enclosed.

2. **Photographs:** A minimum of four professional quality 8x10 color prints of various views showing the entire bridge, including abutments as well as selected details, are required. 35 mm slides are strongly recommended. Photographs will not be returned.

3. **Description:** Explanation of design concept, problems and solutions, aesthetic studies, project economics and any unique or innovative aspect of the project. Include no larger than 11x17 drawings showing elevation, framing system and typical details.

Method of Presentation

Each entry should be submitted in an 8½" x 11" binder, containing transparent window sleeves for displaying inserts back to back. The entry form included in the brochure must be easily removable, so that the identification of the entry can be concealed during judging.

Awards

The winners will be notified shortly after the mid-August judging. Public announcements of the winners will be made in the November issue of *Modern Steel Construction* magazine. Award presentations will be made to the winning designers at the National Symposium on Steel Bridge Construction, November 11, 1993, in Atlanta, GA.

Deadline for Submission

Entries must be postmarked on or before **June 18, 1993**, and addressed to: American Institute of Steel Construction, Inc., Attn: Awards Committee, One East Wacker Drive, Suite 3100, Chicago, IL 60601-2001. For further information, call 312/670-5432.

AISC 1993 Prize Bridge Competition



Entry Form

Entry Date _____

Name of Bridge _____ Completion Date _____

Location _____ Date opened to traffic _____

Category in which entered _____ Approx. total cost _____

Span lengths _____ Roadway widths _____ Steel wt./sq. ft. of deck _____

Vertical clearance _____ Steel tonnage _____ Painted: Yes _____ No _____

Structural system(s) (describe briefly here) _____

Innovative Concepts _____

Descriptive data: Attach separate sheets (see entry requirements)

No. of photographs enclosed: Color prints _____ 35 mm slides _____

Design Firm: _____

Phone _____

Address: _____
Street _____ City and State _____ Zip _____

Person to contact: _____
Title _____

Consulting Firm (if any): _____

Phone _____

Address: _____
Street _____ City and State _____ Zip _____

Person to contact: _____
Title _____

General Contracting Firm: _____

Phone _____

Address: _____
Street _____ City and State _____ Zip _____

Person to contact: _____
Title _____

Steel Fabricating Firm: _____

Phone _____

Address: _____
Street _____ City and State _____ Zip _____

Person to contact: _____
Title _____

Steel Erecting Firm: _____

Phone _____

Address: _____
Street _____ City and State _____ Zip _____

Person to contact: _____
Title _____

Owner: _____

Phone _____

Address: _____
Street _____ City and State _____ Zip _____

Person to contact: _____
Title _____

This entry submitted by:

Name: _____
Title _____

Firm: _____
Phone _____

Address: _____
Street _____ City and State _____ Zip _____

Deck Fastening Anytime, Anywhere.

Incorporating new innovative technology, Hilti's DX750 Powder Actuated Fastening System is designed to fasten metal deck to structural steel and bar joist on just about any type of project...large or small, complex or routine.

Engineers for North Dakota's FARGODOME were faced with design and installation challenges due to severe weather conditions when specifying its deck fastening system. Planned as a multi-purpose entertainment and convention facility, the \$50 million, 470,000 square foot building stands 125 feet tall with nearly 220,000 square feet of roofing.

"Because the dome's architectural design involves a long, sloping roof of metal decking, welding would have been extremely difficult," said Project Engineer Jack Petersen of Martin/Martin Consulting Engineers of Wheat Ridge, Colorado. "The versatility of Hilti's DX750 made it an ideal choice for the decking application."

Unlike welding, the DX750 system worked well despite cold and wet weather. Using a self-contained

power source and a magazine clip of ten fasteners, the DX750 produced fastenings superior to those of a 5/8 inch puddle weld. It eliminated the problem of burn through and was used on coated deck with no retouching needed -- thus reducing labor costs.

Jim Minkinen, Project Manager for the steel erection and roof deck subcontractor Danny's Construction Company Inc. of Shakopee, Minnesota said, "Given Hilti's

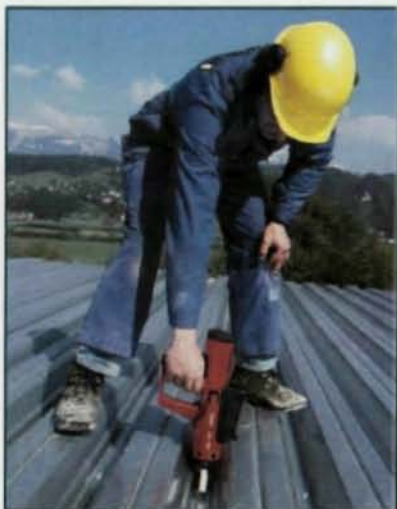

reputation in the industry, I knew we would receive the technical assistance necessary to complete the job. I believe using the DX750 has improved the productivity of our decking crew by at least 50 percent on this project. I'd like to see more structural engineers specify powder-actuated fastenings. It's definitely the best option when installing decking."

If the DX750 can tackle the unique challenges of the FARGODOME, just think what it could do on your next project. It will fasten virtually any deck, anytime, anywhere.

For your copy of the DX750 Specification Kit, including approval, design and technical data, plus success stories from other construction professionals, ask for Hilti's "Deck Tech" at 1-800-879-8000.

HILTI®

P.O. Box 21148
Tulsa, Oklahoma 74121-1148



FARGODOME Engineers Specify the DX750



Masonry-To-Steel Connections

The MTD System 1 is a third-party software system that eliminates the need to assemble masonry and structural steel component details from scratch. Sixty complete state-of-the-art details are provided in plan, section, and isometric form. All details have been carefully researched and formulated to meet current standards and code requirements. Engineers and fabricators can use the details as shown or make modifications to meet specific project requirements. This system is ideal for architects and engineers involved in designing low-rise steel structures clad with masonry. The MTD System operates on DOS version of AutoCAD Release 11 and 12. All details are derived from the technical publication "Masonry and Steel Detailing Handbook." Cost is \$225.

For more information or to receive a free demonstration disk, contact: Masonry Technologies Inc., 2000 Aldrich Place, Downers Grove, IL 60516 (708) 852-9122.

High Shear Nail

Hilti has recently introduced the High Shear Nail (HSN) for the attachment of metal roof and floor deck to bar joist and light structural steel beams. Designed to be equivalent in allowable shear capacity to a $\frac{5}{8}$ " puddle weld, the nail is compatible with Hilti's DX 36M Powder Actuated Fastening System, which is designed to improve fastening consistency and minimize damage to coatings on the deck and supporting steel. The HSN features a unique washer and bell-shaped top hat assembly that combine to provide high diaphragm shear capacity. HSN fastening quality is verifiable through a simple visual method and is faster than screw fastening as there are no holes to drill.

For more information, contact:

Kenneth Walsh, Manager of Marketing Communications, Hilti Inc., 5400 South 122nd East Avenue, Tulsa, OK 74146 (800) 727-3427 ext. 6726.

Lock Pin & Collar

Huck International has introduced a high-strength alternative to ordinary nuts and bolts: The Huck Lock Pin and Collar fastening system. It exceeds ASTM A325 and A490 requirements and meets AASHTO, ICBO, AISC, and ASME requirements. The system is U.S. made, and the fasteners are completely traceable and factory mill certified. Unlike standard high-strength bolts, Lock Pin and Collars require no torque for installation. Instead, a Huck tool applies direct, linear tension to a grooved lock pin, while simultaneously pushing on the collar portion. The tool forces the collar to mold itself into the grooves on the pin, a process known as swaging. The swaging action precisely elongates the collar and pin, and the result is an installed bolt with extremely high, consistent clamp-up. Also, the fasteners can be visually inspected. The system is available in nominal diameters ranging from $\frac{3}{16}$ " to $1\frac{3}{8}$ ". Metric sizes and A307 blind bolts also are available.

For more information, contact: Mark Brenner, Huck Fastening Systems, 6 Thomas, Irvine, CA 92718 (714) 855-9000.

Direct Tension Indicators

Direct tension indicators (DTI) produced by J&M Turner are now identified with a new trademark symbol as well as a lot identification number for complete product traceability. In addition, a full range of metric DTIs are now available that meet the provisions of ASTM A325M and A490M. The company has recently produced two half-hour educational video-

tapes, one describing commonly encountered problems and when installing bolts to the tensions required in the *Specification for Structural Joints Using ASTM A325 or A490 Bolts* ("The Reliable Witness") and the other exploring the relationship between torque and tension in situations normally encountered on construction problems ("Questioning Torque").

For more information or a free copy of a videotape, contact: J&M Turner, 1310 Industrial Blvd., Southampton, PA 18966 (800) 525-7193; fax (215) 953-1125.



Type I And Type III Bolts

St. Louis Screw & Bolt operates the only facility in North America offering a full range of Heavy Head High Strength Bolts, including A325 Structural Bolts from $\frac{1}{2}$ " through $1\frac{1}{2}$ " diameter in all lengths. Everything is produced from steel melted and made in the U.S. to fulfill both Type I and Type III (weathering steel) requirements and feature an "SL" trademark on its heads. All bolts produced are traceable to mill heat lots of steel and are tested in our in-house laboratory. In addition to structural bolts, the company also produces A307A and A307B fasteners, and can offer all products as plain, hot dip galvanized, or mechanical galvanized. The company makes an extensive line of off-standard parts, such as countersunk bolts, slotted countersunk and square heads. Also offered are large anchor bolts, hot forged specials including U-bolts, forged & drilled eye bolts, and head made to customer's blue

Revised &
Updated

Write for
your copy now!

Instruction Manual
for installing
HIGH-STRENGTH
BOLTS
with
DIRECT TENSION INDICATORS
(ASTM F959)
ENGLISH UNITS EDITION



J & M Turner Inc.



J & M Turner Inc.

International Headquarters
1310 Industrial Boulevard
Southampton, PA 18966

Phone: 215-953-1118
800-525-7193

Fax: 215-953-1125
Telex: 288965

ONE CALL GETS YOU ALL YOUR FASTENERS FOR STEEL FABRICATION & CONSTRUCTION

ANCHOR BOLTS, PLATE & SLEEVE
ASSEMBLIES, TIE RODS, STUDS, SWEDGE
BOLTS, U-BOLTS, HEX BOLTS & EYE BOLTS

Custom fabricated to exact specifications from certified domestic
steel up to 4-inch diameter and 40-foot lengths in steel & alloy.

STRUCTURAL BOLTS, NUTS & WASHERS in A325, A490 & TENSION
CONTROL BOLTS, WELD STUDS, CONCRETE ANCHORS, B-7 STUDS,
CLEVISES, TURNBUCKLES and all types of fasteners in various grades
and materials; plain, plated and galvanized.

Stocked for immediate shipment

★ SAME DAY SHIPPING ★
OVERNIGHT TO MOST U.S. CITIES

MID-SOUTH BOLT & SCREW

Central States
499 Cave Road
Nashville, TN 37210
615-889-8341
FAX: 615-885-6542
1-800-251-3520

East Coast
59 Liberty Road
Emporia, VA 23847
804-634-0240
FAX: 804-634-0541
1-800-366-BOLT

FASTENER PRODUCTS

prints.

For more information, contact:
St. Louis Screw & Bolt, 6900 N.
Broadway, St. Louis, MO 63147
(800) 237-7059; fax (314) 389-7510.

Connections Manual

AISC has issued *Volume II Connections Manual of Steel Construction ASD/LRFD*. This 702 page volume covers bolted and welded shear, moment and bracing connections in applications not specifically treated by the general information in the *Manual of Steel Construction*, ASD or LRFD. It also provides examples that follow both ASD (9th Edition) and LRFD (1st Edition) solutions for all applicable topics. Cost is \$60 plus shipping and handling.

For more information, contact:
Publications, American Institute of
Steel Construction, Inc., One East
Wacker Dr., Suite 3100, Chicago, IL
60601-2001 (312) 670-2400 ext. 433;
Fax (312) 670-5403.

Grating Installation

Historically, the installation of grating was always a last minute event. Often, a temporary planking was installed during construction, and then removed prior to the installation of the permanent deck or grating. This scenario has been changing dramatically of late. The major design/build firms have begun moving towards modular construction wherever possible. In this case, a whole floor is assembled on the ground, including the flooring or grating. Then the whole unit is picked up and put in place. Grate-Fast has proven ideal for this application because it installs from one side and is removable without a trace. In addition, there is no welding, hole drilling, penetration of coatings, or studs sticking up. Because Grate-Fast is removable, even though the modules are constructed on the ground, access un-

derneath after installation is still maintained. And since it does not require holes for fastening, it is easy to re-install.

For more information, contact: Struct-Fast, Inc., 20 Walnut St., Suite 101, Wellesley Hills, MA 02181 (617) 235-6734; Fax (617) 431-7940.

Steel-To-Concrete Connections

HALFEN Anchoring Systems offers an extensive line of adjustable anchors suitable for the anchoring of structural steel to concrete. The system provides the installer with the necessary adjustment to make quick and accurate connections and to substantially reduce labor costs. No welding or drilling is required, eliminating the need for special tools or power on the job site. Offered are 10 profiles of cast in channel, providing safe working loads of 650 lbs. to 15,700 lbs. per 12" section.

For more information, contact: HALFEN Inc., P.O. Box 410203, Charlotte, NC 28241 (800) 323-6896; Fax (704) 588-2144.

Roll Threading

Fabsco Corp. has expanded its roll threading capacity to 3" diameter so there's no need to upset large diameter rods to achieve full size thread engagement. Time and money can be saved by roll threading sag rods and tie rods. Also stocked are 5/8", 3/4", and 1" diameter roll thread anchor bolts as well as a large range of plastic anchor bolts sleeves up to 3" diameter. The company also carries hot dip galvanized bridge bearing studs up to 1 1/4" diameter. All steel inventory is mill certifiable and made in the U.S. Certification is provided upon request. Also, Fabsco features cold forming capacity up to 3/8" diameter in lengths up to 3".

For more information, contact:

ARE BOLTS CAUSING YOU UNDUE

TENSION



LEJEUNE SMART BOLTS KNOW "PROPER TENSION!"

A-325 or A-490 high strength bolts.
Factory mill certification-traceable to each keg.
Black or mechanically galvanized.
Full domestic or open stock.

**"THE LOWEST COST SYSTEM FOR PROPERLY
INSTALLED HIGH STRENGTH BOLTS!"**

LEJEUNE BOLT COMPANY
8330 West 220th Street
Lakeville, Minnesota 55044
For Information or Technical Assistance
Call 1-800-USA-BOLT (872-2658)
FAX 1-612-469-5893



Fabsco Corp., 1745 West 124th St., Calumet Park, IL 60643 (708) 371-7500; Fax (708) 371-7524.

Extended End-Plate Moment Connections

The fourth in AISC's fascinating Design Guide series, "Extended End-Plate Moment Connections" covers the design, fabrication and erection of this type of connection. Extended end-plate moment connections are increasingly being used in steel construction and this 43 page guide gives recommendations and background for four-bolt as well as eight-bolt end-plate connections. The Guide costs \$16 plus shipping and handling.

For more information, contact: Publications, American Institute of Steel Construction, Inc., One East Wacker Dr., Suite 3100, Chicago, IL 60601-2001 (312) 670-2400 ext. 433; Fax (312) 670-5403.

Anchor Bolts & Tie Rods

Haydon Bolts manufactures anchor bolts and tie rods up to 4" in diameter. The products are offered in ASTM A36, A449, A325, and A588. A complete line of standard and special sizes of ASTM A325 and A490 are available in hexagon heads as well as button head shear bolts.

For more information, contact: Haydon Bolts, Inc., Adams Avenue & Unity Street, Philadelphia, PA 19124-3196 (215) 537-8700; Fax (215) 537-5569.

Twist-Off Bolt

Nucor Fastener has developed a twist-off bolt with a major difference from competitive products: a hex head. This head makes

the bolt easy to install, easy to remove, and easy to check its installation with a torque wrench. Using a quiet, hand-held tool, the Tru-Tension system provides the correct tension every time. It also eliminates operator error during assembly, and lowers installation costs. All Nucor Tru-Tension bolts and nuts are fully traceable to Nucor's domestic steel sources. They are fully tested and certified, including full compliance with FHWA, DOT and AASHTO specifications for bridge construction.

For more information, contact: Nucor Fastener, P.O. Box 6100, St. Joe, IN 46785 (800) 955-6826; (219) 337-5394.

Metal-To-Wood Fasteners

The Atlas family of fasteners for wood applications offers builders four proven methods to achieve metal-to-wood construction. These fasteners are available in five lengths and feature high, sharp cornered head for fast, positive driving. WoodFast features a plated steel #9-16 washer head and provides a cost-effective method to upgrade from conventional nailing. WoodTite features a #10 shank with shard, type 17 milled point and dual thread for quicker penetration and holding power.

For more information, contact: Atlas, 1628 Troy Road, Ashland, OH 44085 (800) 321-6846.

Cold Forged Bolts

Infasco offers a wide range of cold forged bolt products including: diameters of 1/4" and 5/16" up to 8" in length; diameters of 3/8" through 3/4" up to 15" in length; and diameters 7/8" through 1 1/4" up to 10" in length. Also available is a wide range of metric sizes. The company also manufactures a variety of nuts—cold formed in diameters of 1/4" through 9/16" and hot forged in diameters of 5/8" through

1 1/4". Electroplating and zinc phosphating are available.

For more information, contact: Infasco, division of Ivaco Inc., 700 Ouellette, Marieville, Quebec, J3M 1P6, CANADA (514) 658-8741; Fax (514) 447-0114.

Tension Control

Rapid Tension Bolts from NSS Industries are a type of structural bolt-nut-washer assembly where the proper tension is indicated when the spline has been separated from the bolt. Installation is achieved by first assembling the bolt, washer & nut into the connection hole and tightening by hand until snug. Next, the 12-point socket of the installation tool is engaged. Rapid tension is achieved by simply pressing the trigger of the installation tool; while the outer socket rotates clockwise, the inner socket rotates counterclockwise, ensuring a snug fit.

Contact: NSS Industries, 9075 General Dr., Plymouth, MI 48170 (800) 221-5126.

Connection Software

CONXPRT is a knowledge-based PC software system for the design of connections in steel-framed buildings. All strength limit state are checked and expert advice from long-time fabricator engineers is used to augment the design rules. The program incorporates provisions to set dimensional and material defaults for a particular project or general shop needs. Additionally, CONXPRT is menu-driven and incorporates help screens designed for easy use. The program will generate cope sizes, allows bolt stagger, and permits different bolt diameters for shop and field use. Tightening clearances are automatically checked. If a design cannot be accomplished, CONXPRT provides an explanation, including necessary references. Additionally, expert advice on how to improve the connections

is provided. Module I: Shear Connections (ASD or LRFD) costs \$300 each or \$550 for both versions. Module II: Moment Connections (ASD only) costs \$400.

Contact: AISC Software Sales (312) 670-2400.

Tension Control Indicator

The TS Fastening System is a high-strength tension control indicating system and is designed for the installation of high-strength A325 and A490 bolts. The bolt design incorporates a button head configuration for an increased load bearing area under the head of the bolt. The threaded end of the bolt incorporates a spline drive with a break-neck groove adjacent to the spline. In service, the tension set bolt is installed through the structure, a mating washer and nut are

engaged on the threaded end of the bolt and finger tightened. An installation tool engages the splined end of the fastener and the nut. The planetary gear drive of the tool turns the nut and preloads the fastener assembly. When the assembly has been fully installed, the spine drive end shears at the break-neck groove, resulting in a properly installed and torqued fastener assembly.

Contact: Bristol Machine Company, 19844 Quiroz Court, Walnut, CA 91789 (800) 798-9321.

Rapid Delivery

Specializing in meeting the needs of structural steel fabricators, Mid-South Bolt & Screw Co. provides a wide range of products including anchor bolts, tie rods, studs, crane rail bolts, U-bolts, J-bolts, swedge bolts, eye bolts, structural hex bolts, tension control bolts, load indicator washers, con-

crete anchors, weld studs, threaded studs, plastic sleeves, clevises, turnbuckles and all types of nuts, screws, bolts and washers. Three locations offer next- or second-day delivery to two-thirds of the U.S.

Contact: Mid South Bolt & Screw Co., Inc., 499 Cave Road, Nashville, TN 37210 (800) 251-3520.

Torque Control

Nova-Hex Torque Controlling Nuts from the Fairchild Fastener Group allow users to apply precise torque control to nut and bolt assemblies using the Nov-Hex ball socket and ordinary driving tools. Torque is controlled by the ball socket, not the driving tool. A visible, permanent installation signature clearly and quickly identifies to inspectors that assemblies have the proper torque. Paint, dirt or grime will not obscure the identification. From the outside, the assemblies appear as ordinary hex

WHEN YOU BUY ST. LOUIS, YOU BUY AMERICAN!

AND YOU GET: • FULL TRACEABILITY
• LOT CONTROL
• CERTIFICATIONS

Registered Head Markings on all structural and machine bolts:

Products from 1/2" — 3" diameter include:



A-325
Type 1



A-325
Type 3



A-307-A



A-449



A-307-B



COUNTERSUNK



SQUARE
MACHINE



BUTTON
HEAD

ST. LOUIS SCREW & BOLT COMPANY

6900 N. Broadway • St. Louis, MO 63147

(314) 389-7500 • 1-800-237-7059 • Fax (314) 389-7510

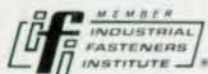

sockets. But inside, there is a circular internal wall in which six carbide balls are arranged in a uniform, hexagonal pattern. Continued application of torque causes the socket balls to first brinell, then penetrate deeper into the lobes of the nut. Finally, the socket balls break through the resistance of the lobes to achieve a uniform, high level of torque control while leaving distinctive signature grooves.

Contact: Fairchild Fastener Group, One Civic Plaza, Suite 500, Carson, CA 90745 (310) 522-0700.

Proper Tension Installation

The LeJeune Tension Control Bolting System provides a calibrated bolt, nut and washer assembly that installs at the proper tension for that particular size and grade of bolt. A non-impacting electric wrench drives the nut against the bolt tip. This contains the counter forces within the wrench and tightens each bolt to the required tension and then automatically causes the tip to shear-off, indicating proper installation. A-325 Type I and III, as well as A-490, Grades are available in 3/4", 7/8", and 1 1/8" diameters.

Contact: LeJeune Bolt Co., 8330 West 220th St., Lakeville, MN 55044 (800) 872-2658.

Domestic Bolts

Lohr Structural Fasteners offers a wide range of domestic bolts. The product line is mill certified, fully assembled and tested, and of the highest quality available.

Contact: Lohr Structural Fasteners, Inc., P.O. Box 1387, Humble, TX 77347 (800) 782-4544.

Construction Fasteners

A wide range of products are available from TC Bolt Supply, including: swaged

anchors; high-strength A325 and A490 bolts; studs; crane rail anchors; hook anchors; sleeve anchors; hook anchors; tie rods; square and round bend U's; double expansion shields; bent tie-rods; eye bolts; drift pins; washers; turn-buckle and clevis assemblies; wedge type anchors; and arc weldments. A variety of coating and heat treatments are available.

Contact: TC Bolt Supply Co., Inc., P.O. Box 197, Forest Road, Greenfield, NH 02047 (603) 547-6371.

Fastener Coating

Dorrlmate, an inherently black, zinc-rich coating is now available from Magni Industries. A dry-to-the-touch finish, the coating is ideal for all construction fasteners requiring corrosion resistance, consistent torque tension, and bi-metallic protection. The coating is applied over a zinc phosphate and sealed with an epoxy topcoat and is cost-effective compared with traditional electroplating.

Contact: Magni Industries, Inc., 255 South Woodward, Suite 300, Birmingham, MI 48009 (313) 647-4500.

Steel Deck Fastener

The Autotraxx ICH Deck Fastening System from ITW Buildex is used to attach steel deck in a stitch or structural steel application. The system has two components: a stand-up tool that includes a screwgun, special fastener guidance system, depth sensitive nose-piece and unique drive socket; and Traxx fasteners with an ICH (Internal Cone Head) design. The fasteners have either a Traxx/1 point for stitch applications or a Traxx/5 point for structural attachments.

For more information, contact: ITW Buildex, 1349 West Bryn Mawr Ave., Itasca, IL 60143 (708) 595-3549.

Shear Connections

Two 120-page books from AISC contain design aids for shear connections. Presented in easy-to-use tabular form, the books include designs for double-angle web bolted connections, structural tee single shear connections and single-angle connections welded to the support. The books are available in both ASD and LRFD formats.

For more information, contact: Publications Dept., AISC, One East Wacker Dr., Suite 3100, Chicago, IL 60601 (312) 670-2400 ext. 433.

Threaded Fasteners

Portland Bolt is a domestic manufacturer of headed and threaded fastening hardware up to 5 1/2" diameter and 40' in length. The material is produced and certified to the latest ASTM and AISC specifications. The company specializes in carbon, alloy, non-ferrous fasteners and hot-dipped galvanized coatings. An expansion has increased production and reduced lead times and costs.

For more information contact: Portland Bolt & Manufacturing Co., Inc., P.O. Box 2866, Portland, OR 97208 (800) 547-6758.

Bolts

Lewis Bolt & Nut Co. has been manufacturing bolts in 1927 and specializes in A-449 and A-325 fasteners in diameters of 1/2" or greater and lengths of 6" and longer. Products are made to order and rush orders are welcome. Certification and lot tracking are offered on all orders and all bolts are manufactured in the U.S. with domestic materials.

For more information, contact: Lewis Bolt & Nut Co., 604 Twelve Oaks Center, Suite 235, 15500 Wayzata, Wayzata, MN 55391 (800) 328-3480.

AISC ANNOUNCES VOLUME II CONNECTIONS MANUAL

ASD / LRFD

A 'MUST-HAVE' FOR ALL STRUCTURAL ENGINEERS, DETAILERS AND FABRICATORS...
 ANYONE RESPONSIBLE FOR DESIGNING AND APPROVING STRUCTURAL STEEL CONNECTIONS.

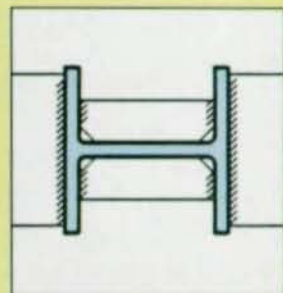
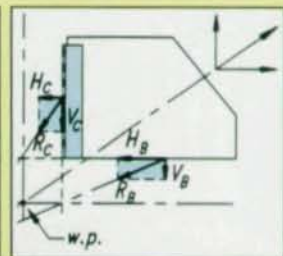
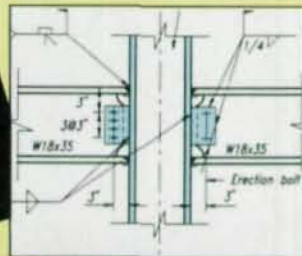

▲ *Volume II Connections* is a companion and extension to the AISC *Manual of Steel Construction* (both LRFD, 1st Edition, and ASD, 9th Edition).

▲ Contains examples and information on steel connections not published anywhere else.

▲ Has practical and economical examples of complex connection designs in both LRFD and ASD.

▲ Based on the latest AISC LRFD and ASD specifications.

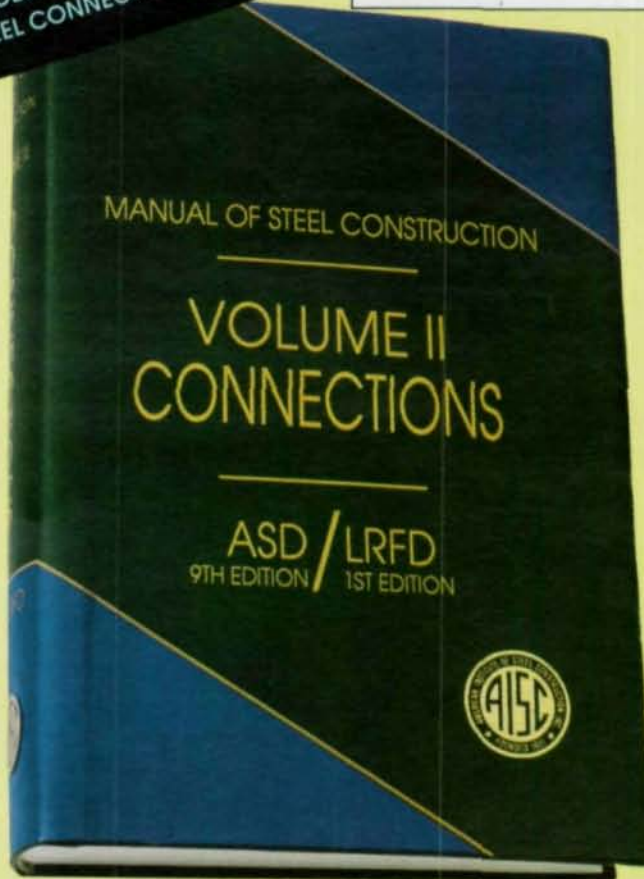

▲ Covers bolted and welded shear, moment, and bracing connections in applications not treated in either the ASD or LRFD *Manual of Steel Construction*.

▲ **FREE BONUS!**
 An updated copy of the AISC *Code of Standard Practice* will be sent with each book.

704 PAGES — ONLY \$60.00 — ORDER YOUR COPY TODAY!

YES! I must have **Volume II Connections**.

Send me _____ copies at only \$60 each.

Name/Title _____

Company _____

Address _____

City/State/Zip _____

Phone _____

Check enclosed Charge my Visa MasterCard

25% DISCOUNT FOR AISC MEMBERS Acct# _____ Expires _____
 Signature _____

Return to:
 AISC Connections Offer
 PO Box 806276
 Chicago, IL 60680-4124

Phone Orders
312/670-2400 X433
 FAX Orders
312/670-5403

Please enclose remittance. No COD orders. Add \$5 for UPS charge. Foreign orders: \$10 minimum for shipping.

STEEL MARKETPLACE

Help Wanted

General Manager

We fabricate short and long span joists, as well as girders and metal decking. Experience with steel fabrication mandatory. Total P/L responsibility.

These positions are for Valley Joist, A Division of EBSCO Industries, and are located in Ft. Payne, AL. Send resume to: Leon Sizemore, c/o EBSCO Industries, P.O. Box 1943, Birmingham, AL 35201-1943.

Structural Engineer

Registration and experience in structural steel engineering required. Must be able to manage engineering standards in accordance with Steel Joist Institute.

Structural Steel Detailing

Experienced, AutoCAD (R12) based structural steel detailing office. Familiar with all aspects of steel construction. 15 years detailing with metric units of measurement. Past projects up to 6,000 tons. References/referrals available upon request. (Competitive prices & timely delivery.)

Ram Drafting (St. Catharines) Ltd.
172½ Niagara St.
St. Catharines, ON L2R 4L4
Tel: 1-416-685-1835
Fax/modem: 1-416-685-6131

USA address:
Main Post Office Box 2629
Niagara Fall, NY 14302
USA

STUDY GUIDE 92. 10th EDITION

For Special Inspector ICBO exam. Structural Steel/Welding. Commentary and outline of sections to study in the UBC, UBC STDS, AISC & AWS Codes. Report writing, L.A. City Code, elements of plan reading. 140 pages. Send \$49 check or money order to:

A. Sherrill
P.O. Box 371
Placentia, CA 92670

2D Software

RISA-2D provides a fast, truly interactive environment for the solution of a wide range of structural design problems. Use RISA-2D for frames, trusses, shear walls, continuous beams and much more. Statics and dynamics are included, with full steel design.

For a free demo, contact:

RISA Technologies, 26212 Dimension Dr., Suite 200,
Lake Forest, CA 92630 (800) 332-7472

CUSTOM DECK SOLUTIONS

We can provide custom designed deck for unusual applications. Long-spans, heavy loads, or special finishes are not new to us. Call us to provide an engineered design for your unique needs.

Nicholas J. Bouras, Inc.
475 Springfield Ave.
Summit, NJ 07902-0662
ph: 908-277-1617 fax: 908-277-6789

Ram Analysis Steel Design Software

Now, get SBEAM by Ram Analysis for only \$100. Full featured composite/non-composite single beam design and analysis software (LRFD or ASD). Easy-to-use with Windows graphical interface. Full 90 day money back guarantee.

Also available, the RAMSTEEL Integrated Structural Software System. Fully integrated analysis, design and drafting of steel beams, joists, columns, and baseplates.

Ram Analysis
5315 Avenida Encinas, Suite M, Carlsbad, CA 92008
Phone: 800/726-7789
Fax orders: 619/431-5214

CLASSIFIED ADS

Reach 35,000 engineers, fabricators, architects, contractors, bridge officials and building owners inexpensively with a classified advertisement in Modern Steel Construction. It's fast and easy—we'll even do the typesetting for you at no charge.

For rate and placement information, call:
Greg Poland at (708) 679-1100.
Or fax him a note at (708) 679-5926.

Advertiser's Index

AISC Prize Bridge Competition.....	40-41
AISC Software	CIII
AISC Volume II-Connections.....	49
Bethlehem Steel Corp.	20-21
Bridgestone	24
Nicholas J. Bouras, Inc.....	CII
CDS	19
CNA Insurance.....	39
Chaparral Steel	8
Computers & Structures, Inc.....	CIV
Computer Detailing Corporation.....	36
Design Data.....	7
EJE Industries	37
Hilit	42
J&M Turner	44
Lejeune Bolt	45
MDX	38
Metrosoft	11
Mid-South Bolt	44
NSCC Call For Papers.....	25
Omnitech.....	36
Optimate.....	37
RMR	31
RAM Analysis	38
Research Engineers.....	5
RISA Technologies.....	31
SCADA Software	16
St. Louis Screw & Bolt	47
Steel Deck Institute	32
Steel Solutions.....	32
Structural Software.....	17
TradeARBED	3
Voss	33
Vulcraft.....	26-27
Whitefab	13

STRUCTURAL STEEL DESIGN

SOFTWARE

FROM AISC

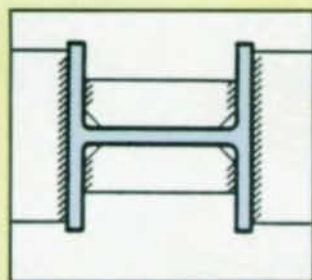

CONXPRT

A knowledge-based, menu-driven PC software system for the design of connections in steel framed buildings. All strength limit states are checked and expert advice from long-time fabricator engineers is used to augment the design rules.

- Generates cope sizes, allows bolt stagger and permits different bolt diameters for shop and field use
- Designs can be stored on disk, allowing electronic communication between design parties.
- Generates complete reports showing details and strength for each limit state checked.

3-1/2" or 5-1/4" disk

MODULE I:

SHEAR CONNECTIONS

1st edition LRFD

Version 1.02 \$300

9th edition ASD

Version 2.0 \$400

MODULE II:

MOMENT CONNECTIONS

ASD format only \$400

STEMFIRE

Determines safe and economical fire protection for steel beams, columns and trusses. Based on rational procedures developed by AISI which extend the published UL fire resistive designs to other possible rolled structural shapes and common protection material requirements.

Two 5-1/4" disks

& users manual \$96

(sorry, no 3-1/2"



WEBOPEN

Designed to enable engineers to quickly and economically design beam web openings. Uses state of the art criteria and features a clear and logical data entry system with easy-to-use color coded input windows. Written by practicing engineers for engineers, incorporating expert design checks and warning messages which enhance the application of the AISC Design Guide—*Steel and Composite Beams with Web Openings*—to specific design problems.

3-1/2" or 5-1/4" disk. Includes AISC Design Guide \$495.00

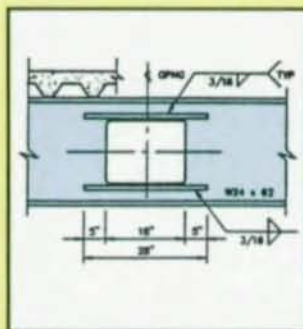

Open Elevation Plan

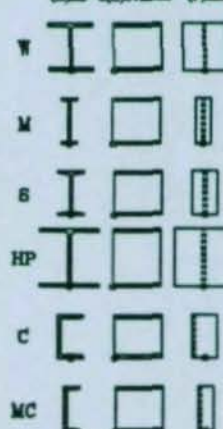

AISC FOR AUTOCAD

Saves time doing detail drawings of structural steel shapes in AutoCAD. Lists properties corresponding to data in the most recent LRFD and ASD manuals. Parametrically draws to scale the end, elevation and plan views of common shapes.

3-1/2" or 5-1/4" disk \$120

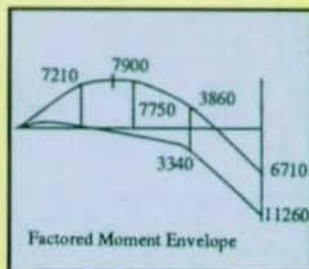

ELRFD

A new sophisticated program for interactively checking structural steel building components for compliance with AISC specification. Checks whether member satisfies all limit states and limitation requirements set by the LRFD Specification and reports which sections are satisfied or violated.

- Review in detail the formulas and rules used in the evaluation and interactively assess any mathematical expression on the screen.
- Fully interactive MS Windows-based user interface.
- Disk includes ELRFD Check/Browser, AISC Structural Shapes Database and sample problems
- User Guide and Reference Manual.

3-1/2" disk only \$495

AISC DATABASE

Contains the properties and dimensions of structural steel shapes, corresponding to data published in the most recent LRFD and ASD Manuals of Steel Construction. Presented in the ASCII format for W, S, M, HP and other common shapes and channels. Available in U.S. customary units or metric units. May be converted to Lotus 1-2-3 PRN format.

3-1/2" or 5-1/4" disk \$60

VISA

ORDER YOUR AISC SOFTWARE PACKAGES TODAY

CALL (312) 670-2400

MASTERCARD

FOR FASTER SERVICE FAX YOUR ORDER (312) 670-5403

OR SEND MAIL ORDERS TO: AISC SOFTWARE, P.O. BOX 806276, CHICAGO, IL 60680-4124.

ALLOW 2-3 WEEKS FOR MAIL ORDERS; 7-10 DAYS ON PHONE, FAX ORDERS.

CREDIT CARDS ONLY ON PHONE, FAX ORDERS

STATE of the ART
Structural Engineering Software

EARTHQUAKE ENGINEERING

Integrated Seismic Analysis & Design of Concrete & Steel Structures
Based Upon 20 Years of Pioneering Research & Development
Developed by Edward L. Wilson & Ashraf Habibullah

Response Spectrum Analysis

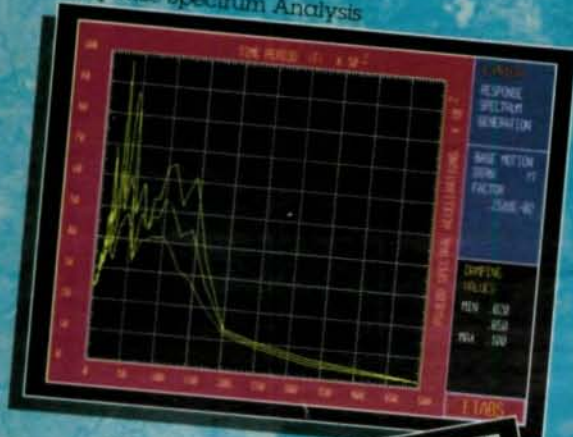

Time History Analysis

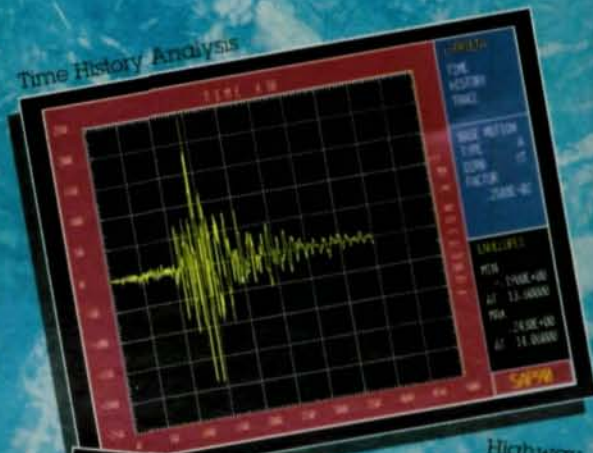

Eccentrically
Braced Frames

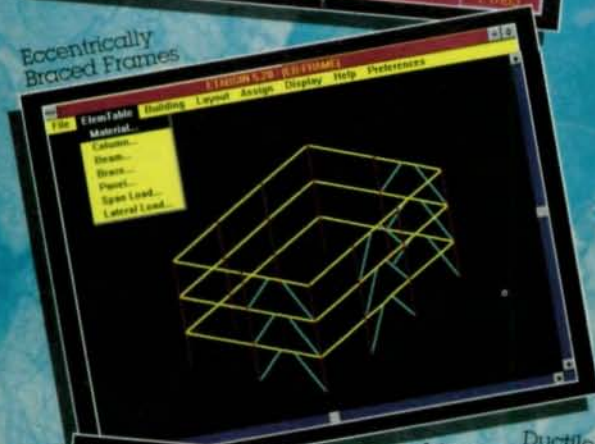

Highway
Engineering



Ductile
Moment Frames

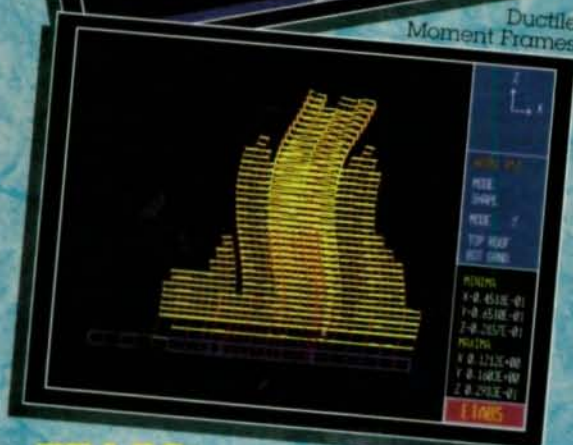

Bridge Dynamics



ETABS
Building Analysis & Design

SAP90
General Analysis & Design

COMPUTERS &
STRUCTURES
INC.

For more information:
Computers & Structures, Inc.
1995 University Avenue
Berkeley, California 94704
TEL: (510) 845-2177
FAX: (510) 845-4096