

# MODERN STEEL CONSTRUCTION

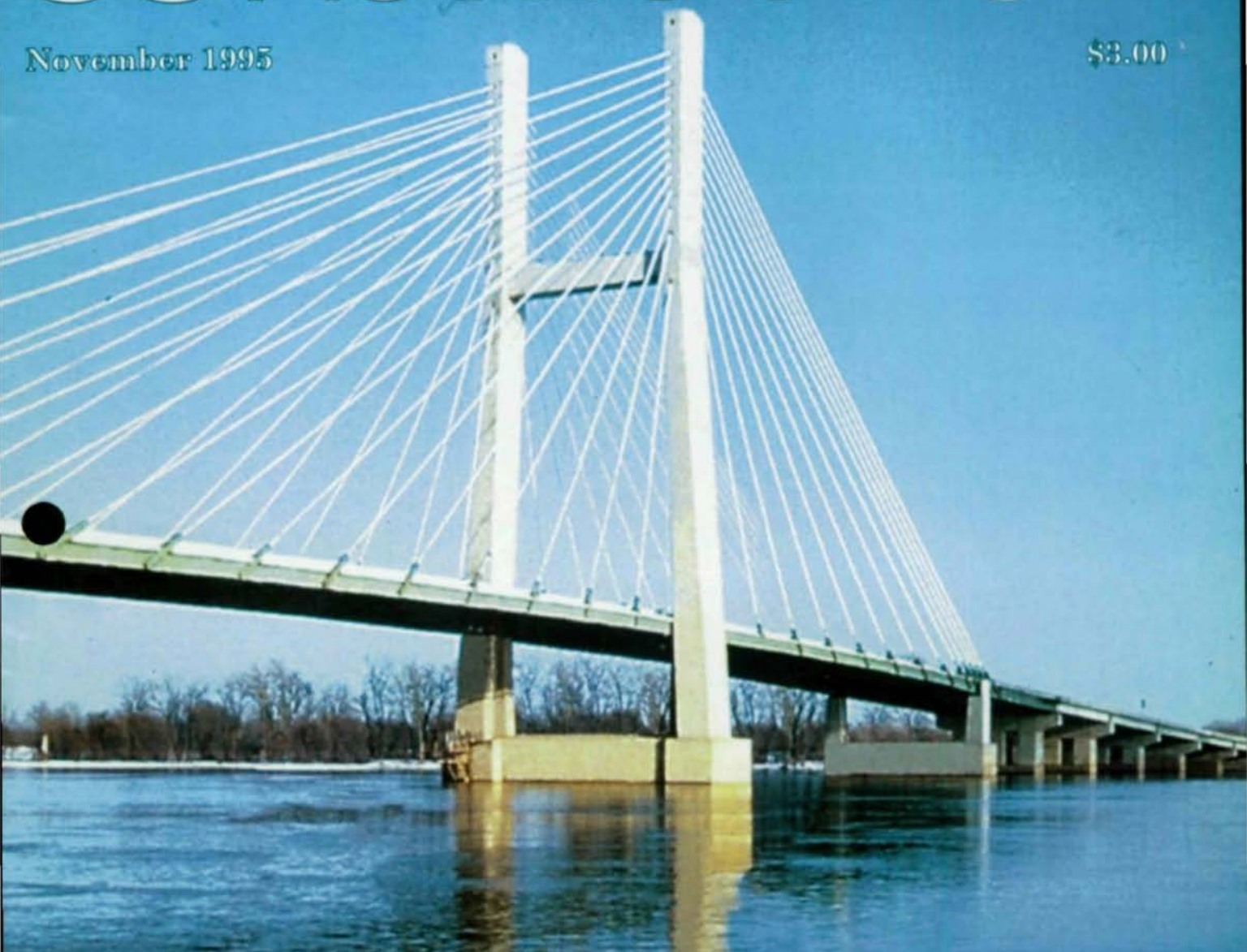

November 1995

\$3.00



## Steel Bridges

063286  
Patrick Newman  
Director  
American Inst. of Const.  
1 East Wacker Dr. #3100  
Chicago, IL 60601-2001





New Columbia Joist Company

# How To Estimate Joist DEFLECTIONS



Approximate camber =  $L^2/2400$  (inches)  
where L = span (feet)

**A**ll joists and joist girders made by **NCJ** are furnished with standard camber. The amount of camber can be approximated by the equation:  $y_c = L^2/2400$ , inches, where L is the span in feet. The word *approximate* is used because the final camber can be influenced by handling during shipping and erection. Non-standard SJI camber is an extra cost.

Joist deflection under uniform load can be estimated by the simple beam formula, modified by 1.15 for trusses,  $y_1 = 1.15 \times 0.013 w L^4(1728)/EI_j$ , where w is in pounds per foot, L is in feet, and E is in psi.  $I_j$  can then be found by working the equation backwards with known values from the **NCJ** joist tables.

The total downward movement is obtained by subtracting the camber from the calculated deflection.

**Example:** A 24K4 joist has a deflection limit (L/360) load of 150 plf on a span of 36'.

$$y_1 = \frac{36 \times 12}{360} = 1.2''$$

$$I_j = \frac{1.15 \times 0.013(150)(36)^4(1728)}{29 \times 10^6 \times 1.2} = 187 \text{ inches}^4$$

Or,  $I_j$  could also be estimated by;

$$I_j = \frac{1.15 \times 0.85 A_T A_B d^2}{(A_T + A_B)}$$

where  $A_T$  is the top chord area, inches<sup>2</sup>;  $A_B$  is the bottom chord area, inches<sup>2</sup>; and d is the distance between the centers of gravity of the top and bottom chords, in inches.

The  $I_j$  could also be obtained (most accurately) by calling **NCJ** (717) 568-6761.



NICHOLAS J. BOURAS, INC.  
475 Springfield Avenue, P.O. Box 662  
Summit, NJ 07902-0662  
(908) 277-1617



United Steel Deck, Inc.

**3**  
joist design data sheet

Please circle # 33



# ARBED

## HISTAR® Grades 50 and 65.

### WIDE FLANGE & TAILOR - MADE BEAMS

- ◆ High Strength, Low Carbon, Fine Grain, Weldable Without Preheating & Good Ductility.
- ◆ Reduces Material, Handling, Transportation, Erection & Welding Costs.
- ◆ Sectional properties are available on a free floppy disc (Lotus 1-2-3, Quattro Pro and ASCII versions for IBM, Excel for Macintosh) and the complete **ARBED** database is ready to use in the design softwares GTSTRUDL, ETABS, SAP90 AND STAAD-III.

### TRUSS APPLICATIONS

- ◆ *Sports Arenas/Stadiums*
- ◆ *Airports (Hangars/Terminals)*
- ◆ *Convention Centers*
- ◆ *Gymnasiums*
- ◆ *Shopping Malls*
- ◆ *Casinos*

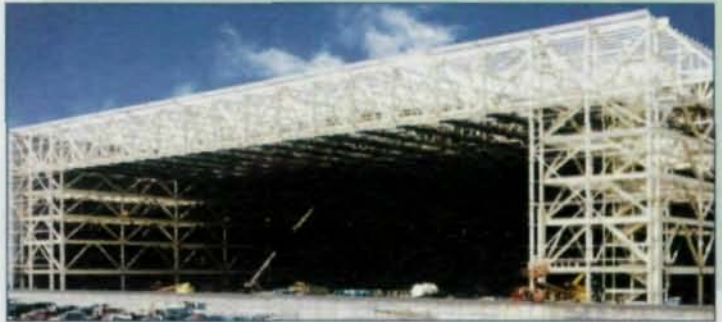

### COLUMN APPLICATIONS



All of the above PLUS:

- ◆ *High-Rise Buildings*
- ◆ *Hospitals*
- ◆ *Heavy Industrial Plants*
- ◆ *Power Plants*

HISTAR® is a registered trade-mark of ARBED.

For complete information, availability, literature and floppy disc, contact one of our **TradeARBED** offices at the following locations:

- ☐ 825 Third Ave., New York, NY 10022. 1-800-272-3369, FAX (212) 355-2159.
- ☐ 60 E. Sir Francis Drake Blvd., Larkspur, CA 94939. (415) 925-0100, FAX (415) 461-1624/8257.
- ☐ 390 Brant Street, Suite 300, Burlington, Ontario, Canada L7R 4J4. (905) 634-1400, Fax (905) 634-3536.



# MODERN STEEL CONSTRUCTION

Volume 35, Number 11

November 1995

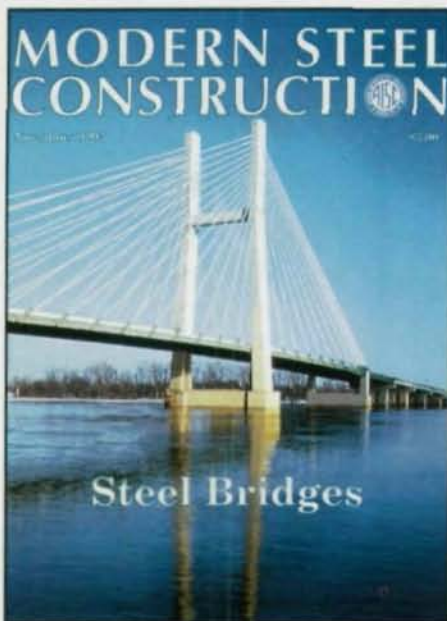

Cable stayed bridges create a dramatic presence while also providing an economical solution. The story behind this Iowa bridge begins on page 18.

## FEATURES

- 18 **A NEW LINK ACROSS THE MISSISSIPPI RIVER**  
*A cable stayed bridge, with the cables arranged in a modified fan pattern, provided both an economical shallow deck structure and an aesthetic appearance*
- 26 **Ribbon Of Steel**  
*A twin trapezoidal steel box girder composite superstructure was the winning design in an international competition to select a replacement bridge in Maryland*
- 34 **Sloping Legs Keep Bridge Piers Above Water**  
*Since the Occoquan Reservoir is a primary source of drinking water, it was essential for quick approval that a new bridge's piers be kept out of the water*
- 44 **POST-TENSIONED BOX GIRDERS**  
*The use of post-tensioned steel box girders on three bridges in Florida is expected to improve aesthetics without increasing costs while also enhancing long-term performance characteristics*

## DEPARTMENTS

- |   |   |    |   |
|---|---|----|---|
| 6 | <b>EDITORIAL</b>  | 8  | <b>STEEL QUIZ</b>   |
| 9 | <b>STEEL INTERCHANGE</b> <ul style="list-style-type: none"><li>• Special requirements for high-strength bolts in a high temperature area</li><li>• Designing welds to connect plates</li><li>• Lateral unbraced lengths for bottom flange of continuous trolley beams</li><li>• Determining the effective allowable member width for point loads on the standing leg of an angle</li><li>• Wall section use</li></ul> | 15 | <b>STEEL NEWS</b> <ul style="list-style-type: none"><li>• National Steel Construction Conference</li><li>• Bridge Symposium</li><li>• Steel Joist Specifications</li><li>• Upcoming Conferences</li><li>• Updated Bridge Welding Code</li></ul> |
|   |   | 53 | <b>INNOVATIVE DECKING SOLUTIONS</b>   |
|   |   | 57 | <b>STEEL MARKETPLACE</b>  |
|   |   | 57 | <b>ADVERTISING INDEX</b>  |

Modern Steel Construction (Volume 35, Number 11). ISSN 0026-8445. Published monthly by the American Institute of Steel Construction, Inc., (AISC), One East Wacker Dr., Suite 3100, Chicago, IL 60601-2001.

Advertising office: Facinelli Media Sales, O'Hare Lake Office Plaza, 2400 E. Devon Ave., Des Plaines, IL 60618 (708) 699-6049.

Subscription price:  
Within the U.S.—single issues \$3;  
3 years \$85.  
Outside the U.S.—single issues \$5;  
1 year \$36; 3 years \$100.

Please fax any address changes to 312/670-5403 or to the address below.

Postmaster: Please send address changes to Modern Steel Construction, One East Wacker Dr., Suite 3100, Chicago, IL 60601-2001.

Second class postage paid at Chicago, IL and at additional mailing offices.



# Think No. 1... Think STAAD-III

## Competitive Upgrade Offer

**\$995**



**Attention: SAP 90, ETABS, RISA, STRUDL, ROBOT Users**

**You asked for it!... And we listened.**

You told us that you want only the best. Why settle for less?

Now you can switch to the very best for very little. After all, STAAD-III, choice of 50,000 plus engineers worldwide, has been consistently ranked #1 by all major industry surveys. And now, you can procure STAAD-III, STARDYNE, and AutoSTAAD - RE's world class structural products, for only a fraction of the price.

### Here's how it works ...

If you are currently using RISA®, ETABS, SAP 90, STRUDL, or ROBOT ...

You may procure	for just ...
STAAD3-2D (DOS)	\$ 895 \$ 195
AutoSTAAD (VAD 13)	\$1295 \$ 195
STAAD-III (Unlimited ver., includes both DOS & Windows)	\$4000 \$ 995
STARDYNE (Unlimited ver., Windows)	\$3995 \$ 995
STAAD-III and STARDYNE (as above)	\$7995 \$1595

- Limited time offer. Expires January 31, 1996.
- Current copy of competitor's software must be purchased before October 15, 1995.
- Proof of purchase required.
- Other Structural software users, please call to check if you qualify.

\* RISA, ETABS, SAP 90, STRUDL, and ROBOT are registered trademarks of the respective developers.

### Release 21 Highlights

- 3-6 times faster with 75% less storage.
- "Concurrent Engineering" based GUI.
- On-line Manual and Tutorials.
- True 32 bit Windows and NT versions.

## STARDYNE®

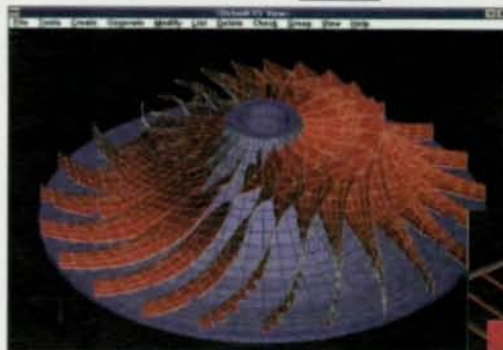

World's first and most trusted Finite Element Software for Mechanical and Structural engineers - since 1968.

## AutoSTAAD



**Release 21**

# STAAD-III

A reputation you can build on

**Research Engineers, Inc.**

#### Headquarters:

22700 Savi Ranch, Yorba Linda, CA 92687-4608  
Tel: (714) 974-2500 Fax: (714) 974-4771 Toll Free: (800) FOR-RESE

#### Eastern Regional Office:

885 Turnpike St., North Andover, MA 01845  
Tel: (508) 688-3626 Fax: (508) 685-7230 Toll Free: (800) 322-1487



# Reserve Strength

## Editorial Staff

Scott Melnick,  
Editor and Publisher  
Patrick M. Newman, P.E.,  
Technical Director  
Charlie Carter,  
Senior Technical Advisor  
Jacques Cattani,  
Technical Advisor

## Editorial Offices

Modern Steel Construction  
One East Wacker Dr.,  
Suite 3100  
Chicago, IL 60601-2001  
(312) 670-5407  
Fax 312/670-5403

## Advertising Sales

Facinelli Media Sales  
2400 E. Devon Ave.,  
Suite 267  
Des Plaines, IL 60018  
(708) 699-6049  
Fax 708/699-8681

## AISC Officers

Robert E. Owen,  
Chairman  
H. Louis Gurthet,  
First Vice Chairman  
Robert G. Abramson,  
Second Vice Chairman  
Robert D. Freeland,  
Treasurer  
Neil W. Zundel,  
President  
David Ratterman,  
Secretary &  
General Counsel  
Morris Caminer,  
Vice President,  
Finance/Administration

**T**HE CHICAGO AREA LOST ONE OF MY FAVORITE LANDMARKS LAST MONTH. For many years, the Lindheimer Observatory stood guard on the lake shore on Northwestern University's campus. Unfortunately, it was a poorly maintained structure: its supporting steel frame was coated with a flaking lead-based paint and the inside was insulated with asbestos. Since the observatory no longer served a research function (there's a bit too much light pollution 10 miles north of downtown Chicago in Evanston), the university opted—despite the considerable chagrin of much of the surrounding community—not to spend the necessary \$750,000 to renovate a building whose sole purpose would have been aesthetic.

Instead, the school hired a demolition company to perform what initially looked to be a fairly simple task. Given the structure's fairly isolated location, controlled explosives seemed like a logical way to bring down the once glorious structure. But despite its delicate appearance, steel can be a surprisingly strong material. So the demolition company set its explosives, and lo and behold, all they succeeded in doing was to bend some of the steel members.

Not to be denied, the workers next decided to hook chains up to the structure and simply pull it down. But again, the effort was to no avail. Instead of pulling down the observatory, all they did was create the Leaning Tower of Evanston.

Finally, they opted for the slow yet sure and disassembled the entire structure piece by piece.

As we watched this comedy of errors unfold night after night on the local news, my wife wondered why they were having so much difficulty. What immediately crossed my mind was the steel buildings that survived the Northridge Earthquake despite losing the integrity of many of their connections. Steel buildings have a remarkable reserve strength that isn't calculated in any design. The uncalculated strength comes from elements such as gravity framing, which actually provides some lateral strength.

Designers don't often consider the reserve strength of steel, but it's a key advantage of steel structures and it's one of the reasons that you have to work awfully hard to bring a steel structure down. **SM**



91243

# SDS/2 leaves nothing to the imagination

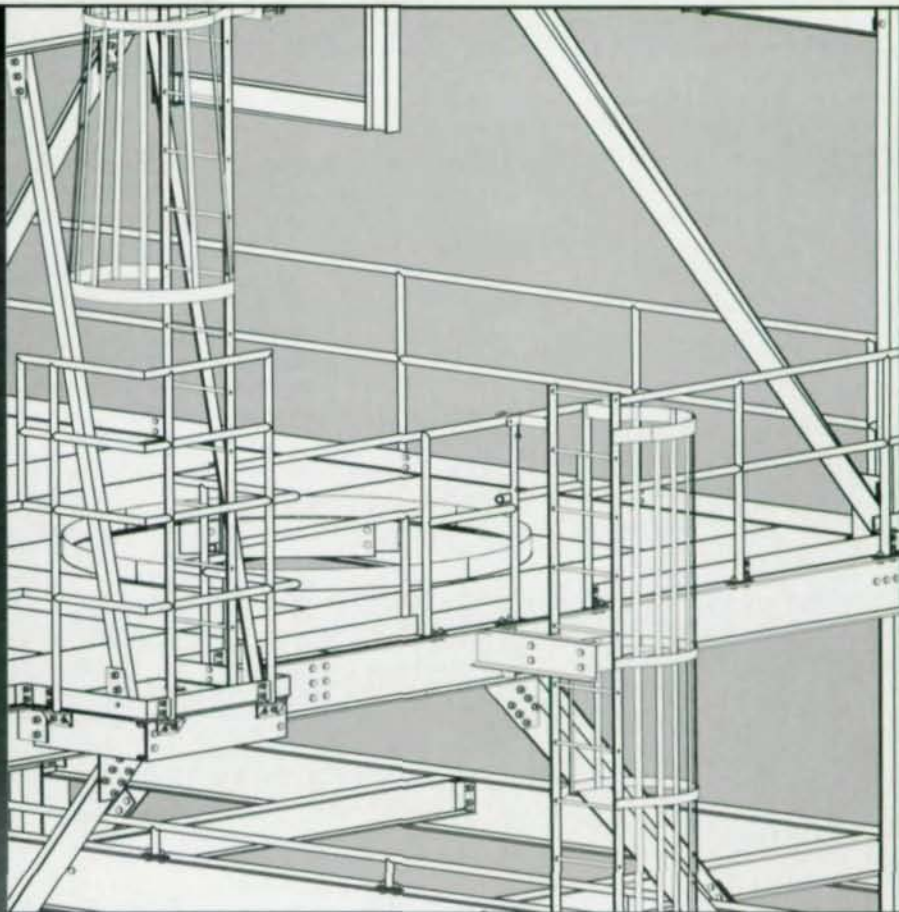

*Compliments of Safety Steel, Victoria, Texas*

Imagine...a software system that automatically gives you:

- Shop Drawings
- CNC Data for Shop Equipment
- Connection Design Calculations
- Labor for Estimating
- Ordering & Inventory Data
- Revision Management
- Job, member status and much more

With SDS/2 imagination becomes reality. You get details, estimates and ordering information on every piece of steel in the job—right down to the nuts, bolts and washers. SDS/2 is the only comprehensive software system for every phase in the steel industry. With SDS/2, each phase of a project creates and stores information that is integrated and utilized in the next project phase, eliminating costly data re-entry time. Project schedules, job status, drawing submittal/approval and erection planning can all be easily done using SDS/2. Whether you are an owner, engineer, fabricator or detailer, you will be able to see the money saving benefits of using SDS/2.

Don't leave anything to the imagination on your next project. Call today for more information or to set up your own personal demonstration of the SDS/2 products that include:

- Estimating
- CNC Interface
- Engineering Design
- Production Control
- Detailing
- DesignLINK

**DESIGN  
DATA**

"First in...software, solutions, service"  
402-476-8278 or 1-800-443-0782  
e-mail: [info@dsndata.com](mailto:info@dsndata.com)

Please circle # 32



# STEEL QUIZ

**S**TEEL QUIZ, A NEW MONTHLY FEATURE IN MODERN STEEL CONSTRUCTION, allows you to test your knowledge of steel design and construction. Unless otherwise noted, all answers can be found in the *LRFD Manual of Steel Construction*. To receive a free catalog of AISC publications, circle #10 on the reader service card in the back of this magazine.

1. Physically, the U.S. customary shape series and metric shape series are identical, True or False?

2. Cross-sectional dimensions and standard mill practice may be found in which of the following documents?

- a) ASTM A36
- b) ASTM A6/A6M
- c) AISC's Manual of Steel Construction

- d) a and c
- e) b and c

3. An installed bolt with the point of the bolt flush with the face of the nut is acceptable, True or False?

4. Which of the following methods for bolt installation is not recognized by the RCSC and AISC?

- a) standard torque
- b) turn-of-nut
- c) snug-tight
- d) calibrated wrench

5. In which of the following positions can weld metal be deposited at the fastest rate?

- a) horizontal
- b) vertical
- c) flat
- d) overhead

6. Which is more costly: a 1/4-in. fillet weld ten inches long or a 1/2-in. fillet weld 5 inches long?

7. If an extended end-plate moment connection is specified as slip-critical, the slip resistance of the bolts at the tension flange must be reduced for the tension present, True or False?

8. Which of the following factors is used to adjust for inelastic column behavior?

- a) K
- b) SRF
- c) m
- d) n
- e) m and n

9. In a partially composite beam, which of the following controls the flexural design?

- a) compression in the concrete
- b) tension in the steel
- c) compression in the steel
- d) shear strength of the shear stud connectors

10. Which of the following trusses does not utilize diagonal members?

- a) Pratt
- b) Fink
- c) Warren
- d) Vierendeel

## Need Structural Design, Analysis and Drafting?

**Multi-Steel**, the only complete structural software package for AutoCAD, allows bidirectional associativity between your 2D frame drawings and 3D structural models.

And, **Multi-Steel** also offers:

- Steel editing including notching and cutbacks
- Parametric connection detailer
- Material take-off
- Welding details
- Stairs, handrails, platforms and ladders
- Two-way link to Rebis' OPTIMIZER structural frame analysis software



Multi-Steel runs on AutoCAD Release 12 & 13 for DOS and Windows.

Call 1-800-4REBIS1 today  
for a FREE demo disk!

**rebis**  
INDUSTRIAL WORKGROUP SOFTWARE

Rebis  
1600 Riviera Avenue, Suite 300  
Walnut Creek, CA 94596  
Tel (510) 933 2525, Fax (510) 933 1920

Please circle # 26

Answers on PAGE 13



# STEEL INTERCHANGE

*Steel Interchange* is an open forum for *Modern Steel Construction* readers to exchange useful and practical professional ideas and information on all phases of steel building and bridge construction. Opinions and suggestions are welcome on any subject covered in this magazine. If you have a question or problem that your fellow readers might help you to solve, please forward it to *Modern Steel Construction*. At the same time, feel free to respond to any of the questions that you have read here. Please send them to:

**Steel Interchange**  
**Modern Steel Construction**  
**One East Wacker Dr., Suite 3100**  
**Chicago, IL 60601-2001**

Answers and/or questions should be typewritten and double-spaced. Submittals that have been prepared by word-processing are appreciated on computer diskette (either as a Wordperfect file or in ASCII format).

The opinions expressed in *Steel Interchange* do not necessarily represent an official position of the American Institute of Steel Construction, Inc. and have not been reviewed. It is recognized that the design of structures is within the scope and expertise of a competent licensed structural engineer, architect or other licensed professional for the application of principals to a particular structure.

Information on ordering AISC publications mentioned in this article can be obtained by calling AISC at 800/644-2400.

The following responses from previous Steel Interchange columns have been received:

**Are there special requirements for the design of high-strength A325 or A490 bolts that are going to be in a high temperature area?**

**A**STM A325-89, paragraph 1.2 stated in part: "...where elevated temperature applications are involved, Type 1 bolts shall be specified by the purchaser."

However, this statement was removed from the 1993 update of the specification. This statement was all too encompassing, and not knowing the actual application for the bolts, it was determined that this statement should be removed. It is possible that the user could place these bolts under temperatures that may affect the physical properties of the bolts. An example being that they were not designed to be used in high-pressure, high-temperature service areas found in power plants.

ASTM A490 specifications do not address the use of these bolts in elevated temperature areas.

There are bolts manufactured for use in elevated temperature areas.

Not knowing the specific application or design requirements the bolts are being used for; look into the possibility of substituting these bolts with ASTM A193/A193M "Standard Specification for Alloy Steel and Stainless Steel Bolting Materials for High-Temperature Service" and ASTM A449 "Standard Specification for Quenched and Tempered Steel Bolts and Studs"

**Tom Slovick**  
**Industrial Steel**  
**Mims, FL**

**If a W-shaped column is made up of three welded plates, how does one design the welds**

**connecting the plates together?**

**I**n general it is best to weld along the full length of the web so one may ignore buckling of the individual elements, i.e. the web and flange. One must still consider buckling according to Table B5.1, Limiting Width-Thickness Ratios for Compression Elements, from the LRFD Manual of Steel Construction. Assuming there is no moment introduced into the column one should use the minimum weld size given in Tables J2.3 and J2.4 of the LRFD Manual.

If the column is subjected to bending stresses which may be due to eccentricities or a lateral load the weld must be designed to transfer the load between the web and the flange like one would do for a beam. The shear flow can be calculated using the formula:

$$\text{Shear Flow} = \frac{V_u Q \text{ kips}}{I_x \text{ in.}}$$

The capacity of the weld is then calculated as:

Continuous Weld Design Strength =  $\phi R_{nw}$

An example of this type of design can be found in Chapter 11 of Salmon and Johnson, Steel Structures. In most cases the minimum weld size will control.

**James D. Palmer**  
**Butler Manufacturing Company**  
**Grandview, MO**

**For a continuous trolley beam with multiple spans and cantilevered ends what is the lateral unbraced length for the bottom flange?**

**O**ne answer published in the July 1995 issue suggests that the lateral unbraced length is simply twice the cantilever distance. A more complete and exact solution to this problem is offered in a 3rd Quarter 1985 Engineering Journal



# STEEL INTERCHANGE

paper by N. Stephen Tanner "Allowable Bending Stresses for Overhanging Monorails." By considering the ratio of the overhanging span to the adjacent interior span in developed equations, a less conservative answer may be computed.

**Nestor Iwankiw**  
AISC, Inc.  
Chicago, IL

**When considering a point load on the standing leg of an angle, what provisions are there for determining the effective allowable member width?**

The following two articles will give a practical approach including finite element study and the latter is a theoretical method for solving the problem of how to distribute a point load on a shelf angle.

Tide, R.H.R. and Norbert V. Krogstad, "Economical Design of Shelf Angles," Proceedings, Symposium on Masonry: Design and Construction, Problems and Repair, Miami, FL, December 8, 1992, STP 1180, May 1993, American Society for Testing and Materials, Philadelphia, PA

Jaramillo, T.J., "Deflections and Moments Due to a Concentrated Load on a Cantilever Plate of Infinite Length." Journal of Applied Mechanics, March 1950, American Society of Mechanical Engineers, New York, NY

**R.H.R. Tide**  
Wiss, Janney, Elstner Associates, Inc.  
Northbrook, IL

**Given a wall of sheet metal or plate subjected to fluid pressure and stiffened by same size parallel members spaced regularly, what section (or width) of the wall shall be used that contributes to the section of a stiffener? The stiffening member may be a flat bar, an angle, or a channel or any other section.**

The section of wall that contributes to the section of a stiffener is defined by means of an effective width by which shall not exceed:

a) The geometric condition, that is the distance between center line of adjacent beams.

b) The shear lag condition, which may be estimated as  $1/4$  of the effective beam span (length of positive moment area of the rib).

c) The stability condition of the plate between stiffeners (see "Specification for the Design of Cold Formed Steel Structural Members", AISI, 1986, B2.1).

With the effective width so defined a verification

must be done of the resistance of welding between the sheet and reinforcement ("Coligon" stresses), and possible buckling due to weld spacing in the line of stress.

**Miguel A. Dodes Traian**  
Buenos Aires, Argentina

---

## NEW QUESTIONS

---

Listed below are questions that we would like the readers to answer or discuss.

If you have an answer or suggestion please send it to the Steel Interchange Editor, Modern Steel Construction, One East Wacker Dr., Suite 3100, Chicago, IL 60601-2001.

Questions and responses will be printed in future editions of Steel Interchange. Also, if you have a question or problem that readers might help solve, send these to the Steel Interchange Editor.

**Is there any criteria, except direct field measurements by drilling holes, to determine the percent loss of capacity in steel bridge members due to weather exposure for the purpose of rating the truck capacity of bridges.**

**Mike Alomari**  
Wayne County  
Sterling Heights, MI

**Where should a control joint be located in a composite large composite floor? Should it be located over the top of either the girders or the beams? What happens to the strength of the shear studs if the concrete cracks over the shear studs? Does this crack go all the way through the slab to the top of the steel beam?**

**Can any beam be cambered without heating? Is there a slenderness limit for the web to prevent buckling of the web while cold cambering?**

**Is it acceptable to either mechanically galvanize or hot dip galvanize high strength bolts? Are there different requirements for the installation depending on how the bolt is galvanized?**



# Join The Wasser Revolution!

Stop using 2-part epoxies, 2-part urethanes and inorganic zincs. After 40 years, it's time to move to a coating system that's far better. Wasser has revolutionized the industry. **Join Us!**

## BRIDGES AND LEAD OVERCOAT



**ASTORIA BRIDGE, OREGON COAST** - Hundreds of bridge projects in environments like Oregon's coast, prove Wasser outperforms all other coatings.

## WATER AND WASTEWATER



**NORTH POLE ALASKA** - Painting continues on these sludge beds, while standing in snow. Wasser outperforms epoxy coatings on these demanding projects.

1. Industry's **BEST Corrosion Resistance**
2. **Single Component.**
3. **No Application Restrictions for Humidity, Dewpoint or Temperature (20°F)**
4. **World's Largest Producer of Single Component Moisture Cure Urethanes.**
5. **North America's Largest Manufacturer of Micaceous Iron Oxide Coatings.**

## UTILITIES, DAMS AND LOCKS



**PRIEST RAPIDS DAM, COLUMBIA RIVER** - Wasser has been chosen for their superior performance by agencies throughout the world.

## PULP AND PAPER



**CHIP CRANE, ROSEBURG LUMBER** - Wasser Coatings allow perfect results in outdoor winter painting or indoor painting on paper machinery, for virtually every paper company. Imagine, immersion after only minutes, and superior performance.

# WASSER

HIGH-TECH COATINGS

FOR FREE VIDEOS

Call 800-MC-PAYNT

For Information About Wasser  
Circle Reader Response #50

## Wasser, the Leader of the Coating Revolution!



# Wasser Coatings Aren't Just Better... They're A Lot Better Look What Experts Are Saying....

"Wasser's system outperformed every high performance coating system even when applied on poorly prepared surfaces. It has solved our state's bridge painting problems."

• *State Highway Report*

"This is Alaska paint. It would be crazy to use anything else but Wasser in this environment."

• *Alaska Coating Inspector*

"Our tank painting project was delayed for months because of the humidity. With Wasser, we finished in three days."

• *Hawaiian Contractor*

"We can't say enough about the MC-Tar. It saved our tail on our clarifier tanks. We would still be painting with the epoxy."

• *Paper Mill Engineer*

"We are very pleased with Wasser for lead overcoating. Everyone is calling it 'steel on steel'. Wasser solved our overcoat problems."

• *Highway Official*

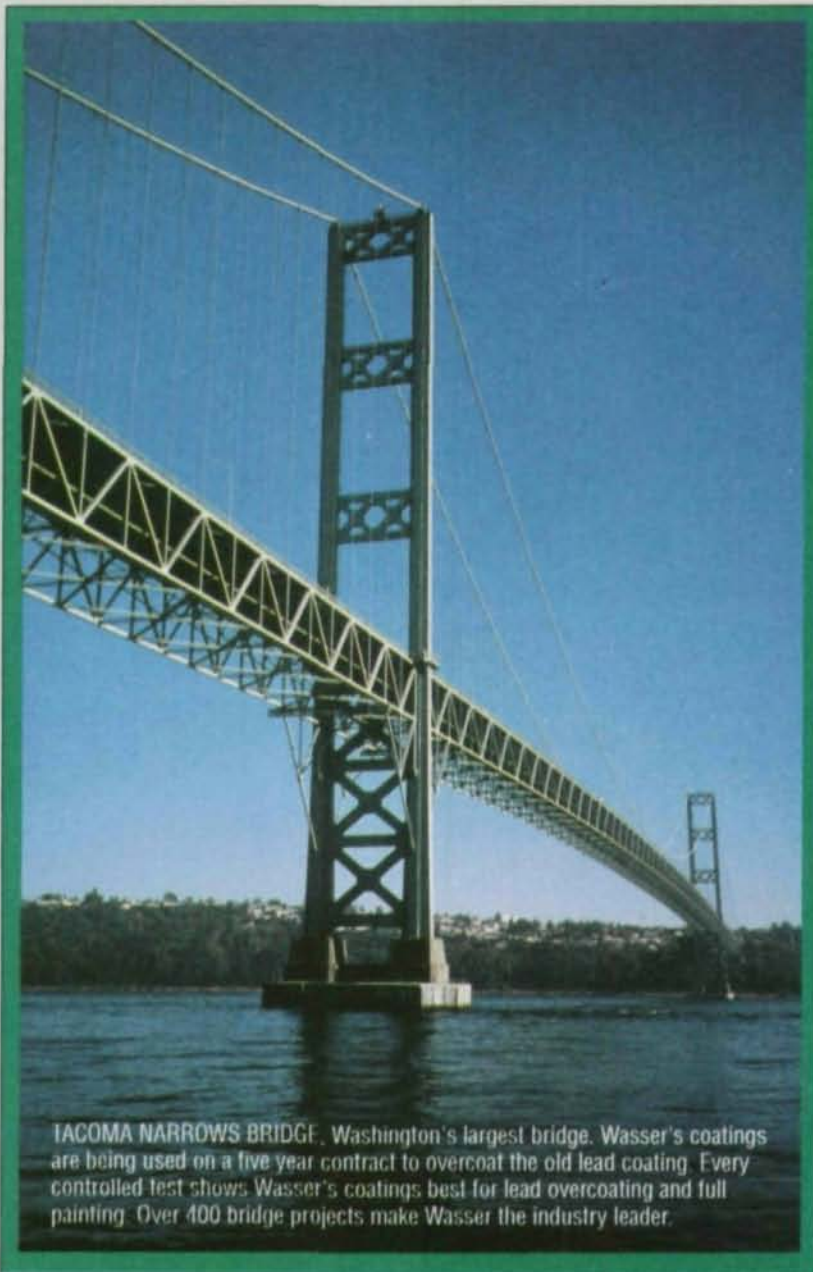

TACOMA NARROWS BRIDGE, Washington's largest bridge. Wasser's coatings are being used on a five year contract to overcoat the old lead coating. Every controlled test shows Wasser's coatings best for lead overcoating and full painting. Over 400 bridge projects make Wasser the industry leader.

"We used the ice as scaffolding in 22' tide and painted down to within four inches of low tide. Four years later, the coating is still perfect on these pilings."

• *Alaska Contractor*

"We coated the interior areas in 99% humidity and the performance is perfect after five years. We'll never use anything else."

• *Army Corps Locks*

"If it wasn't for Wasser, we would still be out there trying to get that darn inorganic zinc to work."

• *Bridge Engineer*

"Wasser is the answer to all our field painting problems. We'll never use epoxy again."

• *Waste Water Engineer*

"Wasser beat every other coating in our tests, and contractors love them."

• *Paper Mill Engineer*

**WASSER**  
HIGH • TECH COATINGS

**Call 800-MC-PAYNT**

**The Best Coatings in the Industry are also the Easiest to Apply!**

CIRCLE #50 ON SERVICE CARD

World Leader in  
Single-Component,  
Moisture-Cure  
Urethane



**A**lthough the Midlothian Chamber of Commerce might disagree, you don't have to move here. Now there's a better way to get the most current and complete information from Chaparral Steel, and it's all thanks to you. Chaparral has recently upgraded our Mill/Net and Mill/FAX capabilities, making a good system even better. You told us what you wanted, and we listened. As a result, you can get more real-time information faster than ever. All it takes is a computer modem hook-up or a FAX and phone.

With Mill/Net and Mill/FAX, you have direct access to the most up-to-date facts in our system, including open order status, stock availability, rolling schedules, 10-day shipment history, rail shipments, and scheduled shipments for the day—all in an instant.

For more information on these free, even more convenient services, contact Chaparral Steel at 1-800-527-7979. Or if you'd prefer, we can recommend a few good Realtors.



**CHAPARRAL  
STEEL**

Chaparral Steel  
300 Ward Road  
Midlothian, Texas 76065-9651  
Toll Free (800) 527-7979  
U.S. and Canada  
Local (214) 775-8241  
Fax (214) 775-6120

Please circle # 43

© 1995 Chaparral Steel



**TO GET  
BETTER  
INFORMATION,  
YOU'D HAVE TO  
MOVE TO  
MIDLOTHIAN.**



# Fortunately Some People Are Never Satisfied.



Lukens remains committed to the only bridge construction material with a proven track record — steel.

Steel bridges built over a century ago remain vital links in our nation's highway system. And just as today's bridge designs are better than ever, so is the steel that makes them possible.

With more grades and higher strength levels available, steel offers unsurpassed design flexibility. The result

is reduced structure weight, making construction easy and cost effective.

Weathering steel and modern coating systems provide increased longevity. And a steel bridge's structural condition can be reliably inspected for years.

Lukens' commitment to steel bridges is backed by modern steel-making facilities that produce the full line of structural quality plate steel

specifications — up to 127 feet long and over 16 feet wide.

Consider steel. It's got a lot more to offer. For a lot longer.

**LUKENS  
STEEL**  
A LUKENS COMPANY

The Specialist In Plate Steels.



Lukens Reg. U.S. Pat & TM Off. ©1994 Lukens Steel

Please circle # 58



# STEEL QUIZ

The answers to this month's steel quiz are as follows:

1. True. Because our current shape series is one of the most efficient in the world, and because the inch-series dimensions are nominal (e.g., a W14 is not exactly 14 in. deep), the metric series is simply a soft conversion of it. Refer to AISC's *Metric Properties of Structural Shapes*.

2. e. ASTM A6/A6M is the standard which specifies cross-sectional dimensions and standard mill practice for rolled shapes. AISC's *Manual of Steel Construction* incorporates this information in Part 1.

3. True. RCSC Specification Commentary Section C2 defines full thread engagement as "having the end [point] of the bolt at least flush with the face of the nut."

4. a. Both RCSC and AISC discourage use of a standard uncalibrated torque value. Such an uncalibrated value may be too high and break well lubricated bolts or, more importantly, may be too low and result in undertensioned bolts if the thread lubrication is poor or the threads are dirty or corroded. Therefore, if torque is to be used, it must be calibrated according to RCSC Specification Section 8(d)(2).

5. c. Welding in the flat position allows the fastest deposition rate and therefore is the most economical welding position.

6. At first glance these welds seem to be of equal cost because they are of equivalent strength. However, because the volume of weld metal is proportional to the square of the weld size, the 1/2-in. weld uses twice as much weld metal as the 1/4-in. weld. Additionally, a 1/2-in. weld will require multiple weld passes. In the end, the same strength will cost more than twice as much with the 1/2-in. weld.

7. False. Because the tensile and compressive flange forces are equal, any loss of slip resistance adjacent to the tension flange of the beam is compensated for by an increase in slip resistance adjacent to the compression flange.

8. b. The stiffness reduction factor SRF is used to adjust G for inelastic behavior.

9. d. The flexural strength of partially composite beams is controlled by the shear strength of the shear stud connectors.

10. d. A Vierendeel truss utilizes chord and vertical members without diagonals. Therefore, unlike other ideal trusses, Vierendeel truss members must also transmit member forces due to bending.



**VALMONT  
TULSA**

## Custom Tubular Sections Made To Your Specific Shapes & Sizes

ASTHETICALLY  
APPEALING



PROPERTIES TAILORED  
TO SPECIFIC NEEDS

EXCELLENT TORSIONAL  
PROPERTIES



EXCELLENT  
COLUMN STRENGTH

LARGE SIZES  
14" TO 30"

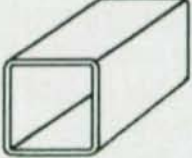

SQUARES



RECTANGLES

HEAVY WALL  
THICKNESS 3/8" - 5/8"

■ Sizes up to 30" square  
■ No minimum order size

■ Section properties  
available on request

---

VALMONT TULSA • P.O. BOX 2620 • TULSA, OKLAHOMA 74101  
ATTN: GARY HANEY • CALL TOLL FREE: 1-800-331-3002  
Please send additional information about custom tubular sections.

NAME \_\_\_\_\_ TITLE \_\_\_\_\_

FIRM \_\_\_\_\_

ADDRESS \_\_\_\_\_

CITY \_\_\_\_\_ STATE \_\_\_\_\_

PHONE \_\_\_\_\_ ZIP \_\_\_\_\_

Please circle # 106



March 27-29, 1996 • Phoenix, Arizona

# 1996 National Steel Construction Conference

## Where the Steel Team Meets...

An expanded educational program — six tracks dedicated to management, technology, engineering and fabrication issues — round out three information-filled days of learning.

Expand your knowledge . . . network with steel construction industry professionals from around the world . . . view the latest products and services for the industry in an expanded expo area . . . it's all a part of the 1996 National Steel Construction Conference, March 27-29, at the Phoenix Convention Center, Phoenix, Arizona.

Educational tracks cover topics such as connections causing severe erector problems,

## • Tracks •

**NEW!** Computer Track

**NEW!** Erection Track

Fabrication Track

erection cost basis; architectural fabrication, welding code reorganization, qualifications and equipment; electronic information exchange for project design and status; e-mail and the fabricator; process industry practices; material management; learning from Northridge; composite design issues; communication of LRFD load information to the fabricator; effective specification, contract documents and general notes, and much more.

Construction Management Track

Engineering Management Track

Engineering Technical Track

If there's one industry gathering you're sure to attend, make it the 1996 National Steel Construction Conference, March 27-29, at the Phoenix Convention Center, Phoenix, Arizona. For more information, complete the coupon below and FAX or mail it to:

American Institute of Steel Construction, Inc.

1 East Wacker Dr., Ste. 3100  
Chicago, IL 60601-2001  
Phone: 312/670-5422  
FAX: 312/670-5403



1996 NATIONAL STEEL  
CONSTRUCTION CONFERENCE  
MARCH 27-29, 1996  
PHOENIX CONVENTION CENTER  
PHOENIX, ARIZONA

**YES!** I want to  
attend the  
1996 National  
Steel Construction  
Conference.  
Send me  
registration  
information.

Name \_\_\_\_\_  
Company \_\_\_\_\_  
Title \_\_\_\_\_  
Address (No P.O. Box please) \_\_\_\_\_  
City/State/ZIP \_\_\_\_\_  
Phone/FAX \_\_\_\_\_

MSCN

**For easy registration, call 1-800-787-0052, ext. 110**



Setting Standards for Over 70 Years

Please circle # 4



# NATIONAL STEEL CONSTRUCTION CONFERENCE EXPANDS SCOPE

SIX TRACKS WILL BE OFFERED AT NEXT YEAR'S NATIONAL STEEL CONSTRUCTION CONFERENCE. New in 1996 will be sessions on computers and erection. In addition, specialized tracks will be offered on: engineering—technical; engineering—management; fabrication; and construction management.

"There was a lot of enthusiasm generated last year when we first introduced specialized tracks," explained Franklin B. Davis, chairman of AISC's NSCC Committee. "The two new tracks are designed to continue and expand on that excitement.

"There has long been a feeling in the engineering consulting community that the erection of steel buildings has not received as much attention as it should. Adding a track on erection should help bring some key issues to the forefront. And adding a computer track is a natural for the show, given its wide attendance from all segments of the steel industry. The advances being made in software have been tremendous during the past few years. The NSCC is an ideal forum where the user and the producer can get together to interface for the benefit of all parties," Davis concluded.

The 1996 Conference will be held in Phoenix on March 27-29. Hot seminar topics include:

- "Selection of Bolted Joint Criteria" with Robert O. Disque, a former long-time AISC engineer and currently a consulting engineer with Besier Gibble Norden in Old Saybrook, CT, and Michael A. Gilmor of CISC and current chairman of the Research Council on Structural Connections;

- "Industrial Building Design" with Jules Van de Pas of Computerized Structural Design in Milwaukee, Duane Ellifrit of University of Florida, and Bob



## 1996 NATIONAL STEEL CONSTRUCTION CONFERENCE

MARCH 27-29, 1996

PHOENIX CONVENTION CENTER

PHOENIX, ARIZONA

MacCrimman of Acres International, Niagara Falls, Ontario

- "Bar Coding—Fabrication Shop Connections" with Richard

Bushnell of Quad II, Shalfont, PA

- Computer Program Usage (MathCAD and Beyond)

- Problem Connections

- "Architectural Fabrication: What is Involved" with David Sailing of Zalk Josephs, Stoughton, WI, and Jim McCrae of Nieder Hauser, Salt Lake City

- "How to evaluate Detailing Software"

- "Steel Erection Awareness"

In addition to more than 30 technical sessions, there will be an exhibit hall with nearly 70 product exhibitors. The sessions qualify for CEU credit and time also is available for extensive industry networking. Also, an extensive package spouse/family activities are scheduled.

As an added benefit, AISC will offer a Short Course on Bolting on Saturday, March 30, 1996. The course is separate from the National Steel Construction Conference and requires a separate registration.

To receive an information and registration packet, please call 800/787-0052 ext. 110.

## CALL FOR PAPERS: NATIONAL STEEL BRIDGE SYMPOSIUM

THE NSBA NATIONAL STEEL BRIDGE SYMPOSIUM, to be held in Chicago in the Fall of 1996, brings together design and engineering professionals, FHWA and Department of Transportation Officials, fabricators, erectors and contractors to discuss and learn about state-of-the-art bridge design, fabrication and construction techniques. The Symposium includes workshops, lectures, technical sessions and the presentation of the AISC Prize Bridge Awards.

If you are interested in submitting a paper on bridge design, fabrication or erection, or on any aspect of an innovative bridge project (painting, welding, connections, bearings, etc.), send a short summary or abstract to: Fred Beckmann, AISC Director of Bridges, American Institute of Steel Construction, Inc., One East Wacker Dr., Suite 3100, Chicago, IL 60601-2001 (fax: 312/670-5403) by December 15, 1995.



## STEEL JOIST SPECIFICATIONS

THE STEEL JOIST INSTITUTE'S 40TH EDITION OF "SPECIFICATIONS, LOAD TABLES AND WEIGHT TABLES" is now available. The 96-page catalog includes new stability requirements, specifications and load tables for the all-new KCS Joist, fire resistance ratings, metric units, and a one-page method for converting the load tables for use with Load and Resistance Factor Design (LRFD).

Copies of the catalog are available for \$20 (or \$30 outside the U.S.), including shipping and handling.

For more information, contact SJI, Suite A, 1205 48th Ave. N., Myrtle Beach, SC 29577; 803/449-0487 or **circle no. 54** on the readers service card in the back of this magazine.

## UPCOMING CONFERENCES

- **ASCE Structures Congress**  
Chicago  
April 15-18, 1996  
(Includes more than 100 technical sessions and combines several specialized conferences: Council on Tall Buildings and Urban Habitat; Structural Stability Research Council; ASCE Committee on Analysis and Computation)  
Contact: ASCE at 212/705-7496
- **1996 FHWA-AASHTO National Metric Conference**  
Radisson MetroDome,  
Minneapolis, MN  
April 15-18, 1996  
Contact: Bob McPartlin,  
MN/DOT, 612/296-4337
- **Structural Steel—Developing Africa**  
Johannesburg, South Africa

August 13-15, 1996  
Contact: SAISC, 7th Floor,  
Metal Industries House, P.O.  
Box 1338, Johannesburg  
2000, South Africa; 011/838-  
1865; fax: 011/834-4301

- **Semi-Rigid Structural Connections**  
Istanbul, Turkey,  
September 25-27, 1996  
(Colloquium will include connections in steel, concrete, composite, timber and masonry; reports of the pan-European COST C1 project; and links between research findings and their practical applications.)  
Contact: Reidar Bjorhovde,  
Department of Civil and Environmental Engineering,  
University of Pittsburgh, 937 Benedum Hall, Pittsburgh, PA 15261-2294;  
412/624-9876;  
e-mail: bjohn@civ.pitt.edu

## UPDATED BRIDGE WELDING CODE

A NEWLY UPDATED "BRIDGE WELDING CODE (ANSI/AWS D1.5-95)" is now available from the American Welding Society. The specification, prepared in conjunction with AASHTO, describes the welding requirements for welded highway bridges made from carbon and low-alloy steels. The 220-page document costs \$96 and includes a means to regulate welding in steel construction, a section of added rules for bridges and requirements for fabricating fracture critical structures. In addition, it contains information on workmanship, specific processes, qualification, inspection and statically loaded structures.

For more information, contact AWS Order Department, 550 NW LeJeune Road, Miami, FL 33126; 800/334-WELD or **circle no. 122** on the reader service card in the back of this magazine.

## BOLTING TIPS

THE INDUSTRIAL FASTENERS INSTITUTE OFFERS A 15-PAGE BOOKLET on "Ensuring Assembly Integrity: Tips for Specifiers, Buyers and Installers of Mechanical Fasteners." The publication offers information on:

- specifying quality fasteners;
- qualifying vendors;
- reducing costs;
- recognizing quality;
- maintaining lot integrity and traceability;
- following safe, responsible maintenance practices; and
- finding help when you need it;

According to the booklet, "Despite efforts to legislate protection for the responsible purchaser/user of fasteners, there is still ample opportunity for confusion—if not outright fraud—in the marketplace. *There is really only one certainty: you, the buyer or user of fasteners, are ultimately responsible to ensure that the right fastener is specified and that the specified fastener is delivered and installed correctly.*" Among the many examples given in the booklet is that of the confusion between Grade 8 and Grade 8.2 bolts.

Copies of the booklet are available for \$3.75 each, with discounts available for quantities of 26 or more.

Also available is the *Fastener Application Advisory* newsletter. The newsletter, aimed at those who specify or purchase mechanical fasteners, offers a wide variety of information, ranging from an FAA probe of bogus bolts to information on hydrogen embrittlement. Subscriptions to the are \$89 for the first copy, with discounts for additional orders.

For more information, contact the Industrial Fasteners Institute, East Ohio Building, Suite 1105, 1717 East Ninth St., Cleveland, OH 044114-2879; 216/241-1482; fax: 216/241-5901.





# THE DECKING IS STACKED IN YOUR FAVOR.

All the types of premium steel decking you need, rolled to your specific job requirements. Delivered where you need it, when you need it. From six strategically positioned manufacturing/service locations throughout the nation:

- Beech Bottom, West Virginia
- Gary, Indiana
- Lenexa, Kansas
- Houston, Texas
- Fort Payne, Alabama
- Wilmington, North Carolina

Wheeling Corrugating is growing, and our expanded production capacity allows us to provide you with unsurpassed service, delivery scheduling and coordination. For more information on Wheeling's full line of steel decks and our network of service capabilities, give us a call today at the following sales offices: Wheeling, WV, 304-234-2300; Lenexa, KS, 913-888-4900; Houston, TX, 713-674-6737.

  
**Wheeling Corrugating Company**  
A DIVISION OF WHEELING-PITTSBURGH STEEL CORPORATION  
*Since 1890*

Please circle # 99





# A NEW LINK ACROSS THE MISSISSIPPI RIVER

A cable stayed bridge, with the cables arranged in a modified fan pattern, provided both an economical shallow deck structure and an aesthetic appearance

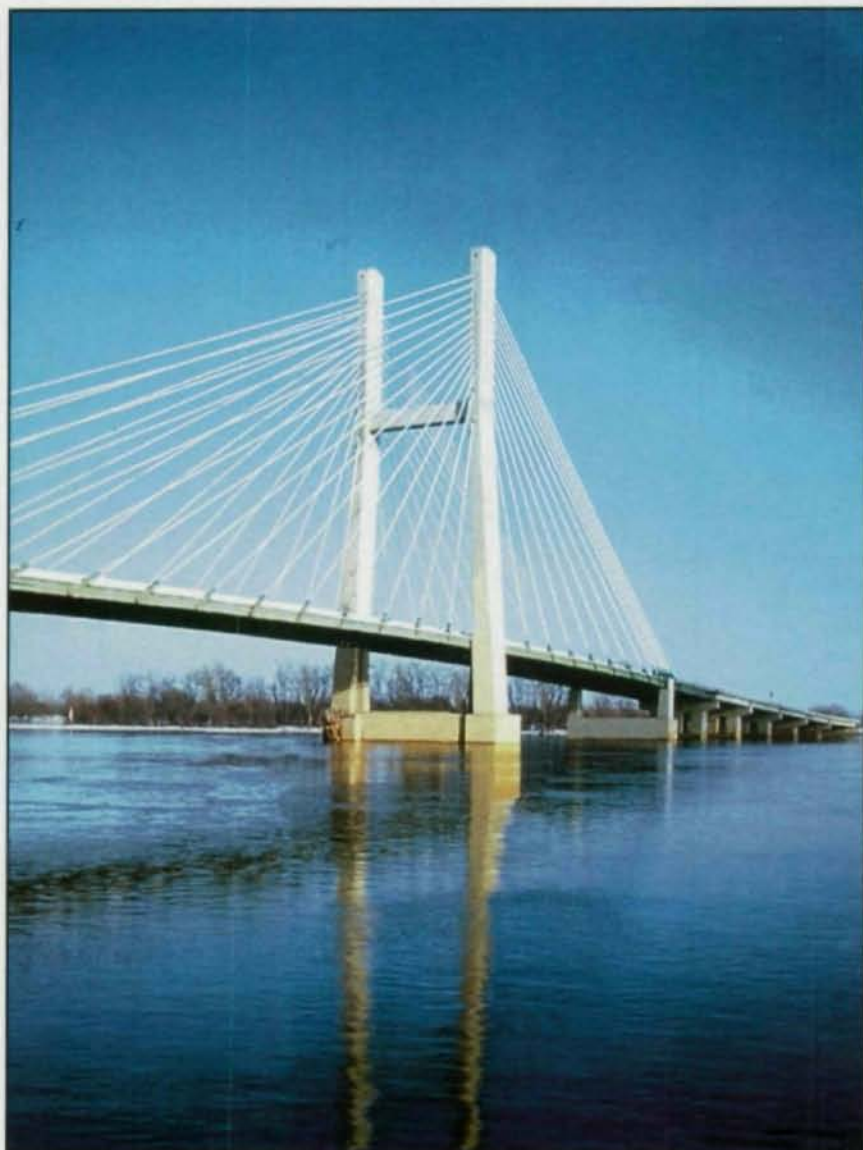

By Ernst H. Petzold, P.E.

**B**Y THE MID-1980S—DESPITE A NUMBER OF EFFORTS OVER MANY YEARS AT REINFORCING AND MODIFYING THE STRUCTURE—it was obvious that a replacement was required for a vintage 1917 Mississippi River crossing at Burlington, IA. In 1984, the Iowa and Illinois Departments of Transportation initiated a study by Sverdrup Corporation of St. Louis to investigate replacement alternatives for the MacArthur Bridge.

The design study developed into the preparation of final plans and specifications by Sverdrup for both steel and concrete alternatives for the cable stayed main spans and girder approaches and also included extensive modifications to the Burlington Interchange. The steel main span option was the alternative selected for construction.

## CABLE-STAYED BRIDGE DESIGN

The bridge is asymmetric with a 660-ft main span and a 405-ft. side span. A third 180-ft. long span is also part of the cable stayed section. The cables are arranged in a modified fan pattern, which provides a compromise between the efficiency of the pure fan arrangement and the practical and aesthetic characteristics of a harp arrangement. To permit the use of a shallow deck structure, which is both economical and attractive, the system consists of a relatively large number of cable stays.



In the transverse direction the two essentially vertical planes of cables are supported by the 'H' shaped tower.

The deck of the cable stayed unit is extremely simple and straightforward. It consists primarily of steel edge girders at about 84-ft. centers, steel floorbeams at 15-ft. centers and precast concrete deck panels. This system is a composite one where the concrete deck participates with both the floorbeams (principally in resisting live load bending moments) and with the edge girders (in resisting mainly dead and live load axial thrusts). The concrete deck also functions as a diaphragm in resisting lateral loads. Longitudinal post-tensioning is used to provide sufficient capacity for the deck to span between floorbeams. The post-tensioning is done prior to effecting the composite connection with the edge girders to prevent the undesirable transfer of the imposed axial force to the steel girders.

A W16 strut under the median barrier is included in the deck system as a construction expedient. The precast deck panels are initially supported on leveling screws bearing on the edges of the floorbeam flanges. During placement of the panels it is possible, therefore, for the floorbeams to be subjected to significant torsional moments. The central strut resists this torsional effect by creating a couple between adjacent floorbeams.

The basic edge girder deck arrangement extends from Pier MS1 to the hinge near Pier MS3. The suspended span between this hinge and Pier MS4 is a conventional multiple steel girder layout with a composite cast-in-place deck slab. A box girder floorbeam at the hinge picks up the reactions from the multiple girder system and transfers them to the edge girders at this location.

The vertical cables are in the same plane as the edge girder webs. This arrangement eliminates the generation of primary

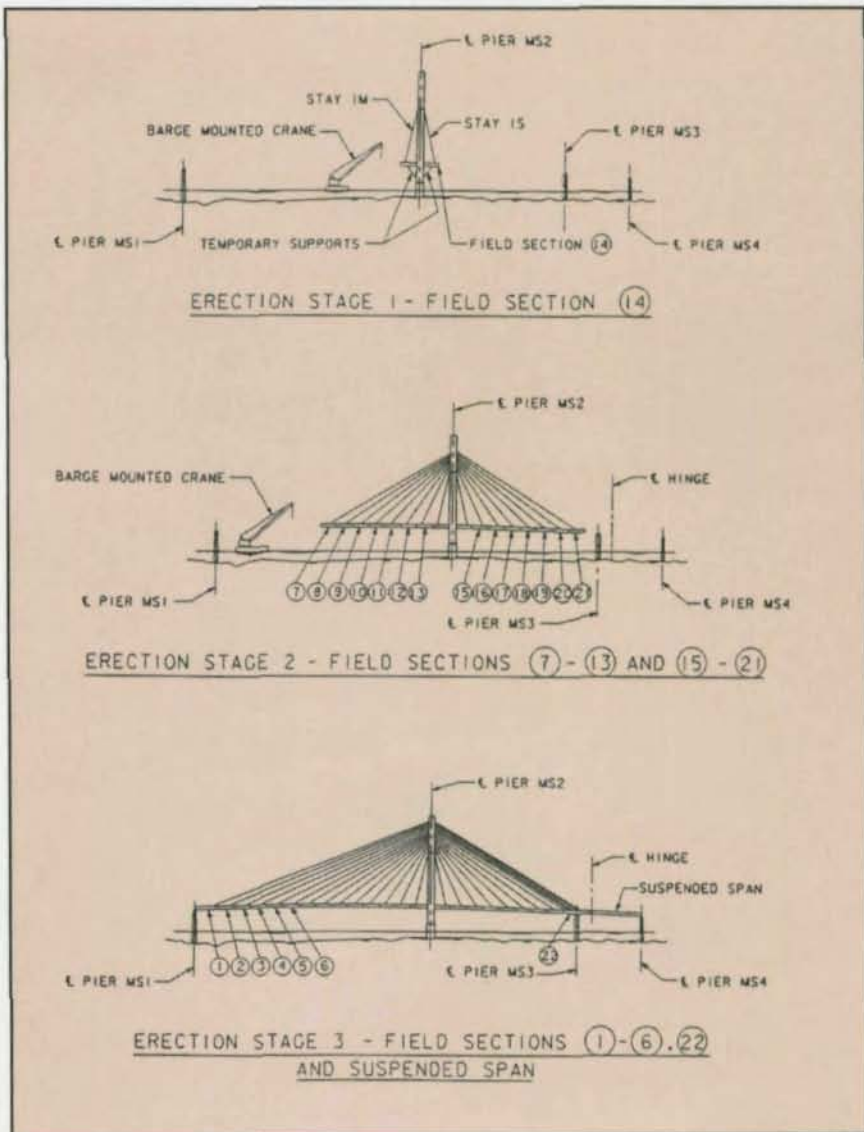





*Cable end connections were assembled to the already erected edge girders and included a temporary deviator for use during installation of the cables (right).*

*During the cantilever erection of the main span, the contractor provided additional stability by the use of temporary support bents in the side span (top).*



torsional moments in the edge girders. The cables are dead-ended at the deck level; all jacking is done at the tower. The deck connection is made via multiple sets of steel plates which transfer loads from the girder

web to the cable. The steel plates pass through blockouts in the concrete deck, around the top flange of the girder and are connected to the girder web using two W14 sections.

The tower is of reinforced con-

crete with post-tensioning being used in the cable stay anchorage area. The tower legs and strut are box sections with wall thicknesses of about 30 and 15 inches, respectively. In the transverse direction the tower acts as a moment resistant frame. The strut dimensions were selected to optimize this frame action. In the longitudinal direction the tower acts as a free standing cantilever with some elastic support offered by the cable stays. Since the tower end of the stays is the jacking end, the interior of the anchorage area was sized to permit the necessary jacking equipment to be placed and operated.

The cable stays consist of 0.6-in.-diameter epoxy coated prestressing strands contained in a grout-filled polyethylene (PE) pipe. The exterior of the pipe is wrapped with a light colored tape after grouting is completed. The stays are anchored in a matrix of epoxy resin, zinc dust and steel balls contained within a forged steel socket. To allow the steel balls to grip the metallic element of the strand directly, the epoxy coating is removed in the socket region. The epoxy resin/steel ball anchoring method was selected for this project for its favorable fatigue characteristics and due to the fact that it permits full prefabrication of the stay. Prefabrication of the stay can be done in an enclosed shop, thereby assuring maximum environmental protection and thorough inspection during fabrication.

#### DESIGN ISSUES

The idealized cable stay system can be thought of as a combination of compression struts (the deck and tower) and tension ties (the stays). Maximum economy is achieved by minimizing the dead load bending moments in the compression elements of the system. The deck moments are minimized by balancing the deck dead weight against the vertical component of each cable. This balancing is accomplished



by appropriate cable geometry which effectively reduces the cable support points along the deck to rigid supports (vertically) for dead load. The tower dead load moments are minimized by balancing the vertical loads left and right of the tower centerline. The 405-ft. side span does not totally balance the weight of the 660-ft. main span, however. The weight of the anchor pier (Pier MS3), which is developed by the use of appropriate hold-downs, and the reaction of the suspended span on the hinge account for the remainder of the necessary force.

Due to the importance of the cable lengths in achieving the desired force distribution in the system it was decided in the design stage that construction of the bridge would be by "geometry". In this system the theoretical cable fabrication length is calculated consistent with the desired final geometry and analysis assumptions. Nominal shims to be used with the as-fabricated cable provide the only adjustment to achieve this theoretical length. Prefabrication of the cable permits its construction to a finite length which is consistent with maintenance of overall geometry. The edge girder length and tower height are also important in establishing the system geometry and these elements are also constructed to predetermined dimensions. However, since these latter elements are not adjustable after construction, it is necessary to determine the precise position of both the deck and the tower cable anchorage work points prior to establishing the final cable shim thicknesses.

#### DECK CONSTRUCTION

While the foundation, substructure and tower construction provided their own unique set of challenges, it is the deck construction which is the most intricate and is described in some detail in this section.

The contract documents included a conceptual deck erec-

## Missouri, The "Show Me" State, Says "Yes" to Transpo



### Transpo T-48 Polymer Concrete, 1/2" overlay, proven success on St. Louis' Orthotropic Steel Deck Bridge.

- High skid resistance, wear resistant, water-proof.
- Resistant to road chemicals.
- Structurally sound, high strength.
- Ultimate pull-off values averaged 500 psi.
- Rapid traffic resumption after overlay completion.

Other Transpo Polymer Concrete Overlays; Patching, Structuring, Sealing and Precast Products are Available.



Fax or send spec's for prompt response.

**TRANSPO INDUSTRIES, INC.**  
20 Jones Street, New Rochelle, NY 10801  
(914) 636-1000 FAX: 914-636-1282

## WHITEFAB INC.

BIRMINGHAM  
ALABAMA

IN ADDITION TO ANGLE, RAIL, PIPE, CHANNEL, AND BEAM ROLLING  
CAPABILITIES, WE ROLL TUBES, CHANNELS, AND BEAMS THE HARD WAY.

Phone (205)791-2011 FAX (205)791-0500

Please circle # 55



# ONE CALL GETS YOU ALL YOUR FASTENERS FOR STEEL FABRICATION & CONSTRUCTION



**ANCHOR BOLTS, PLATE & SLEEVE ASSEMBLIES, TIE RODS, STUDS, SWEDGE BOLTS, U-BOLTS, HEX BOLTS & EYE BOLTS**



Custom fabricated to exact specifications from certified domestic steel up to 4-inch diameter and 40-foot lengths in steel & alloy.

**STRUCTURAL BOLTS, NUTS & WASHERS in A325, A490 & TENSION CONTROL BOLTS, WELD STUDS, CONCRETE ANCHORS, B-7 STUDS, CLEVISSES, TURNBUCKLES and all types of fasteners in various grades and materials; plain, plated and galvanized.**

Stocked for immediate shipment

★ SAME DAY SHIPPING ★  
OVERNIGHT TO MOST U.S. CITIES

## MID-SOUTH BOLT & SCREW

**Central States**  
499 Cave Road  
Nashville, TN 37210  
615-889-8341  
FAX: 615-885-6542  
1-800-251-3520

**East Coast**  
59 Liberty Road  
Emporia, VA 23847  
804-634-0240  
FAX: 804-634-0541  
1-800-366-BOLT

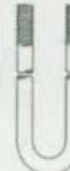
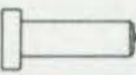
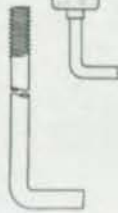

Please circle # 74

## For the BEST in Bridge Software . . .

**WIN-DASH**  
MERLIN DASH FOR WINDOWS

**MERLIN DASH**  
DESIGN OF STRAIGHT HIGHWAY BRIDGES

**NEW!**  
**Get WIN-DASH**  
and receive a  
**FREE BONUS MODULE**  
(a \$1000 Value)  
**CALL!**

- ◆ AASHTO - WSD, LFD (LRFD Analysis)
- ◆ Analysis, Rating, Code Check
- ◆ Optimization by Cost or Weight
- ◆ Auto Live Load - AASHTO and Multiple User Defined Concurrent Live Load
- ◆ Auto RATING FACTORS - Inventory, Operating, Posting, Special Vehicles
- ◆ METRIC/English Conversion
- ◆ Deck Pouring Sequence Analysis
- ◆ Haunched Web, Hybrid, Composite
- ◆ Continuous Spans, Support Restraints
- ◆ Graphics - Moment, Shear, Camber Allow/Actual Stress & Ranges
- ◆ Menu Input - Very Friendly

**DESCUS** DESIGN & ANALYSIS  
CURVED BRIDGES

**SABRE** SIGN BRIDGE  
ANALYSIS DESIGN

**TRAP** TRUSS RATING  
AND ANALYSIS

- ◆ Curved & Straight Bridge Systems
- ◆ Influence Surface Approach
- ◆ T' and BOX Girder Sections
- ◆ Latest AASHTO - LFD & WSD
- ◆ METRIC and English Units
- ◆ Girder Optimization
- ◆ Auto MESH Generation
- ◆ Auto RATING FACTORS - Inventory Operating, Posting, Special Vehicle
- ◆ Complex Geom. - Skewed, Bifurcated
- ◆ Pouring Sequence Analysis Available
- ◆ PC License or Lease, Timesharing
- ◆ Menu-Driven/CAD-Like Features
- ◆ Fast Running (Minutes)

- ◆ Most Types - Tri-Chord, Box Chord Single/Double Cantilever, Other
- ◆ Analysis - Moment, Shear, Torque Displacement, Reaction, Stress
- ◆ Design - Splices, Base Plates
- ◆ Auto Load Cases - Wind (shielding), Ice, DL, User Defined Loads
- ◆ Pull Down Menu/CAD-Like Features
- ◆ Latest AASHTO Code Checking

- ◆ NEW - AASHTO LRFD and LFD Spec.
- ◆ Cable Member Prestressing
- ◆ Most Truss Types Considered
- ◆ Analysis, Design, Rating, Rehabilitation
- ◆ Auto RATING FACTORS - Inventory, Operating, Posting, Special Vehicles
- ◆ Automatic Group Load Combinations
- ◆ Simple or Continuous to 6 Spans
- ◆ Pull-Down Menu/CAD-Like Features

Available Exclusively Thru:

## OPTI-MATE, INC.

P.O. Box 9097 • Dept. A  
Bethlehem, PA 18018

Tel 610-867-4077  
Fax 610-865-1030

Free Trial...  
**FULL PROGRAM**  
(No Deposit)

Please circle # 53

tion sequence. As designed the edge girder consists of a number of sections. These field sections correspond to the length of edge girder between adjacent field splices. These sections are generally 45 feet long and include the connection of one cable stay. Exceptions occur for section 14 (at Pier MS2, which includes two cable connections) and section 22 (at Pier MS3, which provides for the connection of five backstays).

Three primary erection stages were identified. Stage 1 consisted of the erection of the pier table, section 14, at Pier MS2. Stage 2 consisted of the balanced cantilevering of sections sufficient to reach Pier MS3. Stage 3 involved the completion of the major deck structure by erecting section 22 at Pier MS3, the suspended span structural steel and concrete deck and then completing the main span by free cantilevering to Pier MS1. This stage is, perhaps, the most intricate one since it involves the progressive inclusion of the mass of Pier MS3 and the suspended span to balance the increasing weight of the main span.

The proposed sequence for the typical free cantilevering of a section consisted of the following major steps (numbers in parentheses refer to items in the figure on the top of the opposite page):

1. Erect edge girders and floorbeams (1), cantilevered from previously completed section.
2. Erect and partially stress cable stays (2).
3. Place north and south precast panels 'A', followed by panels 'B' and 'C'.
4. Use adjusting screws on panels to set panels to the proper elevation.
5. Place longitudinal post-tensioning bars (3) and couple to stressed bars in previously completed section.
6. Place longitudinal and three cast-in-place joints (4). Joints over the edge girders are not placed at this time.



7. Stress the longitudinal post-tensioning bars.
8. Install shear studs on edge girders through stud pockets (5) provided in precast panels. Grout all pockets behind the stay cable just erected.
9. Stress the north and south cable stays to final length.

As noted, the sequences presented in the plans were conceptual and the contractor was required to verify the applicability of the given information to his desired method of construction. The design had been reviewed for general conformance with the concepts but, as is typical for U.S. practice, detailed design and step by step verification of the erection operations were the responsibility of the contractor.

With one exception the contractor elected to follow the general concept as presented. The aerodynamic studies for the bridge during the construction stages were not completed prior to the completion of final design. These studies did indicate a potential for the tower capacity in bending to be exceeded during Stage 2. Based on his analysis of these reports (all aerodynamic studies were furnished to bidders) the contractor decided to place falsework bents in the 405-ft. side span to provide the desired stability. The construction engineer did, of course, do a step by step analysis of the erection to predict both stresses and geometry at all construction stages. The construction engineer also confirmed that the proposed sequence would achieve the specified geometry and, additionally, predicted final member stresses.

The steel erector chose to erect the steel members (two edge girders and three floorbeams) of a typical section as a complete unit. This had benefits for the schedule, worker safety and maintenance of desired geometry. These elements had been shipped from the fabricator in Des Moines to the erector's facility in Wickliffe, KY, where

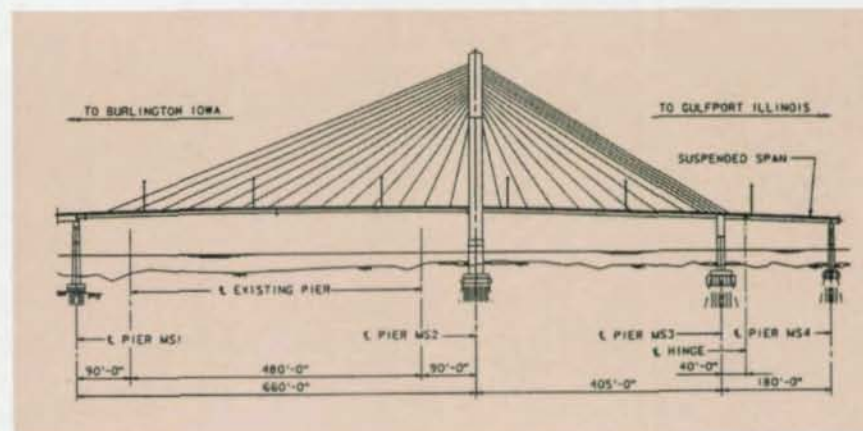
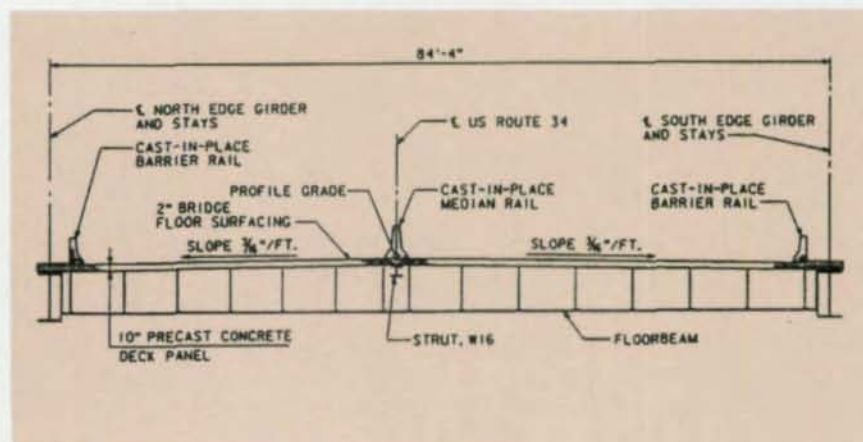
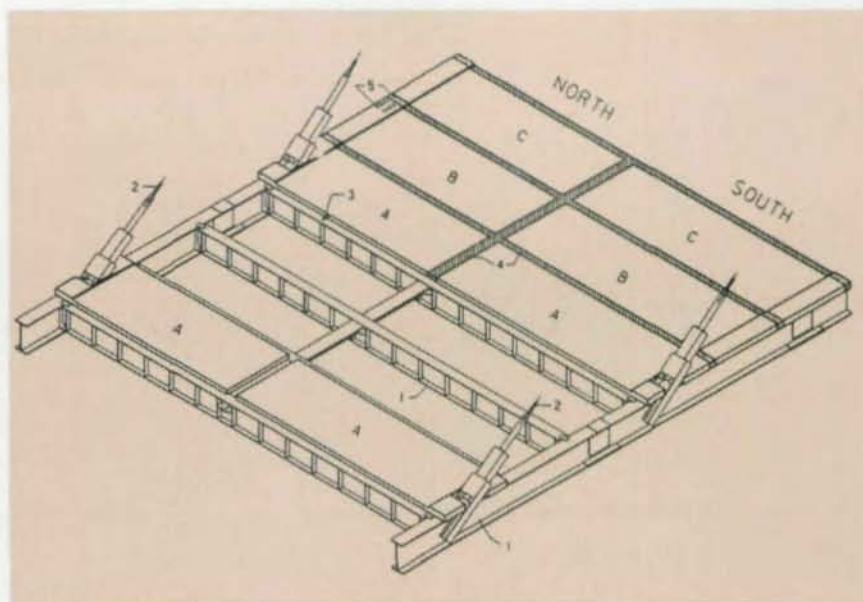

they were assembled on barges and ultimately returned up the Mississippi to the project site. Fabricator on the project was AISC-member Pitt-Des Moines, Inc. Other team members included: Leonhardt, Andra und Partner (consultant for the cable stayed spans); Wells Engineers

(designers of the steel superstructure alternate for Iowa and Illinois approaches); Johnson Brothers (contractor for Illinois approach and substructure for the cable stayed unit); Edward Kraemer & Sons (contractor for superstructure for cable stayed unit, Iowa approach and inter-





change modifications); John F. Beasley (erector of cable stayed unit); Buckland & Taylor (construction engineering for cable stayed unit); VSL Corp. (Cable fabrication); and Raider Precast (concrete deck panel fabrication and fabrication of precast concrete girders for Illinois approach).

The cable stays were fabricated at a facility in Burlington just south of the bridge site. The completed cables were reeled onto spools and delivered to the bridge on barges. For the shorter cables near the tower the cables were uncoiled directly from the barges for installation. For the longer cables the spools

were placed directly on the deck. For these cables the unreeling was accomplished through a coordinated operation using a crane to lift the cable end and a reel carrier to simultaneously uncoil the stay as it moved along the deck.

The cable dead end connection was not preassembled to the edge girders. Rather, these connections were erected with the cable stays. The dead end socket was bolted into the connection and the complete assembly was hauled out to the attachment point on the edge girder. A temporary cable deviator was also used at these locations.

*Ernst H. Petzold, P.E. is Market Principal—Bridges for Sverdrup Civil, Inc., St. Louis, MO. He was Group Leader for the steel alternate design of the Great River Bridge and also served as Deputy Project Manager.*

## DESCON

### DESIGN AND DETAILING OF STEEL CONNECTIONS

- Seated Beam, Framed Beam, End Plate, and Single Plate Shear Connections
- Moment Connections with End Plate, Bolted or Welded Flange Plates, Bolted T-Section, Beam Flange Directly Welded to Column Flange
- Moment Connection to Column Web
- Continuous Beam across a Girder or Atop a Column
- Beam Shear and Moment Splices
- Column Web Stiffeners and Doubler Plates

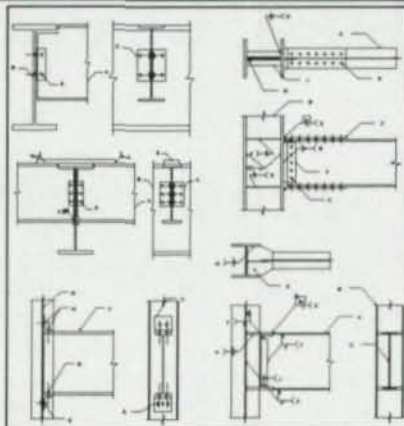

- You can design connections in seconds using DESCON.
- You can import DESCON's graphics output into your CAD system.
- You can learn how to use DESCON productively in minutes without any effort.



- This new version of DESCON at an incredible price is a must for everyone designing steel connections.

Ask for a Free Demo Disk  
**OMNITECH ASSOCIATES**  
 P. O. Box 20792, Oakland, CA 94620  
 (510) 658-8328 Fax: (510) 595-0373

Please circle # 52

## 3D Structural Analysis & Design for Macintosh

Now for PowerPC

The graphical interface you've always wanted, with the advanced analysis power you really need.

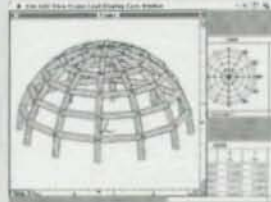

- ✓ Dynamic Analysis
- ✓ Interactive 3D Modeling
- ✓ Rendering & Animation
- ✓ Code Checking
- ✓ True Mac Interface

Graphic Magic Inc. 180 Seventh Ave #201 Santa Cruz CA 95062  
 Tel (408) 464 1949 Fax (408) 464 0731



# Multifranco

Please circle # 92



# RIBBON OF STEEL



**A twin trapezoidal steel box girder composite superstructure was the winning design in an international competition to select a replacement bridge in Maryland**

By Thomas Jenkin, P.E.

**A**N IMPORTANT SITE, COMBINED WITH KEEN PUBLIC INTEREST, led the State of Maryland to conduct an international competition to select the design for a new bridge to replace an existing crossing of the Severn River at Annapolis, MD. The importance of the site, together with keen public interest in the project justified the unusual design competition. The new bridge, which opened in November 1994, features a twin trapezoidal steel box girder composite superstructure that is fully continuous over 17 spans as it follows a complex curved alignment for more than one-half mile. This "ribbon of steel" has won critical acclaim and the approval of the surrounding communities.

## BRIDGE SITE

The bridge spans the Severn River, one of Maryland's most scenic rivers, near its mouth at the Chesapeake Bay. The crossing serves as the eastern gateway to Annapolis, the capital of Maryland and home of the United States Naval Academy.

Annapolis is noted for its fine colonial-era buildings including the Maryland State House which has an octagonal dome visible from the bridge. The narrowing of the Severn River at the bridge site has made this location a road crossing since colonial times. Ferry service originally prevailed until replaced in the nineteenth century by a timber trestle with a swing span. The trestle was replaced in 1924 with a double leaf bascule bridge and arch-shaped approaches. This handsome two lane bridge was a familiar landmark for the surrounding communities; however, automobile and river traffic both grew such that frequent bridge openings became the source of substantial traffic backups. The physical condition of the bridge had also deteriorated such that a major rehabilitation would be required for its continued service. The Maryland State Highway Administration determined that replacement of the bridge with a fixed crossing was the best course of action to accommodate the future needs of both highway and marine traffic. The prominence and importance of the bridge site as well as the

desire to have an outstanding design for the replacement structure provided the stimulus for a design competition.

## DESIGN COMPETITION

The design competition was jointly sponsored by the Maryland State Highway Administration and the Maryland Governor's Office of Art and Culture. The competition was conducted in two stages. For the first stage, those interested in participating were invited to submit their qualifications and three to five examples of previous bridge designs. The 21 responses were received from engineering firms throughout the United States and from Western Europe. These submissions were reviewed by a selection committee, and six contestants were chosen to be finalists.

For the second stage of the competition, each finalist prepared a preliminary design including plans, cost estimates, an engineering report which included preliminary calculations, a narrative description of the design concept, a detailed cost estimate, and several renderings of the proposed struc-



# TO MAKE SURE OUR TENSION

## CONTROL SYSTEMS

# OUTPERFORM THE COMPETITION,

# WE PUT A HEX ON THEM.



Our Tru-Tension® bolt was designed with one very important advantage over other twist-off bolts: a hex head. So removing this bolt or checking the installation with a torque wrench is just as easy as installing it.

Using a quiet, hand-held power tool, our Tru-Tension system always provides the correct tension. It also eliminates operator error during assembly, the bolts come pre-assembled and you can even save money thanks to the quick, easy installation and lower costs for visual inspection.

But, install any button head fastener compared to our hex head fastener, and there's no turning back. Because it's almost impossible to remove a button head fastener, you may even need a welder to burn it off. That costs you time and money. If you'd installed our hex head bolt in the first place you could remove it with a simple, four dollar wrench.

What if you have to verify the proper installation of a button head bolt? Again, it's almost impossible since you can't even get a wrench on the head to test or remove it. But you can verify installation of our hex head bolt with the turn of a wrist and a calibrated torque wrench.

Clearly, this is one bolt that won't let you screw up. Our Tru-Tension system is also fully traceable to our domestic sources, like all Nucor fasteners. They're fully tested and certified, including compliance with FHWA, DOT and AASHTO specifications for bridge construction.

So, forget about cutting bolts off with a torch if something goes wrong. Call us at 800/955-6826, FAX 219/337-5394 or write PO Box 6100, St. Joe, IN 46785 to find out more about our Tru-Tension system. And get a fastener that has a good head for business.



**NUCOR FASTENER**

A Division of Nucor Corporation

Please circle # 38



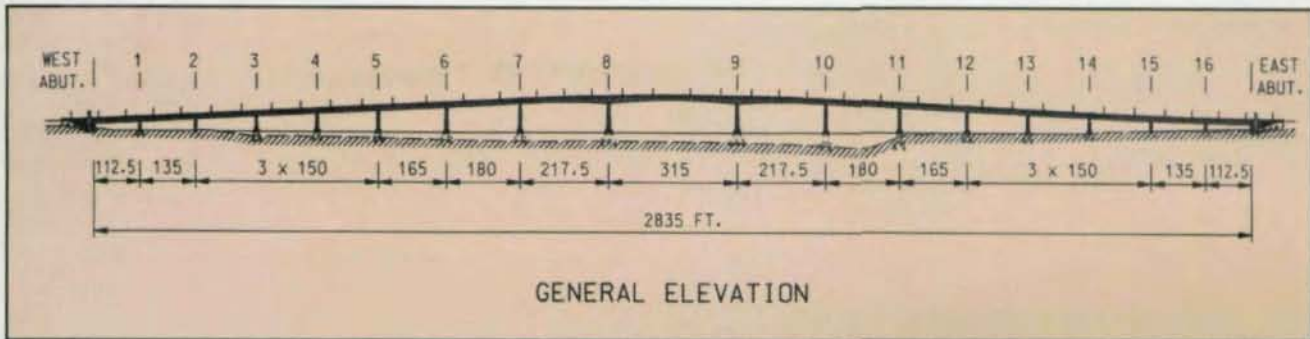

ture. Five of the six finalists submitted complete design packages in September of 1989. The identity of the designer of a particular submission was kept confidential and not shown on the submitted documents nor revealed to those reviewing and judging the entries.

Each entry was reviewed by two technical committees prior to presentation to the jury. A panel of bridge engineers critiqued the designs for technical merit while a separate group of experienced contractors provided independent construction cost estimates and assessed the constructability of the various proposals. In addition, a series of photo-montage renderings was created for the various entries to provide an objective visual comparison of the competing structures. The five finalists' entries included two concrete arch type bridges, one concrete cable-stayed bridge, and two bridges based on composite steel box girders for the superstructure. The 14 jurors provided a broad range of backgrounds and included practicing design professionals as well as representatives of state agencies, local governments and the surrounding communities. During three days of judging, the jury toured the site and received reports on the findings and opinions of the two technical committees. The jury carefully reviewed the entries and evaluated each relative to the technical, functional, aesthetic and economic goals which were established for the new bridge. The jury, by an "overwhelming majority" vote, then selected the entry submitted by

Greiner, Inc., Timonium, MD, as winner of the competition. In addition to selecting the winner, the jury also provided comments on all of the designs as well as recommendations for further refinement of the winning proposal.

Greiner developed their entry in conjunction with Leonhardt, Andra, and Partner of Stuttgart, Germany. The two firms have collaborated on several major bridge projects in the United States and Asia. Greiner was subsequently engaged by the State Highway Administration to prepare preliminary and final designs and contract documents for construction of the new bridge based on their winning proposal.

**BRIDGE LAYOUT**

The bridge is aligned on large radius curves with spiral transitions. From the west abutment on the Annapolis side, the roadway first curves right and then reverses to a long central curve which connects with the eastern approach. The curved alignment was necessary to maintain traffic during construction and avoid conflicting with an electrical substation located on the western bank of the river. Allowing pedestrians and drivers to view the structure from the approaches, the continuous, large radius curves enhance the visual flow and interesting geometry of the



bridge. Spiral transitions, necessary for future construction of a light rail transit line, further smooth the graceful sweep of the structure.

The profile of the bridge allows 75 ft. of vertical clearance over the 140-ft. navigation channel, and the higher level of the approaches and longer spans effectively open the river and allow recreational sailboats new access.

At its eastern end, the bridge widens for a signalized intersection on the approach roadway and crosses the entrance to a park area. Beyond the intersection, the approach rises to a scenic overlook which has long afforded a spectacular view of the river, the Naval Academy, and Annapolis.

**SUPERSTRUCTURE**

The superstructure of the bridge is continuous over all seventeen of the structure's spans with a total length of 2,835 ft. between abutment bearings. The span arrangement is symmetrical with respect to the center of the 31-ft.-long navigation span. The approach span lengths vary with the structure's height so that the span-to-height ratio is



# RAMSTEEL Asks: "How Much Time Do You Spend On These Tasks?"

See how RAMSTEEL can help you  
do this work in a fraction of the time!

30-DAY TRIAL AVAILABLE



INTEGRATED ANALYSIS,  
DESIGN AND DRAFTING OF  
STEEL BUILDINGS

**Ram Analysis**  
5315 Avenida Encinas,  
Suite M, Carlsbad, CA 92008  
Tel 800-726-7789  
Fax 619-431-5214

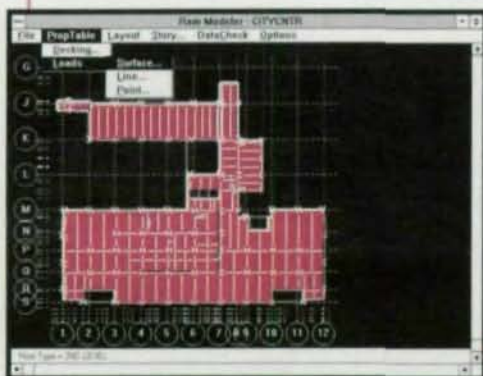

Please circle # 81

## CALL TODAY FOR YOUR FREE DEMO KIT!

### STRUCTURAL MATERIAL MANAGER 5.0

SMM 5.0 gives fabricators and detailers the fastest, most accurate material list manager available. No more time-consuming manual calculations!



ASSOCIATE MEMBER

The software's speed and efficiency delivers an easy-to-use system that's second to none. Call today for a FREE, no-obligation demo disk with all modules and the complete system's user's guide.

Let SMM 5.0 turn your next material list into hands-off experience!

- Main Module computes weights, surface areas, bolt counts & lineal totals
- Length-Nesting module produces optimal cut lists from in-house stock, vendor stock or the best combination of both
- Plate-Nesting Module draws the best layout for cutting plates from stock sheets
- Estimating Module tallies material costs, shop hours & field hours
- Production-Control Module prints shipping lists, loading tickets & job status reports

**E.J.E. INDUSTRIES, INC.**

287 Dewey Avenue, Washington, PA 15304

1-800-321-3955 or 412-228-8841

# HANDS-OFF EXPERIENCE.

Please circle # 46

kept reasonably uniform.

The composite superstructure has a reinforced concrete deck carried on two widely-spaced trapezoidal-shape steel box girders. The deck width is 55-ft. and furnishes two 12-ft. roadways with shoulders, sidewalks, and parapets. Slab thickness varies with a straight taper on the 9-ft.-6-in. cantilever and a parabolic variation over the 20-ft. span between the girders. On the eastern bridge end the deck width widens to 64-ft. As the bridge width increases, each girder stays parallel with the adjacent slab edge keeping a uniform overhang while the span between girders increases to 29-ft. This increased deck span is structurally accommodated by a general thickening of the slab between the boxes.

The bridge parapets include a six-course brick band on their roadway faces, connecting with the colonial-era structures of the city. The upper fascia surfaces of the parapets are inclined to increase their brightness in sunlight, and an offset cap creates a shadow line. Low level decorative lighting fixtures at relatively close spacings illuminate the roadway at night and form a string of lights across the sweep of the bridge. Aesthetic under-bridge lights also illuminate the inner surfaces of the piers and box girders and gives the structure a warm glow of reflected light from the river's surface.

Trapezoidal steel box girders were chosen as the main structural elements since this form best satisfied the functional and aesthetic objectives of the design. The lack of exposed bracing and stiffening gives the bridge underside an uncluttered appearance, while the proportions of the boxes strongly express their support of the bridge deck. For most of the structure's length, the girder depth is uniform with sloping webs providing 6-ft.-8-in. depth between the flanges. At the center span the web depth is doubled to 13-ft.-4-in. over the channel piers to carry the longer



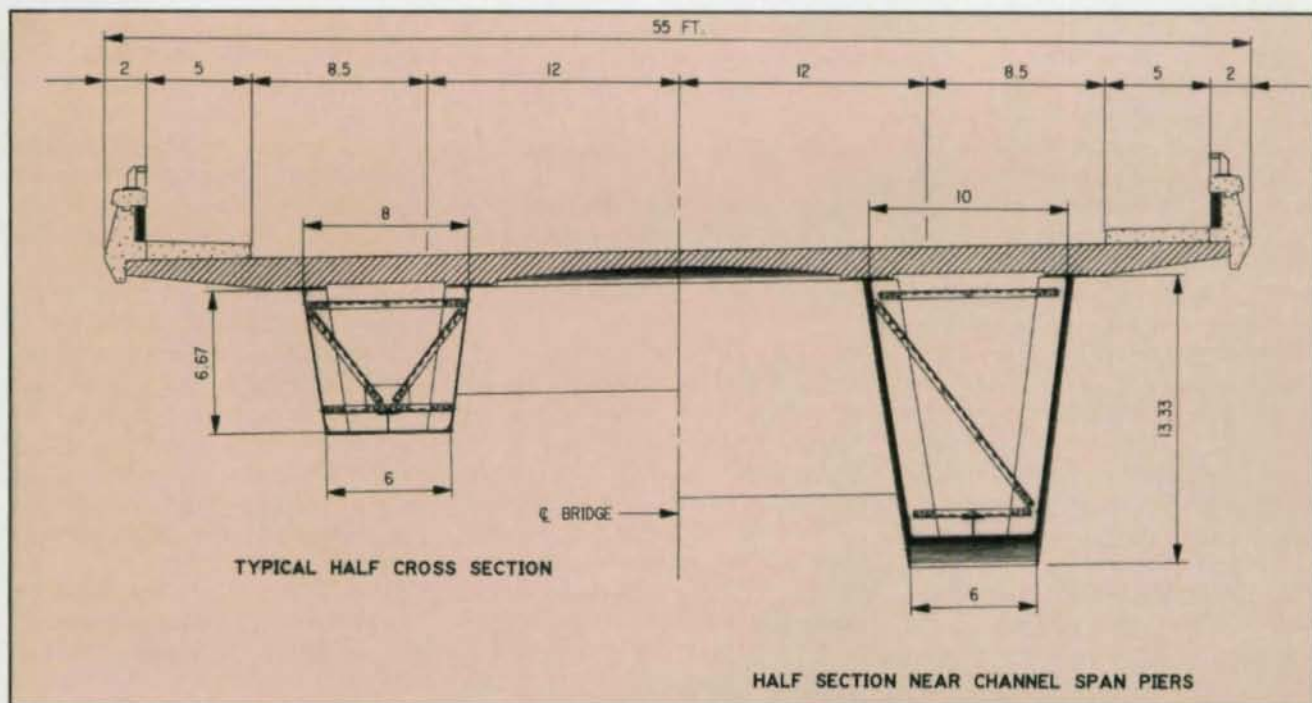

span. The girder's profile in this region has a parabolic variation.

As the girder depth increases, the spacing of the webs at the lower flange and the inclinations of the webs have been kept constant. The spacing of the top flanges thus reflects the parabolic web shape, gradually increasing from 8-ft. to 10-ft. over the main piers. The web planes slightly fold over internal diaphragms at the piers again reflecting the plane changes of the lower flange as it crosses the pier. This shaping of the webs is subtly revealed by a gently rising shadow line from the reduced cantilever overhang. The unusual web geometry gives a well-ordered enlargement of the box girder's proportions in recognition of the increased structural demands.

At each pier, the two main boxes are connected by short transverse composite boxes. These smaller connecting members have vertical webs set at three-quarters of the depth of the main girders. These members provide torsional support since each main girder is placed on a single bearing.

At the abutments, the transverse diaphragms are enlarged

and the steel sections completely closed by full width top flanges. These stiff members equalize the end rotations of the two main girders and give bending continuity to the girder ends through a torsional link. By coupling the two girder ends and using a relatively short span length, the redundancy of the end spans is greatly improved.

The box girders were fabricated from ASTM A709 Grade 50 material. The lower flange is stiffened against buckling with a single T-shaped stiffener at its center. Cross frames, positioned near the ends of each girder field section and at intermediate spacings up to 21-ft.-6-in., stiffen the boxes against distortion. At the piers, the girders are stiffened by

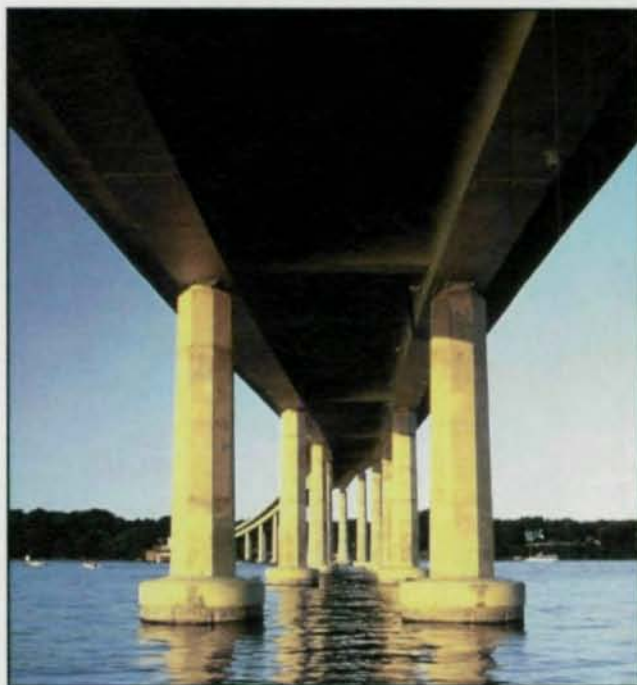

two internal plate diaphragms aligned with the webs of the transverse connecting boxes. Angles connected directly to the top flanges form an upper lateral bracing system. This bracing closes the box for torsional loads during construction of the deck slab. Temporary cross frames located between the girders near field splices also stabilized the boxes as the deck was built and



were later removed.

The superstructure reactions are all carried by multi-rotational bearings with stainless steel spherical segments fixed to the top of the substructure. Longitudinal restraint of the bridge is through the two fixed channel piers. Expansion and contraction of the superstructure between these fixed connections is accommodated by flexing the channel piers. Bearings for the approach piers and above the abutments have horizontal sliding surfaces, transversely restrained, but free to move longitudinally along the local bridge tangent. This bearing layout allows bridge movements without developing significant lateral bearing forces because of the large radii used for the bridge alignment and the relatively flexible lateral elastic support from the columns. The arrangement of the bearings maintains vertical force alignment on the

column as the boxes move position. Detailing of the internal stiffening of the box carries the variable load position with a grillage of stiffeners connected with the girder webs and the two transverse internal diaphragms. Modular expansion joints provide 18-inches of movement capacity at each abutment.

#### SUBSTRUCTURE

Each pier has two octagonal-shaped tapered columns directly supporting the girders. Transverse structural interconnection at the top of the columns is maintained through the bearings and superstructure. The column bases are supported above the water's surface by concrete pedestals which extend to the pier's foundation at the river bottom. For the main channel piers, the columns have a pronounced lower flair accenting the main span and its arched shape, as well as reflecting the impor-

tance of these columns as the fixing points for the structure. The concrete pedestals are granite-faced through the water's surface to enhance durability and compliment the granite used for nearby structures of the Naval Academy. The last two spans at each bridge end are over land, and pedestals are omitted.

Granite-facing is also used at the abutments which have concrete pilasters similar to the pier columns. Two imposing Georgian-style pylons, built of white concrete, flank the roadway at the abutments and create an entrance for the bridge. Bronze medallions with the Maryland state seal are mounted on the pylons. The wingwalls and parapets flair out to terminal posts with a similar style and color as the pylons.

#### CONSTRUCTION

Bids for construction of the bridge were received in

## RISA-3D *Setting the Standard*

Is *value* important to you when selecting structural software?

If so, you'll want to know that **RISA-3D** scored a *10* out of *10* rating for cost vs. benefit in the October '94 issue of *Structural Engineering Forum* magazine.

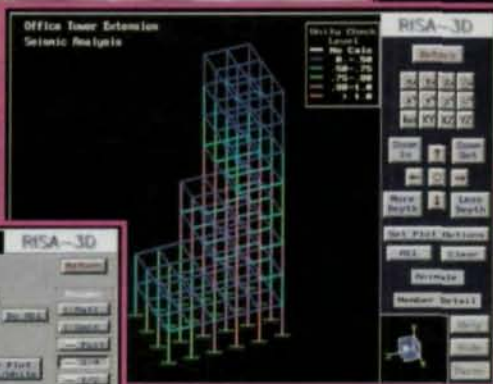
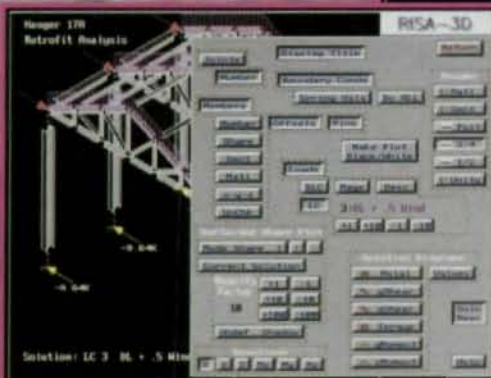

The best software isn't always the most expensive software!

**RISA-3D** is setting a new standard for quality vs. cost. Try our demo and see for yourself just how good structural design software can be!

*Call or Fax us for a Free Demo*

**RISA**  
TECHNOLOGIES

26212 Dimension Dr. Suite 200  
Lake Forest, CA 92630  
Voice: 800-332-7472  
FAX: 714-951-5848

Please circle # 40



November, 1991. The project was awarded to AISC-member Cianbro Corporation of Pittsfield, ME, which offered the best price from a field of 13 contractors. Cianbro's bid of \$33.4 million included construction of the new bridge and approach roadways, as well as removal of most of the old bridge and conversion of a more recent portion of the old bridge into a recreational fishing pier. The bid price for the structural steel was \$8.94 million.

Shop drawings were prepared by AISC Associate-Member Tensor Engineering, Indian Harbour Beach, FL; bearings and expansion joints were supplied by AISC-member D.S. Brown, Inc. of North Baltimore, OH.

Following construction of the piers and abutments, Cianbro erected the 60- to 90-ft. long box girder field sections starting with the three spans in the cen-

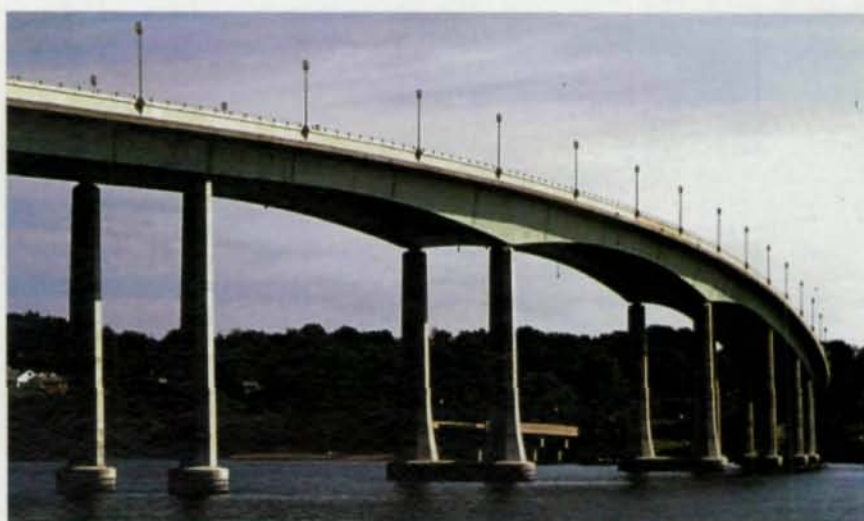

ter of the bridge. Temporary frames attached to the pier columns stabilized the first girder sections as they were centered over the columns. Each 217-ft.-6-in. approach span girder was then completed as two sections were first spliced together and then lifted and connected with the sections over the piers. Once

a span was in place, additional field sections were added to extend each box cantilever in the center span. The center sections of the main span were then lifted and connected with one cantilever while supported by temporary hangers from the other cantilever. To close the last connections in the center span,

## Making the Difference When Performance, Reputation and Quality Count.

- FULL TRACEABILITY
- LOT CONTROL
- CERTIFICATIONS

Registered head markings on all structural and machine bolts.



All products made from steel melted and manufactured in the U.S.A.



### St. Louis Screw & Bolt Company

6900 N. Broadway St. Louis, MO 63147 U.S.A.

1-800-237-7059/(314)389-7500/FAX (314)389-7510



Associate



# UPDATED COMPREHENSIVE DIAPHRAGM DESIGN MANUAL



SECOND  
EDITION

A reference source that  
contains the answers to all  
of your questions!

**FOR PRACTICING  
ENGINEERS & ARCHITECTS!**

Organized For Easy Use/Explicitly Illustrated

## EASY REFERENCE TO

- Diaphragm Strength
- Diaphragm Stiffness
- Connections
- Concrete Filled Diaphragms
- 62 Pages Filled with Shear Diaphragm Examples
- Complete Guide to Symbols and References
- Complete set of Load Tables for Typical Panel Configurations and Connector Types
- Typical Fastener Layout
- Warping Factor Development
- D-Values for Warping



**DON'T DELAY—ORDER YOURS TODAY!**

Send checks; postal, world money orders, drafts, in U.S. currency.

### Quantity

_____	2ND. EDITION DIAPHRAGM DESIGN MANUAL, \$55.00 ea.	_____
_____	1st. Edition Diaphragm Design Manual, \$30.00 ea.	_____
_____	Steel Deck Design Manual, \$25.00 ea.	_____
_____	US Currency Total	_____
_____	Add 15% for Handling	_____
_____	Add on for Airmail	_____
_____	Total Enclosed	_____

**STEEL DECK INSTITUTE, INC.**

P.O. BOX 9506, CANTON, OHIO 44711 ■ (216) 493-7886

Please circle # 77



Cianbro first placed a temporary load of 115 tons on the nearer approach span, elevating the cantilever and reducing the slope discontinuity between the two sides. The contractor then simultaneously pulled the girder sections together using hydraulic jacks and temporary brackets attached to the web plates. This jacking closed a gap of approximately 1 1/4-in. and aligned the top flange connections, which were then fastened together.

Next, cranes lifted the cantilever sides of the joints until the remaining gaps in the bottom flanges closed and these connections were bolted. The jacks and brackets were then removed and the web splices completed. The cranes released the girders, and the temporary hangers and the temporary loading were subsequently removed. Closing operations resulted in inward deflections of the channel pier columns, which would later be restored to vertical with construction of the deck.

Following main span closure, Cianbro erected the balance of

the approaches over the river by lifting pre-spliced sections extending the girders by complete spans with each lift. Over land, steel erection proceeded using smaller equipment and false work towers. The superstructure was completed by sequenced placement of the deck working from the center of the main span towards the bridge ends.

At the west end of the bridge, the two land piers and three spans they supported were constructed in stages to maintain traffic. Temporary supports at the piers and abutment provided torsional support for one box as its share of the deck was built and opened to two lanes of traffic. After removing conflicting portions of the old bridge, the pier foundations were widened, the missing columns constructed, and the second box completed. This staged construction demonstrated the techniques proposed for future redecking.

The new bridge was officially opened in November, 1994, and named the United States Naval Academy Bridge in honor of the venerable institution which has stood for 150 years beside the crossing on the western bank of the Severn River.

*Thomas Jenkins is vice president and chief bridge engineer with Greiner, Inc., Timonium, MD.*



# OUR LATEST IDEA IN STEEL IS FULL OF HOLES.



Introducing new Castelite Steel Beams—the latest from Chaparral Steel. Stronger, lighter, and better looking, Castelite beams provide the ultimate architectural alternative for large, open-spanned areas.

Made from 100% recycled material, Castelite Beams have a high strength/weight ratio, making them perfect for supporting light and moderate concentrated loads, minimizing the need for costly reinforcement. The holes also allow for easy electrical, sprinkler, and mechanical service.

Castelite Beams are made by cutting a hot-rolled beam with computer-controlled, plasma-arc torches. Then, the beam halves are separated, staggered, and welded together. The resulting Castelite Beam weighs the same but is deeper and much stronger than the original hot-rolled beam.

If you'd like to find out more about this new, cost-effective idea from Chaparral Steel, give us a call at (800) 775-4611. We'll be happy to show you how an idea that's full of holes can solidify and beautify your next construction project.

**castelite**  
steel products

*A Chaparral Steel Company*



# SLOPING LEGS KEEP BRIDGE PIERS ABOVE WATER

Since the Occoquan Reservoir is a primary source of drinking water, it was essential for quick approval that a new bridge's piers be kept out of the water

By John D. Anderson, P.E. & David A. Charters, Jr., P.E.

LOCATED APPROXIMATELY 25 MILES SOUTHWEST OF WASHINGTON, DC, the population of Prince William County (PWC), VA, has tripled to 235,000 people in the past 20 years. Unfortunately, though, prior to this year there were only two east-west connector roads in the county and both were winding two-lane roads, with alignments following old colonial routes. Traffic on these roads slowed to a crawl for three hours each day during the morning and evening peak rush hour periods, and they became very dangerous. There have been as many as nine fatalities along one 7-mile stretch of road during a single 10-month period.

The Prince William Parkway (PWP) was conceived by PWC to connect I-95 and U.S. Route 1 in Woodbridge to 166 in Manassas, a distance of approximately 18 miles. The PWP would help relieve traffic congestion on Davis Ford Road.

PWC retained Parsons Brinckerhoff (PB) to design an 8.5-mile section of the PWP on a new alignment through undeveloped, wooded terrain, and to administer its construction. The Prince William Parkway Bridge over the Occoquan Reservoir in Manassas, VA, is approximately at the center of this section.

## BRIDGE DESIGN

The Occoquan Reservoir is a source of drinking water for









# Curved & Straight Steel Bridge Design

## ASD, LFD, LRFD

### Integrated Girder and Bracing Design

Complex grid and roadway geometries, plate and box girders, rolled shapes  
Influence surface (grid) or influence line approach (grid or line girder)  
Powerful nonprismatic girder optimization processing (curved and straight)  
Latest AASHTO Specification, English & metric units including conversion

Demos and 30-day trials available

# MDX software

Phone (314) 446-3221  
Fax (314) 446-3278  
BBS (314) 446-3399  
(area code 573 as of 1/1/96)

Please circle # 120

## The Practical Solution to Designing Metal Stud Framing

# C-STUD ANALYZER II

Metal Stud Systems introduces **C-STUD ANALYZER II™** for Windows, a design aid that eliminates the time consuming task of AISI Specification review and dependence on manufacturer's literature.

Two programs in one. Use your existing analysis software to determine member forces or use the integrated beam analysis program.

### Input Beam Parameters

- Up to 6 uniformly loaded spans & overhangs, 8 point loads, applied axial load, bridging spacing & deflection limits

### Input Framing Parameters

- Select from a "Generic" data base of stud profiles that reflects the majority of sections available today. Components are defined by depth, flange width, steel thickness & yield, punched or unpunched web, single, boxed or "I" shaped configurations

**C-STUD ANALYZER II™** verifies or disproves the framing selection in accordance with the 1986 edition of the AISI Specification for the Design of Cold Formed Steel Structural Members, with 1989 addendum.

### USER MANUAL INCLUDES PROGRAM DOCUMENTATION PLUS:

- Summary of Section Properties
- Expanded Section Properties
- Web Crippling Capacities
- Written Specification Guideline to Generic Sections

### Metal Stud Systems, Inc.

76 Cranbrook Road—Suite 184, Cockeysville, MD 21030

Phone (800) 683-3235 ■ (410) 683-1407

VISA / MC & AMEX Accepted

Demo disk available.  
Call or write for details.

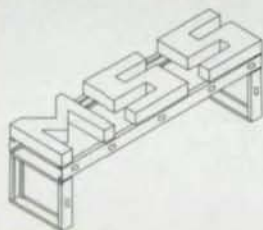

The two massive concrete piers are battered and skewed and have a "fractured fin" architectural treatment on the side facing the river. They are 150 ft. long, 11 ft. wide at the base of the wall, and 25 ft. high from the bottom of the footing to the bearings.

The superstructure includes 13 three-span continuous steel frames. Each frame consists of the two sloping steel pier legs field-welded to the steel plate girders. The depth of the plate girders varies from 4 ft.-2 in. at the abutments to a maximum of 6 ft.-11 in. over the pier legs). Expansion joints were located at the abutments.

The cast-in-place concrete deck is approximately 115-ft. wide, constructed to accommodate six lanes of divided traffic with 10-ft. shoulders and a fenced bike path adjacent to the westbound lanes.

The bridge was designed to AASHTO's Standard Specifications, including VDOT's modifications as appropriate. VDOT's Road and Bridge Standards were also used.

### SUBSTRUCTURE

Due to a high degree of differential weathering, fracturing, and mud seams in the rock sub-surface, the abutment and pier on the west side of the reservoir were founded on 42-in.-diameter drilled shafts. The more competent rock on the east side of the reservoir permitted the use of shallow foundations for that pier and abutment.

A hydraulic analysis was performed to confirm foundation depths to ensure that the bridge would not be susceptible to scour during a flood. This analysis was used to determine the gradation and limits of the 48-in.-thick riprap layer installed around the piers.

The top of the rock at the west pier slows downward from the south end of the pier to its north end. The top of rock was as much as 4 feet below the bottom of the footing for the northernmost 50

Please circle # 47



feet of the 150-ft.-long pier. To confirm the safety of the pier, PB performed a structural analysis of the pier, modelling the upper 4 ft. of the northernmost drilled shafts as if they were exposed during a severe flood.

Special precautions were taken to guard against heat of hydration problems, notably shrinkage cracks, at the massive concrete piers. Provisions were added to the specifications to establish design criteria for the concrete mix.

The size of the concrete pours for the pier stems was limited and the contractor was not permitted to use high early strength cement, calcium chloride, or accelerating admixtures. An attempt was made to limit those items that could add heat to the concrete mix. The contractor was required to submit documentation showing that the concrete design mix and placement methods were in accordance with the special provisions and referenced ACE documents. The contractor chose to use cold waterline and granulated iron blast-furnace slag (to replace half of the cement content) in the mix to satisfy project specifications.

All of these efforts to eliminate excessive shrinkage cracks due to uncontrolled heat of hydration were quite successful. PB's field inspectors remarked at the noticeable lack of these commonplace shrinkage cracks.

Special pin bearings were designed for the pier locations to allow the sloping steel pier legs to rotate as required. The 5.5-in.-diameter pins were made of stainless steel in accordance with ASTM A576, UNS Designation S28200, with a yield strength of 60,000 psi. To protect the pin bearings from deterioration from the reservoir, the top of the pier concrete was set above the 100-year flood level.

During a routine ultrasonic inspection of the pins by VDOT, the inspector noticed some unusual reflections showing up on the ultrasonic equipment. After further investigation, pro-

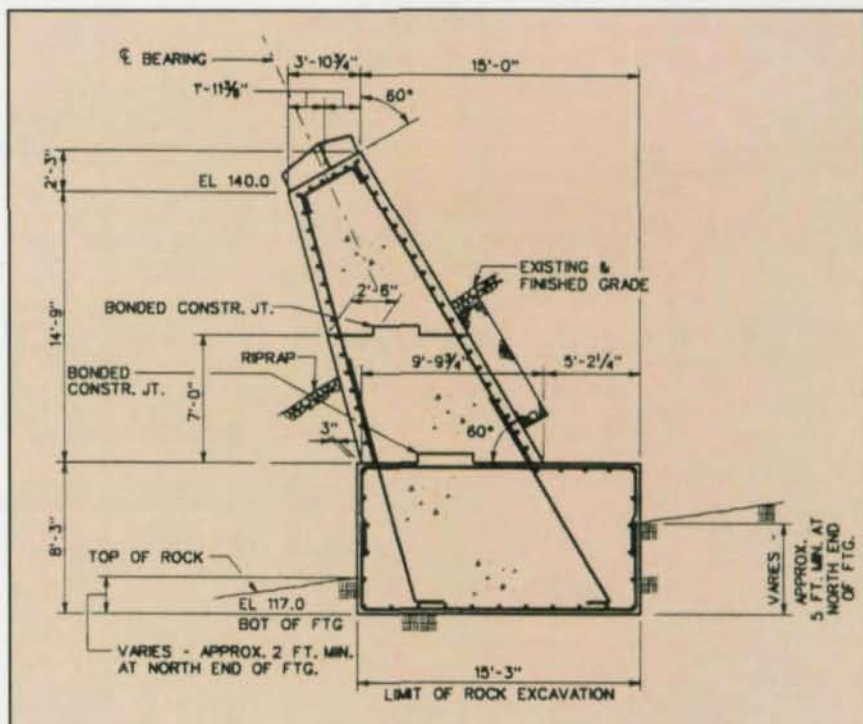

ject engineers concluded that the configuration of the vertical bearing plates with respect to the pin caused the reflections, not a Jack in the pin. VDOT concurred with PB's assessment. To document that there is no structural problem in the pins, a baseline ultrasonic test was performed on all pins in May 1995 and will be repeated next year for comparison.

#### SUPERSTRUCTURE

The material for the rigid-

frame steel members is ASTM A709, Grade 50. A finite element computer analysis was performed at the intersection of the main girders with the top of the sloping steel pier legs to confirm the transfer of load through this structure intersection. The bridge utilized 1,700 tons of steel (58 lbs./sq. ft. of deck).

Project specifications required the steel to be painted with a zinc rich paint system. As an alternative to the conventional three-coat system, VDOT per-





mitted the use of a shop-coated single coat paint system, which avoided the costs of field painting over the reservoir. All faying surfaces, as well as the top flange of the girder, were painted and galvanized bolts were used. The shop application of the paint was carefully monitored by

inspectors from PB, VDOT, the fabricator, and the paint manufacturer. The paint was Carbo Zinc 11 HS by Carboline.

Careful erection procedures are required when single-coat paint systems are used. These procedures help minimize the amount of field touch-up work

that is required after erection, which improves the overall aesthetics of the bridge.

#### ENVIRONMENTAL ISSUES

Aside from the special precautions to avoid field painting over the river, the following restrictions were included in the contract documents to protect the reservoirs natural environment:

- The Nationwide Permit from the Corps of Engineers restricted any fill placed in the reservoir to a maximum of 200 cubic yards.
- No piers were allowed to be constructed in the waterway at its normal elevation.
- Booms were placed in the river to restrict the spread of any fuel spilling from the construction equipment.
- The downspouts from the deck drainage inlets were not permitted to discharge directly into the reservoir;

## **TONE** Shear Wrench Tools for Tension Set Fasteners

**AND**

**ALL Break-Off Type Bolts**

SALES • REPAIRS • RENTALS • PARTS

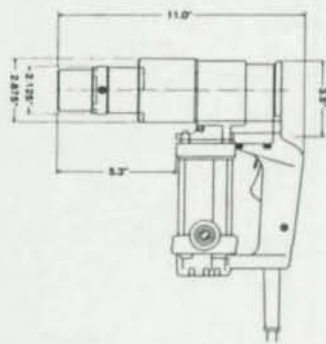

#### S-60EZ Specifications

Weight ..... 13 lbs.  
 Torque ..... 425 ft./lbs.  
 Speed ..... 16 RPM  
 Capacity ..... 5/8" - 3/4"  
 (+7/8" A325 only)  
 Voltage ..... 110 V. AC

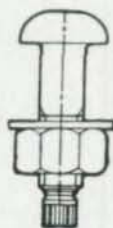

FULL  
 RANGE OF  
 BOLTS  
 5/8" - 1-1/8"  
 A325

A490  
 Are Also  
 Available

**CALL US For Domestic  
 Tension Control Bolts!**

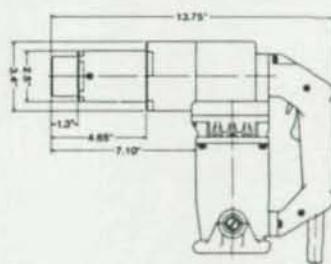

#### S-90EZ Specifications

Weight ..... 18.5 lbs.  
 Torque ..... 550 ft./lbs.  
 Speed ..... 16 RPM  
 Capacity ..... 3/4" - 7/8"  
 (+1" A325 only)  
 Voltage ..... 110 V. AC

## **BRISTOL** MACHINE COMPANY

19844 Quirpz Court, Walnut, CA 91789 • (909) 598-8601 • Fax (909) 598-6493 • (800) 798-9321

Please circle # 113



aside from the deicing salt present in the runoff, an attempt was made to keep any fuel spill on the bridge deck from entering the reservoir.

#### CONSTRUCTION ISSUES

Shirley Contracting Corporation (SCC) won the bridge contract with a bid of \$5.2 million, well below the engineer's estimate of \$6.7 million. The very competitive construction environment at the time of the bidding period contributed to the contractor's low bid.

AISC-member Atlas Machine & Iron Works fabricated the structural steel. The geometry of the sloping legs and the curved web haunch sections at the top of the pier legs was very complex. No two frame sections were alike since all 26 pier bearing pins were at the same elevation. Adjustments were made in the structural steel to provide a

cross slope in the deck surface.

McKinney Drilling Company constructed the drilled shafts. They used mud augers and rock bits to drill the shafts, with casings to prevent material from falling off the walls of the shafts.

Williams Steel erected the structural steel. Iron workers used 21,000 high-strength bolts to connect 65 separate sections of the plate girders. Five girder sections form each of the 13 rigid steel frames. In each frame, two girder sections have field-welded pier legs attached.

After pier leg attachment, the 26 bridge frame sections supported by the piers were erected. The rocky bank on the east side of the river was too steep to use to transport girders or a crane down to the pier. Williams built a frame using wide-flange steel members and attached it to a tri-axle dolly to support the pier/leg girder sections as they were moved down the west slope to

their barge-mounted crane. They used two "tugger" winches to move the barge across the reservoir, pulling on cables anchored at four points on the shore, two on each bank. Before lifting the girder sections above the piers, the barge was anchored by dropping two "Spuds" through well holes at opposite corners of the barge. Their weight drove them into the mud beneath the barge, preventing lateral movement.

With the leg and the bearing attached, the heaviest girder section stands 33 ft.-high, is 124 ft.-long, and weighs 85,000 pounds. The middle section of five sections that form each frame is the longest of the girder sections, measuring 135 ft.-long. Williams' largest crane was a 230-ton Manitowoc, rigged with a 140-foot boom and a 30-foot jib. They "Walked" it on a sectional barge to erect many of the heaviest girder sections. The pin bearings at the piers were attached to the

## GT STRUDL.

on a PC—It's All There!

Quality Performance Customer Support

The premier structural software engineers have been using since 1978 on mainframes and workstations is now available on PCs.

GT STRUDL provides the top quality, versatile, and accurate structural engineering and design software for utility, transportation, offshore, industrial, and civil works facilities.

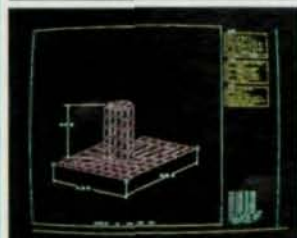

#### GT STRUDL features include:

- interactive graphics
- links to popular CAD systems
- library of over 100 element types
- steel and reinforced concrete design
- static, nonlinear, and dynamic analyses
- graphical frame and finite element modeling
- compliance with NRC and ISO 9000 quality requirements
- operates on PCs, UNIX workstations, and mainframe computers
- voted #1 in user support

30-day trial available

For more information, please contact:

(404) 894-2260 FAX: (404) 894-8014

Computer Aided Structural Engineering Center Atlanta, GA 30332-0355 USA

Please circle # 71



pier legs at the fabrication shop and remained attached during field-welding and erection.

Field welding was used to attach the sloping steel pier legs to the plate girders. This connection method was chosen instead of bolted splice connections due to the proximity of the curved flange plates to the splice location and the improved aesthetics from using field welds.

In the fabrication shop, the webs and flanges of the adjoining members were beveled to prepare them for welding. The fabricator carefully aligned the pier legs and the girders at the proper orientation in the shop. For field alignment purposes, several punch marks were placed on the webs of the pier legs and girders. One punch mark was placed at the structure's work point above the pier leg. Additional punch marks were placed on each side of the intended field weld location. The fabricator then mea-

sured and recorded the distances from the web punches to the center of the bearing pin. Upon arrival in the field, the welding crew re-established the proper alignment of the pier legs and girders using the punch marks and measurements furnished by the fabricator.

The contractor performed the field welding by setting the pier legs and girder webs horizontally on steel support stands. All welding was performed in accordance with BDOT specifications and the AASHTO/AWS Bridge Welding Code. Welders worked on the flanges first, alternating passes on the top and bottom flanges to minimize creep due to temperature changes. The flanges were welded in a vertical direction (upwards) using a flux cored welding process with a Lincoln E71-T1 electrode, 0.045-in.-diameter wire and carbon dioxide gas shielding.

The contractor began using a

flux core process to weld the webs also, but found this to be too time consuming due to the length of the welds, so switched to a submerged arc process. Welding in the horizontal position with a steel back-up bar, the welders used a Lincoln L61 electrode and  $\frac{3}{32}$ -in.-diameter wire. Full penetration of the weld was achieved from one side of the web. After welding the top of each web, the welders removed the back-up bars and ground off the weld reinforcements. All welds were ground flush and 100% radiograph inspected to check for voids and imperfections.

*John D. Anderson, P.E., is a resident engineer with Parsons Brinckerhoff Construction Services, Inc., and David A. Charters, Jr., P.E., is a project structural engineer with Parsons Brinckerhoff Quade & Douglas, Inc.*

# LOOK JOBBER 4™



## Remember "SMOLEY'S"

JOBBER 4™ can do everything Smoley's can do and **MUCH MORE**. More importantly it can do it in **SECONDS**. And you know your answer is **CORRECT**.

Calculations that would have taken hours a few years ago, can now be performed in seconds with the Jobber 4™.

## Jobber Makes What Seems Like Complicated Math Very Simple!

### Works in Three Dimensional Formats

1. Feet, inches, sixteenths (calculator)
2. Decimal (of feet) (or standard calculator)
3. Metric calculator (millimeters, etc.) Instant conversion

## LET JOBBER HELP YOU BUILD THAT TRANSITIONAL BRIDGE FROM FEET AND INCHES TO METRIC

- ★ ★ ★ ★ ★ ★ ★ ★ ★ ★ ★ ★ ★ ★ ★ ★
- ★ EVEN COMPUTER USERS ★
- ★ FIND IT TO BE ONE OF THEIR ★
- ★ MOST VALUABLE TOOLS ★
- ★ ★ ★ ★ ★ ★ ★ ★ ★ ★ ★ ★ ★ ★ ★ ★

## No Math Problem is too Complex for the Jobber 4™

Now almost anyone can be a mathematical genius.

## "THE DIMENSIONAL CALCULATOR THAT REALLY DOES IT ALL"



## SPECIAL FEATURES:

- Automatically Solves **Triangles**
- Automatically Solves **Circles** & Segmental Functions
- Degrees - Minutes - Seconds
- Adding, subtracting, multiplying or dividing dimensions has never been easier.

**Give All Your People:** Draftsmen, Formen, Crew Leaders, Layout Men, etc. **the Handiest Tool They Could Ever Have, A Calculator That Works In Dimensions Like They Do**

**TO ORDER OR FOR MORE INFORMATION**

**PHONE TOLL FREE  
1-800-635-1339**

**PRICE: \$99.95 + 5.50 S&H  
DISCOUNT FOR LARGER ORDERS**

**Jobber Instruments • P.O. Box 4112 • Sevierville, TN 37864**



the outbound modules. Each of the connector elements measures 170-ft. by 1,008-ft., with a clear height requirement varying from 30-ft. along the inbound side to a minimum of 21 ft. at the transition to each outbound module.

The outbound modules are long narrow structures allowing dock doors at 12-ft. on center along both long sides. The areas between the parallel fingers are used for vehicle maneuvering. All 10 outbound modules are 60-ft. wide; the five north fingers are 1,012-ft. long, while the five south fingers are 714-ft. long. The interior of each is column-free with a minimum interior clear height of 21 ft.

In addition to the main building, there are several auxiliary facilities, such as truck wash buildings, a truck maintenance shop and guard houses.

#### STRUCTURAL DESIGN

The design of the structure is of interest both for its process and its product. The process began with UPS's design of the external flow of vehicles (inbound and outbound) and the internal flow of packages (conveying and sorting). In plan, the building shape is that of a block I with narrow finger structures extending from the top and bottom of the block I. Using wide flange beam terminology, the "web" of the I contains the inbound receiving dock doors and sorting equipment, while the "flanges" contain conveyors connecting the inbound areas and outbound areas. Lastly, the outbound modules contain conveyors leading to the outbound dock doors. Each of these three functional areas was studied individually and the structural systems used are unique to each area.

The building's shape also was heavily influenced by the internal flows. The layout and vertical arrangement of chutes and conveyors largely dictated the locations of columns and their possible size. The structure contains 866 columns, including wind columns. UPS's equipment

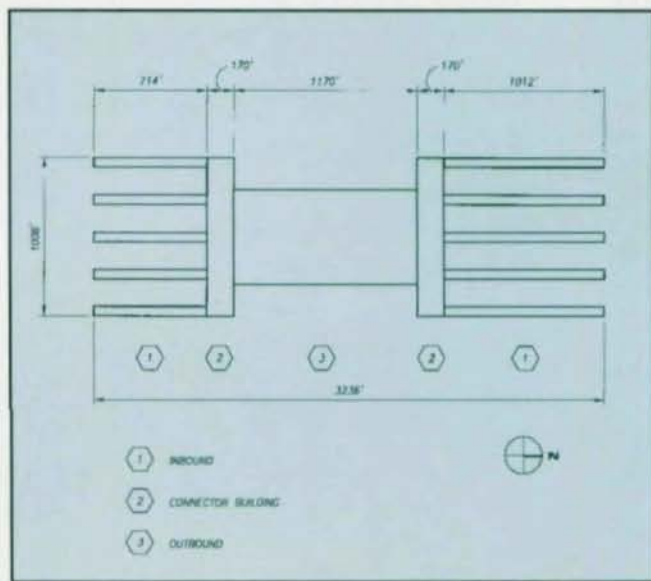

*The 1.9-million-sq.-ft. Chicago Area Consolidation Hub houses a sortation facility that will be the principal hub for all of UPS's east-west traffic.*

needs dictated that the east-west grid lines jogged 10 ft. and 16 ft., respectively, on the east and west sides. Only the first two columns aligned as pairs on each side. The center section of the building was shifted. Also, the bay modules in both the north-south and east-west grids changed to suit the equipment layout.

After the process layout was established, UPS began a series of studies to determine a narrow range of feasible structural systems and enclosure systems. Of foremost importance for the structural system were vertical and horizontal clearances—both of which were previously established by UPS's needs. These studies were done by UPS's engi-



# WITH VULCRAFT ON DECK, THIS



*The Ballpark at Arlington, home of the Texas Rangers, built with Vulcraft composite deck.*



# New Plans and Software for Short-Span Steel Bridges



This two-volume Short-Span Steel Bridge Package contains more than 1,100 predesigned steel superstructures with details, plus user friendly, PC compatible software, that will bring you quick, efficient solutions to many simple-span non-skewed bridges.

The plans tabulate the design of bridges that are 20 feet to 120 feet long in five foot increments for 24, 28, 34, 40 and 44 foot roadway widths. The software provides back-up calculations to the pre-designs and allows the engineer to custom design, code check or rate the bridge.

The package was developed by Dr. S. Taavoni, PE, of Kennedy Porter & Associates for the American Iron and Steel Institute in collaboration with AISC Marketing, Inc. Sponsors of the package include Bethlehem Steel Corporation, Inland Steel Industries, Lukens Steel Co., and U. S. Steel.

With AISI's new comprehensive short-span steel bridge package designers can minimize design time and project cost. Quickly explore design and detail options for:

- Welded plate girders with unstiffened and partially stiffened webs
- Rolled beams with and without cover plates for composite and non-composite construction
- Normal and lightweight concrete deck
- Elastomeric bearings
- Jointless and conventional abutment information
- Crash tested Jersey barrier
- Tables of reactions, moments and deflections
- Table of quantities for each design (structural steel, rebar and concrete)
- AASHTO's Load Factor Design
- HS25 Live Load
- Over 150 11" x 17" design and detail sheets
- Much more!!!

Please send me:

- Information about the AISI Short-Span Steel Bridge Package.  
 A copy of the AISI Short-Span Steel Bridge Package (payment enclosed).

**Ship Short-Span Bridge Package to:**

Name \_\_\_\_\_  
Company \_\_\_\_\_  
Address \_\_\_\_\_  
City \_\_\_\_\_ State \_\_\_\_\_ ZIP \_\_\_\_\_  
Phone \_\_\_\_\_ Fax \_\_\_\_\_

**FAX:** 202-463-6573 or  
**MAIL:** American Iron and Steel Institute  
1101 17th St., NW  
Washington, D. C. 20036  
**TEL:** 202-452-7140



**Order Form**

**Short-Span Bridge Package** \_\_\_ @ \$150 = \$ \_\_\_

*Additional shipping and handling will be added for orders outside the U. S.*

Check  Visa  Mastercard  
(payable to AISI)

Cardholder Name \_\_\_\_\_

Card Number \_\_\_\_\_

Expiration Date \_\_\_\_\_

Signature \_\_\_\_\_



# Affordable Design Power.

## U.S. and SI Units.



**F**or two years the American Institute of Steel Construction has offered bridge designers the powerful Program SIMON for the design of straight steel plate-girder bridges on a PC platform. Now under the auspices of the National Steel Bridge Alliance (NSBA), Program SIMON has been upgraded to include designs in SI (metric) units.

Version 8.0 of Program SIMON gives the user two options for designing I-shaped and box-shaped girders in SI units besides the standard U.S. units. In Version 8.0 input files can be executed in SI units to generate SI unit output files or input files can be executed in U.S. units to generate SI unit output files (soft conversion). Metric input files use SI unit quantities such as meters instead of feet, millimeters instead of inches and megapascals instead of kips per square inch. All files created in Version 7.0 are readable in Version 8.0 of Program SIMON and can generate U.S. or SI unit output.

SIMON is easy to use because the engineer follows the same logic and process as designing a bridge manually. SIMON designs I-shaped and multiple single-cell box-shaped girders, with up to 12

continuous spans. SIMON produces complete designs in accordance with the 1992 Fifteenth Edition of the AASHTO Standard Specification for Highway Bridges through the 1994 interim specification.

Version 8.0 of Program SIMON also includes many improvements to the output files including:

- Reformatted output files to an 80 column width for easier viewing,
- Convenient review of data tables,
- User control of compiled defaults,
- Easier configuration of computers and printers to generate output files.

Licensing of Program SIMON for use on a personal computer is available for an annual subscription fee of \$348. During the subscription period NSBA will furnish program updates along with telephone support on the use of the software at no additional charge. To order or for more information phone: 312-670-2400 or fax: 312-670-5403.



**Setting Standards For Over 70 Years**



11 2462

---

# Call For Papers

---

# NATIONAL STEEL BRIDGE SYMPOSIUM

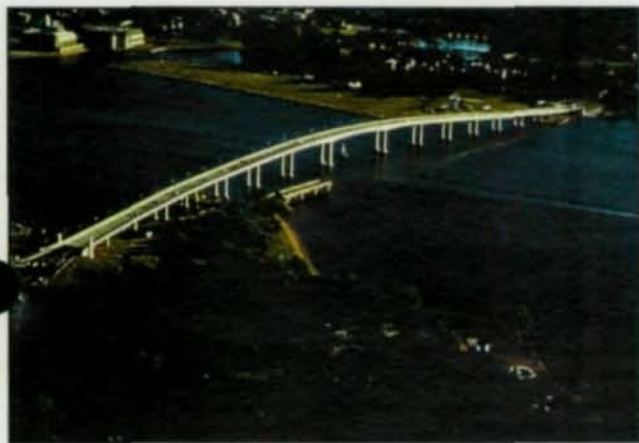

## Wanted: Innovative Steel Bridges

If you have recently designed, built, fabricated, erected or painted an innovative steel bridge—or done anything innovative relative to steel bridges—and wish to present a paper at the Fifth National Steel Bridge Symposium, send a short summary or abstract to Fred Beckmann, AISC Director of Bridges, American Institute of Steel Construction, Inc., One East Wacker Dr., Suite 3100, Chicago, IL 60601-2001 (fax: 312/670-5403) by December 15, 1995.

The **NSBA National Steel Bridge Symposium**, to be held in Chicago in the Fall of 1996, brings together design and engineering professionals, FHWA and Department of Transportation Officials, fabricators, erectors and contractors to discuss and learn about state-of-the-art bridge design, fabrication and construction techniques. The Symposium includes workshops, lectures, technical sessions and the presentation of the AISC Prize Bridge Awards.



Setting Standards For Over 70 Years



THE PRINCIPAL OF PRESTRESSING IS CLEAR-CUT: PRIOR TO THE APPLICATION OF LOAD, A SET OF STRESSES IS INDUCED OF SUCH DEGREE THAT THE TOTAL OF THESE STRESSES AND THE STRESSES PRODUCED BY THE DIRECT DEAD AND LIVE LOADS WILL NOT EXCEED CERTAIN LIMIT STATES

— *USS BRIDGE REPORT, JUNE 1985*

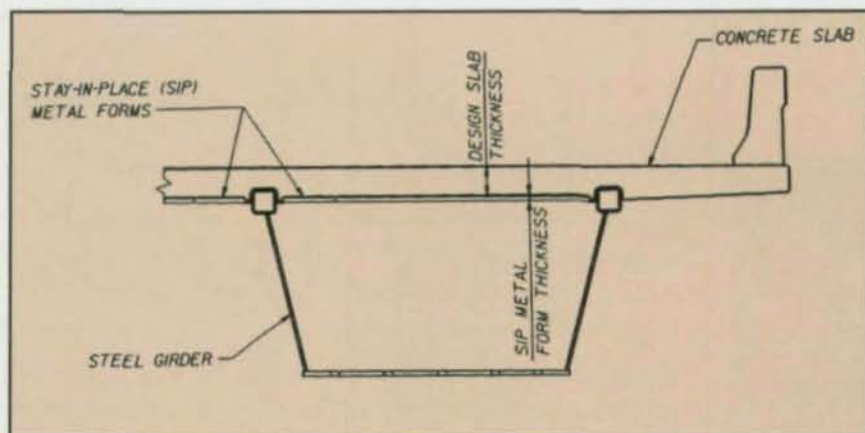

## POST-TENSIONED BOX GIRDERS

The use of post-tensioned steel box girders on three bridges in Florida is expected to improve aesthetics without increasing costs while also enhancing long-term performance characteristics

By Robert B. Anderson

WHILE PRESTRESSING IS OFTEN USED ON CONCRETE STRUCTURES, ITS ADVANTAGES ARE RARELY EXPLOITED ON STEEL STRUCTURES even though the technical advantages of prestressing for steel structures—better performance at a lower cost—have been discussed in U.S. and Canadian literature since the mid-1950s. Unfortunately, the complexity of designing prestressed steel structures has undoubtedly stymied its use.

Now, however, Greiner, Inc., under the direction of the FHWA and the Florida DOT, is designing three innovative bridges utilizing post-tensioned steel box girders. The box girders, thought to be the first of their type, incorporate two-stage longitudinal post-tensioning of the steel box and the steel/concrete composite section. The forerunner to this scheme was the Bonner's Ferry Bridge in Idaho (see sidebar) that incorporated post-tensioning of plate girders.

The two-stage prestressing technique is to be used for three identical bridges designed as part of the improvements to State Road No. 55/U.S. 19 in Clearwater, FL. The highway is being upgraded from general lane service to limited access in a highly congested urban setting and the bridges form an integral part of an "urban" interchange.

The superstructure spans separate turnarounds for the frontage roads and the crossroad intersects beneath the main span. The bridges are three-span continuous with side spans of 106-ft.-6-in. and center span lengths of 204-ft. Six girders spaced 19-ft.-5-in. on center are used to support the roadway, which measures 117-ft.-1-in. wide. Three piers, trapezoidal in shape and located within a median area, each carry two girders at the intermediate supports. The bridge length is defined by the end bents. These structural elements are integrated with a proprietary retaining wall system that is configured to form



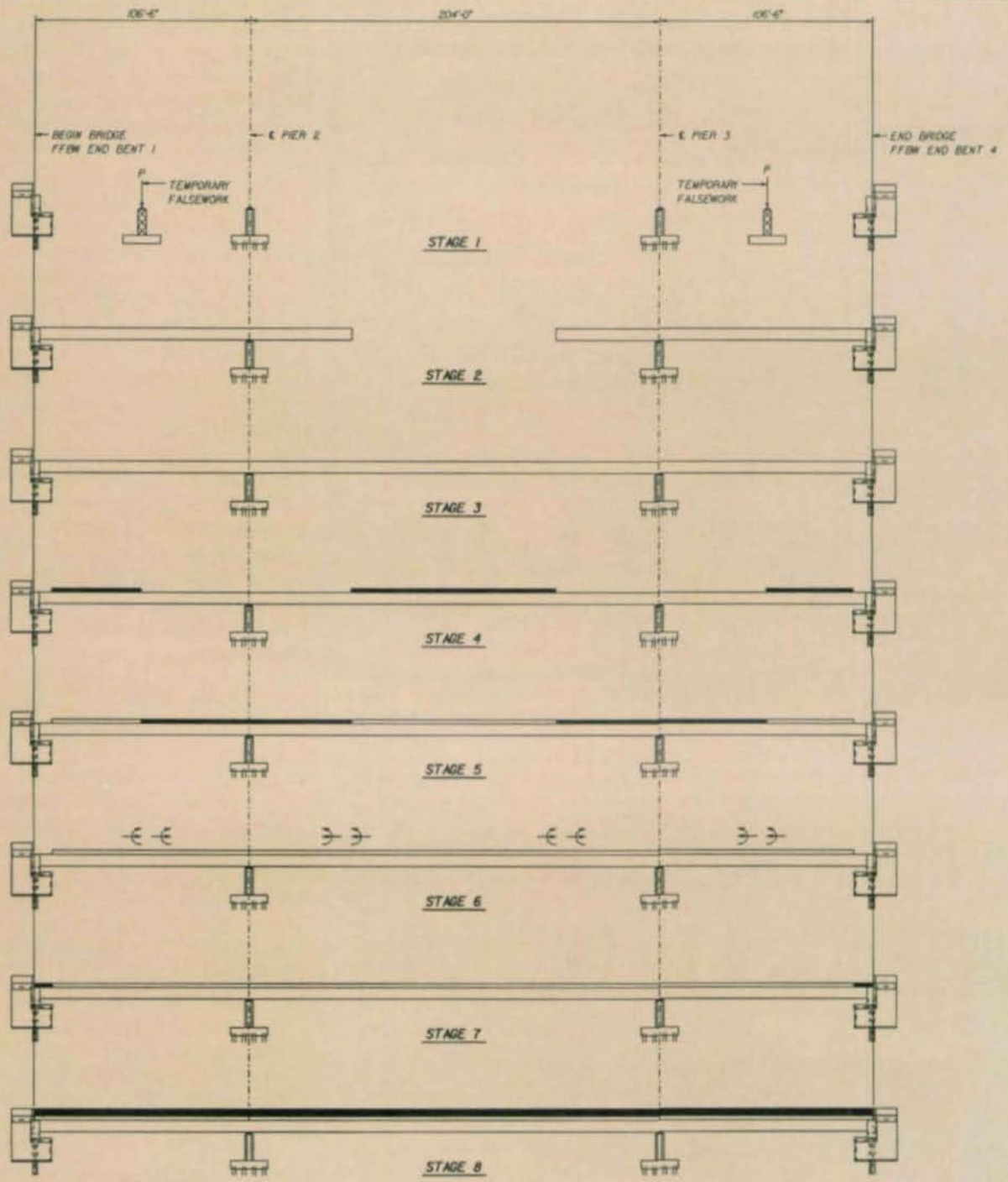

**Stage 1:** Construct bridge superstructure including end bents 1 & 4, piers 2 & 3, and retaining walls adjacent to end bent caps. Erect temporary falsework.

**Stage 2:** After superstructure concrete has obtained a design strength of 3400 psi, erect girder side spans and cantilever portion of main span, also erect end diaphragms, temporary bracing between the girders and cross frames diaphragms at the piers. Dismantle temporary falsework.

**Stage 3:** Erect center of main span.

**Stage 4:** Cast deck placement 1A, 1B & 2 including

anchorage blisters.

**Stage 5:** Cast deck placement 3A & 3B including anchorage blisters.

**Stage 6:** After slab concrete has reached a strength of 4000 psi, remove all temporary cross frames, stress and grout second stage post-tensioning.

**Stage 7:** Cast final deck placement at bridge end. Cast anchorage head covers.

**Stage 8:** Place barriers.



# The #1 True Windows 32-bit Structural Program

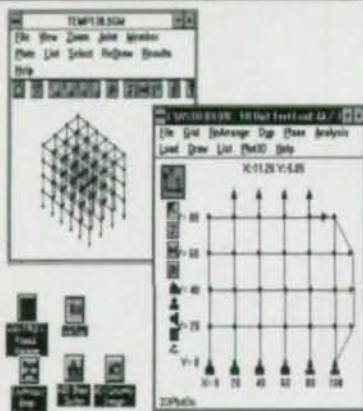

- \*It's for Windows
- \*It's for Network
- \*It's Multi-Tasking
- \*It's 32-Bit
- \*It's Our Competitor's Worst Nightmare

WinSTRUDL is the #1 32-bit Structural Program for Windows. If you got to see it to believe it, ask for a free Demo disk now!

Now is the time to switch! Get out of those **Phony** Windows Programs and experience **REAL** productivity, get the one.....

## WinSTRUDL

Computer Aided Structural Technology, PO Box 14676,  
Fremont, CA 94539-4676 Tel (510) 226-8857 Fax (510) 226-7328

Please circle # 27

## ATTENTION TO DETAIL

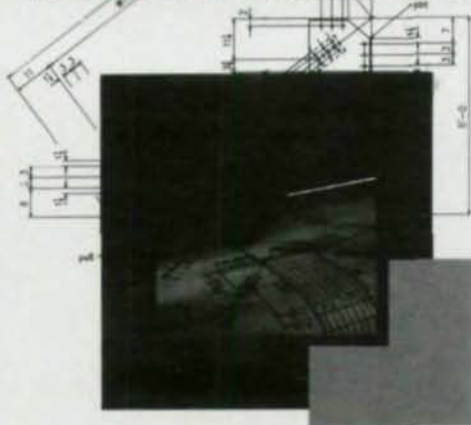

Computer Detailing Systems, Inc. introduces a state of the art structural steel detailing system which allows fabricators and detailers to meet the demands of the future with the ability to generate connection calculations, download to CNC equipment and interface with major design firms through the Steel Detailing Neutral File.

A practical, flexible system requiring minimal training, CDS is capable of producing intelligent 3D models, floor plans and elevations as well as shop drawings of unsurpassed quality using your standards and paper.

CDS is currently used by fabricators and detailers throughout the US and in Canada.

CONTACT COMPUTER DETAILING SYSTEMS  
today FOR A FREE INFORMATION PACK.

**CDS**

Structural Steel Detailing System

Computer Detailing Systems, Inc. • 7280 Pepperdam Avenue • Charleston, South Carolina 29418 • (803)552-7055

Please circle # 63

the approach embankment. Final design plans have been completed for the three bridges and have been submitted to the FDOT with contract letting expected sometime in 1996.

The selection of post-tensioning for the steel box was based primarily on cost with some consideration of bridge aesthetics. As with all prestressing schemes, the prestressing concept is economically feasible only if the cost reduction for the main section is more than the additional costs of the prestressing material and its installation. To establish the economic feasibility of the prestressing scheme, 12 bridge alternatives were evaluated, including various arrangements of steel plate girders, steel box girders, AASHTO beams, and cast-in-place concrete box girders, along with the post-tensioned box girder option. The post-tensioned box girder scheme was approximately 8% more expensive than the least costly conventional plate girder alternative.

Post-tensioning offered a cost savings of roughly 5% when compared to the conventional steel box girder. None of the concrete alternatives were competitive for this application. The post-tensioned steel box made economical sense, though, not only because it offered savings in steel weight, but also because it decreased structural depth, which in turn lowered the approach roadways and retaining walls and lessened right-of-way acquisition costs. All but the right-of-way costs were considered in the preceding cost studies. The post-tensioned steel box was recommended since it proved to be nearly the same overall cost as other schemes and offered improved aesthetics when compared with plate girders.

Because the concept could be applied to three identical bridges, the development cost that might be required for the application of a "new" technology could be shared by multiple



structures. In this regard, the plans were submitted to two fabricators and AISC Marketing, Inc. for their review during design development. Each suggested ways to improve the design.

### PRESTRESSED/NON- PRESTRESSED

A conventional, non-prestressed design was used in the positive moment regions of the box girder. In the negative moment regions, the girder top flange was replaced by a A500-Grade C tube section with a yield strength of 50 ksi. Running through each tube are 25 1/2-in.-diameter prestressing strands. After application of post-tensioning, the tubes are grouted.

The plates conform to ASTM 572-Gr. 50. The second stage post-tensioning was supplied by eight tendons per girder, each with seven 1/2-in.-diameter strands. All post-tensioning strands are low relaxation type with a tensile stress of 270 ksi, conforming to ASTM 416-85. The composite slab is constructed of 5,000 psi cylinder strength concrete. The web depth of 56-in. gives a resulting span-to-depth ratio of 28. (The span is measured between dead load points of contraflexure without superimposed prestressing loads.)

The bridges are designed to meet AASHTO Specifications (14th edition-1989 and Interim Specifications through 1991) using load factor design with a design live load of HS20 truck loading.

### DESIGN CONSIDERATIONS

The construction sequence was set up to minimize the tensile stress in the slab. While it was desirable to engage the composite section as early as possible in the construction sequence to relieve the steel stress, the drawback is that more post-tensioning must be added to overcome slab tension. The most feasible alternative was to make the slab composite over the pier only for superimposed dead loads and

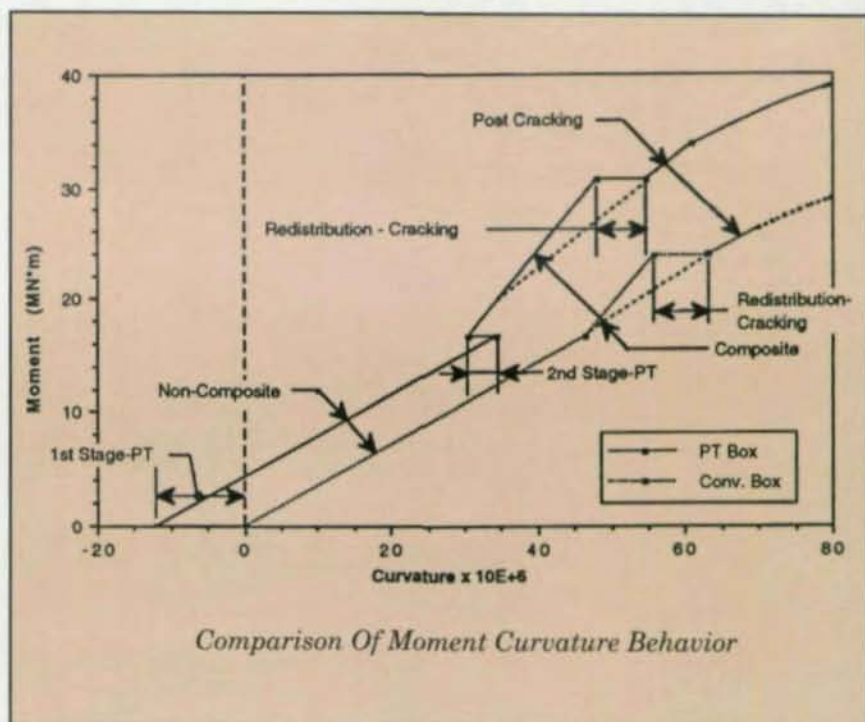

Comparison Of Moment Curvature Behavior

live loads.

Early in the project it was recognized that creep and shrinkage of the concrete slab over time would be a critical element in the design of the post-tensioned steel box. A preliminary study was done using an age-adjusted concrete modulus for a simplified composite section. The goal of this study was to develop an understanding of the load transfer mechanisms that occur with creep and shrinkage. As concrete creeps or shrinks over time, the change in concrete strain will result in both axial force and resulting moment, due to eccentricity of the axial force being redistributed within the section. Under a sustained load, the steel stresses will generally increase while the concrete stresses will reduce with time. The conclusion of this study was that it is appropriate to use a varying modular ratio to account for creep and shrinkage effects when designing post-tensioned steel girders.

Consequently, two separate service level analysis and stress evaluations were undertaken: one at time equal "one" when the bridge is opened to traffic; another at time equal "infinity". Additionally, where cracking of

the slab was shown at the ultimate level, the section properties in the high negative moment regions were reduced to use only the bare steel box and the mild steel and post-tensioned reinforcing of the slab.

The cracked section reduced the negative moments at the intermediate support and increased the midspan positive moments. The most important aspect of this methodology, the use of separate analyses, is that the behavior of the girder is bracketed for all time periods of levels of loading.

### MOMENT-CURVATURE ANALYSIS

A moment-curvature study of the post-tensioned box also was undertaken. Here, the advantages of the post-tensioned scheme can be clearly seen. First stage post-tensioning imparts negative curvature to the post-tensioned section. As moment is applied, the variation in curvature for the post-tensioned box follows the same slope as the conventional girder. The second stage post-tensioning again imparts negative curvature to the post-tensioned steel box and there is an increase in stiffness due to the composite action of







given regarding the application of the first stage post-tensioning.

First, prior to application of the first stage, top lateral bracing and temporary bracing for the tube section are required to be in place. Single end stressing, from either tendon end, with two jacks per girder, was instructed. The two tendons are stressed simultaneously with a 5% maximum differential pressure between jacks.

The plans included camber diagrams and ordinates for first and second stage post tensioning, as well as dead loads, superimposed dead loads and creep and shrinkage effects. The plans also stated the amount of elastic shortening that would be expected due to the first-stage post-tensioning. To negate any uncertainties with the deflections produced by the first-stage post-tensioning, it was the FDOT's preference to require that all the first-stage post-tensioning be done in the steel fabrication shop. This also allows shop fitting of the steel girders before shipment to the jobsite to avoid fit-up problems in the field.

### SECOND-STAGE POST-TENSIONING

The second-stage post-tensioning tendons were staggered over the piers for efficiency. The post-tensioning force was introduced at blisters located on the underside of the slab. In lieu of blisters, the design considered the use of block-outs, with either plate anchorages and small jacks or coupled tendons and jacks with curved stressing noses. The major impetus for contemplating block-outs was to avoid the complication of stick forming beneath the blisters. With block-outs, the entire length of the girder could use stay-in-place forms, which had two advantages. First, the forming would be simplified. And second, the roadways beneath the bridge would have to be closed for only a very short time during construction. The disadvantage of the block-outs, though, is that a

## Bonnors Ferry Bridge

In 1980, the Idaho Transportation Department and the FHWA hired T.Y. Lin International to design a steel alternate to a prestressed concrete design for the replacement of a bridge over the Kootenai River in Bonners Ferry, ID. The innovative—and cost saving—result was a prestressed steel girder bridge.

The bridge features longitudinal cable stressing of the steel girders and post-tensioning of the steel/concrete composite section in the negative bending moment regions over the piers. The stressing was applied in two stages, in order to limit the stresses during construction as well as in the service condition. The first stage of stressing produced a positive bending moment on the steel girder before the concrete deck was poured. This was done to control dead load tension stress induced in the relatively thin top flange. The second stage had as its purpose production of sufficient longitudinal compressive stress in the concrete deck to eliminate tensile stresses induced on the composite steel/concrete section by the AASHTO HS25 service loading. Since, thereby, the deck is always caused to be in compression, and is attached to the top flange by shear connectors placed throughout the full length of the bridge, full composite action is achieved not only for regions of positive moment, but also for the negative moment regions over the piers.

Another major design feature is the transverse prestressing of the concrete deck. This is accomplished by using strands placed in ducts and anchored at the edge of the concrete deck. For the portion over the piers, the concrete deck is prestressed in two directions, insuring a crack-free surface in this often troublesome region. One consequence of the transverse prestressing is that spacing between the steel plate girders can be increased to reduce the number of girders required for the 70-ft.-wide deck. The wide spacing of 18-ft. between girders results in only four girders being required for the full length of the bridge. Transverse prestressing also allowed a long overhang of the deck cantilevering beyond the outside girders, which meant the pile caps could be kept narrow and substructure costs could be reduced.

*(Information condensed from USS Bridge Report, June 1985)*

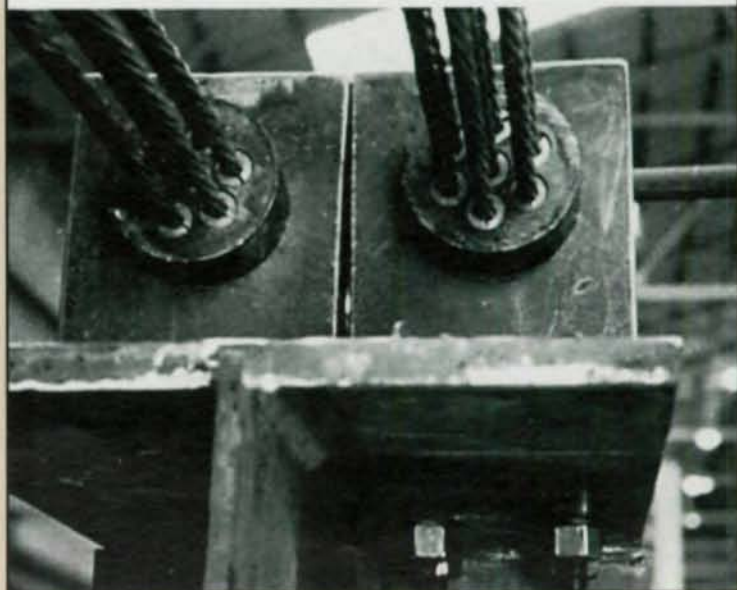
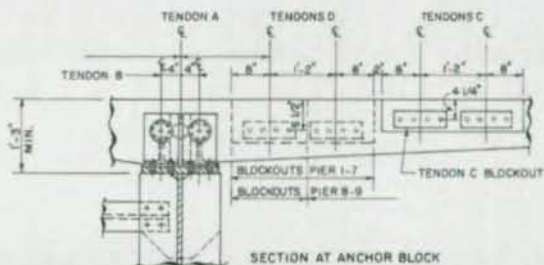



"Solve Your Next Problem in  
**Minutes!**"

Call for  
**FREE Demo**

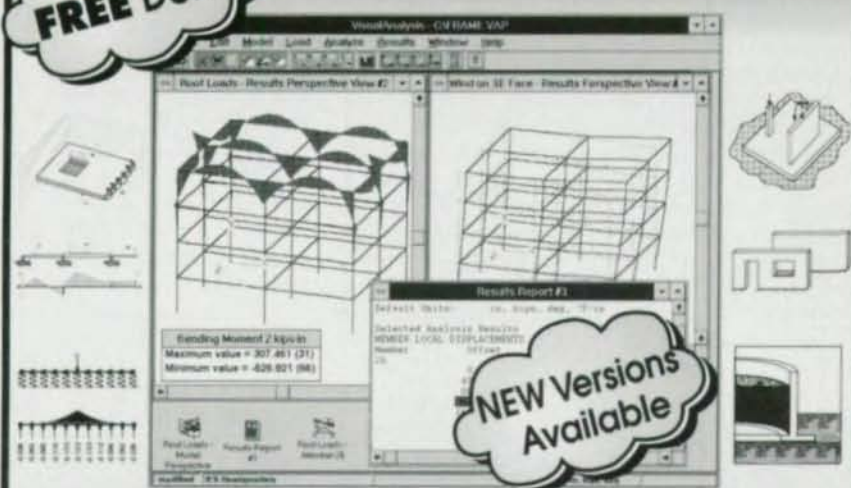

**f** Integrated  
**E** Engineering  
**S** Software

Affordable, high quality software for structural engineers. Real Windows applications save you time, even for small jobs. *VisualAnalysis™* for graphical, unlimited 3D FEA. *AnalysisGroup™* for tools not found elsewhere: shear walls, circular tanks & more! Please call or fax for information.

8840 Chapman Road, Bozeman, MT 59715 **1-800-707-0816**  
(406) 586-8988 Fax: (406) 586-9151

Please circle # 87

# MAX WEISS

## STEEL BENDING SPECIALISTS

Max Weiss has bent large structural beams for major architectural projects as well as the steel ribs on large vessels, but our unique capabilities have served many metal fabricators; boiler shops; steel service centers; foundries; material handling equipment manufacturers; sewer; water and mechanical contractors; gas and electrical utilities; paper-making manufacturers, bottling equipment manufacturers, heavy equipment and crane manufacturers as well. If it's structural steel that needs to be bent, **WE CAN DO IT!**



**max weiss**

Whether you need irregular curves or offsets, angles with unequal legs bent in or out, elliptical shapes, circles, segments of circles or beams split into structural tees and formed stem in, out or up, MAX WEISS CAN DO IT! We also camber and straighten structural shapes. It's why more and more companies are calling Max Weiss first. They know that our specialized equipment and knowledge give us the technological edge in bending capabilities.

MAX WEISS CO., INC. 8625 W. BRADLEY RD., MILWAUKEE, WI 53224  
PHONE: 414/355-8220 MAX FAX: 414/355-4698

substantial portion of the concrete deck would require stressing pockets and subsequent patching of the pockets. Also, corrosion of post-tensioning anchor systems has been cause for concern. Based on FDOT experience, these patches—unless extraordinary measures are used—generally leak and invariably fail to control the ingress of corrosion to the post-tensioning system. Therefore, to assure maximum long-term performance, blisters were used in the final design.

Terminating the tendon at the blister complicated the slab design, however. Specifically, additional slab steel was required to resist bursting forces, deviation forces, tie-back forces and local slab moments produced at the anchorage. Influence surfaces were used to estimate the slab's two-way actions.

### CREEP AND SHRINKAGE

The consideration of long-term losses for prestressed steel structures poses a unique problem. To account for creep and shrinkage losses for the first-stage post-tensioning, only the stress change at the girder top flange from time equal one to time equal infinity needs to be tabulated. For the post-tensioned box application, the long-term loss for the first-stage tensioning was only 1.5 ksi, or 1.3% of the jacking stress after elastic shortening and friction losses.

Time dependent losses for the second-stage post-tensioning were evaluated by the noniterative step-by-step method and long-term losses due to creep and shrinkage of the concrete were found to be 4.6%.

To avoid cycling through the design to account for concrete creep and shrinkage losses, it is important to predict the long-term losses for post-tensioning as accurately as possible. The general results of parametric studies show that an assumed long-term loss due to creep and shrinkage of concrete of 8 per-



# MODERN STEEL CONSTRUCTION Reader Service Card

Please type or print only

name \_\_\_\_\_  
 company name \_\_\_\_\_  
 address \_\_\_\_\_  
 city \_\_\_\_\_ state \_\_\_\_\_ zip code \_\_\_\_\_  
 ( ) ( )  
 business telephone \_\_\_\_\_ fax number \_\_\_\_\_

Check this box to renew or start a **FREE\*** subscription to *Modern Steel Construction* \*This offer good only for practicing professionals within the U.S.

signature \_\_\_\_\_

For free information on advertisers and other companies mentioned in this issue, circle the appropriate number below:

- |     |     |     |     |     |     |     |     |     |     |     |     |
|-----|-----|-----|-----|-----|-----|-----|-----|-----|-----|-----|-----|
| 1   | 2   | 3   | 4   | 5   | 6   | 7   | 8   | 9   | 10  | 11  | 12  |
| 13  | 14  | 15  | 16  | 17  | 18  | 19  | 20  | 21  | 22  | 23  | 24  |
| 25  | 26  | 27  | 28  | 29  | 30  | 31  | 32  | 33  | 34  | 35  | 36  |
| 37  | 38  | 39  | 40  | 41  | 42  | 43  | 44  | 45  | 46  | 47  | 48  |
| 49  | 50  | 51  | 52  | 53  | 54  | 55  | 56  | 57  | 58  | 59  | 60  |
| 61  | 62  | 63  | 64  | 65  | 66  | 67  | 68  | 69  | 70  | 71  | 72  |
| 73  | 74  | 75  | 76  | 77  | 78  | 79  | 80  | 81  | 82  | 83  | 84  |
| 85  | 86  | 87  | 88  | 89  | 90  | 91  | 92  | 93  | 94  | 95  | 96  |
| 97  | 98  | 99  | 100 | 101 | 102 | 103 | 104 | 105 | 106 | 107 | 108 |
| 109 | 110 | 111 | 112 | 113 | 114 | 115 | 116 | 117 | 118 | 119 | 120 |
| 121 | 122 | 123 | 124 | 125 | 126 | 127 | 128 | 129 | 130 | 131 | 132 |

### 1. Type of work

Please circle **all** that apply

- a. Bridges
- b. Office Buildings
- c. Hospitals
- d. Retail
- e. Industrial
- f. Schools
- g. Multifamily
- h. Institutional
- i. Low-Rise
- j. High-Rise

### 2. Your position

Please circle **ONLY** one

- a. Owner/President
- b. Chief Engineer/Chief Architect/Department Head
- c. Staff Engineer/Staff Architect/Construction Manager
- d. Other

### 3. Type of business

Please circle **ONLY** one

- a. Structural engineer
- b. Civil engineer
- c. Structural steel fabricator
- d. Other fabricator
- e. Educator/library
- f. Architect
- g. Building owner/developer
- h. Steel mill
- i. Erector
- j. Steel product manufacturer
- k. GC/CM
- l. Student
- m. Other

### 4. Reason for Inquiry

Please circle **ONLY** one

- a. Information file
- b. Immediate or Future Purchase

NOVEMBER

Use these cards to request information from manufacturers and other companies mentioned in this issue. Simply circle the numbers referenced in the advertisement or article, fill out the rest of the information requested on the card, and either mail it to: Modern Steel Construction, Creative Data Center, 650 South Clark St., Chicago, IL 60605-9960 or fax it to: **312/922-3165.**

Please type or print only

name \_\_\_\_\_  
 company name \_\_\_\_\_  
 address \_\_\_\_\_  
 city \_\_\_\_\_ state \_\_\_\_\_ zip code \_\_\_\_\_  
 ( ) ( )  
 business telephone \_\_\_\_\_ fax number \_\_\_\_\_

Check this box to renew or start a **FREE\*** subscription to *Modern Steel Construction* \*This offer good only for practicing professionals within the U.S.

signature \_\_\_\_\_

For free information on advertisers and other companies mentioned in this issue, circle the appropriate number below:

- |     |     |     |     |     |     |     |     |     |     |     |     |
|-----|-----|-----|-----|-----|-----|-----|-----|-----|-----|-----|-----|
| 1   | 2   | 3   | 4   | 5   | 6   | 7   | 8   | 9   | 10  | 11  | 12  |
| 13  | 14  | 15  | 16  | 17  | 18  | 19  | 20  | 21  | 22  | 23  | 24  |
| 25  | 26  | 27  | 28  | 29  | 30  | 31  | 32  | 33  | 34  | 35  | 36  |
| 37  | 38  | 39  | 40  | 41  | 42  | 43  | 44  | 45  | 46  | 47  | 48  |
| 49  | 50  | 51  | 52  | 53  | 54  | 55  | 56  | 57  | 58  | 59  | 60  |
| 61  | 62  | 63  | 64  | 65  | 66  | 67  | 68  | 69  | 70  | 71  | 72  |
| 73  | 74  | 75  | 76  | 77  | 78  | 79  | 80  | 81  | 82  | 83  | 84  |
| 85  | 86  | 87  | 88  | 89  | 90  | 91  | 92  | 93  | 94  | 95  | 96  |
| 97  | 98  | 99  | 100 | 101 | 102 | 103 | 104 | 105 | 106 | 107 | 108 |
| 109 | 110 | 111 | 112 | 113 | 114 | 115 | 116 | 117 | 118 | 119 | 120 |
| 121 | 122 | 123 | 124 | 125 | 126 | 127 | 128 | 129 | 130 | 131 | 132 |

### 1. Type of work

Please circle **all** that apply

- a. Bridges
- b. Office Buildings
- c. Hospitals
- d. Retail
- e. Industrial
- f. Schools
- g. Multifamily
- h. Institutional
- i. Low-Rise
- j. High-Rise

### 2. Your position

Please circle **ONLY** one

- a. Owner/President
- b. Chief Engineer/Chief Architect/Department Head
- c. Staff Engineer/Staff Architect/Construction Manager
- d. Other

### 3. Type of business

Please circle **ONLY** one

- a. Structural engineer
- b. Civil engineer
- c. Structural steel fabricator
- d. Other fabricator
- e. Educator/library
- f. Architect
- g. Building owner/developer
- h. Steel mill
- i. Erector
- j. Steel product manufacturer
- k. GC/CM
- l. Student
- m. Other

### 4. Reason for Inquiry

Please circle **ONLY** one

- a. Information file
- b. Immediate or Future Purchase

NOVEMBER





NO POSTAGE  
NECESSARY  
IF MAILED  
IN THE  
UNITED STATES

**BUSINESS REPLY MAIL**

FIRST CLASS MAIL PERMIT NO. 12522 CHICAGO, IL

POSTAGE WILL BE PAID BY ADDRESSEE

**MODERN STEEL  
CONSTRUCTION**

c/o CREATIVE DATA SERVICES  
650 S CLARK ST  
CHICAGO, IL 60605-9960



Use these cards to request information from manufacturers and other companies mentioned in this issue. Simply circle the numbers referenced in the advertisement or article, fill out the rest of the information requested on the card, and either mail it to: Modern Steel Construction, Creative Data Center, 650 South Clark St., Chicago, IL 60605-9960 or fax it to: **312/922-3165**.



NO POSTAGE  
NECESSARY  
IF MAILED  
IN THE  
UNITED STATES

**BUSINESS REPLY MAIL**

FIRST CLASS MAIL PERMIT NO. 12522 CHICAGO, IL

POSTAGE WILL BE PAID BY ADDRESSEE

**MODERN STEEL  
CONSTRUCTION**

c/o CREATIVE DATA SERVICES  
650 S CLARK ST  
CHICAGO, IL 60605-9960



**MODERN STEEL  
CONSTRUCTION**  
Reader Service Card



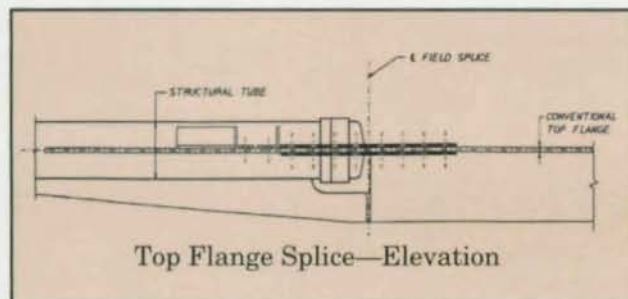
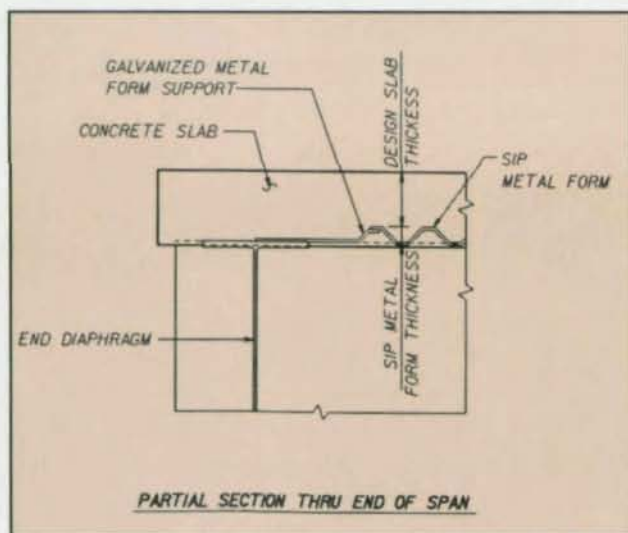
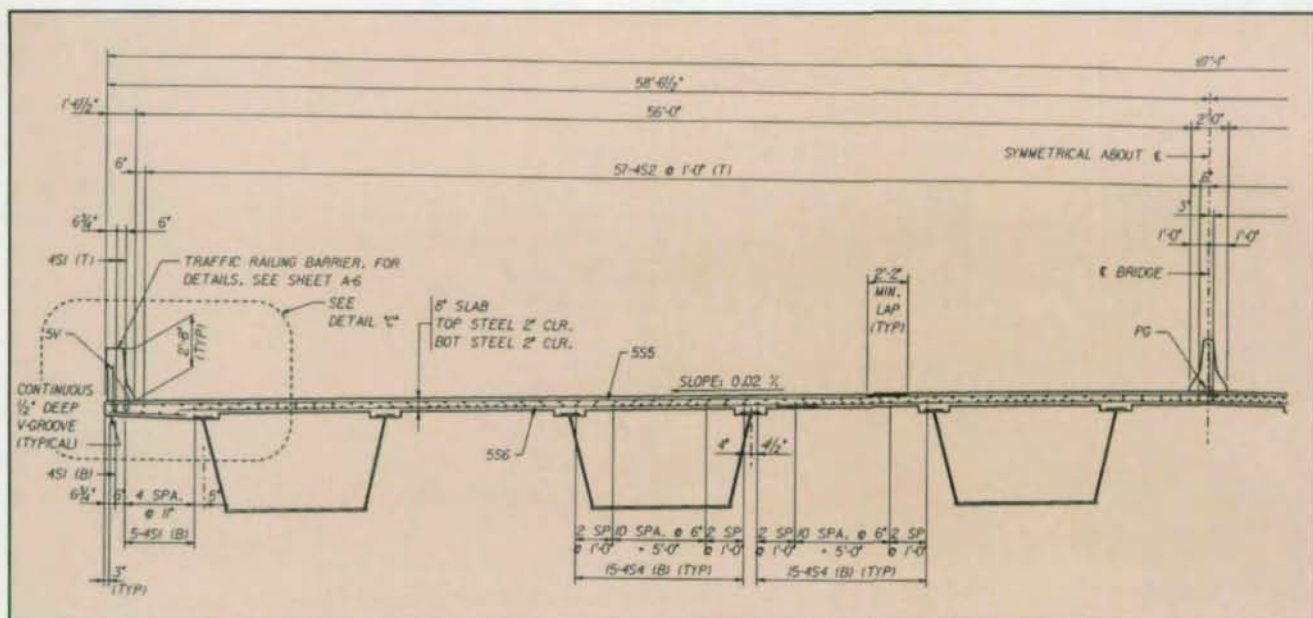

cent is reasonable for most configurations. Additionally, when starting the design, an estimate for the final prestressing stress of 0.6 times the tendon tensile stress based on an initial jacking stress of 0.8 times the tensile stress should be suitable.

The post-tensioned steel box

ers generally require top flange lateral bracing to resist the horizontal component of the shear in the inclined webs. They also prevent compression instability of the top flange before the concrete deck is in place. Special attention must be given to the bracing

shows improved fatigue performance, primarily because the composite action reduced the fatigue stress ranges. At the negative moment region, the top flange stress range was reduced by a factor of 2 when compared to the conventional alternative. The lower stress range at the negative moment results in a one category improvement in AASHTO fatigue rating. However, Charpy V-notch testing still is not eliminated.

layout to miss both the splice and blister locations. One special feature required was temporary bracing to support the girder section at each free end before it was assembled with adjacent girder sections. After the bare beam at the negative moment region was spliced with the rest of the bridge during construction, permanent bracing between the field sections was assembled and the temporary bracing was removed.

While prestressing steel bridges results in a more complex design, it also provides overall savings from reduced cost for the bridge structure, approach embankments, retaining walls and right-of-way acquisition. Also, the prestressing shares some of the load, which improves ductility, and enhances a structures long-term performance by reducing fatigue stress and corrosion of the slab reinforcing.

*Robert B. Anderson, P.E., is a project engineer at Greiner, Inc., in Tampa, FL. Greiner has more than 40 offices nationwide, as well as in Hong Kong and Malaysia. The company specializes in transportation engineering for highway bridges and airport projects.*





## BIG SAVINGS IN THE BIG APPLE!

Everything in NYC is BIG – traffic jams, skyscrapers, business deals...and also BIG savings!

Thanks to grid reinforced concrete bridge decks on the Queensboro Bridge and others...NYC is realizing substantial highway savings. How? Because no other deck surface can withstand the City's harsh climate and relentless traffic so well for so long. Remarkably, several grid reinforced decks in New York are observing their 60th year of continual service – an unmatched record resulting in unsurpassed savings!

By 1998, the Queensboro Bridge (carrying 140,000 vehicles daily) will be totally re-decked (main span and approaches) with nearly one-million square feet of grid reinforced concrete.

Other decks must be replaced on a more frequent basis. This wastes valuable road-tax dollars and creates unnecessary and frustrating construction projects.

Current grid technology builds on that record of durability, while evolving and improving to meet current demands, by using:

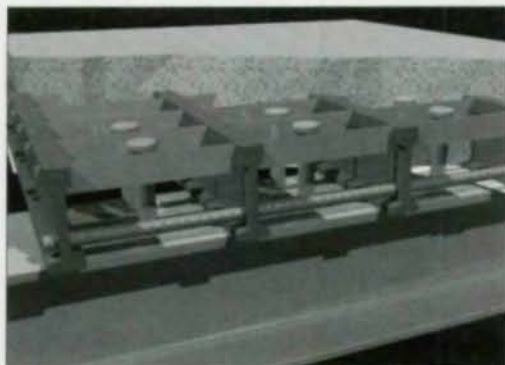

- attachment techniques which insure composite behavior
- variable elevation details to handle cross-slopes and super-elevations
- monolithic overfill to provide a smooth ride, protect the steel grid and enhance the deck's durability
- lightweight concrete to further enhance weight reduction

NYC's savings, however, are NOT restricted to rehabilitation. Grid reinforced decks have also been specified for the NEW approaches to the Williamsburg Bridge!

Strength, durability, long-term economy...and a proven record of performance. There's simply no better choice than grid reinforced concrete decks.



**BRIDGE GRID FLOORING MANUFACTURERS ASSOCIATION**  
231 South Church Street, Mount Pleasant, PA 15666 • Phone 412/547-2660



# SUCCESSFUL RESURFACING FOR AN ORTHOTROPIC STEEL DECK BRIDGE

By Vellore S. Gopalaratnam and Arthur M. Dinitz

The Poplar Street Bridge in St. Louis, one of approximately 30 orthotropic steel-plate deck bridges in the world, carries approximately 130,000 vehicles—including about 15,000 large trucks—across the Mississippi River each day. The five-span bridge is 2,165-ft. long and consists of two independent bridges supported on a set of common piers. Each bridge carries four lanes of traffic and is supported by two box girders with girder depths ranging from 16 ft. to 25 ft. The deck thickness typically is  $\frac{9}{16}$  in. and is stiffened by closed trapezoidal stringers or ribs. The  $\frac{5}{16}$ -in. thick stiffeners on 13-in. centers are 11-in. deep and run along the length of the bridge. Load from the deck also is transferred to the box girders by transverse floor beams spaced on 15-ft. centers. Transverse frames brace the box girders at 60-ft. centers coinciding with every fourth floor beam location, providing the bridge additional torsional rigidity.

When the bridge was constructed in 1967, the steel deck was covered with a wearing surface consisting of two layers of epoxy tack coat and  $1\frac{1}{2}$ -in. of rubberized asphalt concrete wearing surface. Stone chips were embedded in the second layer of epoxy as an anchor for the rubberized asphalt layer. This system performed well until 1983, when it was completely removed and replaced with a second, identical surface. Unfortunately, this time the system only lasted three years. In 1986, the eastbound lanes were replaced with a proprietary system that included a fiberglass reinforcing mat in the asphalt wearing surface. Despite the reinforcing mat, unacceptable amounts of rutting and shoving necessitated the placement of a new wearing system in 1992.

After testing six systems, a Transpo T-48 epoxy concrete was chosen. A total of 20 working days was used by the contractor, Pace Construction Co. of St. Louis, to place the 226,000-sq.-ft. of approximately  $\frac{1}{2}$ -in. thick wearing surface.

This was the first use of the system on large steel decks subjected to

a combination of severe environmental and heavy traffic conditions. As a result, the system was heavily monitored by the Missouri Highway and Transportation Department (MHTD), which awarded the University of Missouri a five-year contract for long-term inspection and testing of the wearing surface. The yearly inspection includes resistivity tests to qualitatively monitor cracking in the wearing surface, pull-out tests to establish the adhesion strength in tension between the wearing surface and the deck-plate, chain-drag/acoustic tests to detect delamination of the wearing surface from the deck-plate, observations to record wearing surface thickness, aggregate loss and other signs of deterioration.

Two visible cracks, one at each end of the southmost-eastbound lane (in the transition zone where the overlay thickness changes from  $2\frac{1}{2}$ -in. at the finger-type expansion device to  $\frac{1}{2}$  in. on the bridge) appeared after one year of service and were repaired using Transpo T-48 epoxy primer. No further crack



growth or deterioration of the wearing surface in the vicinity of the cracks were observed even after two additional years. While the cause of these cracks has not been conclusively established, differential thermal expansion is a probable culprit.

After approximately three years of service, the Transpo T-48 epoxy concrete wearing surface system has performed very well, with no additional visible cracking, loss of skid resistance, excessive wear or any other failure to date.

For more information on the Transpo System, please circle no. 30.

Vellore S. Gopalaratnam is an associate professor of civil engineering at the University of Missouri and Arthur M. Dinitz is president of Transpo Industries.

## EXODERMIC BRIDGE DECKS

An exodermic bridge deck is a 3.5-in. to 5-in. reinforced concrete slab on top of, and composite with, an unfilled steel grid. This efficient deck design permits significant weight savings compared to a standard reinforced concrete deck while providing the same or better stiffness and strength. The modular nature of the deck permits rapid erection, even during very short (overnight) work periods.

An exodermic deck is comprised of two main components: a fabricat-

ed steel grid similar to those that have been used for concrete-filled grid bridge decks for many years, and a reinforced concrete component, which is typically 3.5-in. to 5-in. thick, with rebar selected to provide negative moment capacity. The concrete component is made composite with the steel grid by the embedment of shear connecting elements known as "tertiary bars".

In place on a structure, the concrete handles compressive forces from traffic, while the steel grid han-



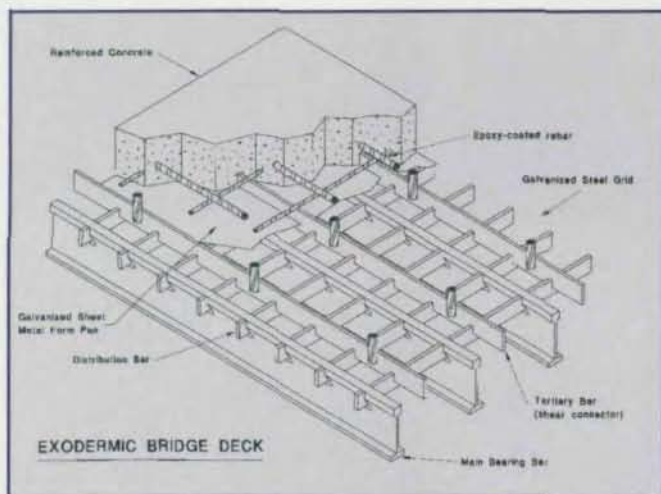

dles tensile forces.

One key benefit of an exodermic deck is its concrete riding surface. In fact the concrete component is often designed to the same specifications as the top half of a standard concrete slab, and can be installed and maintained using the same tools and techniques as standard bridge decks.

Exodermic decks are attached to the superstructure of the bridge by the use of headed shear studs, and the placement of concrete full depth through the grid over the supporting beams. No field welding or bolting of steel grid panels are required.

Because the design is modular, exodermic decks are ideal where deck construction or replacement must be accomplished rapidly. The concrete component of an exodermic deck can be pre-cast or cast-in-place. Pre-cast exodermic decks are used where traffic conditions require rapid deck replacement, generally during a nighttime work window. Such work permits the structure to be fully open to traffic during the day. Pre-cast exodermic projects include the Driscoll Bridge on the Garden State Parkway, the Pitman Creek Bridge (US 27) a 700-ft. deck truss in Somerset, Kentucky, emergency repairs on the Tappan Zee Bridge over the Hudson River, and the Troy-Menands (Route 378) Bridge over the Hudson River in Albany, NY.

Where traffic permits, an exodermic deck can be cast-in-place. In these cases, the steel grid acts as a rapidly-placeable, stay-in-place form. Significant time savings are realized over conventional forming, and the benefits of a lightweight deck realized at the same time. Examples include the Mohawk River

Bridge in St. Johnsville, NY, the Calumet Street Bridge in Philadelphia, the Popolopen Creek (Route 9W) Bridge in Highland Falls, NY, and the Clover Run Bridge in St. George, WV.

In addition to the re-decking of existing structures, Exodermic deck

is also used on new construction. Its light weight permits the entire bridge to be lighter in weight, and thus less expensive. Projects of this type include an interim viaduct that will be carrying 1700-ft. of I93 southbound in Boston during construction of the Central Artery project, and two new bridges in Ithaca, NY.

The Exodermic Bridge Deck Institute (914-722-2448) is an information source for exodermic design and construction, providing printed and computer-based design aids, suggested specifications, informational materials, and technical assistance to bridge engineers, owners, and contractors.

For more information, **circle no. 69.**

## OTHER DECKING PRODUCTS:

**U**nited Steel Deck, in affiliation with Nicholas J. Bouras, Inc., offer a wide variety of decking solutions. A wide variety of special finishes combine with roll forming and bending capabilities to provide solutions to the most unique decking demands.

For more information, contact Nicholas J. Bouras, Inc., P.O. Box 662, 475 Springfield Ave., Summit, NJ 07902-0662; 908/277-1617 or **circle no. 33.**

**W**heeling Corrugating Co. offers all types of premium steel decking, rolled to specific job requirements. The company

has six strategically located manufacturing/service locations to fully serve the fabricated structural steel industry.

For more information, call 304/234-2300 or **circle no. 99.**

**T**he Steel Deck Institute has released a new Design Manual that includes all the latest information for deck design and use, including metric specifications, metric load tables, short form specifications, code of recommended standard practice, and design examples.

For more information, contact: Steel Deck Institute, P.O. Box 9506, Canton, OH 44711 (216) 493-7886 or **circle no. 77.**

**E**pic Metals Corp. offers a wide range of decking solutions, including its MAXSPAN BRIDGE DECK FORM, an entirely new concept in the design of permanent metal deck forms for bridge deck slabs.

For more information, contact: Robert Paul, Product Engineer, Epic Metals Corp., Eleven Talbot Ave., Rankin, PA 15104 (412) 351-3913 or **circle no. 25.**

**H**heavy Duty Grip Strut bridge inspection walkways are suspended beneath bridge deck to enable close inspection of load-carrying members. The well-made catwalks span 24' openings with minimal deflection, which reduces the need and expense of extra supports. Also, gravel, mud, snow and ice fall through large diamond-shaped openings. Choices include 9, 10, or 11 gauge grating with serrated or non-serrated steel, and widths up to 36" with 5" integral toeboards, which eliminate extra welding.

For more information, contact: GS Metals Corp., R.R. 4, Box 7, Pinckneyville, IL 62274 (800) 851-9341 or (618) 357-5353 inside Illinois. or **circle no. 80.**

**G**rid Reinforced Concrete Deck manufacturers offer products with deck thicknesses ranging from 3-in. to 10-in. with weights as low as 45 lb./sq. ft. Modular grid panels also play a vital role in the complex traffic staging often required on rehabilitation projects.

For more information, contact: BGFMA at 412/547-2660 or **circle no. 21.**



# CONXPRT

The only connection design software approved by AISC

Beam: W18x50  
A 572 G 50  
Girder: W24x55  
A 572 G 50  
Vu: 40 Kips  
Beam Elevation: 0.0"  
(with respect to girder)  
 $\phi V_n$ : 87.4 Kips

FRAMING ANGLES - BEAM TO GIRDER WEB CONNECTION  
Girder Web Connection  
 $3/4" \phi \times 2"$   
A325-N STD Bolts  
Girder tw: 0.395"

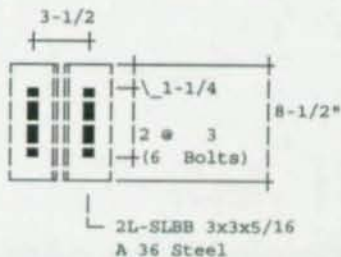
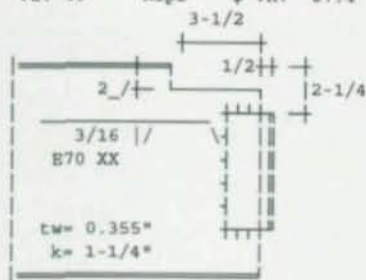

CONXPRT Module I designs various bolted and welded configurations of double angle, single plate, shear end plate and single angle shear connections

CONXPRT Module II designs directly welded flange plated moment connections. Its column stiffening routine provides stiffener and doubler plate design.

Left Connection: Type: Beam Flange Welded  
Id: Beam: W27x94  
A572 Gr 50  
M: 668 Kip-ft  
Flange: 0.745" x 9.99"  
Story Shear <-+: 0.0 Kip  
Left Offset: 0"

Right Connection: Type: Beam Flange Welded  
Id: Beam: W21x73  
A572 Gr 50  
M: 415 Kip-ft  
Flange: 0.74" x 8.295"

Factors: (✓) 5/3 Pbf  
( ) 4/3 Pbf  
Column Top ( )

Default Table: CONXPRT.VDT  
Col. Web Stiffeners: A36  
1: Two Horizontal Plates  
1/2 x7 x12-5/8"  
2: Two Horizontal Plates  
1/2 x7 x12"  
3: Two Horizontal Plates  
3/8 x5 x7"

Column Welds: Fu = 70 Ksi  
Weld Flange Web  
1: B.S. 3/8" 1/4"  
2: B.S. 3/8" 1/4"  
3: B.S. 5/16" 1/4"

Doubler Plates: 11-1/4" wide  
Btwn. Bot. Flgs: 1 PL 9/16"

For more information, or to order a copy of CONXPRT:  
Call AISC Software at 312/670-5411

or circle no. 1 on the reader service card in the back of this magazine



Setting Standards For Over 70 Years



# STRUCAD<sup>®</sup> 2000

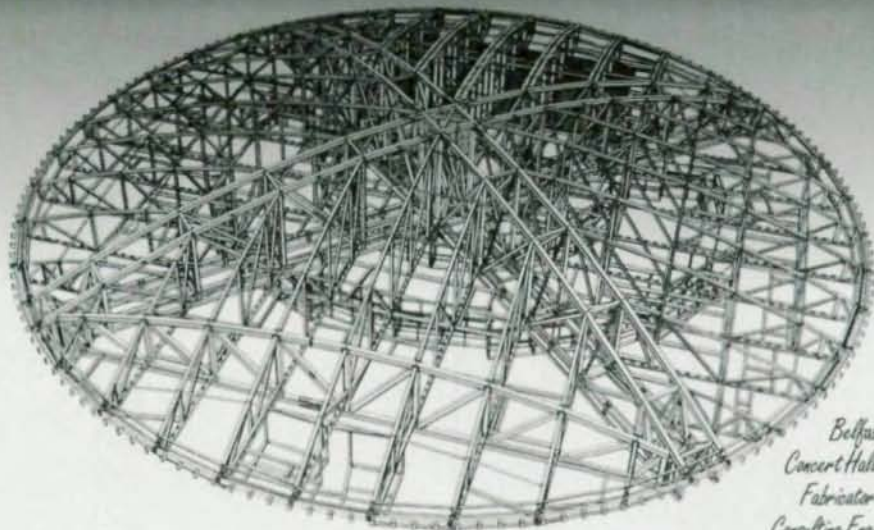

*Belfast, Northern Ireland  
Concert Hall dome detailed using Strucad  
Fabricator—Fisher Engineering Ltd.  
Consulting Engineer—Kirk McClure Martin*

## Finally, a 3-D detailing solution that will produce 100% of your work.

The future of steel fabrication is here. Steel Solutions introduces STRUCAD 2000—3-D detailing software that dispenses with manual drafting operations and results in productivity gains up to 5-to-1.

Developed specifically for steelwork, STRUCAD 2000 allows the user to interactively construct a 3-D wireframe model of a steel structure using a PC workstation. Connection types can be designated from an extensive library of standard connections or the user can easily create any non-standard detail at any location in the structure and save it to a library for reuse. Automatic clash detection eliminates error.

From the solid model, it is possible to produce all drawings and material lists completely automatically. STRUCAD 2000 automatically creates field erection drawings, shop detail drawings, fitting details, full-size templates, 3-D erection drawings, and CNC manufacturing data for a wide range of workshop machinery. Data downloads from STRUCAD 2000 directly to CNC machinery to ensure accurate and consistent results.

Integration between STRUCAD 2000's design and detailing data and the production control and management data of STEEL 2000 is seamless. Structures designed in STRUCAD 2000 will flow through all aspects of estimating,

detailing, muling, purchasing, receiving, production, shipping and erection with complete traceability. The estimated labor to produce any structure that is designed or detailed in STRUCAD 2000 can be printed from STEEL 2000 Estimate with a few keystrokes.

STRUCAD 2000 is interfaced to a large variety of other software packages including AutoCAD applications, STAAD-III from Research Engineers, Intergraph's Mica Plus Analysis and PDS, PDMS from Cadcentre, and PASCE from CE Automation, to name only a few.

Proven in production for six years, there are more than 400 STRUCAD systems installed throughout 22 countries. Now available in imperial units, Steel Solutions is pleased to market and support STRUCAD 2000 in the United States.

To facilitate use of this powerful tool in your plant, Steel Solutions offers a low-cost, five-day training course for your employees at our Training Center in Jackson, Mississippi. In addition, regular user group meetings at the Training Center will ensure that on-going requirements are constantly being integrated into STRUCAD 2000.

Call today to find out more about how STRUCAD 2000 can reduce your detailing costs and eliminate expensive manufacturing and site errors.

Please circle # 98



2260 Flowood Drive • P.O. Box 1128 • Jackson, MS 39215 • 601-932-2760 • Fax 601-939-9359  
Support/Development • Rt. 3, Box 312A • Buckhannon, WV 26201 • 304-472-2668 • Fax 304-472-3214  
STRUCAD is a registered trademark of ACECAD Software Ltd., England, U.K.



## STAAD3-2D

State-of-the-art 2D Structural Analysis and Design Software for \$595

Research Engineers, Inc. is proud to announce the arrival of STAAD3-2D, the most comprehensive 2D Structural Analysis and Design software in today's industry. STAAD3-2D is the 2D version of RE's world famous structural software STAAD-III. Equipped with powerful Analysis/Design, brilliant GUI, easy Visualization/Verification, and flexible Report/Query facilities, STAAD3-2D represents the true state-of-the-art in modern structural engineering.

STAAD3-2D supports STEEL/CONCRETE/TIMBER design per AISC (ASD & LRFD), ACI and AITC codes. With a price tag of \$595, it offers you the best value for all your 2D structural needs.

**Research Engineers, Inc.**  
22700 Savi Ranch  
Yorba Linda, CA 92687  
Toll Free: 1-800-FOR-RESE  
Fax: (714) 974-4771

## StruCAD\*3D

The Flagship Product for 3D Structural Analysis & Design

- Pop-Up & Pull-Down Menus
- Truly Interactive 3D Graphics
- Pre- and Postprocessing
- 3D AutoCAD Interface (in & out)
- AISC-ASD, AISC-LRFD, ACI-318
- Reinforced Concrete Design
- Wind & Gravity Load Generation
- Material Takeoff
- P-Delta and Thermal Analysis
- Pile-Soil Interaction
- Seismic & Machine Vibration
- Detailed Fatigue Analysis

Prices start at only \$249

Zentech, Inc. 8582 Katy Freeway, #205, Houston, TX 77024  
Tel (713) 984-9171 Fax (713) 984-9175

## Structural & Miscellaneous Steel Detailing CAD Programs

AutoCAD parametric LISP programs for preparing structural AND misc. steel shop drawings. All programs have been updated for 1995 and new programs have been added. Anchor bolts to roof opening frames and "everything between". Imperial and metric versions with USA, Canadian and European steel sections. 45-DAY MONEY BACK GUARANTEE. Discounts up to 30%. Buy only what you need. Used in the field for 8 years. Programs written by a detailer with 39 years experience. Extremely "flexible" programs. FREE telephone support. No maintenance fee. Reasonable yearly update fee. EXCELLENT PROGRAMS at a REASONABLE PRICE. Call for a FREE demo disk, list of programs, and prices.

### SSDCP

110 Shady Oak Circle, Florence, MS 39073  
Tel: 601/845-2146 (fax same)

## Integrated Structural Software Solutions From Softdesk The World's Largest Developer for AutoCAD

### Softdesk Modeler — Now Available

- ✓ Graphical Modeler with visualization and error checking tools
- ✓ 2-way link to STAAD-III for creating and updating model automatically
- ✓ Automatic 2D plan, section and elevation drawing generation

### Softdesk Structural Plans & Elevations

- ✓ Comprehensive set of tools to create 2D design/construction drawings
- ✓ Automated geometry and annotation features based on material data

### Softdesk Details

- ✓ State-of-the-art parametric programs for creating structural details
- ✓ Supports AIA CONDOC formatting and keynoting w/link to specification files
- ✓ Customizable material management system stores, retrieves and scales detail drawings

### Softdesk Steel Detailer

- ✓ Parametric programs for generating shop fabrication drawings including beams, columns, braces, stairs, anchor bolts and more
- ✓ Automatically generates Bill of Material and project level reporting

Call for a free brochure and preview disk!

Softdesk, Inc., 7 Liberty Hill Road, Henniker, NH 03242  
Tel (603) 428-3199 ext. 242; Fax (603) 428-7901

## Employment

ProCounsel searches for the right job for you, in the right geography, at the right money. Engineers, architects, draftspersons, detailers, checkers, estimators, plant managers/engineers/supers, erection professionals. Confidential. Fee paid. Buzz Taylor 214-741-3014. Fax: 214-741-3019 or leave a msg: 800-545-5900.

## Help Wanted

### Structural Steel Detailer And A Structural Steel Checker

Structural Steel Detailing company in business for 15 years has 2 positions available immediately. Both positions are considered permanent and full time. Currently operating with 10 in house detailers both on the board and with two different computer systems. Benefits include: paid holidays, paid vacation and retirement plan (401K). Salary will depend on experience. Please mail or fax resume and salary history to:

Callaway & Company Steel Detailing Inc.  
P.O. Box 64268  
Lubbock, Texas 79464  
Phone: (806) 794-7666 / Fax: (806) 794-1432

## FLORIDA — HELP WANTED

Fabricator looking for Engineers/Detailers to do computer and hand detailing. Mid-size AISC Level II plant. Beautiful part of Florida near Space Center. Excellent pay and benefits. Reply to:

### Industrial Steel, Inc.

Attn: Fred Wilson, Jr.

P.O. Box 346

Mims, FL 32754-0346

Ph: (407) 267-2341 Fax: (407) 383-9072

## DRAFTSPERSON

Structural Steel Detailer for a Norfolk/Virginia Beach, VA-based steel fabrication company. Experience with SDS II or Miscellaneous Detailing a plus. Benefits include: Health/Life Insurance, 401K Profit Sharing; Paid Vacations and Holidays.

Fax resume to:

(804) 628-0110

## Structural Bolting Handbook

Step-by-step instructions for: bolt installation using the turn-of-the-nut, calibrated wrench, twist-off bolt and direct tension indicator methods; pre-installation tests and inspection procedures for each method; dispute arbitration procedures; AASTHO/FHWA rotational capacity test procedures; bolt, nut and washer product and manufacturer identification markings; bolt, nut and washer dimensions; compatibility tables; and discussion of many critical bolting issues.

1-10 copies: \$9.00 ea.; 11-50 copies: \$8.00 ea.; 51+ copies: \$7.00 ea.  
For orders under \$75.00, add \$4.00 s&h; MI residents add 6% sales tax.

Prepayment by check, Visa or Mastercard only.  
Steel Structures Technology Center, Inc.,  
40612 Village Oaks Dr., Novi, MI 48375-4462  
Ph: (810) 344-2910 Fax: (810) 344-2911

## WE PROVIDE CADD STRUCTURAL STEEL DESIGN/DETAILING for Engineers, Fabricators and Contractors

### JOHNSON TECHNICAL SERVICES

231 E. 25th St.

Baltimore, MD 21218

Ph: 410/243-3269 Fax: 410/243-1963



## HEWLETT-PACKARD Computers/Peripherals

A complete line of used and refurbished HP Equipment to fill all your computer needs. Laser printers, scanners, disk drives, plotters (Draftpro, Draftmaster & Designjet), PC's and 9000 series workstations are available for immediate delivery. Call our toll free number for additional information and pricing.

**Ted Dasher & Associates**  
4117 2nd Avenue South  
Birmingham, AL 35222  
800-638-4833 fax (205) 591-1108

## GT STRUDL

## ADINA

Static, Dynamic, Linear, Nonlinear & Pushover Analysis  
Straight & Curved Steel Bridge Model & Load Generator

## SC Solutions, Inc.

Tel (415) 903-5050

Fax (415) 691-9452

## SC-Bridge

## SC-Push3D

## STEEL SHAPING SPECIALISTS

WE CAN BEND STRUCTURAL STEEL: THE EASY WAY, THE HARD WAY, IRREGULAR CURVES, OFFSETS, ELLIPTICAL SHAPES, CIRCLES, SEGEMENTS WITH TANGENTS AND WE CAN BEND IT TO TIGHT RADII WITH MINIMAL DISTORTION.

We also offer forging, the hot shaping of metals and the rolling and forming of tubing, rail and bars. Call or fax Frank Hutterer for more information.

Tel: 414-355-8220 Fax: 414-355-4698  
Max Weiss Co., Inc.  
8625 W. Bradley Rd., Milwaukee, WI 53224

## Comprehensive Review Manuals SE and PE (Civil) License

PE (Civil) six vol. (4200 pp). Calif Structural Engr (SE) five vol. (4170 pp). C.V. Chelapati, Ph.D., Editor. Covers solution techniques with several hundred solved problems. Invaluable reference for PE/SE exams. Highly acclaimed as excellent references for practicing engineers.

Call/write for detailed brochures. PEDP, Inc., 5912 Bolsa Ave., Suite 108-MS, Huntington Beach, CA 92649;

(714) 898-3658; Fax (714) 898-4635

## Structural Expert Series (SES)

A complete library of analysis and design software. This library is based on over 20 years of commercial software experience and is installed in over 2,000 companies throughout the world.

Library includes:

- 3D and 2D analysis
- Steel Design, ASD & LRFD
- Concrete design
- Timber design
- Masonry walls & retaining walls

For more information, or to receive a FREE demo kit, please call.  
ECOM Associates, Inc. • 8324 N. Steven • Milwaukee, WI 53223  
Ph: 414/365-2100 ext. 494 • Fax: 414/365-2110

## Computerized Structural Steel Detailing

Experienced Staff including licensed Professional Engineers with many years of detailing experience.

31 years of service to steel fabricators and contractors.

**R.A. Gress & Associates**  
176 Planebrook Road, Frazier, PA 19355  
Ph: (610) 644-3250 Fax (610) 889-4836

## AISC Professional Membership

Receive a **FREE Manual of Steel Construction** and 25% discounts on AISC publications, seminars and the National Steel Construction Conference. In addition, be eligible to serve on AISC Committees.

**For more information, contact:  
Libby Kop at 312/670-5409.**

## Barcode Tracking Systems, Sales & Service

- Asset Tracking/Inventory Control
- Turn-key Shipping/Receiving
- Work-in Process Tracking
- Time and Attendance
- Label Printing Systems
- Photo ID Badges
- Tool Room (Issues/Receipts)
- Preprint Labels

**Janes/Reiland, Inc.**  
17314 SH249, Suite 355, Houston, TX 77064  
Tel: 713/807-9091 Fax: 713/807-9094

## Advertisers' Index

Advertiser	Page Number	Circle No.
AISI	41	15
BGFMA	52	21
Nicholas J. Bouras	CII	33
Bristol Machine	38	113
CAST	46	27
Castelite	33	118
CDS	46	63
Chaparral Steel	11	43
Computer Detailing	48	
Computers & Structures	CIV	31
CONXPRT	55	1
Design Data	7	32
EJE Industries	28	46
Graphic Magic	24	92
GT Strudl	39	71
Integrated Eng. Software	50	87
Jobber Instruments	40	23
Lukens Steel	12	58
MDX Software	36	47
Metal Stud Systems	36	120
Metrosoft	CIII	51
Midsouth Bolt	22	74
NSCC	14	4
Nucor Fastener	25	38
Omnitech	24	52
Optimate	22	53
PC Simon	42	5
REBIS	8	26
Research Engineers	5	34
RISA Technologies	30 & 48	40
Ram Analysis	48	81
St. Louis Screw & Bolt	31	36
Steel Deck Institute	32	77
Steel Solutions	56	98
TradeARBED	3	35
Transpo Industries	21	30
Valmont Industries	13	106
Max Weiss	50	56
Wheeling Corrugating	17	99
Whitefab	21	55



Announcing version 3.0,  
incorporating intrinsic ergonomics which will  
catapult you to the next level of productivity.

# ROBOT V6

**THE FINEST IN STRUCTURAL ANALYSIS AND DESIGN SOFTWARE**

*intelligent proactive prompting*

We have even thought about details like our **intelligent proactive prompting system** that suggests next user action and displays prompts at the current mouse position to **reduce eye fatigue**, and full implementation of DLL technology allowing for **instantaneous switching** between modules, and choice of **beginner, advanced, and expert** menu levels or **customizable toolbars**, and ....

course ROBOT V6 is **not** a set of separate programs just glued together and adopted to work on PC - it is **written in C++ specifically for the PC platform**, providing a **rich set of features** for structural analysis and design, in one **easy to use** coherent and **ergonomically designed** user interface. **Versatility** of the single program and **fast solvers** combined with the addition of **new algorithms** (Kang's - emitter and wave propagation FEM meshing method) make ROBOT V6 a **powerful, truly interactive** tool, that meets the most **demanding engineer** requirements.

**metrosoft**  
STRUCTURES, INC.

332 Paterson Ave.  
E. Rutherford, NJ 07073

Please circle # 51

**yes**  
It runs with  
NetWare



IMAX DOME, DESIGN PRAT

**NEW PROMOTIONAL OFFER.**  
FOR DETAILS, PLEASE CALL 800-60-ROBOT,  
OR USE FAX BACK SERVICE AT 201-438-2733.

LIMITED WORKING VERSION OF PROGRAM WITH PRE-RECORDED EXAMPLES AVAILABLE. OVER 2000 USERS WORLDWIDE. FOR MORE INFORMATION CALL 201-438-4915 OR FAX TO 201-438-7058

**ROBOT V6**

Name: \_\_\_\_\_

Company: \_\_\_\_\_

Address: \_\_\_\_\_ City: \_\_\_\_\_ State: \_\_\_\_\_ Zip: \_\_\_\_\_

Tel.: \_\_\_\_\_ Fax: \_\_\_\_\_

I am:  structural engineer,  architect,  educator,  dealer,  other: \_\_\_\_\_

Please have a product specialist call me  Please send more information

Please send working demo version (limited to 25 elements and 25 nodes), with recorded macros of real design examples. Enclosed is a check for \$25 (plus applicable Tax in NJ). I have a system equal to or better than 386SX with math coprocessor, 8 MB RAM, 25 MB of free disk space, VGA monitor.

Metrosoft Structures, Inc., 332 Paterson Avenue, E. Rutherford, NJ 07073. Tel 201 438-4915, Fax 201 438-7058.

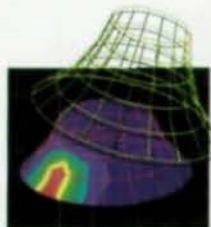

MSC

©1995 Metrosoft Structures, Inc. All brand and product names are trademarks or registered trademarks of their respective holders. Developer Tested Only. Novell makes no warranties with respect to this product.

UK • Germany • Italy • Belgium • Spain • Portugal • France • Brazil • Luxembourg • Poland • Jordan • Morocco



COMPUTERS AND STRUCTURES, INC.

# STRUCTURAL ENGINEERING SOFTWARE

*"When the Project demands Performance"*

# ETABS<sup>®</sup>

LINEAR AND NONLINEAR  
STATIC AND DYNAMIC  
ANALYSIS AND DESIGN  
of  
BUILDING SYSTEMS

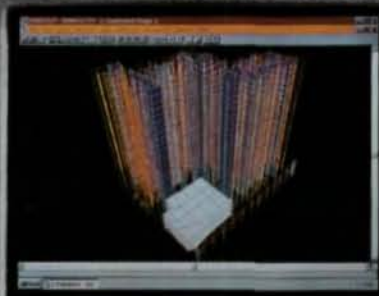
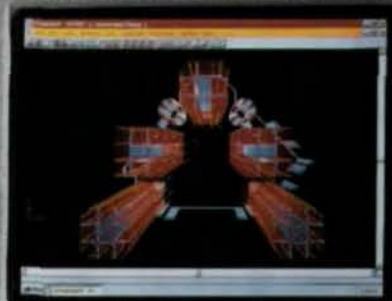
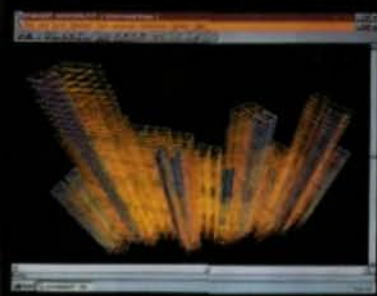

COMPUTERS &  
STRUCTURES  
INC.

For additional information:  
**Computers and Structures, Inc.**  
1995 University Avenue  
Berkeley, California 94704, USA

tel: (510) 845-2177  
fax: (510) 845-4096  
e-mail: [csi@csiberkeley.com](mailto:csi@csiberkeley.com)

COMPUTER APPLICATIONS FOR STRUCTURAL AND EARTHQUAKE ENGINEERING

The CSI logo and ETABS are Registered Trademarks of Computers and Structures, Inc.  
©1995 Computers and Structures, Inc.

Please circle # 31