

# MODERN STEEL CONSTRUCTION



February 1997

\$3.00

**A close-up  
look at  
hollow  
structural  
sections**

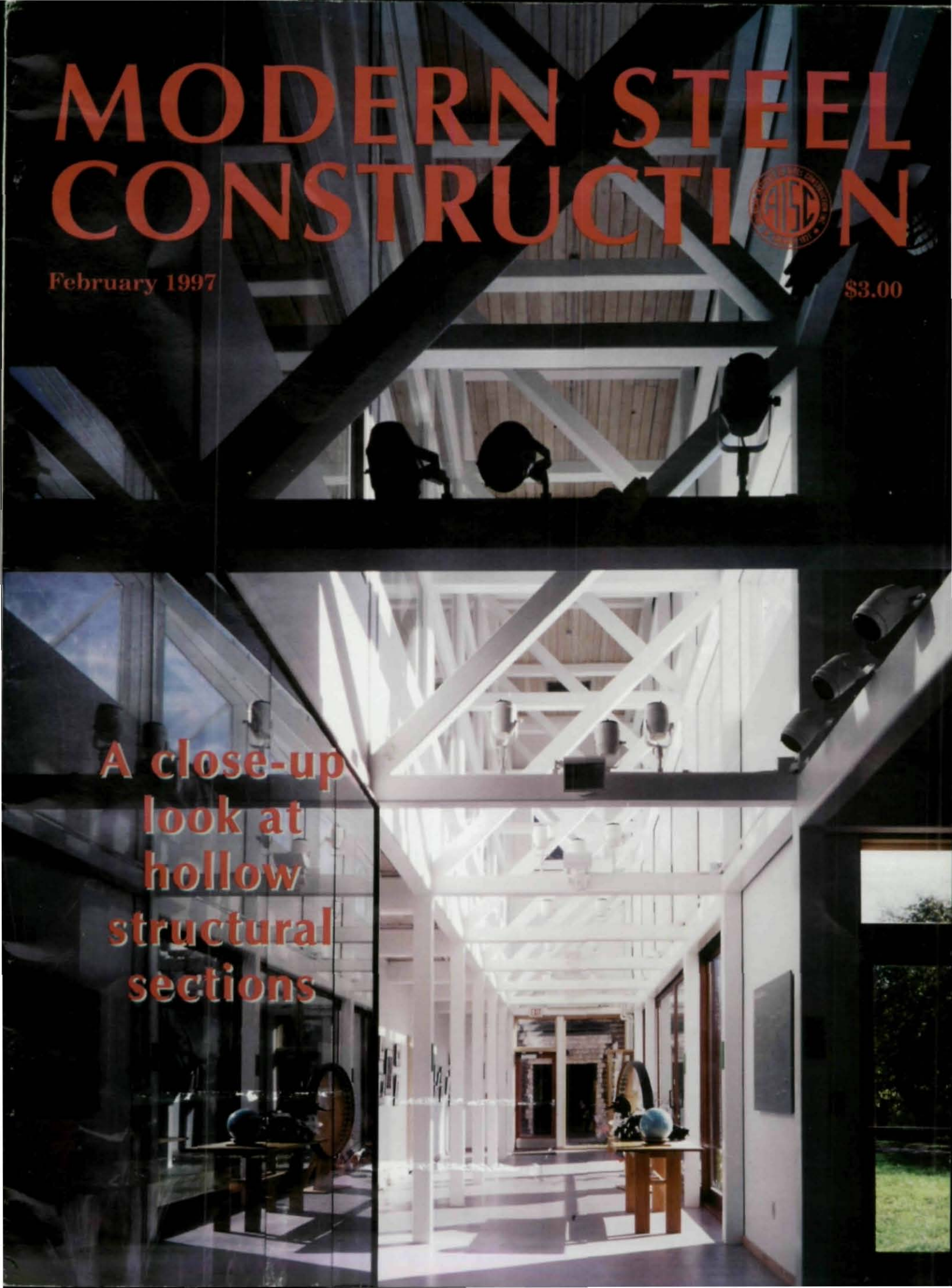





The New Columbia Joist Company

# JOISTS DUCTS

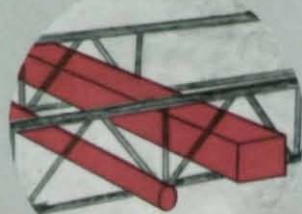

Joist  
Design  
Data  
Sheet #4

1. This information is based upon standard SJI loading, spans and NCJ panel configuration. Joists with special loading requirements may have different dimensions and need to be reviewed individually. If a specific duct location and size is required it must be explicitly noted on the contract documents.

2. No allowance has been made for fireproofing. The dimensions shown are maximum overall sizes capable of being passed through standard joists. If fireproofing is required the duct size must be reduced.

3. Due to the variability of joist girder configurations this table does not apply to girders.

JOIST SERIES	JOIST SIZES		MAXIMUM DUCT OPENING SIZES		
	JOIST DEPTH	BOTTOM CHORD PANEL LENGTH	DUCT SIZE		
			ROUND	SQUARE	RECTANGULAR
(K-Series)	8"	19"	5"	3½" x 3½"	3" x 6"
	10"	19"	6"	4½" x 4½"	3" x 8"
	12"	19"	7"	5" x 5"	3" x 8"
	14"	19"	8"	6" x 6"	5" x 9"
	16"	24"	9"	7½" x 7½"	6" x 10"
	18"	24"	10"	8" x 8"	6" x 10"
	20"	24"	10"	8" x 8"	6" x 11"
	22"	24"	10"	8½" x 8½"	7" x 11"
	24"	48"	16"	12" x 12"	10" x 18"
	26"	48"	16"	13" x 13"	12" x 18"
(KCS-Series)	10"	19"	5"	4" x 4"	3" x 6"
	12"	19"	6½"	5" x 5"	3" x 8"
	14"	19"	7"	6" x 6"	5" x 7"
	16"	24"	9"	7" x 7"	6" x 9"
	18"	24"	10"	8" x 8"	6" x 10"
	20"	24"	10"	8" x 8"	6" x 11"
	22"	24"	10"	8½" x 8½"	7" x 11"
	24"	48"	16"	12" x 12"	10" x 18"
	26"	48"	16"	13" x 13"	12" x 18"
	28"	48"	18"	13" x 13"	12" x 18"
(LH-Series)	18"	48"	10"	8" x 8"	7" x 12"
	20"	48"	12"	9" x 9"	7" x 14"
	24"	48"	14"	11" x 11"	9" x 16"
	28"	56"	16"	13" x 13"	10" x 20"
	32"	64"	20"	16" x 16"	13" x 22"
	36"	72"	22"	18" x 18"	16" x 22"
	40"	80"	26"	21" x 21"	17" x 27"
	44"	88"	28"	23" x 23"	20" x 30"
48"	96"	30"	25" x 25"	20" x 34"	



NICHOLAS J. BOURAS, INC.

Executive Offices, Engineering, and Sales

475 Springfield Avenue, P.O. Box 662

Summit, NJ 07902-0662

phone: (908) 277-1617 fax: (908) 277-1619

email: NJB-SALES@worldnet.att.net

web site: <http://www.njb-united.com>



United Steel Deck, Inc.





Is Northridge keeping you awake nights ?  
You can now sleep soundly!

The  
**STRONG COLUMN - WEAK BEAM**  
concept is back -  
and it's better than ever!

- **A 913 Grades 50 & 65** have a minimum CVN of 40 ft. lbs at 70°F, 14" Columns are available with AISC Sup.2, 20 ft. lbs at 70°F in the core area.
- **A 913 Gr. 50** is available with a maximum of 65 ksi in the flange.
- **A913 Gr. 65** is available with maximum Sulfur of 0.010% for improved through-thickness properties.
- **A913 Grades 50 & 65** can be welded without preheating using a low hydrogen electrode (<8ml/100gr).
- Today's low cost solution for seismic design incorporates the use of the "Dog Bone". The "Dog Bone" was patented by **ARBED** in 1989, but in 1995 was released to public domain. Combining the "Dog Bone" with **A913 Grades 50 & 65** and a well designed connection will provide the best seismic system for your next project.

**A913  
Grade 65**

**A913  
Grade 50**

# HISTAR

ASTM A913 is APPROVED BY:

- AISC-1995 for ASD and LRFD
- UBC-September 1996
- D1 Main Committee  
-September 1996

For detailed information, pricing, availability and literature, please contact Trade**ARBED**, Inc.

Tel: (800) 272-3369 Fax: (212) 355-2159

E-mail: [tradearbed@arbed.com](mailto:tradearbed@arbed.com)

Website Home Page: <http://www.arbed.com>

# ARBED

Please circle # 35



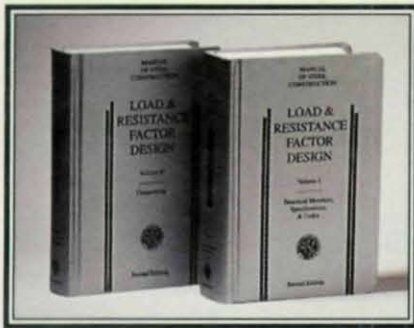

page 22



page 28



page 36

## MODERN STEEL CONSTRUCTION

February 1997

### ON THE COVER:

The Audobon Society Building in Portland, ME, is a good example of the use of tubes in innovative steel buildings.

Page 36

### 22 .....HAS LRFD'S TIME FINALLY ARRIVED?

*A look at why an increasing number of engineers are switching to LRFD*

### 28 .....EXTENSIVE PRE-ASSEMBLY RADICALLY CUTS TIME

*Innovative construction techniques limited bridge closure during an expansion project to just 12 days*

### 36 .....DESIGNING WITH STRUCTURAL TUBING

*The 1996 T.R. Higgins Award recognizes Donald Sherman for his work on HSS design and connections*

*Modern Steel Construction (Volume 37, Number 2). ISSN 0026-8445. Published monthly by the American Institute of Steel Construction, Inc., (AISC), One East Wacker Dr., Suite 3100, Chicago, IL 60601-2001; phone: 312/670-5407.*

#### Subscription price:

Within the U.S.—single issues \$3; 3 years \$85.

Outside the U.S.—single issues \$5; 1 year \$36; 3 years \$100.

**Please fax any address changes to 312/670-5403 or to the address below.**

*Postmaster: Please send address changes to Modern Steel Construction, One East Wacker Dr., Suite 3100, Chicago, IL 60601-2001.*

*Periodical postage paid at Chicago, IL and at additional mailing offices.*

*Advertising office: Facinelli Media Sales, O'Hare Lake Office Plaza, 2400 E. Devon Ave., Des Plaines, IL 60618 (847) 699-6049.*

**Please send subscription changes to: Modern Steel Construction, One East Wacker Dr., Suite 3100, Chicago, IL 60601-2001 or fax them to: 312/670-5403**

6 .....Off The Beam

19 .....News Briefs

9 .....Steel Interchange

47 .....Safety Products

12 .....Steel Quiz

49 .....Marketplace

14 .....Bridge Crossings

50 .....Advertisers Index



The Industry's Best Structural Engineering Software has just become the Most User Friendly ...

# STAAD-III

MULTIMEDIA VERSION

STAAD-III Release 22W Multimedia CD ROM. Redefining **User Friendliness** for the Structural Engineers. **Audio-visual movie clips** to walk you through the entire process of model generation, analysis/design commands, and result verification/visualization. However complex your task is, expert help is **just a click away**.

The Multimedia CD ROM also contains **complete on-line manual**. Forgot a command syntax? Need to understand a theory? — just use the **Search** tool on the Reference manual. Detailed **Example and Verification** problems cover all aspects of the modeling, analysis, design, and verification process.

STAAD-III Release 22W introduces **STAPLE**, a unique script language that allows you to create and integrate **your own programs** with STAAD-III. Easy-to-use and easy-to-learn, STAPLE is the true equivalent of a **structural engineers' operating system**.

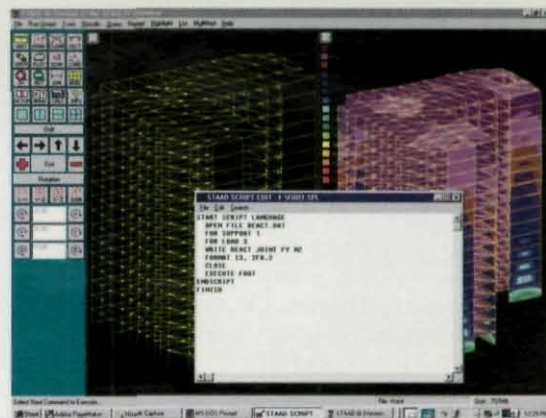

## STAAD-III Release 22 Highlights

- **STAPLE: STAAD-III script language** — Complete access to STAAD-III database, design customized displays and outputs.
- **Solid Element** — Eight-noded, isoparametric 3D finite element — stand-alone or in combination with beam/plate/shell elements
- **Compression-only members**
- **Automatic Spring Support Generator** for foundations
- **Steel Design for Torsion** -per AISC Pub. T114
- **Enhanced Floor Load and Wind Load Generator**
- **Enhanced Tapered Member Design**

## Free STAAD-III Seminar at a city near you ...

*Seeing is Believing! Experience STAAD-III Multimedia version first hand. The seminars will be held during February/March 1997. Please contact Research Engineers for seminar schedule and reservation.*

Headquarters: 22700 Savi Ranch, Yorba Linda, CA 92887-4608 Toll Free: (888) 4-STAAD3 Fax: (714) 974-4771  
e-mail: info@reiusa.com Internet: http://www.reiusa.com

US Eastern Region: 865 Turnpike St., North Andover, MA 01845 Ph: (508) 688-3626 Fax: (508) 685-7230

USA • UK • Germany • France • Canada • Japan • China • Korea • Singapore • Norway • India

Please circle # 5



**Research Engineers, Inc.**



During the past few months, many readers have probably noticed (I hope!) increased coverage of bridges and steel bridge issues in *Modern Steel Construction*. Every issue since October has had a bridge feature and we've added Bridge Crossings as a monthly department. I hope everyone is enjoying the added bridge coverage and I'd love to hear your reaction (fax: 312/670-5403; email: melnick@aiscmail.com).

Much of this change has been spurred by the National Steel Bridge Alliance, a division of AISC that acts as the "umbrella" organization for all steel bridge related activities in the U.S. Participants include steel producers, fabricators, owners, designers, general contractors and erectors—essentially everyone who has any interest in designing and building steel bridges. It's mission is to increase steel bridge market share through marketing, improving technology, education and legislative action—and its staff helps to develop articles on bridge design and construction for MSC. For more information on the NSBA, contact Arun Shirole, executive director (ph: 612/537-7073; fax: 612/537-4997; email: shirole@aiscmail.com).

The NSBA is actually symbolic of the direction AISC has been taking of late. Just as the NSBA serves to bring together disparate groups with a common interest in bridges, AISC has of late been endeavoring to do the same for all aspects of structural steel design and construction. For example, AISC has started to work more closely with AWS on welding issues, particularly for seismic design and for developing standards for welds on architecturally exposed steel.

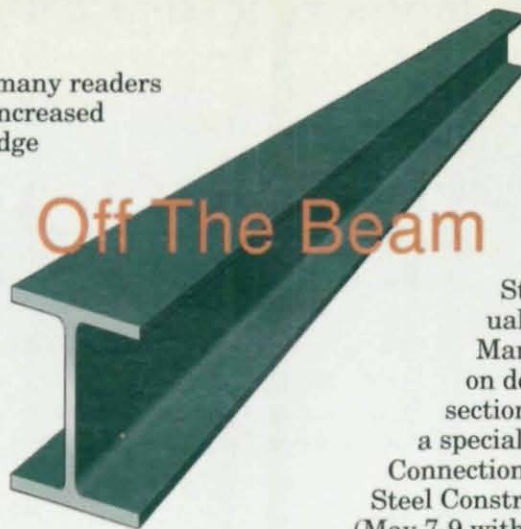

## Off The Beam

Perhaps the most involved joint effort, however, has been with the Steel Tube Institute and AISC.

This summer AISC will publish, in cooperation with STI and the American Iron and Steel Institute, a new tube manual. The HSS Connections

Manual will be the definitive work on designing with hollow structural sections. In addition, AISC will offer a special short course on HSS

Connections after this year's National Steel Construction Symposium in Chicago (May 7-9 with the short course on May 10; to receive more information, call 800/787-0052, ext. 120 or point your favorite web browser to AISC's homepage at <http://www.aiscweb.com>).

And speaking of the NSCC, its another example of AISC trying to bring together different elements of the steel industry. Co-sponsors include: American Galvanizers Association; AISI; ASCE; AWS; Canadian Institute of Steel Construction; Construction Industry Institute; CASE; Edison Welding Institute; Mexican Institute of Steel Construction; National Erectors Association; National Institute of Steel Detailing; Steel Deck Institute; Steel Erectors Association of America; Steel Joist Institute; Steel Plate Fabricators Association; Steel Service Center Institute; Steel Structures Painting Council; and Steel Tube Institute of North America. And this year's NSCC will feature tracks on engineering, engineering management, erection, fabrication, and welding.

*Scott Melnick*  
Editor & Publisher

Who's Who at MSC	Advertising in MSC	AISC Officers
<p><b>Editor &amp; Publisher: Scott Melnick</b> ph: 312/670-5407 email: melnick@aiscmail.com</p> <p><b>Exec. Editor: Patrick M. Newman, P.E.</b> ph: 312/670-5417 email: newman@aiscmail.com</p> <p><b>Sr. Tech. Advisor: Charlie Carter, P.E.</b> ph: 312/670-5414 email: carter@aiscmail.com</p> <p><b>Sr. Tech. Advisor: Jacques Cattan</b> ph: 312/670-5430 email: cattan@aiscmail.com</p> <p>Editorial Offices: One East Wacker Dr., Suite 3100 Chicago, IL 60601-2001 fax: 312/670-5403</p>	<p><b>Account Manager: John Byrne</b> ph: 847/699-6049 fax: 847/699-8681 email: jabber10@ix.netcom.com</p> <p>Advertising Offices: 2400 E. Devon Ave., Suite 267 Des Plaines, IL 60018</p> <p>To receive a media kit, call, fax or email</p> <p style="text-align: center;">John Byrne</p> <p>or view advertising information on AISC's home page on the World Wide Web at:</p> <p style="text-align: center;"><b><a href="http://www.aiscweb.com">http://www.aiscweb.com</a></b></p>	<p>Chairman: Robert E. Owen 1st Vice Chairman: Robert D. Freeland 2nd Vice Chairman: Robert G. Abramson Treasurer: Jerry Milligan Secr. &amp; Gen. Counsel: David Ratterman</p> <p>President: H. Louis Gurthet, P.E.</p> <p>Vice President: Morris Caminer (Finance &amp; Administration)</p> <p>Vice President: Nestor Iwankiw, P.E. (Engineering &amp; Research)</p> <p>American Institute of Steel Construction, Inc. One East Wacker Dr., Suite 3100 Chicago, IL 60601-2001 ph: 312/670-2400 fax: 312/670-5403</p>



SDS/2  
leaves  
nothing  
to the  
imagination

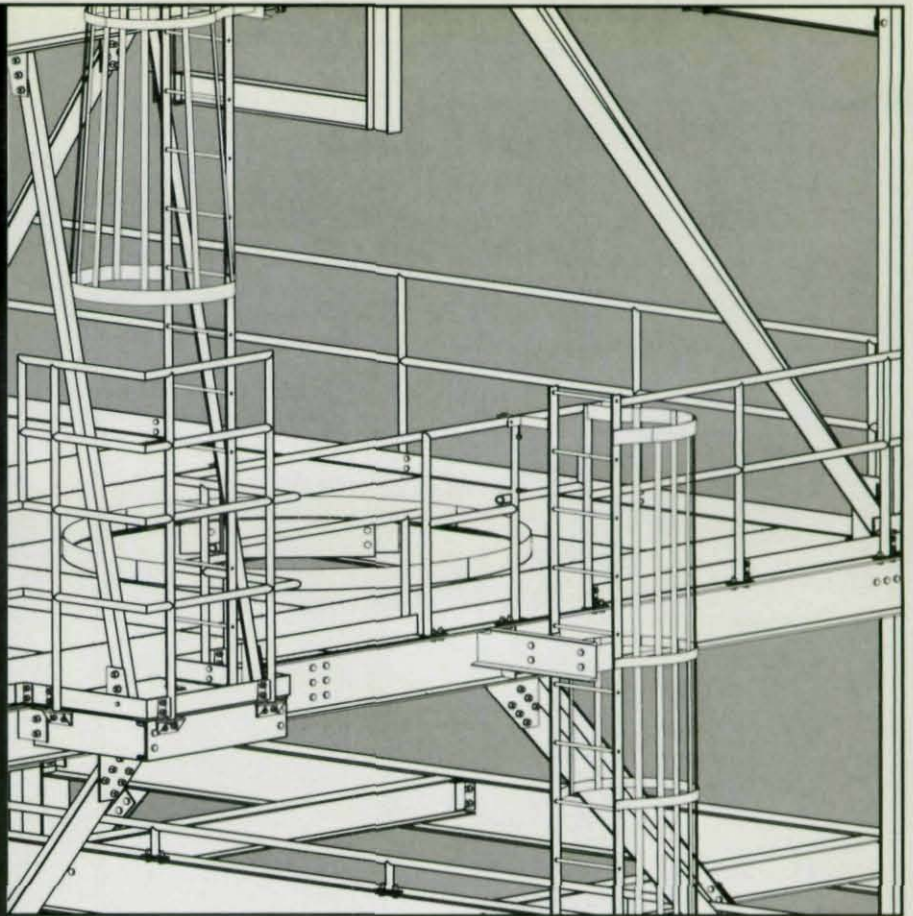

*Compliments of Safety Steel, Victoria, Texas*

Imagine...a software system that automatically gives you:

- Shop Drawings
- CNC Data for Shop Equipment
- Connection Design Calculations
- Labor for Estimating
- Ordering & Inventory Data
- Revision Management
- Job, member status and much more

With SDS/2 imagination becomes reality. You get details, estimates and ordering information on every piece of steel in the job—right down to the nuts, bolts and washers. SDS/2 is the only comprehensive software system for every phase in the steel industry. With SDS/2, each phase of a project creates and stores information that is integrated and utilized in the next project phase, eliminating costly data re-entry time. Project schedules, job status, drawing submittal/approval and erection planning can all be easily done using SDS/2. Whether you are an owner, engineer, fabricator or detailer, you will be able to see the money saving benefits of using SDS/2.

Don't leave anything to the imagination on your next project. Call today for more information or to set up your own personal demonstration of the SDS/2 products that include:

- Estimating
- CNC Interface
- Engineering Design
- Production Control
- Detailing
- DesignLINK

**DESIGN  
DATA** 

"First in...software, solutions, service"  
402-476-8278 or 1-800-443-0782  
e-mail: [info@dsndata.com](mailto:info@dsndata.com)

Please circle # 32



INTRODUCING

# RAMFRAME

*Something The Competition Just Can't Compute.*

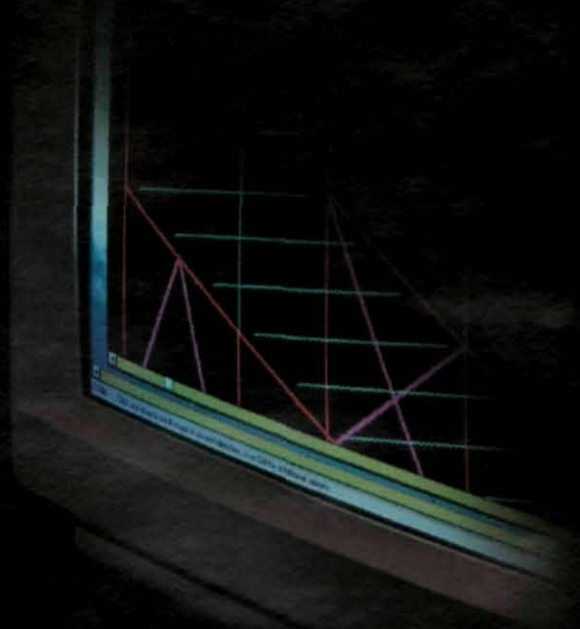

Fully Integrated with **RAMSTEEL™**  
for Gravity Load Framing Design



Once again we have come up with something the competition just can't compute.

While any 3D structural software will get you to a solution, **RAMFRAME™** will get you there in a fraction of the time by automating the most time consuming design tasks for structural engineers.

Modern Steel Construction Magazine's 1996 Annual Software Survey rated Ram Analysis' software **HIGHEST** in the industry overall.

Find out why more and more structural engineers are turning to Ram Analysis.

**RAMFRAME™**  
Integrated 3D Finite Element Analysis  
and Design for Buildings



**Please circle # 81**



# STEEL INTERCHANGE

*Steel Interchange* is an open forum for *Modern Steel Construction* readers to exchange useful and practical professional ideas and information on all phases of steel building and bridge construction. Opinions and suggestions are welcome on any subject covered in this magazine. If you have a question or problem that your fellow readers might help you to solve, please forward it to *Modern Steel Construction*. At the same time, feel free to respond to any of the questions that you have read here. Please send them to:

**Steel Interchange**  
**Modern Steel Construction**  
**One East Wacker Dr., Suite 3100**  
**Chicago, IL 60601-2001**

\*\*\*\* Questions and answers can now be e-mailed to: [newman@aiscmail.com](mailto:newman@aiscmail.com) \*\*\*\*

The following responses from previous Steel Interchange columns have been received:

**Are there any published design aids or criteria for the design of a bolted moment ridge splice connection similar to the one shown? If not, would the tee stem analogy be an acceptable alternative to designing the plate thickness for the connection?**

(Editors note: This question was also answered in the January 1997 issue of *Steel Interchange*)

When the angle between the rafters is relatively flat, the ridge connection can be treated as

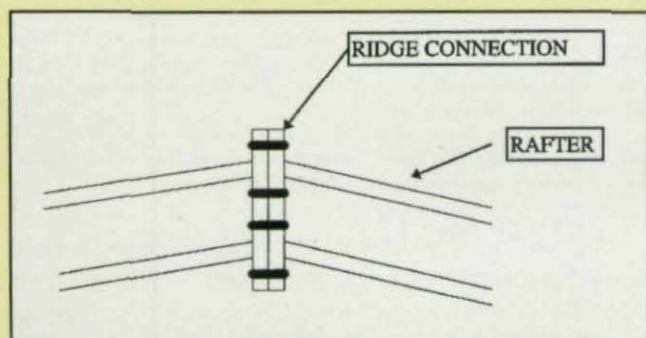

an extended end-plate moment connection. Allowable Stress Design (ASD) procedure and Load and Resistance Factor Design (LRFD) procedure can be found in the *AISC Manuals*. Also *AISC Steel Design Guide Series No. 4, Design Guide for Extended End-Plate Moment Connections*, by Thomas Murray provides comprehensive information on this topic.

**Wing Ho, P.E.**  
**CU/H2A, Inc.**  
**Princeton, NJ**

Answers and/or questions should be typewritten and double-spaced. Submittals that have been prepared by word-processing are appreciated on computer diskette (either as a Wordperfect file or in ASCII format).

The opinions expressed in *Steel Interchange* do not necessarily represent an official position of the American Institute of Steel Construction, Inc. and have not been reviewed. It is recognized that the design of structures is within the scope and expertise of a competent licensed structural engineer, architect or other licensed professional for the application of principals to a particular structure.

Information on ordering AISC publications mentioned in this article can be obtained by calling AISC at 800/644-2400.

## Another answer:

There are several publications which could be used as references for the design of a bolted moment ridge splice, they are as follows:

Page 7-239 to 7-244 of *Structural Engineers (S.E.) License Review Manual*, Volume 3, 4th Edition published by PEDP (Professional Engineers Development Publications, Inc., ph: 714/898-3658; fax: 714/898-4635) has a solution to a problem which is similar.

The *AISC Steel Design Guide 4, Extended End-Plate Moment Connections*, by Thomas Murray; the 2nd edition of the *LRFD Manual of Steel Construction, Volume 2 Connections* on pages 10-21 to 10-35 for the design of end-plate moment connections; and, pages 856-860 of *Steel Structures: Design and Behavior*, 4th Edition by C.G. Salmon and J.E. Johnson, published by Harper-Collins.

The last three publications can be purchased through AISC.

**Timothy M Young**  
**Cumberland, VA**

## Is it permissible to accelerate cooling of structural steel after the application of controlled heat?

Because the maximum temperature permitted by LRFD Specification Section M2.1 for heat straightening, curving, or cambering is below any critical metallurgical temperature for the material being heated, the use of compressed air, water mist, or a combination thereof is permitted to accelerate the final cooling of the heated material, unless specifically prohibited in the bid documents. For members to be used in dynamically loaded (bridge) applications (i.e. where fatigue and toughness are design issues) it is recommended that



# STEEL INTERCHANGE

such accelerated cooling not begin until the temperature has dropped below 600 degrees F. This limitation is more historical than technical in nature. As a fair balance between the needs of the fabricator and the concerns of the owner, it provides an added safeguard to prevent the abuse of excessive cooling and undesirable residual stresses should accepted procedures not be strictly monitored.

## **When must high-strength bolts be ordered as a bolt/nut assembly from a single manufacturer?**

(Editors note: This question was also answered in the December 1996 issue of Steel Interchange)

High strength bolts and nuts are not required to be manufactured by the same manufacturer, in fact, a number of manufacturers make only the nuts or bolts. The lubrication and testing of the assemblies noted in the December 1996 Steel Interchange answer are done after the bolts and nuts are brought together as assemblies for shipping to assure that the assemblies will provide the required tension when installed.

**Gerald E. Schroeder, P.E.**

**Federal Highway Administration  
Columbia, SC**

## **How can one evaluate the strength of a girder or column web or HSS wall with a single-plate connection or stiffened seated connection welded to it?**

When such connections frame back-to-back on a girder or column web, the designer need only consider the total end reaction of the connections and ensure that the shear strength of the supporting material is adequate; any incidental eccentricity will be transferred through the support rather than into it, due to the higher relative stiffness of the framing beams. When framed to one side of the web, however, the concerns exist that the web may yield locally, reduce the column strength due to local deformations, or punching shear limit state may control.

Sherman and Ales in a 1991 National Steel Construction Conference presentation demonstrated that local yielding of the support was not a concern due to the self-limiting nature of simple con-

nection end rotation and that member strength was unaffected by the associated local deformations. This same research indicated that punching shear may be of concern for relatively thin supporting material thicknesses. Accordingly, it is recommended that the minimum supporting material thickness be:

$$t_w \geq \frac{(F_y t)_{pl}}{1.2 F_{uw}}$$

Thus, for A36 plate material, the minimum support thickness is then  $0.52t_{pl}$  for A36 supporting material and  $0.72t_{pl}$  for A572 Gr. 50 supporting material; for A572 Gr. 50 plate material, the minimum support thickness is  $0.46t_{pl}$  for A36 supporting material and  $0.64t_{pl}$  for A572 Gr. 50 supporting material. These minimum thicknesses would also be applicable to a welded plate tension connection (uniform stress distribution). However, for cantilevered bracket connections, which do not have self-limiting rotations; yielding must also be checked.

## **New Questions**

Listed below are questions that we would like the readers to answer or discuss.

If you have an answer or suggestion please send it to the Steel Interchange Editor, Modern Steel Construction, One East Wacker Dr., Suite 3100, Chicago, IL 60601-2001. Questions can also be sent via e-mail to [newman@aismail.com](mailto:newman@aismail.com).

Questions and responses will be printed in future editions of Steel Interchange. Also, if you have a question or problem that readers might help solve, send these to the Steel Interchange Editor.

**Recently, I contacted several companies with inquires regarding nut couplings for connecting two pieces of 1½" diameter galvanized A36 anchor bolts. Virtually no information pertaining to safe working load; catalog cuts showing size, shape and threaded dimension; or, ASTM material is available to the structural engineer from the nut and bolt industry. Please advise me of information sources.**

**Timothy E. Donovan, P.E.**  
**North Weymouth, MA**

**Are special tolerances required to accommodate the cladding on structural steel frames.**

**When are notch toughness properties required for structural steel members.**



# Lots of Avenues. One Decision.

Courtesy of the Chicago Convention & Tourism Bureau  
Michael W. McQuerry



Thousands pass over Michigan Avenue's historic steel bridge to visit Chicago's Magnificent Mile for the best shops, galleries, and restaurants. Your best bridge to steel innovation this year is the National Steel Construction Conference. The decision is simple, come see what we have to offer.



Setting Standards for 75 Years.

<http://www.aiscweb.com>

**Faxback Service: 1.800.787.0052, ext.110**



American Institute of Steel Construction, Inc. - One East Wacker Drive - Suite 3100 - Chicago - 312.670.5417

Please circle # 34



# STEEL QUIZ

**S**TEEL QUIZ, A MONTHLY FEATURE IN *MODERN STEEL CONSTRUCTION*, allows you to test your knowledge of steel design and construction. Unless otherwise noted, all answers can be found in the *LRFD Manual of Steel Construction*. To receive a free catalog of AISC publications, circle #10 on the reader service card in the back of this magazine.

## QUESTIONS:

1. Visually, how can one distinguish between Type 1 and Type 3 ASTM A325 high-strength bolts?
2. LRFD Specification Section A2.2 permits some inelastic, but self-limiting, deformation of a structural steel part. Which of the following

connection elements could not be considered a self-limiting case?

- a. shop bolted/field bolted double angles
  - b. a shear end plate
  - c. the stiffener in a stiffened seated connection
  - d. a shop welded/field bolted single angle
3. In the AISC Specification, beams and their connections are designed to have equivalent reliability, True or False?
  4. Describe undercut and overlap in a fillet-welded joint.
  5. Can crane rail be obtained end-hardened and heat-treated?
  6. When steel is specified to be painted without indication of required surface preparation method, what surface preparation is used?
  7. What is the nominal thickness of an ASTM F436 circular washer?
  8. What is a W610x82?
  9. Where will the 1997 AISC National Steel Construction Conference be held?
  10. When checking an I-shaped beam for local flange buckling (LRFD Specification Appendix F, Table A-F1.1), the term  $k_c$  is used, which is a function of the beam web slenderness ratio  $h/t_w$ . Why is flange local buckling affected by the web slenderness?



## Custom Tubular Sections Made To Your Specific Shapes & Sizes

ASTHETICALLY  
APPEALING

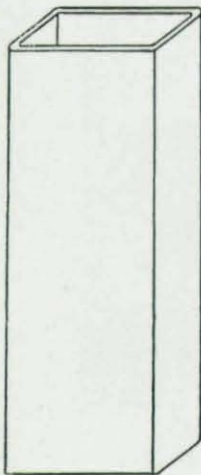

PROPERTIES TAILORED  
TO SPECIFIC NEEDS

EXCELLENT TORSIONAL  
PROPERTIES

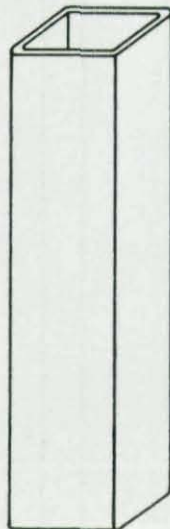

EXCELLENT  
COLUMN STRENGTH

LARGE SIZES  
14" TO 30"

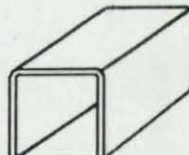

SQUARES

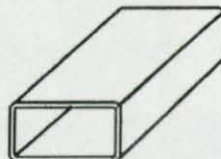

RECTANGLES

HEAVY WALL  
THICKNESS 3/8" - 5/8"

- Sizes up to 30" square
- No minimum order size

- Section properties available on request

VALMONT TULSA • P.O. BOX 2620 • TULSA, OKLAHOMA 74101  
ATTN: GARY HANEY • CALL TOLL FREE: 1-800-331-3002  
Please send additional information about custom tubular sections.

NAME \_\_\_\_\_ TITLE \_\_\_\_\_

FIRM \_\_\_\_\_

ADDRESS \_\_\_\_\_

CITY \_\_\_\_\_ STATE \_\_\_\_\_

PHONE \_\_\_\_\_ ZIP \_\_\_\_\_

Please circle # 30

Continued on page 16



# IF you think ZINC is only a vitamin supplement, THINK AGAIN

Much more ZINC is used to protect steel structures against corrosion.

When erecting a Hot-Dip Galvanized structure, don't forget the Hot-Dip Galvanized Fasteners. "Today", Hot-Dip Galvanizing is the best way to provide cathodic protection to the bolts, screws, washers, nuts, rivets, etc., on a structural steel project.

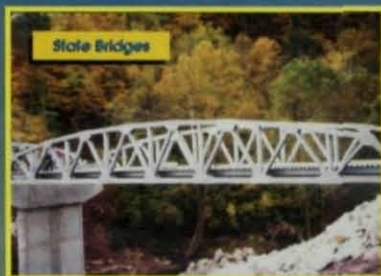

Another first for Voigt & Schweitzer - a "High Temperature Ceramic Lined Kettle" designed exclusively for centrifuge work. This provides an incredibly "clean" surface on threaded galvanized material.

Our newest galvanized fastener operation is our **V&S Cattie** plant in **Philadelphia, PA.** with years of experience and modern technology this plant will put out the finest quality fastener product.

A unique custom Hot-Dip Galvanizing Facility has been set up at **V&S Pilot**, our **Poca, WV.** location, which specialized in fasteners and hardware components.

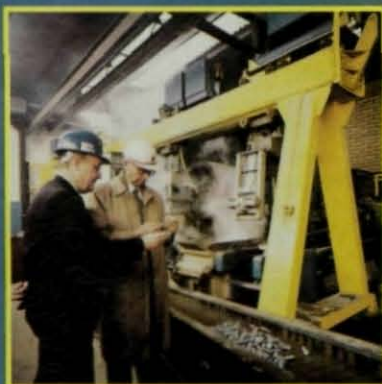
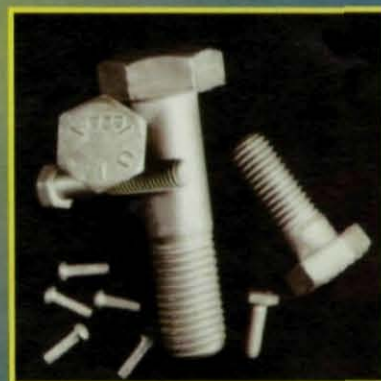

Our chairman Mr. Voigt insists on strict quality and inspects with pride products galvanized in our first fully automated fastener galvanizing line in Germany. We share his pride in the United States in producing a **Top Quality** fastener product.

Voigt & Schweitzer has over 100 years of experience with five United States locations and over 30 plants worldwide.

Voigt & Schweitzer is your best source for Hot-Dip Galvanizing.

Columbus Galvanizing  
Voigt & Schweitzer, Inc.  
Columbus, OH  
(614) 443-4621

Voigt & Schweitzer  
Galvanizers, Inc.  
Redford, MI  
(313) 535-2600

V&S Cattie  
Galvanizing, Inc.  
Philadelphia, PA  
(215) 739-8911

V&S Pilot  
Galvanizing, Inc.  
Poca, WV  
(304) 755-2949

V&S ProGalv, Inc.  
Muskogee, OK  
(918) 683-5005

Member American Galvanizers Association, CSI, AIA, AISC, ASA. ASTM Spec/Military Spec 45208A qualified.

Members of the Industrial Fastener Institute

Please circle # 102



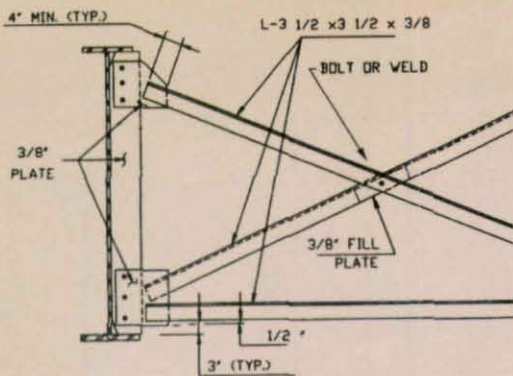

# BRIDGE CROSSINGS

No. 4, February 1997

Practical Information For The Bridge Industry

## BRIDGE FATIGUE MYTHS

By Dennis R. Mertz, P.E., Ph.D.

### Categorizing Details: What if a detail experiences no applied tension?

Many times, engineers look at welded steel bridge details, either on contract drawings or on actual bridge members, and categorize the details into one of the AASHTO-specified detail categories, A through E', based merely on the detail's geometry. However, such categorization is premature. The detail must be expected to experience applied tensile stresses due to the specified design loads before they should ever be considered as a fatigue-sensitive detail and labeled as one of the AASHTO detail categories.

This fact is inherent to all of the AASHTO specifications, yet even learned steel experts can become confused by information beyond that contained in the specifications. For example, knowing that residual stresses play an important role in the performance and design of fatigue-sensitive details, even experts have suggested restricting the use of what they deem to be fatigue-sensitive details, even if the detail does not experience tensile stresses due to the design loads. This misinterpretation of the specifications results because they know that residual stress due to welding are tensile near the detail.

Residual stresses are very localized. These locked-in stresses may cause cracking in a very localized region near a weld, but these cracks will not grow if the applied stresses do not include a tensile component.

With the 1974 *Interim AASHTO Specifications*, the *AASHTO Standard Specifications for Highway Bridges* no longer considered details that experienced only fluctuating compressive stresses for fatigue design. In *National Cooperative Highway Research Program (NCHRP) Report 147*, which reported on one of the research efforts that formed the basis of the interim specifications, Professor John W. Fisher of Lehigh University observed:

"Failures occurred due to destruction of the primary tension flange of all beams with details subjected to tension-tension and partial reversal of stress. Crack growth also was observed in the compression flange. However, the growth arrested after the cracks grew out of the tensile residual stress region unless there was a reversal of stress. There were no failures when the flange was subjected to a compression-compression stress cycle."

In the current edition of the *Standard Specification for Highway Bridges*, 16th Edition, details to be considered for fatigue are tabularized in Table 10.3.1B. In this table, one column is defined as "Kind of Stress."

Examination of this column reveals that no entry for details subjected to compressive stresses alone, only those experiencing a range in tensile stresses or reversal of stresses involving both tension and compression during the stress cycle, are considered for fatigue.

The *LRFD Bridge Design Specification*, First Edition, is more explicit in their description of the application of the fatigue provisions. In Article 6.6.1.2.1, the provisions state: "These provisions shall be applied only to details subjected to net applied tensile stress." In other words, only if during the passage of a truck the detail is anticipated to cycle into tension due to the net applied stresses—both due to dead load and live load—is the detail considered for fatigue.

### Designing for Fatigue: How many cycles are enough, or is a bridge's fatigue life gone after 2 million cycle?

A typical fatigue-resistance curve, in log-log space, is shown in Figure 1. The sloping portion of the curve represents the finite-life fatigue resistance. Along this part of the curve, for a given stress range, a corresponding finite life defined by the curve is anticipated. The dashed horizontal portion of the curve represents the infinite-life fatigue resistance. If all of the stress ranges experienced by a detail are less than the stress range defined by the horizontal line, it is anticipated that the detail will not crack. The dashed horizontal portion of the curve is called the constant-amplitude fatigue threshold.

Ignoring, for the moment, the constant-amplitude fatigue threshold, the curve can be thought to represent the locus of points of equal fatigue damage, as shown in Figure 2. Anywhere in the region to the left of the curve, the steel detail is considered safe (the term "uncracked" would not be appropriate, as all materials contain very small flaws). Anywhere in the region to the right of the curve, the steel detail is considered cracked (the term "unsafe" would not be appropriate as the cracks may be smaller than the critical size). Anywhere along the curve, the details would experience equal fatigue damage (simplistically thought of as having a crack size equal to the size used to define cracking). This equal amount of fatigue damage accumulates faster (in less numbers of cycles) at higher stress ranges, and slower (in more numbers of cycles) at lower stress ranges. In the end, however, the damage is considered equal anywhere along the curve despite the magnitude of the stress range.

Table 10.3.1A of the *Standard Specifications* represents fatigue-resistance curves for all of the fatigue categories, A through E'. The allowable stress ranges for more than two million cycles are the constant-amplitude



# MODERN STEEL CONSTRUCTION Reader Service Card

Please type or print only

name \_\_\_\_\_

company name \_\_\_\_\_

address \_\_\_\_\_

city \_\_\_\_\_ state \_\_\_\_\_ zip code \_\_\_\_\_  
( ) ( )

business telephone \_\_\_\_\_ fax number \_\_\_\_\_

Check this box to renew or start a **FREE\*** subscription to *Modern Steel Construction* \*This offer good only for practicing professionals within the U.S.

signature \_\_\_\_\_

For free information on advertisers and other companies mentioned in this issue, circle the appropriate number below:

- |     |     |     |     |     |     |     |     |     |     |     |     |
|-----|-----|-----|-----|-----|-----|-----|-----|-----|-----|-----|-----|
| 1   | 2   | 3   | 4   | 5   | 6   | 7   | 8   | 9   | 10  | 11  | 12  |
| 13  | 14  | 15  | 16  | 17  | 18  | 19  | 20  | 21  | 22  | 23  | 24  |
| 25  | 26  | 27  | 28  | 29  | 30  | 31  | 32  | 33  | 34  | 35  | 36  |
| 37  | 38  | 39  | 40  | 41  | 42  | 43  | 44  | 45  | 46  | 47  | 48  |
| 49  | 50  | 51  | 52  | 53  | 54  | 55  | 56  | 57  | 58  | 59  | 60  |
| 61  | 62  | 63  | 64  | 65  | 66  | 67  | 68  | 69  | 70  | 71  | 72  |
| 73  | 74  | 75  | 76  | 77  | 78  | 79  | 80  | 81  | 82  | 83  | 84  |
| 85  | 86  | 87  | 88  | 89  | 90  | 91  | 92  | 93  | 94  | 95  | 96  |
| 97  | 98  | 99  | 100 | 101 | 102 | 103 | 104 | 105 | 106 | 107 | 108 |
| 109 | 110 | 111 | 112 | 113 | 114 | 115 | 116 | 117 | 118 | 119 | 120 |
| 121 | 122 | 123 | 124 | 125 | 126 | 127 | 128 | 129 | 130 | 131 | 132 |

### 1. Type of work

Please circle **all** that apply

- a. Bridges
- b. Office Buildings
- c. Hospitals
- d. Retail
- e. Industrial
- f. Schools
- g. Multifamily
- h. Institutional
- i. Low-Rise
- j. High-Rise

### 2. Your position

Please circle **ONLY** one

- a. Owner/President
- b. Chief Engineer/Chief Architect/Department Head
- c. Staff Engineer/Staff Architect/Construction Manager
- d. Other

### 3. Type of business

Please circle **ONLY** one

- a. Structural engineer
- b. Civil engineer
- c. Structural steel fabricator
- d. Other fabricator
- e. Educator/library Architect
- g. Building owner/developer
- h. Steel mill
- i. Erector
- j. Steel product manufacturer
- k. GC/CM
- l. Student
- m. Other

### 4. Reason for Inquiry

Please circle **ONLY** one

- a. Information file
- b. Immediate or Future Purchase

February 1997

Use these cards to request information from manufacturers and other companies mentioned in this issue. Simply circle the numbers referenced in the advertisement or article, fill out the rest of the information requested on the card, and either mail it to: Modern Steel Construction, Creative Data Center, 650 South Clark St., Chicago, IL 60605-9960 or fax it to: **312/922-3165**.

Please type or print only

name \_\_\_\_\_

company name \_\_\_\_\_

address \_\_\_\_\_

city \_\_\_\_\_ state \_\_\_\_\_ zip code \_\_\_\_\_  
( ) ( )

business telephone \_\_\_\_\_ fax number \_\_\_\_\_

Check this box to renew or start a **FREE\*** subscription to *Modern Steel Construction* \*This offer good only for practicing professionals within the U.S.

signature \_\_\_\_\_

For free information on advertisers and other companies mentioned in this issue, circle the appropriate number below:

- |     |     |     |     |     |     |     |     |     |     |     |     |
|-----|-----|-----|-----|-----|-----|-----|-----|-----|-----|-----|-----|
| 1   | 2   | 3   | 4   | 5   | 6   | 7   | 8   | 9   | 10  | 11  | 12  |
| 13  | 14  | 15  | 16  | 17  | 18  | 19  | 20  | 21  | 22  | 23  | 24  |
| 25  | 26  | 27  | 28  | 29  | 30  | 31  | 32  | 33  | 34  | 35  | 36  |
| 37  | 38  | 39  | 40  | 41  | 42  | 43  | 44  | 45  | 46  | 47  | 48  |
| 49  | 50  | 51  | 52  | 53  | 54  | 55  | 56  | 57  | 58  | 59  | 60  |
| 61  | 62  | 63  | 64  | 65  | 66  | 67  | 68  | 69  | 70  | 71  | 72  |
| 73  | 74  | 75  | 76  | 77  | 78  | 79  | 80  | 81  | 82  | 83  | 84  |
| 85  | 86  | 87  | 88  | 89  | 90  | 91  | 92  | 93  | 94  | 95  | 96  |
| 97  | 98  | 99  | 100 | 101 | 102 | 103 | 104 | 105 | 106 | 107 | 108 |
| 109 | 110 | 111 | 112 | 113 | 114 | 115 | 116 | 117 | 118 | 119 | 120 |
| 121 | 122 | 123 | 124 | 125 | 126 | 127 | 128 | 129 | 130 | 131 | 132 |

### 1. Type of work

Please circle **all** that apply

- a. Bridges
- b. Office Buildings
- c. Hospitals
- d. Retail
- e. Industrial
- f. Schools
- g. Multifamily
- h. Institutional
- i. Low-Rise
- j. High-Rise

### 2. Your position

Please circle **ONLY** one

- a. Owner/President
- b. Chief Engineer/Chief Architect/Department Head
- c. Staff Engineer/Staff Architect/Construction Manager
- d. Other

### 3. Type of business

Please circle **ONLY** one

- a. Structural engineer
- b. Civil engineer
- c. Structural steel fabricator
- d. Other fabricator
- e. Educator/library Architect
- g. Building owner/developer
- h. Steel mill
- i. Erector
- j. Steel product manufacturer
- k. GC/CM
- l. Student
- m. Other

### 4. Reason for Inquiry

Please circle **ONLY** one

- a. Information file
- b. Immediate or Future Purchase

February 1997





NO POSTAGE  
NECESSARY  
IF MAILED  
IN THE  
UNITED STATES

**BUSINESS REPLY MAIL**

FIRST CLASS MAIL PERMIT NO. 12522 CHICAGO, IL

POSTAGE WILL BE PAID BY ADDRESSEE

**MODERN STEEL  
CONSTRUCTION**

c/o CREATIVE DATA SERVICES  
650 S CLARK ST  
CHICAGO, IL 60605-9960



Use these cards to request information from manufacturers and other companies mentioned in this issue. Simply circle the numbers referenced in the advertisement or article, fill out the rest of the information requested on the card, and either mail it to: Modern Steel Construction, Creative Data Center, 650 South Clark St., Chicago, IL 60605-9960 or fax it to: **312/922-3165**.



NO POSTAGE  
NECESSARY  
IF MAILED  
IN THE  
UNITED STATES

**BUSINESS REPLY MAIL**

FIRST CLASS MAIL PERMIT NO. 12522 CHICAGO, IL

POSTAGE WILL BE PAID BY ADDRESSEE

**MODERN STEEL  
CONSTRUCTION**

c/o CREATIVE DATA SERVICES  
650 S CLARK ST  
CHICAGO, IL 60605-9960

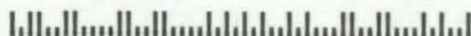

**MODERN STEEL  
CONSTRUCTION**  
Reader Service Card



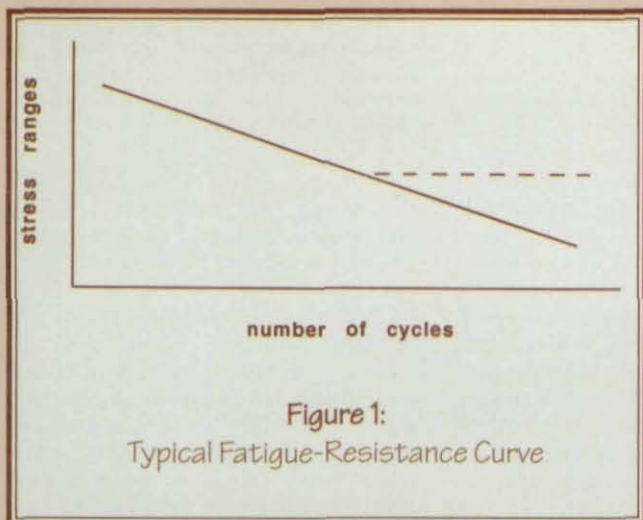

Figure 1:  
Typical Fatigue-Resistance Curve

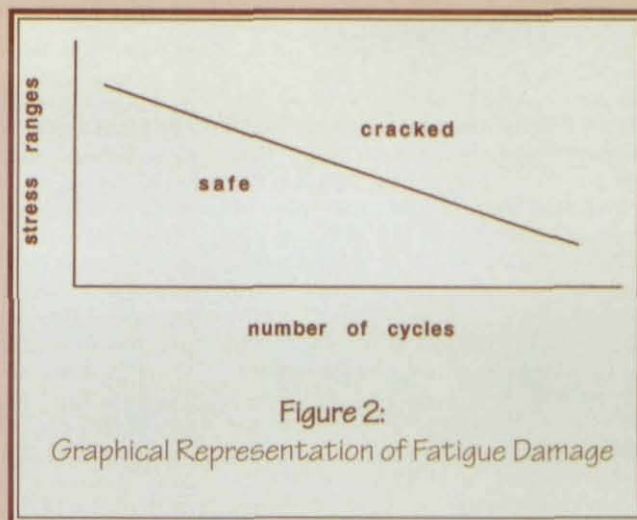

Figure 2:  
Graphical Representation of Fatigue Damage

fatigue thresholds. The differences in the values for redundant and non-redundant bridges represent the different consequences of cracking in redundant versus non-redundant bridges. The codewriters attempted to arbitrarily increase safety against fatigue in non-redundant bridges. The allowable stresses for redundant bridges are the laboratory-derived values.

The *LRFD Specification* includes an equation to define fatigue resistance of each fatigue category (Equation 6.6.1.2.5-1). When 100,000, 500,000 and two million cycles are plugged into the general equation in the *LRFD Specification*, the allowable stress ranges for redundant bridges in the *Standard Specifications* result. Further, the constant-amplitude fatigue thresholds given in Table 6.6.1.2.5-1 of the *LRFD Specification* are equal to the allowable stress ranges for more than two million cycles in the table for redundant bridges in the *Standard Specifications*.

Thus, the specified resistances of the *Standard Specifications* and the *LRFD Specification* are identical, with the exception that the *LRFD Specification* treats redundant versus non-redundant bridges differently.

The true differences between the two specifications lie on the load side of the equation. Since the curve shown in Figure 2 represents equal fatigue damage, the two specifications are comparable in their respective magnitudes of stress range and cycles yield equal fatigue damage on the curves, which are common to each specification.

The codewriters who developed the fatigue provisions of the *Standard Specifications* did not want to require that designers deal with a loading specific to fatigue. They used multiple HS20 truck and lane loads for the fatigue checks, just as these loads are used for strength considerations. Knowing that these are fictitiously high loads for fatigue, the codewriters specified that a fictitiously low number of cycles be considered for fatigue. The higher resultant stress range in conjunction with the lower than actual number of cycles results in fatigue damage comparable to the actual bridge. This fictitiously low number of cycles has led to confusion.

The codewriters who developed the fatigue provisions of the *LRFD Specification* wanted the number of cycles for the fatigue check to be realistic so bridge evaluators

could better comprehend the actual remaining life of a bridge in comparison to the number of cycles used for design. Instead of designing for, say, two million cycles, the designer will consider of tens of millions of cycles when designing to the *LRFD Specification*. Thus, a new load was required for fatigue: 75% of a single HS20 truck (or an HS15 truck) with a fixed rear-axle spacing of 30'. This load is representative of all the trucks that will cross the bridge during its life. Theoretically, if every truck that crossed the bridge during its life—both those heavier and those lighter than the fatigue truck—was replaced by the fatigue truck, fatigue damage equal to the actual fatigue damage would result. The stress ranges resulting from the new fatigue load, in conjunction with the higher, more realistic number of cycles, yields comparable fatigue damage as the *Standard Specifications*, yet will not lead evaluators to believe that the fatigue life is over after two million trucks have crossed the bridge.

Dennis R. Mertz, P.E., Ph.D., teaches bridge design at the University of Delaware. He is the primary author of the fatigue provisions of the AASHTO LRFD Bridge Design Specifications. Mertz currently is studying the simplification of the design provisions for steel I-girder bridges.



#### NATIONAL STEEL BRIDGE ALLIANCE

One East Wacker Dr., Suite 3100  
Chicago, IL 60601-2001  
ph: 312/670-2400 • fax: 312/670-5403

The mission of The National Steel Bridge Alliance (NSBA), which was formed in 1995, is to enhance the art and science of the design and construction of steel bridges. Its activities include organizing meetings, conferences and national symposia, conducting the Prize Bridge Awards competition, supporting research, developing design aids, and providing assistance to bridge owners and designers. The NSBA membership includes representatives from all aspects of the steel bridge industry.



## ANSWERS:

**1.** From ASTM A325 Section 16, Type 1 bolts are marked "A325" and Type 3 bolts are marked "A325"; the underline distinguishes Type 3 bolts. Note that Type 1 bolts may also be marked with three radial lines 120 degrees apart at the manufacturers option.

**2. c.** Deformations in many shear connections such as double angles, shear end plates, and single angles are most often limited by the simple beam rotation of the supported member. Deformation of the stiffener in a stiffened seated connection, however, would not be so limited.

**3.** False. In the LRFD Specification, connection limit states generally utilize a resistance factor of 0.75, while beam design limit states generally utilize a higher resistance factor of 0.9. Therefore connections have a higher reliability. This is historically consistent with the ASD Specification, which generally utilizes a factor of safety of 2 for con-

nection limit states and  $\frac{2}{3}$  for beam design limit states.

**4.** Undercut is a notch (recess) into the base metal that results from the melting and removal (or shifting) of base metal at the toe of the fillet weld. Overlap is a notch that results when weld metal protrudes over unmelted base metal at the toe of the fillet weld; this obscures the fused leg dimension because there is no good way to determine where the overlap stops and the fusion begins. These and other fillet weld profile concerns are addressed in AWS D1.1-96 Section 5.24. *Special thanks to E.M. Beck of Law Engineering for contributing to this answer.*

**5.** No. Crane rail can be obtained end-hardened OR heat-treated, but not both because heat treating relieves the end hardening and vice versa.

**6.** From AISC Code of Standard Practice Section 6.5.2, "In the absence of other requirements in the contract documents, the fabricator hand cleans the steel of loose rust,

loose mill scale, dirt and other foreign matter, prior to painting, by means of wire brushing, or by other methods elected by the fabricator, to meet the requirements of SSPC SP2."

**7.** The nominal thickness is  $\frac{5}{32}$ " for the typical range of bolt diameter used in buildings.

**8.** It is the metric equivalent of a W24x55. The full listing of metric shapes is available in AISC's *Metric Properties of Structural Shapes*, which includes a cross-reference between US customary and metric shape designations. A rough conversion can always be made as follows: dividing the 610 mm nominal metric depth by 25 yields about 24"; dividing the 82 kg mass per meter by 1.5 yields about 55 lbs. per ft. Thus W610x82 equals W24x55.

**9.** In Chicago, IL (May 7-9, 1997).

**10.** The web of an I-shaped beam provides some limited restraint to the flange that is tending to buckle.

## ATTENTION TO DETAIL

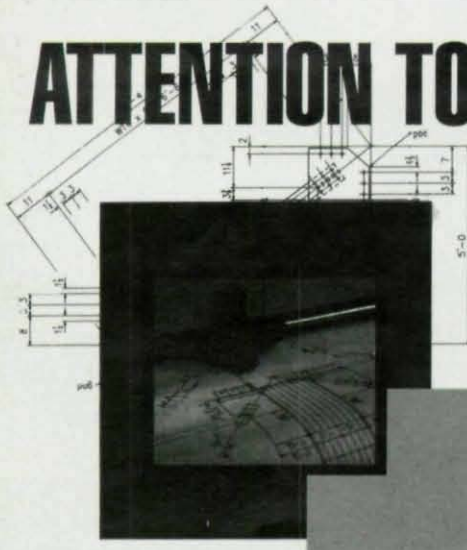

Computer Detailing Systems, Inc. introduces a state of the art structural steel detailing system which allows fabricators and detailers to meet the demands of the future with the ability to generate connection calculations, download to CNC equipment and interface with major design firms through the Steel Detailing Neutral File.

A practical, flexible system requiring minimal training, CDS is capable of producing intelligent 3D models, floor plans and elevations as well as shop drawings of unsurpassed quality using your standards and paper.

CDS is currently used by fabricators and detailers throughout the US and in Canada.

**CONTACT COMPUTER DETAILING SYSTEMS**  
today FOR A FREE INFORMATION PACK.

**CDS**  
Structural Steel Detailing System

Computer Detailing Systems, Inc. • 7280 Pepperdam Avenue • Charleston, South Carolina 29418 • (803)552-7055

Please circle # 63



## AISC Quality Certification

The Quality Certification Program now includes more than 350 fabrication shops— with certified fabricators in every state plus several foreign countries.

For a current listing of Quality Certified Fabricators, including the category of certification, addresses and phone numbers, check out AISC's web page at:

<http://www.aiscweb.com>

Or call 312/670-5435 for more information or a list of Certified Fabricators



# How To Spark Profits With **KLEENKOTE™** STRUCTURAL TUBING

## From storage to cleanup **KLEENKOTE™** outperforms bare steel tubing

KLEENKOTE™ is the material of choice to improve productivity and create savings that go straight to your bottom line.

**KLEENKOTE™ STORES OUTSIDE LONGER**  
KLEENKOTE™ has an average .5 mil coating that stands up to the elements longer than bare tubing.

**WELD SPATTER BRUSHES CLEAN**  
How would you like to simply brush away weld spatter with a wire brush? No grinding. No chemical solvents. No problem. KLEENKOTE™ brushes clean and is ready to go.

**PAINTING MATERIALS AND PREPARATION COSTS ARE REDUCED**  
Reduces primers, paint and labor costs. In many cases KLEENKOTE™ pays for itself with savings from the painting process.

**ALLOWS FOR EASIER CLEANUP**  
KLEENKOTE™ reduces the need for dangerous chemical solvents or expensive grinding.

**SEE FOR YOURSELF**  
Welded Tube Company of America, the developer of KLEENKOTE™, has conducted a series of time and motion studies that prove each of the above benefits. The research is conclusive: KLEENKOTE™ can save you time and money versus bare steel tubing.

*See how you can benefit.  
Call or fax us and we will send  
you the time and motion studies  
that show how you can  
save with KLEENKOTE™.*

**TIME  
AND  
MOTION  
RESEARCH**

**Welded Tube Company Of America**  
1855 East 122nd Street  
Chicago, IL 60633  
Call Toll Free 800-733-5683  
FAX 773-646-6128



**KLEENKOTE™**

*The material of choice.  
Savings that show up on your  
bottom line every time.*

Please circle # 23



## AISC Advisory Statement on Mechanical Properties Near the Fillet of Wide Flange Shapes and Interim Recommendations January 10, 1997

In recent months there have been reports to AISC indicating the potential for crack initiation at, or near, connections in the "k" area of wide flange rotary straightened members. The "k" area is the region extending from approximately the mid point of the radius of the fillet into the web approximately 1 to 1½ inches beyond the point of tangency between the fillet and web. Most of the incidents occurred at highly restrained joints with welds in this area. To gather further information, AISC's Research Subcommittee on Shape Material and Design conducted a workshop on January 8-9, 1997 to systematically review concerns that had been raised.

—*Nestor Iwankiw*  
*Vice President*  
*Engineering &*  
*Research*  
*American Institute*  
*of Steel*  
*Construction, Inc.*

Welding of highly restrained joints, such as those associated with continuity plates and/or doubler plates in columns, induces residual stresses in steel members. It is generally understood that steel is not entirely homogeneous, and that variations in mechanical properties exist. In addition to normal variations, the process of mill rotary straightening alters the mechanical properties by cold working (strain hardening) in the "k" area. Material variations in the "k" area may include: a reduction in ductility and toughness (in some cases Charpy V Notch toughness below 5 ft-lbs at 70° F); an increase in hardness, yield strength and ultimate strength; and an increase in the ratio of yield to ultimate strength. Such variations have been reported in material from all steel making practices, both domestic and international sources of rotary straightened shapes.

Based on the review conducted at the AISC January workshop, the number of examples reported has been limited and these have occurred during construction or laboratory tests, with no evidence of difficulties with steel members in service.

The AISC Research Subcommittee on Shape Material and Design continues to evaluate all submitted concerns in order to recommend necessary research, and will take appropriate action. In the interim AISC recommends the following fabrication and design practices for rolled wide flange shapes:

- Welds should be stopped short of the "k" area for transverse stiffeners (continuity plates).
- For continuity plates, fillet welds and/or partial joint penetration welds proportioned to transfer the calculated stresses to the column web should be considered instead of complete joint penetration welds. Weld volume should be minimized.
- Residual stresses in highly restrained joints may be decreased by increased preheat and proper weld sequencing.
- Magnetic particle or dye penetrant inspection should be considered for weld areas in or near the "k" area of highly restrained connections after the final welding has completely cooled.
- When possible, eliminate the need for column web doubler plates by increasing column size.

Good fabrication and quality control practices, such as inspection for cracks, gouges, etc., at flame-cut access holes or copes, should continue to be followed and any defects repaired and ground smooth. All structural wide flange members for normal service use in building construction should continue to be designed per AISC Specifications and the material furnished per ASTM standards.

AISC will issue further information on this subject as it becomes available.





You dream it—we'll shape it.

The structural profiles rolled and fabricated by Marks Brothers are the stuff of architects' dreams, because we bring engineering challenges to reality. Serving the United States coast to coast since 1946, we have been using our expansive capabilities, including laser cutting, plate and profile rolling, and fabrication to bring form to your ideas.

Dreams aside, Marks Brothers is also very well known for our competitive pricing, dependability and technical expertise. Call us, and we'll talk about how to make your dreams—your ideas—take shape.

Structural Profiles: Rolled / Fabricated



**M**  
**MARKS**  
 BROTHERS, inc.  
 1/800/526-1031  
 10300 SE Jennifer  
 Clackamas, OR 97015  
 Use our Toll free fax:  
 1/888/656-1985

# DESCON AND DESCON BRACE

Design and Detailing of Steel Connections

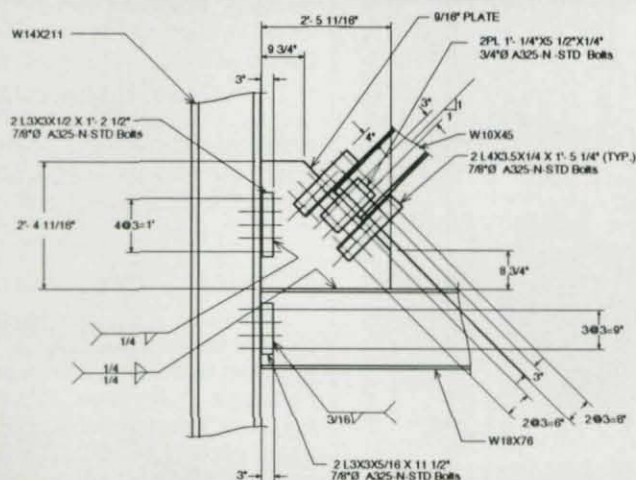

For more information contact:

**OMNITECH ASSOCIATES**

(888) 8-DESCON or (510) 658-8328  
<http://www.desconplus.com>

Fax: (510) 595-0373  
[omnitech@desconplus.com](mailto:omnitech@desconplus.com)

## Bridge Strengthening Symposium

The Second Symposium on Practical Solutions for Bridge Strengthening and Rehabilitation will be held at the Westin Crown Center Hotel in Kansas City on March 25-27. The Symposium offers the latest ideas and research on practical ways to deal with the nation's many deficient bridges. Papers will be presented by engineers from consulting firms, government agencies and academia, all with an emphasis on practical solutions. The Symposium is organized by Iowa State University under grants from the NSF and FHWA in cooperation with HNTB and the Missouri DOT.

Topics include: Seismic Retrofit in Moderately and Marginally Seismic Areas; Rehabilitation of Long Span Bridges; Rehabilitation/Strengthening of Short/Medium Span Bridges; New Materials for Repair and Rehabilitation; New Strengthening/Rehabilitation Techniques for Railway Bridges; and New Strengthening/Rehabilitation Procedures.

Registration fee is \$175 through March 1 and \$200 thereafter. For more information, please contact Professor F.W. Klaiber, Department of Civil and Construction Engineering, Iowa State University, Ames, IA, 50011 (ph: 515/294-8763; fax: 515/294-8216; email: klaiber@ias-tate.edu).

## Fire Safety In Steel Structures

BHP Steel, the leading steel producer in Australia, is offering five free publications on Fire Testing in Steel Structures.

*Open-Deck Car Park Fire Tests* documents research to determine the structural behavior of open-deck steel parking structures during fires to determine if fire protection of such structures is necessary. The work described in this report is the basis for changes to the Building Code of Australia, which allows the use of unprotected structural steel members of appropriate size.

*Fire and Unprotected Steel in Closed Car Parks* considers fires in enclosed parking structures. Fire tests were conducted in both sprinklered and non-sprinklered parking structures and it was found that a minimum sprinkler system was effective in extin-



# Curved & Straight Steel Bridge Design ASD LFD LRFD

## Serious Design Power On Your PC

Complex Grid & Roadway Geometry  
Influence Surface or Influence Line Approach  
Powerful Nonprismatic Girder Optimization  
Plate Girders, Box Girders, Rolled Shapes  
Integrated Girder & Bracing Design  
English/Metric Hard Conversion

# MDX software

[www.mdxsoftware.com](http://www.mdxsoftware.com)

Free Demos      Phone (573) 446 3221      30-Day Trials  
Fax (573) 446 3278

Please circle # 47

## WE BEND STRUCTURAL STEEL

Our exclusive bending technologies give us the capabilities to bend heavy angles, bars, beams, channels, rails, tees, tubing and pipe shapes to demanding structural specifications. In addition, we can cut, forge, punch, thread and weld steel. We are constantly developing our skills to change the shape of steel and assure our customers of close tolerances, saving them time in inspection and fit-up. When you need prompt, accurate, competitive quotations and on time delivery...**TAKE IT TO THE MAX!**

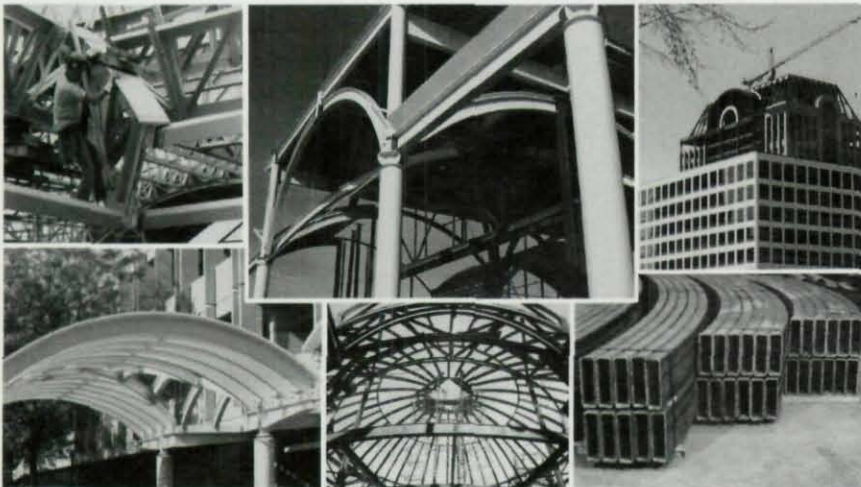

Please circle # 56

# max weiss

IRREGULAR CURVES,  
VERTICAL OFFSETS,  
ELLIPTICAL SHAPES,  
CIRCLES, OR SEGMENTS  
WITH OR WITHOUT TANGENTS

OUR 50<sup>TH</sup> YEAR

MAX WEISS CO., INC. 8625 W. BRADLEY ROAD MILWAUKEE, WI 53224  
TELEPHONE: 414-355-8220 MAX FAX: 414-355-4698

## News Briefs....

guishing and controlling fire and thereby limiting the amount of smoke. This report also resulted in changes in the Building Code of Australia.

*Fire Safety in Carparks* summarizes the tests done on both open-deck and enclosed parking structures.

*Fire in Mixed Occupancy Buildings* demonstrates that provided there is adequate separation between two enclosures (with different occupancies), the effect of fire in each enclosure depends on the characteristics of the particular occupancy under consideration. Tests also reveal the effect of fire in one enclosure is more likely to be felt in the enclosure above than in the one below.

*Fire in Offices* describes two early fire tests conducted on a small office enclosure. The tests were conducted without the use of sprinklers; however, in one test the fire was extinguished by turning on a sprinkler head after flashover had taken place.

To receive copies of these publications, write: BHP Steel Direct, Locked Bag 8825, South Coast Mail Centre, NSW 2521 AUSTRALIA or fax 02-9955-5406.

## Managing Projects In A Global Market

The American Society of Civil Engineers will host *Construction Congress V: Managing Engineered Construction in Expanding Global Markets*, October 5-7 in Minneapolis. The congress will include six tracks: Trends in Mechanical and Electrical Construction; Innovative Underground Construction Technologies; Practical Computer Applications and Technologies; Changing Delivery Systems; Emerging Global Opportunities; and Modern Residential Construction.

For more information, contact: Jeffrey S. Russell, Steering Committee Chair, 2304 Engineering Hall, 1415 Engineering Dr., Madison, WI 63706.

## Painting Conference

The Steel Structures Painting Council will hold the *1997 Compliance in Industrial Painting Conference* March 1-5 in Stamford, CT. Among the topics covered will be VOCs in traffic marking paint, solvent hazards, work in confined spaces, waste disposal, scaffolding and protection, and



lead paint abatement.

For more information, contact Dee Boyle at SSPC (412/281-2331).

## Composites Conference Seeks Abstracts

The Second International Conference on Composites in Infrastructure ICCI'98 will be held Jan. 12-14, 1998 in Tucson. The conference is sponsored by the National Science Foundation, University of Arizona and many other organizations. Abstracts must be submitted by Feb. 15, 1997 to: Engineering Professional Development, University of Arizona, Box 9 Harvill Building, Room 235, P.O. Box 210076, Tucson, AZ 85721-0076 (ph: 520/621-5104; fax: 520/621-1443; email: baltes@big-dog.engr.arizona.edu).

## Earthquake Resistant Structures

The second volume of Computational Mechanics series of books on Advances in Engineering is now available. "Earthquake Resistant Structures" contains the proceedings of the First International Symposium on Earthquake Resistant Engineering Structures, held in Greece in the fall of 1996. The book covers a wide range of subjects, including seismology & earthquake hazard; geotechnical aspects; experimental methods; dynamic analysis; passive protection; bridges; lifelines; tunnels; tanks & towers; steel construction; and the retrofit of historic buildings.

Copies of the 728-page, \$297 publication can be ordered from Computational Mechanics, 25 Bridge St., Billerica, MA 01821 (ph: 508/667-5841; fax: 508/667-7582; email: cmina@ix.netcom.com).

## Free Tube Properties Brochure

The Hollow Structural Sections Committee of the Steel Tube Institute has published a new 24-page booklet on "HSS Dimensions and Section Properties." The brochure provides pertinent engineering data and nomenclature for architects, engineers and fabricators who design structures with tubes. It includes tables of dimensions and section properties for rec-

tangular, square and round hollow structure sections and includes data on: nominal size; weight-per-foot; wall thickness; cross sectional area; moment of inertia; section modulus; radius of gyration; plastic section modulus; torsional stiffness; torsional shear and surface-area-per-foot.

Copies of the free brochure are available from STI at 8500 Station St., Suite 270, Mentor, OH 44060 (ph: 216/974-6990).

## In Memoriam

Condolences to the friends and family of Frank William Schroeder, who passed away at the age of 90. Schroeder graduated in 1930 with a civil engineering degree from the University of Cincinnati. He was the chief engineer at Jones & Laughlin Steel Corp. beginning in 1930 and until he moved to International Steel Co. in 1945. He spent 26 years there, starting as a salesman and advancing to vice president of all products. He finished his career at Inland-Ryerson Construction Products in 1973.

## NSBA Staff News

Steven A. Olson, Ph.D., P.E., has joined the National Steel Bridge Alliance as Manager of Engineering Design. Previously, he was with Burgess & Niple, Ltd., in Columbus, OH.

"I'm looking forward to the opportunity of working with bridge owners, designers, and fabricators on a national level," said Olson, who confesses he's a big fan of steel bridges. "I've become acquainted with several owners, designers, and fabricators in the Midwest. It's been pleasurable for two reasons: First, a majority of the people who work on bridges enjoy what they do. Second, I like to hear stories about bridges. Whether it be an owner, designer, fabricator or contractor, most individuals know of one or two stories for each of the bridges they have worked on."

Olson can be reached at the NSBA, 4527 Robin Circle, N., Robbinsdale, MN 55422 (ph: 612/537-7073; fax: 612/537-4997; email: olson@aiscmail.com).

For the BEST in Bridge Software . . .

<p><b>WIN-DASH</b> MERLIN DASH FOR WINDOWS</p>	<p><b>MERLIN DASH</b> DESIGN OF STRAIGHT HIGHWAY BRIDGES</p>
<p style="font-size: 1.5em; transform: rotate(-30deg); font-weight: bold;">NEW!</p> <p style="font-size: 1.5em; transform: rotate(-30deg); font-weight: bold;">Get WIN-DASH and receive a FREE BONUS MODULE (a \$1000 Value) CALL!</p>	<ul style="list-style-type: none"> <li>◆ AASHTO - WSD, LFD (LRFD Analysis)</li> <li>◆ Analysis, Rating, Code Check</li> <li>◆ Optimization by Cost or Weight</li> <li>◆ Auto Live Load - AASHTO and Multiple User Defined Concurrent Live Load</li> <li>◆ Auto RATING FACTORS - Inventory, Operating, Posting, Special Vehicles</li> <li>◆ METRIC/English Conversion</li> <li>◆ Deck Pouring Sequence Analysis</li> <li>◆ Haunched Web, Hybrid, Composite</li> <li>◆ Continuous Spans, Support Restraints</li> <li>◆ Graphics - Moment, Shear, Camber Allow/Actual Stress &amp; Ranges</li> <li>◆ Menu Input - Very Friendly</li> </ul>
<p><b>DESCUS</b> DESIGN &amp; ANALYSIS CURVED BRIDGES</p> <ul style="list-style-type: none"> <li>◆ Curved &amp; Straight Bridge Systems</li> <li>◆ Influence Surface Approach</li> <li>◆ T and BOX Girder Sections</li> <li>◆ Latest AASHTO - LFD &amp; WSD</li> <li>◆ METRIC and English Units</li> <li>◆ Girder Optimization</li> <li>◆ Auto MESH Generation</li> <li>◆ Auto RATING FACTORS - Inventory Operating, Posting, Special Vehicle</li> <li>◆ Complex Geom. - Skewed, Bifurcated</li> <li>◆ Pouring Sequence Analysis Available</li> <li>◆ PC License or Lease, Timesharing</li> <li>◆ Menu-Driven/CAD-Like Features</li> <li>◆ Fast Running (Minutes)</li> </ul>	<p><b>SABRE</b> SIGN BRIDGE ANALYSIS-DESIGN</p> <ul style="list-style-type: none"> <li>◆ Most Types - Tri-Chord, Box Chord Single/Double Cantilever, Other</li> <li>◆ Analysis - Moment, Shear, Torque Displacement, Reaction, Stress</li> <li>◆ Design - Splices, Base Plates</li> <li>◆ Auto Load Cases - Wind (shielding), Ice, DL, User Defined Loads</li> <li>◆ Pull Down Menu/CAD-Like Features</li> <li>◆ Latest AASHTO Code Checking</li> </ul>
<p><b>TRAP</b> TRUSS RATING AND ANALYSIS</p> <ul style="list-style-type: none"> <li>◆ NEW - AASHTO LRFD and LFD Spec.</li> <li>◆ Cable Member Prestressing</li> <li>◆ Most Truss Types Considered</li> <li>◆ Analysis, Design, Rating, Rehabilitation</li> <li>◆ Auto RATING FACTORS - Inventory, Operating, Posting, Special Vehicles</li> <li>◆ Automatic Group Load Combinations</li> <li>◆ Simple or Continuous to 6 Spans</li> <li>◆ Pull-Down Menu/CAD-Like Features</li> </ul>	

Available Exclusively Thru:

OPTI-MATE, INC.

P.O. Box 9097 • Dept. A      Tel 610-867-4077  
Bethlehem, PA 18018      Fax 610-865-1030

Free Trial...  
FULL PROGRAM  
(No Deposit)

Please circle # 53



# The Better (Not Bitter) Truth HAS LRFD'S TIME FINALLY ARRIVED?

By Charles J. Carter, P.E.

**I**N MARCH OF 1995, THE AISC BOARD OF DIRECTORS REAFFIRMED AISC'S COMMITMENT TO LRFD as the preferred Specification for the fabricated structural steel industry. Ongoing advancements in strength-design-specific areas such as seismic design, composite systems design, and design of systems utilizing partially restrained (PR) connections weighed heavily in this decision. After ten years since its first release in the US, LRFD is now an established design method with the 2nd Edition Manual. Yet while a recent Gallup survey shows that most engineers agree that LRFD is the Specification of choice for the future, there remains the uncertainty as to why the ASD Specification, which has served the profession well since 1923, is now in need of replacement.

AISC is actively developing LRFD while maintaining ASD in its current form for those that choose to continue to use it; the steel bridge design industry is similarly in transition. The concrete industry crossed this bridge many years ago and now looks back with barely any remaining coverage of working stress design. More recently, an appendix was added to ACI 318 that allows the use of ACI strength calculations with ASCE 7 (and LRFD) load factors and load combinations, which makes it easier to design mixed steel

and concrete systems at the factored load level. And although the timber and masonry industries are comparatively in their infancies in transitioning toward LRFD, there can be no question that momentum is on the LRFD side.

## IS ASD STILL ADEQUATE?

**I**n the short term, there is an argument to be made that the use of LRFD or ASD is acceptable. That is, as long as we continue to design and construct steel structures as we have for the past 40 or more years—as braced frames or frames with fully restrained (FR) moment connections—the use of either LRFD or ASD provides safe and economical designs for typical loadings. However, while we may find it convenient to continue to use the same design method as we have in the past, the question remains whether steel will continue as a viable construction material if design methods don't continue to improve and advance.

In any industry, continued success requires innovative progress. Has any other industry or technology remained competitive while tied to concepts introduced more than 40 years ago? Certainly not in current times. For example, the automobile industry tried, failed in a much shorter period, learned the lesson, and is today much stronger

for it. Could you imagine the desirability of a car today that did not offer "modern" advancements such as seat belts, fuel injection, antilock brakes, and airbags? These one-time luxuries are now de facto industry standards.

ASD has its original roots in the 1920s. The advances since that time (such as plastic design, composite beams and floors, frame stability, high-strength bolts, and the continuing development and application of computational power and software) have simply been applied entirely within the context of the same way of doing things. That these advances could be incorporated into ASD in any form, however limited, may be viewed as a tribute to the innovative engineers of the past.

We must also recognize, however, that to make these new ideas fit into the old system, we must accept limits on their utility. By nature, the ASD approach is limited to elastic structural response (some provisions of the ASD Specification indirectly consider limited inelastic behavior; for example a bending strength of  $0.66F_y S_x$  for a compact braced member is 10% above the elastic design strength to account for a typical lower bound shape factor  $Z_x/S_x$  of 1.1). Additionally, it is limited to combinations of service loading that are not significantly different than those contemplated during the development of the allowable stresses, member response models based more upon engineering judgment than the results of actual test data, and idealization of connections as either pinned or fixed, to name a few examples. Despite all that has been accomplished with ASD, even within these limitations, there is little room left to accommodate the ongoing progress that must be made to lead steel design and construction into the future.

So, does this mean that ASD is no longer adequate? Again, in the short term, the answer is probably no, it can still serve a



useful or convenient purpose. But for the accommodation of long term advancements, ASD is in its twilight. Several specific examples follow to illustrate why.

ALLOWABLE STRESSES HAVE  
NO MEANING IN COMPOSITE  
DESIGN

In composite beam design, a simple comparison between the LRFD and ASD methods illustrates the logical and rational basis of the LRFD strength model (see Figure 1). Because concrete inherently behaves inelastically, a composite section does the same. Although the ASD approach provides a safe (and in many cases extremely conservative) design for common loadings, it cannot be ignored that the approximate elastic model does not even provide a free body diagram that satisfies the basic assumptions of equilibrium; the assumed elastic neutral axis (ENA) is incorrect when the failure occurs in the inelastic range. In this and other cases of inelastic behavior, it is inconsistent or inefficient to use a model that is based upon elastic behavior. One must also wonder if it is even desirable—the plastic distribution illustrated in Figure 1c yields a beneficial shape factor on the order of 1.7 when compared to the elastic stress distribution in Figure 1b.

Beyond composite beams, only the LRFD Specification offers guidance on the design of composite columns (see Figure 2). Likewise, the assessment of composite connection strength and performance is prudent only when factored load effects are considered. A partially restrained (PR) composite connection (as detailed in AISC's Design Guide #8: Partially Restrained Composite Connections) can be used to reduce both steel tonnage and service-

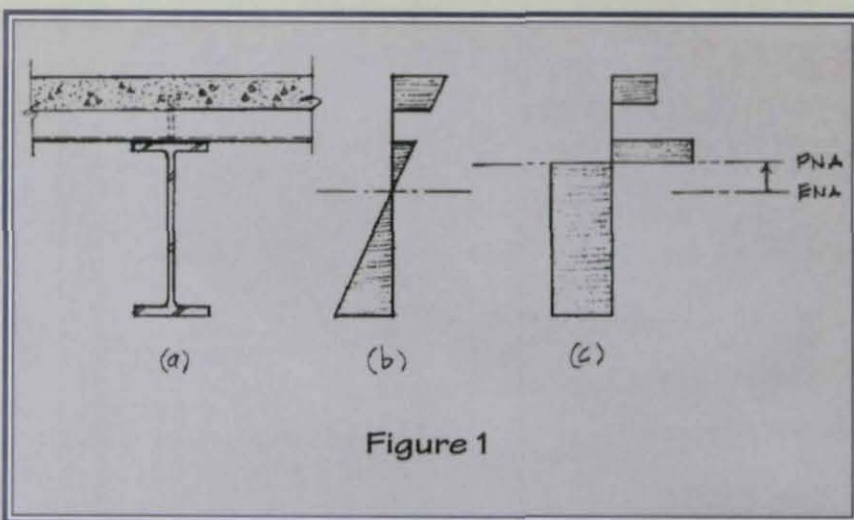

Figure 1

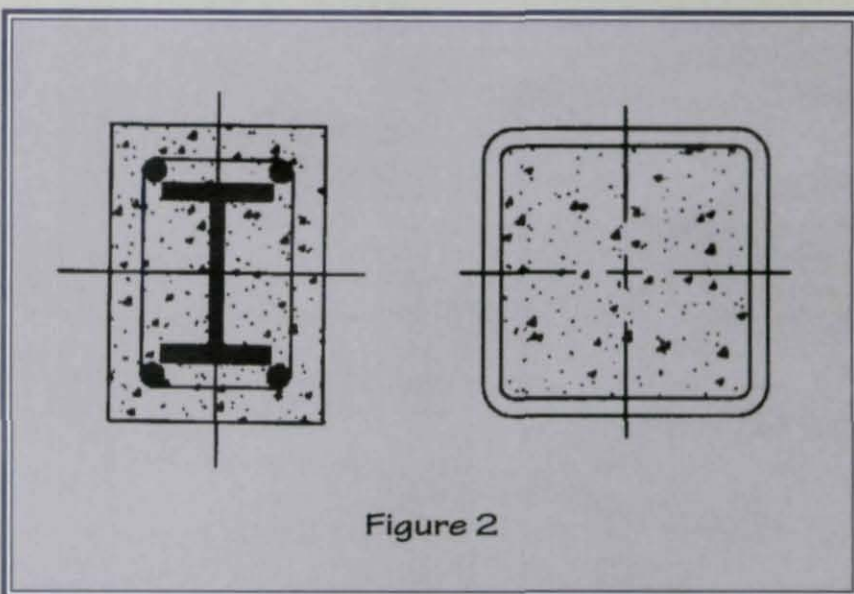

Figure 2

ability problems while at the same time reducing connection and fabrication costs due to simplification of details. All of these result in a lower overall cost of steel construction and can only be realistically implemented using LRFD.

Other composite connection systems provide further advantages. For example, a system utilizing composite connections between steel floor framing and concrete-encased steel columns (also known as steel-reinforced-concrete) or reinforced concrete columns offers a decided steel advantage because of all the deflection problems and structural inefficiencies associated with concrete-slab floor-framing. Traditional reinforced concrete

frame designs could be economically supplanted with hybrid systems utilizing steel floor framing. These systems would provide increased column spacing flexibility and improved control of floor deflection and vibration characteristics. Additionally, for seismic design applications, these systems would provide increased structural damping and improved structural ductility, when compared with the seismic performance of traditional reinforced-concrete frames. But because these systems all require more exact consideration of inelastic behavior under factored loads, LRFD is crucial while ASD is simply unsuitable.



# THE COMPUTER VIBRATION ANALYSIS PROGRAM FOR STEEL JOIST CONCRETE SLAB FLOORS.



Lets you do in  
minutes what  
used to take  
hours!

Now you can get results at the touch of a button. The computer vibration analysis for floor systems employing steel joist/concrete slab floor construction lets you . . .

- calculate frequency and amplitude resulting from transient vibration caused by human activity on joist-concrete floors
- perform various "what-if" scenarios—variation in slab thickness, concrete strength, joist size, joist spacing, floor decking, live and dead loads and span lengths
- verify your own calculations
- handles up to 100 foot spans

The program is available on 5 1/4 and 3 1/2 inch disks, is IBM PC compatible and comes with a comprehensive 58-page user's manual. And at just \$125.00, this program pays for itself after just one project. So fill out the coupon to order this time-saving program today.

Please send me \_\_\_\_\_ program(s) at \$125.00 each (includes Postage and Handling).

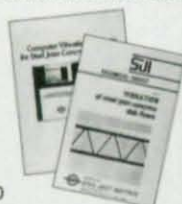

ALL ORDERS  
MUST BE PREPAID

Disk Size: 3 1/2": \_\_\_\_\_ 5 1/4": \_\_\_\_\_

Total Remittance  
U.S. Currency Only \_\_\_\_\_

Name \_\_\_\_\_

Company \_\_\_\_\_

Street Address \_\_\_\_\_

City \_\_\_\_\_ State \_\_\_\_\_ Zip \_\_\_\_\_

Mail to: Managing Director  
Div. A-1  
Steel Joist Institute  
1205 48th Avenue North  
Myrtle Beach, SC 29577



## Important New NSCC Information

### Hotel Reservation Phone Number Changes

With the 1997 National Steel Construction Conference just around the corner, you should be moving quickly to confirm your meeting registration and hotel reservations. To make your hotel reservations at the Sheraton Chicago Hotel & Towers, call 800-233-4100. Please use this 800-number instead of the number listed in the advance program materials.

To quickly receive information on the NSCC, use the conference's Faxback service at:

**800-787-0052, ext. 110.**

To immediately see information on the NSCC, point your favorite web browser to:  
**<http://www.aiscweb.com>**

## ONLY LRFD MAKES SENSE IN SEISMIC DESIGN

In seismic design, a truly elastic design approach is difficult to correlate with expected structural response. After all, by definition, a design earthquake is an ultimate-strength event. Even the current alternative provisions for ASD in AISC's 1992 *Seismic Provisions for Structural Steel Buildings* are only so in name because they employ a conservative load factor of 1.7 on all loads and a set of adjusted "ASD  $\phi$  factors" to determine artificial "allowable strengths." At some point, it has to be realized that we are creating more work and confusion by even trying to use ASD for the inherent inelasticity of seismic design.

## LRFD OFFERS UNIQUE BENEFITS FOR THE DESIGN OF PARTIALLY RESTRAINED (PR) FRAMES

A third area where LRFD offers tremendous innovative promise is in the design of frames with PR connections. Designers will be able to shed the limiting assumptions of ideally pinned or fixed connection behavior. Modeling stiffness and strength using their actual stiffness and strength could result in a more cost-effective structural frame due to simplified connection details.

The old "Type 2 with wind" connections have been around for years and have been used intuitively to accomplish this same goal. But they still were limited by the assumptions that the web connection component carried all the gravity force as a simple shear connection while the flange connection components carried the wind moment



only as a "fully restrained" moment connection. While the performance of such wind connections has been satisfactory, the ability of these connections to determine when the wind was or was not blowing (and therefore when and when not to carry any force in the moment connection) earned them the tongue-in-cheek nickname *smart* wind connections.

But with LRFD, by modeling the actual stiffness of today's standard simple shear connections, steel moment frames can be designed in some cases without adding bolted or welded plates or directly welded flange connections (or their associated cost) at the flanges. It should be recognized that the designers of yesterday already did this in buildings for which experience told them adequate frame stiffness would be present or when heavy masonry walls would provide for lateral strength and stability. But today's design requirements and typical building construction practice using cladding systems such as light curtain wall systems dictate that such designs be verified by calculation. Thus, again LRFD is crucial.

If simple shear connections are not adequate for the loads, other, stronger PR moment connection details such as the PR composite connection mentioned previously can be used. Indeed, the most beneficial advantage of LRFD for connection design may be the elimination of the need to devise connections that will behave as nearly pinned or nearly fully restrained.

However, with all the analysis and design complications involved in design of frames with PR moment connections, is such design feasible from the perspective of design fees? For the low-to-mid-rise construction market, PR connections represent a tremendous opportunity in typical buildings where the stiffness of many connections and framing elements can be utilized. The economics are such that using less expensive PR moment con-

nections in as many locations as possible may be more cost effective than using FR moment connections in as few locations as possible. Consider also the possibility that a PR moment frame could prove more economical than a comparable braced frame—a system commonly considered to be the most economical structural solution. It is almost like getting a lateral system for free.

### DO WE KNOW ENOUGH ABOUT LOADS TO RELY ON LRFD?

**O**n the resistance side, our understanding of steel strength and behavior is quite good. However, on the load side, it has often been said that our lack of understanding of the actual loads on structures renders a fine-tuned approach with factored load combinations as impractical. However, this statement is exactly backwards. To illustrate this point, let's look at dead and live loads.

In any structure, the engineer

can make a very good estimate of the dead load—the structure itself, mechanical systems, and other permanent fixtures. Consequently, a load factor of 1.2 is used in LRFD. Conversely, we do not have as accurate a means of calculating the intensity of the live load. Instead, in most cases, we rely on code specified minimum levels based upon occupancy and use. This higher relative level of uncertainty (and probability of overload) is addressed in LRFD with the higher load factor of 1.6.

In ASD, part of the factor of safety covers load variability and the other part covers member strength variability. But because LRFD and ASD provide generally equal reliability at a live-to-dead-load ratio of three, we can determine an equivalent "load factor" in ASD.

The dead-and-live gravity load combination in LRFD is  $1.2D + 1.6L$ , which can be equated to  $1.5(D + L)$  when  $L/D = 3$ . This required strength must be such that:

$$1.5(D + L) \leq \phi R_n$$

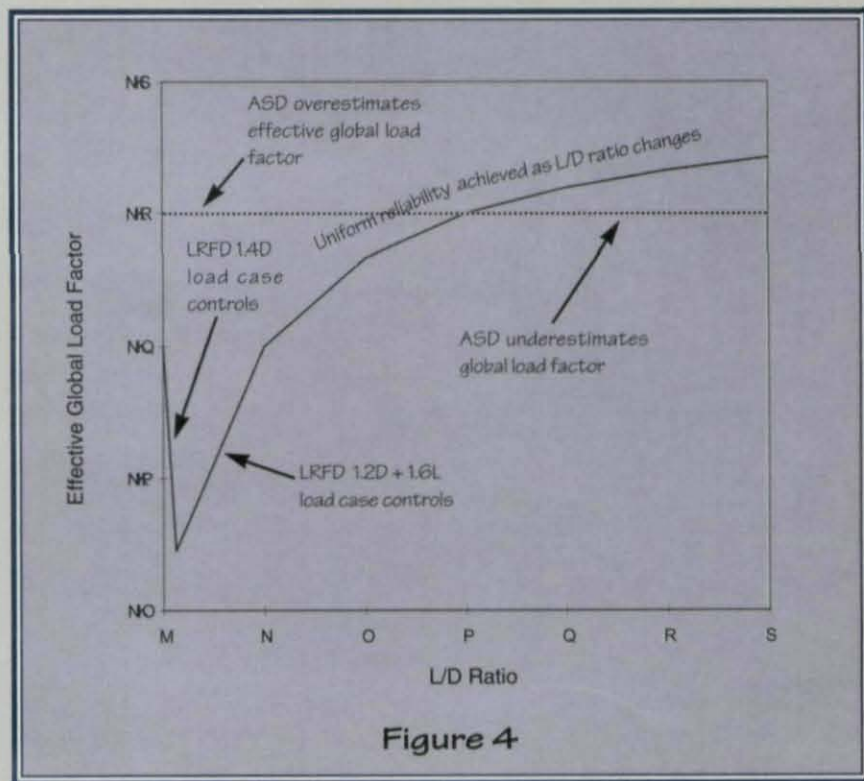

Figure 4



# Can 500 Companies Be Wrong?

YOU'RE INVITED TO FIND OUT FOR YOURSELF!

Since 1985, *Structural Material Manager* has been installed in over 500 companies throughout North America providing fabricators, detailers, and suppliers the most productive material list manager available. This IBM PC-compatible software package performs the following work:

- Main Module computes weights, surface areas, bolt counts & lineal totals.
- Length-Nesting Module produces optimal cut lists from in-house stock, vendor stock, or the best combination of both.
- Plate-Nesting Module draws the best layout for cutting plates from stock sheets.
- Estimating Module tallies material costs, shop hours & field hours.
- Production-Control Module prints shipping lists, loading tickets & job status reports.
- External Data Interface imports existing data, such as bills of material in a CAD system, into the system and eliminates the need for re-typing items.

Call or fax today, and we'll send you a **FREE, NO-OBLIGATION**, fully-functional demo disk and, upon request, references so you can check out our background. The demo includes all the modules and the complete system's user's guide. 500 companies *can't* be wrong! Find out for yourself!



**E.J.E. INDUSTRIES, INC.**

PO Box 268, WASHINGTON, PA 15301

PHONE: 800-321-3955, 412-228-8841 FAX: 412-228-7668

## So Simple To Use, It Even Turns Itself On!



### Elcometer Model 345F - The rugged handheld thickness gage.

The solid **345F** coating thickness gage is so simple to use, you'll wonder how you ever did without it! Auto calibration makes accurate readings simple.

The easy to read display and rough surface capability of the portable **345F** makes it the unit of choice for any jobsite.

Elcometer **345F** simple to use, hard to break.  
Available with integral or separate probes.

For details or a **FREE** brochure, call:

**800-521-0635**



elcometer®

1893 Rochester Industrial Dr.  
Rochester Hills, MI 48309



Please circle # 25

where  $\phi R_n$  is the design strength. Rearranging terms, we have:

$$D + L \leq \frac{R_n}{\left(\frac{1.5}{\phi}\right)}$$

Note that the above inequality is in a form such that  $1.5/\phi$  can be equated to the ASD factor of safety (F.S.). It follows then that F.S. is composed of a global load factor of 1.5 (for  $L/D = 3$ ) divided by a  $\phi$  factor for material resistance reliability (i.e., the same  $\phi$  as in LRFD). In Figure 3, the above relationship is generalized for different ratios of live load to dead load.

It is most interesting to note that this global load factor of 1.5 is then *higher* than that used in LRFD for dead load that we can estimate well, but *lower* for live load that we can't! For this reason, only LRFD can realistically account for both a design where  $D = 100$  psf and  $L = 150$  psf ( $L/D = 1.5$ ) and a design where  $D = 50$  psf and  $L = 200$  psf ( $L/D = 4$ ) because of its consistent reliability approach. In contrast, load variability for these cases is indistinguishable in ASD because the total service load in both is 250 psf. This anomaly should especially be of concern as the proportion of live load to dead load increases. Similarly, for areas of higher wind load, LRFD provides more consistent reliability than ASD, especially in the case of uplift. Perhaps the better question to ask is "Do we know enough about loads not to use LRFD?"

LRFD IS MORE RATIONAL  
FOR THE DESIGNER THAT  
WANTS TO BE CONSERVATIVE

**W**hile the AISC Specification has been developed and calibrated for adequate reliability in building design, another benefit



of LRFD's separate load factors and resistance factors is having a rational means of addressing special cases of uncertainty in loading or member performance. For example, in response to the concern that a special-case live load may be excessively variable, the engineer can use a more conservative load factor of 1.7 instead of the minimum 1.6. Or, if the usually well known dead load is instead a concern for a specific project, the engineer can unilaterally increase the load factor from the 1.2 minimum value to 1.3 or 1.4 as appropriate. In this way load variability concerns can be addressed separately and directly without penalizing the strength side of the equation.

On the resistance (strength) side, if the function of a critical structure were to dictate that the columns be designed to a higher reliability against column buckling, the engineer could choose to use  $\phi = 0.75$  instead of the maximum specified  $\phi = 0.85$ . Or in a roof truss for which tension fracture of a chord element might precipitate catastrophic failure of the structure, the engineer could choose to use  $\phi = 0.65$  instead of the maximum  $\phi = 0.75$ . In this way, the engineer can ensure desirable structural behavior and/or preclude undesirable limit states without unnecessarily conservative treatment of loads.

Thus, LRFD yields a rational means by which the engineer can assure safety in a wide variety of structural designs with appropriate and specific conservatism when justified. In contrast, ASD's single factor of safety means that any attempt to independently address either load variability or member strength variability needlessly impacts both. Even worse, the effect of the increase in factor of safety is diluted among the two, potentially undercompensating for the one and unnecessarily overcompensating for the other.

## GLOBAL COMPETITIVENESS

The era of world-wide competition is upon us and Americans can no longer view the world as from sea to shining sea. Simply stated, there can be no doubt that the best way to compete is with the best available tools. Accordingly, it behooves the American engineering community and fabrication industry to begin exporting their talents with the tools that put them one step ahead of their competition.

AISC's LRFD Specification is a world-class, practically oriented, limit-states design specification. What's more, because a metric version is currently available, it is suspected that most international jurisdictions would accept it, either as an alternative to their own code or in the absence of an established code. Even if this is not the case, AISC's LRFD Specification would form a convenient and familiar basis for the American engineer to get acquainted with the internationally prevalent limit-states design philosophy.

## ADOPT A POSITIVE DIRECTION

While ASD may not be beyond its useful life today, there can be no question that LRFD will supplant it as innovative ideas become mainstream practice. In the short term, it is certainly possible to continue successfully without LRFD. But as the long term transition continues, we as engineers must prepare for innovative progress, not ignore it.

Whatever time frame you choose, the transition to LRFD should be a key assumption in your operating plan.

*Charles J. Carter, P.E., is a Senior Staff Engineer—Structures with AISC. This paper was prepared as an activi-*

*ty of the ASCE Committee on Load and Resistance Factor Design, which is chaired by Jerome F. Hajjar. The author thanks the members of the Committee for their valuable input, particularly the task group of I. (Ed) Alsamsam, W. Samuel Easterling, Roberto T. Leon, and Kurt D. Swensson.*



The two-volume second edition of the LRFD Manual of Steel Construction is available for \$132 by calling 800/644-2400 (each volume sells separately for \$72).

**Volume I—Structural Members, Specifications, and Codes** includes seven sections:

- Dimensions and Properties
- Essentials of LRFD
- Column Design
- Beam and Girder Design
- Composite Design
- Specifications and Codes
- Miscellaneous Data and Mathematical tables

**Volume II—Connections** includes six sections:

- Bolts, Welds and Connected Elements
- Simple Shear and PR Moment Connections
- FR Moment Connections
- Connections for Tension and Compression
- Other Connections
- Construction Industry Organizations





# EXTENSIVE PRE-ASSEMBLY RADICALLY CUTS TIME

Innovative construction techniques  
limited bridge closure during an  
expansion project to just 12 days

By Vincent J. Roney

**W**HEN THE GEORGE P. COLEMAN BRIDGE OVER THE YORK RIVER in Virginia opened in 1952, it had the second longest double swing span in the world—and the largest bridge in Virginia. Since that time, however, traffic volume has increased drastically.

The original bridge was designed to carry 15,000 vehicles per day; currently it carries 28,000, with traffic projections of 43,000 vehicles per day in the year 2015. In addition, the approach roads to the bridge were each four lanes wide, while the bridge itself was only two lanes, which resulted in severe congestion during the morning and evening rush hours.

In 1986, the Virginia DOT began examining ways to improve traffic capacity across the York River between Gloucester Point, a growing residential community, and Yorktown, an area of significant historical importance. An environmental impact statement was initiated the following year that studied an area extending approximately 21 miles around the crossing and initially included 17 alternate crossings, including tunnels, high-level bridges



and the widening of the existing George P. Coleman Bridge. As a result of the study, widening the existing bridge was chosen as the best alternative.

Because the widening would involve a temporary closing of the bridge, an alternate means of maintaining traffic during construction was required. A ferry boat/bus system was considered, but this was rejected as too expensive, too slow and too prone to stoppages due to adverse weather. A more reasonable approach was to install a \$19 million temporary floating bridge adjacent to the existing bridge. Unfortunately, in 1993 when the General Assembly approved the bonds for the bridge expansion, they eliminated the temporary bridge as a means of reducing the total project cost.

As a result, VDOT had no choice but to detour traffic 75 miles around the proposed construction site. Therefore, it was critical that the bridge be closed for as short a time as possible. To minimize the closure time, VDOT and its design consulting firm, Parsons, Brinckerhoff, Quade and Douglas, developed a scheme for floating into place the new structure. As a result of this cooperative effort, a plan was developed that would allow the contractor to swap out the truss sections in two 12-day periods, thus minimizing the inconvenience to motorists.

#### EXISTING STRUCTURE

Construction of the original double-swing Warren-type deck truss bridge, which replaced an existing ferry, began in December 1949 and was completed in May 1952 at a cost of \$9 million. The structure had a clear roadway width of 26' with an overall length of 3,750'. The land approaches consisted of two 65' and 12 90' plate girder spans. Between the approach spans was a 2,240' symmetrically arranged riveted deck truss system. The center consisted of a pair of 500' center pivot swing spans.

**Continued on page 30**

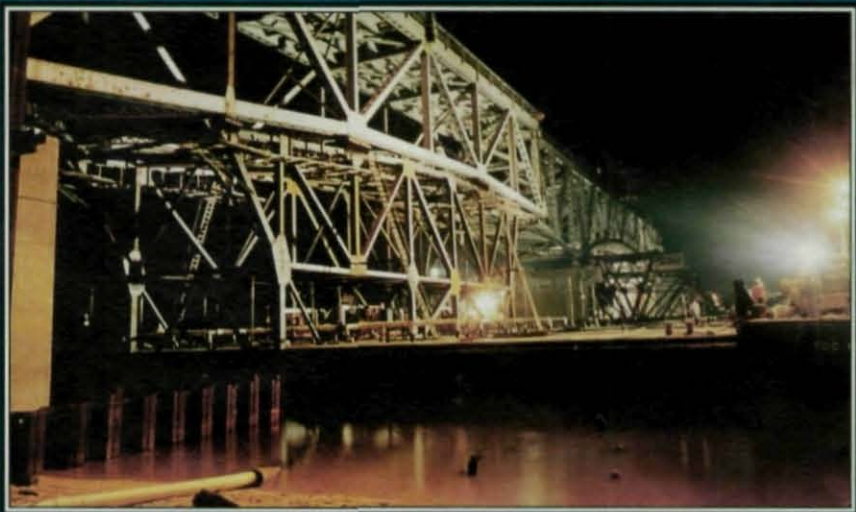

**Six new sections were constructed off-site and then floated on barges to the bridge.**







the spans adjacent to the trusses. These spans sit on the end of the trusses and were replaced with late girder spans. The truss ends of the spans were supported on falsework bents during the truss swap out.

The original approach span piers have timber piles of unknown length. The new piles for the widened footings are steel pipe piles and are designed to carry the total load of the existing and widened structure by themselves.

While the width of the superstructure has been increased considerably, the effect of the added load applied to the bridge piers is not significant. The main issue evaluated during the new design was the allowable bearing pressure on the soils below the caissons. Extensive testing was conducted to establish the soil capacity, including borings to a depth of 200' adjacent to the pier to establish the in-place soil strength. Based on this investigation, the increases in the pressures were found to be acceptable and a large factor of safety remains in the capacity. Due to concerns regarding possible ship collisions with the bridge, a finite element analysis investigation was performed. The forces and displacements were calculated and the results were acceptable. Also, a vessel collision study was made in accordance with AASHTO's *Guide Specification and Commentary for Vessel Collision Design of Highway Bridges* (1991). This study showed that the annual frequency of collapse for the bridge is acceptable so that no additional pier protection system is required.

Although wider than the existing trusses, the new ones appear very similar. By utilizing higher strength Grade 50 and 70 steels, the overall depth of the trusses remain approximately the same. The truss members are shop welded with field bolted connections. Except for the truss spans, regular weight concrete was utilized to construct the

**Continued on page 32**

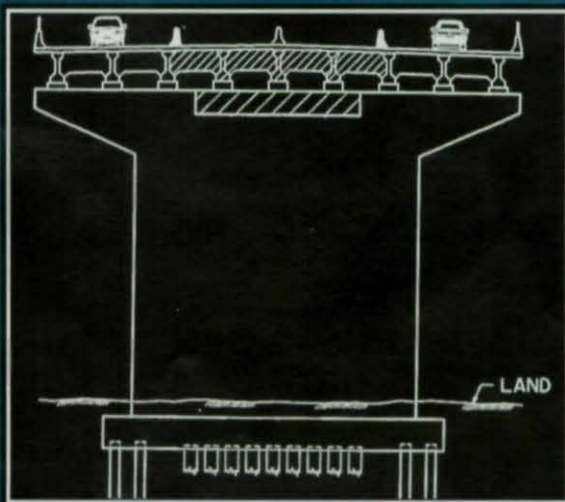

**The substructure was widened and the river pier caps were enlarged utilizing cantilever construction.**





# Multiframe for Windows

The next generation of structural analysis and design software.

The most talked about graphical interface in structural analysis software is now available for Windows 95/NT. Multiframe brings a totally graphical approach to structural modeling, analysis and design - intuitive, fast and powerful design software that works the way you do.

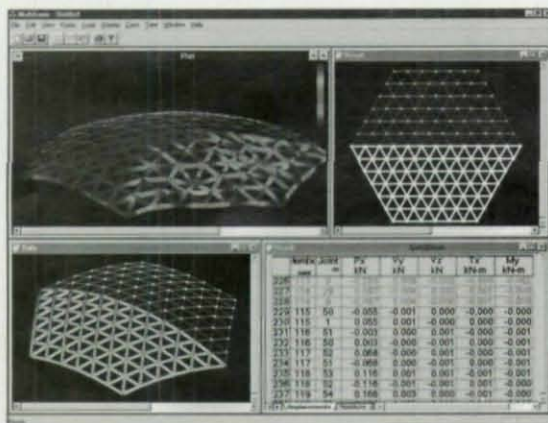

Find out why innovative structural engineers worldwide choose Multiframe. Contact us for your free demonstration kit and video.

Formation Design Systems:

Tel (408) 464 1949 Fax (408) 464 0731

<http://www.formsys.com>

# Multiframe

Computer Aided Design for The Structural Engineer

bridge decks. Lightweight concrete was used in the new swing span deck in lieu of the steel grid deck used in the original construction, which improves the riding surface.

The bridge is controlled by a programmable computer with a manual backup, and is operated by a redundant hydraulic motor system.

## CONSTRUCTION PHASES

A contract to widen the George P. Coleman Bridge was let in October 1993 to Tidewater Construction Corporation in the amount of 73 million dollars with a completion date of August 1996. This contract included a \$4,000 per hour incentive fee and an \$8,000 per hour penalty fee for each closure period allowed for swapping out the truss sections. The Contractor's plan of operation which was reviewed and approved by the Department indicated that the trusses would be swapped out in one 12-day period in lieu of the two 12-day periods stipulated in the contract.

Steel fabricators on the project were AISC-members Stupp Bros. Bridge & Iron Co. and Vincennes Steel Corporation.

Widening of the bridge was accomplished in five construction phases. The first phase consisted of widening the substructure. New piles were driven adjacent to the existing land piers and the piers were widened. Also, the river pier caps were enlarged utilizing cantilever construction.

During phase two, new approach spans were constructed on each side of the existing bridge except for the spans that sit on the end of the widened truss. During the first two phases, normal traffic continued to use the bridge. Also during this phase, the six truss spans were being preassembled on temporary supports 30 miles away at Norfolk International Terminal. As part of this phase, the machinery and operating equipment for the trusses were installed and tested.

Please circle # 92



During phase three, the fixed and swing trusses were floated off of their temporary supports at NIT and swapped out with the existing trusses at Yorktown. During this time, the end approach spans were supported on falsework bents. This work occurred between April 3, 1996 and May 11, 1996. The following is a sequence of events as they occurred:

- On April 3, the first of six sections of the new bridge was floated from NIT and anchored just down river from the old bridge. The 210', 1,300-ton suspended span was lifted from its temporary -piers using buoyancy. Two barges with support towers were filled with water and were positioned underneath the span. Once in place, the water was pumped out and the barges rose, picking up the span. The barges carrying the new span then began their journey to Yorktown with the help of two tug boats. Two other spans joined the smaller suspended span anchored near the bridge. The other three sections waited in Norfolk until barges could return. Everything was in place waiting for the shutdown to begin.

- A comprehensive traffic management plan for the West Point detour was also in place. Before the project even began, VDOT was working with other state agencies and local officials in preparation for the 75 mile detour when the bridge was to be closed.

- VDOT crews began uncovering signs marking the detour through West Point at 1:00 a.m. Saturday, May 4, and four and a half hours later the bridge was closed.

- Construction crews wasted little time getting to work and by noon the first old span, the Yorktown side swing span, was removed and ready for its trip to Norfolk. Then the first problem occurred. Pins holding the span closest to the Yorktown shore had corroded over the 44 years since the bridge was built. While

**Continued on page 34**



**Today, the bridge is one of the few double swing-span bridges still in operation.**



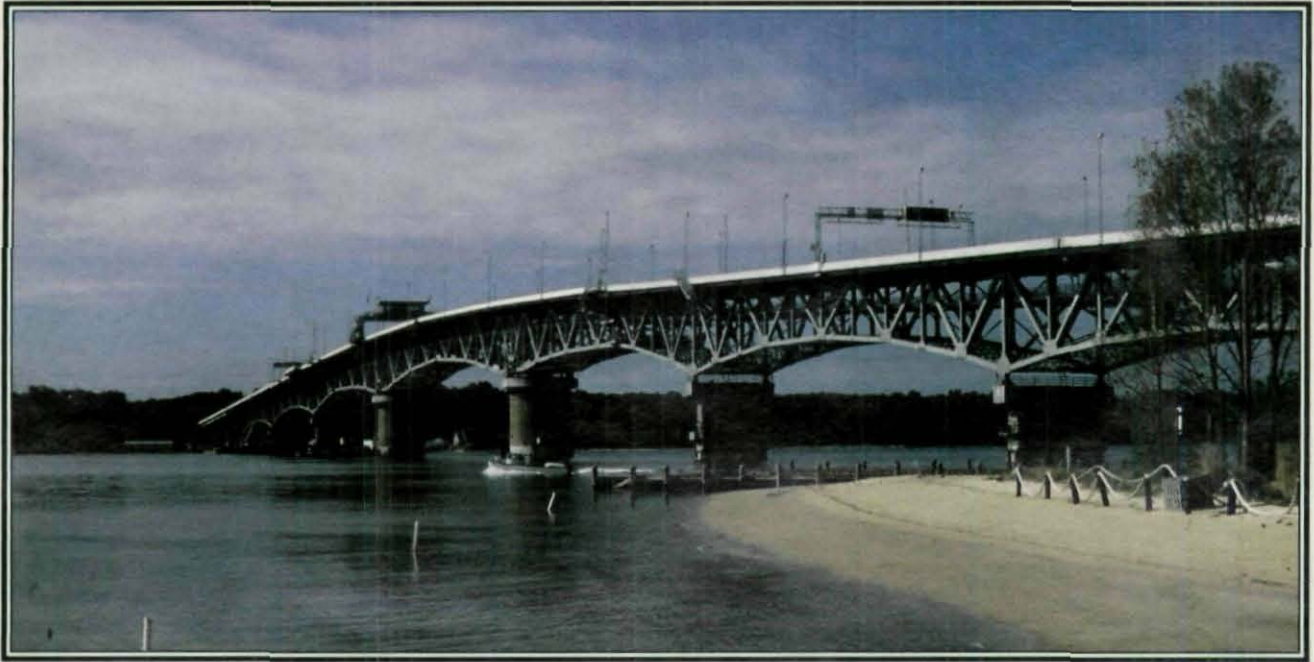

crews worked to free the span, the tide slowly ebbed. The pins were finally removed, but the tide was too low to float the section away. The Contractor waited and floated the section out at 1:00 a.m. The last Yorktown span, the anchor span, came out easily at 11:30 a.m. on Sunday.

- Next, construction crews began preparations to float the new Yorktown spans into place. The small suspended span was brought in first, but it had to wait until the anchor span was set onto its pier. As workers began moving the anchor span from its mooring, severe thunderstorms stopped work for the night. On Monday, crews worked throughout the day and by 8:00 p.m. both the anchor and suspended span were in place.

- On Monday night, weather was once again a problem for construction crews. Wind with gusts of up to 50 m.p.h. created unsafe conditions and the Contractor waited until Tuesday morning to move the swing span into position. Fighting strong wind and rainy conditions, construction crews began moving the span into place at 8:30 that morning. Extra tugs were needed to steady the 8.5 million pound span.

- Meanwhile, the old sections

of the bridge arrived at the Norfolk International Terminal. They were placed on temporary piers where the new bridge was built. Barges also began removing the new Gloucester end of the bridge from NIT. While crews lifted the suspended span from the temporary pier, the load became unbalanced and the span slammed back onto the pier. The damage was not significant and could easily be repaired at another time and would not cause a delay in the project.

- Work to remove the Gloucester sections of the old bridge began Wednesday night. The suspended span was removed at 3:00 a.m., followed by the swing span at 4:30 a.m. on Thursday. Later that afternoon, workers removed the anchor span. The new suspended span and anchor span were moved into place early Friday morning and crews worked throughout the day to set them into place. The last new section, the swing span, was brought into place on Saturday afternoon.

- Construction crews got the swing span into place just in time as another severe storm passed through the area Saturday night. The storm delayed work for a few hours,

but crews were soon preparing the new bridge for traffic. They were installing forms for pouring the concrete barrier walls and roadway joint closures and stripping the roadway. Crews were also finishing up the electrical hookups for service power and the roadway lights.

- At 8:26 Monday morning, May 11, 1996, three days ahead of schedule, the bridge was reopened for vehicle traffic.

In phase four, traffic was shifted to the new outer lanes and the original inner superstructure was demolished and replaced.

During the fifth and final phase, the toll facilities were completed and the widened bridge was opened for traffic at 12:01 a.m. August 3, 1996.

*Vincent J. Roney is a district structure and bridge engineer with the Virginia DOT. He is responsible for the safety and maintenance of more than 1,350 bridges in the 11 cities and nine counties that make up the Suffolk District. In addition, as a senior structural engineer, he provides design and construction expertise during the planning and building phases for new and rehabilitation bridge projects.*



**A**s if you needed any more proof, we've made it even easier to get the most current and complete information from Chaparral Steel—and all you need is a FAX machine.

With Mill/FAX you have direct access to the most up-to-date information, including open order status, stock availability, rolling schedules, 10-day shipment history, rail shipments, and scheduled shipments for the day—all in an instant.

If you're already a Chaparral customer, you can access Mill/FAX, using your identification number, by calling 1-800-645-4155. If you're not yet a Chaparral customer and would like information on this free, even more convenient service, call Chaparral Steel at 1-800-527-7979. Or just send us a FAX at (972) 775-6120.

**MORE PROOF  
THAT DOING  
BUSINESS WITH  
CHAPARRAL IS  
EASIER THAN  
EVER.**



**CHAPARRAL  
STEEL®**

Chaparral Steel  
300 Ward Road  
Midlothian, Texas 76065-9651  
Toll Free (800) 527-7979  
U.S. and Canada  
Local (972) 775-8241  
Fax (972) 775-6120





# DESIGNING WITH STRUCTURAL TUBING

The 1996 T.R. Higgins Award recognizes Donald Sherman for his work on HSS design and connections

By Donald R. Sherman, Ph.D.

**A**LTHOUGH THE USE OF STRUCTURAL TUBING AS TRUSS MEMBERS AND COLUMNS IN BUILDING CONSTRUCTION CONTINUES TO INCREASE in the U.S., it still has not reached the proportion found in some countries—where it approaches half the market for structural steel. Many designers still think of structural tubing as a new technology, even though round tubes were used in some of the earliest steel structures. However, early steel design specifications were primarily developed from experience with hot-rolled sections and it was not until the 1940s that criteria for circular tubes appeared in U.S. design specifications.

Technology for efficiently mass producing square and rectangular structural tubes has been developed in the past few decades, with a resulting surge in research on member and connection behavior and a subsequent development of design criteria. The culmination of this research will be a new Hollow Structural Sections Manual, jointly produced by AISC and the Steel Tube Institute with funding from AISI. The new manual should be available late in the second quarter of 1997 and will cost \$72.

There are several advantages associated with the tubular section as opposed to shapes with open profiles:

- Since the moment of inertia is the same about any axis for round and square tubes, these sections are the most efficient for columns that have the same end restrains in any direction. For different end restraints about the principle axes, a rectangular tube can be selected with proportions that provide the same column slenderness ratio about the major and minor axes, thereby providing the most efficient use of the material. The section modulus also can be optimized for beams in biaxial bending.
- The torsional stiffness of the closed shape and the high weak axis moment of inertia minimize the requirements for lateral bracing of tubular beams. Round and square sections require no lateral bracing and rectangular beams bending about the major would require lateral bracing only for extreme depth-to-width ratios. The torsional stiffness and strength also make tubes the



*The Audobon Society Building in Portland, ME, is a wonderful example of the structural versatility and architectural elegance of exposed hollow structural sections.*

ideal shape for space frame construction.

- The smooth profile has aesthetic appeal for exposed members and the resistance to fluid flow forces (wind or water) is minimized.
- The profile provides the minimum surface area, which minimizes costs for painting and other surface maintenance requirements. The minimum surface also is an advantage for structural members in clean production facilities.

This article will focus only on square and rectangular Hollow Structural Shapes (HSS).

## HSS PRODUCTS

There are two primary ASTM specifications for



HSS sections.

- A500: Cold-Formed Welded and Seamless Carbon Steel Structural Tubing in Rounds and Shapes
- A501: Hot-Formed Welded and Seamless Carbon Steel Structural Tubing

In addition, A618 and A847 are for alloyed hot- and cold-formed tubes that must be obtained by special order from a manufacturer.

From the primary specifications, it appears that four types of HSS products are available. However, in the U.S. there is only one type that can be realistically obtained: cold-formed welded. The typical HSS product is an A500 Grade B with a yield strength of 46 ksi and an ultimate strength of 58 ksi, although much of it would qualify as Grade C with 50 ksi yield and 62 ksi ultimate. Grade C can



*The Salt Palace—Salt Lake City's new Convention Center—utilized tubular members to frame its extensive skylight system.*

be certified by special order from a manufacturer (for a complete listing of structural tube availability, see the January and July issues of MSC).

In addition to the magnitude of the yield and ultimate strengths, the method of manufacture also influences other characteristics that affect structural behavior.

- Cold-formed A500 HSS have through-thickness residual stresses that are on the order of 80% of the yield strength of the material on the inside of the section. The variation of the mean residual stress around the perimeter is not as large, with compression of about 10% of the yield stress in the corners. A higher tension residual stress exists in a localized area at the weld.
- The straightness of HSS sections depends on the manufacturer, but in most cases members are well within the tolerance permitted by A500. Common out-of-straightness measurements are less than  $L/5000$ , which is much better than hot-

formed open sections.

- Due to cold-working, there is a variation in the yield strength around the perimeter of the section, with a higher yield in the corners. The specified yield is from the center of one of the walls that does not contain a weld. Consequently, squash loads for stub columns can exceed the yield time the area.
- Thicknesses are very uniform in the sides of the HSS but somewhat greater in the corners.

The topic of thickness merits additional comments. The A500 specification permits the wall thickness to be 10% under the nominal value. Plate and strip from which HSS are made are produced to a much smaller thickness tolerance. For several marketing reasons, manufacturers in the U.S. take advantage of this situation and consistently produce HSS near the lower end of the A500 tolerance. Consequently the Steel Tube Institute of North America and AISC have issued a statement concerning the design thickness: "...a suggested modified wall thickness representing .93 of the nominal wall dimension should be used for calculations involving engineering design properties."

Tables of section properties and load tables for structural members that reflect this policy are being prepared.

#### MEMBER DESIGN CRITERIA

It is not the intent of this paper to review all the member design provisions for HSS sections. However, there are a few items of concern or differences with more familiar procedures for hot-formed open profiles that will be discussed. The criteria are from the current LRFD Specification issued by AISC.

#### AXIAL COMPRESSION

There have been a few HSS column testing programs in North America, but most data is from an extensive series of column tests conducted by CIDECT (Comite International pour le Developpement et l'Etude de la Construction Tubulaire) in the 1970s. A distinct difference in the normalized column strengths between hot-formed and cold-formed HSS was observed in the CIDECT programs, causing cold-formed tubes to be assigned to lower column curves in specifications with multiple curves. The high levels of residual stresses is a major factor for the lower normalized strength. In the U.S. where a single column curve is used in the LRFD Specification, much of the cold-formed data falls below the curve, indicating somewhat unconservative design. However, this situation is not as severe as accepted practice with heavily welded open shapes, where normalized test data is even lower than that for A500 HSS.

The apparent unconservative design of cold-formed HSS columns is not as critical as it appears. Much of the CIDECT test data was normalized by the offset yield of the section obtained



from stub column tests. This reflects the inherent high yield stress in the corners of the tube resulting from cold working. Since U.S. practice is to determine the yield strength with a coupon taken from the middle of a side of the finished tube, the yield load calculated by the material yield strength times the gross area will be less than the weighted average that includes higher strengths in the corners.

Local buckling of HSS is an important consideration since about half of the standard HSS sizes have at least one pair of sides where the flat-width/thickness ratio exceeds  $238/\sqrt{F_y}$  and the section is classified as thin-walled. Therefore, the LRFD column equation in Appendix B is the basis for many HSS designs.

$$P_{cr} = A_g(0.685^{Q/\lambda_c^2})QF_y \text{ for } \lambda_c\sqrt{Q} \leq 1.5$$

$$P_{cr} = \left[\frac{0.877}{\lambda_c}\right]F_y \text{ for } \lambda_c\sqrt{Q} > 1.5 \quad (1)$$

$$\lambda_c = \frac{KL}{r\pi} \sqrt{\frac{F_y}{E}}$$

The factor  $Q$  accounts for local buckling of HSS and is based on the effective width concept and accounts for inelastic action and imperfections. The concept pertains to the force carried by a long

plate supported on two edges parallel to an axial force. A uniform stress, which has the same magnitude as the true stress at the edge, acting on the effective width will result in the same post-buckling force using the true stress distribution. The effective width equation for the case when the side supports have the same thickness as the buckled plate is used by AISC for local buckling of a tube wall.

$$b_e/t = 1.91\sqrt{E/f}[1 - 0.381\sqrt{E/f}/(b/t)] \leq b/t \quad (2)$$

In this equation,  $b$  is the flat width of the side of the tube and  $f$  is the average stress based on the total gross area, usually the critical stress for the column. The reduction factor  $Q$  is the ratio of the remaining effective area divided by the gross area and Equation 1 is used to determine the column buckling load, which reflects local buckling interaction. Since AISC bases  $f$  on the full section properties of the section rather than the effective properties, iteration to determine the critical load is avoided. If the average column stress is sufficiently low so that the effective width is the full flat width,  $Q$  is equal to one.

#### BENDING

Thin walled HSS in bending are designed with

# HOLE SALE

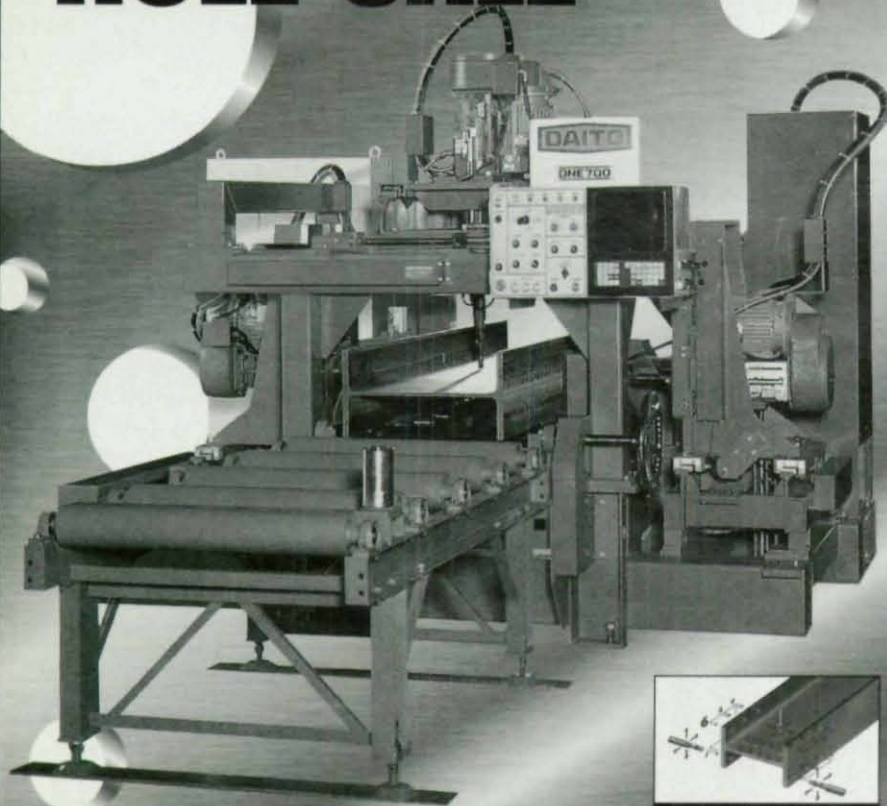

PATENTED FIXED WORK,  
MOVING DRILL

## The **NEW** Affordably Priced DNE700 - Automatic Drilling Machine for Structural Fabricators.

Designed for maximum productivity on multiple small lot jobs, our DNE700 gives you more drilling for the dollar.

The world's leading producer of CNC structural drilling lines, we've combined Daito quality, innovation, engineering and affordability to develop our latest machine. **Featuring a patented design, the DNE700's drills move independently on 3 axes for maximum productivity and accuracy.** What's more, because we've omitted a material gripper for the easy passage of structural shapes, the DNE700 saves time, space and costs.

Daito offers a full line of the world's finest structural drilling machines and band saw machines. For the "hole" story, give us a call.



**DAITO U.S.A. INC.**

1894 S. Elmhurst Road, Mount Prospect, IL 60056

Tel: (847) 437-6788 • Fax: (847) 437-6789

E-mail: [daitousa@cin.net](mailto:daitousa@cin.net)

Web Site: [www.hama.com/daito/1daito.htm](http://www.hama.com/daito/1daito.htm)



the effective width concept of Equation 2 for the compression flange. In this case the stress,  $f$ , is taken as the yield stress since failure occurs when the yield stress is reached in the corners. Using just the effective width for the compression flange causes a shift of the neutral axis away from the flange, as well as a change in the moment of inertia and the section modulus. The limit moment is determined by setting the bending stress calculated with the effective section modulus equal to the yield stress, or

$$\phi M_n = \phi S_{eff} F_y \quad (3)$$

Square HSS are not subject to lateral-torsional buckling and, therefore, do not require lateral bracing. Rectangular HSS bending about the major axis could buckle laterally and AISC currently has provisions for the unbraced length. However, for HSS sections, the unbraced lengths are so large that realistic designs would be controlled by deflection or the reduction of the section moment capacity caused by lateral-torsional buckling is negligible. For example an HSS20 x 4 x 1/8", which has one of the largest depth/width ratios of standard HSS, has  $L_p$  of 8.7' and  $L_r$  of 137'. An extreme deflection limit might correspond to a length/depth ratio of 24, or a length of 40' for this section. Using

the linear reduction between the plastic moment and the yield moment for lateral-torsional buckling, the plastic moment is reduced by only 7% for the 40' length. In most practical designs where the moment gradient  $C_b$  is also a factor, the reduction will be nonexistent or insignificant. The only case where lateral bracing is an important consideration is when a plastic analysis is used for the moment distribution in the structure and some hinges must sustain finite plastic rotations to develop the failure mechanism. The maximum unbraced length from the hinge is

$$L_{pd} = \frac{0.17 + 0.10 (M_1 / M_2)}{F_y / E} r_y \geq 0.10 \frac{E}{F_y} r_y \quad (4)$$

In Equation 4,  $M_2$  is the plastic moment of the section,  $M_1$  is the smaller moment at the end of the unbraced length, and  $r_y$  is the radius of gyration about the minor axis.

#### CYCLIC AXIAL LOADING

HSS braces have been known to fracture catastrophically in earthquakes. A pilot program consisting of nine tests of members subject to axial end displacement reversals was conducted to investigate the failure mode. The program consisted of testing two thicknesses of 5"x2" HSS under axial

## DESIGN YOUR NEXT STRUCTURE IN MINUTES!

Integrated Engineering Software has set a new standard for structural tools. We built our products on object-oriented, user-centered principles--and we tossed out confusing, non-standard interfaces. We've got the engineering features you need for 95% of your structural work. And they are all amazingly simple to use! Our customers say "You've helped me improve the quality of my work!" To make sure you feel the same way, we offer free technical support and a money-back guarantee with every product we sell.

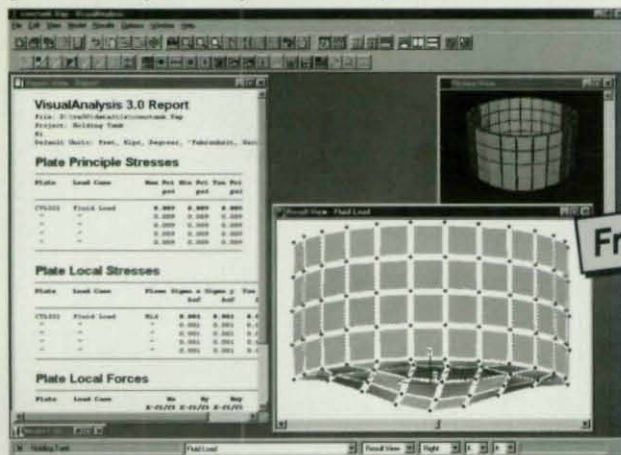

**Free Demo. Call Today! 1-800-707-0816**

**VisualAnalysis v3.0**  
from \$395. General frame and FEA capabilities in a remarkable tool. Design add-ons let you buy exactly what you need.

**AnalysisGroup v1.1** at \$295  
Easy (no nonsense) solutions to six common structural problems.

**ShapeBuilder v1.0** at \$95  
A fun drag & drop utility for creating built-up member cross sections.

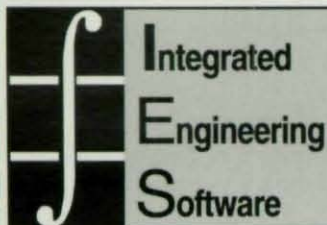

8840 Chapman Road, Bozeman, MT 59715-7133

Phone: (406)586-8988, Fax (406)586-9151

Email: info@iesweb.com, Web: http://www.iesweb.com



**Table 1. HSS Test Specimen Properties**

Size	b/t	KL/r	F <sub>y</sub> kips	P <sub>y</sub> kips	P <sub>stub</sub> kips
5x2x <sup>3</sup> / <sub>16</sub> "	36	83.5	46.1	71.0	77.7
5x2x <sup>3</sup> / <sub>16</sub> "	23	86.4	57.0	127.2	161

**Figure 1**

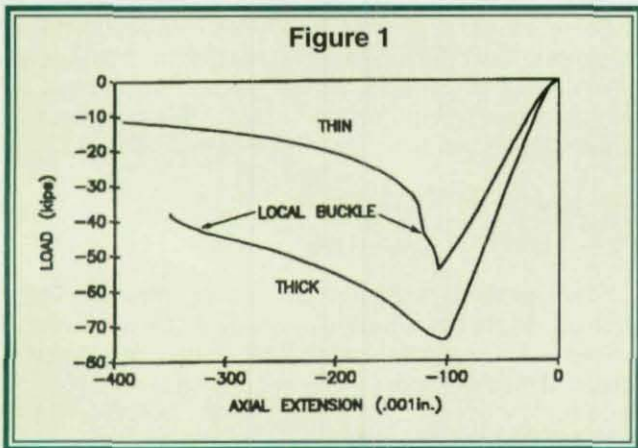

displacement with ends pinned for column buckling about the weak axis. The properties of the test specimens are summarized in Table 1.

The size, *b/t* and column slenderness (*KL/r*) are based on nominal dimensions. The yield stress (*F<sub>y</sub>*)

and the measured stub column strength (*P<sub>stub</sub>*) were obtained in static tests while the yield load (*P<sub>y</sub>*) is calculated from the static yield stress and the actual HSS dimensions. The fact that the stub column tests are higher than the yield load reflects enhanced yield properties in the corners of the HSS and indicate that local buckling occurred in the strain hardening range.

The AISC Specification defines a thin-walled HSS under uniform compression as having a *b/t* that exceed  $238/\sqrt{F_y}$ , or in this case 35 for the thin HSS. The recent AISC Seismic Provisions limit *b/t* to  $110/\sqrt{F_y}$  or about 15 for both of the two sizes. Therefore, the thicker of the test specimens would have been acceptable under the older code provisions, but neither HSS would be acceptable under the newer seismic provisions.

Both tube sizes were initially tested as columns under very slow monotonic axial loading. The resulting load vs. axial displacement curves are shown in Fig. 1. Since the column slenderness is almost identical for the two sizes, overall column buckling occurs at essentially the same axial displacement. Subsequent local buckles, however, develop at less displacement in the thinner HSS. In the cyclic test program, axial displacement limits were at 0.200" where only the thin HSS formed a local buckle and at 0.400" where both HSS had

## ▶ RAMSBEAM ◀

Guaranteed to be the BEST beam program ever or your money back!  
RAMSBEAM, a single steel/steel composite beam program utilizing a Windows graphical interface. Features: ASD or LRFD; vibration analysis; checks existing framing or optimizes new. Allows for depth restrictions, cantilever beams; partial or full composite and unbraced flange conditions; includes SI/Metric units.

Special Limited Time Offer \$150

### Ram Analysis

5315 Avenida Encinas, Suite 220  
Carlsbad, CA 92008  
Tel. 800-726-7789 • Fax. 619-431-5214

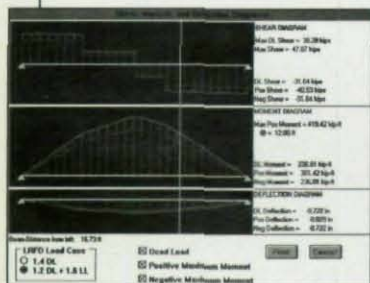

FREE  
DEMO!

Please circle # 81

## The #1 32 bit Win95 Structural Program offers the "3 in 1" Deal!

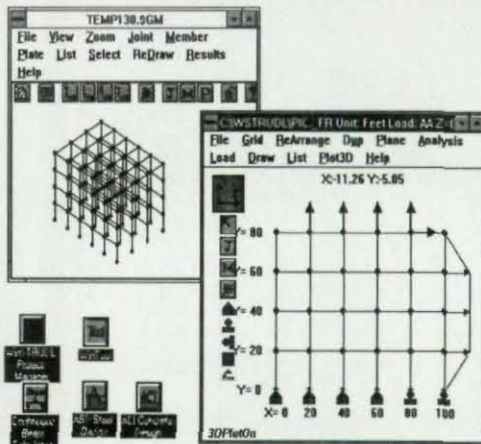

Ask for a Free DEMO Today!

# WinSTRUDL

Email: [wstrudl@ix.netcom.com](mailto:wstrudl@ix.netcom.com)

Computer Aided Structural Technology, PO Box 14676,  
Fremont, CA 94539-4676 Tel (510) 226-8857 Fax 226-7328

Please circle # 27



Displacement (in.)	Thick			Thin		
	Test	Period (sec)	Cycles	Test	Period (sec)	Cycles
-.200, +.200				7	480	32
	4	16	500+	8	16	32
-.300, +.300				10	2	27
-.400, +.200	2	40	31			
	5	5	34			
	4A	5	41	Preload		
	3	2	40	9	2	18

Full yield in axial compression	238 / $\sqrt{F_y}$
Plastic bending moment	190 / $\sqrt{F_y}$
Yield bending moment	238 / $\sqrt{F_y}$
Axial compression for brace in seismic zone	110 / $\sqrt{F_y}$

local buckling.

The variables in the cyclic test program were the axial displacement range, the mean axial displacement and the rate of loading as determined by the period for a cycle. A similar pattern of behavior was observed in most of the cyclic tests. Column

buckling is followed by a local buckle which leaves "horns" at the corners. After several cycles with tension excursions, cracks initiate at the HSS corners on both horns and propagate through the thickness and away from the corners in subsequent cycles. As section is lost at the cracks resulting in an eccentric load, the lateral deflection reverses during the tension part of the cycle but return to the original direction during compression, producing a snap-through behavior. Eventually the crack pops across the local buckle, resulting in increased lateral deflection that creates a large enough eccentricity to reverse the direction of column buckling in the subsequent compression. Table 2 presents the displacement range, the test identification number, the cycle period and the number of cycles for a full fracture across the width of the section.

The most significant conclusion from the tests is that Test #4, which buckled as a column but did not form a local buckle, sustained over 500 cycles of loading without developing a crack. All other tests where local buckling did occur failed in 41 or fewer cycles.

These pilot tests demonstrate that the only important parameter in determining whether HSS braces will survive a seismic event is the formation of local buckles. In summary, the  $b/t$  limits for

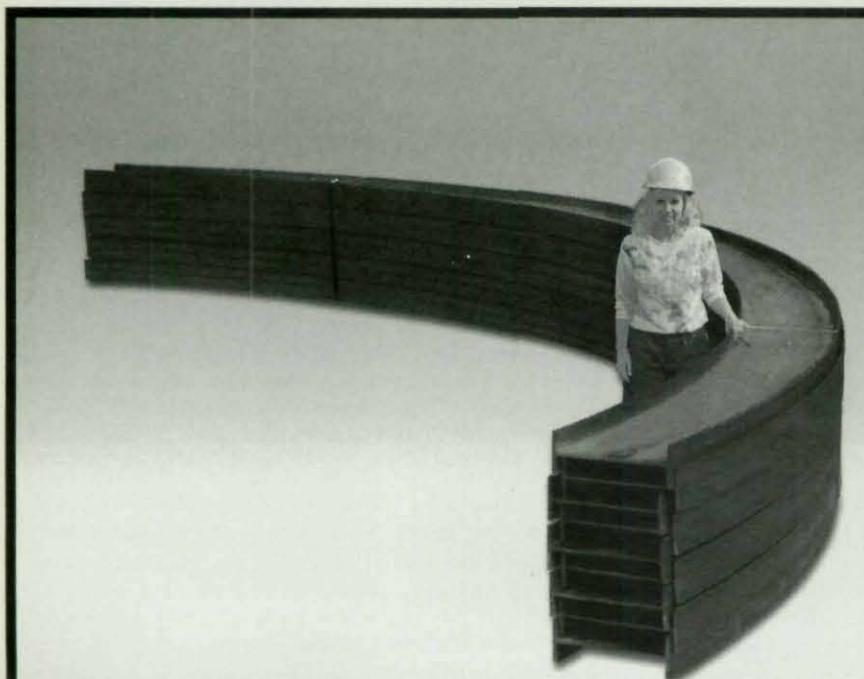

# WHITEFAB INC.

## BIRMINGHAM ALABAMA

Phone (205) 791-2011 Fax (205) 791-0500

- With our patented process, we recently rolled these W18 x 35# beams the hardway to a 24'-4" outside radius.

- Here are just a few more examples of our hardway beam rolling capabilities:

Size	Radius
W16 x 50#	25'-0"
W16 x 26#	20'-0"
W14 x 43#	30'-0"
W14 x 22#	20'-0"
W12 x 53#	25'-0"
W12 x 19#	15'-0"
W10 x 26#	20'-0"
W 8 x 18#	10'-0"

- Of course we do channels, tubing, tees and other shapes, both the hardway and the easyway.

- May we help you with all your rolling requirements?



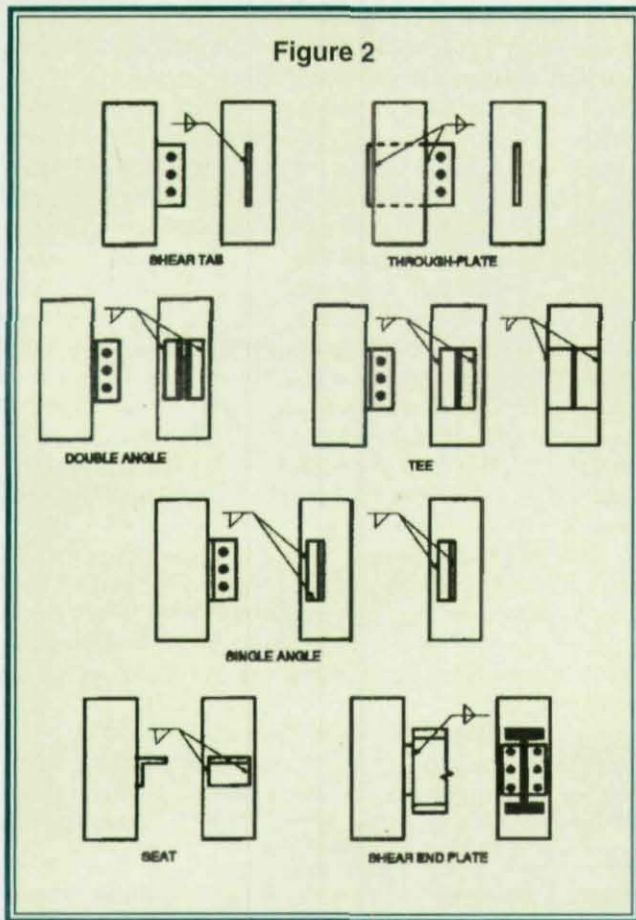

various limit states appear in Table 3.

#### SIMPLE FRAMING CONNECTIONS

Connections have been a concern for some designers who consider the use of structural tubing. Research has shown that a variety of familiar simple framing connections can be used to connect wide-flange beams to HSS columns. Since the cost of different simple connections with the same capacity can vary by more than a factor of two, it is important to understand when inexpensive connections such as shear tabs can be used without compromising the strength of the tubular column.

This discussion concerns nine different types of simple framing connections used with HSS columns. These are shown in Figure 2.

In all but the shear end plate, the connecting elements are welded to the HSS column and bolted to the web of the wide-flange beam, with the exception of the seat angle where the beam flange bears on the outstanding leg. For the shear end plate, the plate is welded to the beam web and bolted to the HSS column using blind expansion bolts or a flow-drill process that produces a tapped hole which replaces a nut in blind connections.

There are two categories of weld positions on the HSS for the connections shown in Figure 2. The shear tab, through-plate and single angle with vertical fillet welds have welds at the center of the

**Table 4. Relative Connection Costs**

Type	Cost
Single Angle, L-shaped Welds	1.00
Shear Tab	1.05
Single Angle, Vertical Welds	1.17
Seat Angle	1.36
Double Angles	1.50
Tee, Vertical Welds	1.62
End Plate	2.15
Through-Plate	2.25
Tee, Flare Bevel Welds	2.42

HSS face, while the others have welds near the edges. Center welds will tend to distort the wall of the HSS more than edge welds, except for the through-plate which provides stiffening of the wall.

The connections are classified as simple, meaning that they produce negligible end moment in the beam. Rotational flexibility is provided by distortion of the connecting elements, particularly the column legs of angles or flanges of tees. Most of the connections are standard shear connections described for use with wide-flange columns in the *AISC Manual of Steel Construction*. Two exceptions are the through-plate, which is unique to hollow members, and the single angle with vertical fillet welds. When a single angle is welded to the flange of a wide-flange column, a vertical weld at the heel would be in line with the web and rotational flexibility would be lost. Therefore, the standard welding pattern is an L-shaped weld with a vertical segment at the toe and a horizontal segment across the bottom. This permits distortion of the column leg of the angle so that the connection can be classified as simple. With an HSS column, however, flexibility is provided by the HSS wall in a manner similar to the shear tab. Therefore, a single angle connection with two vertical welds is considered.

The shear tab is a special connection, even with wide flange columns, due to restricted rotational flexibility. Distortion must come from local yielding of the tab combined with slippage and bearing distortion of the bolts in their holes. Additional flexibility is provided when the tab is used with an HSS column, but some designers fear excessive distortion of the HSS wall. Hence through-plates are sometimes specified to reinforce the wall.

#### RELATIVE CONNECTION COSTS

In order to put the discussion in a good perspective, information on the relative costs of the connections is desirable. Since a number of connection types were being studied and tested at the same time, an excellent opportunity was presented to determine relative costs. Relative costs for 3 bolt connections are listed in Table 4 based on the least expensive (single angle with L shaped fillet weld) being given a value of unity. The costs are for the



**Table 5. Limit States for the Connections**

Connection Type	A	B	C	D&E	F	G	H	I
<b>Bolts</b>								
Shear w/no eccentricity			x		x	x		x
Shear by ultimate anal.	x	x		x				
<b>Connector Material</b>								
Bolt bearing ( $L_{bc} \geq 1.5d$ )	x	x	x	x	x	x		x
Gross shear at yield	x	x	x	x	x	x	x	x
Net sect. shear fracture	x	x	x	x	x	x		
Flexural yield				x			x	
Flexural rupture				x				
Block shear	x	x	x	x	x	x		
<b>Welds</b>								
Shear w/no eccentricity				x				x
Shear by vector anal.			x				x	
Shear by ultimate anal.	x	x			x	x		
<b>Tube Wall</b>								
Shear at weld	x	x	x	x	x	x	x	
Bolt bearing								x
Punching shear	x					x		
A — shear tabs B — through-plates C — double angles D — tee w/ vertical fillet welds E — tee with flare bevel welds F — single angle welded at toe & bottom G — single angle welded at toe & heel H — unstiffened seat I — shear end plate								

connecting material and the labor to fabricate the connection, including welding to the HSS or to the beam web in the case of the end plate. The cost of the end plate is somewhat uncertain since blind bolting or flow-drilling the holes are not routine operations at this time. The costs do not reflect shop preparation of the beam or field erection.

The high cost of the Tee with the flare bevel weld is due to labor and consumable electrodes required for the multipass welding. Vertical fillet welds on the Tee are much more economical. For a simple shear connection, there is no behavioral advantage for the flare bevel welds. In a moment connection where horizontal tees are used between beam flanges and the column, flare bevel welds provide a good transfer of the tension and compression forces into the side walls of the HSS and, therefore, may be warranted.

It may also be noted in Table 4 that the through-plate connection is more than twice as expensive as the shear tab. This is due to the labor involved in laying out and slotting the HSS to insert the plate. In addition, there are interference problems if connections for perpendicular beams are required. Consequently, considerable research has been conducted to justify the use of economical shear tabs.

**CONNECTION LIMIT STATES**

Connection limit states were studied in a series of test programs involving 24 tests of simple con-

nection to HSS columns. The connection strength is governed by limit states associated with the bolts to the beam web, connector material, welds and the HSS. Possible limit states are listed in Table 5 with an indication of which apply for various types of connection according to the AISC Manual. After applying the appropriate resistance factor, the lowest value governs the strength of the connection, or the criteria can be used to establish a size limit so that a particular limit state will not control. The eccentricities are the result of the small distance between the bolts and welds and do not imply that a significant end moment exists in the beam. Since the criteria for various connections were developed from different research programs that may have been separated by several years or decades, there are inconsistencies in the present state-of-the-art. For example, weld eccentricities are evaluated by elastic vector analysis in some cases and by an inelastic ultimate analysis in others.

Connection design for HSS columns is somewhat simplified since it is unlikely that beams would be coped at the top flange. Therefore, the bolt edge distance limits in the connecting material can be met and no bearing reductions are required for less than minimum edge distance.

Table 5 indicates three limit states associated with the HSS column. Bolt bearing applies only for the shear end plate which requires bolting to the HSS. When the connector is welded to the HSS, shear in the wall adjacent to the weld may control the capacity of the weldment. One way to consider this is to determine the maximum throat dimension of the weld for which the weld material will govern.

$$(throat)_{max} = \frac{\phi 0.6 F_u(HSS)}{\phi_w 0.6 F_u(WELD)} t_{HSS} \tag{5}$$

where  $F_u$  is the ultimate strength of the material

For fillet welds where the throat is 0.707 of the weld size and the two resistance factors are the same according to the AISC Specification, the maximum effective weld size is

$$a_{eff} = \frac{\sqrt{2} F_u(HSS)}{F_u(WELD)} t_{HSS} \tag{6}$$

When the actual weld size is less than  $a_{eff}$  the weld dictates the capacity while for larger welds, the effective weld size controls.

The other limit state associated with the HSS in Table 5 is punching shear. This is a tearing through the thickness of the HSS wall adjacent to the weld. This can occur in shear tab and single angle connections with vertical welds where tension in the material resulting from eccentricity pulls directly at the upper part of the weld. It can be prevented by a simple criteria that keeps the



maximum pull as determined by the yield strength in a unit length of the connector material being less than the shear fracture capacity through the two sections of the HSS wall on either side of the weld or pair of welds.

$$F_{y(tab)}t_{tab} < 2(0.6F_{u(HSS)})t_{HSS} \quad (7)$$

$$t_{tab} < 1.2 \frac{F_{u(HSS)}t_{HSS}}{F_{y(tab)}} \quad (8)$$

or

Punching shear will not occur in through-plate connections where the HSS wall is reinforced or in other connections where the pull is transferred to a perpendicular element of the connector, such as the column leg of an angle or flange of a Tee.

One limit state for the HSS that is not shown in Table 5 is that associated with a yield line mechanism. In all the tests that were conducted with the beam simply supported at both ends, there was never enough distortion of the face of the HSS to develop a yield line mechanism. Therefore, the limit states associated with the HSS can be prevented from controlling by determining a maximum effective weld size and by limiting the thickness of the projecting connection material when it is directly welded to the HSS wall.

The experimental strengths generally match or exceed the strengths predicted by the limit states criteria. Distortion due to gross yielding was usually observed at loads less than the corresponding limit state, but this did not represent a loss of load capacity in the connection. Actual failure modes do not always match the theoretical critical limit state. However, the designs were well balanced so that several limit states have nearly the same capacity, making it uncertain to clearly discern the failure mode in the tests. The conclusion is that the AISC tables for connection strength can be conservatively used for HSS columns provided that the weld does not exceed the effective weld size determined from the HSS thickness and that the punching shear criteria is applied for shear tabs.

The economically attractive shear tab connection was tested to a greater extent than the others. It was determined that the shear eccentricities were generally between the weld and bolt line and less than those used in the AISC tables, except for combinations of HSS with very low width/thickness ratios and flexible beams. However, in the latter cases the experimental eccentricities reasonably matched those used in the AISC Manual. Since a smaller eccentricity leads to greater capacity in the bolts and welds, it is conservative to use the AISC Tables for shear tabs.

#### HSS WALL DISTORTION AND COLUMN STRENGTH

In order to determine the effect of the connection

Table 6. Transverse Strain in HSS at 50 kips Shear ( $\mu\text{in/in}$ )

Type	3 Bolt	5 Bolt
Tab	-2100 to -3900	-900 & -1200
Single Angle, Vert. Welds	-2100	-1050
Single Angle, L Weld	-1380	-450
Tee, Vert. Welds	-750 to -1100	-380
Tee, Flare Welds	-1100	20
Double Angle	-975	-600
End Plate		-300
Seat		40 & 60
Through-Plate	55 to 700	

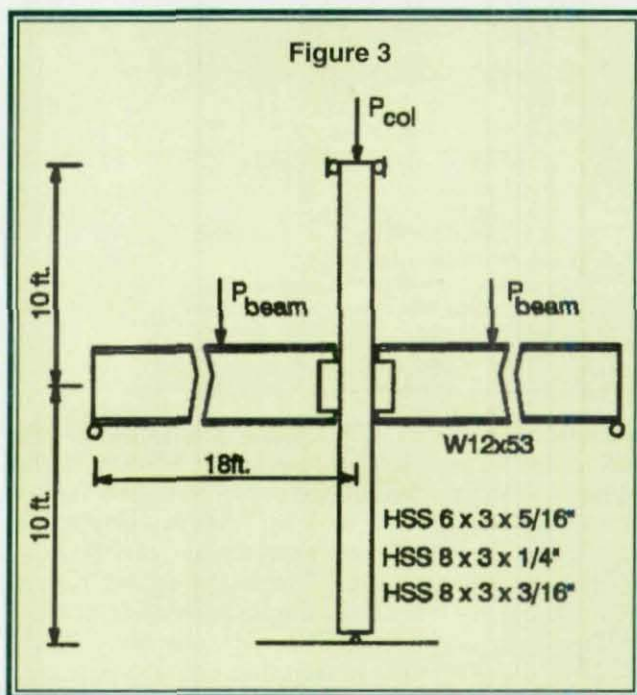

types on local distortion of the HSS columns in the 24 connection tests, strain gages were mounted at the center of the wall one inch below the connecting element. The transverse strains measured or extrapolated at a common 50 kips shear that are shown in Table 6 form the basis for comparison. Positive transverse strains in Table 6 result from Poisson's ratio and indicate no wall distortion.

Connections such as tabs and single angles that have load transfer through a weld at the center of the HSS have the highest transverse strains. These will typically exceed yield even at service loads. An exception to this is the through-plate that inherently reinforces the center of the wall and the transverse strains are negligible. Connections with welds near the sides of the HSS have significantly less transverse strain at the center of the wall. The end plate and seat angle connections produce little transverse strain. Longer connections with five bolts produce less transverse



**Table 7. Column Strengths  
for Tabs vs. Through-Plate Tests**

b/t	Connection	$P_{ult} / P_y$	
		Two Sides	One Side
15	Through-Plate, Tight	0.53	
	Shear Tab, Tight	0.51	
	Through-Plate, Snug	0.50	
	Shear Tab, Snug	0.49	
29	Through-Plate	0.63	0.42
	Shear Tab	0.61	0.46
40	Through-Plate	0.58	0.42
	Shear Tab	0.45	0.42

strain than 3 bolt connections and HSS with thinner walls or higher  $b/t$  tend to have larger strains.

In order to address the question of whether local distortion of the HSS has a detrimental effect on the column capacity, a series of tests were conducted to compare the influence of shear tab and through-plate connections. These types of connections represent the extremes of inducing transverse strain into the HSS wall. A previous paper presented test results leading to a conclusion that there was no significant column strength reduction between shear tab connections and through-plate connections. However, this conclusion was based on only four tests using HSS with a  $b/t$  ratio of 16. More recently similar column tests were conducted using HSS with  $b/t$  ratios of 29 and 40. This study with eight tests included symmetric connections on both sides of the HSS and unsymmetric connections on just one side. Both snug and tight bolts were included in the original four tests, but only snug tightened bolts were used in the eight later tests.

The test setup for all the column tests is shown in Figure 3. In these tests, the beams were loaded to about 70% of the connection capacity and then a load was applied to the top of the column until a column buckling failure occurred in the lower portion.

Table 7 presents the column strengths as ratios of the maximum experimental load divided by the yield load given by area times the static yield strength from a tension coupon taken from the wall of the HSS.

The tests with connection on two sides failed with sudden buckles while the unsymmetric tests failed gradually in bending.

The conclusion from Table 7 is that shear tab connections used with HSS columns that are not thin-walled will develop essentially the same column strength as those where the wall is reinforced with a through-plate. With thin-walled HSS, shear tabs may have a detrimental effect on the axial column capacity. For connections on only one side of the HSS column, there is no strength reduction for using shear tabs. It is safe to assume that these conclusion hold for other types of simple connec-

tions that have smaller transverse strains.

## SUMMARY AND CONCLUSIONS

There are a few characteristics of square and rectangular HSS that cause some member design consideration to differ from those of open profile sections. First it must be recognized that only cold-formed welded HSS are readily available in the U.S. These sections have good structural properties, although the thicknesses will usually be less than the nominal value. It should be recognized that many of the sections are thin-walled and require appropriate design criteria for columns and beams that reflect local buckling. Design criteria must also prevent local buckling when the HSS are used as braces in seismic applications. Except in unusual situation or when plastic analysis is used, HSS beams do not require lateral bracing.

The connection test programs have shown that the variety of simple framing connections typically used in steel construction can confidently be used with HSS columns that are not classified as thin-walled. The tabulated connections capacities and criteria for evaluating connections that appear in the AISC Manual can be applied when HSS columns are used. The only additional limit states that must be considered are a simple thickness criteria for punching shear of the HSS wall when shear tab connections are used and a limit on maximum effective weld size based on the HSS thickness.

Connections that involve welding at the center of an unreinforced HSS wall will produce local strains that exceed yield. However, the resulting wall distortions are barely noticeable and not nearly as great as the distortions of the connecting elements. The local distortion in the HSS wall has negligible influence on the column capacity as long as the HSS is not classified as thin-walled. This applies to connections on one side of the HSS or symmetric on both sides. Careful consideration should be given to the type of connection specified in a design, since the connection cost can vary by a factor of 2½.

*Donald R. Sherman, P.E., Ph.D., is a professor of civil engineering at the University of Wisconsin-Milwaukee. The connection and column tests programs were supported by the Steel Tube Institute of North America and additional funds for the shear tab investigations were provided by the Society of Iron & Steel Fabricators of Wisconsin and AISC. The HSS material was provided by the Welded Tube Company of America. Special thanks is due to Dave Mathews of Ace Iron & Steel Company of Milwaukee who fabricated the connection material and provided the cost estimates for fabrication. The work was conducted over several years by four graduate students; Steve Herlasche, Joe Ales, Chris Haslam and Homyan Boloorchhi.*





# BACK TO THE FUTURE



ASTM A513 TYPES I & II  
 MECHANICAL TUBING • ASTM  
 A500 GRADES A, B AND C  
 STRUCTURAL TUBING • HI-Y 50  
 STRUCTURAL PIPE • HSLA  
 STRUCTURAL TUBING • ROPS  
 • RACK TUBING • OCTG  
 CASING (UNTESTED) • SIZES:  
 SQUARES AND EQUIVALENT  
 RECTANGLES: 1/2" X 1/2" TO  
 10" X 10"; ROUNDS: 3/8" TO  
 12 3/4" • WALL THICKNESSES:  
 .018" (26 ga.) TO .500" (1/2").

## The Tradition of Excellence Continues...

The Tube People of UNR-Leavitt are now the Tube People of Leavitt Tube. We are returning to our original name and service mark—a name which commemorates nearly half a century of experience in manufacturing tubing products.

Although the name has changed, the people, company and manufacturing excellence you have come to know and rely upon has not. As always, our experience is the "trademark" behind our name.

**Leavitt Tube Company, Inc.**



Manufacturers of  
 Electric Welded Steel Tubing

LEAVITT TUBE CO., INC.  
 1717 W. 115th. ST., CHICAGO, IL 60643  
 PHONE: 312-239-7700 OR  
 1-800-L-E-A-V-I-T-T  
 FAX: 312-239-1023  
 FAX: 312-239-8289

**Our people make  
 the difference**



LEAVITT TUBE  
 CHICAGO, ILLINOIS

LEAVITT TUBE  
 BLUE ISLAND, ILLINOIS

LEAVITT TUBE  
 HAMMOND, INDIANA

LEAVITT TUBE  
 MADISON, MISSISSIPPI

Please circle # 24



**FALL PREVENTION**

The 9450 Beamwalker System is a temporary, polyester rope horizontal lifeline system. It is easily installed with a wrench, either at waist height or directly overhead. Horizontal installations



have a maximum length between anchorage points of 60' for use by one person and of 20' for use by two people at a time. The system can be installed between vertical columns or used with other Sellstrom/RTC horizontal lifeline post systems. The system sets up in minutes, provides worker continuous protection and is extremely light weight.

For more information, contact: Sellstrom Manufacturing Co., One Sellstrom Dr., Palatine, IL 60067 (ph: 800/323-7402; fax: 847/358-2000; home page: <http://www.fallprotection.com>) or circle number: 124

**FALL PROTECTION HANDBOOK**

A new guide from SINCO focuses on the wide range of safety nets and perimeter systems available from this manufacturer. Included are safety products for both buildings and bridges. The company also produces safety belts and life-

lines.

For a free copy of this publication, contact: The SINCO Group, 701 Middle St., Middletown, CT 06457-2527 (ph: 860/632-1509; fax: 860/632-1509). or circle number: 127

**SAFETY PRODUCTS**

The design of the Horizon Lifeline System liberates users from disconnecting their safety lanyards when passing through

intermediate supports, thereby increasing worker safety while enhancing mobility. With an advanced shock absorber, the system can accommodate up to five persons on a 40' span. By reducing the dynamic force caused by accidental falls by more than half, it helps to protect against both injury to the user and damage to a structure at its anchorage points. The lifeline's strength is bolstered by its rugged, 3/8" wire rope construction.

Another new products from Rose

**Changing the way you  
"put your life on the line"**

**Iron Wing™**

The Iron Wing Portable Horizontal Lifeline by DBI/SALA is the premiere fall protection system for iron workers on the market today. It features durable all metal components, in-line shock absorbers at each end, 3-point claw contact with beam, pass thru intermediate brackets, easy installation and more.

DBI/SALA offers a complete line of fall protection equipment including: Full Body Harnesses, Self Retracting Lifelines, Positioning Lanyards, Shock Absorbing Lanyards, and Vertical & Horizontal Safety Systems.

**Genuine Fall Protection On High Steel**  
**DBI/SALA®**

*The World Leader In Fall Arrest, Restraint & Rescue Equipment*

D B Industries, Inc. • 3965 Pepin Avenue • Red Wing, MN 55066-1837  
Toll Free: 1-800-328-6146 • Phone: 612-388-8282 • Fax: 612-388-5065

Please circle # 29



**NEW!**

- Building spans up to 24' and heights to 12'
- Pre-insulated or non-insulated

DESIGN INPUT

**FAST!**

**DON'T WASTE DESIGN TIME, USE...**

Pre-engineered SMALL **SPAN** industrial metal buildings with simple "structured panel."

### Kelly Klosure Systems

Easy-to-Assemble, Versatile, Self-Framing Panel Systems for over 25 years!

**800-228-7230**

FREMONT, NEBRASKA  
FAX: 402-727-1363

e-mail: sales@kellyklosure.com  
web: http://www.kellyklosure.com



MFG. BY KELLY INDUSTRIES, INC.

- Professional industrial exterior
- Clean-looking functional interior
- Quick response to design and cost questions
- Engineered to meet BOCA, Standard and UBC codes; ASCE-7 stds.
- Simple foundations requirements

Please circle # 88

We now offer the largest capabilities for rolling structural steel in the Western Hemisphere.



### RICH-CON

The hemisphere's largest shape roll - now on line and fully operational at Richard's & Conover Steel - has capacity up to 40" wide-flange beams and other shapes including large diameter pipe and structural tube. Call, write, fax or e-mail to Bob Evans for complete information.



Since 1857

Wats: 1-800-727-0987  
Fax: 1-816-483-6983  
Email: bevans@rich-con.com

Please circle # 76

Manufacturing include the RCD Remote Connect/Disconnect System that allow workers to secure anchorage connector straps and install fall-arrest systems to qualified overhead anchorage points from ground level.

For more information, contact: Rose Manufacturing, 2250 S. Tejon St., Englewood, CO 80110-1041 (ph: 800/722-1231) or circle number: **126**

### OCCUPATIONAL SAFETY SOFTWARE

Companies can consolidate all incident, Human Resource, safety and risk management information into one system with Occupational Safety Professional (OSP) for Windows. OSP allows companies to quickly access past and present employee data. Also, by converting statistical data into charts, the program can help to identify problem areas within a company.

For more information, contact: Parsec, P.O. Box 551665, Dallas, TX 75355-1665 (ph: 800/527-3454; fax: 214/553-0983) or circle number: **125**

### SAFETY HARNESS

The Miller DuraFlex Harness Series are constructed of a unique webbing composed of nylon, polyester and a specially formulated elastomeric material that conforms to the shape of each worker to provide better fit. The design allows the harness to stretch as the worker moves for maximum comfort without bunching, binding or cutting into the shoulders or legs.

For more information, call Miller Equipment at 800/873-5242 or circle number: **129**

### FALL PROTECTION

A wide range of fall protection equipment is available from DBI/SALA, including: full body harnesses; shock absorbing lanyards; self-retracting lifelines; rope grabs; confined space equipment; anchorage connectors and much more.

For more information, contact: DBI/SALA, 3965 Pepin Ave., Red Wing, MN 55066-1837 (ph: 612/388-8282; fax: 612/388-5065) or circle number: **114**



## Computerized Structural Steel Detailing

Experienced Staff including licensed Professional Engineers with many years of detailing experience.

32 years of service to steel fabricators and contractors.

### R.A. Gress & Associates

176 Planebrook Road, Frazier, PA 19355

Ph: (610) 644-3250 Fax (610) 889-4836

## Comprehensive Review Manuals SE and PE (Civil) License

PE (Civil) six vol. (4200 pp). Calif Structural Engr (SE) five vol. (4170 pp). C.V. Chelapati, Ph.D., Editor. Covers solution techniques with several hundred solved problems. Invaluable reference for PE/SE exams. Highly acclaimed as excellent references for practicing engineers.

Call/write for detailed brochures. PEDP, Inc., 5912 Bolsa Ave., Suite 108-MS, Huntington Beach, CA 92649

(714) 898-3658 • (714) 898-4635

## Computerized Detailing Structural, Miscellaneous, Ornamental

- 23 years of service to steel fabricators and contractors
- Very reasonable rates
- We also provide calculations by licensed professional engineers
- Excellent results

### E/Z Steel Detailing Inc.

Ph: (708) 957-5879

Fax: (708) 922-0438

## Help Wanted — QUALICO STEEL

Chief Engineer: Registered P.E. with strong structural steel experience. Must have good organizational and interpersonal skills.

Submit resume and salary history to:

**Qualico Steel Company, Inc.**

P.O. Box 149

Webb, AL 36376

Attn: John E. Downs

Telephone: (334) 790-3535

## Help Wanted — Fabrication Division Vice President & General Manager

Our client is an \$80 million structural steel construction and renovation company headquartered in a major metropolitan city in the midwest.

Primary responsibilities will include: 1) profit and loss responsibility; 2) operation as in-house supplier; 3) fabrication for outside customers; 4) partnering arrangements with other fabricators. The successful candidate will have approximately 15 years operations management experience in steel and iron fabrication, shop drawings, purchasing and pricing.

Our client offers a highly attractive base salary, performance bonus and car allowance. This is an excellent growth opportunity for the right candidate.

Contact: Christina Balian, Senior Consultant, Compass Group, Ltd., 401 South Woodward Ave., Suite 460, Birmingham, Michigan 48009 tel: (810) 540-9110; fax: (810) 540-2944.

Compass Group is a member of the Association of Executive Search Consultants, an international organization of over 125 quality retained search firms, and conducts searches only on a retained basis. All inquiries will be answered and all responses will be treated confidentially.

## Employment

ProCounsel searches for the right job for you, in the right geography, at the right money. Drafters, detailers, checkers, estimators, plant/project managers, erection professionals, sales. Fee paid by employer. Buzz Taylor 214-741-3014. Fax: 214-741-3019 or leave a msg: 800-545-5900. Confidential.

## Help Wanted — STEEL DETAILER/CHECKER

Columbia, SC-based metal deck manufacturer has a position available for an experienced detailer and checker. Ability to read construction drawings and to layout deck or steel structure is required. AutoCAD R12 experience a plus. Company has full benefits package including health and dental insurance, ESOP, and 401K plan. Associate degree or equivalent is required. Send resume to:

**Consolidated Systems, Inc.**

P.O. Box 1756, Columbia, SC 29202

Attn: Human Resources

Fax: 803/540-2252

## Help Wanted: Structural Steel Detailer

Qualified applicant will have knowledge of general construction practices, ability and experience with CAD, as well as excellent spatial, math and problem solving skills. An associates degree in engineering, architectural drafting or related field preferred.

We offer competitive wages, company paid family health coverage, quarterly bonuses, 401(k), 100% pre-paid college tuition and much more! Send resume and salary requirements to the attention of the Human Resources Department, E.O.E.

## Genzik Steel

40 East 64th Street, Holland MI 49423

Phone: (800) 968-2002 Fax: (616) 392-2423

## Help Wanted — Structural Steel Detailer/Checker

Structural and miscellaneous steel fabrication plant seeks an experienced steel detailer/checker to join its 14 member drafting team. If interested and qualified, send your resume to P.O. Box 1538, Russellville, AR 72801, Attn: Trish Henry

## Help Wanted — Project Manager

NY-NJ Metropolitan Area structural steel fabricator seeks Project Manager with minimum of five years experience. Must be capable of total job management including contract and change order negotiation, scheduling and customer follow-up, and be able to handle several projects. Degree in Engineering, Building Construction or Architecture preferred. Please reply to: Steelco, 601 Fritztown Road, Sinking Spring, PA 19608 Fax: 610-678-4331



### STAAD-III/Online — an idea Who's Time Has Come Use STAAD-III on a Pay-Per-Use Basis

- **Economical:** A typical 50-member analysis and design job will cost around \$5-\$6 (the rate declines as the job size increases). Optionally, you could limit the total charge amount while submitting the job.
- **Efficient:** Only the latest STAAD-III version is on the server, allowing you access to the latest features and facilities.
- **Support:** STAAD-III/Online users are entitled to unlimited technical support.

#### How STAAD-III/Online Works

STAAD-III/Online is a service that allows you to run STAAD-III on a "pay-per-use" basis using a modem connection. The package includes STAAD-III Input Generator and Post Processor software free of cost as well as all necessary utilities for remote connection. Load the STAAD Input Generator on your own computer to create the STAAD-III Input file. Using your modem, dial-in to connect to a host PC running STAAD-III software for analysis/design. After analysis is over, the results are transferred back to your PC. That's it!

For additional information, contact: Research Engineers, Inc., 22700 Savi Ranch Parkway, Yorba Linda, CA 92887-4608  
Ph: (714) 974-2500 • toll free: (888) 4-STAAD-3  
email: info@reiusa.com • Internet: http://www.reiusa.com

### AutoSD Stel Detailing and Calculator Programs

A time saving, cost-effective way to prepare shop drawings, requiring minimum training using AutoCAD Release 11 or later. Over 200 different LISP programs for quickly detailing beams, columns, braces, gusset plates, stairs, stair rails, wall rails, ramp rails, ladders, sections, roof frames, embedded items, erection and anchor bolt drawings. Configure it to your standards and keep different configurations on file. Blocks, cuts, minus dimensions, and bolts are calculated for you from a database of AISC shapes. *Calculator programs* for designing gusset plates and beam end connections and a *feet inch* calculator for solving circles and triangles. There are no maintenance fees, free telephone support. Reasonably priced yearly updates.

**AutoSD, Inc. 8203 Lizelia Rod, Meridian, MS 39305**  
Call or fax (601) 693-4729

### HEWLETT-PACKARD Computers/Peripherals

A complete line of used and refurbished HP Equipment to fill all your computer needs. Laser printers, scanners, disk drives, plotters (Draftpro, Draftmaster & Designjet), PC's and 9000 series workstations are available for immediate delivery. Call our toll free number for additional information and pricing.

**Ted Dasher & Associates**  
4117 2nd Avenue South  
Birmingham, AL 35222  
800-638-4833 fax (205) 591-1108

### Structural & Miscellaneous Steel Detailing CAD Programs

AutoCAD parametric LISP programs for preparing structural AND misc. steel shop drawings. All programs have been updated for 1997 and new programs have been added. Programs from anchor bolts to roof frames and "all steel in between." Imperial and metric versions with USA, Canadian and European steel sections. 45-DAY MONEY BACK GUARANTEE. DISCOUNTS UP TO 40%. Buy ONLY the programs you need. Used in the field for 10 years. Programs written by a detailer with 40 years experience. Extremely "flexible" programs. FREE telephone support. No maintenance fee. Reasonable yearly update fee. EXCELLANT PROGRAMS at a REASONABLE PRICE. Call for a FREE demo disk, list of programs, and pricing or download from AOL: file search: SSDCP.

**SSDCP, 110 Shady Oak Circle, Florance, MS 39073**  
tel: 601/845-2146 (fax same) • email: ssdcp@aol.com

### Rubber Tired Gantry Cranes Bought - Sold - Traded - Brokered

Currently have 9 machines available from 20 tons to 120 tons for immediate shipment. Please call or fax for details.

Machines needed, any size-age-condition for resale. That under-utilized gantry might mean cash for you today.

Large forklifts and rail-mounted gantrys also available.

#### Gantry Crane Sales

P.O. Box #430, Strathmere, NJ 08248  
609/399-2800 • fax: 609/399-3131  
email: mazzeo@boatyardequip.com

### Subscribe now to Engineering Journal

The only technical magazine in the U.S. devoted exclusively to the design of steel structures, the *AISC Engineering Journal* provides structural engineers, fabricators, and educators with the latest information on steel design, research and construction.

**For a one-year subscription, send \$32 to:**  
**American Institute of Steel Construction,**  
**P.O. Box 806276, Chicago, IL 60680-4124**  
**or phone 312/670-2400**

### AISC Professional Membership

Receive a **FREE Manual of Steel Construction** and discounts on AISC publications, seminars and the National Steel Construction Conference.

**For more information, contact:**  
**Libby Kop at 312/670-5409.**

Advertiser	Page Number	Circle No.
Nicholas J. Bouras.....	CII.....	33
Canam Steel.....	22-23.....	64
CAST.....	40.....	27
CDS.....	16.....	63
Chaparall Steel.....	35.....	43
CSI.....	CIV.....	31
Columbus Galvanizing.....	13.....	102
Computer Detailing.....	30.....	
Daito.....	38.....	113
DBI/Sala.....	47.....	114
Design Data.....	7.....	32
EJE Industries.....	26.....	46
Elcometer.....	26.....	115
Fabtrol.....	30.....	94
Formation Design Systems.....	32.....	92
Integrated Engineering Software.....	39.....	87
Kelly Klosure.....	48.....	88
Leavitt Tube.....	46.....	
Marks Brothers, Inc.....	19.....	21
MDX Software.....	20.....	47
NSCC.....	11.....	5
Omnitech.....	19.....	52
Optimate.....	21.....	53
Quality Certification.....	16.....	
Ram Analysis.....	8 & 40.....	81
Research Engineers.....	5.....	34
Richards & Connover.....	48.....	76
Risa Technology.....	CIII.....	40
Steel Joist Institute.....	24.....	54
TradeARBED.....	3.....	37
Valmont Tulsa.....	12.....	61
Max Weiss.....	20.....	56
Whitefab.....	41.....	55



# RISA-3D

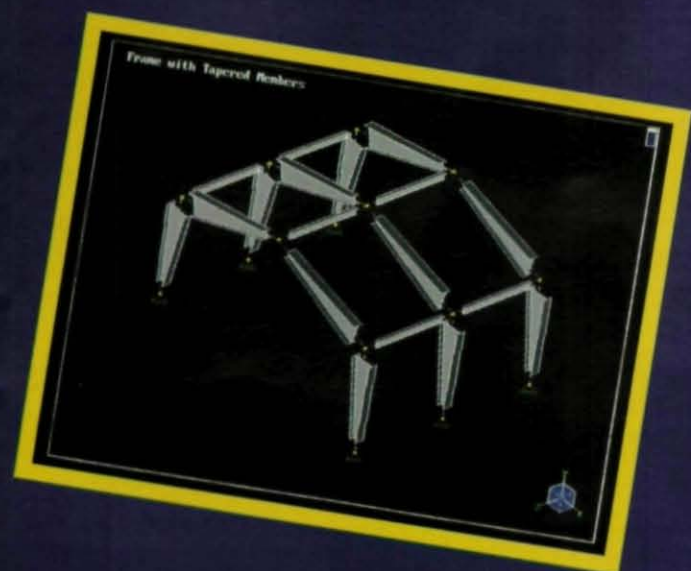

**R**ISA-3D represents a new philosophy in structural engineering software. This is a comprehensive, general purpose program that has been written from the ground up specifically for the personal computer (this is not a recycled mainframe program). RISA-3D's unique design enables you to get up and running very quickly, which makes you more productive in less time. You can concentrate on getting your projects done on schedule rather than spending valuable hours trying to figure out yet another new software product.

Even though we make "ease of use" our primary goal as we improve and enhance RISA-3D, solution accuracy is never sacrificed in the process. The results calculated by RISA-3D are meticulously verified via an extensive matrix of test problems; these problems validate every aspect of RISA-3D's calculations. We also take great pride in the quality of our documentation and technical support. Should you ever have questions about RISA-3D, our staff of professional engineers is always ready to help.

The advanced features offered by RISA-3D are benefiting structural engineering professionals all over the world. Try RISA-3D and see for yourself just how good structural engineering software can be!

Visit our web site at  
[www.risatech.com](http://www.risatech.com)

Please circle # 40

For more information and a **FREE** demo disk, call us at  
**1-800-332-RISA**

26212 Dimension Dr. Suite 200  
 Lake Forest, CA 92630  
 Voice: 800-332-7472 • Fax: 714-951-5848

**RISA**  
 TECHNOLOGIES