

# NSBA 2014 Prize Bridge AWARDS

**FIFTEEN BRIDGES HAVE EARNED** national recognition in the 2014 Prize Bridge Awards Competition. Conducted by the National Steel Bridge Alliance (NSBA), the program honors outstanding and innovative steel bridges constructed in the U.S.

The awards are presented in several categories: major span, long span, medium span, short span, movable span, reconstructed, special purpose, accelerated bridge construction and sustainability. This year's winners range from a reconstructed bridge that had been partially destroyed by a barge to a massive delta frame spanning the Shenandoah River.

Winning bridge projects were selected based on innovation, aesthetics and design and engineering solutions, by a jury of five bridge professionals:

- Benjamin Beerman, Senior Structural Engineer, Federal Highway Administration/Resource Center, Atlanta
- Thomas R. Cooper, P.E., P.Eng., Lead Structural Engineer, Parsons Brinckeroff, Denver
- Robert Healy, Director of Structures, RK&K, Baltimore
- Thomas P. Macioce, P.E., Division Chief of the Bridge Design and Technology Division, Pennsylvania Department of Transportation, Harrisburg, Pa.
- Bert Parker, Senior Vice President/Chief Administrative Officer, Garver, Little Rock, Ark.

This year's competition attracted more than 30 entries and included a variety of bridge structure types and construction methods. All structures were required to have opened to traffic between May 1, 2011 and September 30, 2013.

The competition originated in 1928, with the Sixth Street Bridge in Pittsburgh taking first place, and over the years more than 300 bridges have won in a variety of categories. Between 1928 and 1977, the Prize Bridge Competition was held annually, and since then has been held every other year, with the winners being announced at NSBA's World Steel Bridge Symposium.

## 2014 PRIZE BRIDGE AWARD WINNERS

### Prize Bridge Award winners

- Major Span: Shenandoah River Bridge Delta Frame, Jefferson County, W.Va.
- Medium Span: Dixie Highway Flyover, Boca Raton and Deerfield Beach, Fla.
- Moveable Span: Willis Avenue Bridge, New York
- Reconstructed: Huey P. Long Bridge, New Orleans
- Special Purpose: Phyllis J. Tilley Memorial Pedestrian Bridge, Fort Worth, Texas

### Merit Award winners

- Major Span: Sakonnet River Bridge, Tiverton and Portsmouth, R.I.
- Long Span: Iowa Falls Bridge, Iowa Falls, Iowa
- Medium Span: North Halsted Street Tied Arch Bridge, Chicago
- Medium Span: Ramp TE over I-95, New York
- Short Span: River Road Over Ironstone Brook, Uxbridge, Mass.
- Short Span: Dodge Creek Bridge, Elkton-Sutherlin Highway (OR138), Ore.
- Reconstructed: Eggner's Ferry Bridge Emergency Replacement, Trigg and Marshall Counties, Ky.
- Special Purpose: Christina and John Markey Memorial Pedestrian Bridge, Revere, Mass.

### Accelerated Bridge Construction Commendations

- Willis Avenue Bridge, New York
- River Road Over Ironstone Brook, Uxbridge, Mass.
- 130th Street and Torrence Avenue Railroad Truss Bridge, Chicago
- Eggner's Ferry Bridge Emergency Replacement, Trigg and Marshall Counties, Ky.

### Sustainability Commendations

- Dodge Creek Bridge, Elkton-Sutherlin Highway (OR138), Ore.
- Huey P. Long Bridge, New Orleans
- Keene Road Bridge, Richland, Wash.

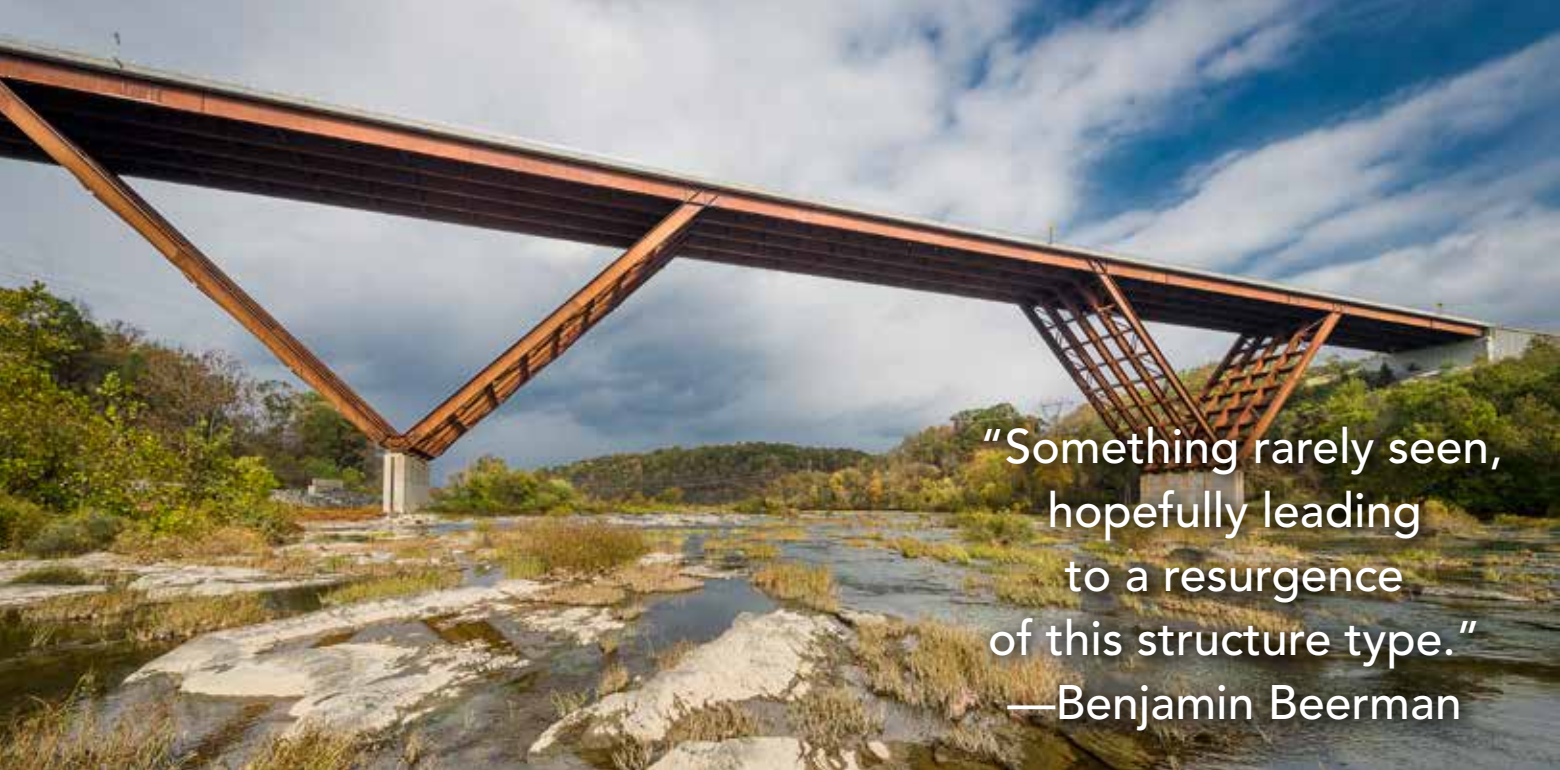

“Something rarely seen,  
hopefully leading  
to a resurgence  
of this structure type.”  
—Benjamin Beerman



PRIZE BRIDGE AWARD—

Major Span Category

**SHENANDOAH RIVER BRIDGE DELTA  
FRAME, JEFFERSON COUNTY, W.VA.**

The opening verse to John Denver’s “Take Me Home, Country Roads” hints at the natural beauty of the Shenandoah River Valley in West Virginia’s eastern panhandle.

To accommodate increasing travel demands to the area, which is about an hour from Washington, D.C., the West Virginia Division of Highways initiated a project to improve West Virginia Highway 9, including a new bridge across the Shenandoah River. HDR developed a delta frame design that delivered significant savings compared to proposals for more traditional designs. The resulting signature shape of the Shenandoah River Bridge is as pleasing to the bottom line as it is to the eye.

The triangular shape of the delta frame, one of the most basic structural forms, yields a sense of stability and strength, of simplicity and functionality. The earth-tone reddish-brown color of the weathering steel blends with the natural colors of the valley and is bounded and complemented by the natural concrete color of the deck and barriers, as well as the piers and abutments.

HDR and Trumbull performed preliminary design on both concrete and steel options, but the anticipated construction

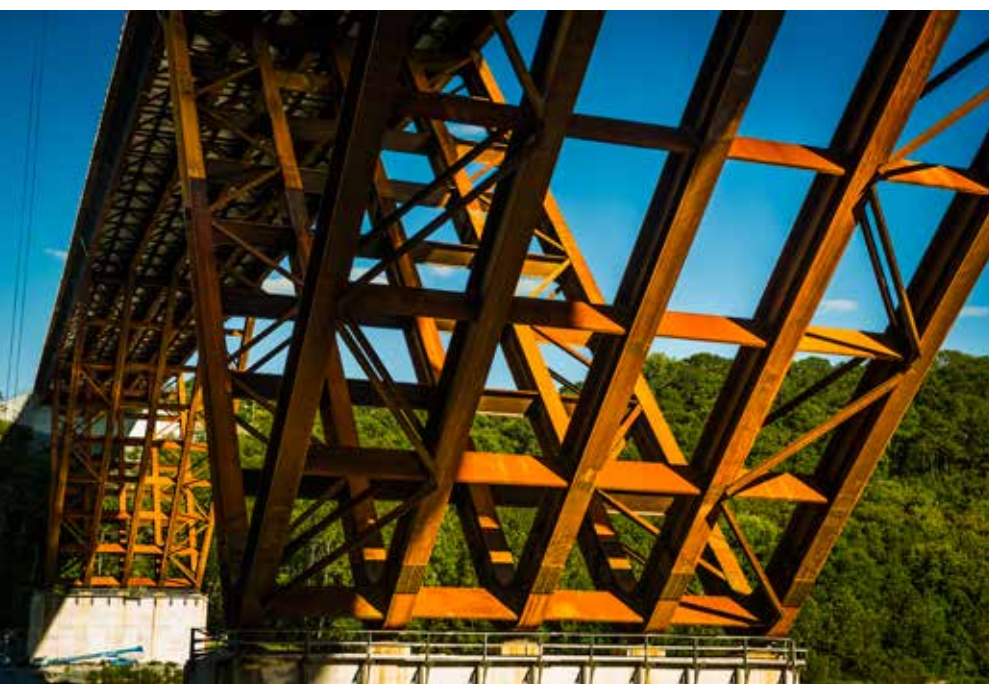



costs for concrete were much greater than for steel. There was enough of a difference that it became obvious that steel would be more economical, so the preliminary design of the concrete alternative was set aside.

The Shenandoah River Bridge would be one of the longest delta frames ever constructed, with 300-ft spans between legs and 600 ft between main piers. Although the bridge type is no longer common, its ability to support long spans at a significant height with few piers made it an ideal fit for traversing the Shenandoah.

The unique shape of the new delta-frame Shenandoah River Bridge strikes a pose worthy of its picturesque West Virginia surroundings, and delivered significant savings compared to proposals for more traditional designs. Trumbull's bid of \$40 million for the bridge meant that the West Virginia Division of Highways would save \$8 million, thanks to this creative design solution; the next lowest bid came in at \$48 million.

The new bridge is a much easier structure type to inspect and maintain than some of the other viable bridge types (including the originally proposed truss), especially since it

was constructed of uncoated weathering steel. This material eliminates the need for costly future painting, which also could have had a negative impact on the environment. As part of the design, a future-staged re-decking scheme was presented in the plans and analyzed to ensure its viability. A potential future deck replacement would not force a temporary closure of the bridge, which would have a negative impact on the public.

You can read more about this project in "Decision: Delta" (12/2013).

**Owner**

West Virginia Department of Transportation, Division of Highways, Charleston, W.Va.

**Engineer**

HDR Engineering, Inc., Weirton, W.Va.

**General Contractor**

Trumbull Corporation, Pittsburgh

**Steel Detailer**

Tensor Engineering, Indian Harbour Beach, Fla.  
(AISC Member/NSBA Member)



“Painted steel box girders provided a clean and efficient solution to a curved alignment traversing the street-level intersections below.” —Tom Cooper

PRIZE BRIDGE AWARD—Medium Span Category

**DIXIE HIGHWAY FLYOVER, BOCA RATON AND DEERFIELD BEACH, FLA.**

The Dixie Highway is done doubling up. The last remaining two-lane stretch, in northern Broward and Palm Beach Counties (Fla.), has been expanded to four lanes in the form of a flyover that crosses the Florida East Coast (FEC) Railroad, several local streets and the Hillsboro Canal, a waterway that separates the cities of Boca Raton and Deerfield Beach.

Two separate structures were constructed using a total of 3,250 tons of structural steel. The main bridge is a 1,390-ft, eight-span, S-curved, steel box girder bridge with a super-elevation transition. The steel tubs are 6 ft and 7 ft deep for ease of maintenance and sit 16 ft to 30 ft above grade. The second bridge is a single-span, 218-ft single steel box pedestrian bridge connecting Pioneer Park in Deerfield Beach to Boca Raton over the canal.

Design challenges included integral pier cap girders at each column and the large number of vertical and horizontal clearances and transitions between the main bridge and ramps. Waterway width was also a challenge; while Hillsboro Canal is technically a navigable waterway, it is not wide enough to accommodate construction barges. The long box tub girder

spans were lifted into place by two 250-ton crawler cranes working in tandem. It was the first time a 192.5-ton steel cap, the single largest component, was ever lifted over and permanently set above the FEC Railroad, which continued to operate freight trains through the construction site every half-hour on weekdays. As construction activities needed to be coordinated with the railroad's train schedule, most heavy lifts took place on weekends and overnight hours.

With only seven months allotted for design and release to construction, the fast-track design-build project finished 95 days ahead of schedule and \$7.5 million under budget. The bridge officially opened in July 2012 and was funded through a \$40 million American Recovery and Reinvestment Act grant. The completed project, including associated roadway, drainage, signalization and drainage improvements, eliminates an existing at-grade crossing of the FEC Railroad, reduces travel times for local businesses and residents and provides a more efficient hurricane evacuation route for the area. Now, all motorists, pedestrians, and bicyclists can travel safely and efficiently between Boca Raton and Deerfield Beach.



**Owner**

Florida Department of Transportation, District Four, Fort Lauderdale, Fla.

**Engineer**

Kimley-Horn and Associates, Inc, West Palm Beach, Fla.

**General Contractor**

Cone & Graham, Inc., West Palm Beach, Fla.

**Steel Team**

**Fabricator**

Tampa Steel Erecting Company, Tampa, Fla. (AISC Member/NSBA Member/AISC Certified Fabricator)

**Erector**

V&M Erectors, Inc., Pembroke Pines, Fla. (AISC Member/AISC Certified Erector)

**Detailer**

Tensor Engineering, Indian Harbour Beach, Fla. (AISC Member/NSBA Member)



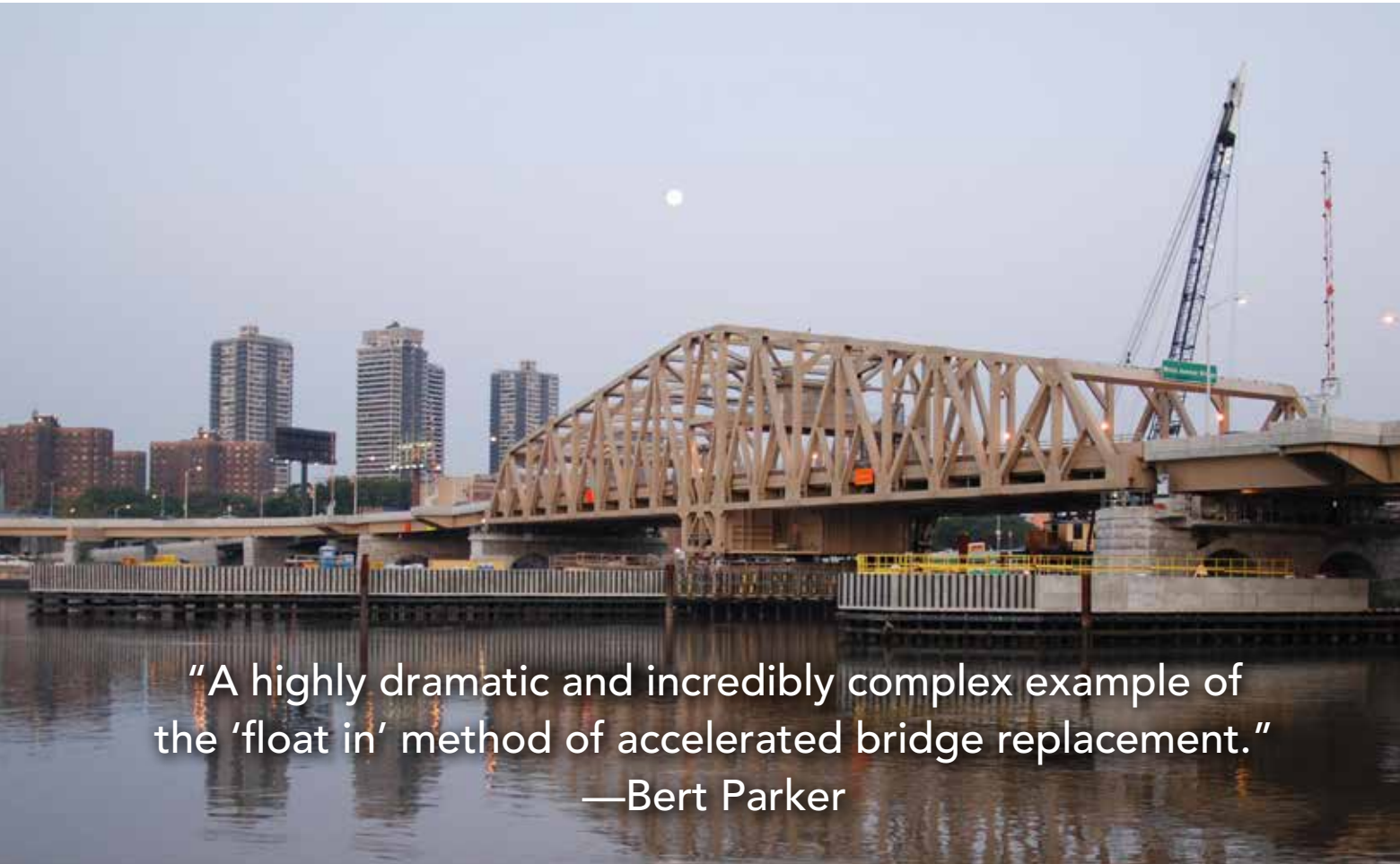

“A highly dramatic and incredibly complex example of the ‘float in’ method of accelerated bridge replacement.”  
—Bert Parker

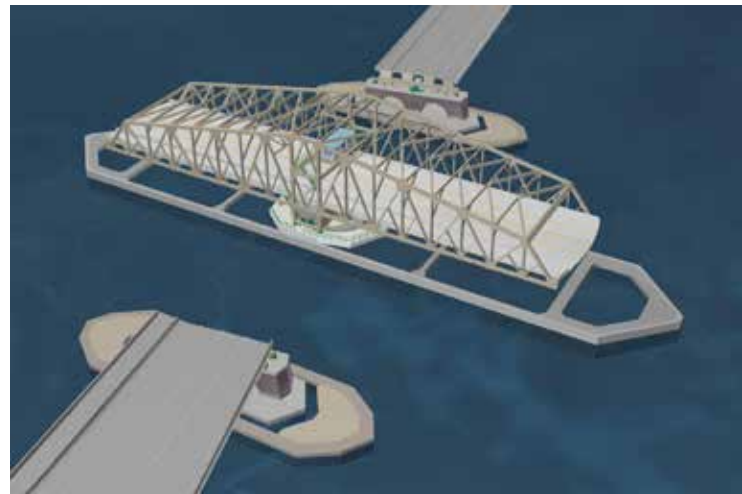

PRIZE BRIDGE AWARD—Movable Span  
ACCELERATED BRIDGE CONSTRUCTION COMMENDATION—Movable Span Category  
**WILLIS AVENUE BRIDGE, NEW YORK**

**T**he Willis Avenue Bridge brings boroughs together. The bridge is integral to connecting Manhattan and the Bronx, carrying roughly 72,000 vehicles per day via four lanes of traffic across the Harlem River. It also provides an important pedestrian and bicycle

corridor—and is on the route of the New York City Marathon.

The 25-ft vertical clearance of the 350-ft-long swing span portion allows most vessels in the river to pass below, but the span swings open periodically to permit the passage

of tall vessels. Although the swing span is the centerpiece of this bridge, this is just a short segment of the three-quarter-mile-long structure. Elevated ramp connections are provided from First Avenue at E. 125th Street and from the Northbound FDR Drive in Manhattan to Willis Avenue and to Bruckner Boulevard in the Bronx.

Due to structural deterioration and alignment issues, the bridge needed to be replaced. The new swing span is a steel through truss and the approach spans include trapezoidal box girders and straight and curved plate girders as well as transverse box girders straddling Harlem River Drive and the at-grade section of Willis Avenue below the bridge. A total of roughly 8,000 tons of structural steel were incorporated in the final project. A separate curved girder ramp, designed by a consultant for New York State DOT, provides a direct connection to the Major Deegan Expressway.

The 2,500-ton swing span portion was preassembled and floated into position on-site. This highly publicized operation included the spectacle of the bridge floating down the Hudson River roughly 160 miles from the assembly site near Albany, including a tour around the tip of Manhattan and below the city's East River bridges. Floating the swing span in allowed simplified erection on land and rapid site installation, minimizing impacts on navigation and vehicular traffic.

A 9-ft-diameter spherical roller thrust bearing supports the entire swing span while minimizing friction during span operation and providing needed seismic restraint. This is the largest application of this type in the world for a spherical

roller thrust bearing. Swing span machinery, electrical and maintenance areas were integrated with floor system framing below deck level to simplify future maintenance access and integrate the mechanical and structural components in a way that provided direct load paths from the balance wheels and center wedges to the main structural members.

The truss arrangement offers a modern design solution that is consistent with other historic swing spans on the river and provides a defined gateway to the Bronx. The clean closed box truss members are detailed to minimize future maintenance needs, while features such as architectural fences and pier treatments are used to enhance the appearance of this significant bridge.

The project produced a range of social and economic benefits including essentially eliminating traffic impact during construction, improving highway safety and operations and providing a continuous, mile-long, 12-ft-wide bikeway/walkway on the bridge that interconnects the bike routes at both ends.

**Owner**

New York City Department of Transportation, New York

**Engineer**

Hardesty & Hanover, New York

**General Contractor**

Kiewit Constructors, Inc./Weeks Marine Inc., a Joint Venture

**Steel Detailer**

Tenca Steel Detailing, Quebec, Canada (AISC Member)

“A span-by-span method of steel truss assembly and erection allowed the bridge to be widened without falsework in the river.”

—Tom Macioce



PRIZE BRIDGE AWARD & SUSTAINABILITY COMMENDATION—Reconstructed Category  
**HUEY P. LONG BRIDGE, NEW ORLEANS**

At the grand opening of the Huey P. Long Bridge Widening Project last June, Louisiana Secretary of Transportation and Development Sherri H. LeBas hailed the event as “the rebirth of a great bridge, which symbolizes the continued rebirth of this great city.”

Originally completed in 1935, the bridge was built to carry both rail and highway traffic. At 23,000 ft between railroad abutments, the main spans of the bridge included two 18-ft highway travel lanes cantilevered off of the railroad bridge.

After a study conducted determined that a new crossing was not a viable option, the Louisiana Department of Transportation and Development in 1986 began investigating widening the existing span. Modjeski and Masters, the structural firm that designed the original Huey P. Long Bridge, was also engaged to design the expansion.

The final approved design involved expanding lanes from two 9-ft lanes to three 11-ft lanes, with a 2-ft inside shoulder and an 8-ft outside shoulder. As an expansion of this magnitude was unprecedented, design teams faced

the additional challenge of executing an extensive analysis of the new main bridge superstructure, as well as the original bridge.

Construction for the massive project began in April 2006. The seven-year schedule was broken into four phases of construction, including:

- Phase I: Main Support Widening (piers) – Began April 2006, completed end of May 2009. Prime contractor: Massman Construction Co.
- Phase II: Railroad Modifications – Began October 2006, completed June 2008. Prime Contractor: Boh Bros. Construction Co.
- Phase III: Main Bridge Widening (truss) – Began early 2008 completed July 2012. Contractor: MTI, a joint venture of Massman Construction Co., Traylor Brothers, Inc. and IHI, Inc.
- Phase IV: New Approaches Construction – Began June 2008 and concluded August 2013. Contractor: KMTC, a joint venture of Kiewit, Massman Construction Co., and Traylor Brothers, Inc.





During the first phase, river piers were widened from 60 ft to 80 ft by encasing the lower portion of existing piers with concrete. The encasements supported a new steel “W” frame that was in turn used to support the widening trusses. The 53-ft-tall steel frame is 152 ft wide at the top but only 75 ft wide at its bearings. Once the steel W frame was supported, teams could widen the main river spans.

You can read more about this project in “The Long Way Home” (12/2012).

#### **Owner**

New Orleans Public Belt Road Railroad, New Orleans  
Louisiana Dept. of Transportation & Development, Baton Rouge, La.

#### **Program Managers**

Louisiana Timed Managers, Baton Rouge

#### **Engineer**

Modjeski and Masters, Inc., New Orleans

#### **General Contractor**

MTI, a joint venture of Massman Construction Co., Traylor Brothers Inc., and IHI Inc.  
Massman Construction Company

KMTC, a joint venture of Kiewit, Massman Construction Co., and Traylor Brothers, Inc.  
Boh Brothers Construction

#### **Steel Team**

##### **Fabricators**

W&W/AFCO Steel, Little Rock, Ark. (AISC Member/NSBA Member/AISC Certified Fabricator)

American Bridge Manufacturing, Reedsport, Ore. (AISC Member/NSBA Member/AISC Certified Fabricator)

Industrial Steel Construction, Gary, Ind. (AISC Member/NSBA Member/AISC Certified Fabricator)

Cosmec Inc., Athens, Texas (AISC Member/NSBA Member AISC Certified Fabricator)

##### **Steel Detailers**

Candraft Detailing Inc., New Westminster, B.C., Canada (AISC Member)

Genifab Detailing and Engineering for Fabricators, Quebec, Canada (AISC Member)

Tensor Engineering, Indian Harbour Beach, Fla. (AISC Member/NSBA Member)

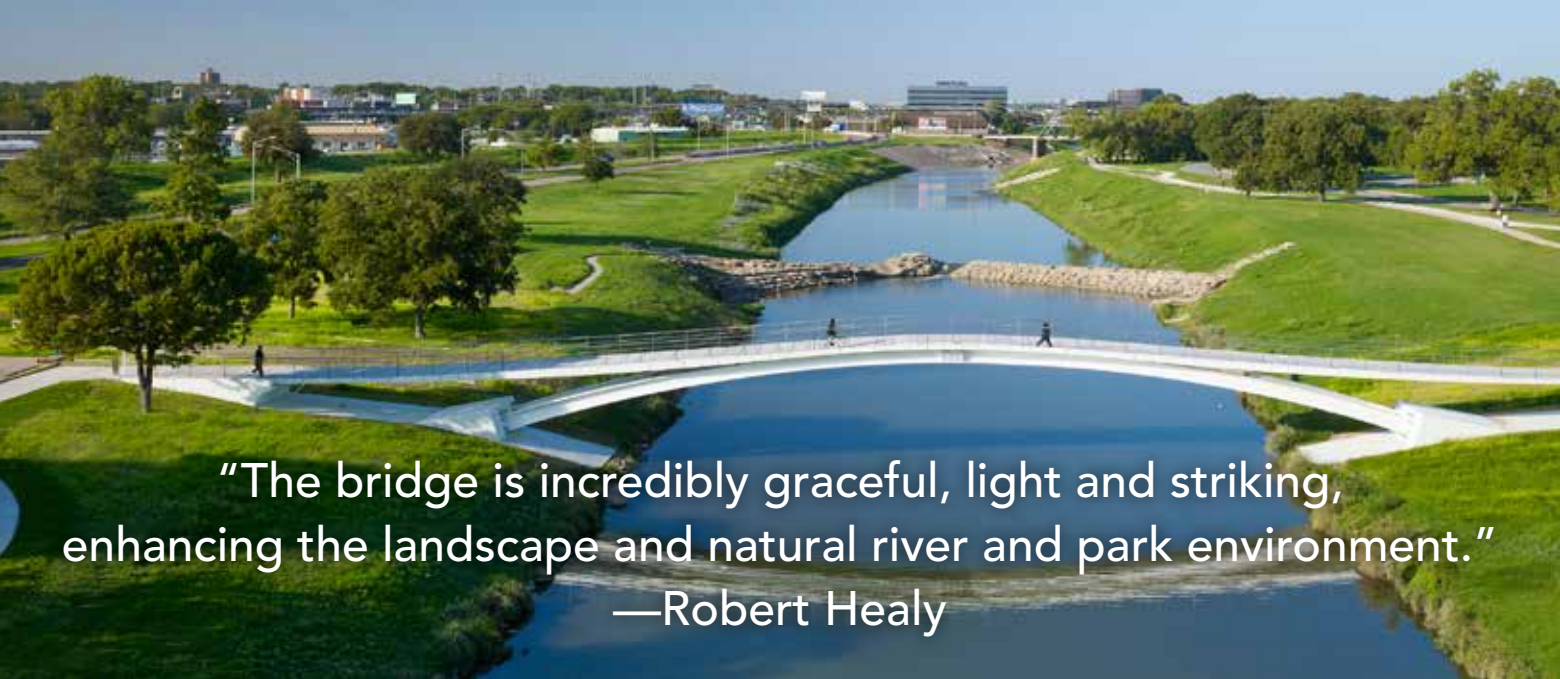

“The bridge is incredibly graceful, light and striking, enhancing the landscape and natural river and park environment.”  
—Robert Healy



PRIZE BRIDGE AWARD—Special Purpose Category

**PHYLLIS J. TILLEY MEMORIAL PEDESTRIAN BRIDGE, FORT WORTH, TEXAS**

Residents of Ft. Worth now have an elegant new path over the Trinity River. Connecting Trinity Park to a new trail that terminates in downtown Fort Worth, the new Phyllis J. Tilley Memorial Bridge has a graceful profile that enhances the serene landscape. A steel arch with a span of 163 ft supports steel stress ribbon segments and precast concrete planks over the river, complementing the adjacent historic Lancaster vehicular bridge.

The 368-ft-long, 12-ft-wide steel stressed ribbon/arch combination bridge is named for Phyllis Tilley, an advocate for use of the riverfront. Pedestrians and bicyclists crossing the bridge will experience a smooth, undulating ADA-compliant bridge surface. At night, the bridge is illuminated with a combination of white and blue LED lighting for increased safety and aesthetic appeal. The absence of vertical arch support struts reduces the horizontal loads created by periodic river flooding. The bridge's slim profile belies

the strength and versatility of the design, which enables the structure to sustain a 500-year flood event without raising flood elevations more than one inch.

One important challenge with stress ribbon bridges is achieving a deck running slope that meets ADA accessibility requirements and maximum allowable slopes. Since a stress ribbon bridge is in fact a catenary structure that derives its strength from the sag of the supporting ribbon, the deck slope must follow the sag of the ribbon, and this slope can easily exceed ADA limits. To meet this challenge, the precast concrete deck panels were designed with varying thicknesses to provide a finished deck surface with a series of short ramps and landings that meet ADA requirements.

This bridge represents a cooperative funding effort by the City of Fort Worth, federal agencies and private donations through Streams and Valleys, Inc., a local not-for-profit organization that helps to protect and enhance the Trinity River and





its adjacent trails. These groups invested a total of \$2.5 million for a bridge that has already had a significantly positive impact on the local area since its dedication in August 2012. The bridge is the first pedestrian crossing of the Clear Fork of the river in the last 20 years.

**Owner**

City of Fort Worth, Texas

**Engineer of Record**

Freese and Nichols, Inc., Fort Worth

**Structural Bridge Engineer**

Schlaich Bergermann and Partner, LP, New York

**Architect**

Rosales + Partners, Boston, Mass.

**General Contractor**

Rebcon, Inc., Dallas



MERIT AWARD—Major Span Category

## SAKONNET RIVER BRIDGE, TIVERTON AND PORTSMOUTH, R.I.

The Sakonnet River Bridge carries R.I. Highway 24 over the Sakonnet River, a tidal passage separating the Town of Portsmouth on Aquidneck Island to the west and the Town of Tiverton on the mainland to the east.

Located just to the south of where the Sakonnet River opens into Mount Hope Bay, the Sakonnet River Bridge setting is one of mixed use, comprised of established neighborhoods with 19th and early 20th century homes, pleasure boat marinas, fishing wharves and commercial real estate.

The replacement structure accommodates two 12-ft lanes in each direction, 4-ft-wide high-speed shoulders, 10-ft-wide low-speed shoulders and a 13-ft-wide bicycle/pedestrian shared-use path on the north side of the bridge; this path introduces a pedestrian and bicycle connection between the two towns that has been absent for more than half a century.

After studying bridge types for the replacement structure, it was decided that the most reasonable and prudent decision would be to design and advertise two separate structure types. These types included 1) an unpainted weathering steel trapezoidal box girder structure and 2) a twin segmental concrete trapezoidal box structure. Extensive architectural enhancements were included to “dress up” these economic structure types.

The final design has ten girder spans ranging from 100 ft to 400 ft. Several enhancements, including a boat ramp and handicap accessible fishing pier, were included in the contract. The project was advertised in October of 2008 and bidding opened the following January. The low bid was about \$165 million for the steel alternative design, which was then constructed. Due to overlapping areas with the existing bridge, the new bridge was built in phases in order to maintain traffic at all times, and

four full lanes of traffic were operational on the new structure in September of 2012.

Ultimately, this bridge is noteworthy for its cost-effective structure type, which is tastefully enhanced with architectural and lighting features. In addition, innovative pile details allowed for combined side-friction and end-bearing in difficult soils, thereby minimizing driving depths. An incentive/disincentive program helped to fast-track the construction schedule, rendering the existing bridge out-of-service as soon as possible and lifting the heavy truck restrictions of this highway route. An automated electronic vibration and displacement instrumentation and alert system was attached to the existing bridge, and several of the existing piers were pre-outfitted for emergency jacking.

### Owner

Rhode Island Department of Transportation, Providence, R.I.

### Engineer

Commonwealth Engineers & Consultants, Inc., Providence, R.I.

### General Contractor

Cardi Corporation, Warwick, R.I.

### Steel Team

#### Fabricator

Hirschfeld Industries - Bridge, Colfax, N.C. (AISC Member/NSBA Member/AISC Certified Fabricator)

#### Detailer

abs Structural Corporation, Melbourne, Fla. (AISC Member/NSBA Member)



MERIT AWARD—Long Span Category  
**IOWA FALLS BRIDGE, IOWA FALLS, IA**

The site of the Iowa Falls Bridge in Iowa Falls, Iowa, has seen a lot of action over the last century.

The recently built bridge replaced a 1928 concrete arch bridge that had undergone seven rehabilitation efforts, including major ones in 1976 and 2000. Eventually, the original structure of the concrete span was found to be structurally deficient, functionally obsolete and too costly to rehabilitate again. Although the structure was on the National Register of Historic Places, the Iowa DOT opted to demolish it and replace it with a modern steel bridge on the same alignment.

The arch rib used on this structure used a nearly square cross section rather than a rectangular configuration common with traditional arch ribs. Consequently, the web plates near the base of the arch are thicker than normal. Conventional design practices use wind bracing between the arch ribs to minimize lateral bending forces in the arch rib as a result of wind loads perpendicular to the arch rib. However, due to the width-to-span ratio, a trussed bracing system was deemed inefficient and impractical. Instead, four struts were provided between the arch ribs to allow them to share the lateral loads, which required designing the arch ribs and struts for biaxial bending plus compression.

Redundancy was designed into the hanger cables and tiebacks at the abutment. In case of damage to the hanger cables, the cables were designed to accommodate full roadway traffic with any one of the four cables in a set removed or damaged. The tiebacks at the abutments are encased in HSS and grouted to add additional protection to withstand small impacts, such as those associated with light excavation equipment that might be used if the buried utilities off the end of the bridge had to be accessed. Also, by using lightweight backfill, the abutment was designed so the failure of one tie will not result in a progressive failure of the remaining ties in the abutment.

As part of its bridge infrastructure program, the Iowa DOT focuses on investigating the use of new high-performance materials, new design concepts and construction methods, and new maintenance methods. These progressive efforts are intended to increase the life span of bridges while also making them safer and more cost-effective. By increasing the longevity of the Iowa Falls Bridge and thus minimizing traffic disruption, the public will experience fewer construction-related travel delays moving forward.



To achieve the greatest service life on the Iowa Falls Bridge, a number of corrosion-resisting systems were incorporated into the design. The structural steel is A709 Grade 50 weathering steel. Areas exposed to road-salt spray and runoff are painted with a three-coat paint system to further protect the structure. The inside of the arch rib is also prime-coated for its entire length. The sockets, pins and threaded rods connecting the hanger cables to the arch rib and interior floor beams are galvanized. The cables have a Class A zinc coating on their interior strands and a Class C zinc coating on the exterior strands for additional corrosion protection.

The Iowa DOT testing and monitoring program, developed in coordination with the Iowa State University Bridge Engineering Center, collects performance data for structures to compare against design-based structural parameters and to determine if the structural response is appropriate. Its most challenging research program has been related to developing structural health monitoring (SHM) to determine the real-time and continuous structural conditions of a bridge. For the Iowa Falls Bridge, the goal was to implement a multi-sensor continuous SHM system for general performance evaluation (structural, environmental, etc.) that can easily be adapted to other highway and interstate bridges and other monitoring needs. The system allows easy access to real-time data the Iowa DOT can react to immediately. To this end, a SHM system was developed by the BEC and placed on the bridge. Sensors monitor wind speed, potential icing conditions, traffic, heavy loads, corrosion, moisture, strain on the arch and cables and other conditions to help evaluate the performance of the structure, its materials and its long-term safety.

**Owner**

Iowa Department of Transportation, Ames, Iowa

**Engineer of Record**

HDR Engineering, Inc., Omaha, Neb.

**General Contractor**

Cramer and Associates, Grimes, Iowa



MERIT AWARD—Medium Span Category  
**NORTH HALSTED STREET TIED ARCH BRIDGE, CHICAGO, IL**

Just a few years ago, the Halsted Street Bridge over the Chicago River North Branch Canal put in its 100th year of service.

Built in 1908, the movable double-leaf trunnion bascule truss bridge provided navigable waterway accessibility for vessels too tall to pass beneath when it was closed. Due to the cost of maintaining a movable bridge and the lack of high-mast vessels using the canal, the movable mechanisms of the bridge were decommissioned over 25 years ago and the movable spans were locked together in the closed position.

More recently, the bridge became identified as the only remaining bottleneck to Halsted Street traffic and had become structurally obsolete (in 2007, it earned a sufficiency rating of 25.9 out of 100), and the Chicago Department of Transportation (CDOT) retained structural engineer Lochner to design a replacement.

The new replacement structure consists of a 157-ft-long, 80-ft-wide steel tied arch bridge main span flanked by two 36-ft three-sided precast concrete arch approach spans. With the new bridge deck 22-ft wider than the existing bridge, the replacement bridge carries two lanes each of northbound and southbound vehicular traffic, with one bike lane and pedestrian sidewalk placed on each side. Architectural enhancements were incorporated into the project, including architectural lighting and railings. The pleasantly wide sidewalks of the bridge are shielded from the vehicle traffic by cables and railings. This design arrangement provides the motorists as well as pedestrians with a much safer traffic environment.

To accommodate the roadway with four vehicular lanes and two bike lanes, the arch ribs are spaced at 60 ft. center-to-center; the rib element is a 2-ft, 6-in-wide by 3-ft-deep welded steel box. For simplicity, the rib is braced with a lateral system that consists of only four top struts rigidly

framed with the ribs. The interior of the tie girder is painted bright white for the convenience of future inspection via cameras through the hand holes.

The major force carrying cambered members also include arch ribs, ties and cable hangers. For the tied arch bridge, which is designed as a rigid moment frame in nature, member cambering not only serves to achieve a desired final bridge geometry, but also helps to reduce the member forces by injecting a counteracting force into the structural system through erection. Similar to the “prestressing” concept used for the concrete structure, introduction of the counteracting torsional moments imposed on the steel structural system allow the design to minimize the structural size and maximize the efficiency of the steel usage. Although the savings of the structural steel to the project was a direct benefit, additional indirect benefits included the use of lighter false work and reduction in demand for the crane capacity.

The original bridge was closed after Thanksgiving Day of 2010, and on Christmas Eve of 2011 the main construction of the project was complete and Halsted Street Bridge was open to vehicular and pedestrian traffic on schedule. The total final construction cost, including approach spans and roadway construction, was \$13.7 million, well under the allocated city budget for the project.

The tied arch bridge is a valid design option for enhancing an urban setting with an aesthetically pleasing structure. The successfully completed project demonstrates that a short-span tied arch can be done economically with attention to the steel details that accommodate both accessibility and constructability. Plus, its size speaks to its adaptability and usefulness in tight quarters, and it validates that site issues can be overcome by thoughtful design.

For more on this project, see “Chicago Crossing” (06/2013).



**Owner**

Chicago Department of Transportation –  
Division of Engineering, Chicago

**Engineers**

H.W. Lochner, Inc., Chicago  
HBM Engineering, Hillside, Ill.

**General Contractor**

Walsh Construction,  
Chicago

**Steel Team**

**Fabricator**

Hillsdale Fabricators, St. Louis  
(AISC Member/AISC Certified  
Fabricator)

**Detailer**

Candraft Detailing, Inc., New  
Westminster, B.C., Canada (AISC  
Member)

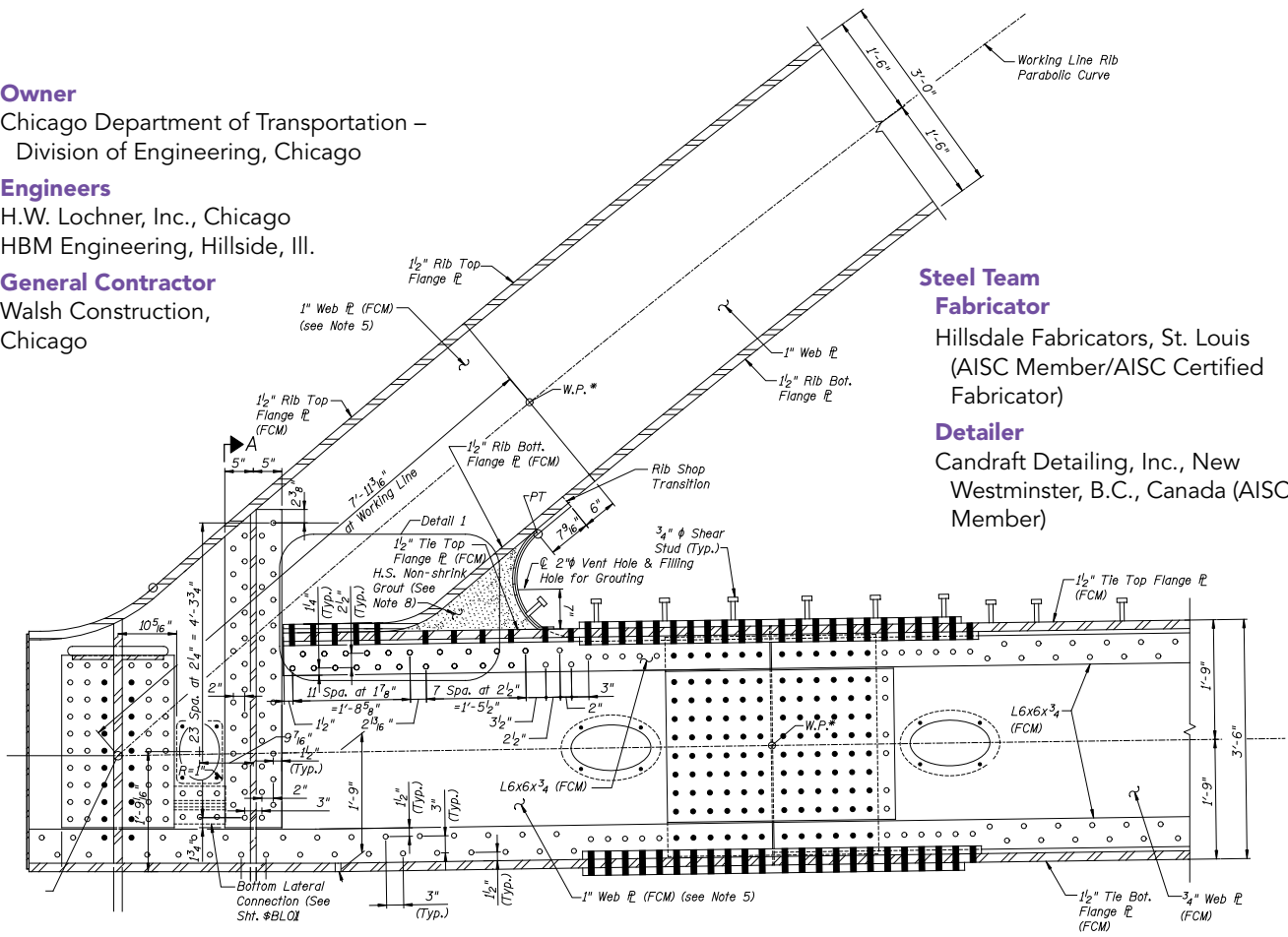



MERIT AWARD—Medium Span  
**RAMP TE OVER I-95, NEW YORK**

**T**he Ramp TE bridge replacement covers a lot of ground (or at least spans over it).

The project is part of the rehabilitation of the Alexander Hamilton Bridge complex on I-95, the Cross Bronx Expressway (CBE) between Amsterdam Avenue in New York County and Undercliff Avenue in Bronx County. The bridge supports the tightly curved Ramp TE over the West Approach spans of the main I-95 bridge.

The existing Ramp TE bridge was a 660-ft-long concrete box girder design with 10 simple spans and a center line radius of 210 ft. The bridge was located totally within a New York City park and had an existing pier located in the median of the CBE, in the center of the west approach spans of the Alexander Hamilton Bridge.

The reconstruction of the Alexander Hamilton Bridge required a widening to each side of the Mainline Bridge of 11 ft. In order to provide the necessary lateral clearances to permit this widening, two of the piers of the Ramp TE bridge structure needed to be relocated as they were positioned immediately adjacent to the edge of the roadway deck of the main bridge. Furthermore, one of the piers supporting Ramp TE was located in the center median of the CBE, in the middle of Span 2W of the Alexander Hamilton Bridge, and effectively prohibited the relocation of traffic lanes during staged construction for the mainline bridge on the west side of the Harlem River.

It was decided to replace the bridge structure in its entirety, with a design that eliminated the pier in the central median of the CBE. The new bridge structure for Ramp TE is a twin steel tub girder structure supporting a reinforced concrete composite deck. It was built in the same location as the existing bridge and remains on a very tight centerline radius of 210 ft with a 6% super elevation. The number of spans was reduced from 10 equal spans of 66 ft to a five-span arrangement of varying centerline lengths, with the piers positioned to suit the existing features. The abutments were retained, as were two pier shafts and foundations; new cap beams were constructed for these shafts. The other two piers have foundations that

used existing spread footings but have complete new shafts.

The design of the new bridge structure was controlled fully by the extremely tight radius of the center line. The client had specified that the top flanges of the box girders be provided with permanent horizontal bracing as a forward-looking measure in the event that a re-decking project would be required at some point in the future. The controlling condition for the design of the top flange bracing was the placement of the deck concrete, due to the unbalanced torsional effects resulting from the concrete placement operation. As such, the sequence for placing the concrete deck sections was rigorously defined in the contract plans.

A further item of interest was that it had been agreed that the structure would be fully continuous throughout its length. This decision arose primarily from the fact that the original bridge had two expansion joints located adjacent to existing piers 4 and 7. These expansion joints had deteriorated severely and it was decided that if possible there would be no interior expansion joints in the new structure throughout its length. As a result, the expansion arrangement of the bridge assumes that the bridge is fixed at new pier 2 and will expand in a guided fashion at all other piers and abutments.

**Owner**

New York State Department of Transportation, Long Island City, N.Y.

**Engineer**

Jacobs, New York

**General Contractor**

Halmar International/CCA Civil, Nanuet, N.Y.

**Steel Fabricator**

Structal-Bridges, Claremont, N.H. (AISC Member/NSBA Member/AISC Certified Fabricator)



MERIT AWARD—Short Span  
SUSTAINABILITY COMMENDATION  
**DODGE CREEK BRIDGE,  
ELKTON-SOUTHERLIN HIGHWAY, ORE.**

One of the Oregon Department of Transportation's (ODOT) chief concerns is the increasing need for rehabilitation on the state's older bridges.

And a chief concern in bridge design and construction is the need for spans that are cost-effective and are environmental friendly—which is where superior materials like weathering steel come in. Weathering steel performs well in parts of Oregon that meet the requirements of the Federal Highway Administration Technical Advisory T5140. However, the state of Oregon was curious about steel types that could reduce steel bridge lifecycle costs in the coastal portion of the State. High-performance steel (HPS) is an important step in increasing toughness and provides a slight increase to the corrosion index compared to weathering steel. However, HPS may still be vulnerable in corrosive and high humidity environments or coastal climates.

One conventional way to provide corrosion protection of bridge steels is to apply protective paint coatings and periodically recoat the bridge during its service life. But the life-cycle cost of this design choice can be much higher than the initial cost of the bridge. An alternative to weathering steel, HPS and painted steel girders is corrosion-resistant ASTM A1010 Grade 50 steel that needs no corrosion protection coating and has better toughness that supersedes toughness properties of Grade HPS 50W. ASTM A1010 is a low-cost stainless steel with 10.5-12%Cr that can perform for 125 years in



coastal environment without a need to maintain for corrosion.

Based on encouraging research and development results, ODOT went ahead with a trial project to design and fabricate of the first public ASTM A1010 steel plate girder bridge in the nation, and ArcelorMittal USA agreed to provide the steel plate. The bridge, with a total length of 132 ft, 6 in. and a width of 42 ft, 8 in., uses just over 80 tons of structural steel. FHWA supported ODOT's proposal by awarding an Innovative Bridge Research and Deployment grant to cover the extra cost for design and fabrication of the first steel plate girders bridge for public use using ASTM A1010 corrosion-resistant steel in the nation.

**Owner and Engineer**

Oregon Department of Transportation, Salem

**General Contractor**

Concrete Enterprises, Inc., Salem

**Steel Team**

**Fabricator**

Fought & Company, Tigard, Ore. (AISC Member/NSBA Member/AISC Certified Fabricator)

**Detailer**

Carlson Detailing Service, Fort Worth, Texas (AISC Member)







MERIT AWARD—Short Span  
ACCELERATED BRIDGE CONSTRUCTION COMMENDATION  
**RIVER ROAD OVER IRONSTONE BROOK, UXBRIDGE, MASS.**

---

**T**he Massachusetts Department of Transportation (MassDOT) is a leader in the use of Accelerated Bridge Construction (ABC) practices.

So when it decided to replace a small bridge carrying River Road over Ironstone Brook in the Town of Uxbridge, Worcester County, with a folded steel plate girder structure, ABC guided the project.

The first application of its kind, the folded steel plate girders were fabricated from a single steel plate of uniform thickness that was then bent along multiple lines using a hydraulic metal press break to form an inverted tub shaped section. A system applicable for spans up to 60 ft in length, this type of fabrication eliminates costly details and processes that have made steel alternatives less competitive than other materials for short span bridges. The need for welding is significantly reduced, and the stability of the resulting girder shape eliminates the need for both internal and external cross framing.

To accelerate construction, the design used four 50-ft-long, 24-in.-deep folded steel plate girders, each prefabricated with a 6.5-in.-deep, 4-ksi concrete deck section attached using  $\frac{3}{4}$ -in.-diameter end welded shear studs. Each beam utilized a single 0.5-in.-thick, 50-ksi steel plate measuring 50 ft in length and 106 in. in width. These dimensions were critical to ensure that the multiple bends could be made using a standard press break. After bending

them to the required shape, a minimal number of welded components were then attached to the beams, including end plates, sole plates and headed shear studs. Four bolted flange separator plates were also attached to the bottom of each girder to help maintain shape, and the entire beam was galvanized.

The decks were then cast in a precast shop with the beams oriented in an upright position with falsework supporting the cantilevers. The shipping width of each interior superstructure module measured 10 ft, 2 in. including headed rebars protruding 11 in. from each edge of the precast slab. Each exterior module was 8 ft, 7 in. in width including a single edge of protruding rebar and an integral concrete curb cast along the exterior slab edge.

The design of the \$1.7 million project (including roadway construction and approach work) was completed in July of 2010, and the construction contract was awarded to the John Rocchio Corporation that October. All four bridge replacements required thirteen weeks to complete, and the roadway was once again open to traffic in November of 2011. As the structure was the first folded steel plate girder bridge ever constructed and placed in service, MassDOT decided to instrument the bridge components with strain gauges to monitor stresses in the steel plates, deck and closure pours. Performance



is currently being monitored by the University of Massachusetts.

MassDOT considers this project a success as a new technology was implemented at a competitive price and resulted in a 28% reduction in the on-site construction schedule when compared to a more conventional adjacent precast concrete box beam alternative. The project has also opened the door for a steel alternative in a span range generally dominated by precast concrete solutions.

**Owner**

Massachusetts Department of Transportation, Boston

**Engineer**

Gannett Fleming, Inc., Mount Laurel, N.J.

**General Contractor**

John Rocchio Corporation, Smithfield, R.I.

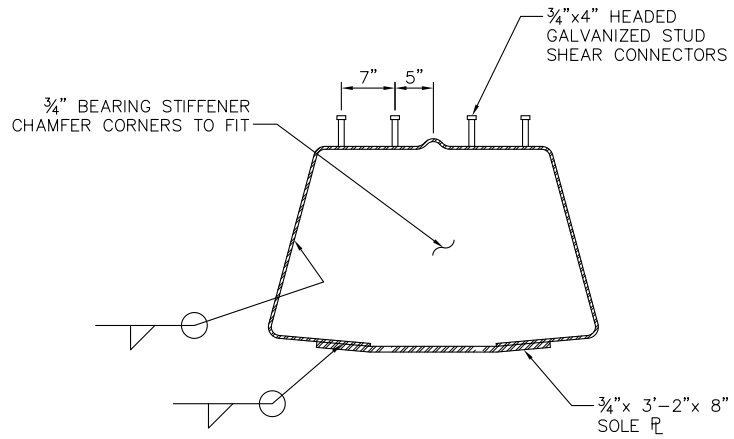



MERIT AWARD—Reconstructed Category

ACCELERATED BRIDGE CONSTRUCTION COMMENDATION

### EGGNER'S FERRY BRIDGE EMERGENCY REPLACEMENT, TRIGG AND MARSHALL COUNTIES, KY.

**O**n January 26, 2012, an 8,679-gross-ton cargo ship struck a 322-ft-long span of the Eggner's Ferry Bridge.

The bridge carries U.S. 68 and KY 80 over Kentucky Lake on the Tennessee River, and the collision effectively closed the western gateway to the Land Between The Lakes National Recreation Area and the only crossing of the lake in Kentucky.

Through an innovative approach to design and construction, the Kentucky Transportation Cabinet (KYTC), Michael Baker Jr., Inc., and Hall Contracting of Kentucky, Inc., were able to replace the span and reopen the bridge to traffic before Memorial Day that year.

Kentucky Lake is a major navigable reservoir adjacent to the 170,000-acre Land Between The Lakes National Recreation Area, which attracts thousands of tourists each year. The Eggner's Ferry Bridge is a 43-span, 3,348-ft-long bridge that provides a vital access point to the recreation area and an important link in the region's transportation system; the detour around the damaged bridge was 42 miles.

Redundancy was an important part of the solution. The preliminary design of the truss assembly was for a parallel chord truss without verticals. Baker redesigned the gusset plates to make all of them a uniform 0.75-in. thick and similarly specified the use of identical sections for the top chord and end diagonals, the bottom chord, the top bracing and struts, the stringers and the floor beams. Designing the truss with only six sizes of rolled sections helped the steel fabricator, Padgett, Inc., and the steel detailer, Tensor Engineering Company, to expedite the detailing and fabrication of the parts by early April. Baker coordinated closely with Tensor to have the shop drawings completed, reviewed and stamped in less than three weeks. Easily accessible material, simple and repetitive connections and high-tech fabrication were the keys to expediting the project. The 13,000 bolt holes that were used to assemble the truss were drilled using computer-controlled equipment, resulting in zero misfits.

The Eggner's Ferry Bridge rehabilitation project demonstrates the importance of careful coordination with the steel detailer and fabricator and intelligent selection of materials

and fabrication details. The use of rolled steel sections in the construction of the new truss eliminated the need for cutting plates and welding, saving valuable weeks of fabrication. Although a slightly heavier truss was used, the consistent sizes of all the components of the new truss ultimately saved days in the fabrication and assembly of the replacement truss. A similar approach could be used by bridge engineers to accelerate the delivery of other bridge replacements or repairs, or even new bridge construction projects.

In addition, lifting a replacement superstructure onto a bridge's existing piers can accelerate construction and minimize the need for lengthy closures, detours, and other traffic disruptions. This project demonstrates that this technique can be used effectively to accelerate repairs to a severely damaged bridge.

On May 15, Hall floated the barge down the lake to the bridge site and used two cranes to lift the new truss from the barge onto the existing piers. The installation of the stay-in-place forms and studs and the pouring of the 6.5-in.-thick concrete deck were completed by May 20. The guardrail was installed and the bridge was opened to traffic, with a celebration by the governor, local officials and the community, on Friday, May 25—two days ahead of schedule.

For more on this project, see "Down but not Out" (11/2012).

#### Owner

Kentucky Transportation Cabinet – District 1, Paducah, Ky.

#### Engineer

Michael Baker Jr., Inc., Louisville, Ky.

#### General Contractor

Hall Contracting of Kentucky, Inc., Louisville

#### Steel Team

##### Fabricator

Padgett, Inc., New Albany, Ind. (AISC Member/NSBA Member/AISC Certified Fabricator)

##### Detailer

Tensor Engineering, Indian Harbour Beach, Fla. (AISC Member/NSBA Member)



MERIT AWARD—Special Purpose Category  
**CHRISTINA AND JOHN MARKEY  
MEMORIAL PEDESTRIAN BRIDGE,  
REVERE, MASS.**

From redevelopment comes new life—and sometimes a first.

The \$1.8 million Markey Bridge is the first cable-stayed pedestrian-only bridge in Massachusetts and has already become an important link between the MBTA Blue Line Wonderland Station in Revere, Mass., and Revere Beach, America's first public beach (established in 1896). Completed last July, the bridge is part of the Revere Transit and Streetscape Project, which was conceived as part of a redevelopment plan for the areas surrounding the Wonderland Station.

The final design and construction was completed through a design-build contract, and the cost of the bridge did not exceed the original budget and completion time. The main span of the bridge crossing Ocean Boulevard is 107 ft and the overall length is 151 ft. The bridge was designed to create a visual statement from a distance providing enhanced and open views of the Atlantic Ocean, and construction had to be coordinated with accessibility to adjacent streets and the beach, which increased the project's complexity.

A pair of 52-ft-tall outward-inclined towers frame the access to the beach and its historic pavilions. All steel components of the bridge are tapered/angled by design, which allows for unique perspectives from several vantage points. The walking surface is 12 ft wide between stainless steel railings that complement the inclination of the towers. Energy-efficient LED aesthetic lighting has been integrated into the railings, enhancing the appearance of the crossing at night. All steel components of the bridge have been treated with a duplex hot-dip galvanizing process to protect them from exposure to the marine environment. Pedestrian traffic between the transit facility and the beach has increased substantially since the bridge opening, and a new hotel is planned to open adjacent to the landmark footbridge in the near future.

**Owner**

Massachusetts Department of Conservation and Recreation, Boston

**Engineer**

AECOM, Boston

**Architect**

Rosales + Partners, Boston

**General Contractor**

Suffolk Construction Company, Boston

**Steel Fabricator and Detailer**

CIANBRO Corporation, Pittsfield, Maine (AISC Member/NSBA Member/AISC Certified Fabricator)

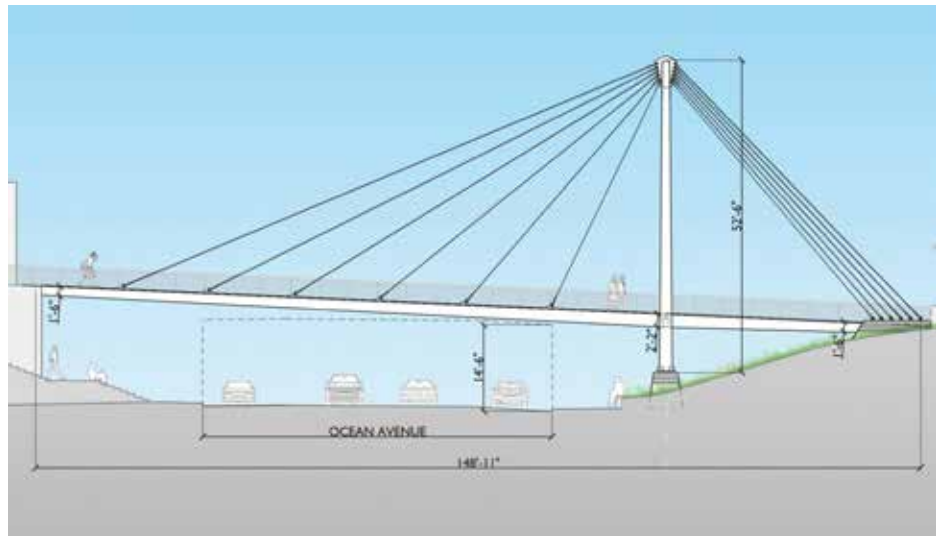



## SUSTAINABILITY COMMENDATION KEENE ROAD BRIDGE, RICHLAND, WASH.

An abandoned Union Pacific Railroad steel box bridge has gained new life with its conversion into a major vehicular traffic bridge in the City of Richland, Wash.

This project required retrofitting the railroad bridge as the final step in completing the Keene Road Corridor, which now serves as a major east-west arterial in the rapidly growing Tri-Cities area of Washington State.

KPFF provided the design expertise for the project, which has been praised by civic leaders and state transportation officials alike for recycling a bridge that had been out-of-service for decades. The retrofitted bridge was designed to carry two westbound traffic lanes as well as a shared-used pedestrian and bicycle pathway across Interstate 182. The newly retrofitted bridge is parallel to Keene Road's preexisting vehicular bridge, which previously carried both east- and westbound traffic over the interstate.

The Union Pacific Railroad Bridge, originally built as a four-span, 412-ft-long steel box structure, had not been under railroad loading since its construction in 1981. The final bridge required an additional 160 tons of steel in addition to the 300 tons that were part of the existing structure. KPFF's winning design was a steel overhang frame, or steel outrigger design, to support the widened portion of the deck. Not only was this the least expensive of the four options considered, but it also offered significant advantages over the other alternatives (a two-span steel girder, four-span steel girder and rebar tie steel overhang frame). The steel outrigger design made the best use of the existing steel box reserve capacity, which was originally designed for heavier railroad loading. The design live load of a train is five times the load considered for truck vehicles on a bridge.

As noted, KPFF partially used the original concrete deck but didn't want to count on the deck to resolve the tension forces between the outriggers. So a steel plate was installed that crossed the top of the box and attached to each outrigger. This adjustment allowed a major part of the original deck to remain in the design.

The railroad tracks of the old bridge were originally positioned within the boundaries of the steel box girder, which meant that the bridge experienced "zero" torsion. KPFF's design doubled the width of the bridge, which in turn located traffic lanes—and their loads—outside the box girder and created significant torsion. To account for the added torsion, KPFF reinforced the existing internal crossframes of the box girder, a treatment that was never part of the original railroad bridge design.

Construction began in August 2011 and proceeded with a minimal number of traffic disruptions—unusual for a bridge project over a major interstate. The bridge officially opened to the public September 28, 2012.

### Owner

City of Richland, Wash., Civil and Utility Engineering

### Engineer

KPFF Consulting Engineers, Seattle

### General Contractor

West Company, Inc., Medical Lake, Wash.

### Steel Team

#### Fabricator

Rainier Welding, Inc., Redmond, Wash. (AISC Member/AISC Certified Fabricator)

#### Detailer

Adams & Smith, Inc., Lindon, Utah (AISC Member)





#### ACCELERATED BRIDGE CONSTRUCTION COMMENDATION

### 130TH STREET AND TORRENCE AVENUE RAILROAD TRUSS BRIDGE, CHICAGO

The intersection of 130th Street and Torrence Avenue in Chicago serves approximately 38,000 vehicles a day, including traffic to and from the nearby Ford Motor Company Plant.

In addition, more than 50 freight trains cross on two at-grade Norfolk Southern (NS) tracks near the intersection, making it a major bottleneck for both rail and vehicular traffic. To eliminate these conflicts, a three-tiered grade separation design was developed for the intersection, and the new Chicago, South Shore & South Bend (CSS&SB) commuter/freight railroad truss is a key component.

The complex reconfiguration involves 130th Street and Torrence Avenue being realigned and lowered below the existing NS tracks. Two new NS structures are being constructed on new alignments and the new CSS&SB structure is already in place on its new alignment. Once fully completed, the project will provide a three-tiered grade separation to relieve traffic congestion and improve the efficiency of rail service in the area. Making sure all the project components fit in this complex puzzle while maintaining all rail traffic required the CSS&SB railroad truss span to be constructed first.

The preliminary design, geometry and location of the truss were based on minimizing impacts to railroad operations during construction; meeting NS horizontal and vertical requirements at both the existing and proposed alignments; tying back into the CSS&SB existing tracks while accommodating a track spiral; and accommodating the proposed widened and realigned Torrence Avenue.

At the end of preliminary design, the proposed CSS&SB structure consisted of a 368-ft-long truss with abutments skewed at 45°; the skew was implemented to have the shortest span possible. During the early stages of the final design phase, other geometric and logistical constraints by the site and stakeholders surfaced, requiring the geometry of the truss to be revisited. The detailing and fabrication of the skewed portal frames of the truss were found to increase the cost of the

truss and make fabrication and construction more complex. With accelerated bridge construction (ABC) techniques already approved by major stakeholders, it was also noted that maintaining a skewed truss would make installation more challenging as the self-propelled mobile transporters (SPMTs) would have to guide the truss into place while moving on a diagonal. It was determined that a longer truss with squared abutments would provide a more economical design and would better facilitate construction.

The elimination of the skew had numerous advantages. The volume of concrete required at the abutments was reduced by approximately 30% due to the reduced width of the truss substructures. The end floor beam span was also reduced from approximately 57 ft, 8 in. to 40 ft, 2 in., eliminating the need for an intermediate bearing for the floor beam. The revised and final layout of the truss resulted in a 394-ft span center to center of bearings with supports perpendicular to the structure. The longer truss span required the east abutment to shift a couple feet to the east due to an increase in bearing size from the size estimated during preliminary design. This shift brought the track closer to the truss due to the spiral curve at the end of the truss span. Because of this, the engineer had to make sure the bridge was wide and tall enough to meet the railroad's clearance requirements, and the width of the truss increased from 36 ft, 8 in. to 40 ft, 2 in. center to center of trusses.

The use of high-performance steel was the best, most durable and economical material choice for the truss bridge. It extended the bridge's expected life to 100-plus years and reduced long-term maintenance. This massive double track, ballasted deck, through truss is just a part of the larger complex grade separation structure, which also includes five approach spans consisting of 54-in.-deep pre-stressed box beams. The truss substructure consists of full height concrete piers supported on driven steel piles. An excavation support system was required to protect the existing NS tracks during construction of the new piers.

Once the truss was in place, the contractor and railroad teams continued to work on the bridge, placing the ballast and ties on the truss, installing the catenary wires that power the CSS&SB trains and putting the finishing touches on the truss. On October 25, 2012, the first CSS&SB train crossed the new railroad truss bridge.

For more on this project, see "Big Roll" (03/2013). ■

**Owner**

Chicago Department of Transportation –  
Division of Engineering, Chicago

**Engineer**

Alfred Benesch & Company, Chicago

**General Contractor**

Walsh Construction Company, Chicago

