

Modern Steel Construction

February 2019

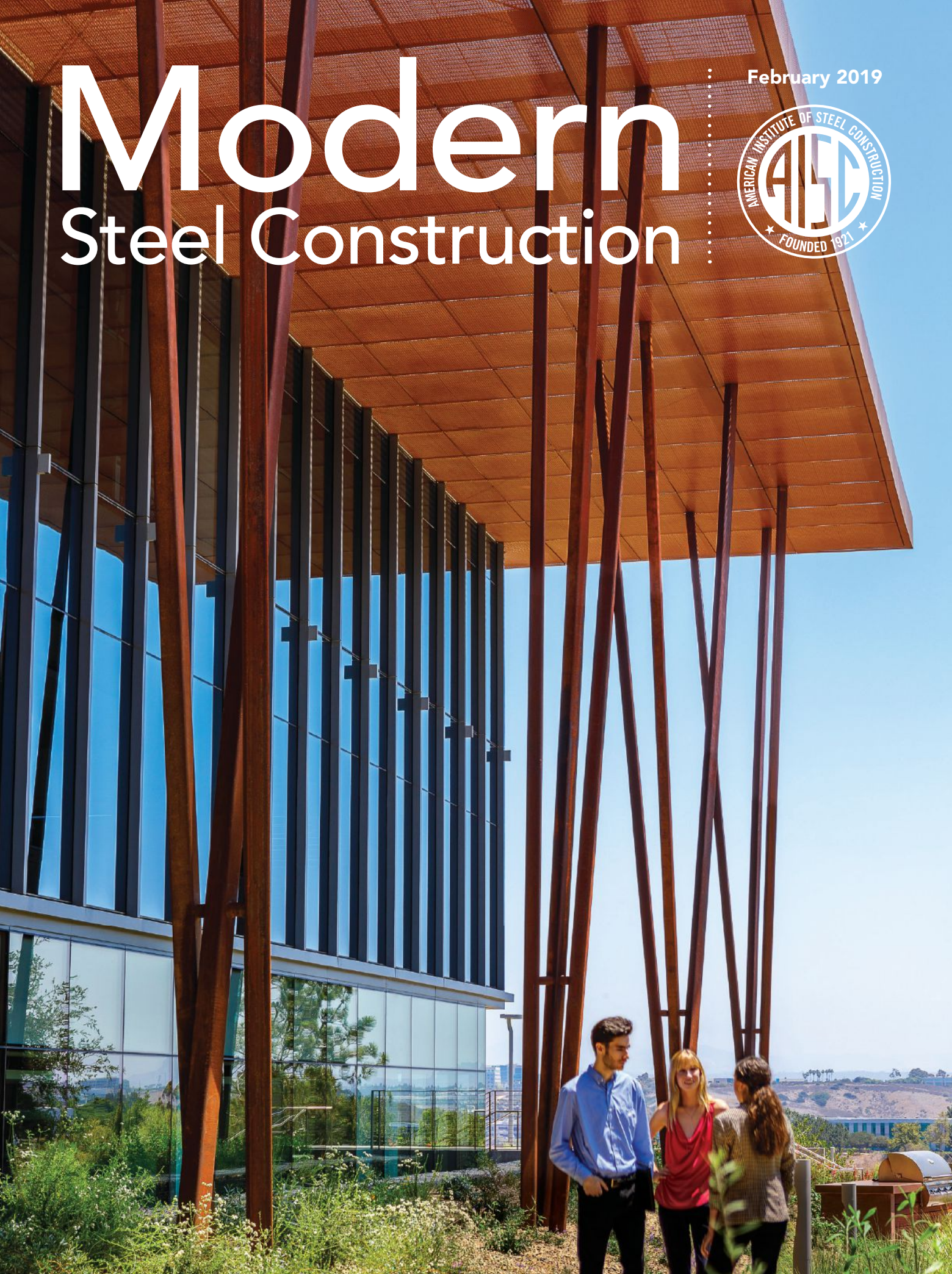

STRONGER THAN STEEL

HIGH SPEED ANGLE AND FLAT BAR PROCESSING

320 TON SINGLE CUT SHEAR

DUAL TRIPLE TOOL PUNCH PRESSES

SHEAR, PUNCH, NIBBLE, SCRIBE
AND STAMP ANGLE AND FLAT BAR

PATENTED MEASUREMENT SYSTEM
FOR UNMATCHED ACCURACY



**WATCH
VIDEOS
HERE**

www.peddinghaus.com/663

Peddinghaus

www.peddinghaus.com | info@peddinghaus.com | (815) 937-3800

WIN A FREE BAND SAW
TEXT KEYWORD 'WINNER' TO 69922

GRAND PRIZE: 410-DG BAND SAW

SECOND PRIZE: \$500 GIFT CARD THIRD PRIZE: \$100 GIFT CARD

3 Msgs/Month. Reply STOP to cancel. HELP for help. Msg&data rates may apply.

Terms: <https://www.peddinghaus.com/terms/1>



Vulcraft 3N Deck

Say Hello to the New 3N Deck.

It's still N deck. It's just wider

With an extra eight inches in coverage, the wider 3N deck from Vulcraft will still meet all of your design needs.

The extra eight inches gives you:

- Faster installation
- Fewer bundles to lift
- Fewer sheets to spread
- Fewer sidelaps to connect
- Compatible with Hilti, Pneutek, Simpson and other fasteners

Available versions (FM and UL Listed)

3NL-32 Nestable sidelap

3NI-32 Interlocking sidelap

3PLN-32 PunchLok® II system

Learn the advantages of our new wider deck

vulcraft.com/decks

NUCOR[®]
VULCRAFT GROUP

Powerful Partnerships.
Powerful Results.

Modern Steel Construction

February 2019

in every issue

departments

- 6 EDITOR'S NOTE
- 9 STEEL INTERCHANGE
- 12 STEEL QUIZ
- 62 NEWS AND EVENTS
- 66 STRUCTURALLY SOUND

resources

- 65 ADVERTISER INDEX
- 65 MARKETPLACE & EMPLOYMENT

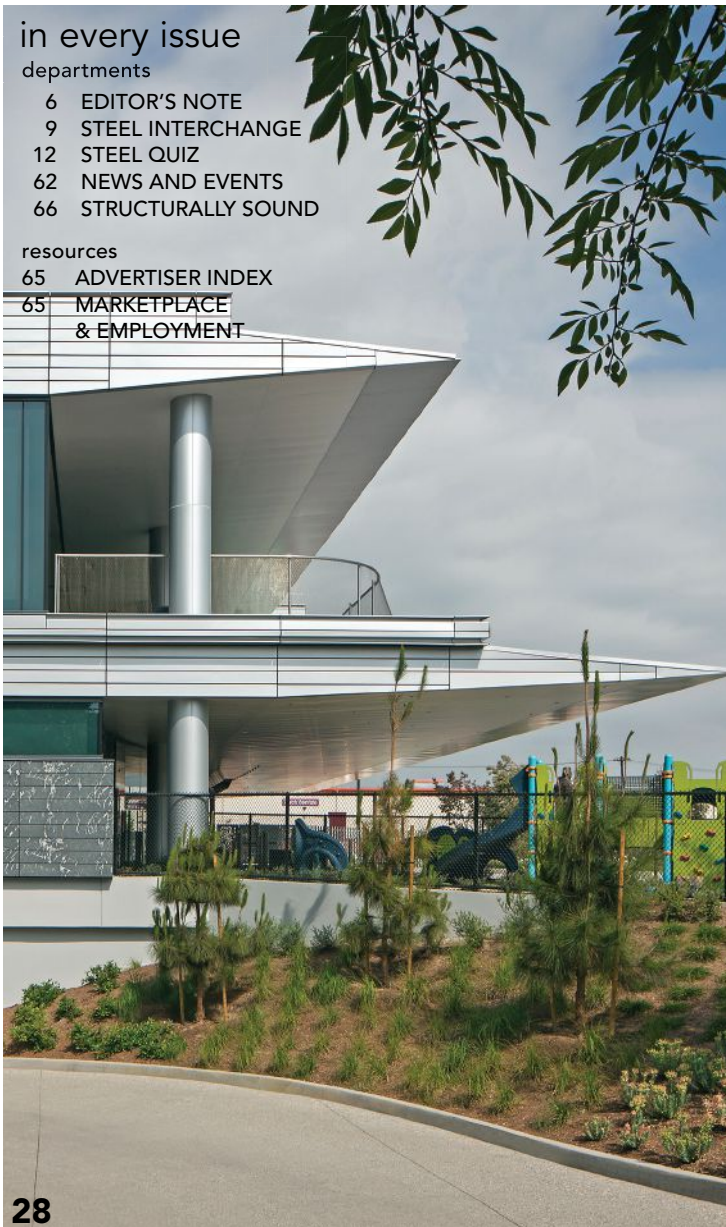

features

- 22 Design-Assist and the AISC Code**
BY CHARLES J. CARTER SE, PE, PhD
A formal interpretation and related thoughts.
- 24 Aloha, Steel**
BY JAMES SAVAGE, SE, PE
Steel successfully addresses all of the typical challenges of building in the Aloha State in the form of a new hospital tower in Honolulu.
- 28 Healing Oasis**
BY TIM HEIMAN, SE
Shriners Hospitals looks to steel to meet sustainability requirements and seismic design challenges with style.
- 34 A Living, Breathing Building**
BY BRYAN SEAMER, SE
A new pharmaceutical headquarters building uses steel to bring its science-inspired design to efficient reality.
- 40 Brainy Building**
BY THOMAS W. TAYLOR, PE, AND RODOLFO D'ARLACH, PE
Smart thinking and an intelligent construction approach help bring a brilliantly designed cognitive research facility to life. Genius!
- 46 Better Seismic Performance**
BY CHARLES W. ROEDER, PhD, DAWN E. LEHMAN, PhD, AND JEFFREY W. BERMAN, PhD
A look at seismic evaluation and improvements to older (pre-1988) concentrically braced frames.
- 50 The Resilient New Kid in Town**
BY ERIC MOE, PE
An innovative braced frame system makes its debut in Wyoming.
- 54 SpeedCore and Composite Plate Shear Walls**
BY MORGAN BROBERG, SOHEIL SHAF AEI AND JUNGIL SEO
A brief look at the seismic behavior of the SpeedCore system.
- 58 To 3 or Not to 3**
BY PATRICK J. FORTNEY, SE, PE, PENG, PhD, AND JOHN HOOPER, SE, PE
Tips on selecting the best seismic system for your next project.

columns

steelwise

- 16 Stated Limits**
BY CARLO LINI, PE
A look at yield-line analysis and how to use it to determine flexure limit states.

business issues

- 20 One-on-One**
BY JEFFREY W. FOLEY
Individual coaching—when done properly—is the most effective way to develop your people.

ON THE COVER:

The new Spectrum IV facility in San Diego offers a wide spectrum of exposed steel elements, p. 34. (Photo: Costea Photography, Inc.)

MODERN STEEL CONSTRUCTION (Volume 59, Number 2) ISSN (print) 0026-8445; ISSN (online) 1945-0737. Published monthly by the American Institute of Steel Construction (AISC), 130 E Randolph Street, Suite 2000, Chicago, IL 60601. Subscriptions: Within the U.S.—single issues \$6.00; 1 year, \$44. Outside the U.S. (Canada and Mexico)—single issues \$9.00; 1 year \$88. Periodicals postage paid at Chicago, IL and at additional mailing offices. Postmaster: Please send address changes to MODERN STEEL CONSTRUCTION, 130 E Randolph Street, Suite 2000, Chicago, IL 60601.

DISCLAIMER: AISC does not approve, disapprove, or guarantee the validity or accuracy of any data, claim, or opinion appearing under a byline or obtained or quoted from an acknowledged source. Opinions are those of the writers and AISC is not responsible for any statement made or opinions expressed in MODERN STEEL CONSTRUCTION. All rights reserved. Materials may not be reproduced without written permission, except for noncommercial educational purposes where fewer than 25 photocopies are being reproduced. The AISC and Modern Steel logos are registered trademarks of AISC.



Printed on paper made from a minimum of 10% recycled content.

“VisualAnalysis offers excellent value”



Structural Software

Easy. Versatile. Productive.



What will you design?

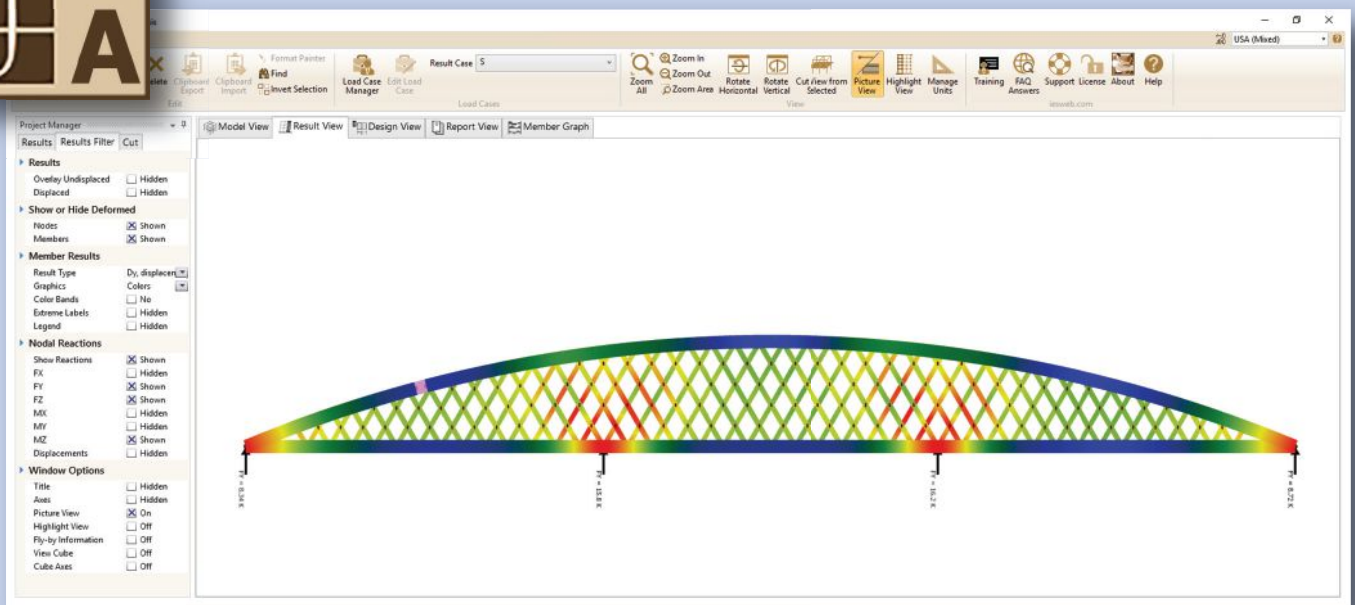

Roller Coasters
Dophins & Docks
Stadiums
Derrick Cranes
Sliding Skids
Storage Racks
Multi-level Foundations
Octagonal Monopoles
Burried Culverts

That Secret Defense Thing
Apartment Buildings
Starter Castles
Crane Girder Systems
Airport Terminals
Concrete Tunnel Shells
Temporary Shoring
Scaffolding
Barns

Musical Stage & Lighting Supports
Mining Conveyor Supports
Highway Signs
Bridge Piers
Dam Gates
Column Transfer Girder
Boiler Tanks
Paint Booths
Artistic Sculptures...

Download your free trial today:

iesweb.com

800.707.0816



editor's note



My current favorite event to watch isn't the Stanley Cup finals or any of the college football bowl games; it's the VEX Robotics Competition.

More than 20,000 teams from more than 40 countries worldwide participate by building sophisticated robots that compete by shooting balls at targets to toggle flags, flip tiles, stack tiles on a pole and seize a central platform. For part of the competition, the robot is driver-controlled, but there's also a purely autonomous portion. (If you want to learn more about the competition, there are plenty of videos at www.youtube.com/user/vexroboticstv.)

My youngest son, Jason, and his team, 333R Los Robos, have already won two tournaments this season and are heading for the state championships later this month. But beyond obvious paternal pride, the robotics competition is important for the future. Sitting at my niece's house for a family gathering on Christmas, my wife was talking about the competition with my sister-in-law, and she compared it to some of the amazing robotics she saw at NASCC: The Steel Conference (www.aisc.org/nascc) last year in Baltimore. The comparison is not only apt but also critical for the future success of the industry. Why? Because fabrication is becoming less driven by manual labor and is rapidly becoming a technology industry.

About one-third of the 200,000-sq.-ft. exhibition hall at this year's conference is devoted to heavy equipment—machines used by fabricators to cut, punch, drill, bend and weld steel. And more and more, the equipment is highly automated. (Check out this video I shot last year at Prospect Steel in Little Rock: www.aisc.org/roboticwelding.) While the sparks and the noise get all the attention, the real excitement is at the control stations.

And while the big equipment indeed commands attention, it's important not to view any one process in isolation. If you wander through the hall, you can easily visit any of the major design software vendors and see how their software is helping to automate the work structural engineers are doing. You can then skip over to see the latest in detailing software and how it integrates with the robotic equipment at the equipment vendors. And, of course, you can also see physical products ranging from curved steel to joists to coating systems to wrenches.

However, the exhibit hall is just a small part of the conference for most of the 5,000-plus participants. Just as important are the more than 150 technical sessions. These practical seminars range in topic from seismic design to contract negotiation, from specifying joists to better understanding quality systems. (If you want to preview the sessions offered at this year's conference, visit www.aisc.org/nascc to download this year's program. Alternately, visit www.aisc.org/2018nascconline and you can view, at no charge, more than 100 sessions from last year's conference.)

The conference is scheduled for April 3–5 in St. Louis, and I urge you to register as soon as possible (registration fees increase \$10 each week). As Joshua Pudleiner from AECOM stated after last year's conference, NASCC is "a perfect blend of professionals from the industry coming together to share their knowledge and expertise." I hope you'll be part of the 2019 conference and that I'll see you in St. Louis!

Scott Melnick
Editor

Modern Steel Construction

Editorial Offices

130 E Randolph St, Ste 2000
Chicago, IL 60601
312.670.2400

Editorial Contacts

EDITOR AND PUBLISHER

Scott Melnick

312.670.8314

melnick@aisc.org

SENIOR EDITOR

Geoff Weisenberger

312.670.8316

weisenberger@aisc.org

DIRECTOR OF PUBLICATIONS

Keith A. Grubb, SE, PE

312.670.8318

grubb@aisc.org

PRODUCTION COORDINATOR

Erika Salisbury

312.670.5427

salisbury@aisc.org

GRAPHIC DESIGN MANAGER

Kristin Hall

312.670.8313

hall@aisc.org

AISC Officers

CHAIR

David Zalesne

VICE CHAIR

Jack Klimp

SECRETARY/LEGAL COUNSEL

Edward Seglias

PRESIDENT

Charles J. Carter, SE, PE, PhD

SENIOR VICE PRESIDENT

Scott Melnick

VICE PRESIDENT

Lawrence F. Kruth, PE

VICE PRESIDENT

Tabitha S. Stine, SE, PE

VICE PRESIDENT

Mark W. Trimble, PE

VICE PRESIDENT

Caroline R. Bennett, PE, PhD,

University of Kansas

Keith R. Griesing, PE,

Hardesty and Hanover

Steve Knitter,

Geiger and Peters

Janice Mochizuki, PE, Arup

Dylan Olson, Olson Steel

Dylan Olson, Olson Steel

Advertising Contact

ACCOUNT MANAGER

Renaë Gurthet

231.995.0637

renaë@gurthetmedia.com

Address Changes and Subscription Concerns

312.670.2400

subscriptions@aisc.org

subscriptions@aisc.org

subscriptions@aisc.org

subscriptions@aisc.org

subscriptions@aisc.org

subscriptions@aisc.org

subscriptions@aisc.org

subscriptions@aisc.org

INTELLIGENT AUTOMATION

EQUALS

PRODUCTIVITY

«PROFITABILITY»

PERFORMANCE

How SDS/2 Helps You

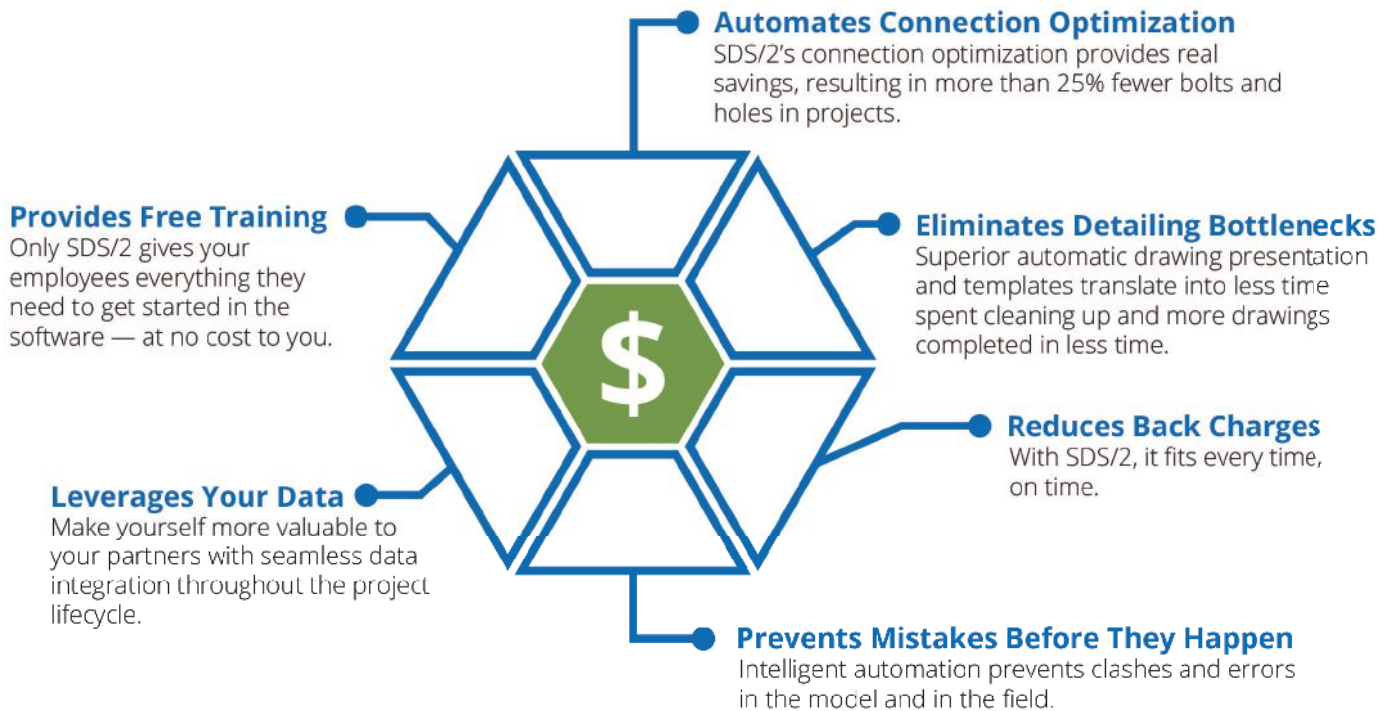

“We made the decision back when we started the company to go with SDS/2

for a lot of reasons. One, a great reputation. I had experience with them in the past, and I knew that they were the kind of people to stand behind their software. They work hard to make the best detailing software in the world. And it continually gets better and better. There's nothing SDS/2 can't do with steel. And we've proven that.

**HENRY E. “HAL” CARTEE, JR., P.E., CO-OWNER
CARTEE-BERRY & ASSOCIATES**

See how SDS/2 can increase your bottom line at
sds2.com/profitability



A NEMETSCHek COMPANY

1501 Old Cheney Rd., Lincoln, NE 68512 // 800-443-0782 // www.sds2.com





AISC Night School

class begins February 4, 2019

Connection Design: Tips, Tricks and Lessons Learned

presented by Carol Drucker, SE, PE; Patrick Fortney, PE, PhD;
Larry Muir, PE; Clifford Schwinger, PE;
and William Thornton, PE, PhD

Monday nights 7:00 p.m. Eastern Time
90 minutes per session | 8 sessions total
1.5 PDHs per session

This course will emphasize the procedural aspects of the detail design process in addition to technical guidance.

Topics include:

- delegated connection design
- shear connections
- vertical bracing connections
- moment connections
- seismic connections
- lessons learned



Smarter. Stronger. Steel.

American Institute of Steel Construction
312.670.2400 | www.aisc.org

www.aisc.org/nightschool

If you've ever asked yourself "Why?" about something related to structural steel design or construction, *Modern Steel's* monthly Steel Interchange is for you! Send your questions or comments to solutions@aisc.org.

steel interchange

All AISC Design Guides mentioned can be found at www.aisc.org/dg. All other AISC publications, unless mentioned otherwise, refer to the current version and are available at www.aisc.org/specifications.

Out-of-Print Publications

I was told I need to purchase "AISC publication number M325" but I don't know what that means. What should I do?

This is the result of a historic anachronism built on a misunderstanding. In the pre-digital past, AISC printed a publications catalog, and each publication had a catalog number that was used by AISC for inventory control and order fulfillment. For example, the *Steel Construction Manual* was M325 and the *Specification for the Design of Steel Hollow Structural Sections* was S346. Oftentimes, people would mistake these catalog numbers as formal designations and would use them in their specifications. Besides the fact that we all know we should not be specifying the *Manual* in a job specification (we should be referencing the *Specification* itself), the catalog number was never intended to be used this way. Realizing the problem, AISC adopted its current naming convention, and all of our reference documents now have formal specification numbers (for example, the current *Specification for Structural Steel Buildings* is ANSI/AISC 360-16). If you run across an odd three-digit publication number, you can find out what it's referring to (including its modern equivalent) by visiting www.aisc.org/publications/out-of-print-publications.

Keith A. Grubb, SE, PE

Metric vs. Imperial Bolt Hole Sizes

What is the reason for the slight difference in hole diameter sizes for metric and imperial bolts in Table J3.3 and J3.3M of the AISC *Specification*?

Maintaining the same hole clearance for both metric and imperial applications would result in odd numbers—e.g., $\frac{1}{16}$ in. is exactly equal to 1.588 mm. I suspect this is the primary reason for the discrepancy.

Note that in the 2016 AISC *Specification*, the clearance for 1-in. bolt diameters and greater was increased to $\frac{1}{8}$ in. This provides better agreement with the metric clearances that have been used for some time.

Larry S. Muir, PE

Excessive Root Openings

I have a question about the root gap opening at a welded moment connection on a current project. The beam-to-column moment frame connection is to be a CJP (complete joint penetration) groove weld at the flanges. But in the field, the root gap is $\frac{5}{8}$ in. or more. Table 8-2 of the 15th Edition *Manual* provides root openings that are less than $\frac{5}{8}$ in. Are these maximum values? Is welding a root pass of $\frac{5}{8}$ in. or larger a concern?

For prequalified joints, the dimensional requirements and tolerances are provided in AWS D1.1 and are reprinted in Table 8-2 of the AISC *Manual* for convenience. Joint TC-U4a (page 8-44 of the *Manual*) shows a root opening tolerance of $+\frac{1}{4}$ in., $-\frac{1}{16}$ in. The tolerance is applied to the "as detailed" root opening dimension.

AWS D1.1 addresses root openings that exceed these tolerances. According to Clause 5.21.4.1, "The dimensions of the cross section of the groove welded joints which vary from those shown on the detail drawings by more than these tolerances shall be referred to the Engineer for approval or correction." If required, corrective action is addressed in AWS D1.1 Clause 5.21.4.3: "Root openings greater than allowed by 5.21.4.2, may be corrected by welding only with the approval of the engineer." Clause 5.21.4.2 states: "Root openings greater than those allowed in 5.21.4.1, but not greater than twice the thickness of the thinner part or $\frac{3}{4}$ in. [20 mm], whichever is less, may be corrected by welding to acceptable dimensions prior to joining the parts by welding."

Bo Dowsell, PE, PhD

Small HSS Shapes

The AISC *Manual* provides dimensions and properties for a large number of HSS shapes. However, there are smaller HSS shapes that are not included in these tables. Is there a reason why really small HSS shape sizes have been excluded?

The AISC *Manual* is already quite large so, the Manual Committee must make decisions about what to include and exclude. Materials that are more likely to be useful as structural steel are included. Smaller material is often excluded either because it has limited use as structural steel and/or it can present challenges to fabrication. For example, though what has been included in the *Manual* varies over time, smaller wide flange sections are often not included in column tables because the use of smaller sections can make it difficult to use standard connections.

Larry S. Muir, PE



Carlo Lini is AISC's director of technical assistance, and **Keith Grubb** is AISC's director of publications. **Larry Muir** and **Bo Dowsell** are both consultants to AISC.

Column Web Workable Gages

The AISC *Manual* lists workable gages for fasteners in the flanges of W-shapes. I would like to know if there is a publication that lists common or standard workable gages for fasteners in the webs of column sizes (W8-W10-W12-W14). This would be helpful for designing vertical bracing connections and beam to column connections.

We do not provide specific guidance related to workable gages for fasteners in the webs of columns. The gages for these conditions will be driven by the beam web thickness and the type of connection. There is a discussion in Part 10 of the *Manual* that states: "Because of bolting and welding clearances, double-angle, shear end-plate, single-plate, single-angle and tee shear connections may not be suitable for connections to the webs of W-shape and similar columns, particularly for W8 columns, unless gages are reduced. Such connections may be impossible for W6, W5 and W4 columns. There is also an accessibility concern for entering and tightening the field bolts when the connection material is shop-attached to the supporting column web and contained within the column flanges."

The best advice I can give is this: If you are using shallow column sections and/or you have doubts about being able to fit up the connections, you should either draw the joints to scale or consult with a fabricator.

Larry S. Muir, PE

Partial Depth Stiffeners

I am calculating the web distortion for a wide-flange section with partial-depth stiffeners to determine bracing requirements. I am using a method suggested by Joseph Yura in his 2001 AISC *Engineering Journal* paper "Fundamentals of Beam Bracing" (a free download for members at www.aisc.org/ej); see Figure 1, below. What values for b_s (stiffener width) and t_s (stiffener thickness) should be used when determining the stiffness of the unstiffened depths, b_c and b_t , of the member?

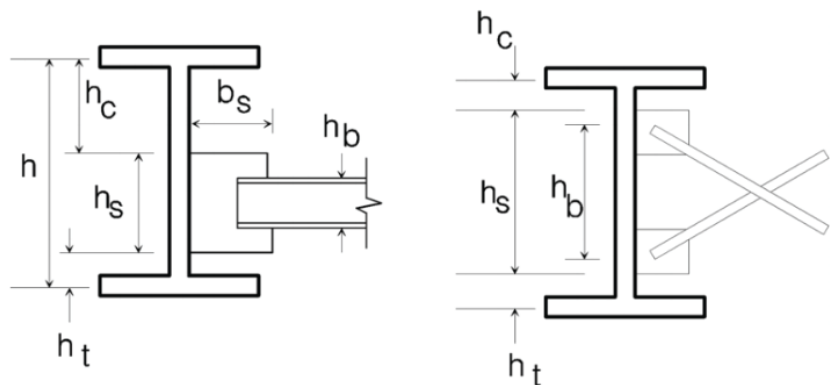

Figure 1. Partially stiffened webs.

When calculating β_c and β_t with the equations in the Yura paper, b_s and t_s are zero because there are no stiffeners in that web segment.

Bo Dowsell, PE, PhD



Steel Interchange is a forum to exchange useful and practical professional ideas and information on all phases of steel building and bridge construction. Contact Steel Interchange with questions or responses via AISC's Steel Solutions Center: 866.ASK.AISC | solutions@aisc.org
The complete collection of Steel Interchange questions and answers is available online at www.modernsteel.com.

The opinions expressed in Steel Interchange do not necessarily represent an official position of the American Institute of Steel Construction and have not been reviewed. It is recognized that the design of structures is within the scope and expertise of a competent licensed structural engineer, architect or other licensed professional for the application of principles to a particular structure.



Total Workflow Optimization at Your Fingertips

TRIMBLE SOFTWARE FOR STEEL INDUSTRY

The best in the business have come together to enable more streamlined workflows for the steel industry! Combining the **Tekla** Structures truly constructible BIM model with **FabSuite's** comprehensive fabrication management solution enables next-generation workflows today!

Learn more at: www.tekla.com/steel

steel quiz

This month's Steel Quiz is based on hollow structural sections (HSS) and their connections per the 2016 AISC *Specification for Structural Steel Buildings* (ANSI/AISC 360-16, available at www.aisc.org/specifications).

- When designing an HSS member, a reduced wall thickness of $0.93t$ must be used for strength calculations.
 - Yes
 - No
 - It depends.
- A round column is needed for a project. What would be some of the potential benefits of specifying ASTM A500 Grade C vs. A500 Grade B or A53 Grade B for the column?
- List some typical limit states for rectangular HSS-to-HSS moment connections.
- What sections in Chapter J of the AISC *Specification* should be referenced when determining the suitability of an HSS wall to resist concentrated forces?
- True or False:** The chord-stress interaction parameter, Q_f , for round HSS-to-HSS truss connections is dependent on

the utilization factor, U , regardless of whether the chord is resisting tension or compression.

- True or False:** When using HSS shapes as beams, lateral-torsional buckling will usually reduce the flexural strength and will govern the design.
- For the HSS5×5×¼ slotted tension connection in Figure 1, calculate the effective area, A_e , assuming a 5-in.-long weld. Assume a gap of $\frac{1}{16}$ in. on each side of the brace slot to allow clearance for erection. Which of the following areas did you calculate?
 - 3.12 sq. in.
 - 2.31 sq. in.
 - 3.37 sq. in.
 - 2.21 sq. in.

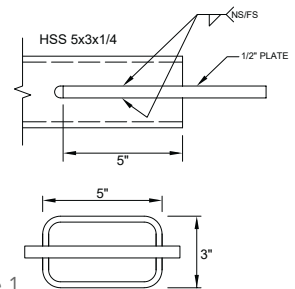

Figure 1

TURN TO PAGE 14 FOR THE ANSWERS

Show'em you did it right!

with DuraSquirt® DTIs

the best way to bolt!



applied bolting
TECHNOLOGY



2019 sponsor
THE STEEL CONFERENCE

800 552 1999
802 460 3100

appliedbolting.com
info@appliedbolting.com

BOOTH 1027

A WORLD OF STEEL PROCESSING MACHINERY...

The Solution That Best Fits Your Needs.



BEAM
PROCESSING



EXCALIBUR - VICTORY
Mono spindle CNC
Horizontal Drilling Systems



ORIENT range
Mono spindle CNC
Profile Processing Center



VANGUARD range
Three spindle CNC Profile
Processing Lines



LIBERTY range
Three spindle CNC
Profile Processing Lines



ENDEAVOUR - VALIANT range
Three spindle CNC Profile
Processing Lines



ENTERPRISE range
CNC Gantry Drilling Lines



RAZ - FLEX range
CNC Coping Robot and Systems



KATANA range
Band Sawing Systems



PLATE
PROCESSING



P range
CNC Punching, Drilling
and Marking Systems



TIPO D range
CNC Punching, Drilling
and Cutting Lines



KRONOS range
CNC High definition Plasma
and Oxy Cutting Systems



TIPO G range
CNC Drilling, Marking and
Thermal Cutting Systems



TIPO B range
CNC Punching, Marking and
Thermal Cutting Systems



TIPO C range
CNC Punching, Drilling and
Thermal Cutting Systems



GEMINI range
CNC Drilling, Milling
and Thermal Cutting Systems



ANGLE
AND FLAT
PROCESSING



A range
CNC Punching, Drilling,
Marking and Shearing Systems



SP range
Super Performance
CNC Punching and Shearing Systems



HP range
CNC Punching, Drilling, Notching,
Marking and Shearing Systems



XP range
High performance CNC Punching
and Shearing Lines



RAPID range
CNC Drilling, Marking
and Cutting Systems



SURFACE
TREATMENT



Shot blasting System
Surface treatment systems

A drive to constantly improve, to meet increased demands for higher efficiency and throughput, has made FICEP a global leader for the past 88 years.

Don't just take our word, ask our customers...
FICEP equipment owners have seen the results, with unmatched reliability and increased productivity.

Call and let us show you solutions designed specifically for your operation.



FICEP Corporation
2301 Industry Court, Forest Hill, Maryland 21050
Phone (410) 588-5800
Fax (410) 588-5900

www.ficepcorp.com

As a fabricator, time is money, and the margin for errors is non-existent. FICEP Corp. understands and is prepared to help you achieve higher through-put with greater control and precision.

Contact us for solutions that increase your productivity, and join fabricators across the globe who trust the world's leader in steel processing equipment.

- 1 **c.** It depends. HSS is produced from plate. The 0.93 factor is from HSS plate production lower-bound tolerances. This factor is applicable for the more common ASTM A500 HSS standard. Additional HSS standards approved for use under this *Specification*, such as ASTM A1085 and A1065 allow the full wall thickness to be used.
- 2 ASTM A500 Grade C has increased strength and can be specified using pipe dimensions. Also, because A500 Grade C meets the requirements of Grade B and is more commonly produced, it is likely that you will receive Grade C regardless of what you specify. ASTM A53 requires pressure testing, which increases the overall cost. The April 2018 SteelWise article "Are you properly specifying materials?" (at www.modernsteel.com) provides additional guidance. That said, any of these materials could be a viable option. An experienced fabricator can help you determine what material specification would be most economical for your project.
- 3 Here are a few: Plastification of the chord connecting face, uneven load distribution, sidewall local yielding, crippling and buckling. The Commentary to Section K4 of the *Specification* provides more guidance.
- 4 The introductory language to Chapter K – Additional Requirements for HSS and Box-Section Connections states: "This chapter addresses additional requirements for connections to HSS members and box sections of uniform wall thickness, where seam welds between box-section elements are complete-joint-penetration (CJP) groove welds in the connection region. The requirements of Chapter J also apply." Limits states that apply to both HSS and wide-flange sections were consolidated in the 2016 *Specification*. Relevant sections include J10.1, J10.2 J10.3, J10.5 and J10.10.
- 5 **False.** Table K3.1 shows that Q_r is equal to 1.0 for chords in tension and is dependent on the utilization factor U when in compression.
- 6 **False.** The User Note in Section F7.4 states: "In HSS sizes, deflection will usually control before there is a significant reduction in flexural strength due to lateral-torsional buckling. The same is true for box sections, and lateral-torsional buckling will usually only be a consideration for sections with high depth-to-width ratios."
- 7 **b,** 2.31 sq. in., is the correct answer. Using the equations provided for case 6 in Specification Table D3.1: $B = 3$ in.; $H = 5$ in.; $\bar{x} = [3^2 + (2 \times 3 \times 5)]/[4 \times (3 + 5)] = 1.22$ in.; $U = 1 - (1.22/5) = 0.76$.
Taking the net area as the gross area found in Table 1-11 in AISC *Steel Construction Manual* (www.aisc.org/manual) minus the area of the plate and gap: $A_n = 3.06$ in.², Equation D3-1 yields $A_e = 2.31$ in.²



STEEL SOLUTIONS CENTER

If you are interested in submitting one question or an entire quiz, contact AISC's Steel Solutions Center at 866.ASK.AISC or solutions@aisc.org.

Why Weld?

SidePlate

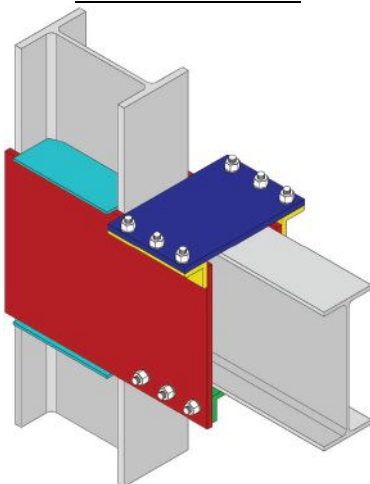

- AISC 358 Prequalified
- All Field Bolted
- Expedited Erection
- Design Flexibility
- Steel Savings
- Minimized Connections

SidePlate PLUS

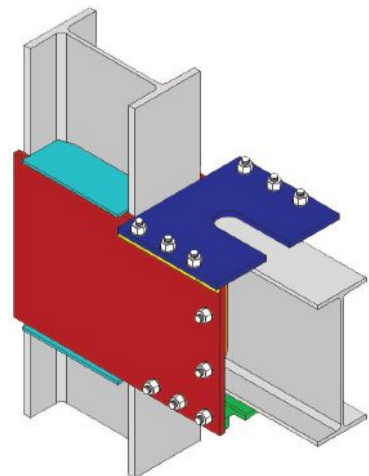

Contact SidePlate for a no-cost evaluation of your project.

www.sideplate.com

MiTek
SIDEPLATE[®]
Optimized. Minimized. Simplified.

949-238-8900
info@sideplate.com

DOWCO

GROUP OF COMPANIES

WE ARE
OBSESSED
IN A

BIM WAY!



VANCOUVER CONVENTION CENTER EXPANSION PROJECT

GENERAL CONTRACTORS & ENGINEERS

WE CAN ENSURE THAT YOUR STEEL STRUCTURE IS FABRICATED, AND ERECTED SOONER, ACCURATELY AND EFFICIENTLY.

Without quality 3D modeling and detailing early in the design phase, your projects are destined to fail.

49

49 YEARS EXPERIENCE
DETAILING FOR SOME
OF THE WORLD'S
MOST ICONIC
STRUCTURES!

PARTNER WITH DOWCO TO PROVIDE
THE MOST DEVELOPED AND DETAILED
VIRTUAL MODELS FOR DESIGN,
FABRICATION AND CONSTRUCTIBILITY.

CONTACT US TO LEARN MORE ABOUT DOWCO AND
ITS NEARLY 5 DECADES SERVING THE STEEL INDUSTRY.

DOWCO.COM
INFO@DOWCO.COM



"A must read!"

—Charlie D. Pug

Bone up on steel design with your very own copy
of the 15th Edition *Steel Construction Manual*!



Learn more about the 15th Edition *Steel Construction Manual* and all of AISC's great manual-related resources at www.aisc.org/manualresources.

ORDER YOURS TODAY!

\$200 Members | \$400 Non-Members

www.aisc.org/publications

800.644.2400



Smarter. Stronger. Steel.

American Institute of Steel Construction
312.670.2400 | www.aisc.org

A look at yield-line analysis and how to use it to determine flexure limit states.

steelwise STATED LIMITS

BY CARLO LINI, PE

TRANSVERSE FORCES got you bent out of shape? Fear not!

A new section was added (Section J10.10) to the 2016 AISC *Specification for Structural Steel Buildings* (ANSI/AISC 360, www.aisc.org/specifications) to address transverse forces on plate elements. One example would be an axially loaded single-plate connection to a column web or HSS wall (see Figure 1 on the next page) where flexure and shear limit states will need to be considered. And one way to approach checking the flexure limit state is to perform a yield-line analysis.

The 15th Edition AISC *Steel Construction Manual* (www.aisc.org/manual) provides equations in Part 9 for commonly used yield-line patterns that provide users with strengths without having to go through the additional work of deriving a solution. In fact, you can find many yield-line solutions for specific conditions provided throughout the years in AISC's quarterly *Engineering Journal* (a free download for AISC members at www.aisc.org/ej). Yet the concern with providing simple, easy-to-use equations is that it may be tempting to plug and chug numbers to get the job done before one has a solid understanding of what it is that they are checking. This article will discuss the basics of a yield-line analysis. In addition, go to www.aisc.org/yieldvid to see a video on how to use the free drawing program Google SketchUp to check yield-lines. The video may also aid you in visualizing this method of analysis.

What is a yield-line analysis?

A yield-line analysis involves the determination of a failure pattern. This requires some engineering judgment since there could be a multitude of possible failure patterns, and some of these patterns can overestimate the strength.

Once a pattern is determined, a plastic hinge is assumed to develop along the yield-lines of this failure pattern. The external work that is done by an applied force over some amount of displacement is then set equal to the internal work which is determined by the amount of rotation that occurs along the plastic hinges. The applied force (available strength) can then be determined. Note that a yield-line analysis is an upper-bound solution. That means that the correct solution will result in the lowest available strength (see Table 1 at right).

Before we demonstrate this with a simple example, please note that the following simplification will be used: For very small angles, we can take the angle, θ (unit in radians), as equal to the deflection divided by the length (see Figure 2, next page).

For a simple-span beam, it is commonly known that the maximum point load that can be applied at the midpoint is based on $M = PL/4$ where $M = F_y Z$. When the load P is such that the resulting moment reaches the plastic strength of the beam, $F_y Z$, a hinge will form. In the case of a simple-span beam, a single hinge at the center will result in a failure. The maximum load, P , that can be applied is equal to $4ML$.

When performing a yield-line analysis, we compare the external work, W_{ext} , to the internal work, W_{int} . They must be equal. For a simple span beam, a load P is applied and the beam will deflect by some amount, δ (see Figure 3, page 19). The external work is equal to $P\delta$. The internal work is equal to the flexural strength of the member and the amount of rotation it undergoes. So we can say that $P\delta = M \times \text{rotation}$. Keep in mind that for small rotations, the angle, θ , is equal to δ/Length .

Figure 3 illustrates how the commonly known equations for a simple-span beam and a fixed-fixed beam with a point load placed at midspan can be derived. A yield-line analysis is very similar to what is shown in Figure 3, except that the moment, M , which would be based



Carlo Lini (lini@aisc.org) is AISC's director of technical assistance.

u (in.)	W_{int} (kip-in.)	R_n (kip)
1.00	131.25	131.25
1.50	95.31	95.31
2.00	78.13	78.13
2.50	68.44	68.44
3.00	62.50	62.50
3.50	58.71	58.71
4.00	56.25	56.25
4.50	54.69	54.69
5.00	53.75	53.75
5.50	53.27	53.27
6.00	53.13	53.13
6.50	53.25	53.25
7.00	53.57	53.57
7.50	54.06	54.06
8.00	54.69	54.69
8.50	55.42	55.42
9.00	56.25	56.25
9.50	57.15	57.15
10.00	58.13	58.13

Table 1. Internal work as a function of u .

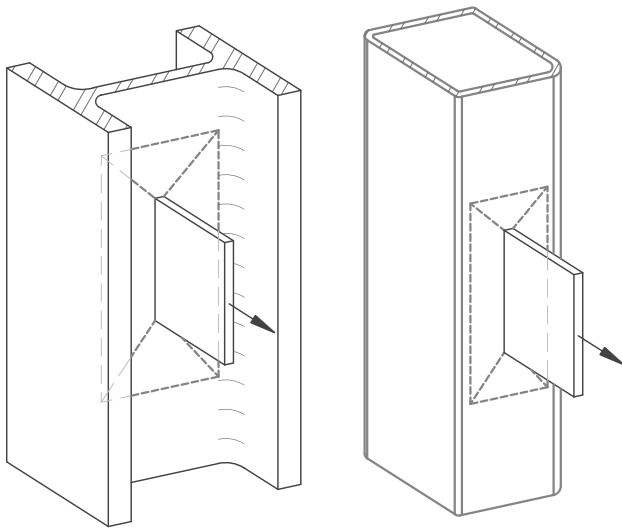

Figure 1. Yield-lines due to transverse forces on plate elements

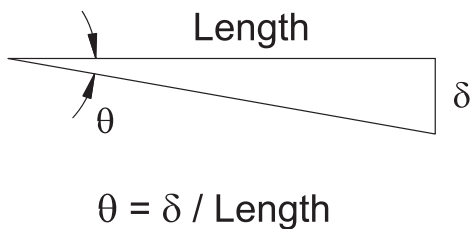
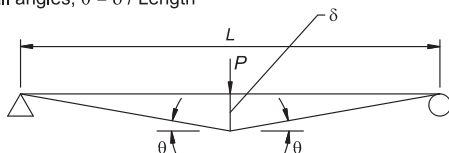

Figure 2.

Simple Span Beam

For small angles, $\theta = \delta / \text{Length}$



$$\text{External Work} = W_{\text{ext}} = P \times \delta$$

$$\text{Internal Work} = W_{\text{int}} = M \times \text{rotation} = M \times 2\theta$$

$$\begin{aligned} M \times 2\theta &= P \times \delta \\ M \times 2 \left[\frac{\delta}{L/2} \right] &= P \times \delta \\ M \times 4/L &= P \longrightarrow M = PL/4 \end{aligned}$$

Fixed Span Beam

For small angles, $\theta = \delta / \text{Length}$

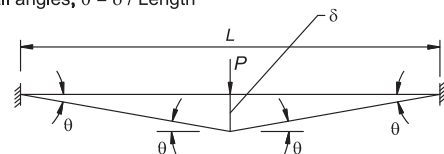

$$\text{External Work} = W_{\text{ext}} = P \times \delta$$

$$\text{Internal Work} = W_{\text{int}} = M \times \text{rotation} = M \times 4\theta$$

$$\begin{aligned} M \times 4\theta &= P \times \delta \\ M \times 4 \left[\frac{\delta}{L/2} \right] &= P \times \delta \\ M \times 8/L &= P \longrightarrow M = PL/8 \end{aligned}$$

Figure 3.

on the plastic section modulus for a beam, would instead need to be calculated based on the section modulus of the plate. The plastic section modulus of the plate would depend on the length of the yield-line based on the pattern that has been assumed.

Manual Equation

As stated above, the 15th Edition *Manual* now includes equations that can be used to evaluate plate elements subjected to out-of-plane loads. This information is provided in the *Manual* to help engineers determine the strength plate elements relative to the requirements in Section J10.10 of the *AISC Specification*. Let's take a look at Equation 9-31 in the *Manual*, which can be used to evaluate out-of-plane transverse loads on column webs of wide flange sections. Note that the edges of the column web are assumed to be pinned. The variables in this equation are illustrated in Figure 4, which is recreated from Figure 9-5 in the *Manual*. Note that a variable, u , is added to Figure 4 though this dimension is not included in *Manual* Figure 9-5.

$$R_n = \frac{t_w^2 F_y}{4} \left[\frac{4\sqrt{2Tab(a+b)} + L(a+b)}{ab} \right] \quad (9-31)$$

Pre-simplified equation

Equation 9-31 has been simplified to make it easier to use. Assuming a and b dimensions are equal, this same equation can also be written as:

$$\begin{aligned} W_{\text{int}} &= M_p \theta \\ &= \frac{t_w^2 F_y}{4} \left[\frac{2T \frac{\delta}{u} + 2L \frac{\delta}{a}}{+4\sqrt{a^2 + u^2} \left(\frac{\delta\sqrt{a^2 + u^2}}{au} \right) + 2c \frac{\delta}{u}} \right] \end{aligned}$$

The yield-line lengths in the equation above has been color coded to more easily identify with the representative yield-lines in Figure 4. The portions that have not been highlighted in the bracketed portion of the equation represent the rotation of each of those specific yield-lines.

Example

Let's solve a problem using the pre-simplified equation and compare the results to ones obtained using Equation (9-31) provided in the *Manual*.

Given: $t_w = 1/2"$, $F_y = 50$ ksi, $T = 9"$, $a = b = 4"$, $c = 1"$, $L = 10"$, $u = \text{unknown}$

The variable, u , is listed as unknown. A number for u needs to be determined such that the lowest strength of the yield-line pattern is obtained. Remember that a yield-line analysis provides an upper-bound solution. The equation in the *Manual* solved for the value, u , and it is incorporated into its derivation. An Excel spreadsheet will be used here to determine the lowest value using the pre-simplified equation. Table 1 lists both the internal work and the nominal strength, R_n , which are displayed graphically in Figure 5. The internal work and nominal strength values are the same since the deformation selected, δ , is equal to 1 in.

$$W_{int} = \frac{1/2^2(50)}{4} \left[2 \left(9 \times \frac{1}{6} \right) + 2 \left(10 \times \frac{1}{4} \right) + 4 \sqrt{4^2 + 6^2} \left(\frac{1 \sqrt{4^2 + 6^2}}{4 \times 6} \right) + 2 \left(1 \times \frac{1}{6} \right) \right]$$

$$= 53.13 \text{ kip-in.}$$

$$W_{int} = 53.13 \text{ kip-in.} = W_{ext} = R_n \delta = R_n \times 1 \text{ in.}$$

$$R_n = 53.13 \text{ kips}$$

Solve using Equation 9-31:

$$R_n = \frac{(50 \text{ ksi})(0.5 \text{ in.}^2)}{4} \left[\frac{4 \sqrt{2(9 \text{ in.})(4 \text{ in.})(4 \text{ in.})(4 \text{ in.} + 4 \text{ in.})} + (10 \text{ in.})(4 \text{ in.} + 4 \text{ in.})}{(4 \text{ in.})(4 \text{ in.})} \right]$$

$$R_n = 53.13 \text{ kips}$$

As can be seen in Table 1, the lowest value matches the strength obtained from Equation 9-31. Also notice that for a wide range of u values, the strength value returned is still reasonably close to the minimum strength. This indicates that it may be possible for a designer to select a u value based on their own judgment to approximate the strength. This may be useful for conditions where closed-form yield-line equations have not been published and the demand is much lower than the approximated strength. Engineering judgment would need to be exercised with this approach. Note that assuming a u value based on a 45° distribution in the example above would have provided a nominal strength of 56.25 kips vs. 53.13 kips, a predicted strength that is about 6% higher than the correct prediction.

Though such approximations may be sufficient for many conditions encountered in practice, finding a closed-form solution that can be applied to a wide range of conditions has certain benefits and can be accomplished with some rudimentary calculus.

Geometry can also be a challenge when it comes to performing a yield-line analysis. For example, how does one determine the amount of rotation that occurs on the diagonal yield-lines in Figure 4. This can be done mathematically. The book *Design of Welded Structures* by Omer Blodgett provides a method for determining this rotation. Another possible approach is to use a 3D modeling program (like Google SketchUp).

Please keep in mind that the intent behind this article is to help gain a better understanding of the yield-line analysis method. It is important for the designer to remember that transferring load transverse to plate elements is generally not an ideal load path and should be avoided when possible. Sometimes this is not possible and, for these situations, a yield-line analysis can be used to determine that a plate element has sufficient strength. Stiffness and serviceability may also be important considerations when transferring load transverse to plate elements. One limitation of the yield line approach is that it does not produce the deformation associated with the strength meaning that it cannot be used to directly determine deflection or stiffness. ■

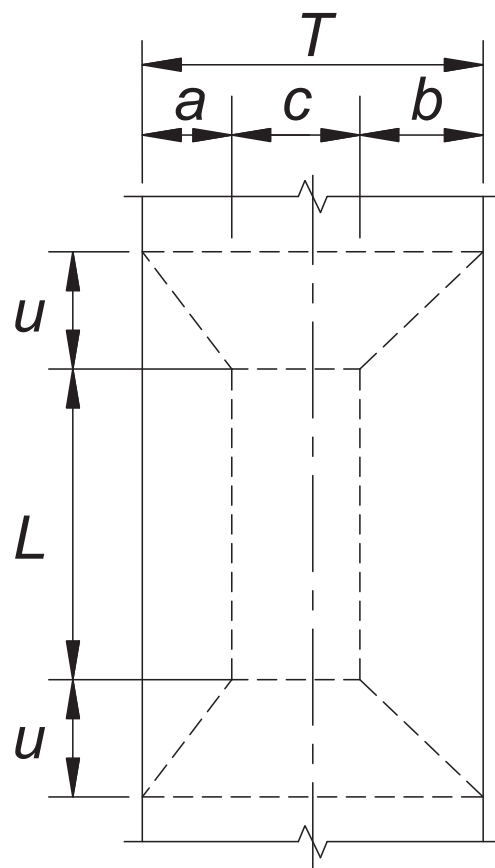

Figure 4. Transverse load.

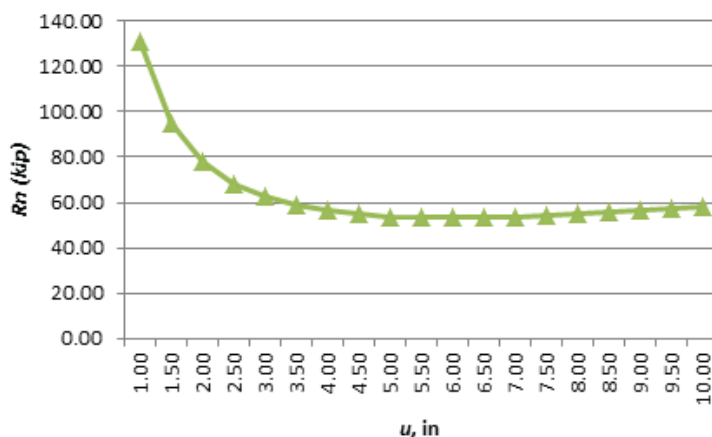

Figure 5.

business issues

ONE-ON-ONE

BY JEFFREY W. FOLEY



Jeff Foley is a professional speaker, executive leadership coach and author of *Rules and Tools for Leaders*. He is a West Point graduate and retired as a Brigadier General, having served 32 years in the U.S. Army. Drawing on his unique military experience, Jeff uses his singular insight to build better leaders. For more on Jeff, visit www.loralmountain.com.

Individual coaching—when done properly—is the most effective way to develop your people.

ONE-ON-ONE COACHING IS one of the most important skills a great leader must possess.

Effective coaching inspires in others an internal drive to act ethically, without direction, to achieve goals. It drives performance, builds competence and confidence, and ultimately enhances relationships. The best coaches help people find ways to make things happen as opposed to creating excuses for why they can't.

Effective coaching also requires you to believe in yourself. You need to believe that you can have an impact in the workplace, and that you can inspire others to achieve their goals they might not otherwise achieve. The real question is not if you will make a difference, but what difference you will make.

Respectful, transparent and regular face-to-face communication between leaders and their people breaks down barriers and builds trust. What you can see in a person's eyes or other body language can be revealing. While technology can be effective at times, it will never replace human contact for discovery and inspiration.

The most impactful leaders are adept listeners and don't allow their egos to become roadblocks. When egos are alive and well, listening ceases, effective coaching environments disappear and organizations suffer.

Here are three recommendations that can help you raise the bar on your ability to coach others.

1. Create a positive and open environment for communication. People listen to and follow leaders they trust. They engage in meaningful dialog with people they trust. They are not afraid to disagree with people they trust. Trust provides the foundation for a positive and open communication environment where connections between people can thrive.

Knowing your people reduces the probability of promoting someone into a management position who does not want it or is not otherwise qualified.

When people connect, they learn about each other. They enable understanding of cultures, individual strengths and challenges. Knowing your people's unique capabilities and desires helps focus on how to help them be successful.

Knowing your people also reduces the probability of promoting someone into a management position who does not want it or is not otherwise qualified. Not all physicians want to be managers. Not all sales people want to be sales managers. Not all technicians want to be a shop foreman. The costs can be exorbitant to an organization that wrongly promotes someone into a management position.

There are three questions that can help establish this open line of communication: What is on your mind? What can I do for you? What do you think? How am I making your life more difficult? When asked with the genuine interest, people respond with more honesty.



Meet with your people regularly helps break down barriers. Not just in your office, but on the manufacturing floor, outside the operating room, in the cafeteria, or the warehouse. Talk to folks outside the work area like the jogging track, grocery store or the kid's soccer game. The informal sessions can be wonderful enablers of opening the line of communication.

2. Establish agreed upon goals and strategies to achieve. Most people want to know what success looks like. They want to be clear in their goals as an individual and, if appropriate, the leader of a team. Well-defined, measurable, relevant goals on paper help people gain clarity on success for them. Assigning responsibility with authority helps inspire an individual's commitment to be successful.

Success also includes how to reach their goals. Strategies are developed and agreed upon by the manager and team member so that both understand each other's roles. The probability of success increases dramatically when strategies and accountabilitys are well defined.

3. Enforce accountability by assessing performance. There are many and significant consequences when people are not held accountable for achieving goals or otherwise performing to standard. Integrity disappears. Discipline erodes. Morale evaporates. Leaders are not taken seriously. Problem employees become a cancer in the organization. The

best people leave. Results are not achieved.

Effective coaching demands assessment of performance. Without this assessment, no system of accountability will be achieved. If the senior leader does not hold his or her executive team accountable, subordinate leaders are likely to think, "Why should I?"

Consistent, regularly scheduled coaching sessions with your people are the key to ensuring effective follow-up assessments to celebrate successes and identify areas to improve.

Coaching Agenda

Coaching session agendas will vary based on a variety of conditions. A good place to start is outlined below.

First, review the individual goals and those of the organization. Ensure alignment of both to clarify where the individual is contributing to the mission of the organization.

Second, discuss what is going well. Where do both the coach and the individual agree on successes? Provide positive recognition for achievements where important.

Third, discuss the challenges or areas for improvement. Underwrite honest mistakes in the pursuit of excellence so people can learn. Determine how you as the manager can help. Gain a clear understanding of the shortfall in the individual's ability and desire to achieve the goal and what resources or assistance the individual needs to be suc-

cessful. When unsatisfactory performance occurs, managers must address it. Leaders who never take action to remove an underperformer are doing a great disservice to their institution. All too often, good people serving in leadership positions fear the task of confrontation. They hope, magically, that something will happen which will turn the underperformer around and all will be well in the end. Hope is not a strategy; the magic seldom happens. Your goal as a leader and coach is to inspire a willingness to succeed. When coaching, it is often easier to criticize and find fault. Think before you speak. Find ways to praise.

Finally, as the manager, seek suggestions for how you can be a more effective leader for them. This question can change the dynamic of the coaching session and can provide powerful feedback for the manager in his or her quest to be the best they can be. Doing so will enhance their trust in you and help build confidence in their own capabilities.

Remember, effective one-on-one coaching can be the catalyst for attracting and retaining the best people, and that will ultimately help your organization to unprecedented results. ■

Have you had success with one-on-one training? What do you see as benefits and drawbacks? We'd love your feedback! Send your thoughts to melnick@aisc.org.

Design-Assist and the AISC Code

BY CHARLES J. CARTER SE, PE, PHD

A formal interpretation and related thoughts.



Charles J. Carter (carter@aisc.org) is AISC's president.

THE TERM "DESIGN-ASSIST" CURRENTLY does not have a standardized definition. Nonetheless, it is appearing with increasing frequency today in steel fabrication contract documents that call for collaboration and the early involvement of the structural steel fabricator.

The AISC Committee on the Code of Standard Practice is working proactively with collaborators at the American Institute of Architects (AIA) to develop a standardized, consensus definition of the term. These discussions are still in progress but already have identified many complex issues related to the design-assist concept of early involvement. We also expect to broaden our discussions to involve other appropriate organizations.

The AISC Committee on the Code of Standard Practice was asked if the *Code of Standard Practice for Steel Buildings and Bridges* (ANSI/AISC 303, the "CoSP"; www.aisc.org/code) is applicable to design-assist projects. Following is the formal interpretation provided by the Committee in answer to that question:

Does ANSI/AISC 303 Code of Standard Practice (the CoSP) apply to design-assist and other forms of collaboration? Yes, the Committee affirms that the provisions of the CoSP apply to all projects that involve fabricated structural steel. The CoSP is the recognized statement of custom and usage in the fabricated structural steel industry in the United States. Portions of the CoSP are also incorporated by reference into the *International Building Code* (IBC) and all state and local building codes that adopt the IBC; see www.aisc.org/303IBC.

The foregoing was issued in AISC General Bulletin #2467 on January 2, 2019, which also stated the following:

The AISC Committee on the Code of Standard Practice is a balanced, ANSI-accredited standards-developing committee. It has equal representation of designers, industry and general interest participants. It is responsible for the ongoing development of ANSI/AISC 303: *Code of Standard Practice for Steel Buildings and Bridges* as a consensus American National Standard, and is the sole entity with the authority to provide official interpretations of it.

Several thoughts merit mention in relation to this formal interpretation:

- Generally speaking, and focusing only on contracts to fabricate or fabricate and erect structural steel, a design-assist contract involves a structural steel fabricator actively participating in a project as the structural design work is evolving. As such, design-assist is a form of early project collaboration between the various parties.



Courtesy: Ruby+Associates

- The participating fabricator usually is asked to comment upon and provide input on the constructability of the design and suggest where efficiencies can be gained through modifications of the design.
- In some instances, that fabricator also is asked to provide preliminary pricing based upon the partial, in-progress design information that is current at the time the design-assist contract is executed.
- The structural design in a design-assist contract is expected to evolve as the project moves forward and is finalized.
- The role and responsibilities of the owner's designated representative for design (ODRD) are clearly defined in the CoSP and do not change with design-assist collaboration.
- The structural steel fabricator does not assume the responsibilities of the ODRD as that term is defined in the CoSP.
- The owner can realize significant benefits through use of early involvement, and early involvement can work to the advantage of all participants.
- However, the lack of a standardized, consensus definition of design-assist as a term means caution should be exercised when considering contract documents that specify a design-assist approach to collaboration and the early involvement of the fabricator.
- Changes in the member and connection designs, as well as in the scope and nature of the work, are likely to result in

changes in the pricing and schedule of the fabricated structural steel work.

- The CoSP establishes mechanisms that are recognized in the industry to develop appropriate and equitable contract price adjustments for such changes in all contracts, including design-assist contracts.

There are fundamental questions that should be raised, answered and clearly documented when engaging in a design-assist contract, including the following:

- Do the contract documents provide a clear definition of the expectations and responsibilities of all parties?
- Do the contract documents explicitly recognize that an evolution likely will occur in the design work after the design-assist fabricator is contracted?
- Do the contract documents make clear how and when all requirements stated in Section 3.1 of the CoSP will be defined in the design documents?

The parties to a contract that leave these questions unanswered are all exposing themselves to the potential consequences of misunderstandings and diverging expectations. The parties that use them to foster a mutual understanding and develop consistent expectations can all reap the benefits and rewards of early involvement. Those collaborators all can manage their own risks and not be asked to bear risks that are shifted to them unexpectedly by another party. ■

Aloha, Steel

BY JAMES SAVAGE, SE, PE



James Savage (james.savage@hdrinc.com) is a professional associate and senior structural engineer with HDR in Omaha.

HAWAII MAY SWEEP visitors off their feet, but it certainly keeps designers and builders on their toes.

It is one of the few places in the U.S. where structures experience both very high winds and very high seismic forces. And its material and labor costs are high compared to the continental U.S. Fortunately, structural steel can successfully address these issues, as demonstrated by a new addition to the Kapi'olani Medical Center for Women and Children.

The hospital's new Neonatal Intensive Care Unit (NICU)/Pediatric Intensive Care Unit (PICU) Tower is the first major hospital project on the medical campus since the early 1970s, providing 192,142 sq. ft of space in one below-grade and six above-grade levels. And it was designed with the option to expand vertically by three floors.

From Mainland to Island

During the pre-design phase, both steel and concrete systems were explored for pricing and constructability. Concrete is traditionally more prominent in Hawaii construction, but the design team determined that a structural steel system would be less expensive than a concrete system. As such, the framing system employs standard ASTM A992 Gr 50 steel beams and columns for the typical floor construction and 4.5 in. of normal-weight concrete on 2-in.-deep composite metal deck. Typical purlins are W16×31 wide-flange beams. Typical girders are part of the lateral load-resisting system and ranged from W30 to W36 wide-flange beams. The moment frame columns are W36 columns at the base, transitioning to W30 columns above, and the gravity columns are W14s.

While all structural steel was fabricated on the mainland—by Supreme Steel in Portland, Ore.—and had to be shipped thousands of miles to the project site on Oahu, early



Copyright 2017 Dan Schwalm - HDR

Steel successfully addresses all of the typical challenges of building in the Aloha State in the form of a new hospital tower in the capital city of Honolulu.

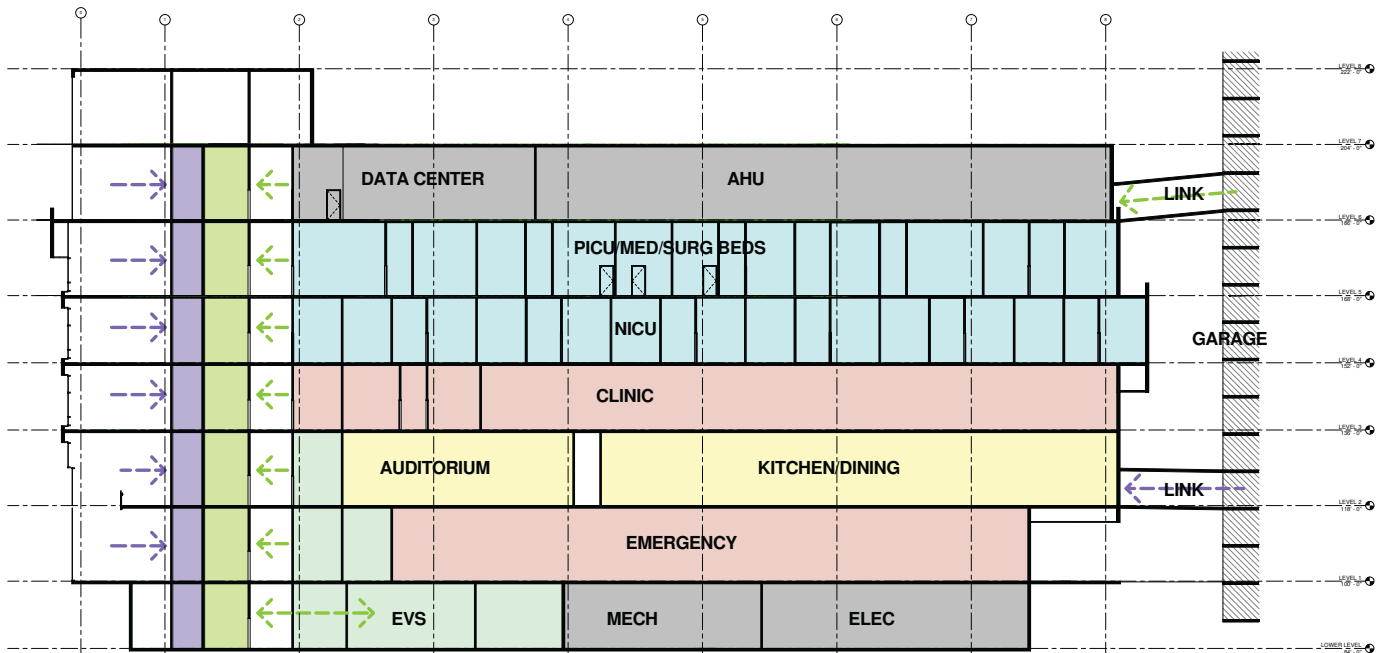
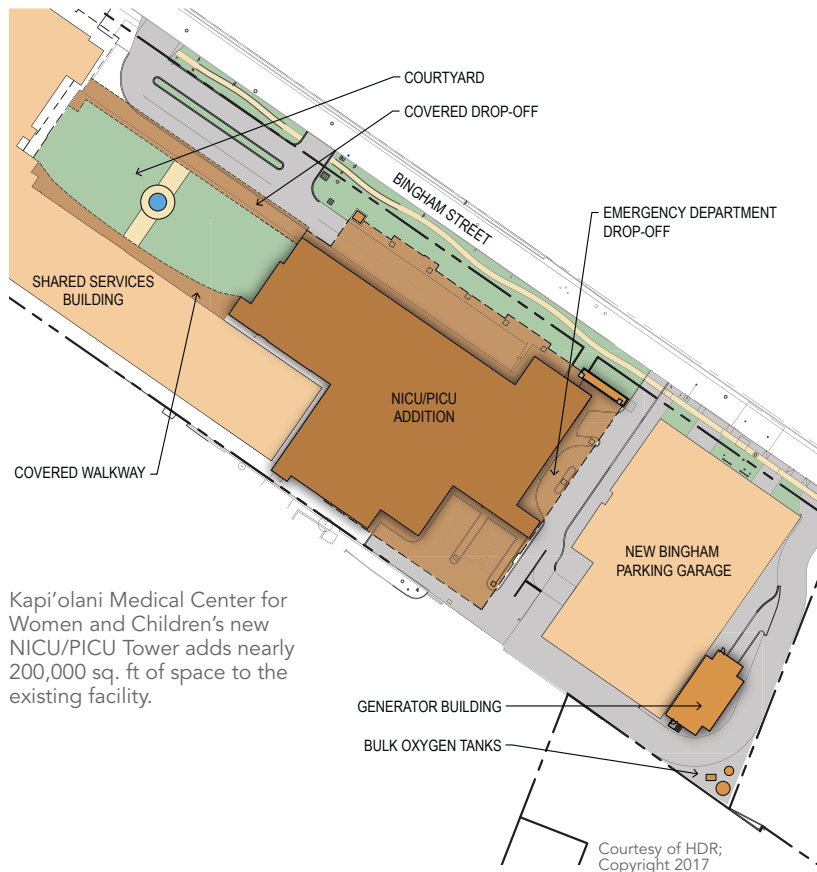

Courtesy of HDR; Copyright 2017

coordination and planning made for smooth sailing. Member lengths were designed to fit within the shipping containers, and structural drawings were completed and coordinated far in advance to accommodate transit times. The entire building structure, including miscellaneous steel, uses nearly 2,700 tons of steel.

Steel was also optimal for the required spans. The code-required minimum dimensions for the patient rooms required bay sizes of 32 ft by 34 ft, and the design also called for a 20-ft cantilever over the loading dock. This bay sizing and cantilever would have required overly heavy, massive concrete framing, thus ruling out concrete as an option from a financial standpoint. In addition, the lower mass of the steel framing scheme helped reduce the seismic loads, resulting in additional savings.

Special Lateral Solution

Following selection of the main framing system, the team had to determine the best

lateral system for the project and evaluated three options: special concrete shear walls, special concentric braced frames and special steel moment-resisting frames. The special concrete shear walls were eliminated for several reasons. First, the lateral forces would have been concentrated on a few foundation elements underneath the shear walls, which would increase foundation costs. The diaphragm forces would also be higher in concentrated areas around the special concrete shear walls. In addition, the system would have increased the construction schedule due to the time needed to form and pour the concrete walls ahead of steel erection. Finally, it would have also increased the lateral load due to a lower *R*-value when compared to a special steel moment-resisting system.

The special concentric braced frames were also ruled out. Based on the architectural floor plans, there were not enough bracing locations available without impacting the functionality of the floors. While these architectural constraints could

possibly have been overcome, this option was still not desirable due to reduced flexibility in future remodels. And similar to special concrete shear walls, the special concentric braced frames also concentrated lateral loads in the areas of the bracing, thus increasing foundation costs.

Special steel moment frames, on the other hand, offered multiple advantages. First, they could be placed more uniformly across the floor plate, which would allow for more even distribution of lateral loads to the foundations and the diaphragms, thus making them more cost-effective. This system would also provide more flexibility for the architectural floor plan as well for potential future remodels.

Once the special steel moment-resisting frame system was selected, the team needed to find a cost-effective moment connection. While the SidePlate moment connection system had only been used once before in Hawaii, both architect/engineer HDR and general contractor Layton were familiar with the system, having successfully used



The new tower adds one below-grade and six above-grade levels and was designed with the option to expand vertically by three floors.

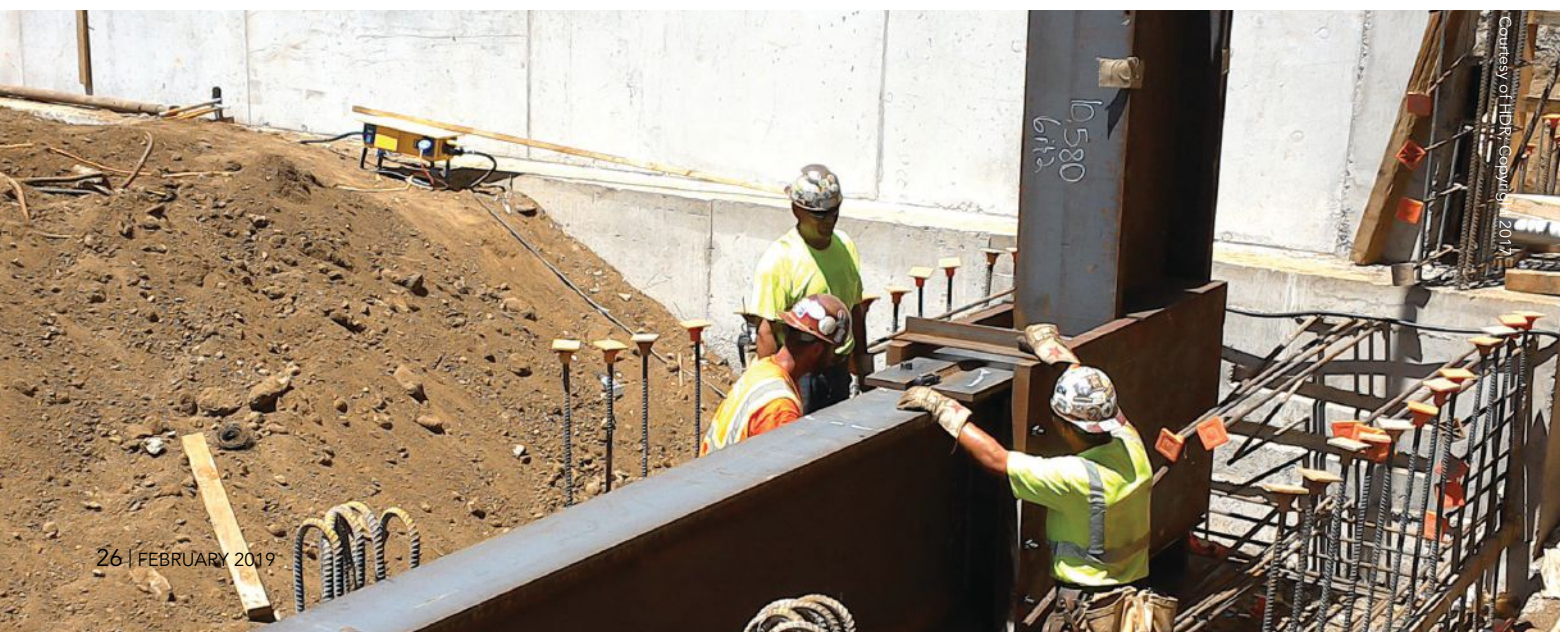

it on a number of previous projects on the mainland, and implemented it on the Kapi'olani project. The connection replaces field-welded complete-penetration welds with field-welded fillet welds, thus reducing time and inspection costs in the field. It also eliminates the need to notch the beam flanges of a dog-bone system by using plates on both sides of the column flanges.

The system offered other advantages as well. The side plates provided a stiffer beam-column moment connection, which meant the lateral inter-story drift limits could be met using less steel. This was beneficial for both wind and seismic loads. The system also results in a higher *R*-value, the seismic response coefficient. (When determining the seismic force acting on a building, the higher the *R*-value, the smaller the seismic force the building is required to resist. SidePlate provides an *R*-value of 8, the highest allowed by code. For comparison, special steel concentrically braced frames or special reinforced concrete shear walls provide an *R*-value of 6.)

It also offers a more uniform distribution of shear and overturning moment to the foundation system. And, it can reduce weight of the steel frame, allowing for additional savings resulting from shipping less steel to Hawaii from the mainland.

The tight, landlocked site was also challenging, but steel again proved to be the best solution. Thanks to the site's limited spacing, a loading dock had to be carved out of the base of the building. At the upper floors, steel beams addressed the 20-ft cantilever to allow access to the loading dock beneath the tower due to its ability to use shallower beams than a comparable concrete system; the framing orientation allowed for W27x84 purlins to cantilever versus 40-in.-deep concrete beams. At the lowest level, a drive lane cuts through the first-floor diaphragm, resulting in unbalanced soil load. A retaining wall around the perimeter of the lowest level removed the unbalanced soil pressure from being applied to the moment frames, which

allowed for significantly lighter moment frame members in the lower levels.

The end product of this nontraditional but highly successful use of steel framing in Hawaii is a magnificent new hospital tower that nearly quintuples the size of Kapi'olani's previous NICU. And it just may spark the beginning of a new life for steel construction in the Aloha State. ■

Owner

Hawaii Pacific Health

General Contractor

Layton Construction

Architect and Structural Engineer

HDR

Steel Team

Fabricator

Supreme Steel Portland



Detailer

Steel Systems Engineering, Inc.

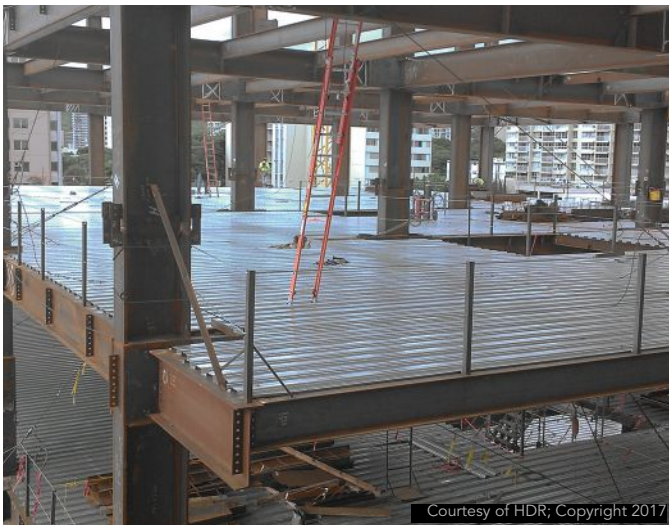

Courtesy of HDR; Copyright 2017

While concrete is traditionally more prominent in Hawaii construction, the Kapi'olani design team determined steel to be less expensive.



Photo Courtesy of HDR; Copyright 2017 Dan Schwalm

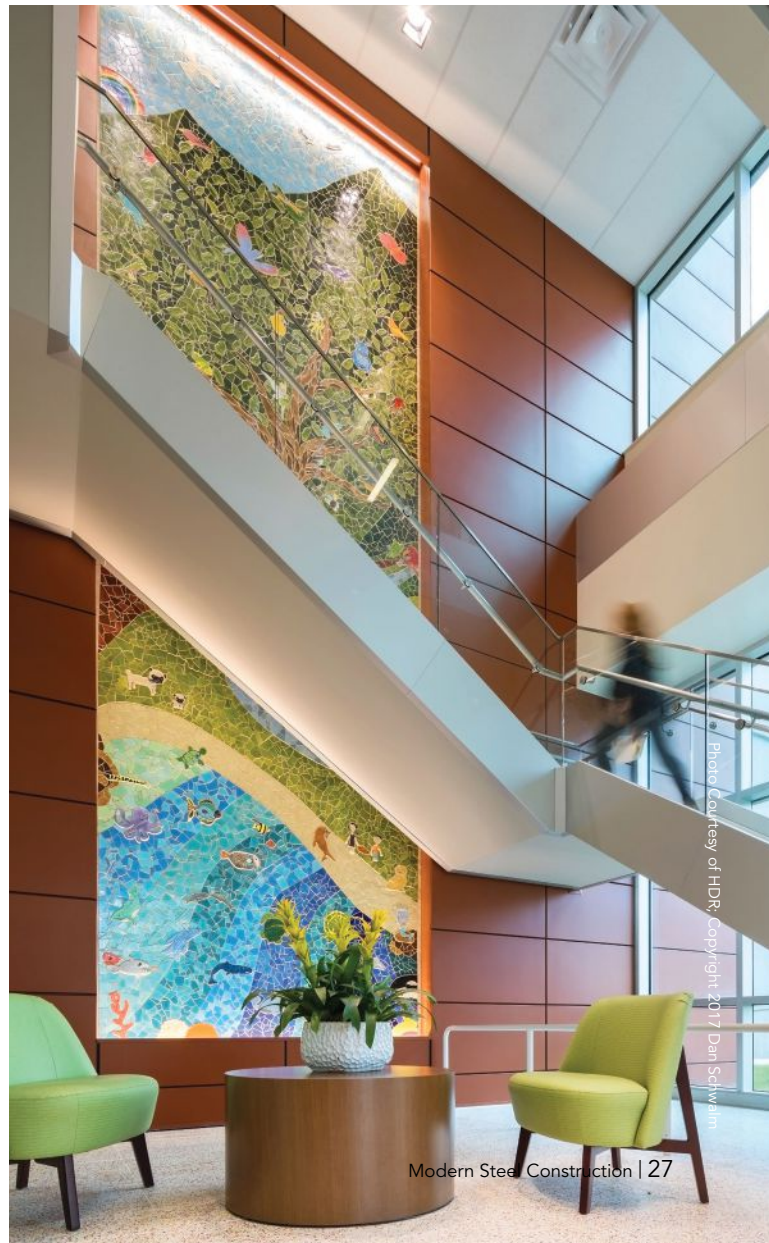

Photo Courtesy of HDR; Copyright 2017 Dan Schwalm

Healing Oasis

BY TIM HEIMAN, SE



© 2018 Tom Bonner



Tim Heiman (tim.heiman@kpff.com) is a newly retired principal with KPFF Engineers in San Francisco.

SHRINERS HOSPITALS' desire to meet California's new *CalGreen* sustainability requirements while still creating a striking architectural statement in a high-seismic zone led the designers to the obvious choice: steel.

The recently completed 74,800-sq.-ft Shriners for Children Medical Center in Pasadena replaces the original 1951 hospital, located in downtown Los Angeles, and serves as the Shriners organization's flagship facility in the region. Founded in 1920 by Shriners International, Shriners Hospitals for Children's mission is to provide the highest quality care to children under the age of 18 with neuromusculoskeletal conditions, burn injuries and other special healthcare needs within a compassionate, family-centered and collaborative care environment.

Shriners moved its medical center from Los Angeles to Pasadena after determining that a new steel-framed surgery center and clinic could be built for the same amount as it would cost to renovate and seismically upgrade its existing L.A. hospital. At the same time, Shriners was changing its business model from own-

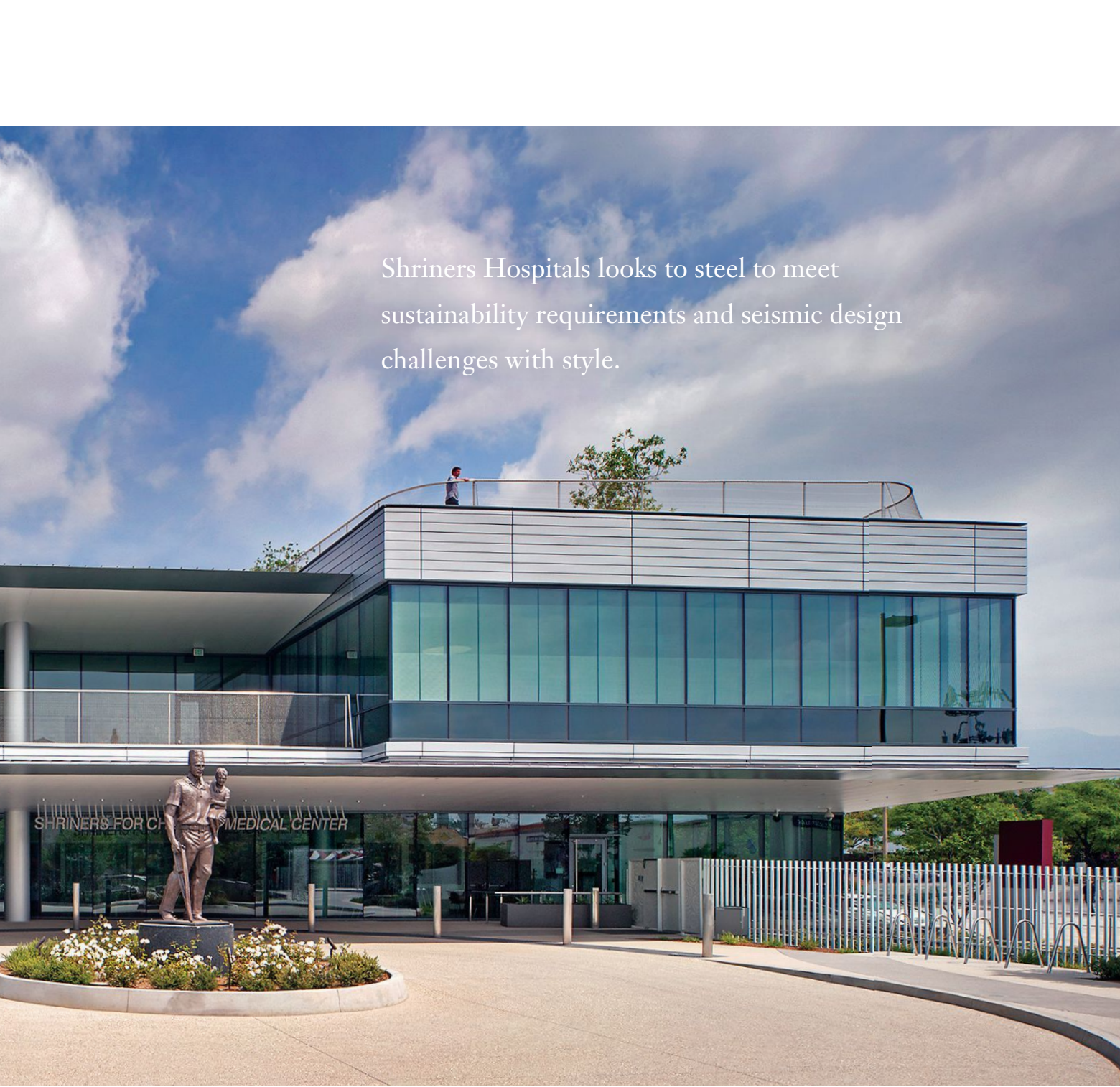

Shriners Hospitals looks to steel to meet sustainability requirements and seismic design challenges with style.

ing and operating acute-care hospitals to providing outpatient services and partnering with local hospitals to provide additional support. The Pasadena location near Huntington Memorial Hospital achieves this goal. In addition, the new medical facility is half the size of the L.A. hospital—but thanks to an efficient layout, is able to service three times the number of patients.

Designed to prioritize a healing connection to nature for patients, families and staff who spend extended time within its walls, the two-acre site is divided into

the medical building on the northern half of the property and therapeutic gardens and outdoor gathering areas on the south side. The contemporary architecture of sweeping horizontal planes, cantilevers and setbacks, along with region-sensitive landscape, is consistent with the modernist legacy of Pasadena. The medical center's glass-lined walls present an open and inviting character and reveal the activity within the building. The energy-efficient building was designed to meet *CalGreen* sustainability requirements, with steel's true cradle-to-cradle designation and high

recyclability and recycling rate contributing to the building materials portion.

The medical center consists of a three-story, 780-ton steel frame above a three-story concrete underground parking garage. Structural steel framing, with special moment frames as the lateral force-resisting system, was chosen to accommodate floor spans up to 50 ft and to provide an open exterior façade and programming flexibility for current and future architectural space planning.

The Pasadena location is in one of the most seismically active regions in California,

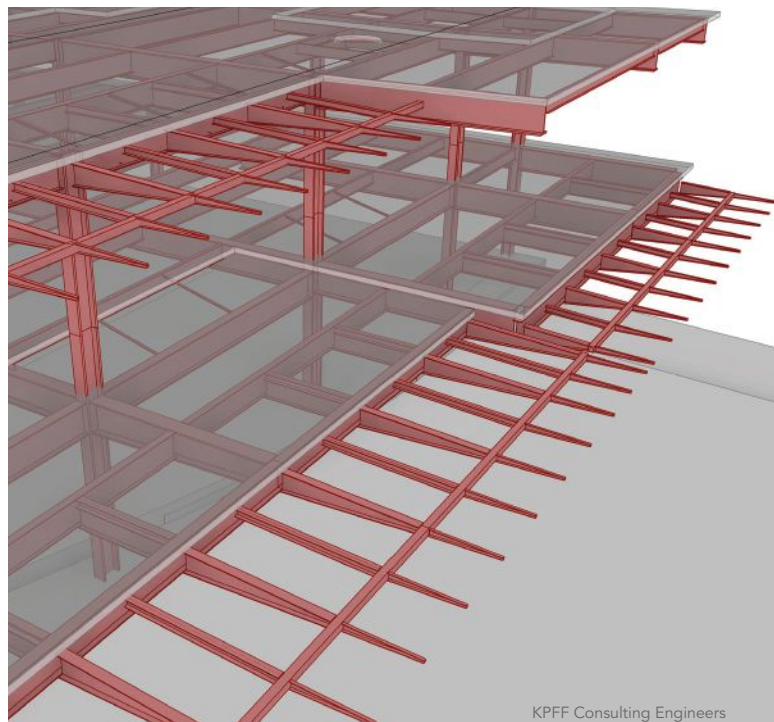
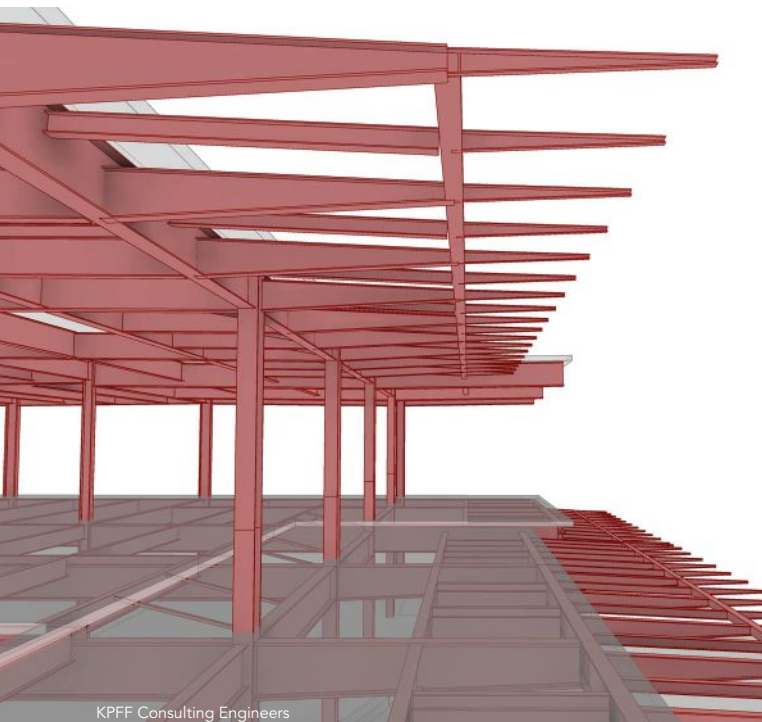

KPFF Consulting Engineers

KPFF Consulting Engineers

Multiple metal-clad canopies are supported with tapered wide-flange sections that transition to "knife blade" profile steel plates.



KPFF Consulting Engineers

The primary steel framing has 1-hour spray-on fireproofing. Canopy framing extending beyond the building envelope did not require fireproofing.

A detail of one of the steel-framed canopies.

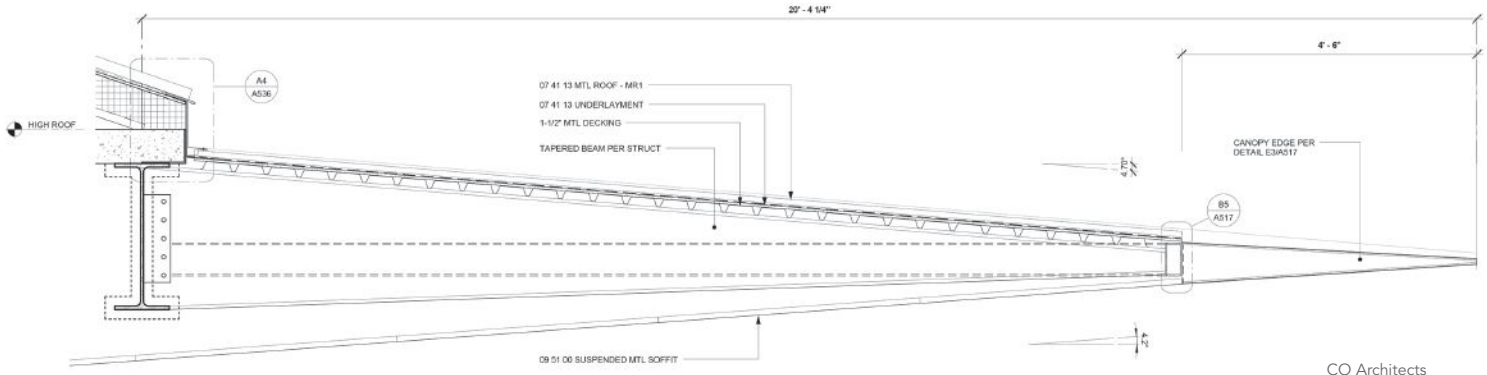

CO Architects

C1 LEVEL 3 CANOPY
1" = 1'-0"

with a site design level short period acceleration of 1.89g. The structural design was conceived in accordance with the *California Building Code (CBC)*, and moment frames using reduced beam section (RBS) connections were designed per the provisions of AISC's *Prequalified Connections for Special and Intermediate Steel Moment Frames for Seismic Applications* (ANSI/AISC 358, www.aisc.org/specifications). A structural steel solution yielded a lighter building than a comparable concrete structure, resulting in lower seismic loads and savings in the foundation. In addition to providing future flexibility, moment frames were chosen because of their superior ductility. While the building was designed for the life-safety objective of the *CBC*, the seismic performance of the building due to earthquakes exceeding code design level was a major consideration. Moment frame beams ranged from W21s through W30s, with W14s and W18s being used primarily for the columns. With story heights up to 18 ft, limiting the seismic drift of the building while achieving a cost-effective design was a challenge. The solution, which involved encasing perimeter steel moment frame columns in concrete pilasters at the upper garage level to create fixity, resulted in reduced beam and columns sizes while meeting code drift requirements.

A key design feature of the project is the multiple rooftop outdoor terraces, which are landscaped to create healing gardens and stretch to roof edges before transitioning into metal-clad cantilever canopies that provide shading to below spaces. These gardens and terraces draw people outside to connect with nature and their surroundings. To achieve this vision, approximately 12,000 sq. ft of the second and third floor framing is depressed and sloped to accommodate the exterior paving, landscaping planters and trees. In addition to the typical floor loading, the steel-supported terraces were designed to

ACCELERATING PRODUCTION PERFORMANCE



THE MOST **RELIABLE** AND **ACCURATE** PLATE
PROCESSING MACHINES FROM THE LEADER IN
AUTOMATED STEEL CNC FABRICATION SYSTEMS

ADVANCED CUTTING

Plasma 3D Bevel and
Oxy-fuel 4.0 technology

AUTOMATION

10-station automatic toolchanger

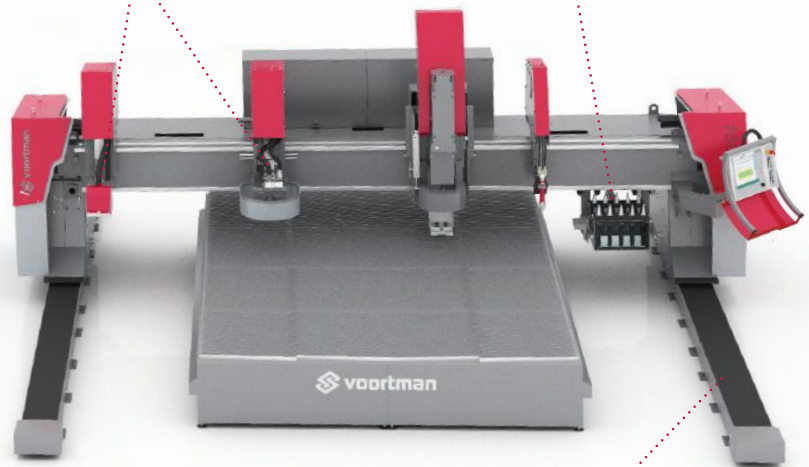

VOORTMAN V310
PLATE DRILLING AND CUTTING

PRECISION

Helical rack and pinion coupled with precision
lineal guides and servo-driven drill spindle



SEE MORE ONLINE

Use your phone's
camera or visit us
with this URL.

VOORTMAN.NET/v310



VOORTMAN USA

26200 S. Whiting Way +1 708 885 4900
Monee, IL 60449 info@voortmancorp.com
United States of America www.voortmancorp.com

WWW.VOORTMANCORP.COM

accommodate 120 psf of landscape loading and two 6-ton trees. Tapered W30x235 girders transitioning to tapered W18x50 beams played a key role in achieving a 30-ft-long cantilevered terrace with a canopy containing a signature pointed edge at the second floor. The pointed canopy edge was achieved via tapered “knife blade” profile steel plates at the end of the W18s to support the metal panels at the edges of the canopies; similar framed canopies also occur at the third floor and roof levels.

The striking new L.A.-area base of operations for Shriners Hospital was able to address the site’s high seismicity and eye-catching cantilevers via steel framing, resulting in a safe, resilient and beautiful healthcare facility that serves as a healing, green oasis for its patients, visitors and staff.

- Owner**
Shriners Hospital for Children
- General Contractor**
DPR Construction

- Architects**
CO Architects (Design Architect)
SRG Partnership, Inc. (Executive Architect)
- Structural Engineer**
KPFF Consulting Engineers
- Steel Team**
Fabricator and Erector
Schuff Steel Company
Pacific Division
- Detailer**
Steel Systems Engineering, Inc.



The new 75,000-sq.-ft Shriners for Children Medical Center in Pasadena replaces a 1951-built facility in downtown Los Angeles.



© 2018 Tom Bonner



Want to make the most of your internal certification audit? Follow the signs to www.aisc.org/cert/Fabricator, where you'll find free audit tools, newsletters, and NASCC quality-related sessions.



CERTIFICATION PROGRAMS

A Living, Breathing Building



BY BRYAN SEAMER, SE



Bryan Seamer (bseamer@lpadesignstudios.com) is an associate principal and director of structural engineering with LPA, Inc., in Irvine, Calif.

THE NEW SPECTRUM IV facility lives and breathes science, for the purpose of saving lives.

The building serves as the new base of operations in San Diego for Vertex Pharmaceuticals, Inc., a global company that develops transformative medicines for people with serious and life-threatening diseases. It consists of 170,000 sq. ft on three floors of state-of-the-art laboratory, office and collaboration spaces above two levels of underground parking in the heart of San Diego's Torrey Pines life sciences cluster. The project was developed by Alexandria Real Estate Equities, Inc., a leader in owning, operating and developing collaborative and dynamic life science and technology campuses across the country. The ground-up project, which is anticipating LEED Gold certification, includes over an acre of outdoor conferencing, meeting and amenity spaces.

Vertex's lifesaving work, focusing on respiratory patients with cystic fibrosis, serves as the inspiration for the building's integrated architectural and structural design. The dramatic architectural forms, numerous cantilevered elements and a unique multi-story tensioned metal fin entry showcase the versatility and elegance of structural steel as both a building material and an appropriate medium for architectural expression. Close integration between designers and builders was key to the success of the project, according to Jim Larson, Vertex's vice president of corporate real estate and operations. "This integrated design approach has proven to improve communication and save time, and has ultimately led to the delivery of a better solution," he noted. "The structural engineering team has provided creative solutions to the many complex needs of the facility and lab spaces."

The Right System for the Site

During the project's programming and conceptual design phases, architect and structural engineer LPA Design Studios worked closely with both Vertex Pharmaceuticals and

Chicago Metal Rolled Products Saved Their Customer More Than 80,000 lbs. of 12" sq. Tubing

A tribute to the teamwork of
the roller, fabricator and erector:
"This project went almost
flawlessly despite its complexity
and challenging schedule."

Project Manager

Using advanced technology, Chicago Metal Rolled Products:

- Curved 52' of distortion-free arc from stock only 54' long
- Eliminated 6' to 10' of material, per tube, normally lost to scrap
- Substantially reduced freight charges
- Stored 213 pieces of tubing from mills, curving and shipping over course of five months

Early involvement in the University of Phoenix Stadium (Home to Arizona Cardinals, BCS National Championship Games and Superbowl XLIX; 2007 IDEAS² Winner) allowed Chicago Metal Rolled Products to save their customer time and money when curving 402 tons of 12" x 12" x 5/8" and 12" x 12" x 1/2" tubing to radiuses from 1000' to 1200' for the roof trusses.

Call us at 866-940-5739

Contact us to see how much we
can save you on your next project.



**CHICAGO METAL
ROLLED PRODUCTS COMPANY**

CHICAGO • KANSAS CITY
cmrp.com



We bend ALL sizes up to:

We bend ALL sizes up to:



10" x 10" x 1" Angle



10" x 10" x 1" Angle



24" x 12" Flat

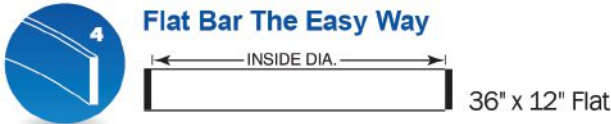

36" x 12" Flat

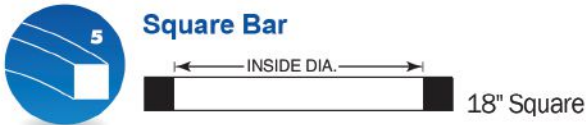

18" Square

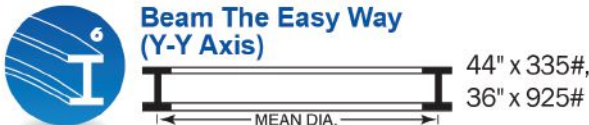

44" x 335#,
36" x 925#



44" x 285#

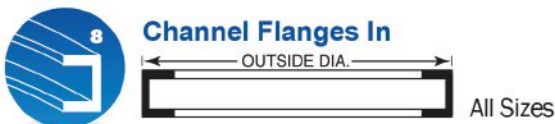

All Sizes



All Sizes



All Sizes



22" x 142¹/₂# Tee

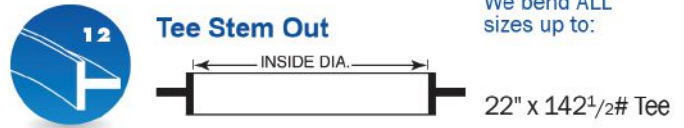

22" x 142¹/₂# Tee

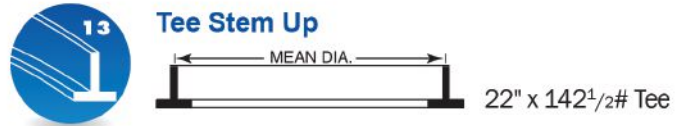

22" x 142¹/₂# Tee

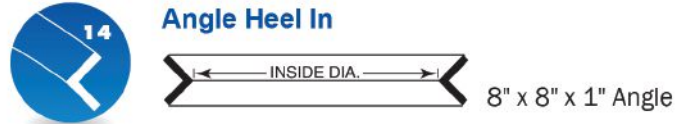

8" x 8" x 1" Angle

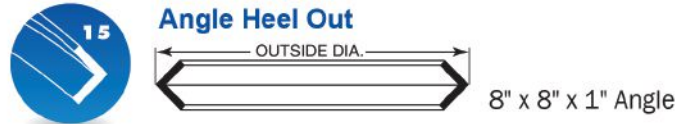

8" x 8" x 1" Angle

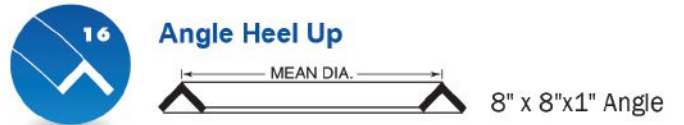

8" x 8"x1" Angle

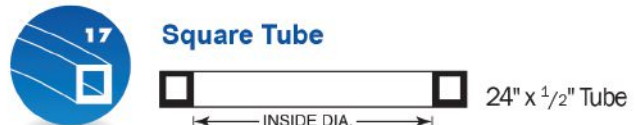

24" x 1¹/₂" Tube

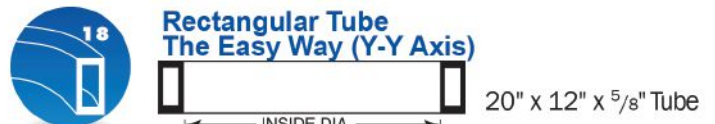

20" x 12" x 5⁵/₈" Tube



20" x 12" x 5⁵/₈" Tube

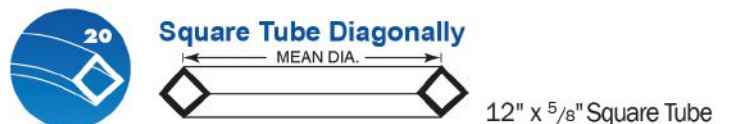

12" x 5⁵/₈" Square Tube

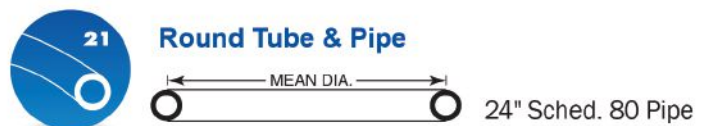

24" Sched. 80 Pipe

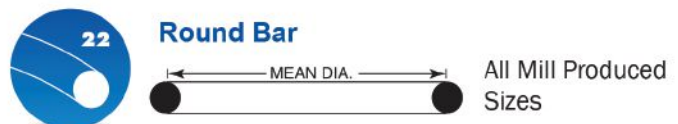

All Mill Produced Sizes

We also roll stair stringers, helical hand rails, off-axis bends, formed shapes and extrusions.

Visit cmrp.com for more information.



CHICAGO METAL
ROLLED PRODUCTS COMPANY

CHICAGO • KANSAS CITY



A new pharmaceutical headquarters building uses steel to bring its science-inspired design to efficient reality.



Costea Photography, Inc.

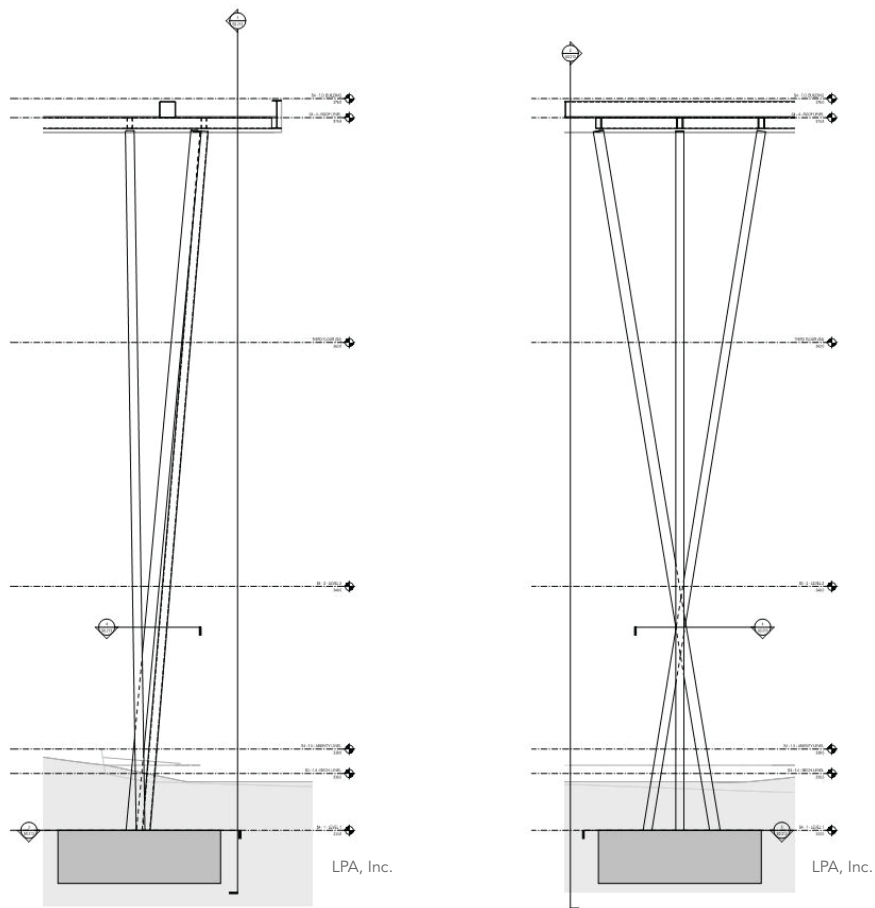

LPA, Inc.

LPA, Inc.

Details of the weathering steel HSS columns at the building's rear.

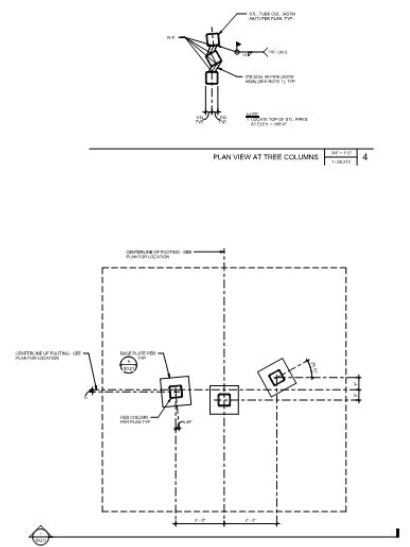

LPA, Inc.



Costea Photography, Inc.

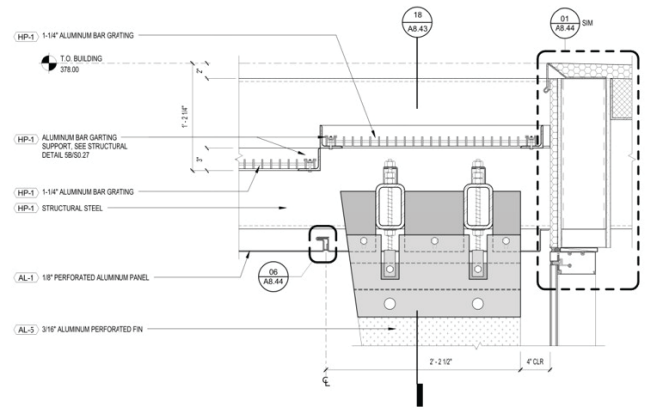

above: An architectural-fin-to-steel-framing connection.

left: A scale model of the building.

below: Architectural fins connecting to the steel framing of the steel halo.

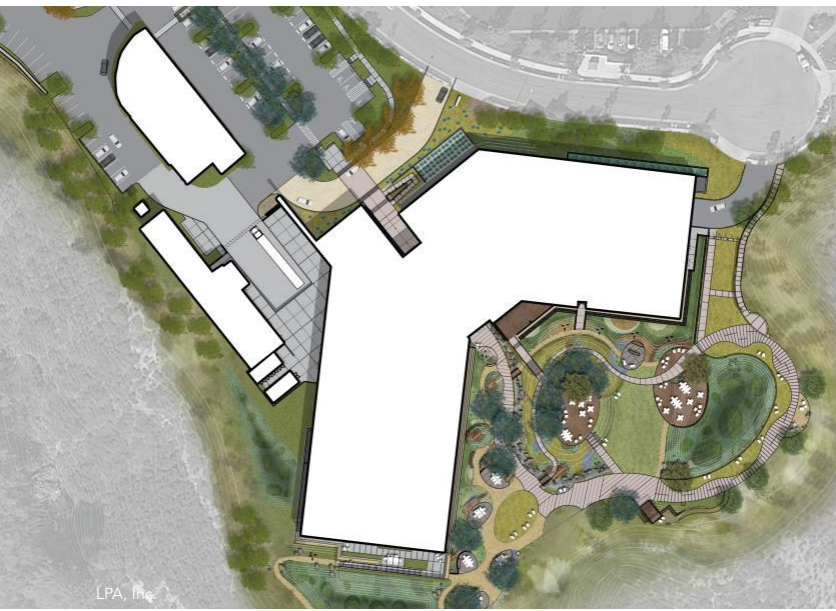

LPA, Inc.



left: An overhead view of the right-angle "V" configuration.

below: The facility consists of 170,000 sq. ft of state-of-the-art laboratory, office and collaboration spaces above two levels of underground parking in the heart of San Diego's Torrey Pines life sciences cluster.



A cutaway view of the facility, showing the above- and belowground portions.

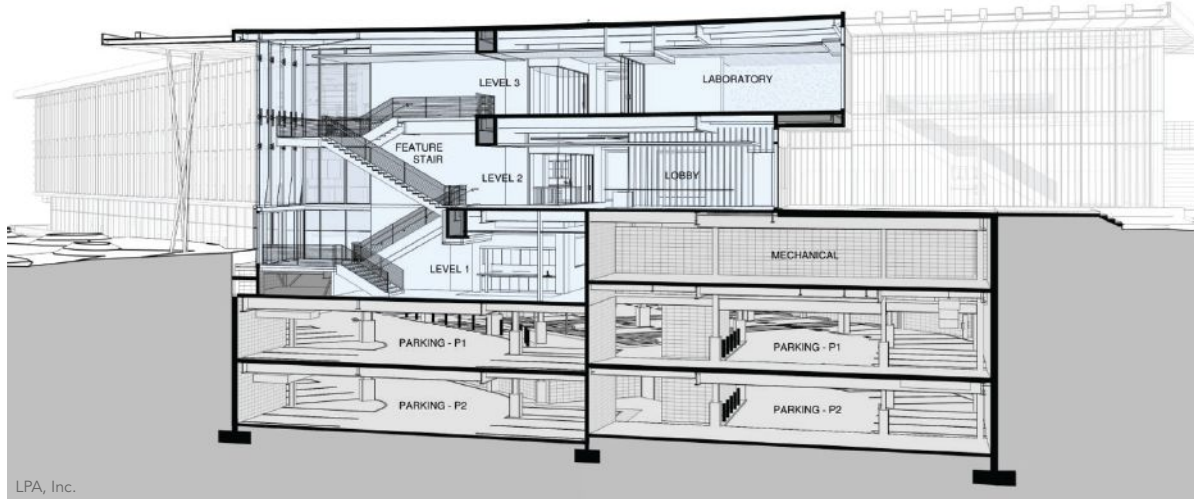

Alexandria along with the project’s general contractor, BNBuilders, to address a challenging combination of site constraints and programmatic requirements. The project site, perched on a scenic canyon rim, has both steep topography and a strict building height limit due to its proximity to the coast. The sloping site resulted in a lower level that opens to the canyon-side outdoor amenity area, while the opposite side is completely below grade.

The integrated design team studied multiple building forms and construction materials before ultimately selecting a stepped-grade, steel-framed concept comprised of two rectangular wings interconnected by a high-volume through lobby. The wings are at right angles to each other, resulting in a V-shaped building form with people, light and air passing through a common lobby that is reminiscent of the trachea and the lobes of the lungs, the

targets of the cystic fibrosis medications that Vertex develops. This form also allows for intimate internal views into the laboratories as well as inspirational external views from the labs out to canyons and mountains in the distance, all without sacrificing structural efficiency.

Structural steel was the ideal material for both the superstructure and the subterranean parking structure; the building uses approximately 1,700 tons in all. The ability of steel to efficiently span uninterrupted interior lab spaces up to 50 ft, as well as provide the adaptability and flexibility required to meet Vertex’s current and future needs with relatively shallow shapes (standard shapes ranged from W12 to W24), allowed the project team to fit three stories of programming within the coastal height limit. Further, at strategic locations to meet programmatic needs, the steel floor framing was

See it, or dont.
You choose.

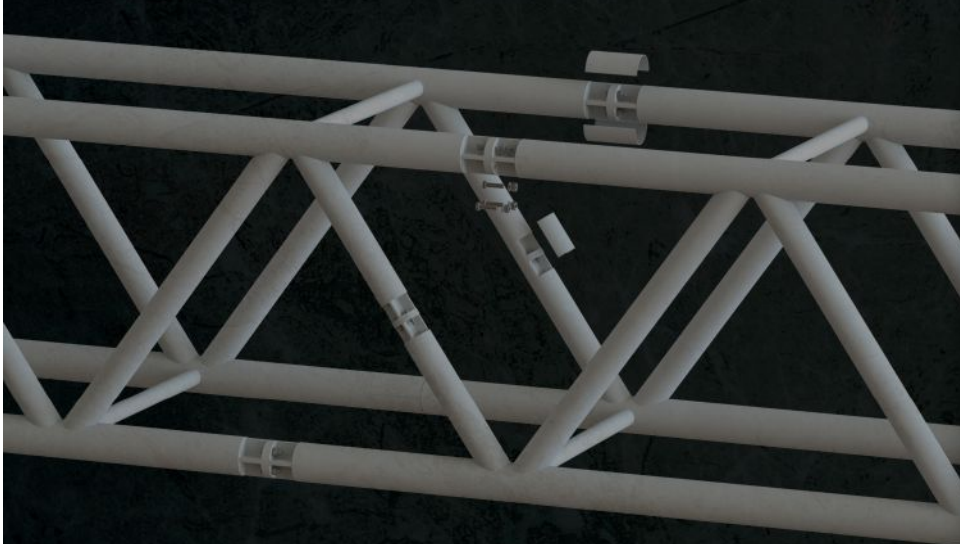

CASTCONNEX
innovative components for inspired designs



Diablo Bolted Splice™

carefully tuned to minimize the dynamic loading-induced floor vibrations that are incompatible with the high-powered optical lab equipment essential for development of lifesaving pharmaceuticals.

The building's seismic force-resisting system was complicated by both the V-shaped floor plan and the sloping canyon-edged site, and consists of steel Side-Plate special moment-resisting frames in each of the wings, arranged orthogonally to reduce building torsion and allow

for predictable ductile behavior during future earthquakes. Close collaboration between the structural and architectural designers during concept development led to the 90° angle between the two building wings. While early designs had a more obtuse angle, the design evolved to 90° specifically to allow for a more regular seismic system. And by arranging the seismic force-resisting elements on a regular orthogonal grid, moment frame sizes were minimized.

In addition, the need for full-height retaining walls on one side of the lower level led the team to design the building using a two-stage analysis with the lower level's rigid CMU shear walls supporting the upper steel moment frame structure. Developing seismic collector forces from into the masonry shear walls was challenging. The solution was to integrate a full-length wide-flange steel shape into the top of the masonry shear walls to allow transfer of seismic forces along the entire length of the shear walls.



Costea Photography, Inc.

The design team chose a stepped-grade, steel-framed concept for the building, comprised of two rectangular wings interconnected by a high-volume through lobby.

Exposed exterior steel provides multiple focal points for visitors and occupants.

Steel fabrication, delivery and erection followed the general contractor's sequencing of three designated site areas (C, B and A).



Kirk Snell - LPA, Inc.

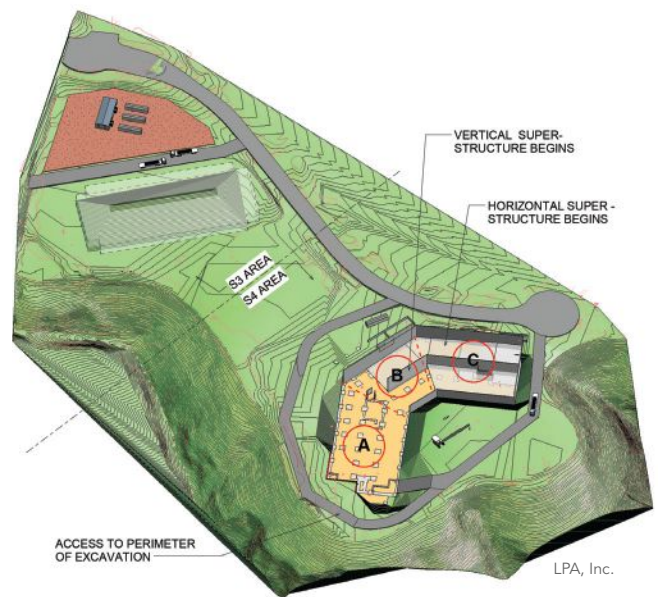

LPA, Inc.

Exposed Expression

The integrated architecture and structural engineering team collaborated closely on several prominent building features designed to showcase the versatility and beauty of exposed structural steel. One of the most impressive features is a steel “halo” that rings the perimeter of the building, cantilevering up to 25 ft from the façade. At the rear of the building, the halo is supported by soaring bouquets of whimsically tilted weathering steel HSS columns (ASTM A847). These sloping bundles of columns pass through an expansive outdoor deck, allowing building occupants to experience them both visually and tactilely at various scales as they move through the project.

The upper floors on the west side of the building cantilever about 7 ft to provide additional usable floor area while shading the exterior walkway and ground floor below. Each of the building corners cantilevers between 10 ft and 15 ft, allowing for unobstructed views without increasing construction costs. In addition, an architectural feature wall made of 62 perforated vertical aluminum fins was designed with a pattern and rhythm that draws visitors into the lobby and out to the amenity area.

Responding to San Diego’s famously moderate climate, the design blurs the boundaries between indoors and outdoors while maintaining the controlled laboratory environment within. Taking advantage of the openness inherent in a steel-framed building, the design provides 100% of the occupied interior space with natural light. The solar heat gain into the building is minimized by perforated steel sunshades, building overhangs and vertical and horizontal louvers, all contributing to the anticipated LEED Gold certification.

The Spectrum IV project is one of this year’s AISC IDEAS² Award winners. Full coverage of all the winners will appear in the May issue.

Owner

Alexandria Real Estate Equities

Architect and Structural Engineer

LPA Design Studios

General Contractor

BNBuilders

Steel Team

Fabricator and Erector

Rossin Steel, Inc.



Detailer

Dowco Consultants, Ltd.



Fall in love
with QuickFrames



The new industry
standard for structural
roof top opening frames.

QUICKFRAMES™

quickframes.us

480-464-1500

HEXPORT®



Save valuable time and money. Never search
for bolting documents ever again!

Test Reports
Invoices
Packing Lists
DOT Approvals
Order Tracking
Proof of Delivery

TEST REPORT			
Lot No: BM0551		MANUFACTURING DATE: 10/11/2017	
PRODUCTION INFORMATION			
PART NO: AAAM087250		MANUFACTURERS HEAD MARK	
SIZE: 7/8" (9) X 2-1/2"		DESCRIPTION: HVY HEX STRUC. BOLT - MG	
MANUFACTURING QTY: 18,615			
ASTM/ASME SPECIFICATIONS			
SPECIFICATION	AMEND	SPECIFICATION	AMEND
ASTM F3125	15a	ASTM F1470	12
ASTM A325-1	14	ASTM F805	10
	2010	ASTM F185	13
	2001 (R2009)	ASTM B686	2004 (R2008)
RAW MATERIAL INFORMATION*			
SUPPLIERS TEST REPORT ATTACHED WITH CHEMISTRY INFORMATION			
GRADE	HEAT INFO/NUMBER	ASTM SPEC	AN
F4330	1040330	A325-1	



Call or Go Online to find out more
St. Louis Screw & Bolt

stlouisscrewbolt.com

800-237-7059

Structural Bolting Experts



Randy Anderson Photography

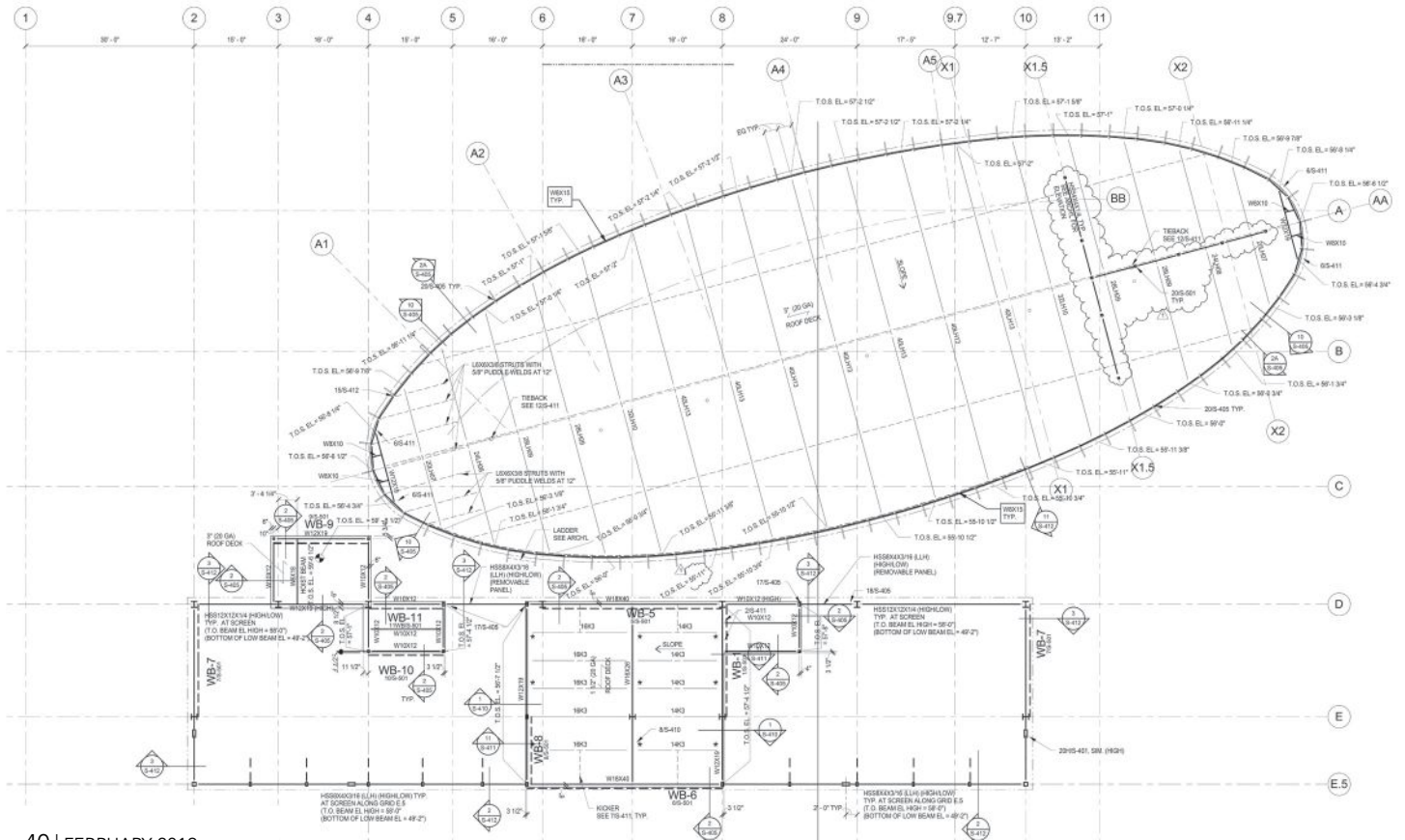

Brainy Building

Smart thinking and an intelligent construction approach help bring a brilliantly designed cognitive research facility to life. Genius!

BY THOMAS W. TAYLOR, PE, AND RODOLFO D'ARLACH, PE

CAN A BUILDING called the Brain Performance Institute make you smarter? Actually... yes, it can.

Part of the Center for BrainHealth at the University of Texas at Dallas, this new steel-framed facility is focused on innovations that enhance how individuals think, work and live. And it definitely involved some creative thinking and brainy—and attractive—design and construction solutions to address challenging circumstances.

Moving Money

Many of the challenges focused on the architect's vision of a "Live Lobby" composed of an exposed steel façade—but the engineering complexity of such a structure exceeded the university's budget. Serious design team discussions ensued to identify the best way to accomplish the vision while staying within budget.

Considerable attention was devoted to creating an economical structural solution for the three-story structure that wrapped around the side and rear of the lobby, with the idea that savings achieved in this portion could be transferred to the lobby's ambitious requirements. Extensive coordination between the architect and engineer, Page and Datum Gojer, respectively, resulted in economical structural bay spacing for the wraparound, which also meshed well with the functional use of the space. The column spacing around the perimeter of the building was set at 30 ft, which synched with the architectural grid and reduced spandrel beam lengths (the longer spans of the initial design called for longer spandrel beams to control deflections, as dictated by curtain wall deflection criteria). From here, a bay spacing of 30 ft by 25 ft was established for the floors and roof. The building uses approximately 750 tons of steel in all.

Roof framing also played a key role. The most economical steel roof joist spacing over the lobby was determined to be 10 ft, which allowed the joists to straddle steel plate columns at the lobby's exterior—while still being supported on the con-

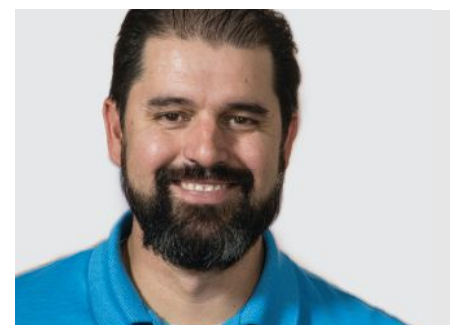

Thomas Taylor (thomas@datumengineers.com) is principal design engineer, and **Rodolfo D'Arlach** (rodolfo@datumengineers.com) is a principal and studio leader, both with Datum Gojer Engineers.



The lobby is encircled by a series of 2-in.-thick steel plate fin columns spaced at 5 ft.

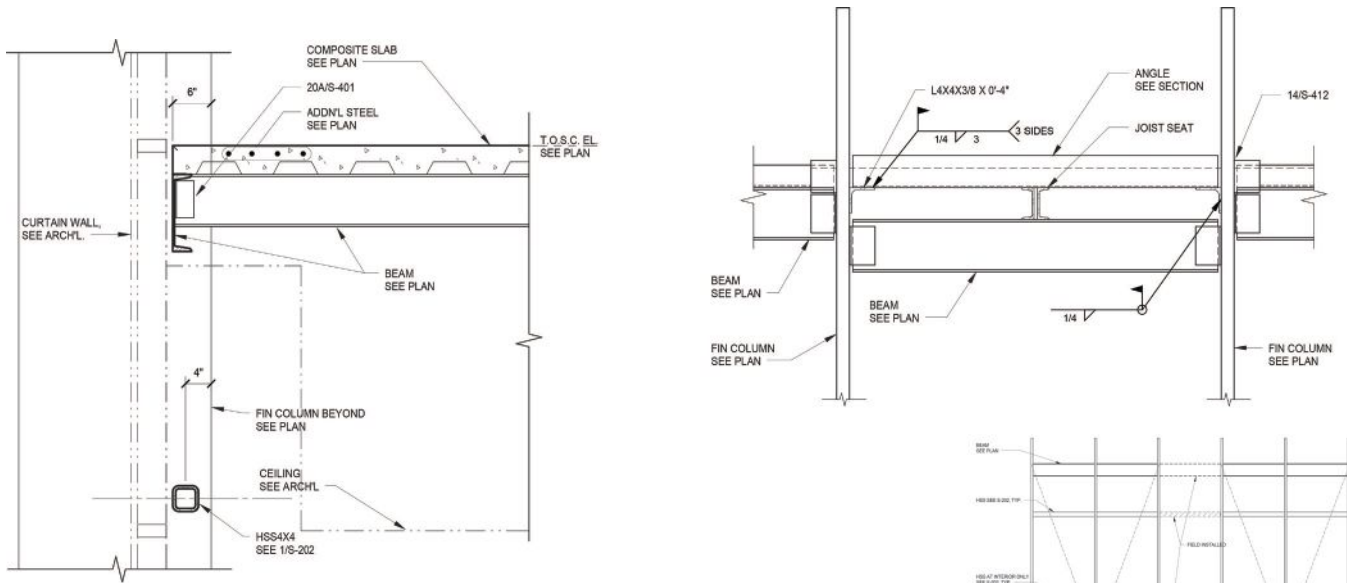

Connections at the fins.

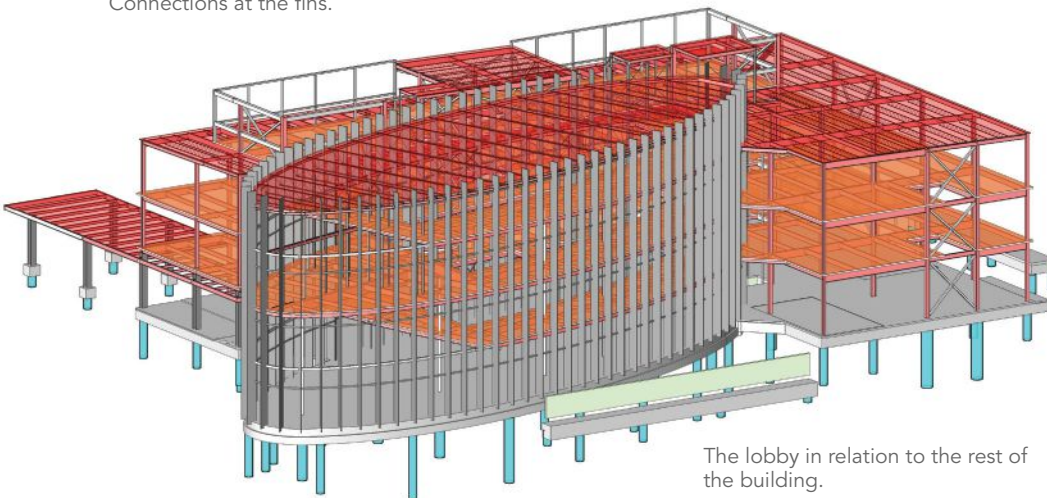

The lobby in relation to the rest of the building.

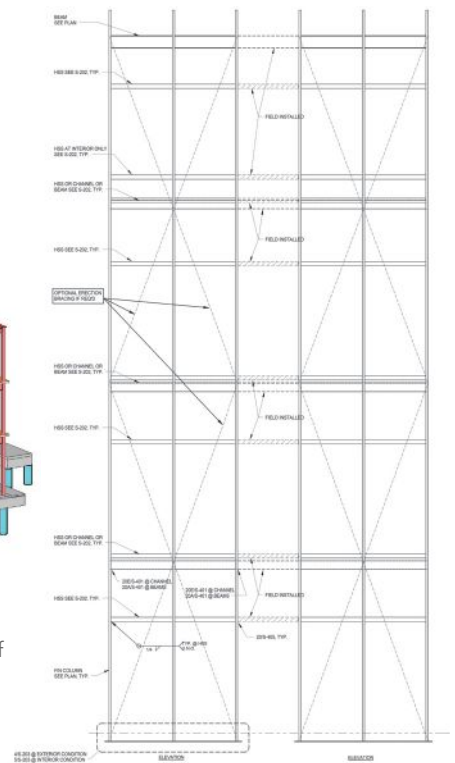

nection beam between the plate columns so as to avoid costly connection details at the columns. The steel beams on the second and third floors, supported by the steel plate columns, were detailed to straddle the columns as well. This simplified and reduced the cost of the joist and beam support details for the roof and floor, and the resulting reduction in steel tonnage provided additional funding for the lobby.

Perfect Perimeter

When it came to the perimeter columns of the lobby, Datum Gojer opted to construct them as single steel plates as opposed to built-up sections, with the idea of reducing fabrication costs and eliminating the additional tonnage needed to create built-up columns. The tops of the columns, 78 in all, are set at 60 ft tall. Some of the columns are full-height columns supporting the roof, while others support only the second or third floors surrounding the lobby. The optimal sizing for the plate columns, which were designed to resist wind and gravity loading on the wall, was determined to be 2 in. thick and 30 in. deep, spaced at 5 ft. Though initially shallower, the architect opted to increase

the plate depth to 30 in. to maximize sun shading and visual effect, with the added bonus of increasing the structural strength of the plates. However, doing so caused the plates to extend 12 in. beyond the supporting concrete foundation, creating an eccentric load that required additional structural analysis. As a result, horizontal steel 4-in. by x 4-in. x 1/2-in. hollow structural section (HSS) struts were added to the structure every 12 ft vertically and welded to the plate columns to reduce the unbraced length and twist of the columns. The perimeter steel was designed to AISC AESS (architecturally exposed structural steel) Category 1.

Placing Plates

Another brainteaser for the team was determining the most economical way to fabricate and erect this plate column wall around the elliptical lobby, with the hope of achieving addition savings by developing an innovative construction approach. The solution was to prefabricate three columns connected together in the shop and ship them in 10-ft-wide modules (though due to the geometry and curvature of the wall, some panels were con-

structed of two columns). The sections were composed of plate columns and associated horizontal struts and beams welded to the columns in the shop, leaving only lifting, bracing and attaching the column assemblies in the field via steel struts and beams—and resulting in field connections comprising only one-third of the total connections.

In terms of erection, the effect was essentially that of a tilt-wall system. The concept was actually added as an option on Datum Gojer's initial drawings in order to allow the erector to search for the most economical method to fit its capabilities. However, no other process was presented, and so the tilt-wall method was implemented. The 10-ft-wide panels were delivered to the site on a flatbed truck trailer; this width with was chosen over 15-ft sections to simplify delivery on local roads. The segments were laid horizontally on the trailer with the exterior face up. Holes were provided at the tops of the plate columns, and crane cables were hooked through these holes to raise the segments from the trailer. The crane then transported the segments to their final locations on the building.

5

REASONS

Why SEAA Membership is a GOOD Investment.









- 1

Your Industry

No other national association represents the unique interests of all steel erectors and fabricators. Members are experts in construction of commercial buildings, arenas, bridges, and highway structures. Members enjoy opportunities to network with other industry professionals at the Annual Convention, golf tournaments, member events, and training classes.
- 2

Improve Safety and Productivity

Members have access to custom Ironworker Craft Training Curriculum. Studies show 24% of businesses experience lower productivity due to the lack of skilled ironworkers and welders. A better trained workforce delivers lower accidents rates, higher productivity, and increased profits.
- 3

Accredited Credentials at Reduced Cost

SEAA's NCCER (National Center for Construction Education and Research) sponsorship means that member companies can provide industry-recognized credentials to their employees with the benefit of SEAA administrative support and at a lower cost to members than going direct through NCCER.
- 4

Competitive Advantage

SEAA's U.S. Department of Labor-approved Ironworker Apprenticeship Program allows members to create formal training that meets standards recognized by Federal and State governments. Participation allows merit shop contractors to utilize government approved apprenticeship rates on Davis Bacon Wage Projects.
- 5

Influence Industry Standards

SEAA strategic partnerships with industry groups provide member companies with industry representation with American Institute of Steel Construction, Steel Joist Institute, Steel Deck Institute, National Institute of Steel Detailing, and others.













Join by calling the SEAA office at 336-294-8880, or visit seaa.net.



Randy Anderson Photography

below: The fins were installed in 10-ft-wide modules.

above: The interior of the live lobby.



Through cerebral solutions such as efficient plate columns, modular panels and optimized integration of roof joists and exterior columns, not to mention achieving structural savings in one area that could be transferred to the showcase element, this intelligent building came together under budget while achieving the desired design—a smart approach for a facility that focuses on enhancing brainpower. ■

Owner
The University of Texas at Dallas

General Contractor
Turner Construction Company

Architect
Page

Structural Engineer
Datum Gojer Engineers

Steel Fabricator and Detailer
Schuff Steel – Gulf Coast

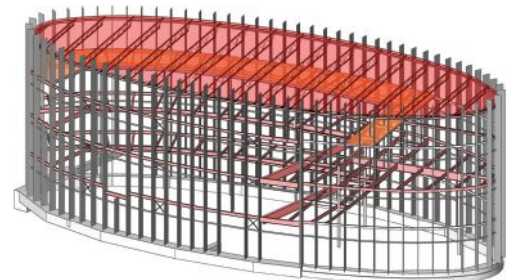

A structural model of the elliptical live lobby.

NASCC: THE STEEL CONFERENCE

incorporating the World Steel Bridge Symposium and the SSRC Annual Stability Conference

- 250+ exhibitors
- 5,000+ design and construction professionals
- 140+ educational seminars

technical sessions
networking
product showcase

It's the **premier event** for everyone involved in the design and construction of steel-framed buildings and bridges.

registration
NOW OPEN!



cisc icca
imca

St. Louis, Missouri
April 3–5, 2019



www.aisc.org/nascc

conference preview

BETTER SEISMIC PERFORMANCE

BY CHARLES W. ROEDER, PHD, DAWN E. LEHMAN, PHD,
AND JEFFREY W. BERMAN, PHD

A look at seismic evaluation and improvements to older (pre-1988) concentrically braced frames.



Charles W. Roeder (croeder@uw.edu), **Dawn E. Lehman** (delehman@uw.edu) and **Jeffrey W. Berman** (jberman@uw.edu) are all with the Department of Civil Engineering at the University of Washington in Seattle.

CONCENTRICALLY BRACED FRAMES (CBFs) meet strength and stiffness requirements for seismic design—which is why they are commonly used as lateral load-resisting systems in buildings.

Today, special concentrically braced frame (SCBF) capacity-based design requirements assure good inelastic performance—but prior to 1988, CBFs were not capacity designed (termed NCBFs) and were inferior to SCBFs.

Extensive research has been performed over the last 15 years, which has further improved the inelastic behavior of SCBFs, specifically with advancements in the brace gusset-plate connection design. More recently, older, non-ductile NCBFs were investigated to quantify their seismic performance and study cost-effective retrofit strategies. The research shows that some NCBF deficiencies, such as cross-sectionally slender braces or inadequate welds, cause severe problems during seismic loading, while other deficiencies, like bolt bearing, that are prevented in current SCBF criteria can result in relatively good performance. This article summarizes these research results and methods for improving the seismic performance of SCBF and CBFs.

Investigation and Improvement of SCBF Design

SCBF design provisions were initiated in the 1990s based upon research available at the time. Prior to the 2016 AISC *Seismic Provisions for Structural Steel Buildings* (ANSI/AISC 341, www.aisc.org/specifications), capacity-based design requirements included the following:

- Braces are designed to develop the factored seismic design forces and meet local and global slenderness limits. Braces are sized so that tensile and compressive braces share lateral resistance.
- Connections, beams and columns are designed to resist the expected tensile ($P_{te} = A_g R_y F_y$) and compressive ($P_{cre} = A_g F_{cre}$ where F_{cre} is the critical buckling stress at $R_y F_y$) brace forces rather than the design forces (a key component of capacity-based design).
- Tensile yield and buckling capacities of the gusset plate are calculated using the Whitmore width defined by a 30° projected angle and the modified Thornton method.
- The gusset plate accommodates out-of-plane buckling of the brace, typically using a $2t_p$ gusset plate clearance model.
- Welds or bolts attaching the gusset plate to beams and columns are designed to resist forces determined by uniform force method due to P_{te} and P_{cre} of the brace.
- Beams of chevron or inverted-V braced frames are designed to resist the maximum expected brace forces (P_{te} and P_{cre}) and the post-buckling brace forces (P_{te} and $0.3P_{cre}$).



Initially, a large set of experiments were conducted to evaluate the SCBF design method and to improve their constructability and ductility. This research verified that tensile yield, buckling and post-buckling deformation of the brace dominates the inelastic behavior of CBFs, as assumed in design, but the gusset plate connection design also plays a significant role. This research shows that gusset plate connections that yield following brace yielding and prior to brace fracture significantly improves SCBF seismic performance and inelastic deformation capacity. Figure 1 illustrates this by showing the 3 test results for SCBFs with identical beams, columns, braces and beam-column connections, but different gusset plate connections. The test in Figure 1a employed a connection meeting 2005 AISC *Seismic Provisions* using the uniform force method to size the gusset plate welds, while Figure 1b had an identical gusset plate using CJP welds. The test shown in Figure 1c used a somewhat thinner gusset plate than the other specimens designed by the balanced design procedure (BDP), which balances the brace

and gusset plate yield capacities and requires a weld designed to meet the strength of the gusset plate. The figure and statistical data from many tests show that the BDP increases the inelastic deformation capacity an average of 46% over that achieved by 2010 AISC SCBF criteria.

The BDP for gusset plate design incorporates all 2010 AISC SCBF requirements except:

1. Welds or bolts joining the gusset plate to the beam and column are designed to develop the plastic capacity of the gusset plate rather than the force from the uniform force method.
2. The Whitmore width for evaluating the tensile and compressive resistance of the gusset plate is determined by a 37.6° projection angle (3-4-5 triangle), which provides a conservative estimate of gusset resistance with controlled yielding of gusset.
3. End rotation clearances for the brace are defined by the $8t_p$ elliptical clearance model for corner gussets (Figure 2a) and the $6t_p$ vertical clearance with mid-span gussets (Figure 2b).

conference preview

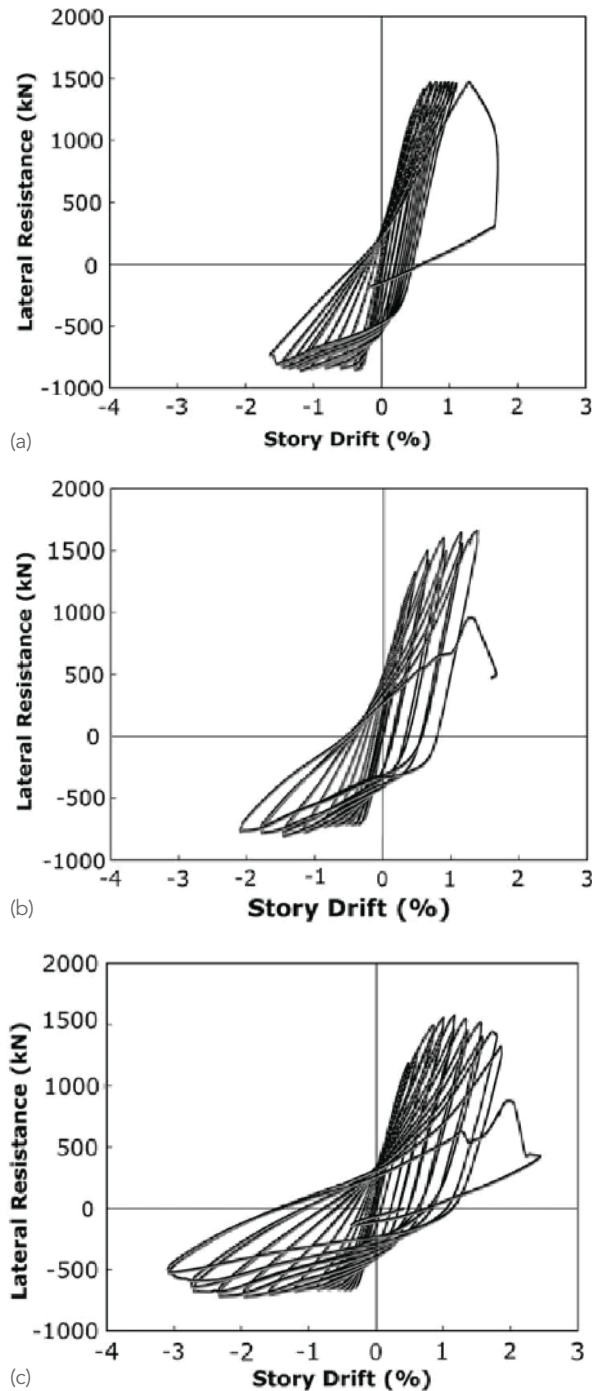

Figure 1. (a) fillet welded, thicker gusset plate, (b) CJP-welded, thicker gusset plate and (c) gusset plate and weld designed to meet BD.

4. Relaxed block shear used at the brace-to-gusset joint. This is conservative due to the concentric loading of the brace on the gusset, but is not permitted in the 2016 AISC *Specification for Structural Steel Buildings* (ANSI/AISC 360, www.aisc.org/specifications).

Figures 2c and 2d show the gusset yielding resulting from this method. These changes result in thinner, more compact gusset plates, which significantly increase the inelastic deformation capacity of SCBFs. The first three changes noted above are permissible in the 2016 *Seismic Provisions*; the fourth item is currently under review for possible inclusion in the 2022 AISC standards.

Evaluation of Older Braced Frames

Extensive research has been conducted on older NCBFs. An infrastructure review of NCBFs showed that chevron or inverted-V CBFs with rectangular HSS tube braces with local slenderness values significantly larger λ_{bd} are common with beams significantly weaker than currently required by the SCBF unbalanced load criteria. Connection vulnerabilities are also common including: 1) undersized bolts and welds, 2) welds that are not demand critical and 3) interrupted load paths from the brace to the beams and columns. Experiments investigated these deficiencies and showed that some NCBFs behaved relatively well while others behaved poorly (see Figure 3). Figure 3a shows the performance of a NCBF with a single continuous shear plate joining the gusset and beam web to the column and a brace with local slenderness that was 2.3 times λ_{bd} . Fracture of the brace occurred at a low drift and limited ductility. Figure 3b shows another NCBF with the same beams and columns, a similar brace local slenderness less than λ_{bd} . We had a continuous bolted shear plate with undersized bolts controlled by bearing, and this NCBF behaved quite well because bolt bearing led to bolt-hole elongation, which increased the inelastic deformation prior to brace fracture.

The study of NCBFs led to the following observations on the behavior and retrofit of NCBFs:

- Beams in chevron or inverted-V NCBFs that do not meet current unbalanced load requirements can provide good inelastic performance if other aspects of the design are adequate, but overly weak beams may lead to undesirable performance. Current research is studying new limits for chevron beams including SCBFs.
- Connections which have relatively low bolt resistance that is controlled by bolt bearing may provide good performance, due to bolt hole elongation and strain hardening.

Acknowledgments

The work described herein was funded by the National Science Foundation through Grants 0301792, 0619161 and 1208002 and AISC; other steel industry sources provided materials. The authors are grateful for this support. A large number of graduate students conducted the experiments and analyses described here. Former PhD students are: Po-Chien Hsiao, Keith Palmer, Andrew Sen and Jung-Han Yoo; and the following are former MS research students: Ryan Ballard, Adam Christopoulos,

Kelly Clark, David Herman, Sara Ibarra, Molly Johnson, Shawn Johnson, Brandon Kotulka, Eric Lumpkin, Jacob Powell, Daniel Sloat, Marsh Swatosh and Claire Terpstra. An advisory committee of practicing engineers guided the work and included James Malley, Rafael Sabelli and Tom Sabol. The authors wish to express their gratitude towards their former students and the members of the advisory committee for their efforts and expertise, all of which made this research so successful.

- Connections with understrength welds not meeting demand critical requirements result in sudden failure at relatively small inelastic deformation. Research shows that weld overlays designed to meet the BPD can mitigate this failure mode.
- NCBFs with rectangular HSS braces with local slenderness (b/t) exceeding λ_{bd} will have sudden brace fracture at small inelastic deformations. This may be mitigated for these slender braces by using concrete fill that does not engage the end connections.

Future Changes to Braced Frame Design

Current SCBF design provisions for chevron braced frames require large beams because of the large unbalanced load current requirement, and therefore chevron SCBFs are seldom used today. The NCBF research showed that yielding of the chevron beam is not detrimental to behavior if the required frame lateral resistance is achieved and beam deflection is limited. AISC

funded research to experimentally and analytically investigate the effect of beam yielding on SCBF buildings, and this work included experiments on single-story and multi-story chevrons with various degrees of beam yielding as well as a comprehensive nonlinear analytical study of their performance. It also shows that a significant reduction in this unbalanced design force will result in increased beam yielding, which may increase the deformation capacity of the braced frame prior to brace fracture with relatively little reduction in frame strength or stiffness. A proposal to reduce the unbalanced design load in future versions of the AISC *Seismic Provisions* can be expected. ■

This article is a preview of the session “AISC Research: Seismic Evaluation and Retrofit of Concentrically Braced Frames” at the 2019 NASCC: The Steel Conference, taking place April 3-5 in St. Louis. For more information and to register, visit www.aisc.org/nascc.

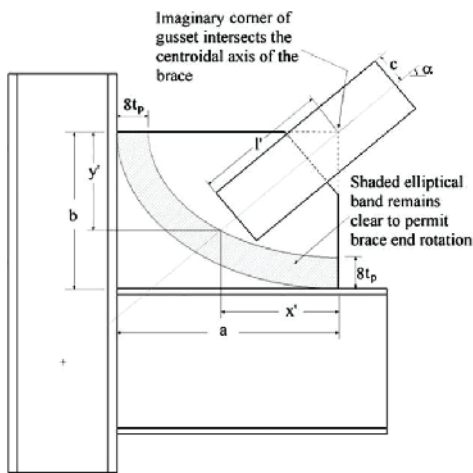

(a) Corner Gusset Clearance

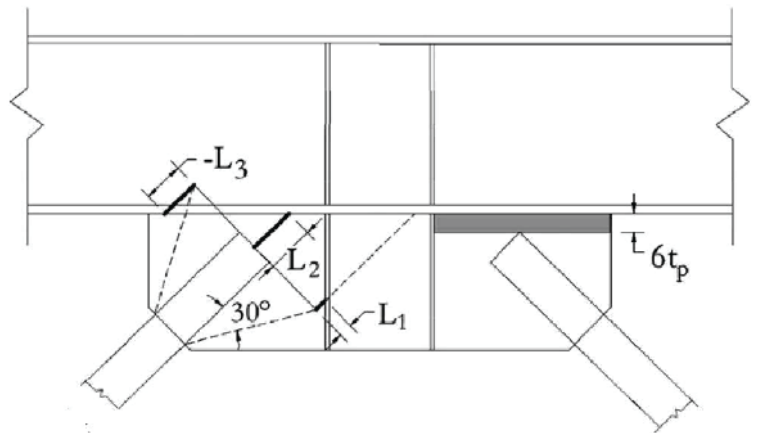

(b) Mudspan Gusset Clearance

Figure 2. End rotation clearances.

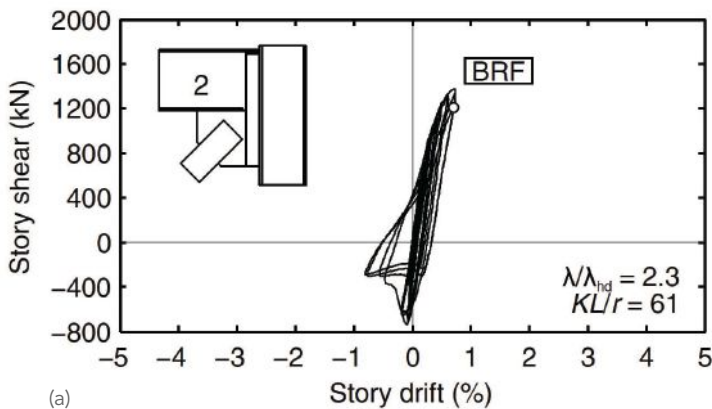

(a)

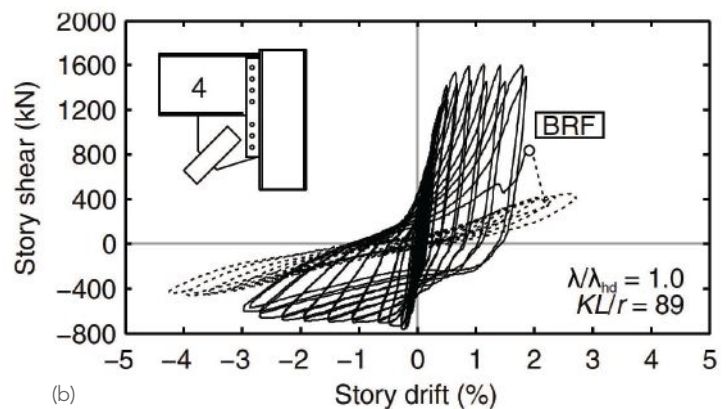

(b)

Figure 3. Range of NCBF performance for (a) cross-sectionally slender brace and undersized welded gusset-plate connection and (b) bolted connection with continuous shear plate (BRF = brace fracture).

conference preview

THE RESILIENT NEW KID IN TOWN

BY ERIC MOE, PE

An innovative braced frame system makes its debut in Wyoming.



Eric Moe (eric.moe@pumasteel.com) is director of business development for Puma Steel.

Patrick McManus (patrick.s.mcmanus@novelstructures.com) of Novel Structures, LLC, also contributed to this article.

THERE'S A NEW LATERAL SYSTEM IN TOWN.

And it's not just for high-seismic applications. Called the Re-Fuse braced frame (RFBF) system, it is proving to be an economical choice for its first implementation in Cheyenne, Wyo., an area of relatively low seismicity.

Re-Fuse is making its debut at U-Haul of East Cheyenne, a three-story, 80,000-sq.-ft storage facility built to meet the current nationwide demand for conditioned storage. The adverse weather and available labor pool in the Cheyenne area, coupled with the high load-carrying capacity of composite steel framing, made structural steel the best choice for the new building. Design-build was selected as the project delivery method, in order to expedite schedule and lock in pricing early in the design, and fabricator Puma Steel was engaged thanks to its long history of providing a highly effective method of design-build steel delivery, known as Team Puma. Team Puma provides specialty structural design, in-house detailing, fabrication and erection for the structural steel package, including structural and miscellaneous steel, joist and deck, all under one contract. The specialty design is customized to the purchasing, fabrication and erection preferences of the team while meeting the architectural intent and other project constraints. Design is directed toward effective use of Puma Steel's robust suite of automated equipment, thereby minimizing labor, particularly field welding. The result is a highly customized steel frame constructed with speed, accuracy and economy.

Relatively high seismic mass is common to many projects in the mountain region either due to masonry veneer cladding systems or building use. U-Haul of East Cheyenne as a storage facility is no exception, with a portion of the storage loading included in the seismic mass. As building codes have progressed through the years, earthquake loading substantially governs over wind the lateral design of these relatively high-mass structures, a reality that is counterintuitive in low-seismicity regions.

U-Haul of East Cheyenne resides in Seismic Design Category B, where a response modification factor, R , of 3 would traditionally be used to avoid seismic detailing in accordance with ASCE 7. However, the forces associated with a low-ductility $R = 3$ design resulted in large, costly spread footings to resist overturning forces. Puma Steel, instrumental in the development of Re-Fuse, had the solution. The system, qualified in accordance with ASCE 7 to be equivalent to buckling-restrained braced frames, offers a high performance of $R = 8$. However, it was specifically developed to address low force ranges common to low-rise buildings and buildings in moderate and low seismicity where traditional high-seismic systems have historically proven cost-prohibitive.

Cost-effectiveness is only one aspect of Re-Fuse, the development of which is centered around the replaceable fuse concept that inspired the product's name. Developed

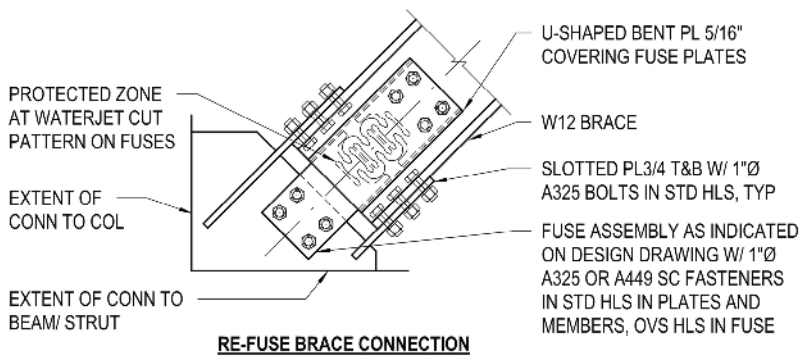

The new Re-Fuse based frame system.

conference preview

by Novel Structures, LLC, it uses typical A572 Grade 50 plates with a proprietary pattern cut into them via waterjet. The plates, or fuses, are used to connect the web of conventional wide flange concentric braces to gusset plates. Depending on the force and stiffness demands of the brace,

plates are configured in multiple laminations and connected using standard slip critical connections with F3125 A325 bolts to achieve desired strength and stiffness.

The individual plates range from 26 in. to 62 in. in length and 37 lb to 91 lb in weight. Consequently, the parts can be

unbolted subsequent to a significant seismic event and replaced with new parts, thus making the overall system highly resilient compared to traditional seismic systems. The only protected zone is the waterjet-cut portion of the fuse plates themselves, which is concealed in the final connected

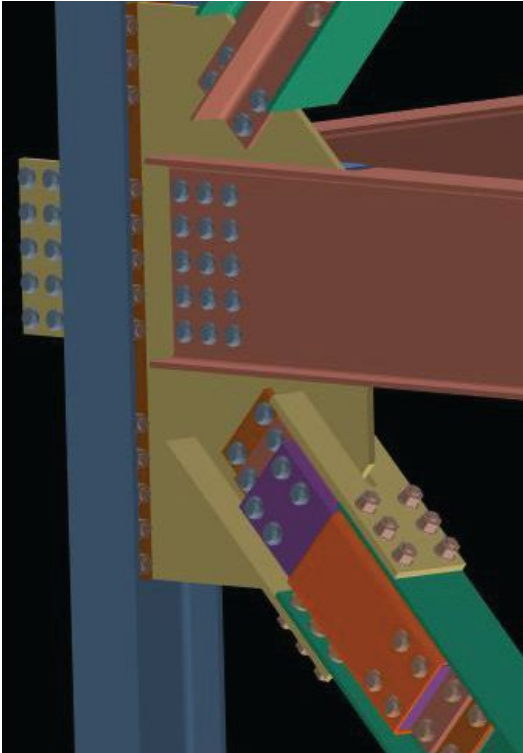

A 3D model of the Re-Fuse system.

The U-Haul of East Cheyenne project, which topped out this past summer.

The system uses typical A572 Gr. 50 plates with a proprietary pattern cut into them via waterjet.



condition. The system is thus convenient for architecture and construction as metal studs and other attachments can be made to the brace itself without compromising the seismic performance of the system.

For the U-Haul project, Puma Steel developed steel pricing for designs using an $R = 3$ concentric braced frame lateral system and the $R = 8$ Re-Fuse system. Foundation designs for each system were provided to the general contractor along with the steel pricing. Once the contractor, Edwards, had priced the foundations, it was clear that Re-Fuse was the more economical solution.

The system resulted in further cost savings through the course of design. The reduced seismic forces allowed for greater diaphragm spans, thereby reducing the number of braced frames needed. The associated reduction in the number of lateral foundations, along with reduced labor and handling due to a lower piece count, accounted for the additional cost savings. Further, architectural flexibility was enhanced by the elimination of interior braced frames.

Re-Fuse was specifically developed to use materials and processes common to conventional fabrication and erection. As such, shop installation of the components onto the vertical braces and the subsequent field installation of the braces both went smoothly. Black Cat Erectors installed each brace in approximately fifteen minutes while the bolted connections eliminated field welding, arguably the most expensive process in steel construction. Topping out occurred in mid-August 2018, approximately one month after erection began. ■

This article is a preview of the session "Alternative Seismic Systems" at the 2019 NASCC: The Steel Conference, taking place April 3-5 in St. Louis. For more information and to register, visit www.aisc.org/nascc.

Owner

Americo Real Estate Company

General Contractor

Edwards General Contractors, Cheyenne, Wyo.

Architect and Structural Engineer

HDR

Steel Team

Fabricator and Detailer

Puma Steel, Cheyenne 

Steel Erector

Black Cat, LLC, Cheyenne 

We love Quality Connections

How does Qnect define Quality?

Optimized, Accurate, Erectable, Economic, EOR Approved, Schedule Boosting, Safe.

Qnect.com/quality

Qnect



COREBRACE

Contact CoreBrace at:
5789 West Wells Park Road
West Jordan, UT 84081
801.280.0701
www.corebrace.com
info@corebrace.com

**Simplified Design
Simplified Installation
Simplified Costs**

Superior Seismic Performance

conference preview

SPEEDCORE AND COMPOSITE PLATE SHEAR WALLS

BY MORGAN BROBERG, SOHEIL SHAFAEI AND JUNGIL SEO

A brief look at the seismic behavior of the SpeedCore system.



Morgan Broberg (mbroberg@purdue.edu) and **Soheil Shafaei** (sshafaei@purdue.edu) are both graduate students and **Jungil Seo** (seo2@purdue.edu) is a post-doctoral research scientist, all at the Lyles School of Civil Engineering at Purdue University.

THE SPEEDCORE WALL system has rocketed to the forefront of tall building discussions.

With the ongoing construction of the first high-rise using this system, Rainier Square (www.rainiersquare.com/project), set to be completed in 2020, the move from research to practice had been swift for this innovative system. But what is it and how is it beneficial?

What Is SpeedCore?

Also referred to as coupled composite plate shear walls/concrete-filled (CC-PSW/CF), SpeedCore is a coupled-wall system comprised of composite walls and coupling beams. The composite wall panels consist of a concrete core sandwiched between two steel faceplates that serve as the primary reinforcement, replacing conventional rebar (these sandwich panels are depicted in Figure 1). Tie bars connect the two steel faceplates together and provide stability during transportation and construction activities. After casting, the tie bars become embedded in the concrete infill and provide composite action between the steel plate and concrete. The coupling beams are built-up steel box sections with concrete infill. Similar to the wall panels, the built-up steel section provides primary reinforcement to the coupling beam. The empty steel modules, including both the walls and coupling beam components, are fabricated in the shop, transported to the site, erected and filled with concrete.

Core wall construction generally dictates the sequencing and scheduling of construction at the site, and SpeedCore can expedite the construction schedule when compared to conventional concrete core walls. The steel plates and tie bars are sized to resist the construction loads of floors above, which reduces the number of days spent for the conventional concrete core walls to cure. Additionally, the empty steel modules serve as permanent formwork and falsework, eliminating days spent building or tearing down formwork for conventional concrete core walls. For the Rainier Square project, the change from conventional concrete walls to SpeedCore walls is expected to save over four months of working days in the construction schedule (see www.aisc.org/why-steel/speedcore for more details).

The composite walls can be planar, C-shaped or I-shaped, following the typical geometric configurations of conventional concrete core walls. As research continues, the focus of current work is on improving and optimizing SpeedCore design, and developing a detailed seismic design procedure for the system. Specifically, the seismic design philosophy, response modification factor and pushover results are briefly discussed here.

Seismic Design Philosophy

The SpeedCore system uses coupled walls to resist lateral loads, as shown in Figure 2. This system is expected to undergo significant inelastic deformation in



The ongoing Rainier Square project in Seattle, which is being built using the SpeedCore system.

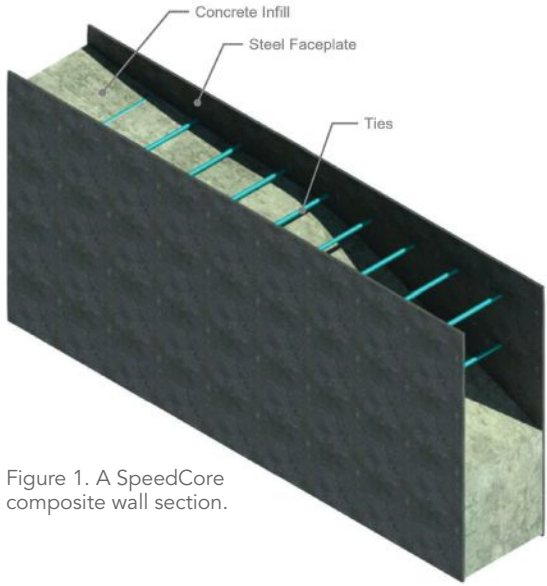
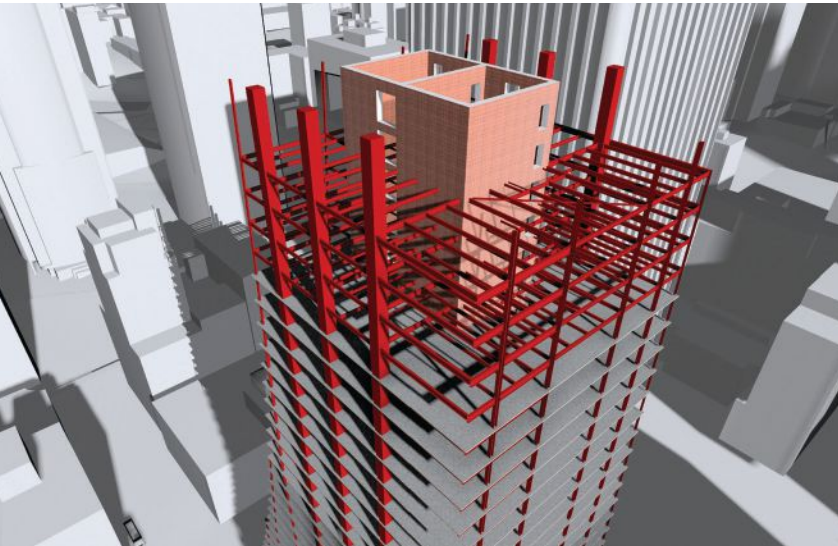

Figure 1. A SpeedCore composite wall section.

conference preview



A model of Rainier Square, showing the steel framing around the SpeedCore system.

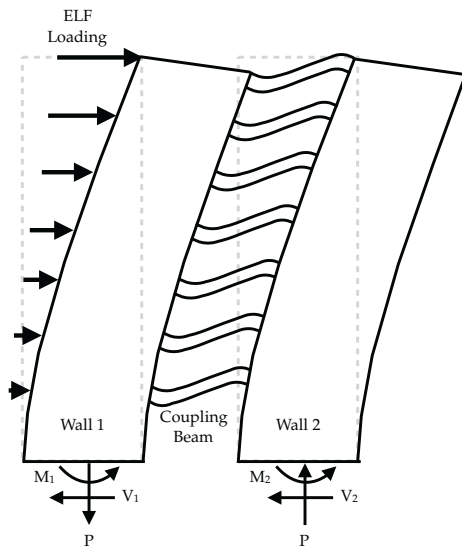

Figure 2. Coupled composite core wall.

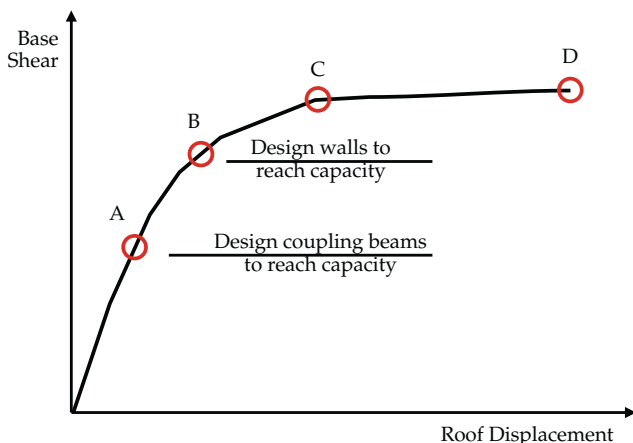

Figure 3. Characteristic pushover (base shear-roof displacement) behavior.

large (design-basis and maximum considered) seismic events. The inelastic deformation has two sources: 1) flexural plastic hinges at the ends of coupling beams and 2) flexural yielding at the base of walls. The preferred inelastic (failure) mechanism consists of forming flexural plastic hinges at both ends of a majority of coupling beams followed by flexural hinging at the base of the composite walls. Essentially, the design implements a strong wall-weak coupling beam approach that must be followed for appropriately sizing the composite members. The coupling beams are designed with beam span-to-depth ratios ranging from 3 to 5.

Following this design philosophy leads to structures with the characteristic pushover behavior depicted in Figure 3. The initial branch represents the elastic behavior of the structure, and the slope of this branch represents the effective structural stiffness which is approximated by elastic models such as those used with the equivalent lateral force (ELF) procedure defined by ASCE 7-16. On the base shear-roof displacement curve, Point A represents the lateral load level corresponding to the ELF distribution. The coupling beams are designed to reach their flexural capacity at this demand. As the lateral load (and base shear force) increases, the coupling beams along the height of the structure undergo flexural plastic hinging at both ends. The response reaches the next milestone, Point B, where a majority of the coupling beams have developed flexural hinges. The composite walls are designed to reach their flexural capacity at this demand level. The next milestone on the response, Point C, corresponds to the overall inelastic mechanism with flexural plastic hinging in the majority of the coupling beams and the base of the composite walls. A final milestone, Point D, represents fracture failure of the composite walls. The overstrength factor for this system, defined as the ratio of ultimate load capacity to capacity at ELF level loads, is approximately the ratio of base shear force at Point C to Point A.

Seismic Response Modification Factor

The seismic response modification factor (R) is given in ASCE 7-16 for composite plate shear walls (individual SpeedCore shear walls) to be equal to 6.5. A FEMA P695 (Quantification of Building Seismic Performance Factors) study is currently underway to evaluate an appropriate R -factor for *coupled* SpeedCore walls, and this cou-

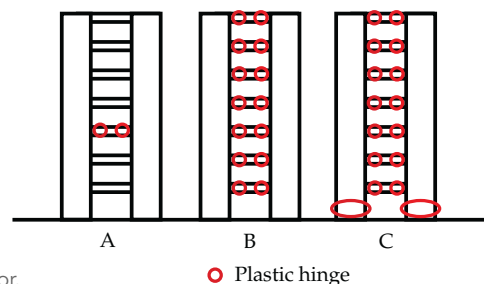

○ Plastic hinge

pled system is expected to have a greater R -factor of 8. This increase in the R -factor for coupled SpeedCore walls is expected due to the spread of plastic hinging and inelastic deformations (energy dissipation) along the height of the structure. Increasing the R -factor allows designers to consider reduced earthquake loads when using ELF procedures. These reduced loads then yield smaller member sizes and more economical designs.

Example Structure and Pushover curves

To showcase the system's behavior, a sample structure is modelled and analyzed using a detailed 3D finite element method. For the FEMA P695 study, archetype structures with 8, 12, 18 and 22 stories and coupling beam span-to-depth ratios of 3, 4 and 5 were designed. These structures were designed to meet composite member and system requirements as laid out in AISC's *Specification for Structural Steel Buildings* (ANSI/AISC 360) and *Seismic Provisions for Structural Steel Buildings* (ANSI/AISC 341); both are available at www.aisc.org/specifications. Seismic demands followed standards set in ASCE 7-16 and the FEMA P695 procedure. The nonlinear static pushover behavior predicted by the finite element model (Figures 4 and 5) follows the expected behavior discussed previously in Figure 3. This sample structure is eight stories tall with a coupling beam span to depth ratio of 5.

SpeedCore research is currently ongoing, with a focus on various topics including developing design criteria and philosophy for seismic and non-seismic design, increasing the seismic response modification factor, evaluating seismic performance and investigating fire resistance. More information on these subjects and the nonlinear time history response of this system will be presented at our session.

For previous coverage of the SpeedCore system, see "Core Solution" in the February 2018 issue at www.modernsteel.com. ■

This article is a preview of the session "SpeedCore and Composite Plate Shear Walls: Current Research and Developments" at the 2019 NASCC: The Steel Conference, taking place April 3-5 in St. Louis. For more information and to register, visit www.aisc.org/nascc.

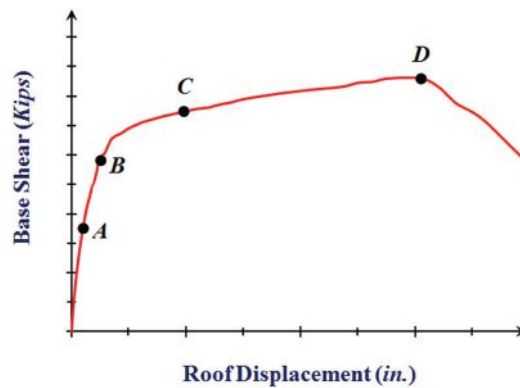

Figure 4. Pushover behavior from 3D FEM analysis.

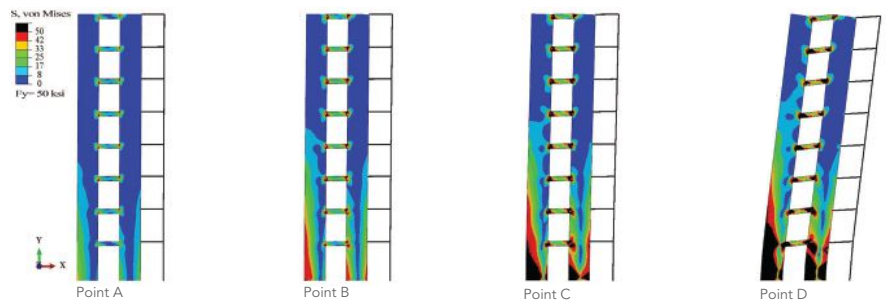



Figure 5. Extent of steel yielding for different points on pushover curve (from 3D FEM analysis).



COMPLETE PART PROCESSING - ALL IN ONE MACHINE

Drilling Coping Marking

DCM1050

Daito's Drilling Coping machine DCM1050 is a multi-tasking machine combining a CNC Drill (with 3 spindles), a CNC Robotic Coper for standard or complicated plasma cuts, and a marking machine for part number marking and welding / layout marking. Each drill has an automatic tool changer to cover tapping, milling, chamfering holes and boring blind holes.

CUTTING



DRILLING



TAPPING



MILLING



PRODUCT CODING



MARKING



COPING





DAITO U.S.A., INC.

1470 Elmhurst Road, Elk Grove Village, IL 60007
Phone 847-437-6788

Website <http://www.daitousa.com>
You Tube <http://www.youtube.com/DAITOUNFO>

You Tube DCM1050



conference preview

TO 3 OR NOT TO 3

RICK J. FORTNEY, SE, PE, PENG, PHD,
AND JOHN HOOPER, SE, PE

Tips on selecting the best seismic system for your next project.



Patrick J. Fortney (patrick.fortney@uc.edu) is an associate professor at the University of Cincinnati, and **John Hooper** (jhooper@mka.com) is director of earthquake engineering with Magnusson Klemencic Associates.

SELECTING THE RIGHT seismic system for your project involves considering many important parameters.

The desired performance level, occupancy or risk category, seismic design category, architectural constraints, ease of repair and cost impacts on the structural steel and foundation packages are just a few of the many items parameters that need to be thought through. Here, we'll provide some brief guidance as well as discuss different types of moment and braced frame systems and system-specific connections.

Let's start with intermediate and special systems. In some cases, structural engineers may evaluate the possibility of using intermediate or special seismic force-resisting systems in regions where "steel systems not specifically detailed for seismic resistance" ($R = 3$) are allowed by code. Typically, this is done to reduce the lateral loads considered during analysis and design, potentially reducing the weight of the structural system and the overall cost of the project. This involves cautious and careful consideration. Figure 1 shows a representation of how lateral loads are potentially reduced as a function of the response modification coefficient, R .

AISC's *Seismic Provisions for Structural Steel Buildings* (ANSI/AISC 341, www.aisc.org/specifications) contains prescriptive requirements for the proportioning of the structure, as well as the analysis and design of the connections, which can potentially have a significant impact on connection costs relative to an $R = 3$ system. Figure 2 shows a comparison of a brace connection designed for an $R = 3$ system and an ordinary concentrically braced frame ($R = 3.25$). As can be determined from Figure 1, the base shear for an $R = 3.25$ system is reduced by 7.7%. This may reduce the weight of the steel package for cases where strength controls over drift. This potential reduction in cost is offset potentially by the cost increase of the brace connections in Figure 2.

On the other hand, reduced base shear and overturning demands may result in significant reductions in foundation costs. A thorough cost-benefit analysis is



required to make an informed decision.

When evaluating the potential for savings by using a seismic force-resisting system other than an $R = 3$ system where not required by code, it may be beneficial to “aim high.” For example, an evaluation of the base shear reduction for a special concentrically braced frame (SCBF) gives a 50% reduction in base shear. The connection requirements for an ordinary concentrically braced frame (OCBF) and an SCBF are similar regarding required connection strength (with some exceptions). The main difference is in the detailing requirements. See the photos for examples of an $R = 3$ brace connection and an SCBF connection. An evaluation of the connection costs must be evaluated for the two systems. The $R = 3$ connection need only be designed for the forces obtained from a linear-elastic analysis with no specific seismic detailing requirements. An SCBF connection must be proportioned to transfer the mechanistic strength of the braces and “special” detailing is required. However, the brace is proportioned based on a 50% reduc-

$R = 3$ connection.

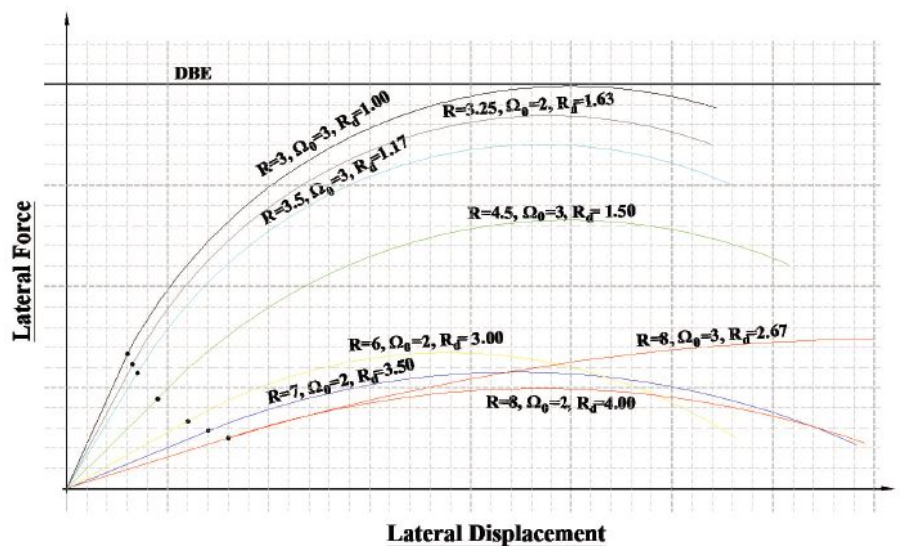

Figure 1. A potential reduction in force demands.

conference preview

tion in seismic loads. Whether there is a reduction or increase in connection costs requires a thoughtful evaluation, combined with a thorough evaluation of the relative costs of the foundations.

For structural engineers contemplating such an approach, we invite you to attend our session at NASCC: The Steel Conference, which we hope will offer meaningful

insight for such considerations. Note that we will also discuss the general seismic design requirements in ASCE 7, the *Seismic Provisions* and also the Specification for Structural Steel Buildings (ANSI/AISC 360, www.aisc.org/specifications) followed by a discussion of project case studies where special seismic force-resisting systems were constructed in areas of low seismicity for the purposes of

reducing overall costs. In addition, the considerations undertaken to make an informed decision will also be presented. ■

This article is a preview of the session "To 3 or Not to 3" at the 2019 NASCC: The Steel Conference, taking place April 3-5 in St. Louis. For more information and to register, visit www.aisc.org/nascc.

Figure 2a. $R = 3$.

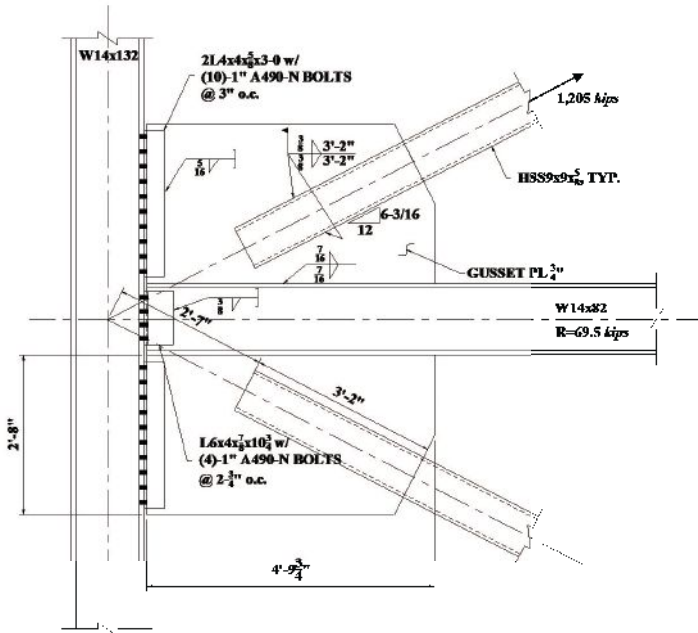
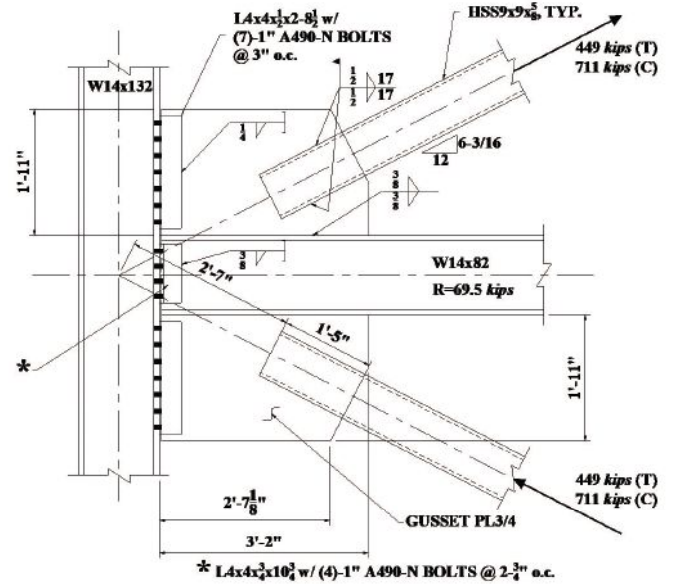

Figure 2b. $R = 3.25$.



SCBF connection.



Steel reduces waste and features a material recovery rate greater than 98%! Structural steel features an incredibly sustainable manufacturing process. Consider these facts:



- The structural steel making process boasts
- a 95% water recycling rate with no external
- discharges, resulting in a **net consumption**
- **of only 70 gallons per ton.**



- **Steel is the most recycled material in the world.** Domestic mills recycle more than 70
- million tons of scrap each year and structural
- steel has a 93% recycled content!



- **Steel production** productivity levels are
- up by a factor of 24 and labor hours have
- been reduced from 12 to just 0.5 per ton.



- **Steel's carbon footprint** is down 37%,
- energy use has decreased 32%, and
- greenhouse gas emissions have
- dropped by 45%.

- Steel is the most
- resilient material,
- designed to last,
- whether it's exposed
- to fire, blast, or the
- ravages of time. And
- when a steel building
- reaches the end of
- its life, the steel is
- recycled and retains all
- of its fantastic physical
- characteristics. Today's
- beams and columns
- are nearly 40%
- stronger and offer
- greater constructability
- benefits!

- The American
- Institute of Steel
- Construction
- provides
- environmental
- product declarations
- (EPDs) for fabricated
- hot-rolled structural
- sections, fabricated
- steel plate and
- fabricated hollow
- structural sections.
- These EPDs cover
- the product life
- cycle from cradle to
- fabricator gate and
- are available at
- **www.aisc.org/epd.**

Are you Earth-friendly?

www.aisc.org/earthfriendly



Smarter. Stronger. Steel.

American Institute of Steel Construction
312.670.2400 | www.aisc.org

news and events

LEGAL NEWS

AISC Welcomes Edward Seglias as General Counsel



AISC proudly welcomes Edward Seglias, Partner at Cohen Seglias Pallas Greenhall & Furman PC, as general counsel. Seglias replaces David Ratterman, who retired at the end of last year after serving as AISC's General Counsel for 30 years.

"I have been delighted to transition the office of general counsel to Ed Seglias over the last three months," says Ratterman. "Ed is an extraordinary lawyer—the perfect person to guide the Institute into the next 100 years of its history. The Institute and its board of directors are in very good hands!"

Bringing more than 25 years of experience, Seglias is a highly regarded trial lawyer, noted for his wealth of experience in construction disputes. He has successfully tried numerous multi-million dollar construction and commercial litigation cases nationwide, including many jury trials. Seglias holds a BA in criminal justice from York College and a JD from Widener Law School.

Seglias is a sought-after lecturer on the subjects of bidding law, delay claims, scope claims and project management. He has created seminars for various trade organizations, including "Construction Project Documentations: Improving Your Chances

for Victory" and "Ignorance is Not Bliss: Contract Terms You Need to Know." He has been ranked on the Pennsylvania Construction List by Chambers USA since 2015. And he is recognized on the Best Lawyers in America List, for Construction Law and Litigation—Construction and on the Pennsylvania Super Lawyers list for Construction Litigation.

"I have known Ed for more than 15 years, going back to when I was practicing law in Philadelphia," commented David Zalesne, president of Owen Steel and AISC's board chair. "We are looking forward to working with Ed as general counsel, along with his partners George Pallas and Jason Copley as assistant general counsel, as we take on a busy agenda for the structural steel industry in 2019."

AISC's president Charlie Carter is looking forward to what the future holds. "I'm excited to be working with Ed and Cohen Seglias to meet the challenge of succeeding David Ratterman, who has served AISC for nearly a third of our history," he said. "We're off to a great start both in starting our traditional practices and also in identifying new ideas and opportunities."



WELDING

AWS Announces Inaugural Inspection Conference, Call for Abstracts

The American Welding Society (AWS) has announced its inaugural Inspection Conference, where experts from AWS, AISC, the American Society for Nondestructive Testing (ASNT) and NACE International (The Corrosion Society) will join forces on a comprehensive array of topics common to corrosion engineering, nondestructive testing, steel construction and welding inspection. Attendees will learn tips, technology and resources to improve the quality of plans, drawings, documentation, visual inspections, procedures and testing processes.

The conference will take place in Houston, Texas, at the Hyatt Regency Houston from January 21 to 23, 2020. Visit www.awo.aws.org for more information.

In addition, the conference's call for abstracts is now open. Inspection professionals are invited to submit abstracts of 150 to 200 words describing original, previously unpublished work for consideration. The work may pertain to current research, actual or potential applications or new developments. Commercialism must be avoided to maintain the high level

of technical quality and integrity of the Inspection Conference series.

All abstract submissions must be completed by June 1, 2019. Submit your application and abstract via email to cbrowne@aws.org. Before submittal, AWS asks that you carefully consider your ability to present your work at the conference. Speakers are required to pay a (reduced) conference registration fee and are responsible for their travel, housing and any related expenses.

NASCC

Registration Now Open for NASCC: The Steel Conference

Just a friendly reminder that registration is now open for the 2019 NASCC: The Steel Conference, taking place April 3-5 in St. Louis. The sooner you register, the more you save! Registration opened on January 2 at \$420 and is increasing on a weekly basis, so be sure to register as soon as you can for the best price.

If you're involved in the design or construction of steel buildings or bridges, The Steel Conference is the premier opportunity to immerse yourself in the latest design concepts, construction techniques and cutting-edge research while engag-

ing with thousands of industry professionals. We have many great things in store for this year, including more than 140 sessions, an extensive trade show and plenty of opportunities for networking. Additionally, there will be three keynote sessions, demonstrations from Student Steel Bridge Competition teams, a special "Women Who Weld" workshop and of course the Welcome Reception and Conference Dinner.

Visit www.aisc.org/nascc to register and to view more conference information, including the Advance Program. See you in St. Louis!

PUBLICATIONS

Latest Revision to AISC Nuclear Specification Now Available For Free Download

The 2018 version of the AISC standard, *Specification for Safety-Related Steel Structures for Nuclear Facilities* (ANSI/AISC N690-18), is now available for free download at www.aisc.org/standards. The updated standard includes changes that are compatible with the baseline document, the 2016 AISC *Specification for Structural Steel Buildings* (ANSI/AISC 360-16), and it replaces ANSI/AISC N690-12 including Supplement No. 1 (ANSI/AISC N690s1-15).

"New provisions in this version of the standard include acceptable methods to design for impactive and/or impulsive loadings, and ductility ratios for steel plate structures," explained Ronald Janowiak, chairman of the AISC Task Committee on Nuclear Facilities that developed the updated standard. "Also, to facilitate welded construction, welds on safety-related material are required to be uniquely identified and traceable. Several new User Notes provide design guidance, including help with establishing material properties when designing

for impactive and/or impulsive loads, addressing thermal loads from abnormal load conditions, and guidance for visual weld acceptance criteria."

The new standard has been approved by the AISC Committee on Specifications and is ANSI-accredited.

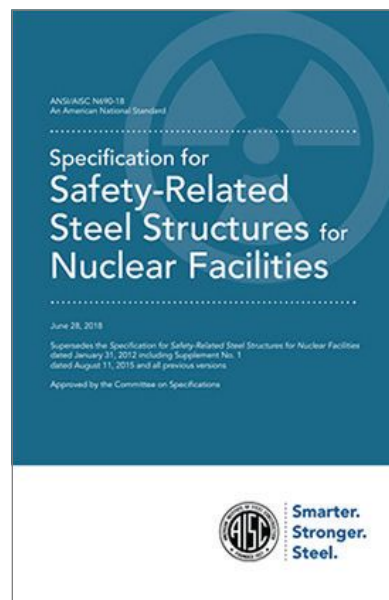

PEOPLE AND FIRMS

- **Amit Varma, PhD**, was recently ratified as **Purdue University's** Karl H. Kettelhut Professor in Civil Engineering. Varma has been with Purdue since 2004 and has been serving as the director of the **Bowen Laboratory for Large-Scale Civil Engineering Research** since 2017. He is the recipient of an AISC Special Achievement Award for his work with nuclear power plants and was also the winner of the AISC Milek Faculty Fellowship Award in 2003. Additionally, Varma serves as the Chair of the AISI/AISC Fire Committee and is also a member of five other AISC committees.
- **Michel Bruneau, PhD**, has been named a SUNY Distinguished Professor, the highest faculty rank in the **State University of New York (SUNY)** system. A professor in the **University at Buffalo's Department of Civil, Structural and Environmental Engineering** and a past AISC T.R. Higgins award winner, Bruneau received the honor in recognition of his international prominence and distinguished reputation within the field of civil engineering.
- **The Lincoln Electric Company**, which develops and manufactures arc welding and plasma and oxyfuel cutting equipment as well as robotic welding systems, announced that it has acquired **Inovatech Engineering Corporation**, a maker of advanced robotic plasma cutting solutions for structural steel applications, and related assets. Both companies are AISC associate members.
- **SidePlate Systems** (an AISC associate member) has announced that its all-field-bolted SidePlate PLUS Steel Moment Frame connection has been added to Supplement No. 1 of AISC's *Prequalified Connections for Special and Intermediate Steel Moment Frames for Seismic Applications* (ANSI/AISC 358s1-18), available at www.aisc.org/specifications.
- Bridge engineering firm **Modjeski and Masters** has announced the opening of its newest office in Austin, Texas, its first office in the Lone Star State. This new office is the company's 12th location nationwide and will be led by former **Texas Department of Transportation (TxDOT)** Bridge Division retiree **John Holt, PE**, who will be responsible for managing operations in Texas and the surrounding region.

news and events

IN MEMORIAM

Werner H. Quasebarth, Former AISC Director and Chairman, Dies

Werner H. Quasebarth, retired CEO of Atlas Machine and Iron Works, Inc., and former AISC Chairman (1985-1987) and director (1977-1998), died on December 26, 2018, at the age of 87. He was dedicated to an active life of service through his leadership in industry and community organizations.

Quasebarth served as Chairman and CEO of Atlas, which was founded by his father in 1931, from 1975 until his retirement in 1998. Atlas engineered, fabricated and built heavy metal weldments for steel bridges, complex multi-story buildings and nuclear power plants. Notable achievements include the construction of the Netherlands Carillon near Arlington National Cemetery, the original control tower at Dulles International Airport, the FBI Building in Washington, D.C., and many highway and Interstate bridges. Participating in the construction of the World Trade Center was a hallmark of Quasebarth's career and a source of pride to Atlas' many highly qualified engineers and steel workers.

In addition to AISC, Quasebarth served as a director and Chair of the the American Welding Institute and as counselor to the American Welding Society. He was also an active member of the Young Presidents' Organization; a director of Ross Industries, the National Capital Bank and the C.M. Russell Museum in Montana; and a member of the Virginia State Bar Disciplinary Board.

Quasebarth was known for his sense of adventure, love of storytelling and drive, especially in supporting his team to be creative regarding steel fabrication. Former AISC president and Board Member Louis Gurthet has fond memories of Quasebarth, noting, "Werner was a gracious and true gentleman who provided leadership during important times of AISC's history."

Arthur Miles, former president at Atlas, said, "Werner was unique in the industry. He would look, assess and try developing new pieces of equipment to fit the growing needs. He was not a sedentary person at all. He would go to conferences and everyone would be waiting for his return,

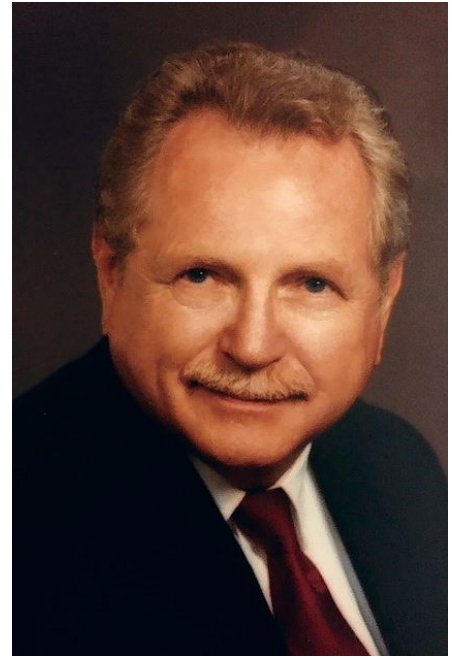

anxious about 'what crazy thing is he going to come back with.' He pushed us and he pushed the industry."

letter to the editor

Tight Fit

I must bring to your attention an inaccuracy published in the December 2018 article "Silica Safety" (www.modernsteel.com).

Regarding dust filter masks, the article incorrectly states that "there is no qualitative or quantitative fit test for this type of respirator." This is not accurate, and indeed there are circumstances under which fit testing of dust masks is required under OSHA's respiratory protection standard. Generally speaking, any time a permissible exposure limit is exceeded, the entire requirements of the *Respiratory Protection Standard* (1926.103/1910.134) apply, including fit testing for respirators, which rely on a tight seal in order to be protective.

—*Sarah Fobes*
safety, health and environmental coordinator,
chemical manufacturing industry

Response from author Kathleen Dobson:

After further research, here is a clarification:

OSHA requires qualitative or quantitative fit tests for any type of tight-fitting respirator. An N95 filtering face mask used to meet the assigned protection factor (APF) of 10 under Table 1 meets OSHA's criteria of "tight-fitting." Employers should contact their distributor for specific testing requirements and supplies. Do not assume that there are no qualitative or quantitative fit test for this type of respirator, and be aware there are instructions for testing the seal (on the respirator packaging) that a worker should follow every time they use one.

Additionally, OSHA has recently clarified that a medical evaluation for silica is not mandatory; workers may refuse the examination. That said, make certain that any refusals are documented and that you continue to offer the evaluation annually.

marketplace & employment

Structural Engineers

Are you looking for a new and exciting opportunity?

We are a niche recruiter that specializes in matching great structural engineers with unique opportunities that will help you utilize your talents and achieve your goals.

- We are structural engineers by background and enjoy helping other structural engineers find their "Dream Jobs."
- We have over 30 years of experience working with structural engineers.
- We will save you time in your job search and provide additional information and help during the process of finding a new job.
- For Current Openings, please visit our website and select Hot Jobs.
- Please call or e-mail Brian Quinn, PE (616.546.9420 or Brian.Quinn@FindYourEngineer.com) so we can learn more about your goals and interests.
All inquiries are kept confidential.

SE Impact by SE Solutions, LLC | www.FindYourEngineer.com

Plant Manager

One of the leading structural steel fabricator in the nation is seeking a Plant Manager for its Southeast location. Complete responsibility of steel fabrication including but not limited to productivity, safety, quality, employee relations, equipment maintenance, and training. This person shall be familiar with work scheduling and diverse work force planning, shipping and on time delivery, understanding of fabrication codes and standards, familiarity with Peddinghaus and Controlled Automation equipment, budgets and forecasting, continuous improvement processes, and Fabtrol software experience.

Plant Manager shall provide leadership by promoting team concepts, coaching, counseling, retaining, mentoring, training, and individual development. Drives a culture of accountability and results through strategy deployment and effective performance management.

Demonstrated ability to organize and manage multiple priorities using effective problem solving/resolution skills and a team focus. Excellent interpersonal and communication skills.

10 years' experience as Plant Manager or 15 years of experience as supervisor in multiple departments including parts, fit & weld, and painting department for a fabricator over 100 employees and over 20,000 Tons annually.

Excellent interpersonal and communication skills required. Send all resumes to P.O. Box 362, Cedar Mi. 49621 or ggraber@gurthetmedia.com.



Interested in business development and making structural steel the material of choice?

AISC has a job for you!

now hiring in

Los Angeles ★ New York ★ Washington, D.C.

.....
to learn more visit
www.aisc.org/mynextcareer

LATE MODEL STRUCTURAL STEEL FABRICATING EQUIPMENT

Peddinghaus FPDB-2500 CNC Heavy Plate Processor, 96" W, (3)

Spindles, HPR260 Plasma, (1) Oxy, Siemens 840D, 2008 **#27974**

Controlled Automation DRL-336 CNC Beam Drill, 36" x 18", (3)

15 HP Spindles, Hem WF140 Tandem Saw, 2005 **#29344**

Peddinghaus PCD-1100 CNC Beam Drill, 44" x 18", (3) Spindles,

13.5 HP, 900 RPM, 3" Max. Diameter, 13" Stroke, 2008 **#29286**

Controlled Automation DRL344 CNC Beam Drill Line, Hem

WF140 Saw, Tandem Line, 2008 **#24937**

Ficpep Gemini 324PG Plate Processor, 10' x 40', 15 HP Drill,

HPR260XD Plasma Bevel Head, (1) Oxy, 2014 **#28489**

Ficpep Gemini 36-HD Plate Processor, 12' x 40', 35 HP Drill,

HPR400XD Plasma Bevel Head, 2012 **#28490**

Peddinghaus 623-0 CNC Angle Line, 6" x 6" x 5/8" Capacity, 75

Ton Punch, 230 Ton Shear, Siemens CNC Ctrl, 2006 **#29317**

www.PrestigeEquipment.com | Ph: +1.631.249.5566
sales@prestigeequipment.com

Search employment ads online at www.modernsteel.com. To advertise, call 231.995.0637 or email renae@gurthetmedia.com.

advertiser index

AISC	8 16 33 45 61	Peddinghaus Corporation	2
Applied Bolting Technology	12	Qnect	53
Bull Moose Industries	back cover	QuickFrames USA	39
Cast Connex Corporation	37	SDS/2	7
Chicago Metal Rolled Products	insert	Sideplate	14
CoreBrace	53	St. Louis Screw & Bolt	39
Daito USA	57	Steel Erectors Association of America	43
Dowco Consultants	15	Trimble	11
FICEP Corporation	13	Voortman Corporation	31
IES	5	Vulcraft	3
Infra-Metals	67		

structurally sound

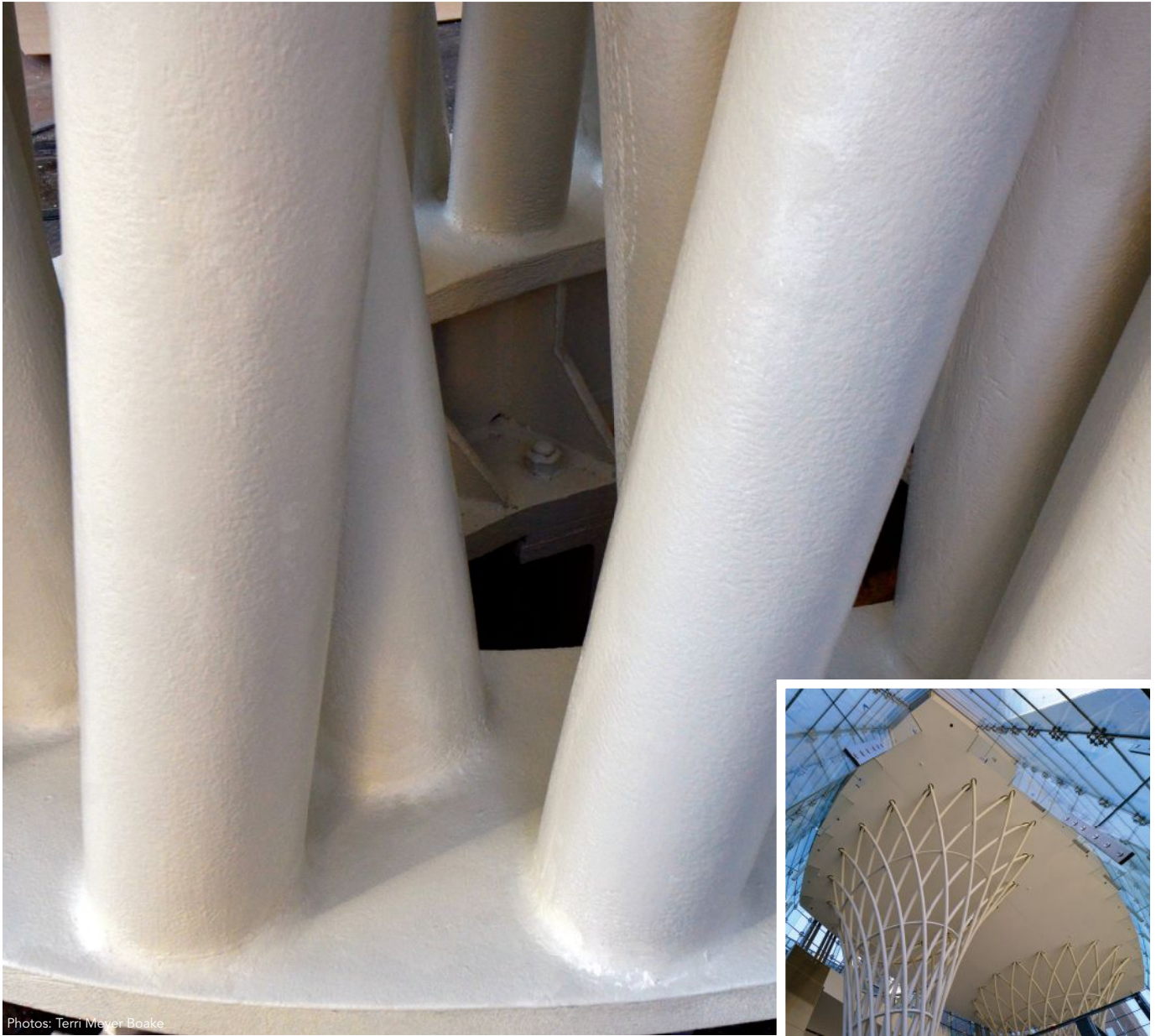

Photos: Terri Meyer Boake

GRINDING IT OUT

TO GRIND WELDS OR NOT TO GRIND WELDS ON EXPOSED STRUCTURAL STEEL? That is the question.

In most situations, the answer is no. But too often, it is performed unnecessarily. Understanding AISC's new category approach to architecturally exposed structural steel (AESS) can help you maximize exposed steel aesthetics while eliminating unnecessary costs like weld grinding.

Want to learn more? Check out the 2019 NASCC: The Steel Conference session "Architecturally Exposed Structural Steel (AESS): Communicating for Success," which will cover all aspects of AESS, including weld grinding, as well as discuss successful sam-

ple projects—such as New York's Brookfield Place Entry Pavilion, a 2014 AISC IDEAS² Award winner, pictured above (see the May 2014 issue at www.modernsteel.com for more). And it's just one of more than 140 sessions at this year's show, taking place April 3-5 in St. Louis! (Registration is now open; visit www.aisc.org/nascc.)

You can get a sneak peek of this session—and several others—in the March issue, which will include multiple preview papers for the show. On top of that, we'll also be distributing a special The Steel Conference issue in mid-March, which will include additional preview papers, the Final Program and the Exhibitor List.



WWW.INFRA-METALS.COM



DELTA STEEL, INC.

WWW.DELTASTEEL.COM

YOUR #1 DOMESTICALLY PRODUCED SUPPLIER

EXTENSIVE INVENTORY | FIRST STAGE PROCESSING | INDUSTRY LEADING CUSTOMER SERVICE



Wallingford, CT
800-243-4410

Langhorne, PA
800-899-3432

Baltimore, MD
800-235-3979

Marseilles, IL
800-987-5283

Petersburg, VA
800-435-0850

New Boston, OH
877-741-8806

Atlanta, GA
INFRA-METALS / IMS
800-833-9175

Tampa, FL
800-693-1361

Hallandale, FL
800-432-1146



Houston, TX
800-324-0220

San Antonio, TX
800-292-5828

Fort Worth, TX
800-772-2762

Cedar Hill, TX
800-284-7321

Chicago Heights, IL
800-772-2762

HOLLOW STRUCTURAL STEEL TUBE FROM BULL MOOSE

**BUILD A
LANDMARK.**



For projects that will stand the test of time, start with Bull Moose HSS tube.

Our direct-form manufacturing process enables us to use the highest grade HSLA steel...and form it directly into a tube.

With sizes ranging from 1.5" square to 18"x6", and wall thicknesses from 1/8" through 5/8", Bull Moose features one of the largest size ranges of HSS products in the industry.

For strength, versatility and reliability, build with Bull Moose.

BULL MOOSE ADVANTAGES

- Strength ranges of 46 KSI to 110 KSI
- Tighter tolerances, sharper edges, and straighter tubes
- Widest variety of custom sizes/lengths, including metric
- In-line NDT weld testing available on all tube
- Readily available weathering grade steel
- Fast delivery with 8 domestic sites



BULL MOOSE
For exceptional strength.

1819 Clarkson Rd.
Chesterfield, MO 63017

800.325.4467 | BULLMOOSETUBE.COM