

Modern Steel Construction

December 2019



HIGH SPEED ROBOTIC

STEEL BEAM ASSEMBLY

- Accomplishes work of 5 fitters per shift
- Maintains 1/24" accuracy over 60' profiles
- Fit and tack pieces at 1.5 minutes per part

www.peddinghaus.com/peddiassembler



THE
PEDDIASSEMBLER

Peddinghaus

STRONGER THAN STEEL®

www.peddinghaus.com | info@peddinghaus.com | (815) 937-3800



The Best in Steel MIS Just Got Better



The Power of FabSuite Plus a Whole Lot More

The industry's next generation of steel fabrication management software is here. Tekla PowerFab is a software suite that combines the power of FabSuite with other Tekla solutions to deliver next-level performance in estimating accuracy and project collaboration.

Learn more at: www.TeklaPowerFab.com



IS NOW



Modern Steel Construction

December 2019



40

in every issue

departments

- 6 EDITOR'S NOTE
- 9 STEEL INTERCHANGE
- 12 STEEL QUIZ
- 62 NEWS & EVENTS
- 66 STRUCTURALLY SOUND

resources

- 65 ADVERTISER INDEX
- 65 MARKETPLACE & EMPLOYMENT

features

- 26 Pivot Point**
BY SUZY DeHORATIIS, JASON MYERS, SE, PE, AND TIMON HAZELL
A D.C. area school brings a new twist to education facility design in the form of five stacked steel-framed sections that fan around a pivot.
- 32 Wide Load**
BY THOMAS POULOS, SE, PE, ROBERT STADLER, SE, PE, AND PETER KONOPKA, SE, PE
Steel facilitates the massive spans required for the world's largest dual-access aircraft hangar.
- 40 Crossing the Creek**
BY ROBERT ANDERSON, SE, PE, TREVOR KIRKPATRICK, PE, AND KEVIN SWEAT, PE
A new steel bridge comes together over a downtown waterway in Texas' capital city thanks to well-planned and executed design and construction.

- 48 Combatting Chromium**
BY KATIE RICHARDSON
Hexavalent chromium is a legitimate safety hazard when welding stainless steel. But it can be removed from the equation with proper safety equipment and practices.
- 52 Writing the Book on BIM**
BY LUKE FAULKNER
A new AISC publication covers the basics of 3D modeling and virtual design and construction as they relate to the structural steel industry.
- 56 Steel Across America**
BY GEOFF WEISENBERGER
SteelDay brought students and the AEC community together at job sites, mills, fabrication shops, and other locations all across the country.

columns

steelwise

- 16 Structural Vibration Serviceability**
BY BRAD DAVIS, SE, PhD, AND JEREMY SALMON, SE, PE
Exploring advanced design methods in AISC's guide on vibrations.

business issues

- 22 Brand Maintenance**
BY DAN COUGHLIN
Deliberately and carefully build, strengthen, and protect your organization's brand.

ON THE COVER: This suburban D.C. school takes a layered approach to education, p. 26. (Photo: Gilbane)

MODERN STEEL CONSTRUCTION (Volume 59, Number 13) ISSN (print) 0026-8445; ISSN (online) 1945-0737. Published monthly by the American Institute of Steel Construction (AISC), 130 E Randolph Street, Suite 2000, Chicago, IL 60601. Subscriptions: Within the U.S.—single issues \$6.00; 1 year, \$44. Outside the U.S. (Canada and Mexico)—single issues \$9.00; 1 year \$88. Periodicals postage paid at Chicago, IL and at additional mailing offices. Postmaster: Please send address changes to MODERN STEEL CONSTRUCTION, 130 E Randolph Street, Suite 2000, Chicago, IL 60601.

DISCLAIMER: AISC does not approve, disapprove, or guarantee the validity or accuracy of any data, claim, or opinion appearing under a byline or obtained or quoted from an acknowledged source. Opinions are those of the writers and AISC is not responsible for any statement made or opinions expressed in MODERN STEEL CONSTRUCTION. All rights reserved. Materials may not be reproduced without written permission, except for noncommercial educational purposes where fewer than 25 photocopies are being reproduced. The AISC and Modern Steel logos are registered trademarks of AISC.



Printed on paper made from a minimum of 10% recycled content.

1-800-801-3648



“Zinc Protects Steel”®

V&S GALVANIZING

With over 100 years of hot-dip galvanizing experience, we believe in safely doing what we say we'll do and continually investing in our people, our equipment and our experience to ensure **Total Customer Satisfaction.**

“STEEL” THE SHOW

with Hot-Dip Galvanizing

DIP AND SPIN
GALVANIZING
TO ASTM A153

CRANE
CAPACITY
20 TONS

UP TO 85'
PROGRESSIVE
DIP

KETTLE RANGE
30' - 56'
IN LENGTH

www.HotDipGalvanizing.com

OUR LOCATIONS: Columbus, OH • Memphis, TN
Owego, NY • Taunton, MA • Detroit, MI
Perth Amboy, NJ • New Castle, DE • Jonestown, PA

editor's note



For almost three decades, my friend and colleague (and now boss) Charlie Carter and I have enjoyed arguing. Stylistically, as we explore answers to whatever we're working on, we take opposite sides and debate the issue. It doesn't matter who takes which side—and we're perfectly willing to switch sides in the middle.

But deep down, we do have different philosophical approaches, and you can see this reflected in many major AISC programs.

Charlie is Pete "Maverick" Mitchell in *Top Gun*, and you can see it most clearly reflected in AISC's newest initiative, where we plan to cut in half the time it takes to design, fabricate, and build steel buildings and bridges. We even made t-shirts announcing "We feel the need for speed."

My hero is Lewis from *Meet the Robinsons*. And I like to remember Walt Disney's quote from the end of that movie: "Around here, however, we don't look backwards for very long. We keep moving forward, opening up new doors and doing new things... and curiosity keeps leading us down new paths." And I like to think that's the philosophy we employ when planning NASCC: The Steel Conference.

In 2020, the Steel Conference travels a new path to Atlanta (mark your calendars for April 22–24). Of course, we'll have nearly 200 fantastic technical sessions. Yes, there'll be more than 200 innovators in the exhibit hall. And, for sure, you'll have time to network with more than 5,000 industry leaders.

But we're also expanding the scope. For a long time, we've offered The Steel Conference and the SSRC Annual Stability Conference. A few years ago, we added the World Steel Bridge Symposium. And this year we're adding a steel conference for architects, the NISD Steel Detailing Conference, and a 23-session QualityCon.

We continue to offer our welcome reception in the exhibit hall on Wednesday evening, but rather than holding an exclusive dinner on Thursday night, we're opening the event to all full attendees and making it a dynamic block party.

The advance program, which describes the full program in great detail, will be available next month and registration opens on January 20—and we hope you'll register early, as registration rates increase \$10 each week. When you do review the program, let me know if there's something we should be doing that we're not, if there's a seminar topic we're missing, or an exhibitor who should be there but isn't. We've already started planning the 2021 Steel Conference and we're counting on you to help us keep moving forward!

Scott Melnick
Editor

Modern Steel Construction

Editorial Offices

130 E Randolph St, Ste 2000
Chicago, IL 60601
312.670.2400

Editorial Contacts

EDITOR AND PUBLISHER

Scott Melnick
312.670.8314
melnick@aisc.org

SENIOR EDITOR

Geoff Weisenberger
312.670.8316
weisenberger@aisc.org

DIRECTOR OF PUBLICATIONS

Keith A. Grubb, SE, PE
312.670.8318
grubb@aisc.org

PRODUCTION COORDINATOR

Erika Salisbury
312.670.5427
salisbury@aisc.org

GRAPHIC DESIGN MANAGER

Kristin Hall
312.670.8313
hall@aisc.org

AISC Officers

CHAIR

Jack Klump, Cianbro Fabrication
& Coating Corporation

VICE CHAIR

Stephen Knitter
Geiger & Peters, Inc.

SECRETARY/LEGAL COUNSEL

Edward Seglias, Cohen Seglias
Pallas Greenhall & Furman, PC

PRESIDENT

Charles J. Carter, SE, PE, PhD

SENIOR VICE PRESIDENT

Scott Melnick

VICE PRESIDENT

Lawrence F. Kruth, PE

VICE PRESIDENT

Tabitha S. Stine, SE, PE

VICE PRESIDENT

Mark W. Trimble, PE

Editorial Advisory Panel

Caroline R. Bennett, PE, PhD
University of Kansas

Amanda Dean, PE

Walter P Moore

Bryan Frazier,
Zalk Josephs Fabricators, LLC

Keith R. Griesing, PE
Hardesty and Hanover

Stephen Knitter

Geiger & Peters, Inc.

Advertising Sales

M.J. Mrvica Associates, Inc.

2 W Taunton Avenue

Berlin, NJ 08009

856.768.9360

mjmrsvica@mrsvica.com

Address Changes and Subscription Concerns

312.670.2401

subscriptions@aisc.org

Reprints

Erika Salisbury

312.670.5427

salisbury@aisc.org

INTELLIGENT AUTOMATION EQUALS PRODUCTIVITY

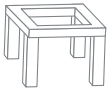

Recognizes and Automatically **ADAPTS TO FRAMING CONDITIONS**

SDS/2 takes a uniquely intelligent approach to its connection design by considering framing conditions and erectability.

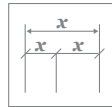

Reduces Detailing Time **WITH CUSTOM TEMPLATES**

SDS/2 allows detailing drawings to be customized to your detailing and fabrication standards, reducing time spent on cleanup.



Creates Multi-User Environment **TO STREAMLINE WORKFLOW**

With SDS/2, everyone works in the live model simultaneously; there's no need to check the model in or out.

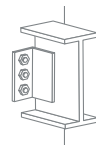

Conducts Code-Based **JOINT ANALYSIS**

Only SDS/2 automatically performs clash detection and prevention as part of its connection design, which leads to savings in the shop.



Integrates to the **SHOP, FIELD AND OFFICE**

SDS/2's intelligence allows for seamless transfer of information from start to finish.



ENSURES FIT-UP in Field

With SDS/2, if it fits in the model, it fits in the field.

See how SDS/2 can increase your bottom line at
[SDS2.COM/PRODUCTIVITY](https://www.sds2.com/productivity)



www.sds2.com
800-443-0782 // 402-441-4045 (fax)
1501 Old Cheney Rd., Lincoln, NE 68512



Need PDHs? We've got you covered.

AISC Continuing Education

Education Archives

Did you know that AISC offers 1- to 6-hour presentations on demand? Viewing is free—whether it's from the convenience of your office or snowed-in at home! And if PDHs are what you're after, you can purchase, take and pass a quiz to earn a certificate. With over 200 hours of options (50 hours added in 2019!), your educational needs are sure to be covered.

aisc.org/educationarchives

Live Webinars

- 12/3 Introduction to the FHWA Bridge Welding Reference Manual (1.5 PDHs)
by Ronnie Medlock
- 12/5 Design of Curved Members, Part 1 (1.5 PDHs)
by Bo Dowswell
- 12/12 Design of Curved Members, Part 2 (1.5 PDHs)
by Bo Dowswell

aisc.org/webinars



Smarter. Stronger. Steel.

American Institute of Steel Construction
312.670.2400 | www.aisc.org

If you've ever asked yourself "Why?" about something related to structural steel design or construction,

Modern Steel's monthly Steel Interchange is for you!

Send your questions or comments to solutions@aisc.org.

steel interchange

All referenced AISC publications, unless noted otherwise, refer to the current version and are available at aisc.org/specifications. Modern Steel Construction articles can be found in the Archives section at www.modernsteel.com, and AISC Design Guides are available at aisc.org/dg.

Weld Strength at Elevated Temperatures

I am trying to evaluate the strength of welds at elevated temperatures. Do you have any references you could direct me to that might help?

Note that the design of welds at elevated temperatures falls outside the scope of the AISC *Specification for Structural Steel Buildings* (ANSI/AISC 360). The following references may be helpful. Reduction factors for welds at elevated temperatures are addressed in a Lehigh University research report, "Strength of Transverse Fillet Welds at Elevated and Post-Elevated Temperatures" (visit tinyurl.com/luweldtemp). The data was based on experimental data from transverse fillet weld tests. Also, the article "Effects of Temperature on Weld Metal Properties" in the August 1954 *Welding Research Supplement* discusses testing of all-weld-metal tension specimens, resulting in similar strength reductions.

Bo Dowswell, PE, PhD

Welding Plate Washers to Base Plates

If I am using the recommended hole sizes in Table 14-2 of the 15th Edition AISC Steel Construction Manual, do the plate washers need to be welded to the base plate?

It is generally not recommended to transfer shear through the anchor rods. Note that if the base plate is transferring axial load only, then it is not necessary to weld the plate washers to the base plate. If there is a shear force, you could consider a few options for transferring this load:

- Friction
- Bearing of the base plate and/or shear lug against concrete
- Shear in the anchor rods—plate washers not welded (not recommended; use with caution)
- Shear in the anchor rods—plate washers welded (not recommended; use with caution)

Note that more information on each of these methods can be found in AISC Design Guide 1: *Base Plate and Anchor Rod Design*.

The larger base plate hole sizes combined with placement tolerances of the anchor rods will likely result in conditions where not all of the anchor rods in a pattern are equally loaded. To account for this, the authors of the guide recommend a conservative approach of using only half of the anchor rods to transfer

the shear unless "special provisions are made to equalize the load to all anchor rods." As stated in the guide: "Lateral forces can be transferred equally to all anchor rods, or selective anchor rods, by using a plate washer welded to the base plate between the anchor rod/nut and the top of the base plate."

Welding the washers will ensure a more equal distribution of forces into the anchor rods. If no welds are used, then a more conservative approach, as suggested by the authors, is needed. You will also have to consider the effect of the significant slip that occurs before the base plate bears against the anchor rods.

Carlo Lini, PE

Responsibility for Lintels

A current project we are fabricating includes lintels that are supported by brick in some locations and cold-formed metal studs in others. The erector that is working for us has indicated that this work was not included in their contract. However, they did not specifically exclude this work in their contract either. Is there any document that addresses this issue?

Per the AISC *Code of Standard Practice for Steel Buildings and Bridges* (ANSI/AISC 303), the lintels you describe would not be provided by the fabricator unless the fabricator was specifically required to supply these lintels in the contract documents. The fact that you, as the fabricator, agreed to provide these lintels does not automatically convey responsibility for erecting these lintels to the structural steel erector. The lintels supplied would fall under *Code* Section 2.2, which includes other items (such as embed plates) that, if furnished, are installed by others. Unless the contract specifically requires the erector to install these lintels, they would be supplied to be installed by others.

Section 2.1 of the *Code* contains a user note that states: "The fabricator normally fabricates the items listed in Section 2.1." Section 2.1 defines the elements of the structural frame that are considered structural steel. Included in Section 2.1 are "Lintels, if attached to the structural steel frame." If the lintels are attached to the structural steel frame, then it is the responsibility of the fabricator to provide these lintels unless stated otherwise in the contract documents. Note that the lintels will need to be shown and sized in the structural design documents.

Section 2.2 refers to other items not classified as structural steel. Included in this list are "Cold-formed steel products" and "Lintels, if not attached to the structural steel frame." A user note in this section states: "Section 2.2 includes many items that may be furnished by the fabricator if contracted to do so by specific notation and detail in the contract documents. When such



Carlo Lini (lini@aisc.org) is AISC's director of technical assistance.

Bo Dowswell, principal with ARC International, LLC, and **Larry Muir** are both consultants to AISC.

items are contracted to be provided by the fabricator, coordination will normally be required between the fabricator and other material suppliers and trades.”

Carlo Lini, PE

Weld Access Hole Requirements for RBS Moment Connections

Section 5.5(2) of AISC *Prequalified Connections for Special and Intermediate Steel Moment Frames for Seismic Applications* (ANSI/AISC 358-10) states: “Weld access hole geometry shall conform to the requirements of the AISC *Specification*.” However, we typically see the alternate geometry, covered in AWS D1.8, provided. Is this allowed for RBS moment connections?

Section J1.8 of the *Specification* provides requirements for weld access holes. I believe that the alternative geometry for weld access holes specified in Section 6.11.1.2 of AWS D1.8/D1.8M will satisfy the requirements of Section J1.8 of the *Specification*, so the weld access holes specified in Section 6.11.1.2 of AWS D1.8/D1.8M are permitted but not required when using RBS connections. Section 6.11.1.1 in AWS D1.8/D1.8M states: “Unless otherwise stated in Contract Documents, all weld access holes shall meet the dimensions and tolerances of AWS D1.1/D1.1M or AISC 360. At the option of the Contractor, the geometry of 6.11.1.2 may be substituted for the 6.11.1.1 geometry.”

The Commentary to AISC 358-10 states: “Test specimens have employed a range of weld access-hole geometries, and results suggest that connection performance is not highly sensitive to the weld access-hole geometry. Consequently, prequalified RBS connections do not require specific access-hole geometry. Weld access holes should satisfy the requirements of Section 6.11 of AWS D1.8/D1.8M (AWS 2016). The alternative geometry for weld access holes specified in Section 6.11.1.2 of AWS D1.8/D1.8M is not required for RBS connections.”

Fabricators should conform to whatever requirements are included in the contract documents. I suspect fabricators are split as to whether they prefer to provide the Section J1.8 weld access hole or the AWS D1.8 weld access hole. And I suspect more would be in favor of the Section J1.8 weld access hole. Just as an example, I have sketched the access hole for a W24x55 beam based on the requirements in Section J1.6 of the *Specification* and based on the alternate geometry per Section 6.11.1.2 in AWS D1.8 (see Figure 1). Note that for the alternate geometry, I used Table 1-1 and 1-3 in the 3rd Edition AISC *Seismic Design Manual*. Keep in mind that use of a larger weld access hole will result in a reduction in shear strength of the beam web.

Larry Muir, PE



Steel Interchange is a forum to exchange useful and practical professional ideas and information on all phases of steel building and bridge construction. Contact Steel Interchange with questions or responses via AISC's Steel Solutions Center: 866.ASK.AISC | solutions@aisc.org

The complete collection of Steel Interchange questions and answers is available online at www.modernsteel.com.

The opinions expressed in Steel Interchange do not necessarily represent an official position of the American Institute of Steel Construction and have not been reviewed. It is recognized that the design of structures is within the scope and expertise of a competent licensed structural engineer, architect or other licensed professional for the application of principles to a particular structure.

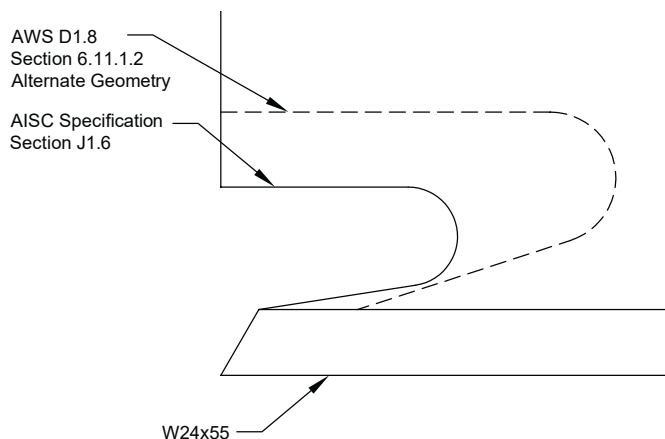

Fig. 1.



“Practical tools
for professionals”

Structural Software

is easy and affordable at iesweb.com

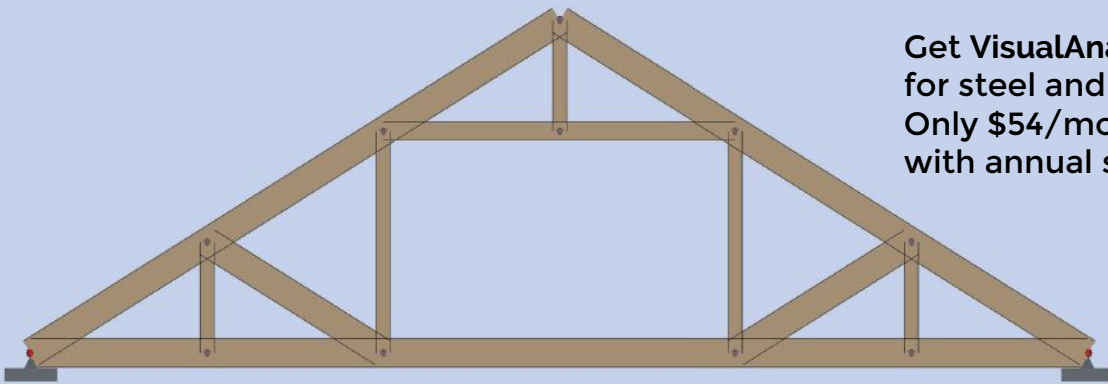

Get VisualAnalysis 2D Design
for steel and wood frames.
Only \$54/month
with annual subscription.

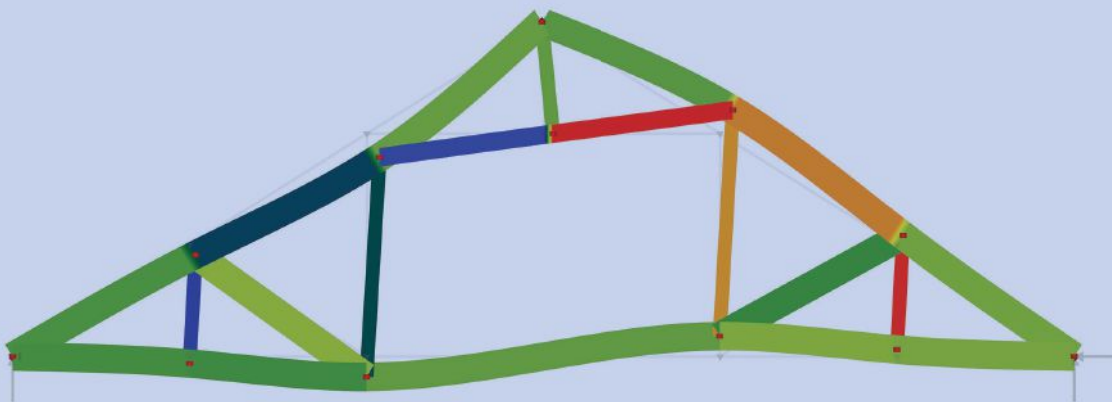

Download your free trial today:

iesweb.com

800.707.0816



steel quiz

This month's Quiz focuses on software and technology.

- 1 True or False:** Many structural analysis software programs rely on the direct stiffness method to determine the reaction forces, nodal displacements, and rotations of members in a frame during a linear analysis.
- 2** What is the general equation related to the direct stiffness method, that needs to be solved? (Provide your answer in vector form.)
- 3 True or False:** The AISC *Guide to BIM & VDC* is intended to set a standard of practice and serve referenceable document for the implementation of BIM (building information modeling) in the structural steel industry. (Hint: Listen to Luke Faulkner's 2019 NASCC: The Steel Conference session "The AISC Guide to BIM/Modeling," available at aisc.org/2019nascconline. You can also find out more about the guide in "Writing the Book on BIM" on page 52.)
- 4** While 3D modeling and BIM capabilities have revolutionized the way structures are designed and erected, direct communication between all involved parties is still essential to prevent instability during installation. What is one way the structural engineer can ensure that the nature of the design concept is accurately conveyed so as to prevent construction mishaps? (Hint: See David Ruby's "But It Worked in the Model!" series, available in the Archives section at www.modernsteel.com. The last installment ran in September 2018, and previous installments are referenced in that article. Specifically, you might want to take a look at the October 2017 installment.)
- 5** What are some benefits of incorporating steelXML schema for ordering and purchasing steel?
- 6** At what level of development (LOD) can designers incorporate steel reinforcement such as web stiffeners, sleeve penetrations, etc.? (Hint: See the BIMForum Level of Development (LOD) *Specification*, available at aisc.org/bim.)
 - a. LOD 100
 - b. LOD 300
 - c. LOD 400
 - d. LOD 200
 - e. LOD 350

TURN TO PAGE 14 FOR THE ANSWERS

Innovation Highlights

- No Beam or Column Damage Under Severe Earthquake Loading
- Faster Repair Following a Severe Earthquake
- Less Steel + Less Fabrication Labor = Up Front Cost Savings
- No Field Welding + No Field Weld Inspection = Fast Erection

Easy to Design

- Stiffness Checks Performed in RAM or ETABS
- Complimentary Design Assistance
- Connection Design, Detail Sheets, and Connection Schedules Provided

DURA FUSE

FRAMES

durafuseframes.com
contact@durafuseframes.com
801.727.4060

Resiliency

The bottom fuse plate in DuraFuse Frames protects the beams and columns and is the only part to be replaced after a severe earthquake.





SUCCESS STORY: Mike's Metal Works

Meets Challenging Deadline with PythonX STRUCTURAL

CHALLENGES

1. Missed opportunities

Because they strictly focused on miscellaneous, they were missing out on a lot of structural opportunities that their competitors were bidding on.

2. Unable to meet deadlines with outdated technology

Unable to meet a customer's deadline with their current outdated technology, they knew they had to upgrade their equipment.

SOLUTION

RESEARCH

An industry expert recommended the PythonX STRUCTURAL, and they had watched PythonX STRUCTURAL videos online and were amazed at the speed that the PythonX STRUCTURAL processed structural steel. So they decided to take a closer look at FABTECH and bought it on the spot. The primary reason they chose PythonX STRUCTURAL is that Lincoln Electric makes it, and they were impressed with the quality, workmanship, and support that are superior to competitive systems.

THE PRODUCT

PythonX STRUCTURAL, a versatile and complete solution that requires only 1 operator and no programming. All processing operations are automated, resulting in increased productivity, unmatched cut quality, predictable, and consistent throughput.



RESULTS

INCREASED EFFICIENCY OPENS UP NEW OPPORTUNITIES

When they implemented the PythonX into their production process, they didn't anticipate its effectiveness and the new opportunities that the PythonX STRUCTURAL would open up with other customers with their new manufacturing potential. Growth was imminent.

Since starting the business from a single person operation in the family's garage, they have expanded to a 50,000 sq. ft. facility with 37 employees based in San Diego, CA.



MIKE & JACKIE HANCOCK

President and CEO,
Mike's Metal Works



PythonX paid for itself with its first job processing 500 pieces of steel



Decrease Time
To complete infill beam production from a minimum of 90 minutes to 6-8 minutes



For more information on this revolutionary technology: Call +1 833 PYTHONX
Watch our Customer Success Videos: www.pythonx.com/customer-success



steel quiz ANSWERS

Everyone is welcome to submit questions and answers for the Steel Quiz. If you are interested in submitting one question or an entire quiz, contact AISC's Steel Solutions Center at 866.ASK.AISC or solutions@aisc.org.

- 1 True.** See Ron Ziemian's 2007 NASCC session "Basic Introduction to Nonlinear Analysis" at aisc.org/education-archives.
- 2** The general vector form of the series of equations can be written as $F = Ku$. F is the force vector, containing axial, shear, and moments. u is the displacement vector containing axial displacement, transverse displacement, and rotation. K is the global stiffness matrix, which is assembled from local member stiffnesses.
- 3 False.** *Guide to BIM & VDC* is a concise resource for the industry that is meant to be a bridging document for the AISC Code of Standard Practice for Steel Buildings and Bridges (ANSI/AISC 303, aisc.org/specifications). It includes an introduction to the concept and implementation of BIM, use cases for BIM, LODs, a BIM execution plan, a glossary of terms, discussion of compatible software platforms, and translators.
- 4** To account for the unknown, the structural engineer may consider providing a structural narrative describing the structure, its major components (structural and nonstructural steel), and their interdependence. Supplying a structural narrative with the 3D model is a means for the engineer to clearly define the nature of the design concept and to emphasize its unique features prior to the erector and construction manager developing their project plans and installation procedures during the bidding stage.
- 5** steelXML is a schema that accommodates all transactions in the structural steel procurement process and acts as a platform to develop an electronic data interchange (EDI). steelXML provides a common standard platform for the electronic exchange of inquiries, requests for quotations, purchase orders, schedules, material test reports, and customer sales order quotations. Key benefits of adopting steelXML are an increase in processing speed, data accuracy, performance visibility, and cost reduction, thus providing a competitive advantage. More information can be found at aisc.org/steelxml, and a deeper discussion can be found in the August 2015 article "Ordering up Integration" (available at www.modernsteel.com).
- 6 e.** Uniformat B1010.10.30 and B1010.10.40 show that at LOD 350, the element model should include actual elevations and location of member connections; main elements of typical connections applied to all structural steel connections; miscellaneous steel members with correct size, shape, orientation, and material; and any steel structure reinforcement such as web stiffeners, sleeve penetrations, etc.

THE SAFEST HOSPITALS USE SIDEPLATE

David Bibbs, PE, SE of CannonDesign recently wrote our new ad when he said this about Bay Health's Sussex Replacement Hospital:

"We used SidePlate moment frames to reduce labor and material costs – because healthcare resources are better spent on patients, not steel."



WHEN ARE YOU GOING SIDEPLATE?

MiTek
25 SIDEPLATE®
[1995-2020] 25 Years of Optimization

www.sideplate.com

A WORLD OF STEEL PROCESSING MACHINERY...

The Solution That Best Fits Your Needs.



BEAM
PROCESSING



EXCALIBUR - VICTORY
Mono spindle CNC
Horizontal Drilling Systems



ORIENT range
Mono spindle CNC
Profile Processing Center



VANGUARD range
Three spindle CNC Profile
Processing Lines



LIBERTY range
Three spindle CNC
Profile Processing Lines



ENDEAVOUR - VALIANT range
Three spindle CNC Profile
Processing Lines



ENTERPRISE range
CNC Gantry Drilling Lines



RAZ - FLEX range
CNC Coping Robot and Systems



KATANA range
Band Sawing Systems



PLATE
PROCESSING



P range
CNC Punching, Drilling
and Marking Systems



TIPO D range
CNC Punching, Drilling
and Cutting Lines



KRONOS range
CNC High definition Plasma
and Oxy Cutting Systems



GEMINI range
CNC Drilling, Milling
and Thermal Cutting Systems



TIPO G range
CNC Drilling, Marking
and Thermal Cutting Systems



TIPO B range
CNC Punching, Marking
and Thermal Cutting Systems

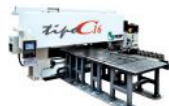

TIPO C range
CNC Punching, Drilling
and Thermal Cutting Systems



ANGLE
AND FLAT
PROCESSING



A range
CNC Punching, Drilling,
Marking and Shearing Systems



SP range
Super Performance
CNC Punching and Shearing Systems



HP range
CNC Punching, Drilling, Notching,
Marking and Shearing Systems



XP range
High performance CNC Punching
and Shearing Lines



RAPID range
CNC Drilling, Marking
and Cutting Systems



SURFACE
TREATMENT



Shot blasting System
Surface treatment systems

A drive to constantly improve, to meet increased demands for higher efficiency and throughput, has made FICEP a global leader for the past 88 years.

Don't just take our word, ask our customers...

FICEP equipment owners have seen the results, with unmatched reliability and increased productivity.

Call and let us show you solutions designed specifically for your operation.



FICEP Corporation
2301 Industry Court, Forest Hill, Maryland 21050
Phone (410) 588-5800
Fax (410) 588-5900

www.ficepcorp.com

As a fabricator, time is money, and the margin for errors is non-existent. FICEP Corp. understands and is prepared to help you achieve higher through-put with greater control and precision.

Contact us for solutions that increase your productivity, and join fabricators across the globe who trust the world's leader in steel processing equipment.

steelwise STRUCTURAL VIBRATION SERVICE- ABILITY

BY BRAD DAVIS, SE, PhD, AND
JEREMY SALMON, SE, PE



Brad Davis (bradd@davisstructures.com) is an associate professor at the University of Kentucky and the owner of Davis Structural Engineering, LLC. **Jeremy Salmon** (jeremys@sdg-structure.com) is a principal with Structural Design Group.



Exploring advanced design methods
in AISC's design guide on vibrations.

THE SECOND EDITION AISC Design Guide 11: *Vibrations of Steel-Framed Structural Systems Due to Human Activity* (DG 11) is an invaluable reference for structural engineers evaluating steel structures for vibration serviceability.

As the chapters on finite element analysis (FEA) and experimental testing require fairly specialized knowledge of vibrations (see the sidebar on the opposite page for a brief summary of these chapters) it is often advantageous for the engineer of record (EOR) to collaborate with a vibration specialist to implement these methods and solve the problem at hand. The following two case studies will help illustrate this process.

Case Study 1: Irregular Framing, Sensitive Equipment

In this example, a proposed physician's office building is planned adjacent to a new hospital. It will be 160,000 sq. ft, with five stories plus a basement. The architect has planned for two magnetic resonance imagers (MRI) on the first floor, which will be an elevated slab above the basement level. Because MRIs are very sensitive to vibration and these will be on an elevated floor, vibration due to walking is a concern.

Figure 1 shows a partial floor plan indicating the MRI rooms, control room, adjacent corridor, and structural framing. The primary load cases are very slow walking in the control room and fast walking in the corridor. The south MRI, used for illustration herein, has a tolerance limit of 0.001 m/s^2 , which is $0.0102\%g$. (This form of the response corresponds to A_{NB} in the sensitive equipment chapter in DG 11.) Lack of compliance could affect the stability and homogeneity of the magnetic field or degrade image quality. MRI suppliers typically require vibration testing prior to installation. If the floor vibrates at levels above the limit, difficult retrofit work would likely be required.

The typical floor construction will be 5¼-in.-thick lightweight structural concrete with 2-in. composite steel deck supported by beams at a maximum spacing of 10 ft. The typical column spacing will be 30 ft. The slab directly under the MRIs will be 8-in.-thick normal-weight concrete, recessed 4 in. to accommodate shielding. The framing shown in Figure 1 are significantly heavier than those expected for typical areas.

The sensitive equipment chapter in DG 11 contains the design provisions for evaluating such floors. Unfortunately, it relies on predictions of the fundamental natural frequency, effective weight, and mode shape, and it is unclear how to compute these using manual calculations for the irregular framing in this case. Thus, the floor is outside the scope of the manual methods. At this stage in the design process, the EOR decided to engage a vibration specialist for design assistance.

The vibration specialist chose to use an FEA-based method, and the SAP2000 model depicted in Figure 2 was developed using the methods described in the FEA chapter of DG 11. The model includes only the bays with the MRIs plus one surrounding bay in each direction; this limited area was chosen because a larger area would increase the likelihood of an unconservative under-prediction of the acceleration.

With the model developed, the vibration specialist chose to predict the vibration response using the modified form of the FRF method mentioned in the sidebar. With this method, the frequency response function (FRF) was computed and used to determine the natural

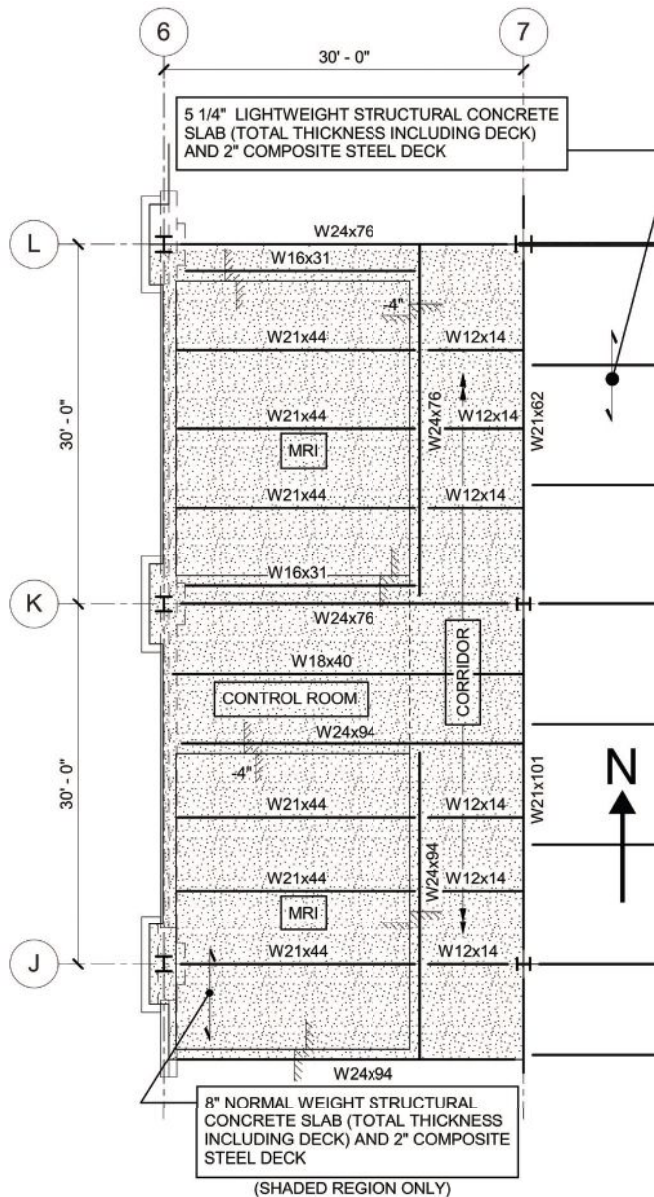

Fig. 1. Partial plan for Case Study 1, MRIs on an elevated floor.

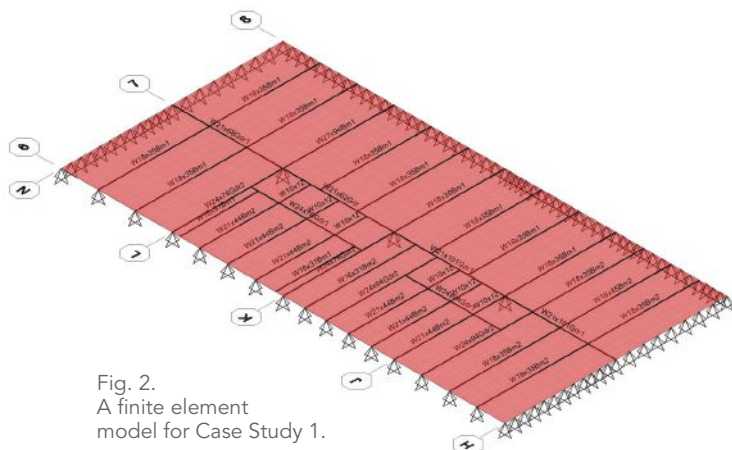

Fig. 2. A finite element model for Case Study 1.

A Quick Review of Design Guide 11

When it comes to vibration evaluation, Chapter 4, “Design for Walking Excitation,” Chapter 5, “Design for Rhythmic Excitation,” and Chapter 6, “Design for Sensitive Equipment and Sensitive Occupancies,” provide methods that are fairly simple and can be performed using manual calculations or commercial software. Most of these methods have been used for many years and have substantial experimental backing, so they should be employed whenever possible. For situations that require methods outside the scope of these chapters, Chapter 7, “Finite Element Analysis Methods,” and Chapter 8, “Evaluation of Vibration Problems and Remedial Measures,” provide guidance.

Chapter 7, covering FEA, provides guidance for predicting the dynamic properties of the structure using commercial FEA programs, and subsequently predicting the acceleration or velocity for comparison with tolerance limits. This chapter makes extensive use of frequency response functions (FRFs). An FRF is a plot of vibration response due to a sinusoidal force with a unit amplitude. It indicates which frequencies would provide the highest vibration responses if excited by a dynamic load, thus allowing the engineer to focus on the most relevant modes and proceed with the analysis. The process of using the FRF to predict the vibration response is called the FRF method. It is advantageous over other methods in that it facilitates the use of engineering judgment, plenty of which is needed to use FEA for vibration analysis. This method is described in detail in the FEA chapter for floors subject to walking and running, and monumental stairs. For sensitive equipment, a revised version of the FRF method has been developed since the second edition of DG 11 was published. This method is illustrated in Case Study 1 and is explained in more detail in the 2019 NASCC: The Steel Conference presentation “Structural Vibration Serviceability: FAQs and More,” available at aisc.org/2019nascconline.

When problematic vibrations occur, a vibration reduction retrofit is usually needed. To design such a retrofit solution, the current level of vibration and dynamic properties must be known. Because computed predictions can only be considered moderately accurate and reliable, experimental measurements are greatly preferred. With accurate measured values available, the subsequent design of the retrofit solution is much more reliable. DG 11 Chapter 8 describes recommended experimental testing procedures for such situations. The methods require a moderate level of specialization in vibrations, but they are nondestructive and only require a short and non-intrusive visit to the site. The only equipment required is a seismic accelerometer and a spectrum analyzer, both of which can be easily transported to the site and cause no consternation on the part of the owners. Experimental methods from Chapter 8, along with the FRF method for stairs, are illustrated in Case Study 2.

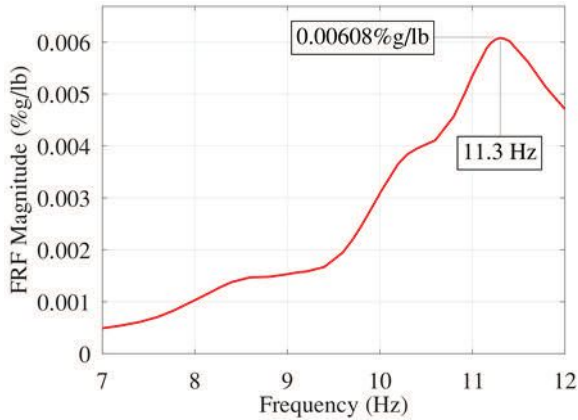

Fig. 3. Predicted FRF for Case Study 1.

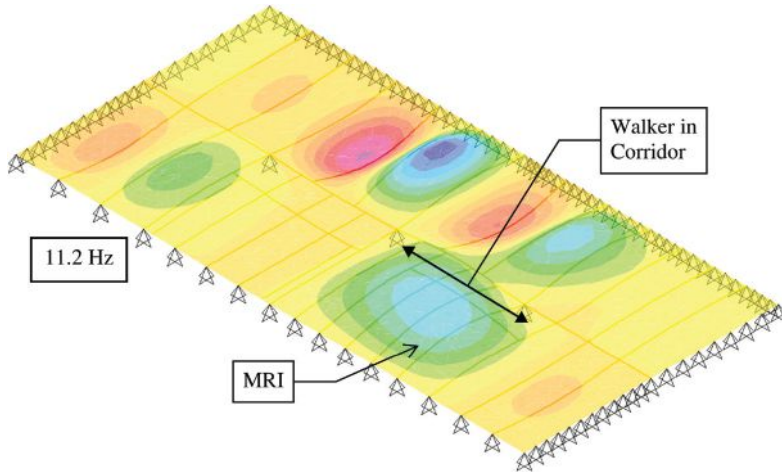

Fig. 4. Predicted natural mode for Case Study 1.

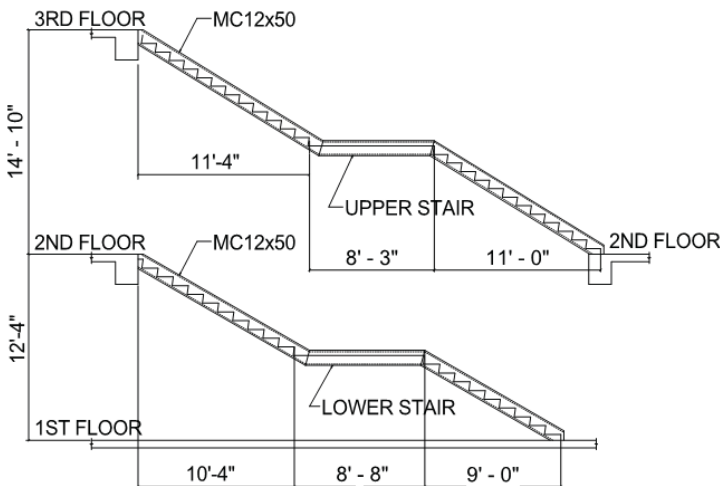

Fig. 5. Stair elevations for Case Study 2.

frequency, f_n , and effective weight, W , for use in DG 11 Chapter 6 equations. (This process is explained in further detail in the NASCC presentation mentioned in the sidebar.)

The FRFs were computed for response at the center of each MRI magnet due to walking in the control room area and in the corridor. Thus, the locations of the affected equipment and walkers were taken into account. A viscous damping ratio of 0.05 was used due to the presence of significant full-height partitions on the slab and ceiling and mechanical ductwork below. The evaluation for the south MRI and walking in the corridor is used for illustration here; the process is similar for the north MRI and for walking in the control room. The FRF for acceleration at the south MRI due to walking in the corridor is shown in Figure 3. This FRF indicated a lively mode of vibration at approximately 11.3 Hz. (The FRF peak is sometimes at a frequency that is slightly lower or higher than the nearest natural frequency.) The natural frequency, f_n , and effective weight, W , corresponding to this FRF peak are 11.3 Hz and 329 kips.

The mode nearest 11.3 Hz is shown in Figure 4. This is the eleventh mode, so as usual, numerous modes were predicted and the FRF magnitude was instrumental in identifying the controlling frequency.

With the natural frequencies and effective weights defined, the acceleration was predicted for each FRF peak using DG 11 Equation 6-7. The spectral acceleration at the MRI due to very slow walking in the control room was far below the limit. The spectral acceleration due to fast walking in the corridor was below the limit by a very small margin. Thus, the calculations predicted that the floor will be adequate to support this MRI.

Case Study 2: Monumental Stair, Problematic Vibrations

The second case study involves a pair of linear monumental stairs (in the configuration shown in Figure 5) that were installed as a prominent architectural feature in a new building. The lower stair spans 28 ft and the upper stair spans just under 31 ft, and each is supported by two MC12x50 stringers at a horizontal clear spacing of 8 ft, 8 in. At the bottom the stringers bear on the concrete slab, and at the top the stairs have welded connections to embedded plates in concrete beams. The stair has typical bent plate treads and risers, with a 2-in.-thick normal-weight concrete walking surface. The intermediate landings consist of 3 in. of normal-weight concrete supported by channel beams. The stairs have a typical guardrail system consisting of stainless steel pipes and glass panels and are designed to be elegant and aesthetically pleasing.

During construction, project team members noticed perceptible vibrations that warranted investigation, so an experimental measurement program was initiated. The first purpose was to determine the accelerations due to stair descents for comparison with tolerance limits. The second purpose was to provide accurate natural frequencies and damping ratios to facilitate the design of a vibration-reduction retrofit.

Natural frequencies were determined using heel-drop tests as described in the experimental testing chapter. During these tests, a measurement team member rose onto the balls of his feet and dropped forcefully on the landing. The resulting acceleration waveform was measured at the landing and transformed to an acceleration spectrum. Peaks in the spectrum indicate natural frequencies. Figure 6 shows the results for the lower stair. The spectrum indicates a natural frequency of 5.88 Hz. The waveform and spectrum for the upper stair are similar except that the natural frequency is 5.12 Hz. The upper stair is slightly longer, which explains its lower frequency. These frequencies exceed the recommended lower limit, 5 Hz, from DG 11. The waveforms were very simple, so decay curve-fitting was used to determine the damping ratios, which were approximately 0.026. Without the measurements, the retrofit design would proceed with DG 11's recommended damping ratio of 0.01 for a stair without a soffit or other likely sources of damping, resulting in an overly conservative design.

Accelerations due to regular-speed descents and rapid descents were also measured. Regular descents occur at step frequencies below about 2.5 Hz and rapid descents occur between 2.5 Hz and 4.0 Hz. During these tests, one team member descended the stair while listening to a metronome set at an integer division of the natural frequency so that a force harmonic caused resonance. For example, at the lower stair, for regular descents, the step frequency was $5.88 \text{ Hz} / 3 = 1.96 \text{ Hz}$, resulting in the third harmonic causing resonance. Three walkers participated in these tests. During most tests, a team member stood on the landing and offered his or her subjective evaluation of the vibration level. The measured accelerations were recorded and processed to determine the equivalent sinusoidal peak acceleration (ESPA) that is directly comparable to the DG 11 tolerance limits. The recommended limit for regular descents is 1.7%g. For rapid descents, it is 3.0%g because occupants typically tolerate higher accelerations due to other occupants running down the stair.

The average ESPAs at the lower stair were 3.1%g for regular descents and 4.4%g for rapid descents, which exceed the recommended tolerance limits of 1.7% and 3.0%, respectively. The subjective evaluators described the vibrations as “very noticeable.” An example waveform for a lower stair test with one of the highest ESPAs is depicted in Figure 7. During this test, the walker descended at a regular speed. The waveform indicates a resonant build-up as the walker descended the top flight, then a decrease as he crossed the intermediate landing, and then a short build-up followed by decay as he descended the bottom flight. The maximum value of the red line is the ESPA for the test.

At the upper stair, the average ESPAs for regular and rapid descents, respectively, were 1.9%g and 3.2%g, which are slightly above the limits. During several tests, the subjective evaluators described the vibration of the upper stair as “noticeable” and “might be acceptable.” While not conclusive, the subjective evaluations in this study confirm the recommended tolerance limits in DG 11, and the team considered the measured vibration levels to be high enough to warrant developing a vibration reduction strategy.

The design of the retrofit was accomplished as follows:

1. A finite element model was developed in SAP2000
2. The model was tuned so that its natural frequency predictions for the as-built stairs matched the measurements as closely as possible
3. The acceleration prediction method was tuned so that the predictions matched the average ESPA
4. The tuned model and acceleration prediction method were used to predict the effectiveness of retrofit options.

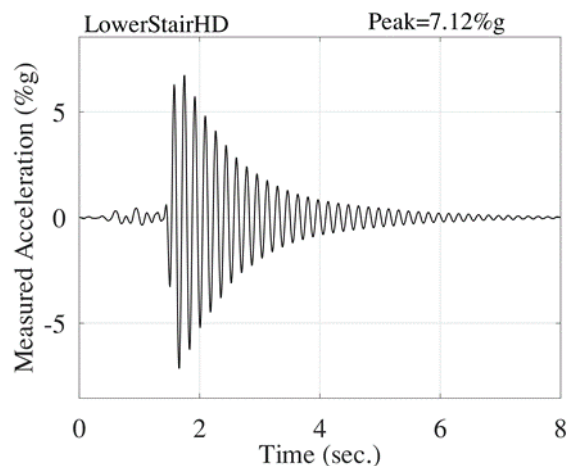

(a) Waveform

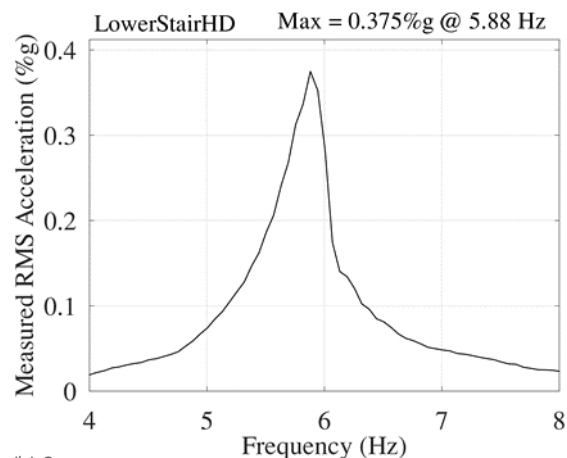

(b) Spectrum

Fig. 6. Heel-drop test results for the lower stair in Case Study 2.

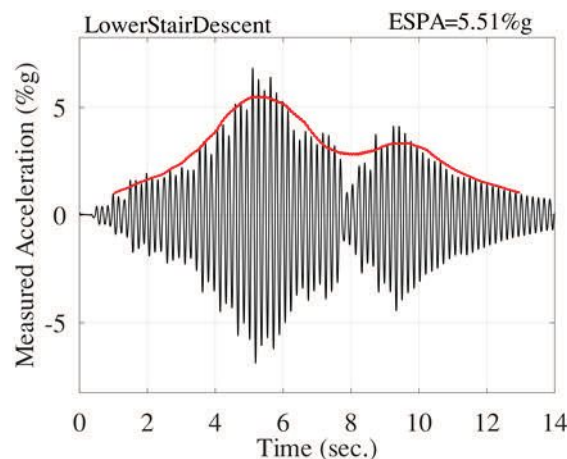

Fig. 7: Example stair descent test result for the lower stair in Case Study 2.

The finite element model of the as-built stairs is shown in Figure 8. The major unknown for these stairs was the degree of rotational restraint at the stringer top connections. This connection is somewhere between a pin and a fixed support. Thus, linear rotational springs were added at the top supports in the model. The stiffnesses of these springs were such that the measured and predicted natural frequencies were approximately equal. Inclusion of these springs, along with the use of the measured damping ratio, resulted in a tuned model.

The accelerations due to stair descents were predicted using the FRF method. At the lower stair, the predicted accelerations were 27% higher than the average measured value (adjusted for a 168-lb walker to be comparable to the prediction equation) and on the upper stair, they were 35% lower than measured. Predictions of vibration due to walking inevitably include a great deal of uncertainty, and discrepancies of the magnitudes reported here are not unusual. The acceleration prediction method was tuned so that the predicted accelerations were approximately equal to the average measured accelerations.

The tuned model and acceleration prediction method, which should be much more accurate and reliable than predictions based on design assumptions only, were used to evaluate the following options:

1. Stiffen each stringer by welding an angle to the bottom and plate to the side, resulting in the 16-in.-deep built-up tube in Figure 9. The purpose is to increase the natural frequencies, resulting in lower accelerations due to stair descents. This option has the advantage of causing minimal aesthetic impact. It has the disadvantage of being expensive and time consuming. The controlling

predicted acceleration is approximately 20% below the tolerance limit.

2. Connect the intermediate landings with four HSS2.375×0.125 near the corners of the landings. These HSS members might be subject to compressive loads, so they were selected such that the KL/r ratio does not exceed 200 by a wide margin. The purpose of this option is to force the two stairs to vibrate in unison during stair descents. With the vibrating mass approximately doubled, the predicted acceleration would be cut in half. This option has a minor aesthetic impact and has the advantage of being inexpensive and rapid to deploy. The controlling predicted acceleration is approximately 20% below the tolerance limit.
3. Connect the intermediate landing with HSS2.375×0.125 that also connect to the slab-on-grade below. The primary purpose of this option is to cause a very large increase in the natural frequency. This option would have a significant aesthetic impact and would require a thickened slab or new footings—both major disadvantages. The predicted accelerations are far below the tolerance limits.
4. Connect the intermediate landings with HSS2.375×0.125 and add a column below the bottom landing. This option has the major disadvantage of requiring a new footing. It also has an even more severe impact on the aesthetics than does Option 3. The predicted accelerations are far below the tolerance limits.

The team preferred Option 2. An advantage of this choice is that, if the vibration level is not sufficiently reduced, then Option 3 or 4 could be implemented to ensure that the vibration levels are far below the tolerance limits.

Visit aisc.org/dg to access Design Guide 11 and all of AISC's design guides.

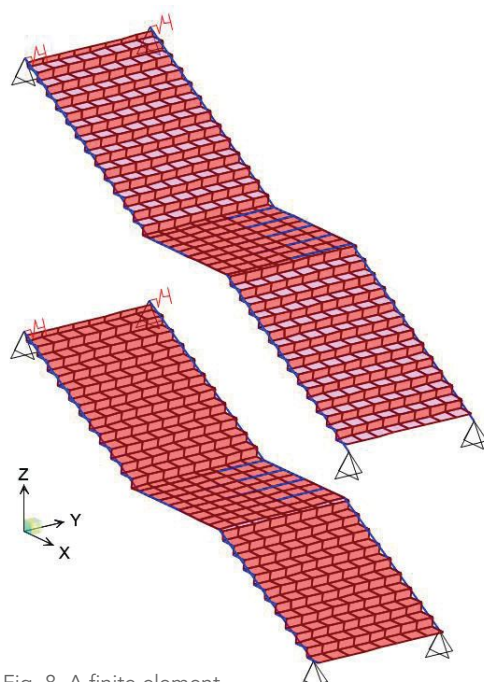
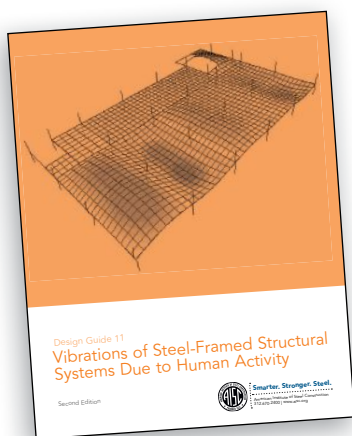

Fig. 8. A finite element model for Case Study 2.

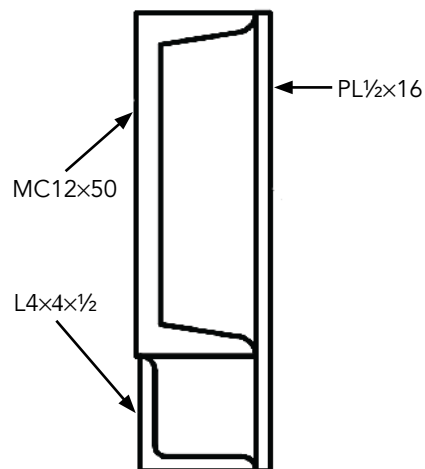

Fig. 9. A stiffened stringer for Case Study 2.

The predicted FRFs for the stair in the as-built condition and with the Option 2 retrofit are shown in Figure 10. The plots indicate that in the as-built condition, the two stairs vibrate independently at their natural frequencies—5.78 Hz for the lower stair and 5.06 Hz for the upper stair. With the HSS members added, the two stairs vibrate together at 5.41 Hz, which is approximately halfway between the two natural frequencies for the as-built condition. The predicted accelerations due to regular and rapid descents are 1.4%g and 2.0%g, respectively. These are below the tolerance limits, 1.7%g and 3.0%g, so the retrofit stair vibration evaluation is satisfactory. Thus, the team decided to use Option 2 to reduce the vibrations to tolerable levels.

As explained in the experimental testing and retrofit chapter of DG 11, for retrofits such as the ones in this case study to be effective, stress must be induced in the new steel elements to force them to be engaged. Otherwise, the stair behavior after the installation would be indistinguishable from the behavior before the installation. For Option 2 to be effective, one stair would need to be loaded and deflected during the installation of the HSS members and then released, thus subjecting the HSS members to axial loads of approximately 1 kip. The connection detail would need to be such that there is no potential for slipping or other deformation that might allow the HSS to become disengaged.

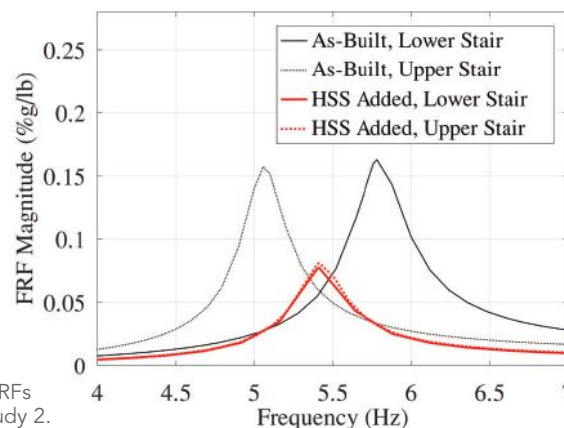

Fig. 10. Predicted FRFs for Case Study 2.

Teamwork

The DG 11 chapters on FEA methods and experimental testing and retrofit solutions offer methods for addressing vibration issues that are beyond typical design evaluations performed in practice. As both case studies demonstrate, structural engineers teaming up with a floor vibration specialist to address complicated vibration issues can lead to successful projects that satisfy occupant comfort and sensitive equipment requirements. ■

DEICON TUNED MASS DAMPERS PROTECT YOUR STRUCTURE FROM UNDESIREABLE VIBRATIONS

APPLICATIONS

- > Walking-induced vibration in floor systems, pedestrian bridges, staircases, balconies, piers
- > Exercise-induced vibration in gymnasium floors
- > Wind-induced vibration in tall buildings, control towers, observation decks
- > Machinery-induced vibration in factory floors, offshore platforms, piping systems

FEATURES

- > Application-Dependent Configuration
- > Unobtrusive & Easy-to-Install
- > Optional Self & Multi-Frequency Tuning
- > No Energy Consumption
- > Maintenance-Free



WWW.DEICON.COM
+1 (937) 885 4134
CONTACT@DEICON.COM

business issues **BRAND MAINTENANCE**

BY DAN COUGHLIN



Since 1998, **Dan Coughlin** has equipped business leaders to consistently deliver excellence in management, leadership, and teamwork. Visit his Business Performance Idea Center at www.thecoughlincompany.com.

Deliberately and carefully build, strengthen, and protect your organization's brand.

BRAND IS A MODERN, fancy word for reputation.

If you wanted to hang out with someone in high school or even college, you may have asked yourself, "What's the person's reputation?" You were attracted to some people and repelled by others based on a little bit of information. As you got to know the person a little bit more, you would either be a little bit more attracted or a little bit more repelled.

If the person made a commitment to you or told you what he or she was all about, then you had an expectation in your mind. If that expectation was met, you trusted the person a bit more. If that expectation was not met, you trusted the person a bit less. And you told other people about this person, which enhanced or hurt the person's reputation.

Reputation meant a lot.

You never own your reputation because it's what other people think of you. You don't own other people's thoughts. Those thoughts exist inside the other person. The same is true with a brand. The organization doesn't own the brand because it exists inside the minds of customers and potential customers.

A brand is the value a person thinks he or she is going to get when buying a certain product or service from a certain company. That expectation is either met, exceeded, or not met, resulting in the person's trust in that brand going either up or down. And then that person tells other people their thoughts about that brand.

This pattern is true for every single organization in the world. People either have an opinion about your products and services or they've never heard of them. Either way they have a thought about your brand, which, again, might be that they've never heard of it. If they have heard about your products and services, they have an opinion, and they might very well share that opinion with other people.

Your job is to work in a very deliberate and careful way to build, strengthen, and protect the reputation that you want your organization to be known for.

Here are six steps to build, strengthen, and protect your organization's brand:

1. Define the people whom you want to sell value.
2. Define the value you want to sell them.
3. Commit to those people that you will deliver that value.
4. Create and deliver the value you have committed to delivering.
5. Get better at creating and delivering that value.
6. Be very careful to protect your organization's reputation regarding the value you deliver.

These six steps can be applied to a one-person business or to a 100,000-person business. They can be applied to a business that has not yet begun or to a 50-year-old business.

Define the people whom you want to sell value, and define the value you want to sell them. These first two steps set the stage for intentionally building a brand. Sometimes a company creates value and then it finds a market, and other times a company identifies a market and then creates value for those people. The order doesn't matter, and both parts are equally important.

Describe the people to whom you want to sell value in as much detail as you can: geographical area, age, interests, roles, gender, industries, and/or any other factor that you think might be useful to define your desired customer group.

No, really; this is important. Don't just read that and move on. Actually write down a description of your desired customers. For me, it would be "business leaders who want to improve critically important results in a sustainable way."

Then write down the value you want to sell them. This value has to be seen as important by those people. This is where your empathy as an organization plays a tremendously important role. Only when you've really worked to understand what your desired customers are experiencing can you truly understand what they are thinking and feeling. Talk with these people, observe them, and step into their world as much as possible.

When you write down the value you want to sell, don't write down a product or service. Those are just the delivery mechanisms of the value. Please take out a blank sheet of paper. Write down six to ten words or phrases that describe the value you want to be known for delivering. I'll do this for my own business just to give you an example. *Ideas: practical, understandable, relevant for achieving better results, collaborative, solution-oriented, personalized and customized to their situations, and applicable for people in any size organization anywhere in the world.*

Before you move on, jot down six to ten words or phrases that describe the value you want to sell to your desired customers.

To build a strong brand, you need to occupy a space inside the

minds of your desired customers. You need your organization to be thought of by these people as the number one or number two option for the value you want to be known for delivering.

Commit to those people what value you will deliver to them.

Once you know your audience and the value you want to deliver, write down what change you are trying to make for those people. If there is no change, why would they need to work with you?

Write down what will be different for your customer as a result of working with your organization. After you've done that, communicate this commitment to your customers over and over and over. You won't ever own your brand, but you can communicate often about what customers can expect to receive from your organization. In your messaging to customers, weave in the six to ten words or phrases that describe the value you want to be known for delivering.

Create and deliver the value you have committed to delivering. When you deliver on your commitments, you begin to build a stronger brand. People trusted you enough to give you a try, and you delivered on your promises. As you do that over and over and over, your brand becomes stronger and stronger and stronger.

This is the operations segment of your business. Whenever people talk about operations in a business, what they really are talking about is whatever they do to create and deliver the value customers expect to receive.

NEW!

**ACCELERATING
YOUR
PERFORMANCE**

**ALL-IN-ONE
MACHINE
DO IT ALL IN
A SINGLE
PASS!**

IN STOCK NOW!

- ▶ FINANCING AVAILABLE
- ▶ FASTEST ROI

**NEW DESIGN;
SAME PRODUCTIVITY**

- ▶ Footprint reduced 50%
- ▶ Fully automated processing from loading to unloading
- ▶ Copers, rat holes, slots, block outs, seismic connections, layout marking and more
- ▶ Capable of plasma and oxy-fuel cutting; quickly change torch lead sets



voortman
VOORTMAN STEEL MACHINERY

**VOORTMAN
V807** ROBOTIC THERMAL
PROFILE PROCESSOR

coping

oxy-fuel
cutting

plasma
cutting

bevel
cutting

layout
marking

voortman
VOORTMAN USA

26200 S. Whiting Way +1708 885 4900
Monee, IL 60449 info@voortmancorp.com
United States of America www.voortmancorp.com







business issues

Get better at creating and delivering that value. Don't fall into the trap of going off on tangents. Stay focused on creating and delivering the value you have committed to delivering, and keep getting better at that creativity and delivery. This can mean improving or changing your products, your services, your delivery, your speed and so on. It's still under the same umbrella of the value that you promised to deliver. You're just doing it better.

Protect your organization's reputation. I'm not talking about taking legal actions against outsiders. I'm actually talking about protecting your organization's brand from yourself and the other members of your organization. Mainly, this comes down to discipline and focus.

There are two ways to hurt your organization's brand. First, the behaviors of key people in the organization can damage the brand. Brand-ruining behaviors can usually be traced to sex, drugs, alcohol, greed, anger, jealousy, and/or revenge. In other

**Stay focused on creating and delivering
the value you have committed to delivering,
and keep getting better
at that creativity and delivery.**

words, the organization itself is moving along very nicely, but key individuals inside the organization behave in a way that ruins the reputation of the organization.

The more closely the organization is identified with certain individuals, the more devastating their impact can be on the brand. It's very important to talk about values and behaviors on an ongoing basis. Make it as clear as you can as

often as you can as to what is appropriate behavior, and make sure the message is clear to people at all levels in the organization.

Step back and ask yourself if a personal decision you're making is worth damaging your organization's brand. Step back, reflect, and discern what you think you should do.

Don't rush into it.

The second way to hurt a brand is by making bad decisions about the organization. This comes from the tendency to keep developing new products and services and adding them to the mix. I encourage you to be very careful not to add products or services that will confuse people as to what the value is they will receive from your organization. If you can build extensions that make sense to customers and connect with the value you want to be known for delivering, then you can strengthen your brand. However, if you fall into the trap of trying to make an organization that is everything for everybody, you will hurt your brand.

I encourage you to put every new product and service idea through this filter: "Will this product/service strengthen our brand or weaken it?" If it doesn't help your brand, I encourage you not to do it, even if it helps your short-term revenue goals. Keep your brand pure, and it will attract more and more of the customers you want to work with.

Your organization's brand is its reputation in the minds of your customers and prospects. Your reputation will either attract people to your organization or repel them. Just as culture is critical on the inside of your organization, so is your brand on the outside of your organization. Intentionally build your organization's brand, strengthen it, and carefully protect it. ■

HEXPOR[®]T

Save valuable time and money. Never search for bolting documents ever again!

Test Reports

Invoices

Packing Lists

DOT Approvals

Order Tracking

Proof of Delivery



TEST REPORT			
Lot No: BM0551		MANUFACTURING DATE: 10/11/2017	
PRODUCTION INFORMATION			
PART NO: AAAM087250		MANUFACTURER'S HEAD MARK	
SIZE: 7/8"(9) X 2-1/2"			
DESCRIPTION: HVY HEX STRUC. BOLT - MG			
MANUFACTURING QTY: 18,615			
ASTM/ASME SPECIFICATIONS			
SPECIFICATION	AMEND	SPECIFICATION	AMEND
ASTM F3125	16e	ASTM F1470	12
ASTM A325-1	14	ASTM F606	16
	2010	ASTM F398	13
	2003 (R2008)	ASTM B895	2004 (R2008)
RAW MATERIAL INFORMATION*			
SUPPLIER'S TEST REPORT ATTACHED WITH CHEMISTRY INFORMATION			
GRADE	HEAT INFO/NUMBER	ASTM SPEC	AS
F4330	42423242	A325-1	AS

Call or Go Online to find out more

St. Louis Screw & Bolt

stlouisscrewbolt.com

800-237-7059

Structural Bolting Experts



Are You Redi?

REDICOR SIMPLIFIES AND ACCELERATES THE CONSTRUCTION OF REINFORCED CONCRETE CORES.

Conventional cast-in-place, pre-cast and masonry methods of constructing reinforced concrete shear cores often require long and



Pre-engineered load-bearing structural connections enable framing to begin immediately.

expensive schedules before structural framing can begin.

Now there's a better way.

RediCor is a pre-fabricated, ready-to-set modular steel form system that simplifies and accelerates concrete core construction. Our load-bearing modules are ready to set once on-site, and structural framing can be installed simultaneously – saving time, energy and money. Are you Redi?

VISIT US AT REDICOR.COM FOR THE REDICOR STORY.

NUCOR
VULCRAFT/VERCO

Powerful Partnerships.
Powerful Results.

REDICORTM
Modular Steel Form System
BY VULCRAFT

Pivot Point

BY SUZY DeHORATIIS,
JASON MYERS, SE, PE,
AND TIMON HAZELL

A D.C. area school brings a new twist to education facility design in the form of five stacked steel-framed sections that fan around a pivot.

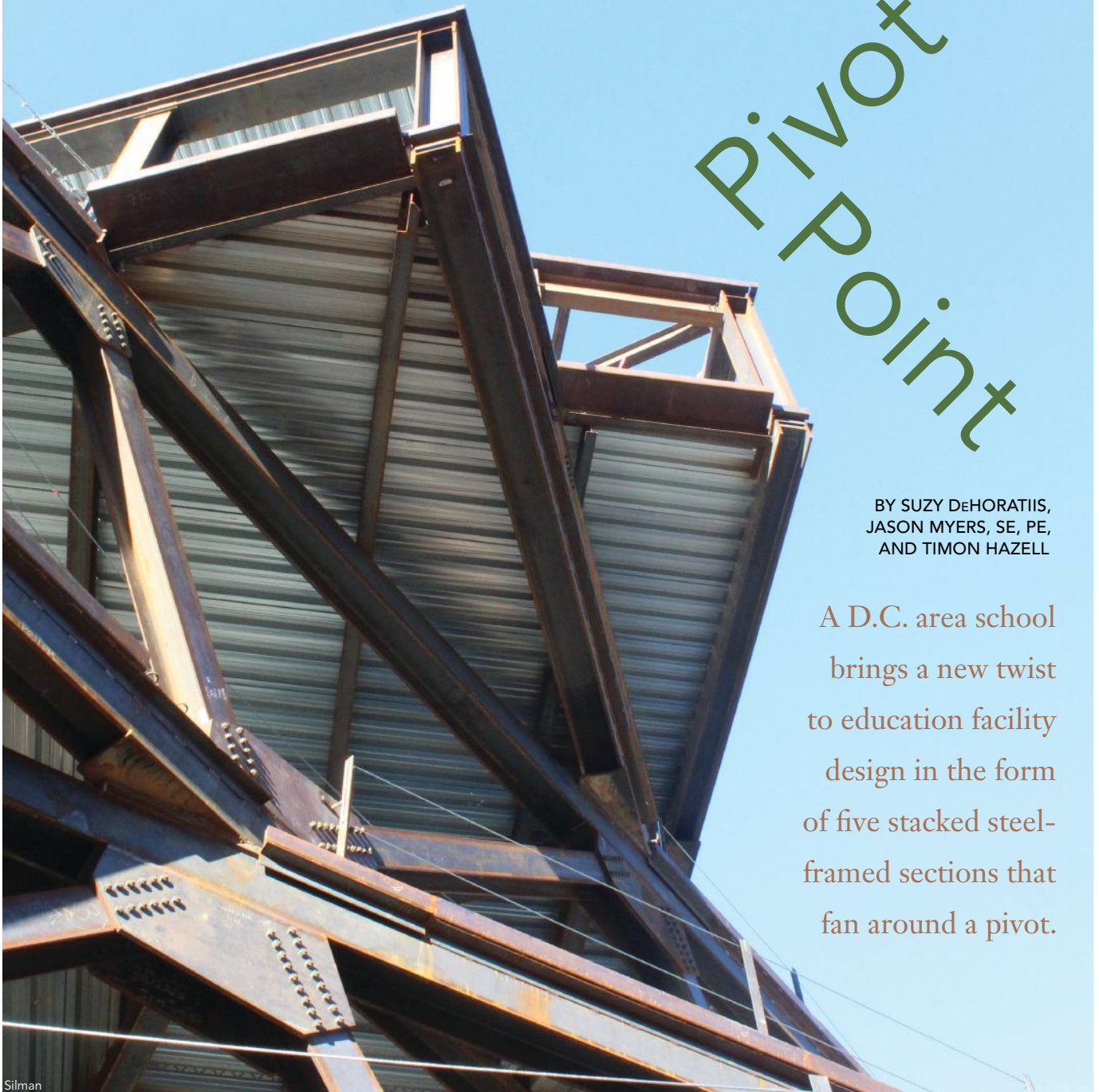

Silman

above: The truss and floating buttress system during construction.

below: An early sketch of the “pivoting bars” design concept.

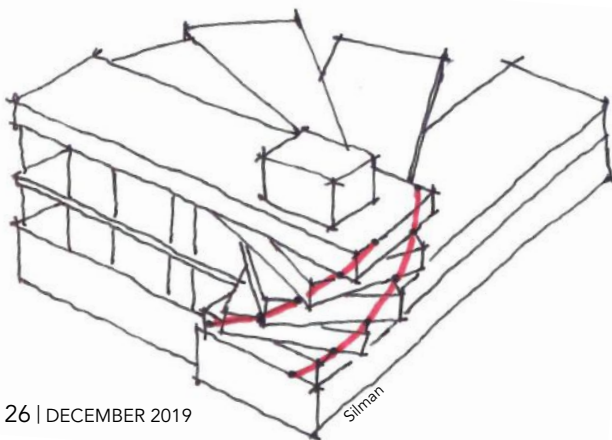

Silman

IF YOU LOOK at the new Heights school in Arlington, Va., from above, you might think you’re seeing a massive hand fan.

The new school, which opened in time for the 2019-20 academic year and enrolls 775 sixth- through twelfth-grade students, consists of five stacked steel-framed “bars” that fan around a pivot. This fanning gives the feel of a one-story school building while also creating large open volumes beneath the bars. Fanning the bars around a pivot led to the development of an innovative load-path concept using floating buttresses to support the corners of each bar. In addition, landscaped terraces live atop each bar, creating multiple outdoor learning and relaxation spaces.

The pivot was a natural location for vertical circulation and distribution of services, so a concrete core was designed to resist torsional, lateral, and gravity forces. The bars create floating corners on each



Silman

The terraced outdoor learning and relaxation spaces/green roofs connect the school with the community and provide a visually intriguing focal point from above.

side, and multiple structural concepts were evaluated to facilitate this design scheme, including cascading cantilevered beams with column transfers, cantilevered trusses parallel to each bar, and helical columns. Ultimately, the floating buttress design evolved from the helical column concept, where each column leans as the bar fans out. This created one helical load path at each corner that, while beautiful in structural elegance and simplicity, created sloped columns that occupied valuable interior space that couldn't be lost. To preserve this space, the helical columns were pushed out to the perimeter walls, forming a truss and floating buttress system framed with W12 and W14 wide-flange sections. Each truss uses standard bolted gusset connections and bearing plates, and the buttresses use welded connections. The floating buttress resulted in additional out-of-plane forces, which are resisted by horizontal diaphragm

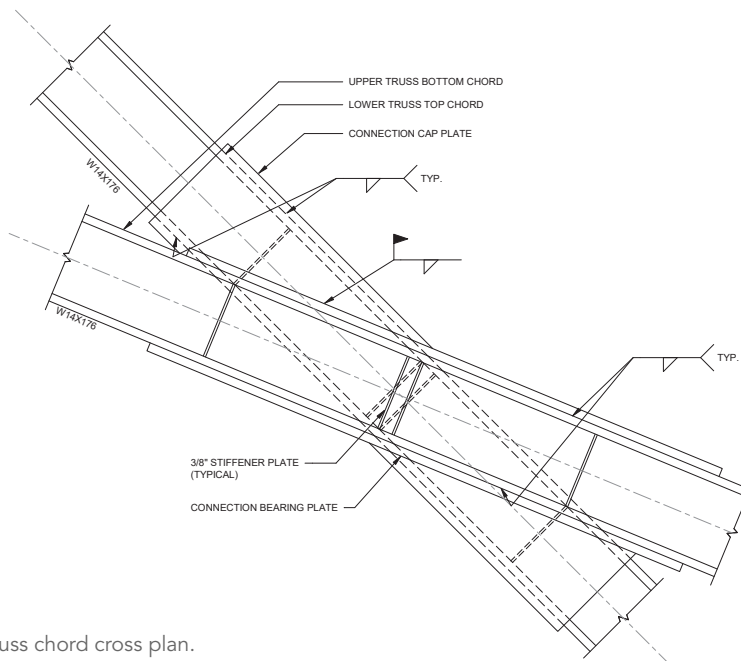

A typical truss chord cross plan.



Suzy DeHoratiis (dehoratiis@silman.com) is a project engineer, **Jason Myers** (myers@silman.com) is an associate, and **Timon Hazell** (hazell@silman.com) is a senior BIM engineer, all with Silman.



Want to experience the Heights for yourself? Point your phone's camera at this QR code to take a virtual tour of the project. (If you don't already have a QR code reader/scanner on your phone, there are plenty of free ones available for both iPhones and Android devices.) You can also access this information at silman.com/wilson.

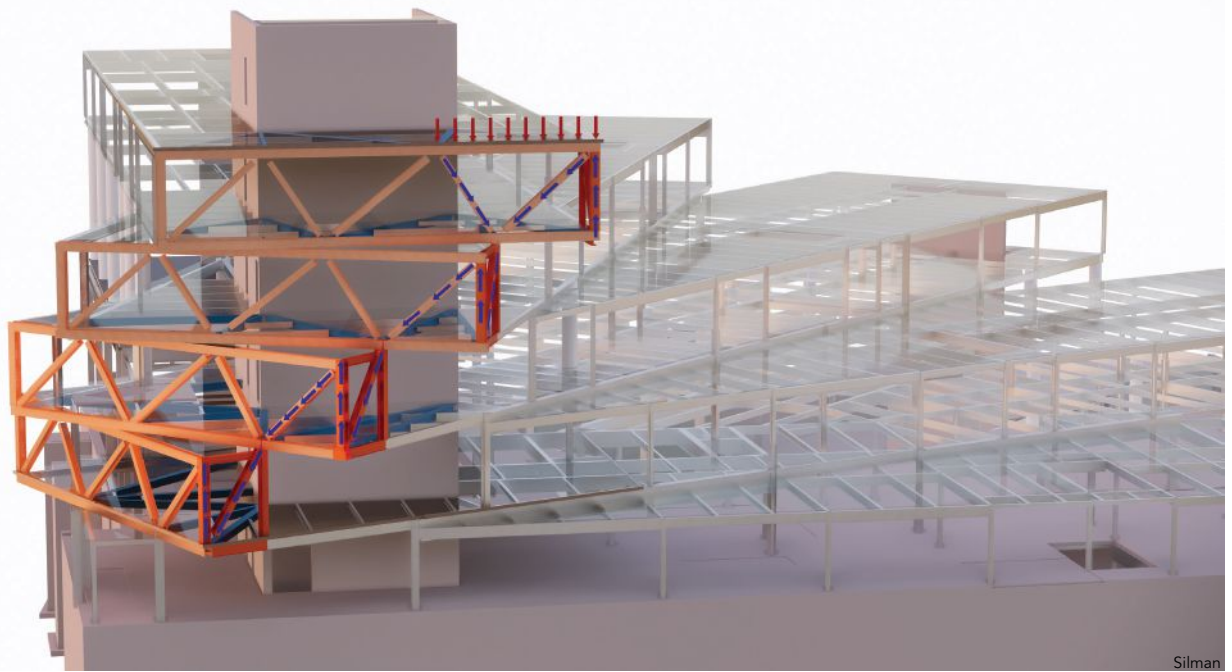

Silman

above: An illustration of the school's load-path concept using floating buttresses.

left: A BIM rendering of the truss and floating buttress system.

.....

framing that transfers diaphragm forces back to the core. To simplify erection, each truss was designed to be fully erected into place by putting an upper truss on the truss below it, using a few shoring posts for stability during erection. Where trusses intersected in plan, the chords simply passed over one another in elevation. Structural engineer Silman collaborated with steel fabricator Banker Steel to simplify load-path continuity through geometrically complex connections at critical locations. In addition, limited laydown area necessitated multiple crane lifts to get the heavy trusses and girders into place.

As is typical in school design, the classroom modules for the Heights are standardized for uniformity of program. Each bar includes classrooms on either side of a central corridor. Early studies were conducted to economize steel tonnage, considering two primary options: a double line of columns down the corridor and a single line down one side of the corridor. A double line of 8-in. to 14-in. wide-flange columns was selected, as this scheme required fewer materials and facilitated shallow corridor framing (the standard floor-to-floor height is 14 ft, 6 in.) in order to accommodate MEP routing. Continuing with this interdisciplinary collaboration between engineer and fabricator, framing was kept shallow at the exterior to allow greater

.....

The building's five bars spread around a pivot, which serves as a natural location for vertical circulation and distribution of services.



Silman

Silman



light ingress as well as linear HVAC diffusers. Silman paid specific attention to a condition where one bar fanned out over another, with the two modules intersecting. To avoid multiple column transfers, the repetitive framing on the upper level was transferred out at the level below.

The landscaped terraces were designed to support a variety of intensive plants, trees, and landscaping features. To maintain economy, repetitive framing was maintained, with varying beam sizes and deck profiles being employed depending on loading requirements. The slabs were stepped down 19½ in. between classrooms and terraces, which created an opportunity to accommodate the approximately 70-ft-long transfer girders where the bars intersected. A two-level steel and precast concrete stair cascades down radially to connect the terraces and classrooms and create a sense of community while aligning orthogonally with the bar framing.

Spreading out the five bars created large volumes below that were particularly favorable for active school functions. The gym, assembly atrium, and theater were inserted in these volumes, and a library and music



An intersection of the steel framing for multiple bars.

Torque Control



Your Bolts Tight?

Tension Control

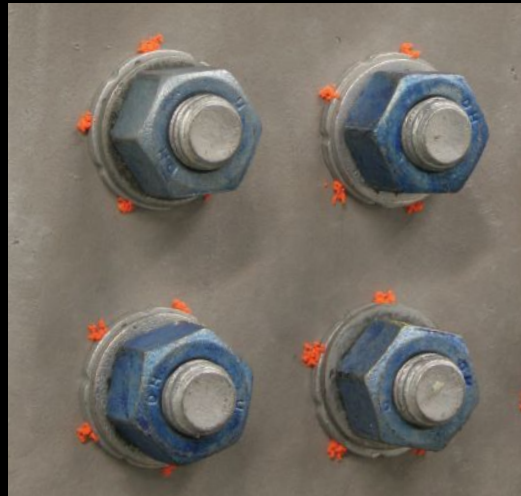

Know They're Tight!

DuraSquirt® DTIs



applied
bolting
TECHNOLOGY

the best way to bolt!

800 552 1999

802 460 3100

appliedbolting.com

info@appliedbolting.com



Above the theater, trusses were the optimal solution to meet the needs of future expansion, MEP routing, and allowable floor depths.

room were included between classrooms and the gym and theater. These spaces required clear spans from side to side of their respective bars, and steel framing depths were restricted for overall building height limitations.

The framing above the gym, library, and atrium are all standard or built-up sections, and the framing over the theater uses shallow trusses. Trusses were not feasible for the available space above the gym, so plate girders and heavy W36 sections were used to transfer the columns from above, supporting bar floor and terrace framing, and double-W24 sections ended up being the most economical solution over the atrium. A dramatic cantilever over the atrium reaches toward Wilson Boulevard to the south. To achieve the shallow floor depth, as well as the aesthetic desires of the project's architects, Leo A Daly and Bjarke Ingels Group, a dapped-end 24-in.-deep built-up double-web plate girder was used for the soffit. Due to the large terrace load from above and the short back span of this cantilever, the plate girder was anchored with a tension column in bar five. Above the theater, trusses were the optimal solution to meet the needs of potential future expansion, MEP routing, column transfers for the crossing bar above, and allowable floor depths.

The egress requirements for this unique building layout led to stairs being placed at the opposite ends of bars one, three, and five. Silman took advantage of these stairs and implemented shear walls at each stair shaft, which created a tangential force-

resisting path that coupled with the core to provide lateral force resistance. Diaphragms in bars two and four were tied with collectors to the shear walls in bars one, three, and five to provide a continual load path radially around the building bar ends. Another unique challenge resulting from the truss configuration at the pivot was the global diaphragm forces that were developed from gravity and lateral forces on the building. As the trusses fan out around the pivot, a global lean and twist was created and was resolved with steel struts and unique chord arrangements at and below-grade levels.

Silman carefully collaborated with the design and construction team during the early project phases to develop and track costs associated with critical and typical structural steel features, integrating analysis and 3D models throughout the process to track tonnage and costs associated with all structural elements. Throughout the design process and especially early on, meetings with Banker Steel and general contractor Gilbane were essential to ensuring economical solutions and constructability throughout design, as well as coordinating steel availability with the construction schedule, erection methods, preferred connection types, and site logistics. Some standard sections were changed to plate girders through this collaboration, while others remained heavy W36 beams spliced together in the field. Minor revisions were made to transfer girder connections, truss node stiffener configurations, and column splice locations.



Bjarke Ingels Group

above: An early 3D architectural model of the building. The visual effect from above is that of a fan.

right: The new school provides education for nearly 800 sixth- through twelfth-graders with special needs in Arlington's H-B Woodlawn and Stratford Programs. Formerly separated, the two programs now share space in the new \$100 million building.

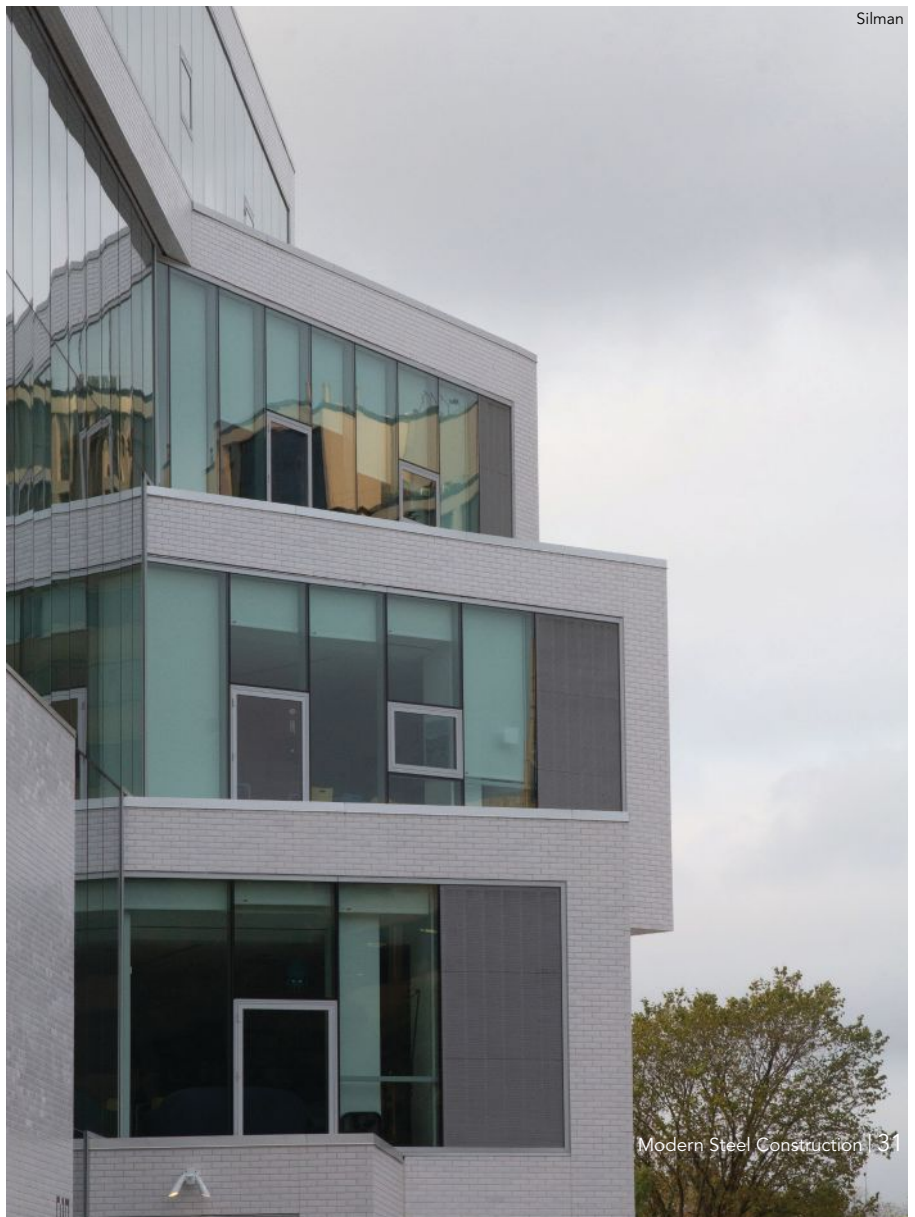

Silman

The Heights is a testament to excellence through true collaboration of structural design, architecture, steel fabrication, and construction. At every twist, innovative approaches were developed to achieve a monumental vision and a demanding school program, leading to a true architectural jewel to serve the students of Arlington. ■

Owner

Arlington Public Schools, Arlington, Va.

Construction Manager

Gilbane

Architects

Bjarke Ingels Group (BIG), New York
Leo A Daly, Washington, D.C.

Structural Engineer

Silman, Washington, D.C.

Steel Team

Fabricator

Banker Steel, Lynchburg, Va. 

Erector

Memco, LLC, Culpeper, Va. 

Detailer

Sanria Engineering, San Jose, Calif. 

Wide Load

Steel facilitates the massive spans required for the world's largest dual-access aircraft hangar.

BY THOMAS POULOS, SE, PE, ROBERT STADLER, SE, PE, AND PETER KONOPKA, SE, PE



R.M. Chin

CHICAGO O'HARE INTERNATIONAL AIRPORT has long been one of the country's and the world's busiest airports.

And thanks to an extensive ongoing modernization program to bring it firmly into the 21st century, the airport now has another feather in its cap, a new state-of-the-art hangar unlike any other: American Airlines Hangar II. The facility, which opened in January, is the largest dual-access hangar (with doors large enough for two wide-body planes side-by-side) in the world, consisting of 194,000 sq. ft of maintenance space for the largest aircraft in American's

fleet, including the Boeing 777 and 787 wide-body aircraft. A total of almost 7,000 tons of structural steel was used to bring the massive hangar to life.

The O'Hare Modernization Program's runway 9C/27C, to be located through current airline maintenance and hangar facilities, prompted American to construct the new facility, which is the first hangar to be built at the airport in 30 years. The logistics of American's operations mandated a hangar that is accessible from multiple areas; therefore, this unique structure was designed to accommo-



Ghafari Associates

above: The south elevation of the hangar.

opposite page: The hangar filled to capacity with several narrow-body aircraft and one wide-body aircraft.

date hangar doors on both sides of the building. It also accommodates bridge cranes that hang from the underside of the roof trusses to facilitate maintenance procedures.

The building was designed to meet *Chicago Building Code* requirements. However, due to the array of possible wind cases from hangar door operations, *ASCE/SEI 7-10: Minimum Design Loads for Buildings and other Structures* was referenced as well. The operable hangar doors on the north and south ends of the building create an enclosed, partially enclosed, or open classification for wind. Consequently, the cladding and associated attachments were designed for higher wind pressures, which occur while the windward hangar door is open.

The entirety of the roof is supported by 45-ft-tall box trusses over each hangar door, and the clear span is 528 ft. These box trusses are composed of two trusses linked together at the top and bottom and across web members. The box configuration was designed to provide vertical stiffness for the gravity system as well as torsional stiffness for supporting the eccentrically attached roof trusses. The trusses link to the towers at both ends, creating a giant portal frame that provides stability for the hangar in the east-west direction. The truss members are composed of wide-flange ASTM A992 steel. Spanning between the box trusses are 22-ft-tall, 249-ft-long gabled roof trusses, braced by three lines of sway frames, which support wide-flange purlins and the 3-in. roof deck.

Trussed towers stand at the corners of the building, each composed of six wide-flange columns, with the interior columns formed from 4-in. plate material in order to resist the high loads. One of the structural design challenges of the trussed tower was the pocket door configuration. The inside face of the trussed tower must remain clear in order to store the hangar door's leaves when the door is open, which caused a high unbraced length in half (three) of the trussed tower columns.

The building features translucent wall panels along the top, prominently displaying the box trusses as the high-bay lights glow in the night. When it came to optimizing the truss and tower foundation design, the design team explored several truss configurations and the phasing of the installation. One configuration included an efficient arching load path, which, although extremely effective for the steel material takeoff, proved to be exceedingly high in foundation costs due to the extreme thrust forces. The final configuration fell somewhere between arching and beam action and sequenced the installation of the end kickers after dead load deflections.



Thomas Poulos (tpoulos@thorntontomasetti.com) is a senior principal and aviation leader, **Robert Stadler** (rstadler@thorntontomasetti.com) is an associate principal, and **Peter Konopka** (pkonopka@thorntontomasetti.com) is a senior associate, all with Thornton Tomasetti.



Thornton Tomasetti

above: The hangar's framing system under construction. The green shoring towers provided support for the box trusses during erection.

below: A fully connected Tekla model was produced by Thornton Tomasetti with collaboration from steel fabricator LeJeune.

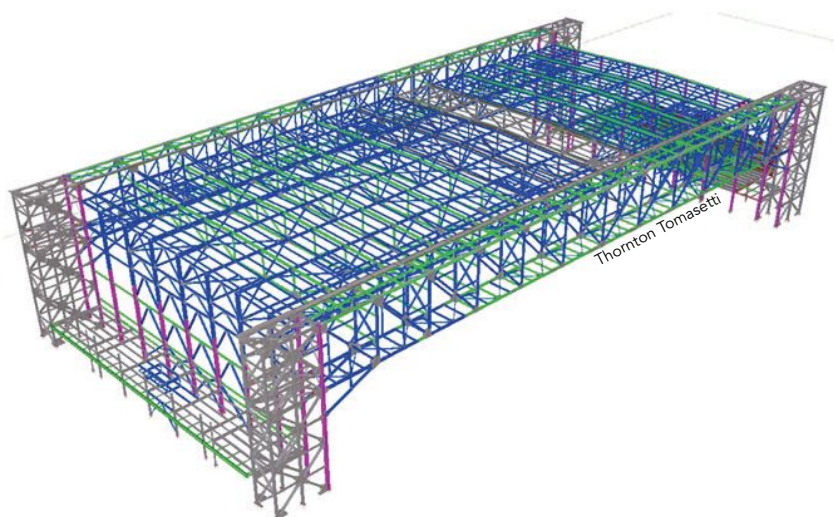

The box trusses and roof trusses were cambered for predicted deflections. The camber of the box truss was 16 in. at the center to account for full dead and snow loads, and deflections were limited to accommodate the hangar doors. Each door leaf included two vertical articulating pipes that keep the top roller head in contact with the top rail as the box truss deflects.

Lateral support is provided by concentric braced frames in the north-south direction, and portal frames created by the trussed towers and header trusses in the east-west direction. The building's diaphragm is located at the bottom chord elevation of the roof trusses. The braces within the diaphragm include round hollow structural sections (HSS), which were chosen for their compression efficiency.

Because the hangar accommodates a variety of aircraft and maintenance vehicles ranging widely in weight, the floor is 16-in.-thick concrete slab-on-grade. Various service pits dot the hangar floor, providing power, air, and data to aircraft during

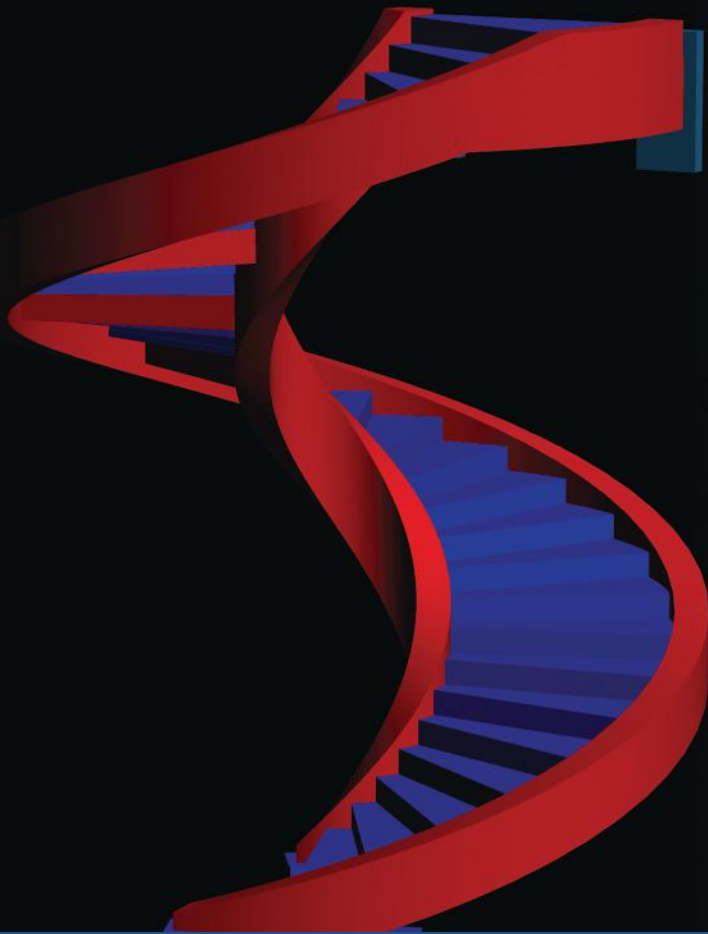

Spiral Stair Stringers

Big, True, Plumb and Fast!

Use our innovative online **Stringer Calculator** for accurate computation, improved communication and increased quality fabrication of helical stair stringers and handrails

Stringer Calculator		Print Calcs	Save to PDF	Email this PDF	Like
If you know the Tread Arcs:		Reset		Enter < or >	
Steps Total Between Landings:	<input type="text"/> Steps	If you know the Degrees per tread:		Reset	
Rise Per Tread:	<input type="text"/> Inches	Steps Total Between Landings:	<input type="text"/> Steps		
Inner Stringer Plan View Radius:	<input type="text"/> Inches	Rise Per Tread:	<input type="text"/> Inches		
Outer Stringer Plan View Radius:	<input type="text"/> Inches	Inner Stringer Plan View Radius:	<input type="text"/> Inches		
Inside Stringer Tread Arc:	<input type="text"/> Inches	Outer Stringer Plan View Radius:	<input type="text"/> Inches		
Outside Stringer Tread Arc:	<input type="text"/> Inches	Inside Stringer Tread Arc:	<input type="text"/> Degrees		
		Outer Stringer Tread Arc:	<input type="text"/> Degrees		



CHICAGO METAL
ROLLED PRODUCTS COMPANY

CHICAGO • KANSAS CITY

cmrp.com

Call us at 866-940-5739

Easy to use and powerful
cmrp.com/calculators



1 Angle Leg Out We bend ALL sizes up to:
 10" x 10" x 1" Angle

2 Angle Leg In
 10" x 10" x 1" Angle

3 Flat Bar The Hard Way
 24" x 12" Flat

4 Flat Bar The Easy Way
 36" x 12" Flat

5 Square Bar
 18" Square

6 Beam The Easy Way (Y-Y Axis)
 44" x 335#,
36" x 925#

7 Beam The Hard Way (X-X Axis)
 44" x 285#

8 Channel Flanges In
 All Sizes

9 Channel Flanges Out
 All Sizes

10 Channel The Hard Way (X-X Axis)
 All Sizes

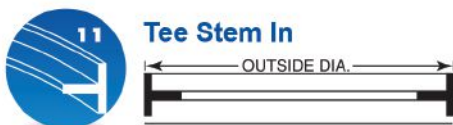
11 Tee Stem In
 22" x 142¹/₂# Tee

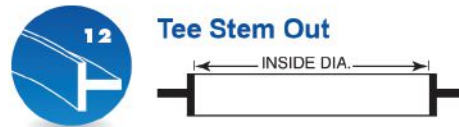
12 Tee Stem Out We bend ALL sizes up to:
 22" x 142¹/₂# Tee

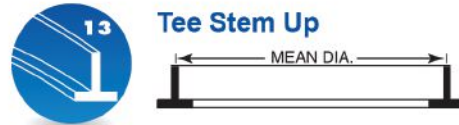
13 Tee Stem Up
 22" x 142¹/₂# Tee

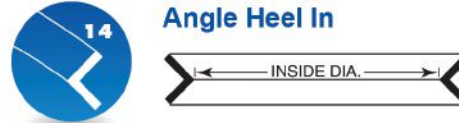
14 Angle Heel In
 8" x 8" x 1" Angle

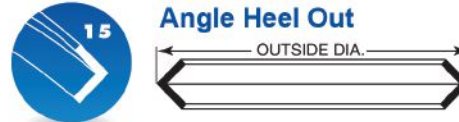
15 Angle Heel Out
 8" x 8" x 1" Angle

16 Angle Heel Up
 8" x 8"x1" Angle

17 Square Tube
 24" x 1¹/₂" Tube

18 Rectangular Tube The Easy Way (Y-Y Axis)
 20" x 12" x 5/8" Tube

19 Rectangular Tube The Hard Way (X-X Axis)
 20" x 12" x 5/8" Tube

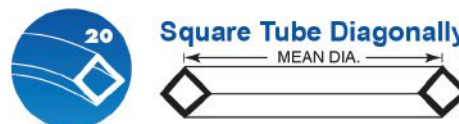
20 Square Tube Diagonally
 12" x 5/8" Square Tube

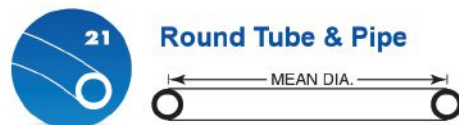
21 Round Tube & Pipe
 24" Sched. 80 Pipe

22 Round Bar
 All Mill Produced Sizes

We also roll stair stringers, helical hand rails, off-axis bends, formed shapes and extrusions.

Visit cmrp.com for more information.



CHICAGO METAL
ROLLED PRODUCTS COMPANY

CHICAGO • KANSAS CITY





Thornton Tomasetti

above: A clear view of the horizontal diaphragm at the lower truss chords.

below: Bottom chord plan contains the building diaphragm. The corner braces were API 5L pipe in order to be sourced domestically.

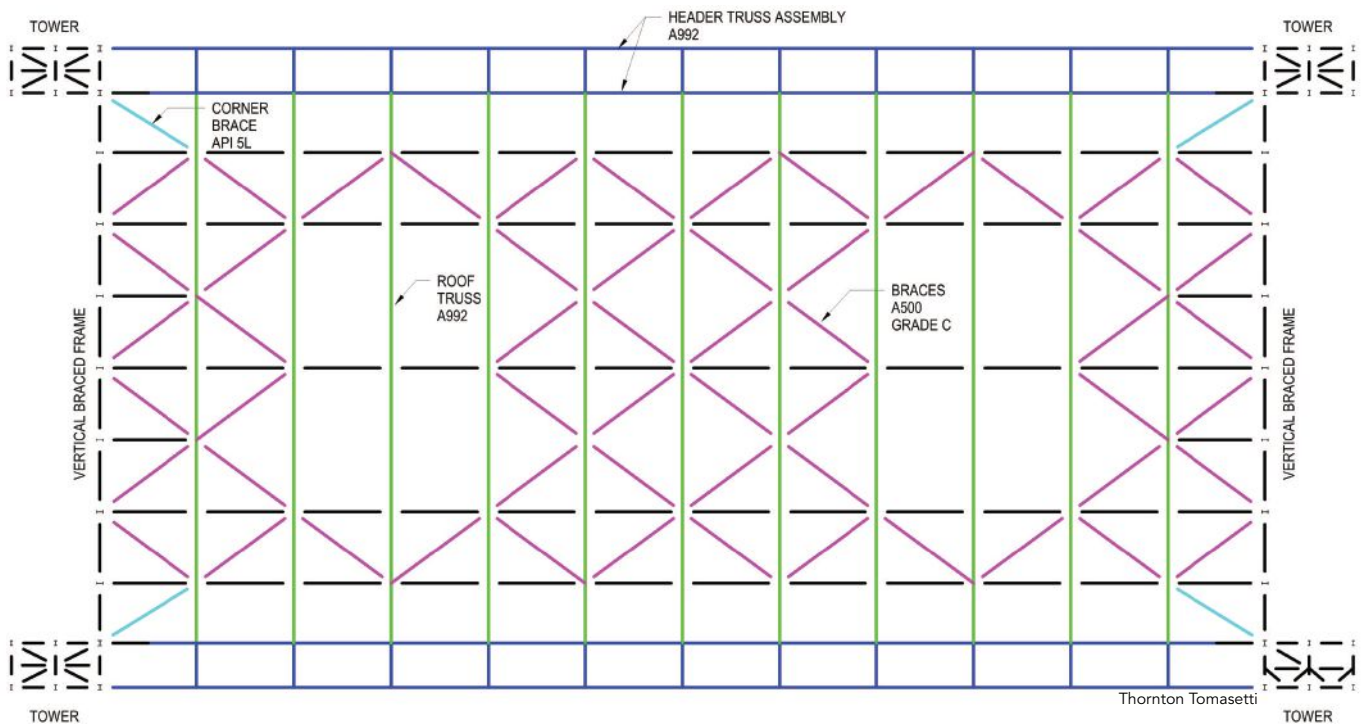

Thornton Tomasetti

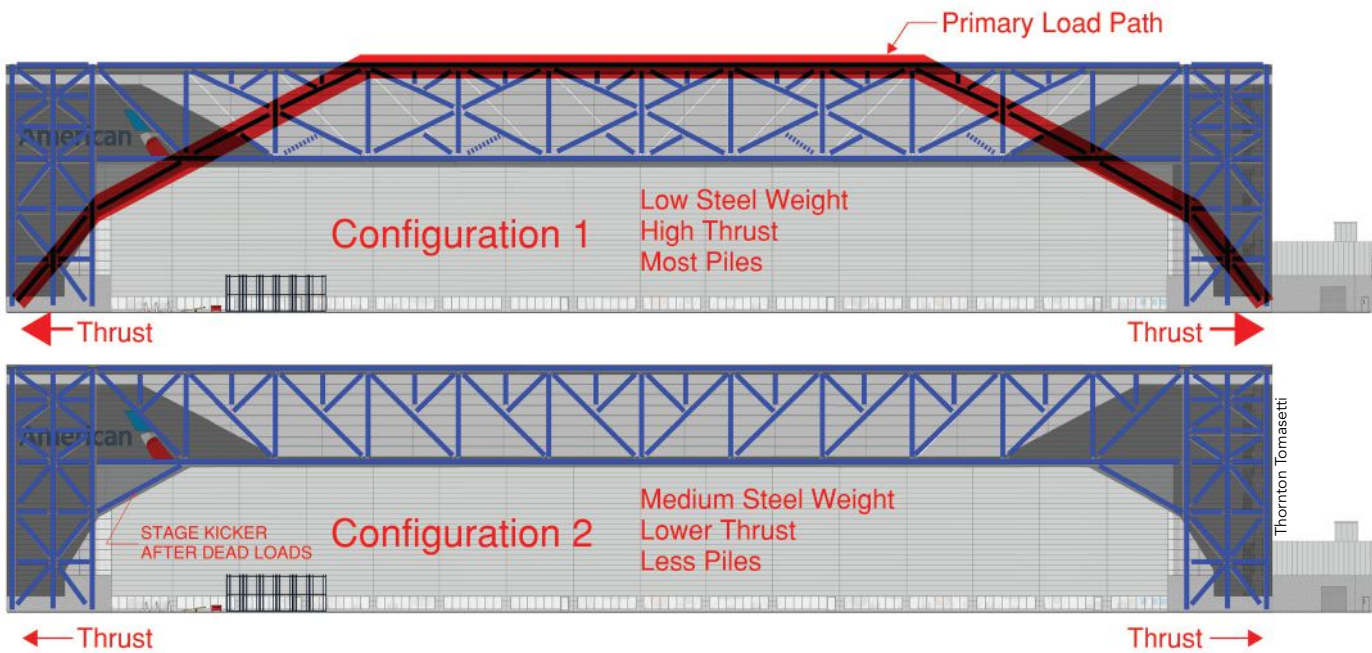

above: Two of several truss configurations that were explored. Configuration 1 had the most efficient configuration for the steel superstructure but the highest demand on the tower foundations. Configuration 2, using Pratt truss geometry and staged kickers, offered the best solution for the superstructure and foundation.

right: A view of the trussed tower connection from the fabrication model.

bottom right: The fully constructed trussed tower connection.

below: A trussed tower with six wide-flange columns laced together over a 7-ft-thick concrete mat. One side of the tower is open for the hangar doors to nest into.

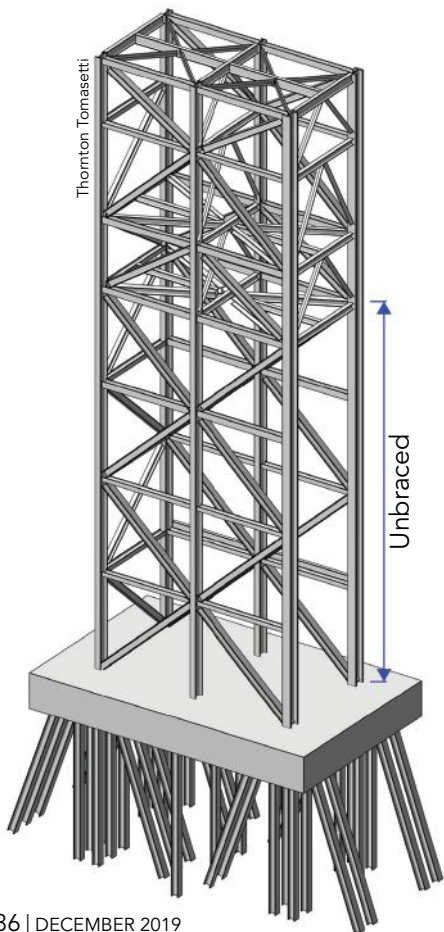
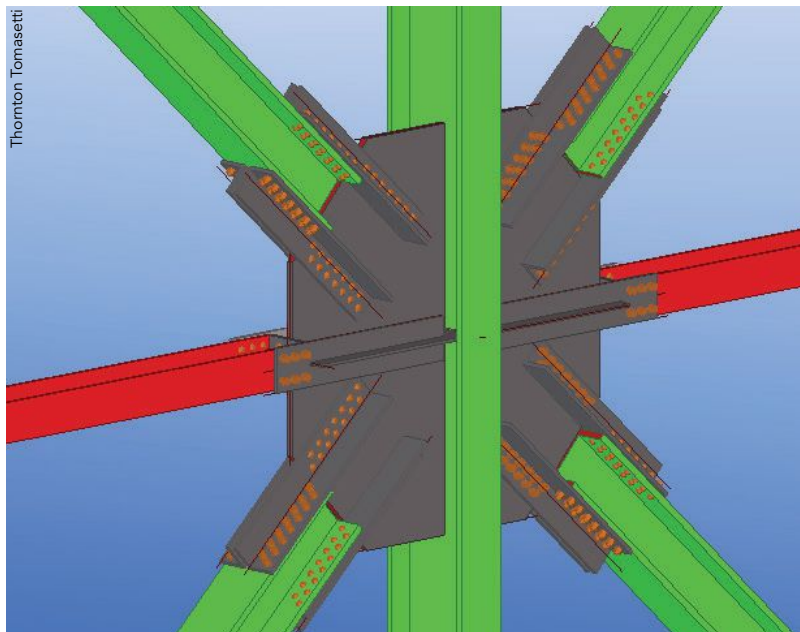

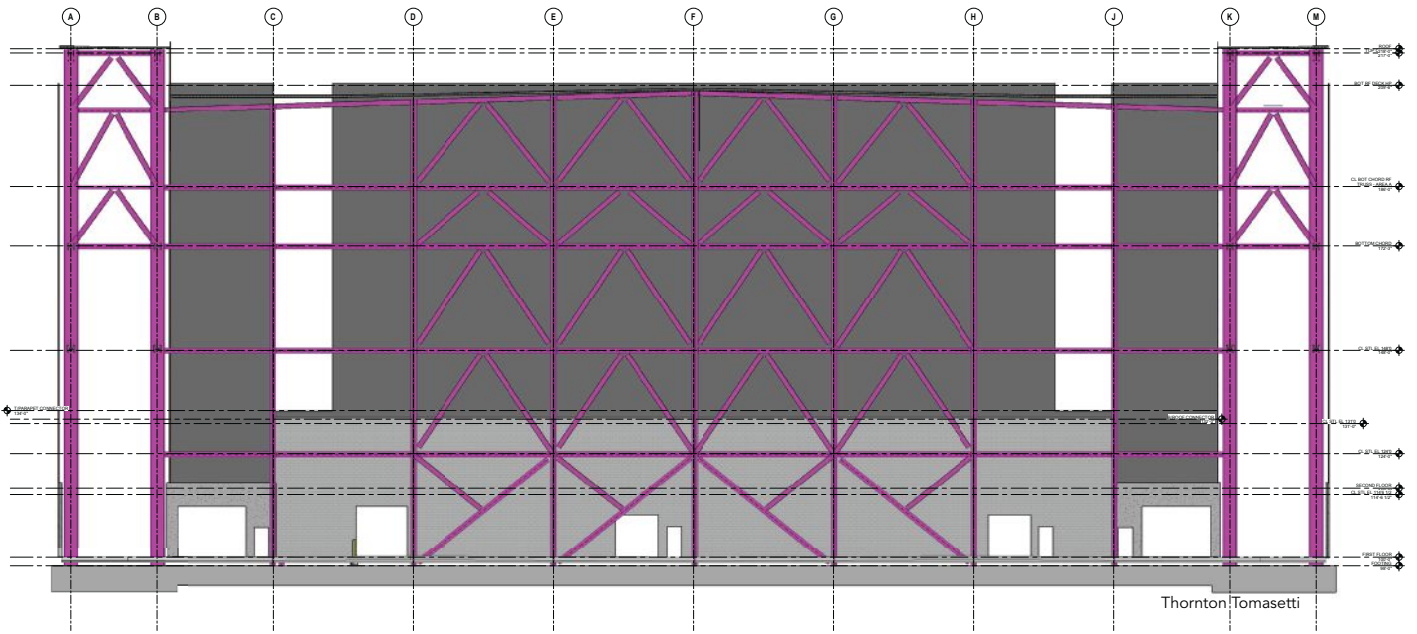

above: Vertical braces at the side walls provided the lateral force resistance for north-south lateral forces.

below: An overhead view showing the original hangar location in red and the new hangar in blue.



maintenance. Steel piles provided support for the hangar and the two side buildings. The foundation at each corner tower includes 44 430-ton-capacity HP16 steel piles beneath a 7-ft-thick concrete mat. Heavily loaded piles at the hangar were driven to rock, approximately 100 ft deep, and batter piles at a 1:3 horizontal-to-vertical slope were used to resist horizontal thrusts of up to 2,300 kips. To accommodate driving large piles at a steep angle, the design team reviewed a 4-in. top-of-pile tolerance. The batter pile configuration was a challenge, as the piles crossed within inches of each other approximately 50 ft below grade, and the foundation construction

team deftly drove all the piles in the towers within tolerance while avoiding driving through adjacent piles.

A unique aspect of designing a long-span structure is the fact that the structural engineer of record (EOR) needs to fully understand how it will be constructed, as this will drastically affect the design. Additionally, these types of structures can benefit from input from the construction team, as there are many factors that determine the overall cost of the structure.

Engineer Thornton Tomasetti's approach included working with architect Ghafari Associates, contractor W.E. O'Neil, fabri-

cator LeJeune Steel Co., and erector Danny's Construction Co. to develop a structural design that accommodated the proposed erection scheme, which eliminated the need for temporary bracing of the truss members during erection—and, most importantly, sharing 3D Tekla models with O'Neil and LeJeune to fully communicate the design intent and geometry of the structure. This type of approach, coined Advanced Project Delivery™ (APD), is based on IPD (integrated project delivery) principles, including collaborative innovation and decision making, early involvement of key participants, open communication, and leveraging technology. LeJeune was brought on board during the early stages of

design to provide guidance on fabrication, shipping, and erection preferences. The design team and steel fabricator worked closely together to develop a design that was both efficient and constructible. Alongside the structural design team, Thornton Tomasetti's in-house construction engineering team developed a 3D Tekla model, and with input from LeJeune also provided the connection design that met LeJeune's and erector Danny's Construction's preferences. The fully connected Tekla model was issued to LeJeune to produce shop drawings three weeks after the structural bid documents were issued, and LeJeune started production of shop drawings immediately and submitted them for review in

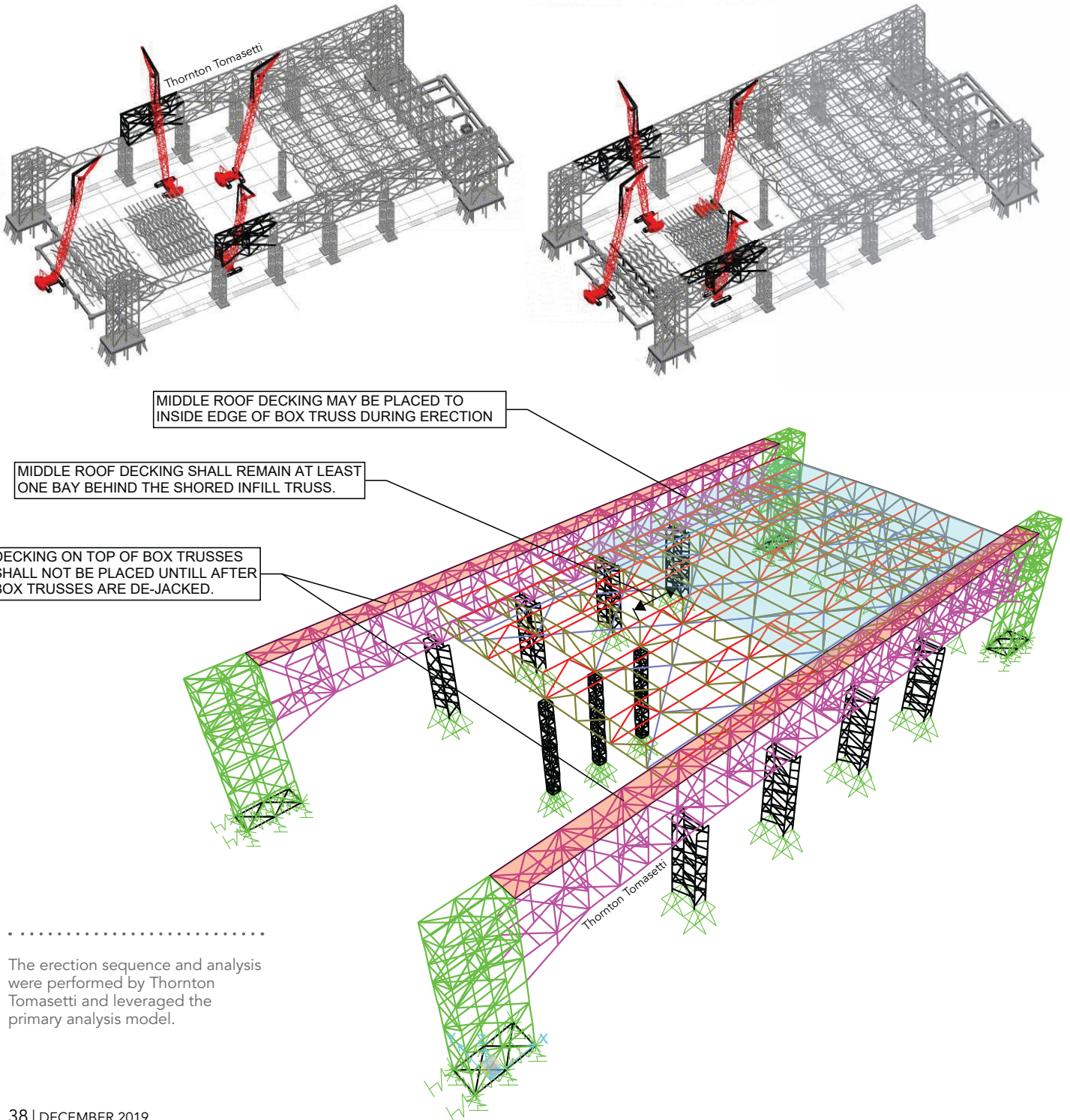

.....

The erection sequence and analysis were performed by Thornton Tomasetti and leveraged the primary analysis model.



Ghafari Associates

An exterior view of the north elevation at dusk. The translucent wall panels were specified to bring light into the building and show off the structure at night.

under a week. This collaborative process streamlined production and erection while mitigating the risk of construction delays.

The process yielded an enhanced design deliverable that provided better definition of scope, better coordination of the design, and a sole source of responsibility, facilitating quick responses and turnaround time on all submittals.

The collaborative team approach was beneficial for steel erection as well. Thornton Tomasetti also provided erection engineering services to Danny's; the analytical model used for the building's design was also used for a staged analysis to evaluate the stability of the partially completed structure at numerous phases of construction. Four temporary shoring towers with up to 800-ton jacks were placed under each header truss assembly. The jacking plan included six phases, with pre- and post-jacking surveys to monitor deflections. Predicted deflections were within ¼-in. of actual deflections upon completion of truss decentering operations.

These unique and collaborative solutions led to a successful project that was designed, fabricated, and erected without a hitch. The approach provided an overall reduction of more than five months in the steel fabrication and erection schedule. Structural

steel RFIs numbered less than five and eliminated any construction delays that may have occurred during fabrication and erection. The new American Airlines Hangar II facility is now poised to service the entirety of American's fleet for years to come. ■

Owner

American Airlines

General Contractor

W.E. O'Neil

Architect

Ghafari Associates, Chicago

Structural Engineer, Connection Designer, and Erection Engineer

Thornton Tomasetti, Chicago

Steel Team

Fabricator

LeJeune Steel Co., Minneapolis 

Erector

Danny's Construction Co., LLC, Shakopee, Minn. 



Crossing the Creek

BY ROBERT ANDERSON, SE, PE, TREVOR KIRKPATRICK, PE, AND KEVIN SWEAT, PE

A new steel bridge comes together
over a downtown waterway in Texas' capital city
thanks to well-planned and executed design and construction.

SHOAL CREEK in downtown Austin might be a fairly modest waterway, but it's seen some big changes in recent years.

The area has been transformed by several projects: the decommissioning of the Green Water Treatment Plant (GWTP) site, stabilization of the east bank of the creek itself, construction of the new Central Library to the west, construction of high-rise condominiums with retail space and restaurants to the east, and the extension of 2nd Street between San Antonio Street and West Avenue.

The latter aspect was the genesis of the 2nd Street Bridge, a new crossing that will provide a vital link for vehicles and pedestrians over Shoal Creek between the new library to the west and the residential/retail areas to the east.

The new bridge is designed, proportioned, and detailed to offer an elegant solution to connect the two sides of the 2nd Street over Shoal Creek with an iconic structure that is and integrated with the future vision of the booming area. Through a series of meetings and design charrettes, AECOM developed a tiered process to elicit input and obtain decisions from key stakeholders. During those workshops the team analyzed and evaluated multiple possible structural steel forms for the bridge, including traditional girder, cable-stayed, and arch schemes.

The chosen bridge type was a canted arch spanning approximately 160 ft. The over-deck supporting elements of the bridge are a pair of trapezoidal shaped steel ribs, each with a network arrangement of galvanized wire rope hangers connected above the deck to the girder framing. A central utility corridor between the box girders accommodates the multiple utility lines that cross the bridge, and the bottom soffit of the corridor is screened by a metal deck bar grating. Outrigger beams carry a curved pedestrian sidewalk that ranges from 12 ft to 14 ft wide. The thrust of the arch ribs is resisted by a foundation system with 6-ft-diameter drilled shafts anchored to bedrock.

Every component of the structure was examined to fit the needs of the project. For example, a gap was created between the sidewalk slab and the bridge's traffic deck. This opening allows light to pass through to Shoal Creek below and creates a feeling of lightness to the bridge. To keep the outriggers from collecting dirt, a stainless steel "hat" section was added to keep the tops of the outriggers clean.

The mantra of "form follows function" was certainly achieved in the bridge's design. The exterior webs of the box girders are canted at a 15° angle to connect to supporting cables to the arch ribs. Transverse framing transfers load from the interior of the girder system to the outside webs, and the tub girders also work to carry load longitudinally to the bearing supports. The result is a highly redundant structural system that is also non-fracture critical, thus reducing future inspection costs for the City of Austin. In addition, the network cable provides longitudinal restraint to the superstructure and also reduces thrust created by the arch rib.

A gap between the sidewalk slab and the traffic deck allows light to pass through to Shoal Creek below and makes the crossing appear lighter and more open to pedestrian and bicycle traffic along the creek.



Robert Anderson (bob.anderson@aecom.com) is vice president and technical leader, complex bridges, and **Trevor Kirkpatrick** (trevor.kirkpatrick@aecom.com) is senior structural engineer, bridges, Greater Florida, both with AECOM. **Kevin Sweat** (kevin.sweat@austintexas.gov) is division manager for the City of Austin Public Works Department's Engineering Services Division.



Touchstone Architecture

above: The arch ribs are attached to thrust blocks on either end of the bridge via base plates and anchor bolts.

right: The arches were lifted and set using a 400-ton crane with help from a 100-ft main spreader beam and two 30-ft spreader beams.

below: Attaching an outrigger to a superstructure tub girder at the fabrication shop.



AECOM



City of Austin

Steel Components

The 160-ft single-span canted parabolic arch bridge varies in width from 63 ft at the abutment to 73 ft at mid-span. The superstructure consists of two steel box girders joined by cross-frames with a composite deck slab, providing two 12-ft-wide traffic lanes. Each of the two arch ribs is canted (sloped) outwards 15° from the vertical plane, matching the angle of the box girder framing, and rises some 31 ft above the roadway.

Each rib comprises a trapezoidal steel box section 3 ft deep with a width varying from 2 ft at the bottom to 3 ft at the top. One refinement made during final design was the selection of painted weathering steel for the arch rib (it was realized that painting the interior of the arch rib after fabrication would be impractical), and

a second refinement was the decision to field-weld the center connection of two of the rib sections.

The thrust arch system resists the compressive forces produced by the arch rib with the foundation elements, versus a tied arch, which resists the arch rib forces with a bottom chord tie. The ends of each arch rib are supported at concrete thrust blocks connected to large concrete footings at each end of the bridge. These footings also support some of the weight of the bridge deck superstructure carried by the two longitudinal steel box beams. Each footing is supported by six 6-ft-diameter drilled shafts that are socketed into the underlying bedrock. The deck roadway surface comprises a 9-in.-thick reinforced concrete slab acting compositely with the steel box beams.



AECOM

above: The bridge is at the epicenter of downtown Austin's construction boom.



AECOM

left and below: A network of 20 galvanized wire rope hangers along each arch rib support the bridge deck structure below. The tops of the hangers are connected to the arch rib using a forked pin-and-clevis system, and the bottoms are connected to the top of the longitudinal girders using a bolted anchor assembly.



AECOM

A network of 20 2-in. galvanized wire rope hangers along each arch rib supports the bridge deck structure below. Each hanger is sloped $\sim 45^\circ$ in the direction of traffic, resulting in a diamond pattern. The tops of the hangers are connected to the arch rib using a forked pin-and-clevis system, and the bottoms are connected to the top of the longitudinal girders using a bolted anchor assembly. The hangers were stressed to approximately offset the tributary load of each panel and thus minimize the longitudinal girder moment. With one or the other bearing longitudinally engaged, it became apparent that the short hanger cables would draw too much force due to thermal loads. Therefore, the bridge was released at both ends for longitudinal movement. Longitudinal restraint is provided by the hanger cable network, which transmits longitudinal loads to each thrust block and abutment.

Ten steel “outrigger” I-beams spaced at 14 ft, 6½ in. along the length of the bridge extend outward from each longitudinal steel box beam to support a sidewalk. Each outrigger beam varies in depth from ~ 6 ft at the steel box beam to ~ 2 ft, 6 in. at the free end. Like the traffic deck, the sidewalk also consists of a 9-in.-thick reinforced concrete slab—again, with a varying width of 12 ft at the abutment to 14 ft at mid-span. A precast fascia beam attached to the ends of the outrigger beams provides a clean line at the outside edge of the bridge. The width of the gap between the roadway and sidewalk slabs ranges from 3 ft to 6 ft. The combination of the varying gap width and varying sidewalk width creates a curved edge beam in plan, with a depth that varies from 2 ft, 6 in. at mid-span to ~ 3 ft, 4 in. at the abutment.



Florida Structural Steel/Tampa Tank

above: Shipping a completed half of an arch-rib girder from the fabrication facility.
 below: The pedestrian and vehicle bridge carries 2nd Street over Austin's Shoal Creek.

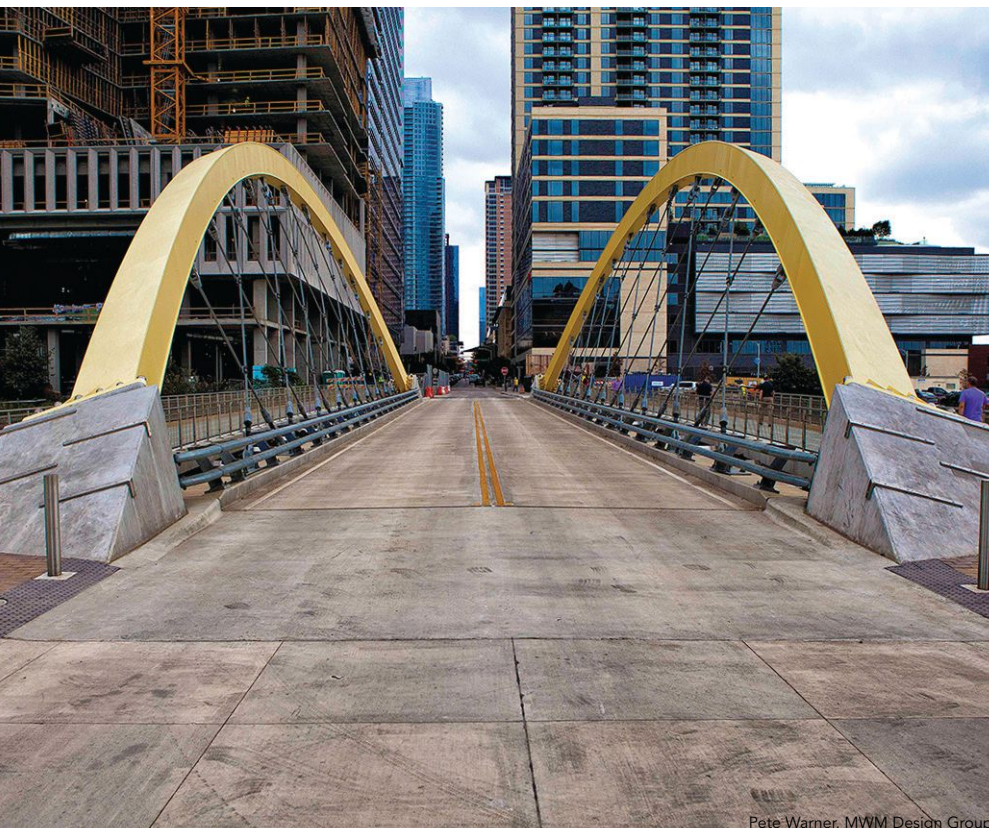

Pete Warner, MWM Design Group

Construction

The structural steel components, including the longitudinal steel box girders and the outrigger beams, were shipped to the site via truck. To develop a proposed construction sequence for the bridge, careful consideration was given to the presence of existing overhead power lines located over the east end of the bridge site. A shorter, lighter section of the longitudinal girder was detailed beneath the overhead power lines, enabling a smaller, low-head crane to pick up and place the girder section. The erection sequence presented in the plans was used to construct the bridge, and the contractor supplemented the erection sequence with erection plans developed by the erection engineer. The general steps are as follows:

- Stage 1 – Install the foundations.
Install the girder temporary shoring in creek.
- Stage 2 – Erect and splice/bolt longitudinal girder sections at the east end.
- Stage 3 – Erect and splice short longitudinal girder section beneath the overhead power lines at the west end.
- Stage 4 – Erect the cross frames, diaphragms, and outrigger beams.

- Stage 5 – Cast the roadway deck and sidewalk concrete.
- Stage 6 – Install the arch rib falsework and erect the arch rib.
- Stage 7 – Remove the arch rib falsework and install and stress the hangers.
- Stage 8 – Remove the girder temporary shoring.
- Stage 9 – Install and complete utilities and finishing works.

The longitudinal girders were lifted and set using a 600-ton crane positioned near the southeast corner of the bridge. Each of the twin box girders were set in two lifts. The first lift comprised the east and central field sections, which were spliced together prior to lifting. The second lift comprised the shorter west field section and was made continuous by splicing the sections in the air. Although an allowance was made for a smaller crane to set the west field section to avoid power lines over the west abutment, the contractor used the larger crane by working with the utility company to temporarily de-energize the lines.

The arch ribs were shipped to the site in halves, and field welding was used to join the halves of the arch rib on the ground. The full length of the arch ribs was lifted and set using a 400-ton crane. A 100-ft main spreader beam in tandem with two 30-ft spreader beams and varying length cables were also used. After grouting the arch rib base plate and stressing the anchor bolts at the connection to the thrust block, the arch rib temporary tower was removed.

The cable hangers were fabricated off-site to the lengths specified in the contract documents. Each of the hanger cables was initially connected to the upper and lower pin plate with slack in the cable. The cables were then sequentially stressed to the target jacking forces provided by the erection engineer.

A jacking assembly fabricated by the contractor used hydraulic jacks bearing on the cable anchor and attached to high-strength steel rods to tension the cables. The steel rods were fixed to the lower anchorage assembly by jacking holes provided in the lower pin plate.

The force in each cable was confirmed with a lift-off test. Fine adjustments were made to the cable forces based on the result of this test. With the superstructure in place, miscellaneous components and

THE PROVEN STEEL BRIDGE DESIGN SOLUTION

FREE 15-DAY TRIAL*
*see website for details



The leading software package for designing and rating curved and straight steel girder bridges.

Used by Many State DOTs and Top Design Firms

(573) 446-3221 ■ www.mdxsoftware.com ■ info@mdxsoftware.com



THE HOLE SYSTEM AT A FAIR PRICE!

Affordable, extra heavy-duty and reliable, with state-of-the-art cutting options.

Contact PCS to discuss your requirements!



brian@usapcsinc.com

1-800-656-1903 | www.profilecuttingsystems.com

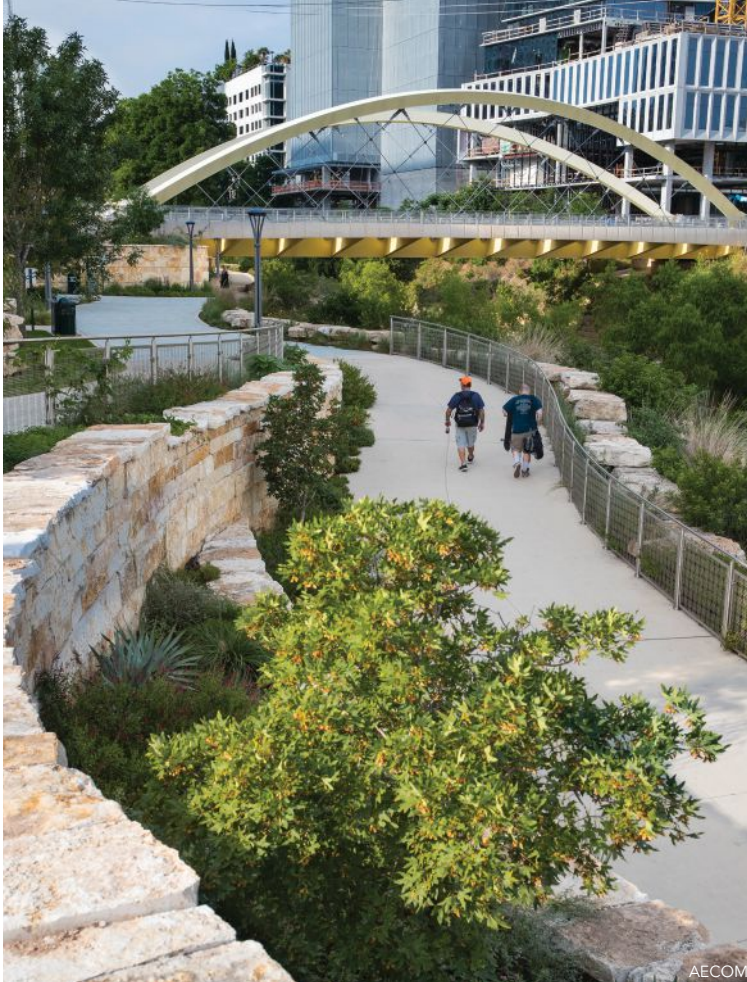

above and below: The new 160-ft-long bridge is designed to offer an elegant solution to connect 2nd Street over Shoal Creek with an iconic structure that is friendly to both vehicles and pedestrians.

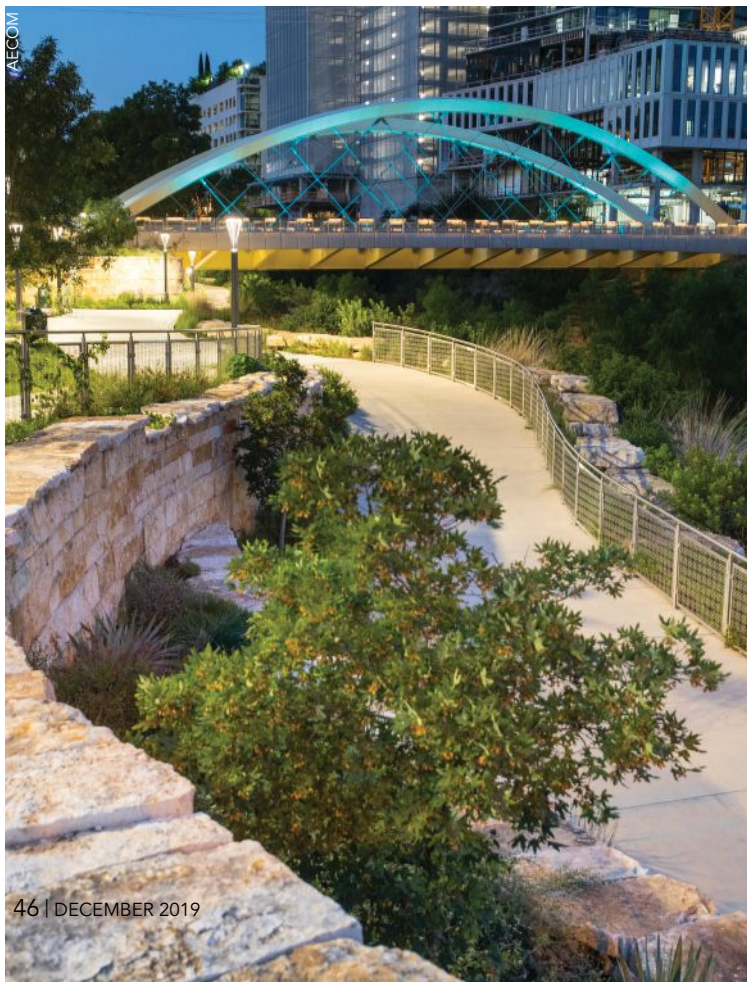

Charrette Mindset

Design charrettes helped inform decisions on steel design schemes and other site considerations for the bridge. At the first charrette, five bridge concepts were developed that considered discussions from the kickoff meeting: circular arch, trapezoidal arch, canted/butterfly arch, single-plane cable-stay arch, and dual-plane cable stay arch. The arch concepts presented used a lower arch-rib profile to lessen the vertical height impacts on the above power lines. The charrette participants stated a preference for a canted (butterfly) arch (vs. vertical) with an arch rib having a trapezoidal cross section (vs. circular). Avoiding struts, with the use of outriggers, was thought to be less busy and ended up being the preferred option. Additionally, a network arch with crisscrossing hangers was favored over vertical hangers.

The second charrette meeting focused on decisions related to more specific design features of the preferred canted arch structure type, such as hangers and coating system. Several types of wire rope hanger arrangements were presented and discussed. The topics ranged from girder connection type (bottom vs. top) to the crossing angle. The preference was stated for a $\sim 45^\circ$ crossing angle and a minimalistic above-deck anchorage connection. The top arch rib connection of the hangers was envisioned as a forked pin-and-clevis system.

At the third charrette, general discussion was undertaken regarding bridge finishes, included painting, color schemes, galvanizing, and weathering steel. Regarding unpainted weathering steel, it was removed from further consideration due to its staining potential for the adjacent concrete components. While the life-cycle cost, low maintenance, and durability advantages of galvanizing were attractive, the initial cost and non-painting ability to repair graffiti ruled out this option for the major bridge components like the arch rib and the girders (though galvanizing was felt to be appropriate for secondary steel components such as the traffic and pedestrian rails and the hanger connections at the deck level). For the main steel components, the initial color chosen was a sage green. However, the final color was determined to be yellow after consultation with City of Austin representatives and bridge architect Touchstone, as it provided more "pop" visually.

finishing works were then installed, including railings and utilities. ■

Owner

City of Austin, Texas

Construction Manager

Hensel Phelps Construction Co., Austin

Architect

Touchstone Architecture,
Miramar Beach, Fla.

Landscape Architect

MWM DesignGroup, Austin

Structural Engineer

AECOM, Tampa, Fla.

Erection Engineering

Stone Structural Engineering
Beeville, Texas

McElhanney Consulting Services, Inc.,
Tampa

Steel Team

Fabricators

W&W/AFCO Steel, 
Little Rock, Ark. (Prime)

Florida Structural Steel/Tampa Tank, 
Tampa, Fla. (Subcontractor)

Detailer

Dowco Consultants, Ltd., 
Langley, B.C.



AECOM

An inside look at one of the bridge's arch ribs during fabrication.

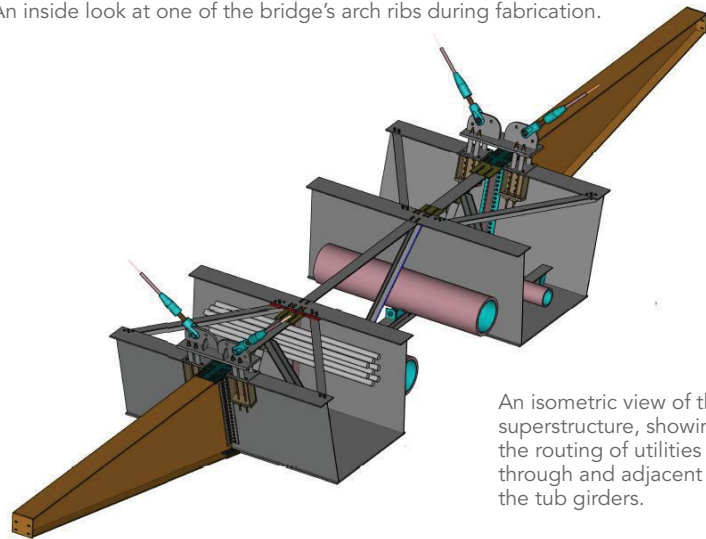

An isometric view of the superstructure, showing the routing of utilities through and adjacent to the tub girders.

**WE REDUCE THERMAL BRIDGING,
SO YOU CAN MEET YOUR ENERGY GOALS.**

The importance of reducing thermal bridging in the building envelope is becoming a priority for conformance to energy efficient certifications. Let Fabreeka assist with thermal break on your next building project:

info@fabreeka.com



**We are the specialist
at your side.
For 100 years.**

www.fabreeka.com



Hexavalent chromium is a legitimate safety hazard
when welding stainless steel.

But it can be removed from the equation with
proper safety equipment and practices.

Combating Chromium

BY KATIE RICHARDSON



Katie Richardson

(krichardson@sentryair.com) is the marketing coordinator for Sentry Air Systems, Inc., in Cypress, Texas.

This article is excerpted, with permission from the American Welding Society (AWS), from an article published in the November 2018 issue of *Welding Journal*. (All photos: Sentry Air Systems.)

WELDING GENERATES FUMES from the application of heat on metal materials—but certain types of metal produce more hazardous fumes than others.

When welding stainless steel, chrome alloys, or chrome-plated metals, the resulting fumes can create health risks due to the presence of chromium—hexavalent chromium in particular.

While respirators are a common method for protecting welders from fumes, they alone may not provide enough respiratory protection. The National Institute for Occupational Safety and Health (NIOSH) recommends using other control methods in conjunction with respirators, such as installing local exhaust ventilation systems like fume extractors. To understand the importance of welding fume extractors, we will first explain what hexavalent chromium is, why it's dangerous, and how it's regulated.

What It Is, Why It's Bad

What is hexavalent chromium? Chromium is primarily consumed by the steel industry, with alloys of stainless steel and chromium containing about 11.5% to 30% chromium by weight. During the welding of chromium alloy steel or stainless steel, the heat turns the chromium into *hexavalent chromium*, a more unstable, hazardous, and easily absorbed form of chromium. Once inhaled, hexavalent chromium must turn into a stable form, resulting in the production of toxic and carcinogenic free radicals that can damage DNA.

The International Agency for Research on Cancer (IARC) classifies hexavalent chromium as a carcinogen in humans. The most commonly caused cancer from hexavalent chromium is lung cancer, due to the inhalation of fumes, with the risk dependent on personal health as well as the intensity and duration of the exposure.

Not only does hexavalent chromium increase the risk for lung cancer, but it can also cause sinonasal, oral, liver, and esophagus cancers. However, the risks for these cancer types are much lower, with little evidence that they are directly caused by hexavalent chromium exposure.

Also, exposure to airborne hexavalent chromium has been shown to irritate the nose and throat, with symptoms such as a runny nose and nose bleeds. In severe cases, exposure can result in nasal septum perforation. Overall, any nasal symptoms should be closely monitored because they can signify cancer development.

In addition to cancer risks, welders exposed to hexavalent chromium may become allergic and develop wheezing or shortness of breath. While small concentrations don't normally cause respiratory issues with most people, increased exposure can result in bronchitis, asthma, and damage to the skin, eyes, kidneys, and liver. Pulmonary congestion, abdominal pain, and teeth irritation or yellowing may also result from exposure.

Regulations and Guidelines

Now that we understand the health risks of hexavalent chromium, let's take a look at how its exposure is regulated in order to protect workers' safety and health.

OSHA legally requires employers to keep the time-weighted average (TWA) of exposure below the permissible exposure limit (PEL) of $5 \mu\text{g}/\text{m}^3$ for eight hours of work five days a week. Employers must conduct monitoring assessments to check the level of airborne hexavalent chromium. If the airborne level is at or above $2.5 \mu\text{g}/\text{m}^3$, OSHA requires that action must be taken to control fumes and regularly monitor exposure every six months to ensure the exposure level does not exceed the PEL.

In contrast, NIOSH and the American College of Governmental Industrial Hygienists (ACGIH) have much stricter exposure recommendations. NIOSH's recommended exposure limit (REL) of $0.2 \mu\text{g}/\text{m}^3$ for eight hours of work five days a week is not legally enforceable but does provide best practice recommendations for employers to help reduce the risk of cancer for exposed workers. NIOSH selected this limit because this exposure level had a $1/4,000$ cancer risk, derived from data of a quantitative risk assessment of lung cancer deaths from a Maryland chromate production facility over a 45-year lifetime exposure. The ACGIH recently decreased its threshold limit value (TLV) to $0.2 \mu\text{g}/\text{m}^3$, which is the same as NIOSH's REL. The ACGIH also advises a short-term exposure limit of $0.5 \mu\text{g}/\text{m}^3$ for a 15 minute period.

Determining Risk

So how do you determine the level of risk? The amount of exposure to hexavalent chromium during welding depends on the amount of chromium in the filler and base metal, as well as the type of welding process. A study by the Electric Power Research Institute collected exposure samples from different types of welding at six electric utility companies. The mean exposure was



above: A portable fume extractor with an extra flexible capture hose to enable placement in hard-to-reach areas, being used beside a welder.



above: A worker welds next to a dual-operator, portable welding fume extractor featuring heavy-duty arms and a cleanable filter.

below: Two welders benefit from using a dual-arm portable fume extractor with a cleanable filter.



Permissible and Recommended Exposure Limits Matter

You can access annotated tables of permissible exposure limits on the OSHA site at [osha.gov/dsg/annotated-pels/index.html](https://www.osha.gov/dsg/annotated-pels/index.html).

As the site states, "To provide employers, workers, and other interested parties with a list of alternate occupational exposure limits that may serve to better protect workers, OSHA has annotated the existing Z-Tables with other selected occupational exposure limits."

Additional guidance on OSHA's website consists of NIOSH recommended exposure limits, including the following statement: "In developing RELs and other recommendations to protect worker health, NIOSH evaluates all available medical, biological, engineering, chemical, and trade information relevant to the hazard. NIOSH transmits its recommendations to OSHA for use in developing legally enforceable standards."



A rugged-air portable fume extractor uses a heavy-duty extractor arm and cleanable filter to capture and remove fumes at the source.

calculated for the different welding types representing the time-weighted average concentration at the welder's breathing zone for a full work shift. The exposures were measured under the welding hood, but the welders did not wear respirators. The use of ventilation varied in the recorded exposures from low to medium to high with local exhaust ventilation. The mean exposures for the distinct welding types are as follows:

- Shielded metal arc welding (SMAW): $1.4 \mu\text{g}/\text{m}^3$
- Gas metal arc welding (GMAW): $1.3 \mu\text{g}/\text{m}^3$
- Gas tungsten arc welding (GTAW): $0.14 \mu\text{g}/\text{m}^3$

All of the mean exposures were below the OSHA PEL, but the recorded exposures for SMAW had 25% above the PEL with 37% above the action level, and for GMAW, 28% above the PEL with 33% above the action level. The exposure level for SMAW was only below the OSHA PEL when the welder properly used local exhaust ventilation and the chromium content of the consumable was less than 3%. To ensure hexavalent chromium fume protection for SMAW, the local exhaust ventilation should be optimized by consistently moving the capture hood closer to the weld.

From this study, you can see that SMAW and certain types of GMAW produced the

highest concentrations of hexavalent chromium fumes. Other types of stainless steel welding, such as flux cored arc welding (FCAW), GTAW, pulsed-spray welding, and short circuit welding, produce fewer chromium fumes than SMAW.

Beyond Respirators

There are several ways employers can keep hexavalent chromium levels below the OSHA PEL and/or NIOSH's REL, including changing the welding type, reducing the amount of chromium in the material and the electrode, using personal protective equipment (PPE), and installing local exhaust ventilation or fume extractors.

The most functional and versatile fume extractors are portable source-capture units, as they can be easily installed and moved to different welding locations because they do not require exterior ducting or makeup air. With an application like welding, flame-retardant capture hoses and filter media provide optimized safety. Flame-retardant hoses are available as self-supporting flexible hoses, allowing the operator to move the capture source closer to the weld, or as extra-long flexible hoses that allow fumes to be extracted in hard-to-reach areas.

Most welding fume extractors use high-efficiency particulate air (HEPA) filters or cleanable micro-pleat filters. HEPA filters are best suited for lower-volume welding and provide up to 99.97% efficiency on particles as small as 0.3 microns. Cleanable filter media provides a solution for high-volume applications by allowing the operator to clean and reuse the filter without removing it from the system. The cleanable filter media systems are usually larger but also do not require ductwork or makeup air, making them easy to move if needed. Multiple-operator systems provide two or four capture hoses to allow multiple employees to use the same system.

Ambient air cleaners provide added protection to collect fumes and particulate from the room's air. This type of system is recommended to be used in combination with source-capture fume extractors but can be used as a primary control device for low-fume-producing applications. General ventilation helps protect workers not directly involved in stainless steel welding.

Overall, fabricators need to consider a variety of options for protecting their workers. With a better understanding of the risks associated with hexavalent chromium in stainless steel welding, employers can ensure safety for their welders and others working near them. ■



Hanging ambient air cleaners, such as the models seen here, are advised to be used with a source-capture fume extractor.

Trimble

Design, Fabricate and Erect Steel Structures on Time and Budget

Tekla Structures and FabSuite are powerful and flexible software for steel fabricators and detailers. The model-based fabrication workflow benefits your whole operations.

Join our webinars to learn more on latest software improvements and truly connected steel fabrication process.

 **Tekla 2019** Sneak Preview Webinar
www.tekla.com/us/about/webinar



Writing the Book on BIM

BY LUKE FAULKNER

A new AISC publication covers the basics of 3D modeling and virtual design and construction as they relate to the structural steel industry.



Luke Faulkner (faulkner@aisc.org) is AISC's director of technology initiatives.

IT TURNS OUT this whole BIM thing may have some staying power after all.

Since its early days, many expected BIM (building information modeling) to be replaced or superseded by the next bright, shiny object—but that hasn't happened yet. That said, BIM seemingly exists in a sort of quantum state. While it has matured from its early days and is now seen as an everyday occurrence, it's still somehow shrouded in confusion and questions. Answering them is not always as simple as we'd like, and finding a return on investment using BIM can at times be elusive. It can be tricky to initially deploy new technology on a company-wide basis, and commitment can falter once a company moves past the "excitement phase" of integration.

A key failing in many of these cases is a simple lack of references, a feeling of being out in the woods without a map to get you where you want to go. That's not to say there are no references. There are actually quite a few BIM manuals, guidebooks, and introductions, but many are, to put it politely, not terribly accessible, and none of them are specific to the steel construction industry.

But that's about to change with the release of AISC's *Guide to BIM & VDC for Structural Steel*, which is geared specifically toward the structural steel design community and is expected to be available this month at aisc.org/bimguide. And yes, that's two acronyms in one title; the latter stands for virtual design and construction. This new free guide will not only provide an introduction to BIM, but also address issues that affect the design and fabrication of structural steel.

A Guide to the Guide

Following are answers to some questions we've anticipated about the new publication.

Is this guide an AISC standard or part of the AISC *Code of Standard Practice for Steel Buildings and Bridges* (ANSI/AISC 303)? No. One of the key reasons behind the guide's development is that publications like the AISC *Code* are on comparatively long revision cycles relative to the pace of technology—though the task group developing the guide has worked hard to ensure that it is properly harmonized with the *Code*.

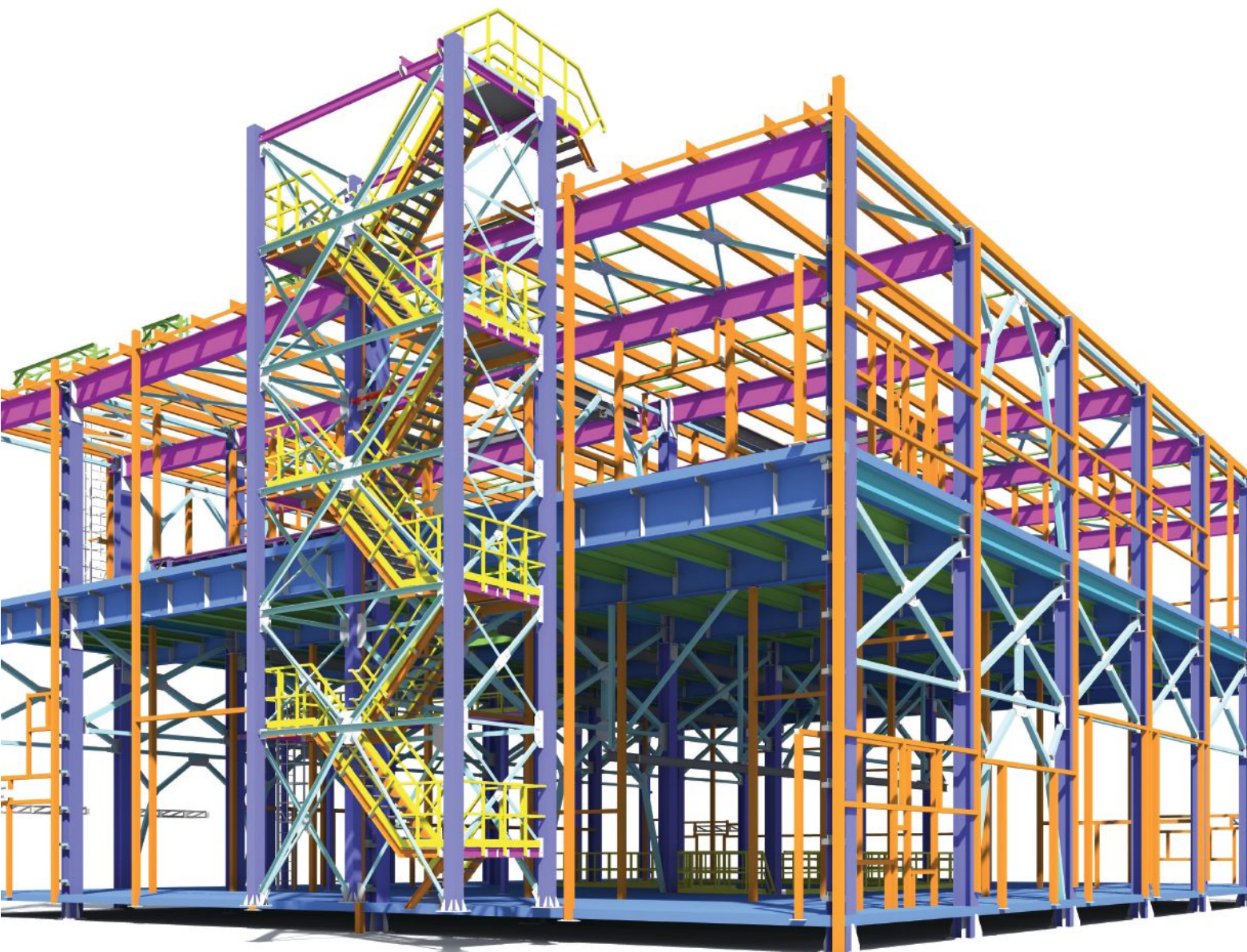

Who is this guide aimed at? Anyone in the structural steel supply chain should get some use out of the guide, though it is aimed primarily at steel fabricators and detailers and structural engineers. The first edition of the guide is intended to benefit those in the middle to tail end of the bell curve when it comes to BIM—i.e., not the early adopters. As the guide (and BIM itself) matures, it will begin to capture and be updated to include some of the more complex issues related to BIM.

What's in it? The challenge that the task group was, well, tasked with was to develop a publication that is simple, accessible, and concise. Keeping the first edition to 25 pages was crucial to its ease of use. The guide addresses fundamental issues such as:

- Understanding BIM – How to distinguish between BIM as a noun (building information model) BIM as a verb (building information modeling) and VDC.
- Getting Started with BIM – BIM can't be bought in a box, and this section addresses a lot of the issues that companies and/or projects will struggle with when implementing BIM.
- Interoperability – Understanding how different software platforms communicate with each other and exchange data. This is a foundational component of BIM and is often misunderstood and misappropriated.



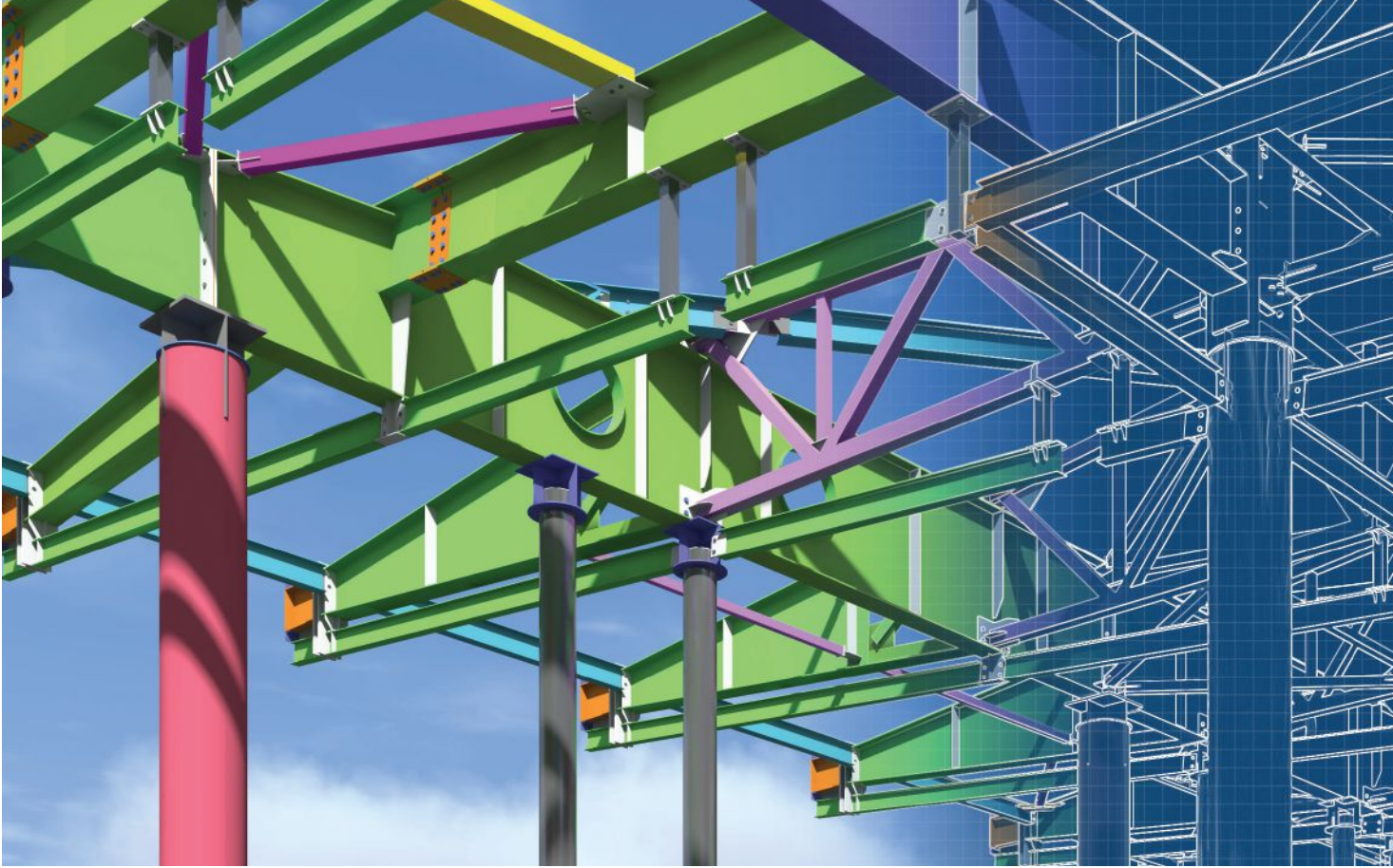

Interoperability: A Brief History

In the 1980s, when 3D digital models were introduced in the structural steel engineering and fabrication sectors, interoperability between models was also introduced to increase efficiency and communication within the construction industry. Early proprietary formats, such as the SDNF file, were being developed. A few years later, in an attempt to bring some harmony to the various software packages that were being developed, AISC promoted the CIS/2 file format as a common standard for structural steel. This format sufficed well for primary structural steel but was not sufficient for other trades in the construction industry. Thus, the IFC file format came about and was adopted, eventually replacing the CIS/2 format. IFC then became the exchange file format norm for structural steel. Unfortunately, as with any common file format, information would get lost in translation. As with any language, there are misinterpretations on some vague areas within the standard, and this would cause issues when moving data from one 3D modeling software package to another. To clarify the standard, AISC developed the EM11 to work with NC machinery, specifying where data was to be located in the IFC 2x3 file format. As the industry continues to develop, we are now seeing software companies that have developed application programming interfaces (APIs), which allow a more controlled push and pull of information between software packages. In a way, this reverts back to the old days of the proprietary formats, but with better efficiency and no large, cumbersome files to be transferred and stored.

This sidebar was excerpted from the Guide to BIM & VDC for Structural Steel.

- Model views and usage – A look at the different model types and the given purpose and use of each one, and why it's important to understand the difference between them.
- An explanation of the *Level of Development (LOD) Specification* – The *LOD Specification* is, at its core, all about the reliability of model elements. It's becoming more and more common to see it in specifications and bidding documents, but it can be a source of much confusion and misuse.
- An overview of BIM execution and planning guides (BxP) – The BxP is a critical tool in the planning and success of any BIM project. There are myriad BxPs used in the industry (Penn State is well known for its work in this area, as are the General Services Administration and BIMForum).
- The BIM Ecosystem – An illustration to help readers understand the various software packages used in the structural steel industry, with a simplified view of the workflow between them and avenues through which the model may be shared.
- Other References – The guide will also include a glossary of common terms, an index of different file formats, best practices, and an explanation of the costs of implementing BIM.

What if I think there's a relevant issue the guide doesn't address? We'd like to hear from you and will have an ongoing comment system. While the rigor that comes with, say, an ANSI standard does not exist with the guide, we still take public comments and suggestions very seriously and need to know if there are pain points that could be addressed or issues that could be further clarified.

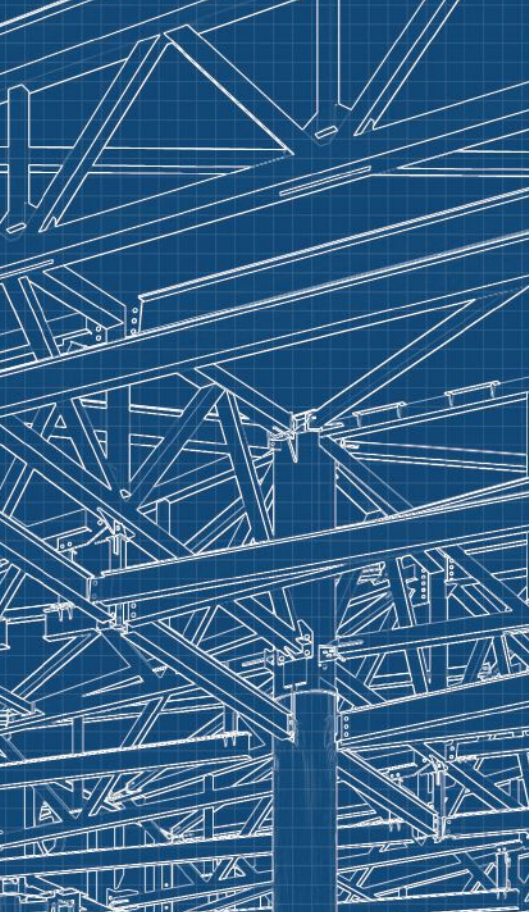

Can I get a hard copy? At this point, we don't expect sufficient demand to justify a full printing of a hard copy. However, the guide will be available as an unlimited free download, which is reflective of the trends we see for many BIM-related documents.

Moving Forward

We're aware of how fast the technology landscape can change, and the *Guide to BIM & VDC* even contains an acknowledgement that this is a living document. We need to be able to keep up with the pace of change as more technology is deployed in the industry while at the same time not create a "moving target."

Our aim is to keep substantial revisions on a yearly basis, avoiding the confusion that can emerge from a constant stream of revisions. Minor edits—such as updating the name of a software package in the event of rebranding or acquisition, or updating live links—may be carried out on a rolling basis. The document will evolve as appropriate, but maintaining ease of use—as with the software it covers—will be a primary goal with each iteration. The idea is to make BIM easier to understand and use, which will result in better, smoother steel projects. ■



Still using angle iron roof frames?

QUICKFRAMES™

www.quickframes.us/NICE

480-464-1500



Automated Stair & Railing Layout

WWW.AUTOMATEDLAYOUT.COM

603-402-3055

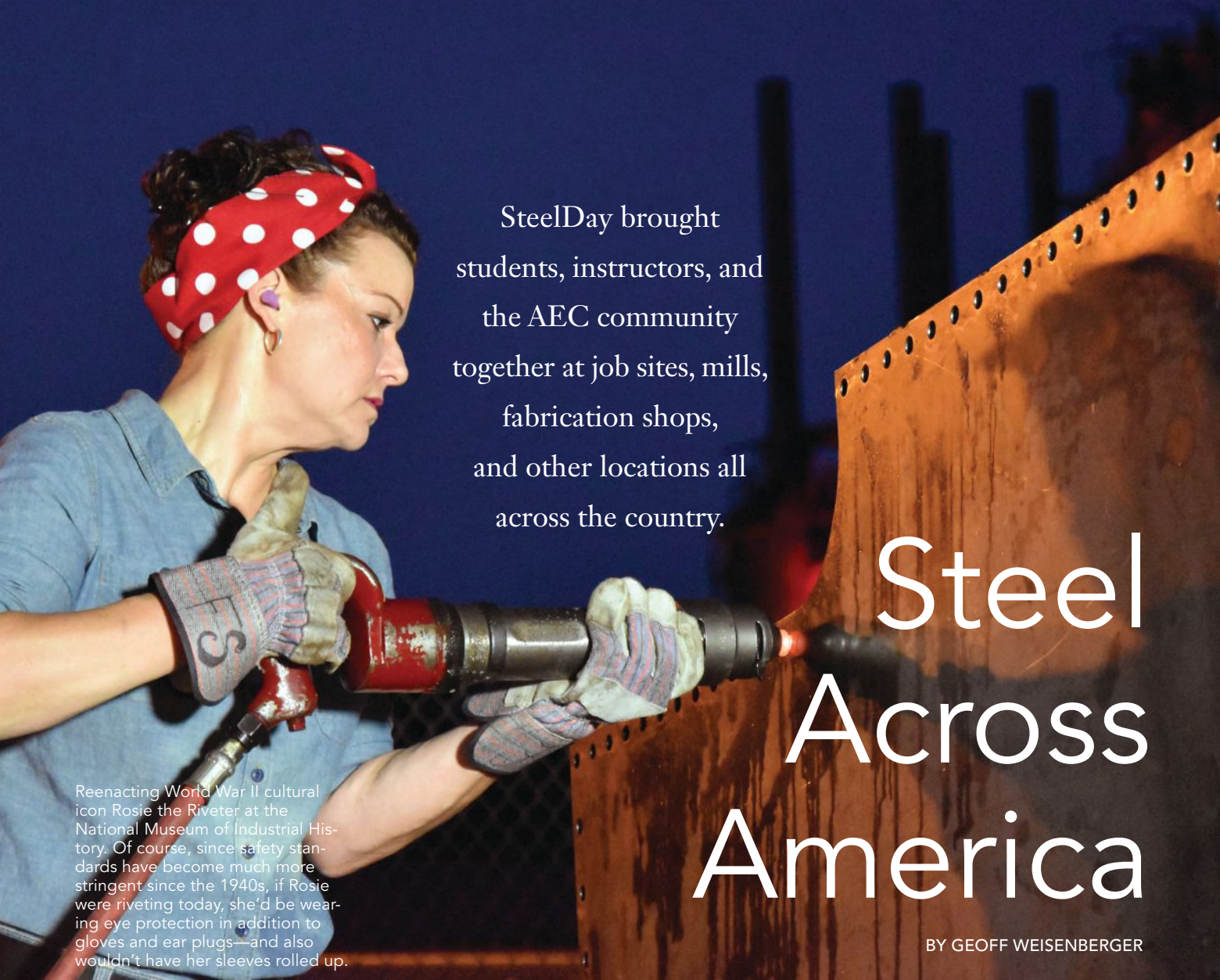

SteelDay brought students, instructors, and the AEC community together at job sites, mills, fabrication shops, and other locations all across the country.

Steel Across America

BY GEOFF WEISENBERGER

Reenacting World War II cultural icon Rosie the Riveter at the National Museum of Industrial History. Of course, since safety standards have become much more stringent since the 1940s, if Rosie were riveting today, she'd be wearing eye protection in addition to gloves and ear plugs—and also wouldn't have her sleeves rolled up.



Geoff Weisenberger (weisenberger@aisc.org) is senior editor of *Modern Steel Construction*.

IT'S DIFFICULT TO BE in more than one place at the same time—although, for better or for worse, cell phones and social media are doing their best to change that.

Here, we've done our best to take you to SteelDay events across the country. Most took place on the actual day—Friday, September 27—though some occurred before or after. SteelDay is AISC's annual celebration of the structural steel industry, involving events throughout the country, hosted by its members and partners, for AEC professionals, faculty, students, and the public to see firsthand how the vibrant U.S. structural steel industry works to build our country's buildings and bridges.

This year's events represented a wide range of ways to learn about the inner workings of the industry. Some attendees were able to see how projects come together in real time, visiting project sites while steel was erected around them or observing steel members being drilled and sawed in high-tech fabrication facilities. Some listened to presentations and mingled with industry peers in venues ranging from lecture halls to completed steel buildings to fabrication shops and even a boat, in some cases gleaning advice from designers at the top of their profession, such as Ron Klemencic, or learning about AISC publications firsthand from AISC staff like our director of engineering, Cindi Duncan. Others learned about steel's role in the American economy and the advancements in the steelmaking process at a museum dedicated to the history of manufacturing. And yet others put their welding and cutting skills to the test in actual fabrication facilities, in at least one case competing for the chance to win a scholarship.

Read/look on for a pictorial tour of just a handful of the events that took place on and around SteelDay 2019.



Lancaster, Pa.

High Steel Structures (an AISC member fabricator) hosted a record-breaking 275 guests for its latest SteelDay event in Lancaster, Pa. Project owners, designers, students, contractors, and other industry professionals attended a morning technical session with featured speaker Shane Beabes, PE, vice president and lead of the Southeast Region Complex Bridge Practice at AECOM, who shared a presentation on the rehabilitation of the Arlington Memorial Bridge over the Potomac River between Arlington, Va., and Washington, D.C. In the afternoon, attendees toured High Steel's facilities, and some tried their hand at welding a sculpture of the High Steel logo. "Welding looks so easy!" commented one attendee, who didn't partake. [Editor's note: Welding is not easy. I know this from experience, having attempted it at a previous SteelDay event. It requires patience, training, skill, experience, and a steady hand to create the desired "stack of dimes" look.]

Bethlehem, Pa.

An after-hours event at the National Museum of Industrial History (NMIH) featured actors modeling historical scenes from Bethlehem Steel using actual steelmaking equipment, smoke machines, and lighting equipment to produce memorable scenes from steel history. The event was part of NMIH's Steel Weekend, a celebration dedicated to the structural steel industry, complete with forging and riveting demonstrations, the latter performed by a real-life Rosie the Riveter (pictured on the opposite page). Fun facts from the museum include a display on the evolution of structural steel columns as well as some interesting numbers. According to the museum, there were more women making silk than men making steel in the Lehigh Valley from 1915 to 1925. In addition, Bethlehem Steel built 1,127 ships of 19 different classes during World War II.



Cheyenne, Wyo.

For the third year in a row, Puma Steel (an AISC member fabricator) centered its SteelDay event around a student welding competition with a multitude of prizes, including AISC Rex I. Lewis Fast Start Scholarships to Laramie County Community College's

welding program. And also for the third year in a row, the Wyoming governor was on hand for the festivities. (For more about this event, see "Winning Welding in Wyoming" in the August issue at www.modernsteel.com.)



Newport Beach, Calif.

“Let’s Taco ’Bout Steel” was a SteelDay networking reception held at AIA Orange County’s new office—and yes, tacos were provided, along with live music and discussions about structural steel. Said one attendee: “I told my wife that I would be at this work event for 20 to 30 minutes. Now it’s two-and-a-half hours later and I’m still here. She’s never going to believe I was talking about steel all this time. But I was.”



Syracuse, N.Y.

AISC member fabricator JPW Companies provided shop tours and also treated attendees to a presentation from AISC’s Cindi Duncan. “This is the first time I’ve presented on the AISC *Specification for Structural Steel Buildings* and the *Code of Standard Practice for Steel Buildings and Bridges* on the shop floor of a fabrication plant,” commented Duncan. “And there ended up being the sound of drilling/welding in the background! How appropriate is that?” Not only were AISC publications discussed, but a copy of the AISC *Steel Construction Manual* was also raffled off.



Lakeland, Fla.

GMF Steel Group’s (an AISC member fabricator) SteelDay event featured a discussion on advancements in and advantages of steel construction, highlighting the efficiency of the steel fabrication process. Presentations were given by AISC’s Tampa structural

steel specialist, Larry Flynn, GMF president Andy Norman, and Walter P. Moore’s Dylan Richard. Guests were then able to tour the facility, where tour guides explained and demonstrated what it takes to become an AISC certified plant.



Marina Del Ray, Calif.

Up the coast from Newport Beach, attendees set sail on a three-hour tour on a yacht, the *Dandean*, for a networking event that also included a presentation on a very relevant topic for the area: seismic standards. “I could get used to this!” said one attendee, Austin Gould with Fenagh Engineering and Testing. “Can every day be SteelDay?”

San Francisco

At the Steel Innovations Symposium event, made possible in part by community partners AIA San Francisco and SEA of Northern California, attendees had the opportunity to hear guest speaker Ron Klemencic of Magnusson Klemencic Associates (MKA) talk about SpeedCore and its implementation in Seattle's Rainier Square Tower (for more on SpeedCore and Rainier Square, see aisc.org/speedcore.) Also discussed was AISC's BHAG (Big Hairy Audacious Goal). Want to find out more about it? Check out the Project Extras section at www.modernsteel.com.

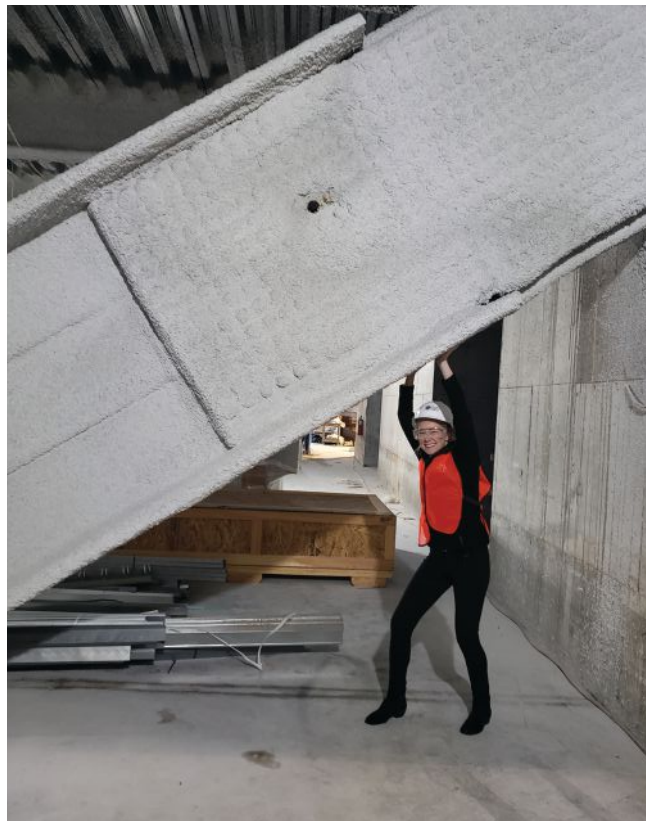

Chicago

In Chicago (home to AISC's headquarters) attendees got an inside look at 110 N. Wacker, an under-construction high-rise that is changing the city's downtown riverfront. Some even tried to become part of the structural system.

AISC also held a scavenger hunt that had participants running around the Loop, engaging with steel icons—e.g., taking a video sliding down the Picasso sculpture in Daley Plaza, getting a team selfie reflected in the Bean, and tracking down the two Chicago projects that won an AISC IDEAS² Award in 2019 (read about all the winners in the May 2019 issue at www.modernsteel.com).

Washington, D.C.

Secret agents, er attendees, enjoyed drinks, hors d'oeuvres, and presentations from project team members at the newly completed steel-framed International Spy Museum. "One of my favorite moments was hearing one of the presenters talk about working through a difficult steel connection detail," said Kristi Sattler, senior engineer with AISC's University Relations department. "He had an image of the model on the screen, and then he was able to point up and say, 'Yup, it's that one right there!' Oh, the beauty of exposed structural steel!"

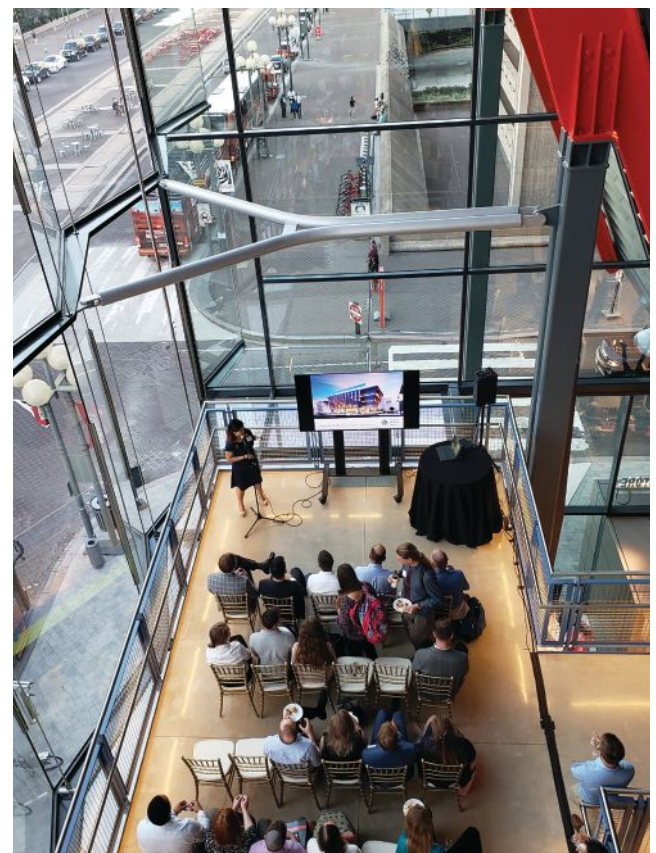

Dripping Springs, Texas

AISC member fabricator Patriot Erectors, located a bit southwest of Austin, has held an event ever since the first SteelDay back in 2009. Back then, with a staff of only eight, the “catering” manifested in the form of employees bringing in homemade fajitas. A decade later, the facility (which was originally a rodeo arena!) now employs more than 120, and the event has grown to more than 450 attendees, including students from multiple area high schools. (Needless to say, they now employ professional catering—still Tex-Mex). The half-day event featured a social hour, a drone-enabled group shot, presentations—including recognizing junior high students who designed safety posters—displays from multiple vendors, lunch, shop tours, and welding and cutting competitions, with contestants’ welding samples proudly displayed, in true Texas fashion, on the tailgate of a pickup truck. Visitors even got to observe a highway bridge, slated to be installed in Houston, fully fit up on the facility’s grounds.

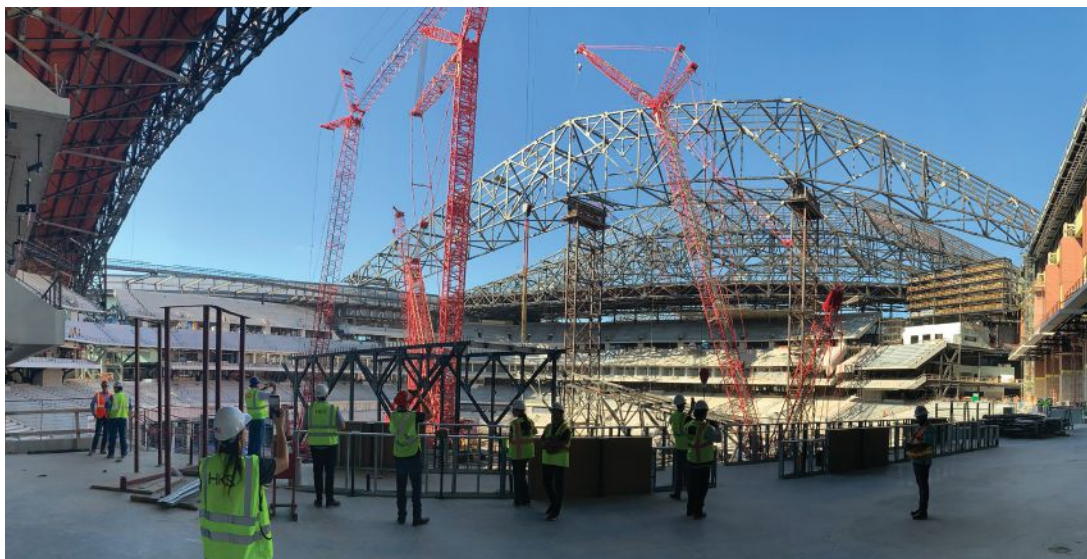

Arlington, Texas

With opening day several months away, several people got the opportunity to see the Texas Rangers’ new Globe Life Field while it was still under construction. The tour was narrated by members of the project’s design and construction teams.

Boston

In Beantown, one SteelDay event focused on an AISC IDEAS² Award winner, the Exchange at 100 Federal Street (featured in the May 2019 issue and also in “Functional Folds” in the January 2018 issue, both available at www.modernsteel.com) while a second event took place at Autodesk’s headquarters, where the company highlighted robotic technology.



New York

One Vanderbilt will add another supertall building to Manhattan’s already formidable skyline. Planned for 1,300 ft (1,400 including the antenna spire) the steel-framed tower just topped out and was the subject of a SteelDay presentation, with AISC’s New York structural steel specialist, Jacinda Collins, introducing presentations from members of the design and construction teams.



Houston

At the “Building a Bright Future With Equity in Mind” event at the Moody Center on the Rice University campus, AISC partnered with AIA Houston and Women in Architecture to celebrate SteelDay. The structural steel industry shares a common goal with the professions of architecture, engineering, and construction: the need to support diversity in leadership roles in the AEC world as well as in our skilled trades. The event brought together professionals in the built environment for an engaging conversation on how to move forward with this common goal, using platforms such as SteelDay to celebrate the strides of those who have worked, either by support or by example, to promote diversity, equity, and inclusion in our respective fields.

Raleigh, N.C.

The mingling at this happy hour event, geared toward the Smoky Hollow Harrington Office Building project, was going so well that the presentation team decided to wait until the end of the event to do the presentation so as to allow the networking to continue uninterrupted. AISC member North State Steel, the project’s fabricator, had several employees on hand who were able to meet AEC professionals who had worked on the project but whom they’d never actually met before. “I have been working for years with many of the people in this room on various projects, but we never met in person until now,” noted Kari Ann Bell, vice president of North State Steel.



Charlotte, N.C.

This joint event with the Structural Engineers Association of Charlotte started with a lunch (tacos again!) presentation led by the entire design and construction team for the Charles R. Jonas Federal Courthouse project, then moved to a guided tour of the site. The building had topped out a week prior to the event, and about half of the structural steel was fireproofed, so there were ample opportunities to see the framing system. Many attendees had never been inside a structure that was designed for blast resistance and progressive collapse, so they were excited to take part. One attendee marveled, “I had no idea steel is so versatile. The SidePlate system used on this project really opens up the space within the building!”

Topeka, Kan.

More than 200 people came from area design and architectural firms, general contractors, and local universities to visit AISC member fabricator HME, Inc.’s shop on SteelDay. Tours were given at the main structural fabrication facility, the miscellaneous metals facility, the machine shop, and the engineered railings/ladders division. One attendee remarked on the facility’s range of spaces and equipment: “It seems like they’re quite capable of handling a whole host of project needs.” ■



news & events

LEGAL MATTERS

Federal Appeals Court Turns to AISC Code of Standard Practice

Most contractors assume that a contract will provide the terms and standards by which the parties can be expected to perform and how their relationship will be governed, even in potentially adversarial situations. But what if those terms or standards are not incorporated or set forth in the contract, or are sufficiently vague or ambiguous so that a clear understanding cannot be determined? What do courts do in that circumstance when litigation results? What sources can they review to resolve the issues? That was the challenge facing the United States Court of Appeal for the 8th Circuit in a recently decided case.

The case—*Advance Conveying Technologies, LLC v. Lemartec Corporation*—involves the construction of a chlor-alkali production plant in Iowa, which required a conveyor system to transport salt into a storage facility and to the production floor. The general contractor, Lemartec, solicited bids for the conveyor-system, and Advance Conveying Technologies, LLC (ACT) won the work. ACT and Lemartec entered into a purchase order with a scope of work that required ACT to comply with “applicable code requirements,” without further explanation. ACT, however, failed to incorporate Lemartec’s bid package into the purchase order, which required the subcontractor to follow the *AISC Code of Standard Practice for Steel Buildings and Bridges* (ANSI/AISC 303, aisc.org/specifications).

A dispute arose on the project after Lemartec directed ACT to immediately deliver components for installation, despite the fact that ACT did not have approved drawings. ACT protested that this directive violated the *Code of Standard Practice* and warned of potential problems. But ACT nevertheless was required to proceed. Not surprisingly, the installation resulted in delays, added costs, and ultimately litigation.

In court, ACT argued that the *Code* governed its work and the submittal procedure. It also argued that because it was directed to proceed without approved drawings, Lemartec had converted the project into a fast-track delivery method

under the *Code*, and therefore Lemartec took responsibility for field rework and related costs. A problem with ACT’s argument, however, was the fact that the purchase order did not mention the *Code*, nor did it incorporate Lemartec’s bid package requiring compliance with the *Code*. Therefore, the court ruled that Lemartec’s bid package was neither part of nor controlled the parties’ agreement.

Fortunately for ACT, the court focused on the phrase “applicable code requirements” as the term appeared in the purchase order. Relying, in part, on expert testimony that the *Code* was the industry standard, the court found in favor of ACT. Though the court did not cite the expert’s exact testimony, it likely relied on the fact that the *Code* constitutes the authoritative reference in the United States for fabricated structural steel work and that it is referenced in various United States building codes. Based on the strength of the expert’s testimony regarding trade usage, the court ruled that “applicable code requirements” referred to the *Code*. From that finding, the court affirmed the trial court’s decision in favor of ACT. Good news for the FSS industry and AISC.

But there are at least two important lessons to be learned from the ACT case. First, a steel fabricator should make sure that all the applicable terms, conditions, and standards are incorporated into the final contract. Fabricators should understand that simply because something may appear in earlier documents, it may not necessarily become a controlling term when the contract is finalized, whether by accident or intention. Second, the fabricator should strive to make sure that the *AISC Code* is incorporated and made a part of your final contract. It provides some of your best protection against arguments that you are responsible for added costs on a poorly planned project. Employing these few best practices may help to avoid the long, drawn-out litigation in which ACT found itself.

—By Edward Seglias, Jason A. Copley,
and Matthew R. Skaroff, all with
Coben Seglias’ Construction Group

People and Schools

- Westside Community Schools in Omaha, Neb., recently unveiled a state-of-the-art welding, fabrication, and manufacturing lab at Westside High School in partnership with the Westside Foundation. The 2,500-sq.-ft facility was funded by donors and the Nebraska Department of Labor. Students will use the space for trades instruction in conjunction with a program of mentorships, apprenticeships, and hands-on experience through partnerships with local companies. “Industries nationwide are in dire need of qualified, talented trades workers,” said Tyler Owen, a 1990 Westside High graduate and CEO of Owen Industries, an AISC member fabricator. “This facility will provide top instruction and opportunity for our future workforce.”
- AISC member fabricator SteelFab’s apprentice program, SteelFab University, is offering high school students paid apprenticeships in a wide range of trades including paint application, machine operation, welding, fitting, and maintenance. Each apprentice is assigned a personal mentor to provide hands-on job training in addition to assistance in becoming independent by offering guidance on matters such as financial planning, setting up a checking account, and securing transportation. Each mentor spends time with their apprentice to provide a big brother/big sister role model to ease the transition into the work force. SteelFab’s goal is to provide 100% job placement for students who successfully complete the SteelFab University program. To see if there’s a SteelFab plant near you, visit steelfab-inc.com/divisions.

IN MEMORIAM

Pat Fortney, Educator and Steel Industry Expert, Dies At 57

Patrick J. “Pat” Fortney, PE, PhD, a prominent contributor to the structural steel industry, passed away on October 12 at 57 from a heart attack.

A longtime construction industry professional, Fortney owned and managed his own company, Fortney Construction, from 1986 to 1998. Most recently, he was a professor in the University of Cincinnati’s College of Engineering and Applied Science.

An enthusiastic and prolific contributor to AISC activities, he was chair of AISC’s Task Committee 2 Editorial Committee, a member and past vice chair of the Committee on Specifications, a member of the Task Committee on Connection Design, and a member of the Committee on Manuals. He wrote several articles for AISC’s *Engineering Journal*—including recent papers on the chevron effect—presented live seminars on AISC’s *Seismic Design Manual* as well as multiple webinars, and was a frequent speaker at NASCC: The Steel Conference. He was also recently involved with research for AISC on coupling beams.

“Pat was a great contributor to our industry,” said AISC’s chief of engineering staff, Thomas Schlafly. “He travelled the country giving design lectures that were professionally presented, and demonstrated a strong understanding of structure behavior, design, and

fabrication. His proposals came with enlightening rationale, and the donation of his time was incredibly generous, initiating research projects that promised to improve economy and provide the knowledge we need.”

“Pat was an inspiration to all of us,” said Lawrence Kruth, PE, AISC’s vice president of engineering and research. “His in-depth knowledge was communicated through his work as a fabricator to help make our specifications better technically as well as meet the needs of the industry. He was a great leader in all of his committee work. He will be missed.”

“Pat was the quintessential workaholic,” recalled William “Bill” Thornton, PE, PhD of Cives Engineering Corporation, where Pat was employed from 2009 to 2016. “He was a great asset for Cives on many jobs. We collaborated on many research ideas in steel and published multiple papers jointly in the seven years we worked together. One of these papers was the basis for a change in the AISC *Specification*, and two others have revolutionized understanding of the analysis and design of chevron bracing connections.”

Pat left Cives to accept a teaching position in his hometown of Cincinnati, at the University of Cincinnati, where he received both a BS and PhD in civil engineering.

“He always told me that he wanted to go back to teaching and research—he

was a faculty member at Clemson and the University of Dayton before joining Cives—and that was what he succeeded in doing,” said Thornton. “His time there was shortened by his untimely passing. He will be sorely missed by all his colleagues, and especially by me as a friend.”

“We lost a friend, a colleague, a teacher, a researcher, a mentor, a musician, and an engineer,” added Gian A. Rassati, PhD, a professor at the University of Cincinnati and colleague of Fortney’s. “His loss will be felt by all with whom he had ever interacted, and even those who never met him—such was the impact of his life.”



IN MEMORIAM

AISC Remembers Jeffrey W. Post

AISC joined the steel industry in fondly remembering Jeffrey W. Post, a leading expert on heat straightening, who died in October.

Post earned an AISC Special Achievement Award in 2001 in recognition of his work on tubular steel and heat straightening.

“Jeff was a special person,” said AISC’s chief of engineering staff, Thomas Schlafly. “His outlook on life and his humor made him a pleasure to work with. Jeff brought a great blend of humanity, ethics, and ‘steel’ to the table every day.”

Schlafly recalled a particularly illuminating excursion with Post. “Jeff took a few AISC staff to the Louisiana bayou to show us what steel can do,” he said. “He showed us 50,000-ton assemblies placed in the Gulf of Mexico,

and the sharing of knowledge was a great awakening. There are different worlds out there. Steel is extraordinary and Jeff showed us facets that we had not seen before.”

“We employed Jeff as a technical consultant to diagnose a particular issue that needed to be concluded in very short time frame,” recalled David DeBlasio of Gayle Manufacturing Company. “He tenaciously tackled the issue and was able to determine the root cause in a short time frame through a series of specialized tests.”

Post was always willing to share his knowledge and gave a fantastic lecture on welding at the 1998 National Steel Construction Conference. (You can read about it in the March 1998 issue at www.modernsteel.com.)



news & events

T.R. HIGGINS AWARD

Bo Dowswell Named 2020 T.R. Higgins Lectureship Award Winner

AISC has awarded its 2020 T.R. Higgins Lectureship Award to Bo Dowswell, PE, PhD, principal at SDS Consulting and ARC International.

Dowswell will present “Gusset Plates: The Evolution of Simplified Design Models” as a keynote speaker during NASCC: The Steel Conference, which will take place April 22–24 in Atlanta. This lecture will provide a brief history of gusset plate design methods before considering current approaches and previewing a new method to predict the compression strength of gusset plates using notional loads.

The \$15,000 T.R. Higgins Lectureship Award recognizes an innovative lecturer or author whose outstanding technical writing constitutes a groundbreaking addition to engineering literature on fabricated structural steel.

“Bo Dowswell’s work on gusset plate design is exceptional,” said AISC’s vice president of engineering and research, Lawrence Kruth, PE. “His research on wrap-around gusset plates is at the forefront of modern engineering. Bo has the unique

ability to evaluate constructability aspects of gusset plates as well as the groundbreaking engineering involved. AISC is proud to recognize Bo and his extraordinary analysis of structural steel connection methods, and I look forward to his keynote at the Steel Conference in April.”

Dowswell started in the steel industry as a detailer in 1985. Since then, he has earned BS, MS, and PhD degrees from Auburn University and the University of Alabama at Birmingham. As a professional engineer, his design practice focuses on steel structures.

Currently, he is principal of SDS Consulting, a design firm, and ARC International, which specializes in research and consulting. Dowswell is also an adjunct professor at the University of Alabama at Birmingham, where his research and teaching are concentrated on steel connection design.

Dowswell provides consulting services for the AISC Steel Solutions Center and is the author of AISC Design Guide 33: *Curved Member Design*. He is a member of several AISC Committees, including the

Committee on Specifications, the Committee on Manuals, the Committee on Research, and the Task Group on Industrial Buildings and Nonbuilding Structures. Dowswell is also a member of the Structural Stability Research Council, where his activities are primarily related to connection element and beam stability.

For more about the T.R. Higgins Award and its past winners, please visit aisc.org/higgins.



STEEL HIGH-RISES

CTBUH Recognizes 50 Most Influential Tall Buildings for Its 50th Anniversary



The Council on Tall Buildings and Urban Habitat (CTBUH) has revealed its list of “The 50 Most Influential Tall Buildings of the Last 50 Years” in conjunction with the Council’s 50th anniversary. The buildings received special recognition at the recent CTBUH 10th World Congress in Chicago, at which AISC hosted a workshop and social event. The list includes several American skyscrapers built with structural steel: Sears Tower (now Willis Tower), One World Trade Center, the John Hancock Center (now 875 North Michigan Avenue, at left) and many more.

CTBUH received nominations from industry professionals across the globe for this iconic list. The history of skyscrapers dates back more than 120 years, with an acceleration in tall building innovations occurring in the late 1960s. The recognized buildings either greatly influenced the design of tall buildings and/or became cultural landmarks. See the full list at ctbuh2019.com.

marketplace & employment

Structural Engineers

Are you looking for a new and exciting opportunity?

We are a niche recruiter that specializes in matching great structural engineers with unique opportunities that will help you utilize your talents and achieve your goals.

- We are structural engineers by background and enjoy helping other structural engineers find their "Dream Jobs."
- We have over 30 years of experience working with structural engineers.
- We will save you time in your job search and provide additional information and help during the process of finding a new job.
- For Current Openings, please visit our website and select Hot Jobs.
- Please call or e-mail Brian Quinn, PE (616.546.9420 or Brian.Quinn@FindYourEngineer.com) so we can learn more about your goals and interests.

All inquiries are kept confidential.

SE Impact by SE Solutions, LLC | www.FindYourEngineer.com

Struggling to create compliant
Welding Procedure Specifications?

Atema can create compliant and user friendly WPSs.

Take a short survey and our
Quality Systems Specialists will create
easy-to-read WPSs with a fast turnaround.

www.atema.com
316.861.3000
info@atema.com



QMC Contract Auditor

Quality Management Company, LLC (QMC) is seeking qualified independent contract auditors to conduct site audits for the American Institute of Steel Construction (AISC) Certified Fabricators and Certified Erector Programs.

This contract requires travel throughout North America and limited International travel. This is not a regionally based contract and a minimum travel of 75% should be expected.

Contract auditors must have knowledge of quality management systems, audit principles and techniques. Knowledge of the structural steel construction industry quality management systems is preferred but not required as is certifications for CWI, CQA or NDT. Prior or current auditing experience or auditing certifications are preferred but not required. Interested contractors should submit a statement of interest and resume to contractor@qmconline.org.

LATE MODEL STRUCTURAL STEEL FABRICATING EQUIPMENT

Controlled Automation DRL-336 CNC Beam Drill, 36" x 18", (3) 15 HP Spindles, Hem WF140 Tandem Saw, 2005 #29344
Ficpep Gemini 324PG CNC Plasma Cutting System, 10' x 40', (1) Oxy, 15 HP Drill, HPR260XD Plasma Bevel Head, 2014 #28489
Peddinghaus FPDB-2500 CNC Heavy Plate Processor, 96" Width, (3) Drill Spindles, HPR260 Plasma, (1) Oxy, Siemens 840, 2008 #27974
Peddinghaus FDB-2500A CNC Plate Drill with Oxy/Plasma Torches, (3) Head Drill, 96" Max. Plate Width, 2003 #29542
Peddinghaus PCD-1100 CNC Beam Drill, 44" x 18" Capacity, 13.5 HP, 900 RPM, (3) Spindles, 3" Max. Diameter, 13" Stroke, 2008 #29286
Peddinghaus Ocean Avenger II 1000/1B CNC Beam Drill, 40" x 40' Max Beam, Siemens 840Di CNC Control, 2006 #29710
Peddinghaus AFCPS 833A Revolution CNC Anglemaster Angle Line, 8" x 8" x 1", Loader, Conveyor, Fagor 8055 CNC, 2011 #29959
Voortman V630/1000 CNC Beam Drill, (3) Drill Heads, Max Length 612", Power Roller Conveyor, 4-Side Layout Marking, 2016 #29726

www.PrestigeEquipment.com | (631) 249-5566
sales@prestigeequipment.com

Search employment ads online at www.modernsteel.com. To advertise, contact M.J. Mrvica Associates, Inc.: 856.768.9360 | mjmrvica@mrvica.com

advertiser index

AISC	8	PythonX, A Lincoln Electric Company	13
Applied Bolting Technology	29	MDX Software	45
Automated Layout Technology	55	Nucor Vulcraft-Verco Group – Redicor	25
Bull Moose Industries	back cover	Peddinghaus Corporation	2
Chicago Metal Rolled Products	insert	Profile Cutting Systems	45
Controlled Automation	50	QuickFrames USA	55
Deicon, Inc	21	SDS/2	7
DuraFuse Frames	12	SidePlate Systems	14
Fabreeka	47	St. Louis Screw & Bolt	24
FICEP Corporation	15	Trimble	3 51
IES	11	Voortman Corporation	23
Infra-Metals	67	V&S Galvanizing LLC	5

structurally sound



A BETTER VIEW

GO TO WWW.MODERNSTEEL.COM. RIGHT NOW.

Notice anything different? Yes, we've redesigned our website!

While we enjoyed the visual style of our previous site design, a common complaint was that it was unclear how to access various types of content. We hope our new design is much easier to navigate. (It has also been optimized for mobile viewing, so be sure to check it out on your phone.)

In addition to being laid out in a more user-friendly and intuitive manner, we've also added some new features. One is our weekly

quiz, which you can participate in for a chance at a monthly prize. Another is our Project Extra section, which will provide web-only content connected to various *Modern Steel* articles. And of course, we still provide all of the content from our previous site, including our Archives section (which provides three different ways to access content from the print magazine), our regular Steel in the News section, Steel Interchange questions, and more.

Other new features are forthcoming, so be sure to check out the new site on a regular basis. ■

Seasons Greetings

INFRA-METALS
www.infra-metals.com

DELTA STEEL, INC.
www.deltasteel.com

Consider us your partner,
not just another supplier.

250,000 Tons of Structural Inventory
Comprehensive First-Stage Processing
Industry Leading Customer Service



With many locations to serve you:

Wallingford, CT
Langhorne, PA
Baltimore, MD
Petersburg, VA
Atlanta, GA
Tampa, FL
Hallandale, FL
Marseilles, IL
New Boston, OH

Houston, TX
San Antonio, TX
Cedar Hill, TX
Fort Worth, TX
Chicago Heights, IL



Full Member

HOLLOW STRUCTURAL STEEL TUBE FROM BULL MOOSE

**BUILD A
LANDMARK.**



For projects that will stand the test of time, start with Bull Moose HSS tube.

Our direct-form manufacturing process enables us to use the highest grade HSLA steel...and form it directly into a tube.

With sizes ranging from 1.5" square to 18"x6", and wall thicknesses from 1/8" through 5/8", Bull Moose features one of the largest size ranges of HSS products in the industry.

For strength, versatility and reliability, build with Bull Moose.

BULL MOOSE ADVANTAGES

- Strength ranges of 46 KSI to 110 KSI
- Tighter tolerances, sharper edges, and straighter tubes
- Widest variety of custom sizes/lengths, including metric
- In-line NDT weld testing available on all tube
- Readily available weathering grade steel
- Fast delivery with 8 domestic sites



BULL MOOSE
For exceptional strength.

1819 Clarkson Rd.
Chesterfield, MO 63017

800.325.4467 | **BULLMOOSETUBE.COM**