

Modern Steel Construction

July 2019

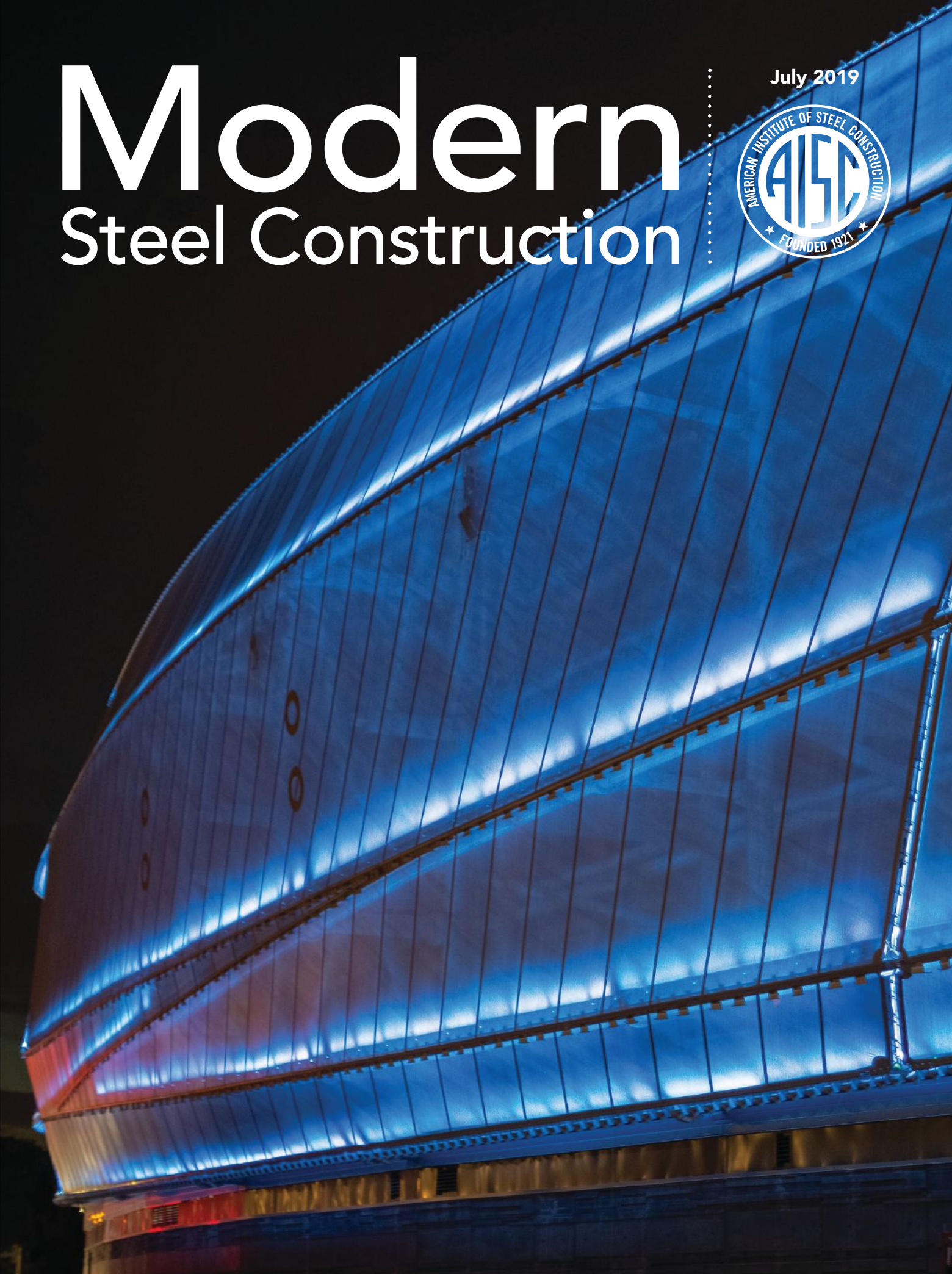

STRONGER THAN STEEL

HIGH SPEED ROBOTIC STEEL BEAM ASSEMBLY

ACCOMPLISHES WORK OF 5 FITTERS PER SHIFT

MAINTAINS 1/32" ACCURACY OVER 60' PROFILES

FIT AND TACK PIECES AT 1.5 MINUTES PER PART

WATCH
VIDEOS
HERE

www.peddinghaus.com/videos

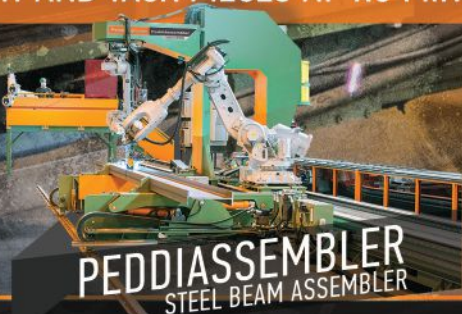

PEDDIASSEMBLER
STEEL BEAM ASSEMBLER

Peddinghaus

www.peddinghaus.com | info@peddinghaus.com | (815) 937-3800

WIN A BEAM ROTATOR
TEXT KEYWORD 'WINNER' TO 69922

Prizes: PeddiRotator, \$500 gift card, or \$100 gift card. Three (3) winners will be selected per year. Eligibility limited to United States/Canada steel industry.

3 Msgs/Month. Reply STOP to cancel, HELP for help. Msg&data rates may apply.

Terms: <https://www.peddinghaus.com/terms/1>





“Quick to learn!”

Structural Software

Easy. Versatile. Productive.

Solve your next project with: www.iesweb.com

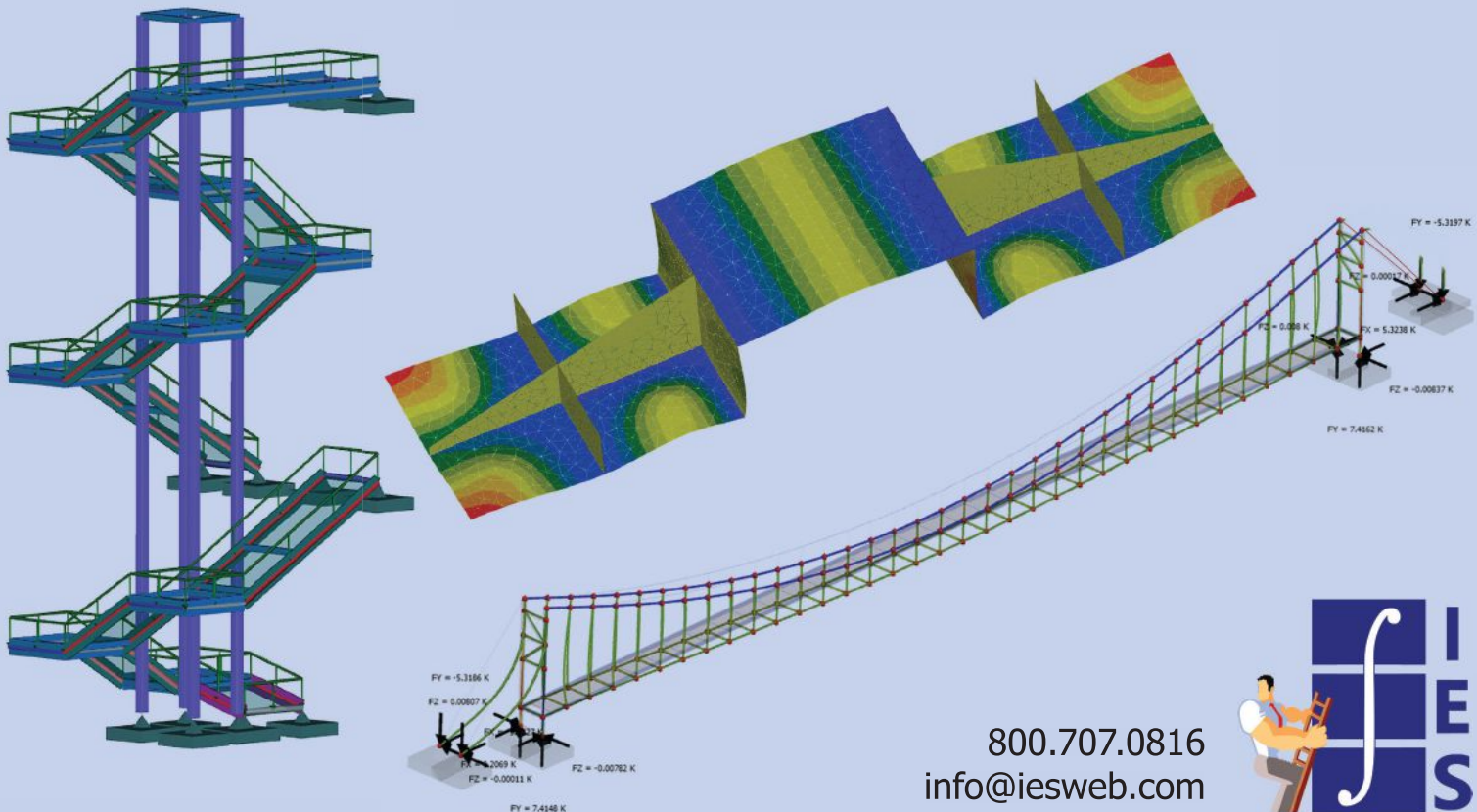

800.707.0816
info@iesweb.com



Modern Steel Construction

July 2019



in every issue

departments

- 6 EDITOR'S NOTE
- 9 STEEL INTERCHANGE
- 12 STEEL QUIZ
- 62 NEWS & EVENTS
- 66 STRUCTURALLY SOUND

resources

- 64 ADVERTISER INDEX
- 65 MARKETPLACE & EMPLOYMENT

© Christopher Ambridge

48

columns

steelwise

16 Opposites Attract

BY CHRISTOPHER HEWITT, SE, PE, P.ENG,
ALAN HUMPHREYS, PE, PH.D, AND ERIC
TWOMEY, SE, PE

A primer on galvanic corrosion of
dissimilar metals.

business issues

20 True Teamwork

BY DAN COUGHLIN
Tips on building teamwork that
actually work.

features

22 Soccer Star

BY JUSTIN BARTON, SE, PE

Minnesota United's stunning, sophisticated new soccer stadium is encapsulated by a complex web of steel wrapped in a first-of-its-kind translucent, tear-resistant skin.

30 Healthy Example

BY JEFF KOKE, PE, THOMAS TAYLOR, PE, AND
DAVE THOMAS, SE, PE

Exposed steel inside and out elevates a new Colorado hospital's identity and helps solidify its role as a prototype for future facilities of its kind.

36 Game Changer

BY GARRET BROWNE, SE, PE, AND RYAN KOEHN

A Chicago fitness club becomes a sporty new athletic resort when a steel-framed expansion walks onto the court mid-design.

42 Common Ground

BY LARRY BAKER, PE, AND BRAD KIRKHAM, PE

Penn State's new steel-framed Chemical and Biomedical Engineering Building provides an education on vibration, collaboration, and structural system optimization.

48 Jazzing It Up

BY CHRIS AMBRIDGE, AIA, AND BILL YUN, PE

A steel-framed, egg-shaped theater serves as the beating heart of an updated arts-based high school in D.C.

54 A Studio Grows in Brooklyn

BY MARCO SHMERYKOWSKY, PE

A century-old service station becomes a steel-framed TV studio thanks in part to a creative column configuration and a fresh façade.

58 An Accurate Declaration

BY LUKE JOHNSON, SE, PE

For steel projects with green goals, environmental product declarations provide a third party-verified breakdown of various steel products' impacts on the earth.

ON THE COVER: Allianz Field in the Twin Cities elevates and illuminates the Major League Soccer experience, p. 22. (Photo: Nathan Klok)

MODERN STEEL CONSTRUCTION (Volume 59, Number 8) ISSN (print) 0026-8445; ISSN (online) 1945-0737. Published monthly by the American Institute of Steel Construction (AISC), 130 E Randolph Street, Suite 2000, Chicago, IL 60601. Subscriptions: Within the U.S.—single issues \$6.00; 1 year, \$44. Outside the U.S. (Canada and Mexico)—single issues \$9.00; 1 year \$88. Periodicals postage paid at Chicago, IL and at additional mailing offices. Postmaster: Please send address changes to MODERN STEEL CONSTRUCTION, 130 E Randolph Street, Suite 2000, Chicago, IL 60601.

DISCLAIMER: AISC does not approve, disapprove, or guarantee the validity or accuracy of any data, claim, or opinion appearing under a byline or obtained or quoted from an acknowledged source. Opinions are those of the writers and AISC is not responsible for any statement made or opinions expressed in MODERN STEEL CONSTRUCTION. All rights reserved. Materials may not be reproduced without written permission, except for noncommercial educational purposes where fewer than 25 photocopies are being reproduced. The AISC and Modern Steel logos are registered trademarks of AISC.



Printed on paper made
from a minimum of
10% recycled content.



The Best in Steel MIS Just Got Better

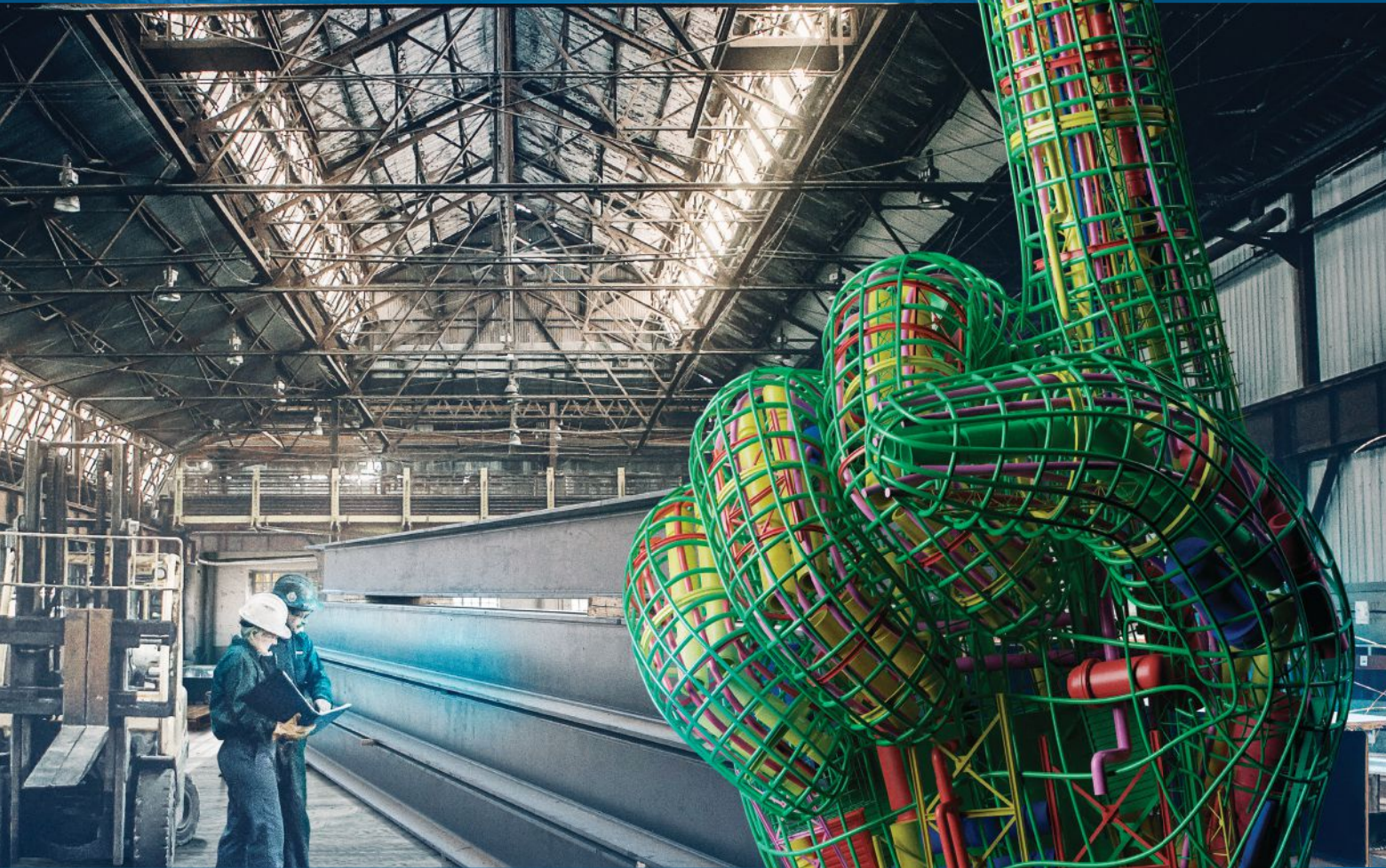

The Power of FabSuite Plus a Whole Lot More

The industry's next generation of steel fabrication management software is here. Tekla PowerFab is a software suite that combines the power of FabSuite with other Tekla solutions to deliver next-level performance in estimating accuracy and project collaboration.

Learn more at: www.TeklaPowerFab.com



IS NOW



editor's note



At dinner last night, a conversation broke out about recycling, waste, and what the world will be like in 20 years. My middle child has always been deeply concerned about environmental issues, so this wasn't an unusual discussion.

But it did make me think about an article I had just read in *Vice* about Apple's AirPods (<https://bit.ly/2ZYMPUd>). The article is incredibly harsh in its evaluation of this conspicuous symbol of consumer consumption. According to *Vice*, AirPods are only designed to fully maintain their usability for about 18 months. After that time, the battery begins to degrade and performance suffers. "They can't be repaired because they're glued together. They can't be thrown out, or else the lithium-ion battery may start a fire in the garbage compactor. They can't be easily recycled, because there's no safe way to separate the lithium-ion battery from the plastic shell." The article goes on to point out that even if the AirPods make it to a landfill, they take at least a millennia to decompose.

Of course, AirPods aren't alone in planned obsolescence. Almost all electronics, and even major appliances, are rarely repaired nowadays. Instead, we have come to accept a limited life span for our gadgets and appliances, usually measured in years, rarely in decades.

Even the built environment has a planned life span. The question we need to ask is, what is an acceptable life span for a building or bridge and what impact will its disposal have on future generations?

Fortunately for me, I can look my son in the eye and tell him that I work for the steel industry and assure him that we're part of the solution, not the problem.

I can talk with him about steel's resilience and how steel structures are designed for a long life in any environment and to withstand whatever nature or humans throw at them. I can point at steel's documented performance. I can tell him how we're the only modern material with a track record of 100-year-old bridges and buildings (and even show him *Modern Steel's* series of articles on centurion bridges at www.aisc.org/100yearbridge).

I can assure him that when a steel structure does reach obsolescence, the steel doesn't go into a landfill (like concrete) and isn't incinerated (like wood) but is instead recycled into new steel beams and columns.

I can assure him the use of scrap is a prime factor in keeping the cost of steel material low, that as America turns increasingly to renewable energy steel becomes even more earth-friendly, and that the steel industry even recycles the water used in the steelmaking process.

AISC's tagline touts "Smarter. Stronger. Steel." But if you're looking for more adjectives, I'd recommend adding sustainable and resilient. What are your favorite words to describe steel? Join the conversation and let me know!

Scott Melnick
Editor

Modern Steel Construction

Editorial Offices

130 E Randolph St, Ste 2000
Chicago, IL 60601
312.670.2400

Editorial Contacts

EDITOR AND PUBLISHER

Scott Melnick
312.670.8314
melnick@aisc.org

SENIOR EDITOR

Geoff Weisenberger
312.670.8316
weisenberger@aisc.org

DIRECTOR OF PUBLICATIONS

Keith A. Grubb, SE, PE
312.670.8318
grubb@aisc.org

PRODUCTION COORDINATOR

Erika Salisbury
312.670.5427
salisbury@aisc.org

GRAPHIC DESIGN MANAGER

Kristin Hall
312.670.8313
hall@aisc.org

AISC Officers

CHAIR

David Zalesne,
Owen Steel Company, Inc.

VICE CHAIR

Jack Klump, Cianbro Fabrication
& Coating Corporation

SECRETARY/LEGAL COUNSEL

Edward Seglias, Cohen Seglias
Pallas Greenhall & Furman, PC

PRESIDENT

Charles J. Carter, SE, PE, PhD

SENIOR VICE PRESIDENT

Scott Melnick

VICE PRESIDENT

Lawrence F. Kruth, PE

VICE PRESIDENT

Tabitha S. Stine, SE, PE

VICE PRESIDENT

Mark W. Trimble, PE

Editorial Advisory Panel

Caroline R. Bennett, PE, PhD,
University of Kansas

Amanda Dean, PE,
Huitt-Zollars, Inc.

Bryan Frazier,
Zalk Josephs Fabricators, LLC

Keith R. Griesing, PE,
Hardesty and Hanover

Steve Knitter,
Geiger and Peters

Advertising Contact

ACCOUNT MANAGER

Renae Gurthet
231.995.0637
renae@gurthetmedia.com

Address Changes and Subscription Concerns

312.670.2401
subscriptions@aisc.org

Reprints

Erika Salisbury
312.670.5427
salisbury@aisc.org

INTELLIGENT AUTOMATION EQUALS PRODUCTIVITY

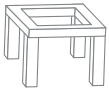

Recognizes and Automatically **ADAPTS TO FRAMING CONDITIONS**

SDS/2 takes a uniquely intelligent approach to its connection design by considering framing conditions and erectability.

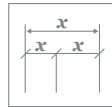

Reduces Detailing Time **WITH CUSTOM TEMPLATES**

SDS/2 allows detailing drawings to be customized to your detailing and fabrication standards, reducing time spent on cleanup.



Creates Multi-User Environment **TO STREAMLINE WORKFLOW**

With SDS/2, everyone works in the live model simultaneously; there's no need to check the model in or out.

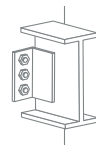

Conducts Code-Based **JOINT ANALYSIS**

Only SDS/2 automatically performs clash detection and prevention as part of its connection design, which leads to savings in the shop.



Integrates to the **SHOP, FIELD AND OFFICE**

SDS/2's intelligence allows for seamless transfer of information from start to finish.



ENSURES FIT-UP in Field

With SDS/2, if it fits in the model, it fits in the field.

See how SDS/2 can increase your bottom line at
[SDS2.COM/PRODUCTIVITY](https://www.sds2.com/productivity)



www.sds2.com
800-443-0782 // 402-441-4045 (fax)
1501 Old Cheney Rd., Lincoln, NE 68512



CALLING ALL INNOVATORS!

If you have recently worked on a structural steel bridge that embodies the pioneering spirit of modern bridge-building, we want to hear about it. Submit it for a 2020 Prize Bridge award!

entries close
on SteelDay
Sept. 27, 2019

enter now at
www.aisc.org/prizebridge



2020
**PRIZE BRIDGE
AWARDS**

Recognizing the innovative use of structural steel in the bridges that connect America's communities.

www.aisc.org/prizebridge

2018 Prize Bridge
National Award
Sellwood Bridge
Portland, Ore.
Photo: Tom Paiva

If you've ever asked yourself "Why?" about something related to structural steel design or construction, *Modern Steel's* monthly Steel Interchange is for you! Send your questions or comments to solutions@aisc.org.

steel interchange

All AISC Design Guides mentioned can be found at www.aisc.org/dg, and all Engineering Journal papers can be found at www.aisc.org/ej. All other AISC publications, unless noted otherwise, refer to the current version and are available at www.aisc.org/specifications.

Stress Dispersion Angles for Loads Passing Through Plate Elements

I have seen various load distributions (e.g., 1:1 and 2.5:1) used for loads applied transverse to cap plates, base plates, and beam or column flanges. Is there a resource that provides additional guidance on this topic? Additionally, do I also have to check the bending of the plate elements when using this approach?

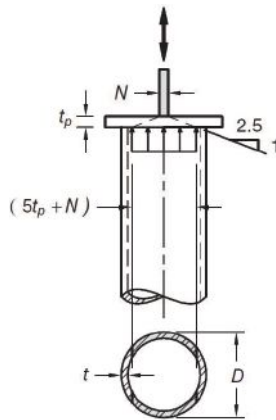

Recommended load dispersion through a cap-plate-to-round-HSS connection (see AISC's Design Guide 24: *Hollow Structural Section Connections*).

What you have described is typically referred to as an effective width method. Connections can be designed either by using an effective width method or by considering the bending strength of the plate or flange. You would not need to use both methods. In practice, the effective width method is often used due to its simplicity. The primary challenge with this method is selecting an appropriate stress trajectory angle (dispersion angle). The dispersion angle can be affected by the geometry, constraint, and inelastic deformation capacity of the connection. The first quarter 2013 AISC *Engineering Journal* paper "Calculation of Stress Trajectories Using Fracture Mechanics" discusses the effect these variables have on the stress trajectory angle, provides practical design guidelines, and includes a summary of current design recommendations for various conditions such as gusset plates, local web yielding, and stresses from wheel loads on crane girders. For more information on HSS connections, see AISC Design Guide 24: *Hollow Structural Section Connections*.

Bo Dowsell, PE, PhD

Torsional Properties

I noticed that the torsional properties included in the AISC Shapes Database v15.0 are different than some of the values provided in Appendix A of Design Guide 9: *Torsional Analysis of Structural Steel Members*. Can you explain why these differences occur?

Design Guide 9 was first published in 1997, and the shape property information provided in the design guide is representative of

shapes produced during that time. With the development of each new AISC *Steel Construction Manual*, a survey is sent out to all AISC member producers and the responses are used to update the section property information provided in the tables of Part 1 of *Manual* and also in the AISC Shapes Database, which you can download at www.aisc.org/shapesdatabase. Thus, the property information provided in this database represents the most up-to-date information based on current steel rolling practices.

Jonathan Tuvarez, PE

AESS and Meeting Expectations

Are there different categories of architecturally exposed structural steel (AESS)? How can I be sure that the quality of the final product will meet my expectations?

There are different categories of AESS, and the process of specifying AESS has become much more formalized in the last few years. Section 10 of the AISC *Code of Standard Practice for Steel Buildings and Bridges* (ANSI/AISC 303) provides requirements on AESS, including the five different categories: 1 through 4 and a custom category.

AESS 1 is defined as "basic elements." The Commentary provides a further description and indicates that AESS 1 elements "have workmanship requirements that exceed what would be done in non-AESS construction."

AESS 2 is defined as "feature elements viewed at a distance greater than 20 ft (6 m)." The Commentary provides a further description and indicates that AESS 2 "is achieved primarily through geometry without finish work, and treats things that can be seen at a larger viewing distance, like enhanced treatment of bolts, welds, connection, and fabrication details, and tolerances for gaps, copes and similar details."

The above can be contrasted with the work described for AESS categories 3 and 4: "AESS 3 is achieved through geometry and basic finish work, and treats things that can be seen at a closer viewing distance or are subject to touch by the viewer, with welds that are generally smooth but visible..." And AESS 4 (showcase elements) are "those for which the designer intends that the form is the only feature showing in an element. All welds are ground and filled, edges are ground square and true. All surfaces are filled and sanded to a smoothness that doesn't catch on a cloth or glove. Tolerances of fabricated forms are more stringent—generally half of standard tolerance."

It must be recognized that by its very nature, AESS involves some subjectivity. One problem we sometimes see is that the owner may have very high expectations but doesn't adequately convey them in the contract. In an effort to prevent misunderstandings when a high level of finish is required, the *Code* requires a mock-up be produced, reviewed, and approved to get all parties on the same page. Section 10.1.2 states: "A mock-up shall be required for AESS 3, 4, and C. If a mock-up is to be used in other

steel interchange



Carlo Lini (lini@aisc.org) is AISC's director of technical assistance.

Jonathan Tavarez (tavarez@aisc.org) is a staff engineer with AISC's Steel Solutions Center. **Bo Dowswell**, principal with ARC International, LLC, and **Larry Muir** are both consultants to AISC.



STEEL SOLUTIONS CENTER

Steel Interchange is a forum to exchange useful and practical professional ideas and information on all phases of steel building and bridge construction. Contact Steel Interchange with questions or responses via AISC's Steel Solutions Center: 866.ASK.AISC | solutions@aisc.org

The complete collection of Steel Interchange questions and answers is available online at www.modernsteel.com.

The opinions expressed in Steel Interchange do not necessarily represent an official position of the American Institute of Steel Construction and have not been reviewed. It is recognized that the design of structures is within the scope and expertise of a competent licensed structural engineer, architect or other licensed professional for the application of principles to a particular structure.

AESS categories, it shall be specified in the contract documents. When required, the nature and extent of the mock-up shall be specified in the contract documents. Alternatively, when a mock-up is not practical, the first piece of an element or connection can be used to determine acceptability.”

It is certainly possible (and not particularly uncommon) for there to be different expectations regarding AESS. The mock-up process helps the various parties resolve these differences and manage everyone's expectations. For example, in the mock-up process, the fabricator may perceive the expectations of the owner or the owner's representative to be disproportionate with the work conveyed in the contract documents. In such cases, the fabricator may request an adjustment in cost and/or schedule. However, because the mock-up process has been adhered to, this can be worked out early in the project when the impact can be better managed and issues more easily ironed out.

Bottom line, if the owner has high expectations and you have concerns about your ability to adequately convey AESS requirements in the project specification, a mock-up is a good idea. For more information on AESS, visit www.aisc.org/aess.

Larry S. Muir, PE

Repair of Mill-Induced Discontinuities

A fabricator has received a beam with surface imperfections on the web that the owner is objecting to. Are there repair procedures for addressing such imperfections?

Yes. The fabricator has the option to perform corrective procedures to recondition the surface of the beam, as indicated in the *Code*. Section 5.1.3 states: “When variations that exceed ASTM A6/A6M tolerances are discovered or occur after the receipt of mill material the fabricator shall, at the fabricator's option, be permitted to perform the ASTM A6/A6M corrective procedures for mill reconditioning of the surface of structural steel shapes and plates.”

Section 9.1 of ASTM A6 states: “The conditioning requirements in 9.2, 9.3, and 9.4 limits the conditioning allowed to be performed by the manufacturer or processor. Conditioning of imperfections beyond the limits of 9.2, 9.3, and 9.4 may be performed by parties other than the manufacturer or processor at the discretion of the purchaser.” Section 9.3 of ASTM A6 addresses structural shapes and provides options involving simply grinding out the imperfection within the provided depth limits, as long as the ground area is well faired and without abrupt changes in contour. For removal of imperfections at depths that exceed the limits of Section 9.3, a repair weld is needed and requirements are provided in Section 9.5.

Section 15.1.2 and 15.1.3 of the second edition of AISC Design Guide 21: *Welded Connections—A Primer for Engineers* addresses repair of mill-induced discontinuities and repair of damaged steel. Section 15.1.2 summarizes the information provided in ASTM A6. Section 15.1.3 provides additional guidance on repair that may be helpful, stating: “There is no established or codified limit as to how much repair welding can be performed by a contractor on a given member; practical issues of economics and schedule generally determine how much repair welding is too much. Properly made, weld metal repairs have mechanical properties similar to structural steels provide a similar level of structural performance for statically loaded structures.” There may be additional considerations for cyclically loaded structures or structures subject to inelastic deformations in service (seismic or blast loading, for example).

It should be noted that not all such imperfections need to be repaired. ASTM A6 states: “Unless otherwise specified, structural products are normally furnished in the as-rolled condition and are subjected to visual inspection by the manufacturer or processor. Non-injurious surface or internal imperfections, or both, may be present in the structural product as delivered and the structural product may require conditioning by the purchaser to improve its appearance or in preparation for welding, coating, or other further operations.” It also sets criteria based solely on the defects not being “injurious” and the product having “a workmanlike finish.”

Carlo Lini, PE

Introducing

DURAFUSE
FRAMES



- ◆ Resiliency
- ◆ Efficiency
- ◆ Simplicity

Innovative Moment Frames



Innovation Highlights

- ◆ No Beam or Column Damage Under Severe Earthquake Loading
- ◆ Faster Repair Following a Severe Earthquake
- ◆ Less Steel + Less Fabrication Labor = Up Front Cost Savings
- ◆ No Field Welding + Fewer Parts = Fast Erection

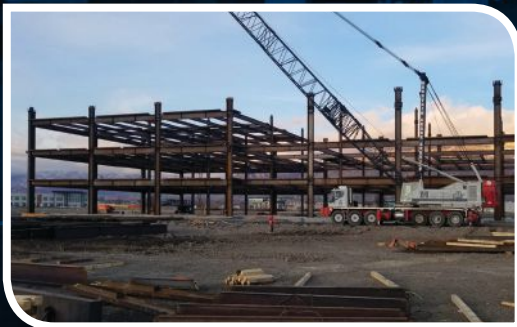

Easy to Design

- ◆ Stiffness Checks Performed in RAM or ETABS
- ◆ Complimentary Design Assistance
- ◆ Connection Design, Detail Sheets, and Connection Schedules Provided

DURA FUSE
FRAMES

durafuseframes.com
contact@durafuseframes.com
801.727.4060

steel quiz

This month's Steel Quiz focuses on sustainability, resilience, and integrity. The answers can be found in the AISC 2016 *Specification for Structural Steel Buildings* (ANSI/AISC 360, www.aisc.org/specifications) and its Commentary, as well as in the many resources available at www.aisc.org/sustainability.

- 1 When designing for structural integrity, providing minimum nominal tensile strength for connections and splices improves the structure's _____ and _____. (Hint: Rearrange the scrambled letters below to spell the words.)
First word: ityotunnic
Second word: lytidtuic
- 2 **True or False:** The goal of structural integrity requirements in Section B3.9 of the *Specification* is to provide additional strength for members to resist the loads caused by extreme events such as an earthquake.
- 3 Which of the following is not true of the requirements for structural integrity in the *Specification*?
 - a. Structural integrity is evaluated independently from other required strengths.
 - b. The use of bearing bolts in connections with short-slotted holes parallel to the direction of tension force is prohibited.
 - c. The required minimum nominal tensile strength for a column splice is to be equal to the total gravity load for the area tributary between the column splice and the splice or base immediately below.
 - d. The provisions on structural integrity should be considered where required by the applicable building code.
- 4 In order to meet the requirements of MRc5 (Material and Resources Credit 5) in the LEED 2009 rating system, all building materials or products should be extracted, harvested, or recovered, as well as manufactured, within a ___-mile radius of the project site.
- 5 AISC has developed industry average environmental product declarations (EPDs) for hot-rolled structural sections, steel plate, and HSS (the latter was developed in conjunction with the Steel Tube Institute). **True or False:** These EPDs can only be submitted for credit for a project fabricated by a company that was an AISC full member at the time of the project's development or that has subsequently joined AISC and submitted environmental impact data relative to its shop.
- 6 What are the six environmental impact categories of a whole-building life-cycle assessment, as defined in LEED v4?
- 7 The 2015 *International Building Code* assigns structural integrity requirements to high-rise buildings in which risk categories?



**WE CAN HELP YOU
HELP YOUR
CUSTOMERS
IMPROVE
PRODUCTIVITY.**

QUICKFRAMES

QuickFrames.us 480-464-1500

Specify QuickFrames, and your customers win.

TURN TO PAGE 14 FOR THE ANSWERS

The questions and answers were contributed by Yishan He, a masters student at Northwestern University and an intern at AISC. Thank you, Yishan!

AISC

Night School

Classical Methods of Structural Analysis

presented by Louis F. Geschwindner, PE, PhD

Monday nights 7:00 p.m. Eastern Time
90 minutes each

Upcoming Sessions:

- 7/8 Moment Areas and Elastic Weights
- 7/15 Indeterminate Structures and the General Method
- 7/22 Indeterminate Structures by Slope Deflection
- 7/29 Approximate Methods and Moment Distribution
- 8/5 Classical Approaches Applied to Second-order Analysis



Smarter. Stronger. Steel.

American Institute of Steel Construction
312.670.2400 | www.aisc.org

www.aisc.org/nightschool

steel quiz ANSWERS

- 1 Continuity and ductility.** Improving the continuity and ductility of a structure reduces the chance of its failure when subjected to unanticipated tension loads caused by extraordinary events such as failure of an adjacent structural member, impact loads on columns, etc.
- 2 False.** In an extreme event, the damage is usually caused by abnormal loading events that are not considered in routine design. As a result, the goal of a structural integrity assessment is to provide an alternative load path to redistribute loads in the event of damage to or the loss of the primary load-bearing component, thus reducing the probability for disproportionate collapse. Additional information can be found in the *Specification* Commentary,

- as well as in the September 2017 article "Structural Integrity—and Reorganization" (available at www.modernsteel.com).
- 3 b.** This requirement is prescribed in Section B3.9 of the *Specification*. The use of bearing bolts in connections with short-slotted holes parallel to the direction of tension force is *permitted*.
- 4 500.** MRc5 Option 1 states: "All building materials or products have been extracted, harvested or recovered, as well as manufactured, within a 500-mile (800-kilometer) radius of the project site." (Note that this requirement refers to materials that were transported via roads. If the materials or products were shipped by rail or water to the project site, an alternative weighted average method to determine distance is also provided.)

- 5 True.** You can find more information, including a list of fabricators permitted to submit this EPD, at www.aisc.org/epd.
- 6** The six impact categories in LEED v4 are listed as follows:
1. Global warming potential (greenhouse gases), measured in kg CO₂e
 2. Depletion of the stratospheric ozone layer, measured in kg CFC-11
 3. Acidification of land and water sources, measured in moles H⁺ or kg SO₂
 4. Eutrophication [Editor's note: Think algae blooms.], measured in kg nitrogen or kg phosphate
 5. Formation of tropospheric ozone, measured in kg NO_x, kg O₃ eq, or kg ethene
 6. Depletion of nonrenewable energy resources, measured in MJ

Further information can be found on the "Whole building life cycle assessment through LEED v4" page at www.gbci.org.

- 7** The *IBC* assigns structural integrity requirements to high-rise buildings in risk categories III or IV, meaning that the number of buildings to which this requirement currently applies is limited.

HEXP[®]ORT[®]

Save valuable time and money. Never search for bolting documents ever again!

Test Reports
Invoices
Packing Lists
DOT Approvals
Order Tracking
Proof of Delivery

Call or Go Online to find out more
St. Louis Screw & Bolt
stlouisscrewbolt.com
800-237-7059

Structural Bolting Experts



Everyone is welcome to submit questions and answers for the Steel Quiz. If you are interested in submitting one question or an entire quiz, contact AISC's Steel Solutions Center at 866.ASK.AISC or solutions@aisc.org.



2020
IDEAS²
AWARDS

Innovative Design in Engineering and
Architecture with Structural Steel

.....
www.aisc.org/ideas2

CALLING ALL INNOVATORS!

If you recently worked on a project
that featured structural steel, we
want to hear from you. Submit it
for a 2020 IDEAS² award!

.....
entries close on SteelDay
September 27, 2019
.....

enter now at
www.aisc.org/ideas2

2019 IDEAS²
National Award
Waffle
Culver City,
Calif.
Photo: Tom
Bonner

steelwise OPPOSITES ATTRACT

BY CHRISTOPHER HEWITT, SE, PE,
PENG, ALAN HUMPHREYS, PE, PhD
AND ERIC TWOMEY, SE, PE



Christopher Hewitt (cmhewitt@sgh.com) is a senior project manager, **Alan Humphreys** (aohumphreys@sgh.com) is a senior metallurgist, and **Eric Twomey** (ejtwwomey@sgh.com) is a senior structural engineer, all with Simpson Gumpertz and Heger (SGH).

A primer on galvanic corrosion of dissimilar metals.

ENGINEERS AND ARCHITECTS often encounter conditions where dissimilar metals are in contact.

When these situations arise, it is appropriate to consider the corrosion susceptibility of the materials. Although the term corrosion can be broadly applied to any degradation of a metal and can have a variety of causes, this article will discuss the main drivers of galvanic corrosion, which occurs between two dissimilar metals, and offer some strategies to help engineers assess and mitigate its effect in structural applications.

What is Galvanic Corrosion?

Galvanic corrosion typically occurs when dissimilar metals are in electrical contact with each other in wet or humid conditions. It is caused by an electrochemical reaction between the two metals where the transfer of electrons from one metal to the other causes one metal to be oxidized (corroded) at the expense of the other. The reaction occurs when the materials have been connected in a galvanic cell, which is made up of four essential elements (see Figure 1 for an illustration of the relationship between these elements):

1. An **electrolyte** is a conductive liquid or gel that allows the transfer of electrons between the two metals—e.g., water.
2. An **anode** is the negative terminal of a galvanic cell, from which electrons are transferred, resulting in oxidation and section loss of the metal. The anodic metal has the greater negative electrical potential of the two metals in contact.
3. A **cathode** is the positive terminal of a galvanic cell, to which electrons are transferred. No degradation occurs at the cathode. The cathodic metal has the lesser negative electrical potential compared to the anode.
4. An **electrical connection between the anode and cathode** that allows the electrochemical reaction to occur. In immersed conditions, the electrolyte may produce the electrical connection.

If an electrolyte is not present or if the metal ions don't have a mechanism that will allow them to transfer between the materials (i.e., the metals are not in contact) then galvanic corrosion cannot occur. Surface wetting, which can act as an electrolyte, typically occurs when the relative humidity of the environment is greater than 80%. In a marine environment where chloride contamination of a surface has occurred, surface wetting can occur with a relative humidity as low as 30%, which in practice results in the permanent presence of an electrolyte on the surface of a structure. In addition, the rate of galvanic corrosion increases with the conductivity of the electrolyte, so rapid galvanic corrosion can occur in marine environments.

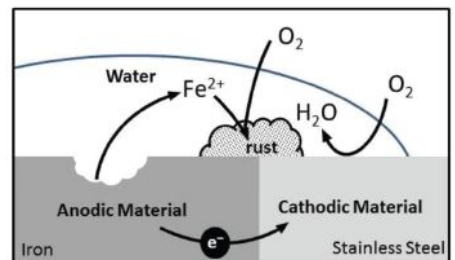
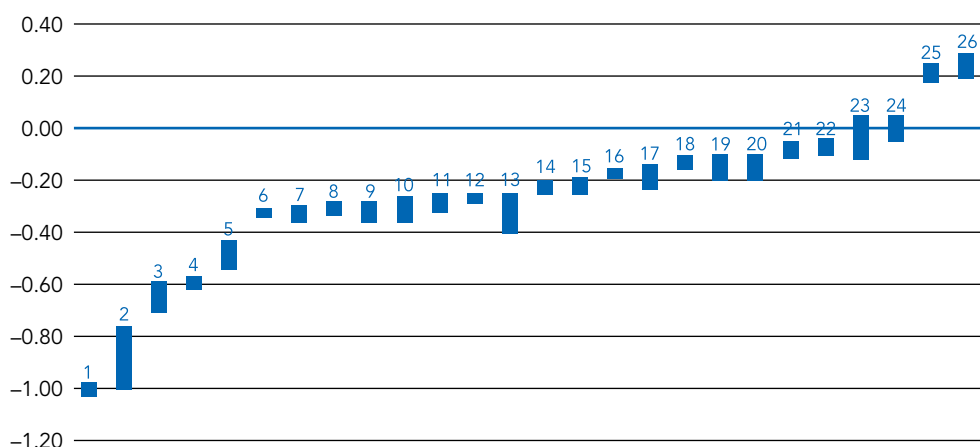

Fig. 1. An example of a galvanic cell.



1. Zinc
2. Aluminum alloys
3. Low-carbon steel, cast iron
4. Low-alloy steel
5. Austenitic nickel cast iron
6. Tin
7. Copper
8. Manganese bronze
9. 50Sn-50Pb solder
10. Stainless steel (AISI types 410, 416) - passive
11. Tin bronze
12. Silicon bronze
13. Brass
14. Stainless steel (AISI types 430) - passive
15. Lead
16. Inconel 600 - passive
17. Nickel-aluminum bronze
18. Silver
19. Nickel
20. Silver brazing alloys
21. Stainless steel (AISI types 302, 304, 321, 347) - passive
22. Stainless steel (types 316, 317) - passive
23. Titanium
24. Alloy 20 stainless steels - passive
25. Platinum - passive
26. Graphite

Fig. 2. Galvanic series of common metals: potential energy (in volts) when in saltwater.

In many cases, the effects of galvanic corrosion are negligible. The severity of galvanic corrosion depends on the difference in the electrical potential between the contacting metals. A chart showing the relative potentials of different metals, known as the galvanic series, is shown in Figure 2. The galvanic series is given in the figure based on saltwater conditions. However, the actual electrical potential of a metal will vary based on the electrolyte. For more exotic metal alloys, the electrical potential can be measured in a test laboratory according to ASTM G82: *Standard Guide for Development and Use of a Galvanic Series for Predicting Galvanic Corrosion Performance*. Note that stainless steels have different potentials according to whether they are passive or active (corroding) due to a breakdown of their passivating layer. The galvanic series shown in Figure 2 provides the electrical potential for stainless steels in their passive (normal) state rather than their active state, as this condition of stainless steel has an electrical potential that is further away from that of carbon steel.

In general, galvanic corrosion will not occur if the difference in potential is less than 200mV, but in an aggressive environment dissimilar metal corrosion can occur with a potential difference as small as a few tens of millivolts.

Galvanic corrosion is also affected by the relative surface areas of the metals in contact. If the surface area of the anode is much smaller than the surface area of the cathode, then the flow of electrons will have a high current density in the anode, resulting in rapid corrosion of the anodic metal. If the surface area of the anode is much greater than the area of the cathode, then the current density at the anode will be low and the corrosion will typically be negligible. As a rule of thumb, a cathode-to-anode surface ratio of at least 10:1 is optimal for minimizing galvanic corrosion.

The severity of galvanic corrosion can be predicted for construction materials of different potentials and surface areas using design charts—and of course, fasteners have a smaller surface area than structural members. See Figure 3 for a chart listing the corrosion susceptibility of different fastener/member metal couples.

Fig. 3. Galvanic corrosion potential between steel and common construction metals.

Galvanic Corrosion of Dissimilar Metals		Fastener					
		Stainless Steel	Copper	Brass	Carbon Steel/Iron	Aluminum Alloys	Galvanized Steel (Zinc)
Approximate Electrical Potential, Measured in Volts*		-0.05 to -0.25	-0.36	-0.25 to -0.4	-0.61	-0.80	-1.00
Member	Carbon Steel/Iron	Member may corrode	Member may corrode	Member may corrode	—	Fastener may corrode	No significant corrosion**
	Galvanized Steel	Member may corrode**	Member may corrode**	Member may corrode**	No significant corrosion**	No significant corrosion	—
	Stainless Steel	—	No significant corrosion	No significant corrosion	Fastener likely to corrode	Fastener likely to corrode	Fastener likely to corrode

* Volts in saltwater. Note that compatibility of materials should be assessed based on a galvanic series that is applicable to the exposure environment. For example, the difference in electrical potential between aluminum and stainless steel is typically negligible in general atmospheric conditions but is more pronounced in saltwater environments.

** Zinc coating is likely to corrode but is sacrificial.

Preventing Galvanic Corrosion

The simplest mitigation strategy is to remove any one of the four components from the galvanic cell. This may involve one or more of the following:

Elimination of the electrolyte (such as water) from connecting materials. Materials wholly enclosed inside of buildings with controlled environments are typically not susceptible to galvanic corrosion. Exceptions can occur on surfaces where condensation can form, or where the internal humidity is high. Coatings can also be used to keep an electrolyte from a surface, but the coating must be durable and free of defects to provide reliable protection.

Electrical isolation of the anodic and cathodic metals using an electrically insulative material. If there is no electrical connection between materials, the galvanic cell cannot form and galvanic corrosion cannot occur. Effective electrical insulators are materials that have high dielectric strength and low capacity for water absorption. Various isolation kits are available in the market, which often include materials manufactured from neoprene, mylar, nylon, PTFE (Teflon), or similar insulators. For bolted connections, an isolation kit may include plastic washers, bolt sleeves, and shims to isolate the dissimilar metals. When selecting alternative washers and shims that are to be used in a bolted joint, the washer

and shim strength and stiffness must be evaluated for compatibility with the loading condition—e.g., if the bolt is loaded in tension, the washer must provide adequate strength and stiffness to transfer and distribute the load to the connected parts.

The designer should also note that *RCSC Specification* Section 3.1 does not allow compressible materials to be included within the grip of a high-strength bolt assembly and states that “any materials that are used under the head or nut shall be steel.” Since an insulator is necessary under the head and nut to maintain electrical isolation, the engineer cannot rely on the installation procedures from the *RCSC Specification* for these bolts and must evaluate the effect of the compressible material on the joint—while recognizing that the joint may not develop pretension and will need to be kept from loosening in service.

Using materials of similar electrical potential. If possible, the difference in electrical potential between contacting metals should be limited, and/or the design should ensure that the anodic metal has a much greater surface area than the cathodic metal. The environment should also be considered, as any surface contamination with chlorides (such as in a marine environment or surfaces exposed to deicing salts) can result in very aggressive galvanic corrosion.

**ACCELERATING
YOUR
PERFORMANCE**



WWW.VOORTMANCORP.COM

VOORTMAN V325

HEAVY PLATE DRILLING, CUTTING,
MARKING AND MILLING



PROCESS CAPABILITIES:

								
plasma cutting	oxy-fuel cutting	bevel cutting	drilling	centerpoint marking	thread tapping	counter sinking	milling	layout marking

THE LEADER IN AUTOMATED STEEL PROCESSING SYSTEMS

MULTI SYSTEM INTEGRATION™

..... voortman.net/msi





VOORTMAN USA

26200 S. Whiting Way +1 708 885 4900
Monee, IL 60449 info@voortmancorp.com
United States of America www.voortmancorp.com

When Corrosion is a Good Thing

Is corrosion always a bad thing? No! Although not strictly a galvanic form of corrosion, two common corrosion protection methods use the concept of corrosion to your advantage:

Hot-dip galvanizing. In some cases, sacrificial anodes are coupled to structural materials to protect them from corrosion. The most common example of this is a zinc coating used to galvanize carbon steel, where the zinc is not relied upon to perform a structural function and the zinc material is slowly consumed to protect the underlying steel. Although not technically considered to be galvanic corrosion, the science behind this process is similar in that an anode (zinc) is designed to corrode over time and force the structural load carrying element (carbon steel) to be the cathode.

Cathodic protection. Cathodic protection systems come in two types: sacrificial anodes and impressed current systems. Both apply the concept of a galvanic cell with the protected material acting as the cathode (positive pole of the cell). These systems are typically most effective in buried or immersed conditions where the soil or water is available to act as an electrolyte. Sacrificial anodes without an external power source are often used for small structures such as buried tanks, piles, etc. These systems are low-maintenance and easy to install. For larger structures such as pipelines and wharves, an impressed current system may be more cost-effective—though the designer should consider that these systems have the potential to be turned off during a structure’s life, resulting in a loss of protection. In above-grade conditions, cathodic protection systems are not typically effective for steel frames as there is not an electrolyte readily present.

The table at right provides a few typical conditions of dissimilar metals in contact that a structural engineer may be asked to consider.

We hope this discussion has given you a better understanding of galvanic corrosion as it relates to structural design. For more nuanced conditions such as enclosure design, conditions involving water flow, or materials subjected to unusual exposures, please consider additional reading or consulting a building scientist or metallurgist for assistance. ■

Condition	Level of Concern
A carbon steel bolt is used in a stainless steel beam within a sealed plenum space of an office building.	Because there is no electrolyte (water or humidity) present in the space, a galvanic cell will not be expected to form, and galvanic action is typically not a concern.
A stainless steel walking surface is supported on a carbon steel pedestrian bridge with stainless steel bolts.	In an outdoor environment, a galvanic cell may form between these materials. The stainless steel deck should be isolated from the carbon steel structure. The stainless steel bolts will also tend to cause corrosion of the steel structure, but the amount of carbon steel will most typically be much greater than the amount of stainless steel, and the section loss in the carbon steel structure may be tolerable. If not, insulation kits should be used on the bolts to prevent section loss on the carbon steel members.
An aluminum cable tray is supported from a galvanized steel beam in an electrical switchyard.	If there is potential for moisture in this condition and chlorides are present, the aluminum may experience some section loss. If this is of concern, the materials should be isolated. In general atmosphere, galvanic corrosion between these materials will not typically occur.
A zinc-coated, carbon steel Unistrut member is welded to a stainless steel member to support a bin that will be exposed to seawater.	The Unistrut has a much more negative electrical potential and will likely corrode in this environment.
Aluminum fasteners are used in a steel bridge.	If chlorides from road salt are present, the aluminum fasteners will corrode significantly faster than the steel members, potentially resulting in premature collapse.
A carbon steel pipe is attached by a flange connection to a bronze pump body in a city water system with a high chloride content.	The carbon steel pipe will corrode and leak due to galvanic corrosion. A dielectric coupling should be used at the joint to prevent this from occurring.
A galvanized light-gauge carbon steel sloped cover plate is specified to prevent birds from perching on the bottom flange of an exterior beam. The plate is to be attached to a carbon steel beam with stainless steel fasteners.	As this situation occurs in an outdoor environment, the stainless steel fasteners will tend to cause section loss in the light-gauge galvanized steel plate. As the light-gauge material is thin, the amount of section loss may not be tolerable. Using a galvanized fastener will reduce the likelihood of galvanic corrosion.

business issues **TRUE TEAMWORK**

BY DAN COUGHLIN



Dan Coughlin (dan@thecoughlincompany.com) is the founder of management consultant firm The Coughlin Company, Inc., and co-author of *The Any Person Mindset: Be Accountable to the Difference You Can Make*. Visit his website at www.thecoughlincompany.com.

Tips on building teamwork that actually works.

TRUE TEAMWORK is difficult enough to build in sports.

It's even harder to build in business. However, the benefits for the individuals and the organization are well worth it.

I define teamwork as a group of individuals who support one another toward achieving meaningful objectives and fulfilling a meaningful purpose.

This is so easy to type, and yet so hard to create for any length of time.

There are four key elements of building a team:

- A clear purpose as to why the group exists
- Measurable and challenging outcomes for the team to achieve
- Individuals who have the abilities to do the work that needs to be done, the values that support the desired culture for the organization, and the desire to apply their passions and talents toward fulfilling the purpose and achieving the objectives
- A willingness on the part of these individuals to actively support each other, even if it means hurting their own individual recognition and rewards

That is a lot to ask of any group of people. And it might not work perfectly every time it's implemented. But when it all comes together successfully, the participants never forget the experience. They look back at truly well-executed teamwork experiences, and the results that were generated, with fond memories.

How to Facilitate Teamwork

Let's take a closer look at these four components.

Clarify the purpose. You can either clarify the purpose of the group before the members are recruited, or you can do it after the group has been assembled. Either way, the group needs a reason for existing before they will ever become a true team.

Consider these questions: Why does this group exist? What will be better as a result of this group's existence? What will be worse if this group never existed?

Don't copy your purpose from another group. Really think about it, discuss it, clarify it, and then communicate it over and over and over. Talk about it in conversational language, not some high-falutin statement that only a professional wordsmith could craft.

In sports, this is easy. We're working to win the Super Bowl/World Cup/Wimbledon/NCAA Tournament/state swimming championship. In business, it's not always so easy. You need to define a purpose that people can get excited about. Take the time to clarify it.

Establish meaningful objectives. What are the measurable outcomes you need to achieve to show progress toward fulfilling your purpose? What are three to five measurable indicators of progress that the whole team can work toward?

Make sure these objectives are challenging but realistic. Measure them on a regular basis. Communicate to the whole team how it is doing in terms of meeting these measurable objectives.

A purpose is deeply satisfying, but you need measurable outcomes to really know if you are making progress.

Select team members carefully. Not every person is right for every team. You need specific attributes in order to build a specific team. I suggest you answer the following questions for each potential member to make sure they are right for your team:

- What does the person need to be able to do well in order to do this job?
- In order to fit into our culture, what does this person need to believe is so important that it drives his or her behaviors on a consistent basis?
- How can this person use his or her passions and talents to make a meaningful contribution to the team?

Create an environment of mutual support. This is one of your most important jobs. Through your words and actions, you will either guide the group toward supporting one another or you will guide the group toward working in silos and looking out for themselves to the detriment of the team.

The way you talk about team members, especially behind their backs (because it *will* get back to them), will impact whether they feel safe in supporting their fellow team members or feel as though they are in danger.

The way you highlight the achievements of the group will either send a message that it's all about individual stars or all about the team efforts.

In other words, the way you work to support the group will either send a message that you truly care about the team or you truly care about yourself, your reputation, and your future career.

People will imitate the path you set. I encourage you to really think about sending messages that show you applaud people's efforts to support each other in fulfilling the purpose of the team and achieving the desired outcomes.

How to Sabotage Teamwork

For every path to encouraging teamwork, there's a path to ruining it. If you want your team to gel and succeed, you should obviously avoid these behaviors.

Don't aim contempt toward team members. Dr. John Gottman has conducted more than 40 years of research on relationships and marriage. He discovered that the number one reason for divorce is contempt, where one person has an attitude of superiority toward the other person and expresses this sense of superiority in dismissive, disdainful, and demeaning statements.

I believe Gottman's work applies to business groups as well. People will work incredibly hard to help other people on the road to achieving something extraordinary and meaningful. However, the wind goes out of their sails when they feel the other person has an attitude of contempt. If they get a sense that this person feels he or she is better than everyone else and looks down on the rest of the team, then teamwork begins to crumble. In all areas of life, and especially at work, people fall into small packs and waste an enormous amount of time in complaining about The Contemptuous Ones.

Don't promote your personal agenda items. If people get the idea that you are only focused on issues that are important to you personally—and that you are effectively using the group to achieve what you personally want accomplished—the teamwork mentality will disintegrate.

The manager plays an incredibly important role in the creation of teamwork. And the manager must set aside his or her personal agenda and work with the group to fulfill a clear, meaningful purpose and achieve important objectives. The manager is the guide for the group to become a team. If you make the goals all about your personal agenda, you have lost your credibility as that guide.



Worth It? Absolutely!

It is completely worth it to build true teamwork in an organization. It is also very hard work to build true teamwork in an organization.

But if you follow these steps and stay the course, you can create true teams and reap their benefits throughout your career, and empower your fellow team members to do the same. And in the best cases, you can do something that people will look back on years down the road and be thankful that they were a part of that team. ■

This article features content presented in the session “Build Teamwork that Works to Win” at the 2019 NASCC: The Steel Conference in St. Louis. You can access a recording of that session, as well as all of the 2019 sessions, at www.aisc.org/2019nasconline.

Soccer Star

BY JUSTIN BARTON, SE, PE

Minnesota United's stunning, sophisticated new soccer stadium is encapsulated by a complex web of steel wrapped in a first-of-its-kind translucent, tear-resistant skin.

ALLIANZ FIELD HAS ELEVATED the American professional soccer experience.

The new soccer-specific stadium soars as the home for Minnesota United FC of Major League Soccer (MLS), the top flight league in the U.S. and Canada.

Naming rights were acquired by Allianz, a global life insurance and retirement services company whose North American headquarters are in Minneapolis. The stadium, which opened to spectacular reviews this past April, serves as the focal point for a new mixed-use redevelopment on a 35-acre brownfield site in St. Paul, Minn. In announcing the neighborhood revitalization, team owners outlined their vision of a captivating and intimate stadium that rivals international soccer venues. The \$250 million stadium has a 19,500-seat capacity and the capability to expand to 23,000. Though the pitch is open to the sky, fans are protected from inclement weather by a 360° cantilevered steel canopy structure. Encircling the stadium is an undulating wall of translucent polytetrafluoroethylene (PTFE) fabric backlit by variable LED lighting and supported by a hollow structural section (HSS) frame. And the farthest seat is just 125 ft from the

sideline, making a Minnesota United home game one of the most exclusive tickets in professional soccer.

Steel Bowls

The stadium is laid out as a lower seating bowl, a west tower featuring a Club Level with an associated seating bowl, a suite/press level, an east side upper seating bowl, and a south side elevated seating bowl, all encircled by a 360° main concourse and the cantilevered canopy extending over the seating bowls. Several other significant structural components are present throughout the stadium, including a field club, the scoreboard, field lighting supports, and back-of-house structures.

The stadium pitch is depressed 19 ft below grade, allowing fans to enter at the concourse level and minimizing the building's height compared to adjacent neighborhood developments. (As Minnesota United owner Bill McGuire puts it, "This stadium fits into the neighborhood without overwhelming it.") Half of the stadium features a basement to match the pitch level, housing team locker rooms, a loading dock, the premium field club, and other operational spaces. The concourse is a mixture of slab-on-grade

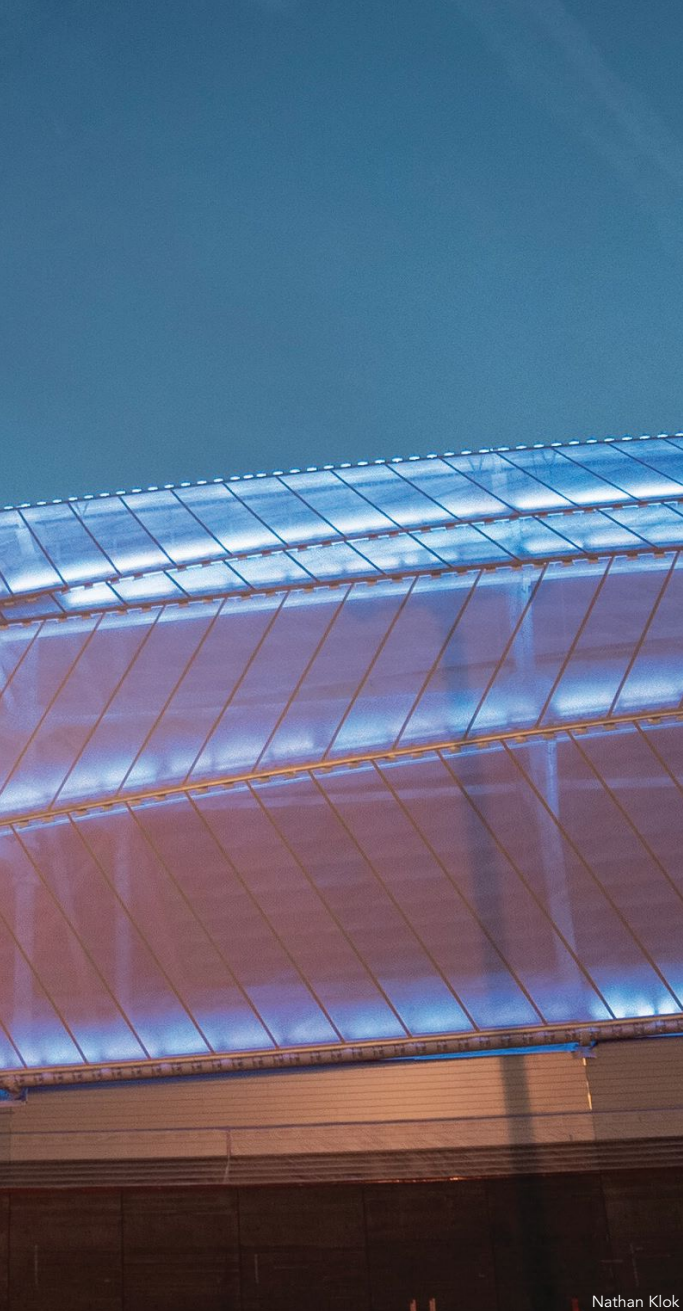

Nathan Klok

left: The 19,500-seat Allianz Field is wrapped in an undulating skin of translucent polytetrafluoroethylene (PTFE) fabric backlit by variable LED lighting.
below: The skin is supported by a frame of curved 18-in.-OD HSS.



Walter P Moore

concrete and cast-in-place concrete framing over the partial basement, and the lower bowl is a combination of on-grade concrete and precast treads/risers.

Structural steel (totaling 4,600 tons) was the easy and economical choice for the remainder of the primary structure thanks to its ability to meet the design and construction challenges of multiple shapes and assemblies, long cantilevers, irregular geometry, and fast erection.

The east upper bowl uses steel rakers to support precast concrete treads and risers, and the south upper bowl incorporates steel stringers and rakers to support aluminum treads and risers. The west tower has two levels of composite concrete slab on metal deck supported on steel beams to frame the club and suite levels, and cantilevered steel rakers extend 20 ft beyond the column line, providing exceptional views for fans. In addition, the roof over the suite level is supported by steel girders and open-web steel joists.

Major League Canopy

The MLS season stretches from early March to late November, meaning fans in the Twin Cities area will experience game-day weather ranging from sub-freezing temperatures to hot summer afternoons, driving rainstorms to perfect, clear evenings. This required the ownership group and design team to create a stadium that would remain open to the elements, yet still provide a high level of fan protection and comfort. A large canopy covering the fans, while keeping the natural grass pitch open to sun and rain, is a solution that has been used successfully in European soccer (football in European and rest-



Justin Barton (jbarton@walterpmoore.com) is a principal in Walter P Moore's Kansas City office.



MNUFC

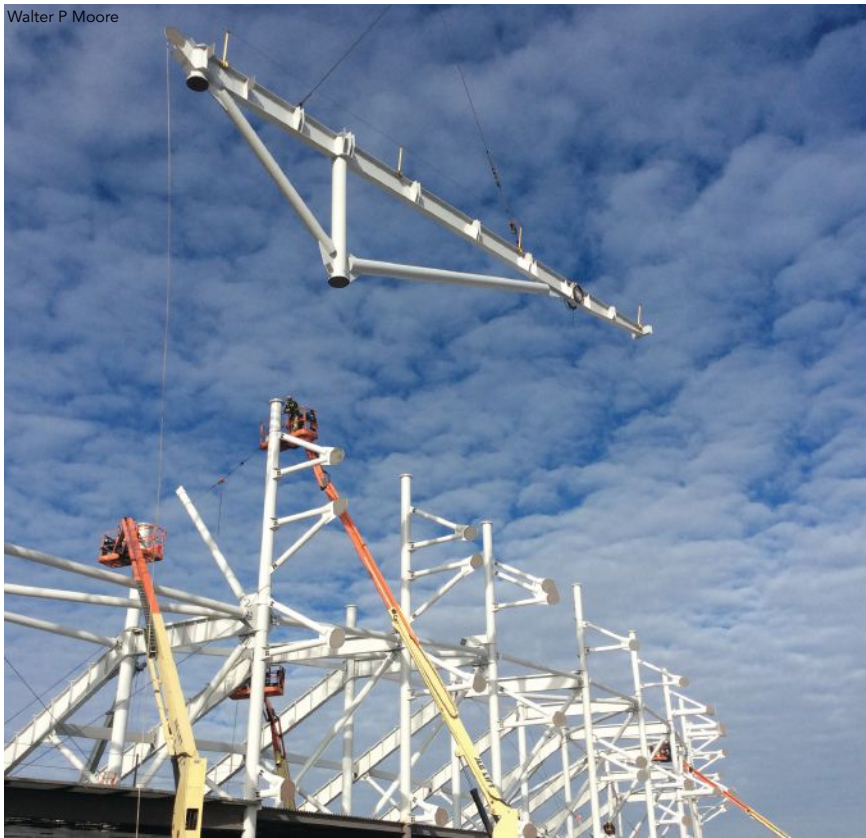

Walter P Moore

above: The field is 19 ft below grade, minimizing the building's height compared to adjacent neighborhood developments.

left: Each 78-ft-long canopy girder unit was fully shop-assembled then erected as a single lift.

of-the-world parlance) venues for decades, and that mindset translated to Allianz Field as well.

A variety of canopy shapes and types were considered early in the design process, including a tensile fabric canopy, a cantilevered truss, and a cantilevered, propped girder system. Ultimately, a steel girder system was chosen as the most economical choice for the desired canopy size. The 145,000-sq.-ft canopy, which extends from support columns at the back of the bowl, covers approximately 85% of the seating, simultaneously protecting fans from the elements and reflecting sound back onto the pitch below.

Structural steel framing created a light and graceful support for the large canopy while having sufficient strength to address the heavy snow loads typical of a Minnesota winter. The structural system incorporates 3-in. steel deck spanning 13 ft to minimize the number of purlins supporting the canopy, and each purlin then frames into a large wide-flange girder at each grid line at a bay width of 42 ft, 8 in. Each girder cantilevers from a back-of-bowl column and is supported by a single strut that props the girder up. Although this resulted in a slightly heavier system than a cantilevered truss (due to additional bending imposed on the girder) it created a much more open structure and required fewer pieces to fabricate and erect. At the leading (inner) edge, the girder tapers down from 36 in. to 16 in., matching the depth of the steel purlins and creating a consistent thin profile all the way around the stadium. At the north end, the canopy gracefully swoops down, lowering the overall profile of the stadium.



Walter P Moore

At the leading (inner) edge, the girders taper down from 36 in. to 16 in.

The trapezoidal shape of the supporters' section frames perfectly into the 22-ft x 116-ft main videoboard.

.....

Due to steel fabricator Merrill Steel's proximity to the job site (185 miles) as well as its trucking equipment and capabilities, the canopy girder and strut assemblies were fully fabricated, welded, and painted in the shop, then shipped to the site and erected. The longest canopy-and-back-span piece to be shipped measured 110 ft long (78-ft cantilever plus 32-ft back span) and 19 ft deep and weighed 26 tons. Thanks to the shop fabrication and assembly of these elements, erector Danny's Construction was able to place two assemblies per day. The entire canopy was erected in just 20 weeks, including the harsh early winter months.

Wonder Wall, Smooth Skin

The soul of every soccer stadium is the supporters' section. These are the fans that stand, sing, drum, chant, and jump for 90-plus minutes at every match, providing a collective heartbeat and megaphone for the hometown fans. Beyond the vocal impact, Allianz Field makes the supporters' section a visual standout as well. Behind the south goal, the 2,800-capacity section rises at approximately 35°, creating a true "wall of sound." In addition, the trapezoidal shape of this seating area frames perfectly into the

.....

right: A Tekla model of the "driver pipe" frame.

below: This HSS frame serves to "drive" the skin's complex geometry and create the supporting structure that gives the skin its distinctive form.



Walter P. Moore

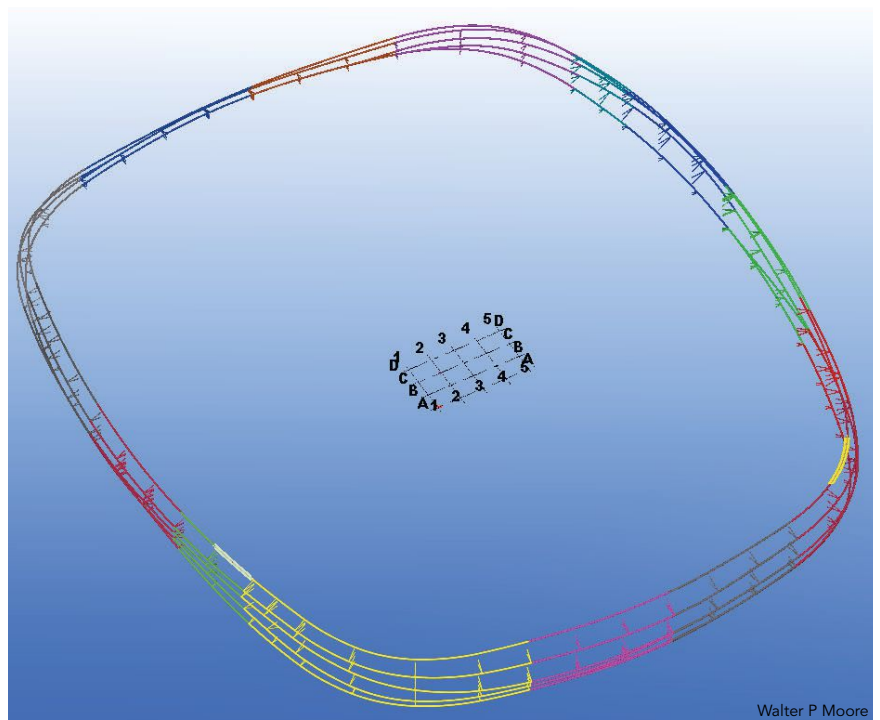

Walter P. Moore



Walter P. Moore



Walter P. Moore



Walter P. Moore

The PTFE fabric is connected to continuous aluminum extrusions that are connected back to the driver pipes through built-up tee-shapes at 18 in. on center.

Steel fabricator Merrill and PTFE installer Fabritec collaborated to accurately locate each tee-shape along the length and radius of a given driver pipe.

22-ft × 116-ft main videoboard above. Three integral steel-framed catwalks with steel grating allow convenient access to the display panels for maintenance.

The steel bowl structure was designed per the latest Institute of Structural Engineers (UK) standard for fan participation loads in order to not induce any objectionable vibration from fans jumping throughout the match. After each home win, the supporters section leads the entire stadium in singing Oasis' *Wonderwall*, a tradition that started back when the team played in the North American Soccer League (NASL), the United States' second-tier soccer league.

The stadium's signature visual feature is the PTFE skin, which wraps around the entire perimeter. Team ownership desired a stadium whose exterior skin was as dynamic and intricate as the action on the pitch and thus challenged the design team to find a cladding material that would provide appropriate weather protection in the often-harsh Minnesota wind and rain (and snow), while also creating a distinctive and elegant look. Minnesota United and project architect Populous envisioned cladding that

could be colored, backlit, and transparent so as to visually connect fans outside the stadium to the energy being generated within.

Collaborating with façade products manufacturer Saint-Gobain, the project team developed a new type of fabric containing an open weave of fiberglass yarns that provides strength and tear resistance and also serves as a platform to hold color. The fiberglass weave is laminated with a clear PTFE that renders the material weathertight and allows twice the amount of light transmission compared to traditional PTFE-coated membranes.

Steel forms the backbone supporting the PTFE. In order to minimize cost, the fabric needed to span as far as possible between supports, which induces large bending loads in two directions along the support lines. Simultaneously, those support lines needed to curve around the stadium to create the desired architectural appearance, and 18-in.-OD hollow structural sections (HSS) proved to be the ideal solution. These pipes, dubbed "driver pipes" serve to "drive" the skin's complex geometry and create the supporting structure that gives the skin its distinctive form.

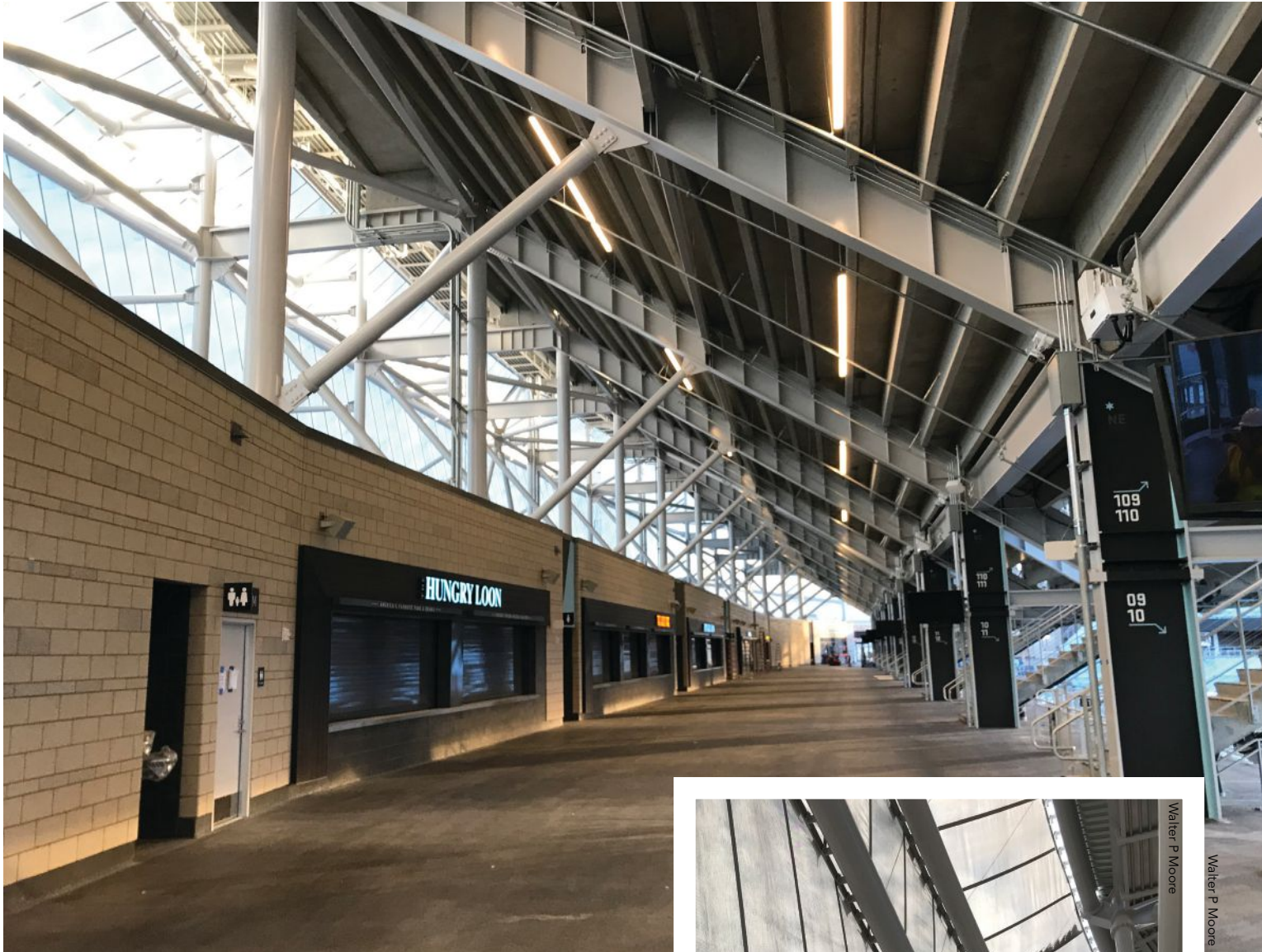

above: The 360° main concourse is located at street level, with the pitch 19 ft lower.
 right: An inside look at the driver-pipe framing system for the translucent skin.

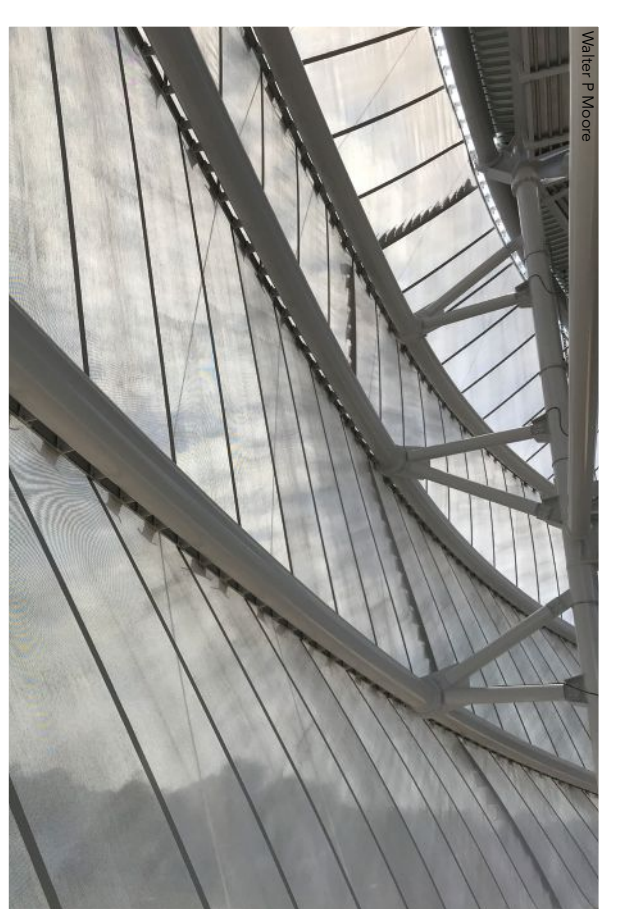

Walter P Moore
 Walter P Moore

Digital Workflow

During the design process, Populous and structural engineer Walter P Moore developed a digital workflow to rapidly incorporate complex architectural geometry into structural models and communicate the impacts in quick turnarounds to modify architectural design—which created a symbiotic relationship of design, analysis, and performance. Essentially, this equated to having a single file in which all parties could access, process, manipulate, and rapidly share the data, enabling quick decision making and leading to an efficient system within the schedule and budget constraints. The digital model (using Grasshopper/Rhinoceros 3D) served as the centerline of the pipes, which was a direct offset from the PTFE transition lines. That digital model was then used as the baseline for the structural steel analysis model. Eventually, the model was converted into a Tekla model so that Merrill Steel would have the exact 3D geometry rather than having to create the geometry from a 2D set of drawings. Although giving the appearance of curving in two directions, each driver pipe has a single radius, greatly simplifying the fabrication and rolling processes.



The PTFE fabric is connected to continuous aluminum extrusions that are connected back to the driver pipes through built-up tee-shapes at 18 in. on center. Although each driver pipe uses a single radius, the tees follow a spiral layout along each pipe, allowing the fabric to achieve a smooth, undulating appear-

ance around the entire stadium. The final layout of these tees was determined by Fabritec, the PTFE installer, who coordinated the layout with Merrill and developed a precise system to accurately locate each tee-shape along the length and radius of a given driver pipe.

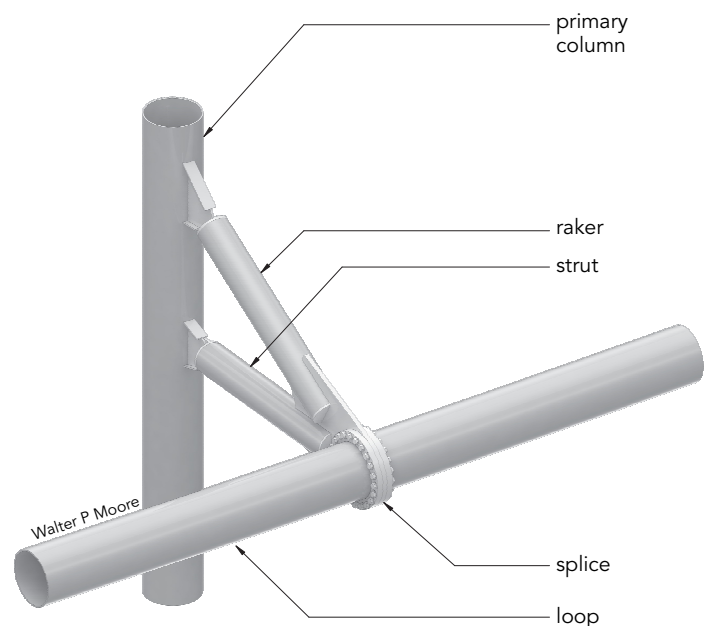
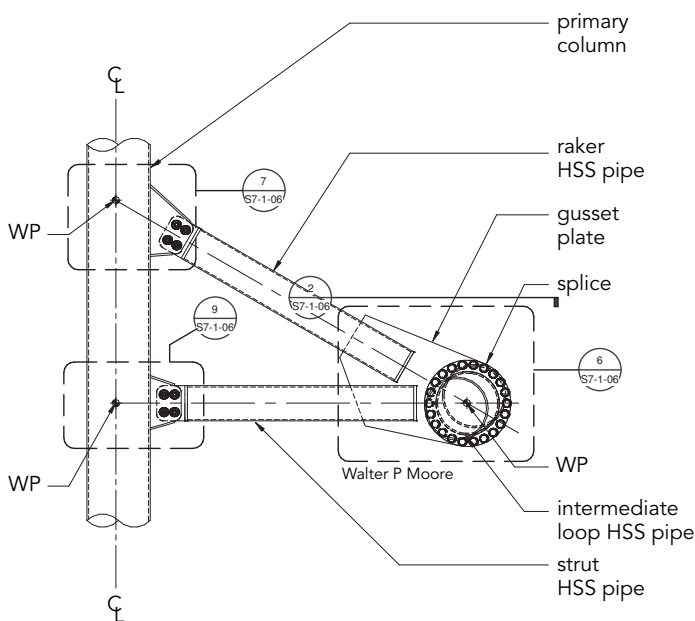

A sample connection at the intermediate loop of the driver-pipe system.

A 3D model of the connection detail at left.



Ryan Linton

above: The stadium's large canopy and translucent skin create the perfect game-day atmosphere.

right: Elevation drawings of two driver-pipe wall sections.

.....

The driver pipes are supported by 10-in.-OD HSS, known as armature assemblies, that connect back to the main building columns. Each of these armature assemblies was also controlled and developed in a digital model. To facilitate erection of the driver pipes, an end-plate connection was welded onto each pipe and then bolted to a connection plate that is part of the armature assembly.

The end result is jaw-dropping: a beautifully exposed structural steel building that provides the strength and complex geometry required to create the iconic façade and dramatic canopy. Allianz Field has set a new standard for soccer stadiums in North America, and structural steel was a critical component in bringing the owner's and architect's stunning vision to reality for the team, its fans, and the surrounding community. ■

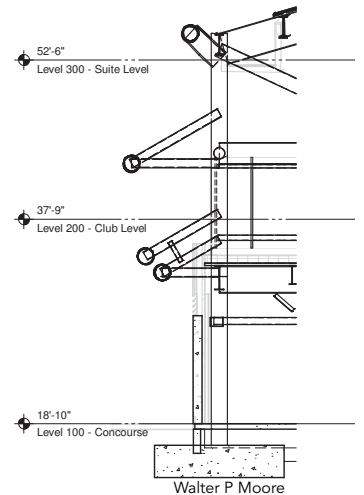
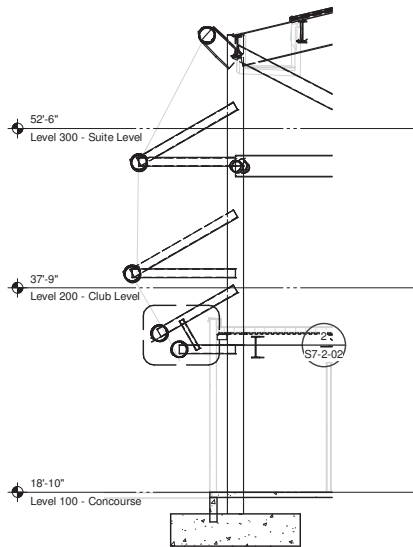

Owner
Minnesota United FC

Owner's Representative
TEGRA

Construction Manager
Mortenson Construction

Architect
Populous, Kansas City

Structural and Enclosure Engineer
Walter P Moore, Kansas City

Steel Team Fabricator
Merrill Steel, Schofield, Wis. 

Erector
Danny's Construction Co., Shakopee, Minn. 

Bender-Roller
Max Weiss Co., Milwaukee 

Healthy Example

BY JEFF KOKE, PE, THOMAS TAYLOR, PE, AND DAVE THOMAS, SE, PE



Exposed steel inside and out elevates a new Colorado Hospital's identity and helps solidify its role as a prototype for future facilities of its kind.

Jim Roof

ANY NEW HOSPITAL should be built with the goals of providing high-quality healthcare, state-of-the-art medical equipment, excellent physicians, and a comfortable environment for patients.

For the new steel-framed UCHealth Longs Peak Hospital in Longmont, Colo., another goal was added to the list: Serve as an example to other hospitals.

Many design teams will tell you that their newest building is a shining example for future structures of similar type, but for Longs Peak Hospital, this isn't just lip service. The UCHealth system is rapidly expanding and the new facility was designed as a prototype for all new UCHealth hospitals. Thanks to this additional expectation, it was important for the hospital to not only be cost-efficient but also incorporate a signature branding element that could be echoed at future facilities.

The 210,000-sq.-ft, LEED Silver hospital includes 51 inpatient beds (expandable to 100), an intensive care unit, four operating rooms, a birth center, advanced cardiology services, an emergency department, and a separate surgery center. The three-story building is steel-framed—using roughly 1,600 tons of structural steel in all—and built with a 30-ft × 30-ft grid using concentric steel braces on top of drilled piers. The design is punctuated by a

four-story open lobby and the aforementioned signature element: a 150-ft-long clear-span arched roof featuring exposed curved steel horizontal braces. The roof's visual impact was so strong that it has even become part of the UCHealth logo. In addition, the design team was tasked with incorporating local building materials (wood and stone) into the façade to reflect the hospital's namesake Longs Peak, one of the state's many 14,000-ft-plus peaks (known as 14ers), which rises roughly 40 miles to the west in Rocky Mountain National Park.

Raising the Roof

The signature arch came with several structural challenges including constructability, reducing horizontal and vertical deflections to protect the glass-walled lobby, and accounting for thermal expansion. The arched roof is supported on one end by a four-story open lobby and on the other by a stair tower. The girders extend over the lobby and cantilever an additional 18 ft, and at the stair tower the front girder is supported by a cantilevered beam that projects 15 ft.

Early in the design process, structural engineer Datum Engineers worked with steel fabricator Drake-Williams and

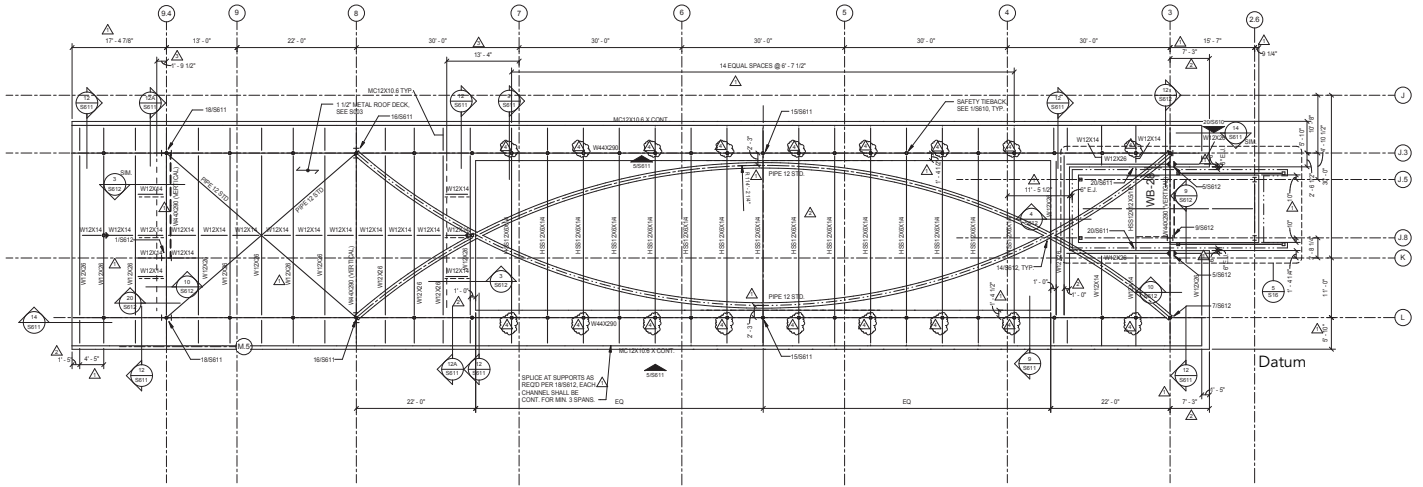

opposite page: The roof arch for Longs Peak Hospital inspired the underscore for owner UCHealth's logo, which can be seen on the top "stripe" of the building's wood cladding.

above: A top-down view of the roof framing plan, highlighting the curved elements and "aileron" shading elements.

below: The arched roof is supported by a stair tower at one end and the framing for the four-story lobby at the other end.



erector LPR Construction to study several framing options to efficiently span the 150 ft with a shallow section, with the goal of matching the architectural intent while also remaining constructable. Drake-Williams suggested using deep wide-flange beams instead of the originally proposed built-up box girders, so Datum selected W44x290 beams with bolted splices at a maximum spacing of 45 ft. This scheme was cost-effective and allowed for easy fabrication, shipping to the construction site, and field splicing. The early coordination allowed the mill order for the girders to be placed while design was being completed so that the deep beams, with a longer lead time, would be ready by the time the supporting structure was built.

The project's architect, EYP Health, designed an open roof with shading "aileron" — thus the roof deck could not be used as a diaphragm and any bracing across the clear span would need to be exposed. Rather than using standard horizontal X-braces, Datum proposed two architecturally exposed structural steel (AESS) opposing curved pipes that would complement the arched roof.

Special care was taken to align the brace points such that these two 12-in.-diameter elements intersected at each end of the roof opening to seamlessly integrate with the architecture. Inside the covered portions of the roof, the braces switch to standard X-braces. The open concept of the roof also meant that the wide-flange girders would be unbraced across the opening. To mitigate this, Datum designed the shade elements crossing the roof's opening to be moment connected to the girders so as to prevent lateral torsional buckling.

Dave Thomas (dave@datumengineers.com) is a senior associate and the engineer of record for the Longs Peak Hospital project, **Thomas Taylor** (thomas@datumengineers.com) is a principal design engineer, and **Jeff Koke** (jeff@datumengineers.com) is a principal and studio director, all with Datum Engineers in Dallas.



Haseldeh

The 150-ft roof segment on the ground, 50 ft from its final position.



Drake Williams

The 135-ton segment was qualified as a critical lift under OSHA standards.



Drake Williams

A two-crane tandem lift was used, with each crane lifting more than 75% of its rated capacity.

LPR assembled the roof in two segments on the ground to minimize work needed high in the air. The first segment formed the lobby roof and the second segment, which consisted of the 150-ft clear span, weighed 135 tons and qualified as a critical lift under OSHA standards. After a month of extensive planning, this latter segment was put into place, 50 ft from where it was assembled, using a two-crane tandem lift, with each crane lifting in excess of 75% of its rated capacity. Once

in its final location, bolted splices allowed for quick connection to the building structure.

Another challenge with the arched roof was how to deal with the large temperature swings it would experience relative to the air-conditioned hospital it was connected to. Through a RISA 3D analysis, Datum found that between dead, live, wind, snow, and thermal loads, the roof would deflect up to 3 in. horizontally in the long direction. Pot bearings and an expansion joint were used

ICC-ES Approved Structural Steel Connections

Lindapter's Girder Clamp is the **world's first** and **only** approved structural steel clamping system that is compliant with the International Building Code.

- ✓ No drilling or welding in the field!
- ✓ Faster installation reduces labor costs
- ✓ For structural steel sections including W and S beams, channels, and angles
- ✓ High tensile and slip resistance capacities
- ✓ Free connection detailing service



lindapter®

Celebrating 85 years of innovation

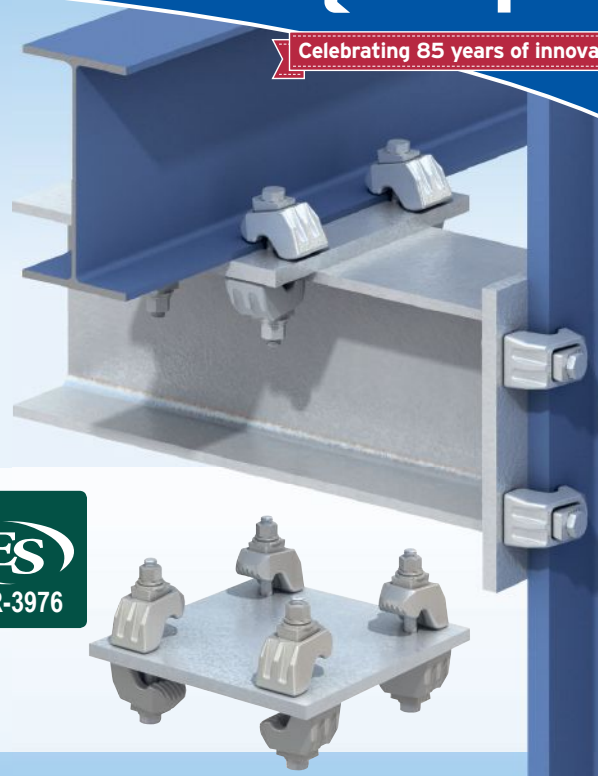

For information and design data, call **866 566-2658** or visit **www.LindapterUSA.com**



Haselden

Connecting the 150-ft clear-span segment with the lobby roof segment via bolted splices.



Datum

The arch roof in its final position. The roof's curve has been incorporated into the UCHHealth logo.

on the stair tower side of the roof in order to accommodate this movement without imposing undue stresses on the supporting elements. Fabreka-TIM thermal structural break elements were also incorporated into the support connections in order to reduce thermal bridging and improve the building's energy performance; any bolts passing through the thermal break were stainless steel.

While the roof only spans 150 ft in terms of gravity loads, it spans 185 ft for horizontal loads and acts to brace the top of the

four-story lobby, whose glass also extends about 15 ft underneath the long-span girders. Due to this connection to the lobby, deflections had to be tightly controlled by the horizontal curved braces.

Exposed Inside and Out

Datum worked closely with EYP Health to craft the grand lobby underneath the arched roof. One of the main W21×132 columns supporting the arched roof appears unbraced out-of-



OPTIMIZED. MINIMIZED. SIMPLIFIED.

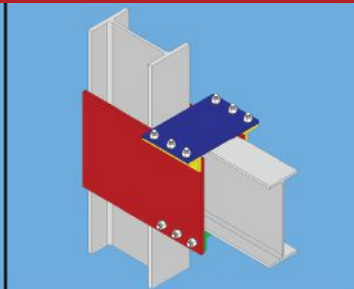
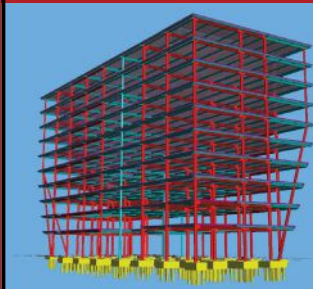

SIDEPLATE BENEFITS:

- Schedule efficiency
- Field-bolted construction
- No field-welding
- Reduced required connections
- Minimized crane time
- Increased design flexibility
- Reduced steel package costs
- Increased useable square footage

www.sideplate.com
949-238-8900
info@sideplate.com



above and below: The exposed steel elements in the lobby were designated as AESS Category 3, as they are within 10 ft to 20 ft from view.

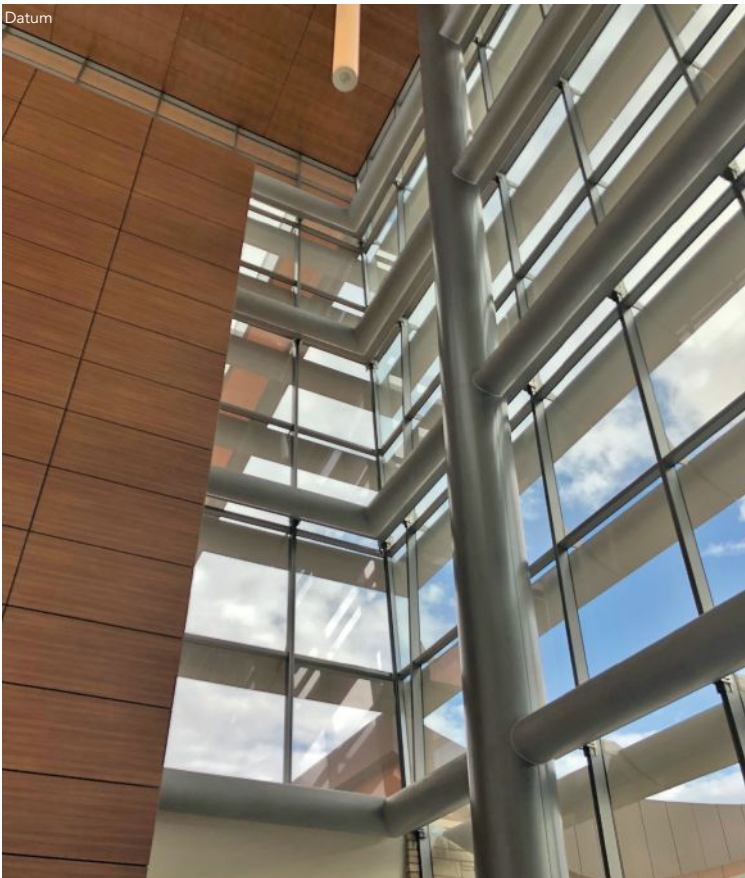

plane for its full 70-ft height, but Datum was able to moment connect the wind girts that frame into this column in order to laterally brace it for increased capacity and reduce wind deflections.

While the curved pipes of the roof and the wind girts in the lobby were both specified as AESS, they used different categories. As the arched roof is nearly 60 ft above the ground, a modified version of AESS Category 2 (which covers steel elements greater than 20 ft away) was specified. Category 2 mandates fabrication tolerances for straightness to be half that of standard tolerances, but this requirement was omitted as it was difficult to achieve due to the long span and radiuses in two directions. Additionally, the distance from view and curved geometry would make any reduction in tolerance difficult to discern. However, special care was taken in detailing to ensure that all connections were either hidden or had clean continuous welds. This included a requirement that butt splices for the pipes be ground smooth, as any imperfections in the pipes would still be readily visible. The pipes are connected to the shading ailerons with welded tabs on top that are hidden from view, and to the main girders at mid-span using a perpendicular pipe of equal size. This made for a very clean appearance and also offset the curved pipes from the girders to simplify waterproofing.

Below, in the lobby, the wind girts blend in with the curtain wall mullions and shading elements to become nearly invisible from the building exterior, yet remain as prominent elements inside the lobby. Since they are within 10 ft to 20 ft of view from the floor, AESS Category 3 (for steel components within a viewing distance of 20 ft or less) was specified. The connections of the girts to the columns are hidden within column wraps, but the connections of the girts to the curtain wall are exposed. The curtain wall was offset about 9 in. from the face of the wind girts, and the large amount of glass in the lobby also required radiators be located at each girt to maintain a comfortable environment. This prompted the need for a creative solution to provide a clean look, so a continuous plate was designed that would act as a support point for the curtain wall as well as provide a shelf to support and hide the radiators. The welds on the underside of this plate were specified to be contoured and blended to give a clean, seamless appearance.

In addition to the arched roof and exposed framing in the lobby, a third signature element greets visitors at the front door: the main entry canopy. Composed of steel, stone, and metal panels made to look like wood, it features a 27-ft cantilever with a 10-ft back span to support the roof, whose curved “scoop” shape is intended to coordinate with the arched roof. The canopy is framed with built-up wide-flange beams that taper from 44 in. deep at the column connection to 12 in. deep at the end—which then transition to 8-in.-deep back-to-back channels bolted to the web of the built up beam. The long cantilever, snow accumulation in the roof, and stone used to clad the W18 steel columns necessitated very high column stiffness to reduce rotations and keep the brick from cracking. As such, the columns are encased in a concrete base to create

Curved Architecturally Exposed Structural Steel (AESS)

On time
On budget
And as expected

Institute of Environmental Sustainability;
Loyola University of Chicago

Winner of the SEAOL
"Best Project"
award.

Chicago Metal Rolled Products curves to AESS tolerances or better.

This 3,100 sq ft urban agricultural greenhouse is designed with nine elliptically curved trusses rolled by Chicago Metal Rolled Products from 5" and 8" diameter AESS pipes. These pipes were curved multi-radial from a tight 12' radius with a 90 degree bend to a very large 250' radius. The resulting structure forms a truss for a glass curtain wall designed to maximize sunlight in the greenhouse growing area and minimize glare for the surrounding buildings.



**CHICAGO METAL
ROLLED PRODUCTS COMPANY**

CHICAGO • KANSAS CITY
cmrp.com



Call us at 866-940-5739

When you need it done right

We bend ALL sizes up to:

We bend ALL sizes up to:



1 Angle Leg Out

10" x 10" x 1" Angle



2 Angle Leg In

10" x 10" x 1" Angle



3 Flat Bar The Hard Way

24" x 12" Flat

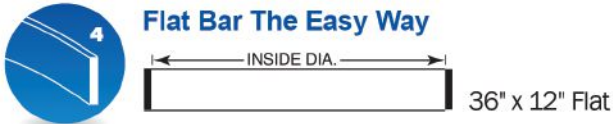

4 Flat Bar The Easy Way

36" x 12" Flat

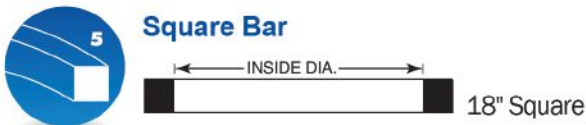

5 Square Bar

18" Square

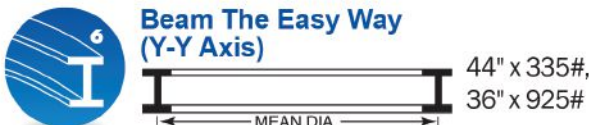

6 Beam The Easy Way (Y-Y Axis)

44" x 335#,
36" x 925#



7 Beam The Hard Way (X-X Axis)

44" x 285#



8 Channel Flanges In

All Sizes



9 Channel Flanges Out

All Sizes



10 Channel The Hard Way (X-X Axis)

All Sizes



11 Tee Stem In

22" x 142¹/₂# Tee

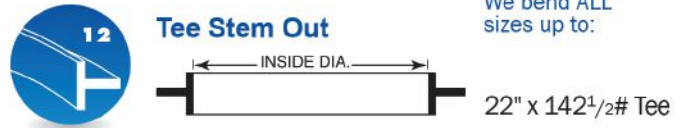

12 Tee Stem Out

22" x 142¹/₂# Tee

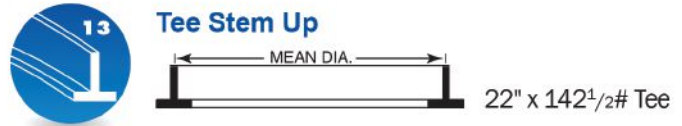

13 Tee Stem Up

22" x 142¹/₂# Tee

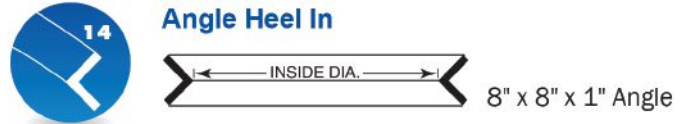

14 Angle Heel In

8" x 8" x 1" Angle

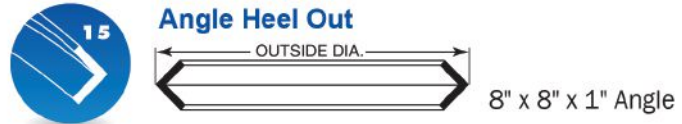

15 Angle Heel Out

8" x 8" x 1" Angle

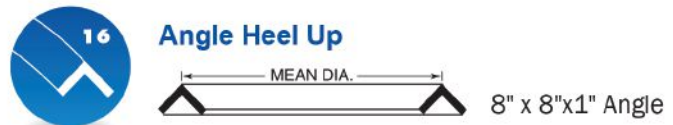

16 Angle Heel Up

8" x 8"x1" Angle

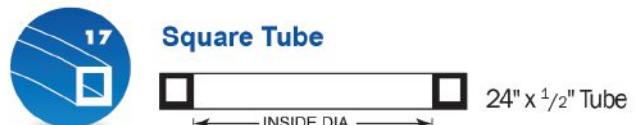

17 Square Tube

24" x 1¹/₂" Tube

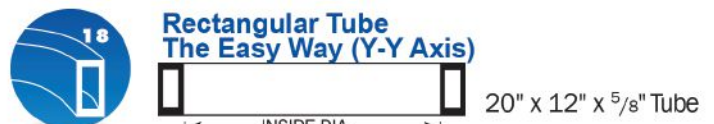

18 Rectangular Tube The Easy Way (Y-Y Axis)

20" x 12" x 5⁵/₈" Tube

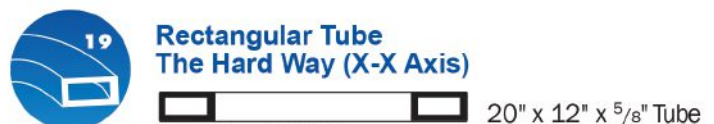

19 Rectangular Tube The Hard Way (X-X Axis)

20" x 12" x 5⁵/₈" Tube

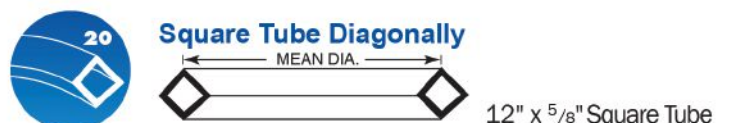

20 Square Tube Diagonally

12" x 5⁵/₈" Square Tube



21 Round Tube & Pipe

24" Sched. 80 Pipe

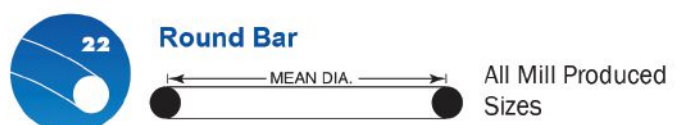

22 Round Bar

All Mill Produced Sizes

We also roll stair stringers, helical hand rails, off-axis bends, formed shapes and extrusions.

Visit cmrp.com for more information.



CHICAGO METAL ROLLED PRODUCTS COMPANY

CHICAGO • KANSAS CITY



a composite section. Not only did this achieve the required stiffness, but it also provided a seamless transition to the foundation while eliminating the need for a large base plate to transfer overturning moments.

Thanks to close collaboration and early fabricator involvement, the design and construction teams “got it right the first time” with Longs Peak Hospital, setting up future UCHealth hospitals—with several currently under construction—for success. ■

Owner

UCHealth, Aurora, Colo.

General Contractor

Haselden, Centennial, Colo.

Architect

EYP Health, Denver

Structural Engineer

Datum Engineers, Dallas

Steel Team

Fabricator

Drake-Williams Steel, Inc., Aurora, Colo. 

Erector

LPR Construction Co., Loveland, Colo. 

Bender-Roller

Albina Co., Inc., Tualatin, Ore. 

An Acceptable Alternate Addresses an Unavailability

When designing the arch roof, Datum Engineers had initially specified either ASTM A53 or A500 Grade B for the curved pipe elements. The project’s steel fabricator, Drake-Williams Steel, Inc., suggested substituting A252 Grade 3 steel of the same diameter due to the unavailability of the requested grade in the needed lengths to meet the project schedule. While A252 has a rather loose specification and isn’t listed in the AISC *Specification for Structural Steel Buildings’* (ANSI/AISC 360, www.aisc.org/specifications) list of approved materials, mill test reports showed that yield strength, tensile strength, elongation, and chemical composition all fell within the requirements for ASTM A500 Grade B—which is listed in the *Specification* as an approved material—but A252 also has less stringent tolerances for diameter, thickness, and straightness than A500B. Datum specified oversized pipes to provide the correct architectural scale, so the pipes were only stressed to about 30% of their capacity. As such, the added tolerances in thickness and diameter were not problematic, and the double curvature of the pipes eliminated any concerns over the straightness tolerance. After careful evaluation of the mill test reports for the proposed material, Datum authorized the use of the A252 Grade 3 material for the curved pipe features.

For more on the use of unlisted materials, see the “Unlisted Materials” series of SteelWise articles (October, November, and December 2018, all available at www.modernsteel.com).

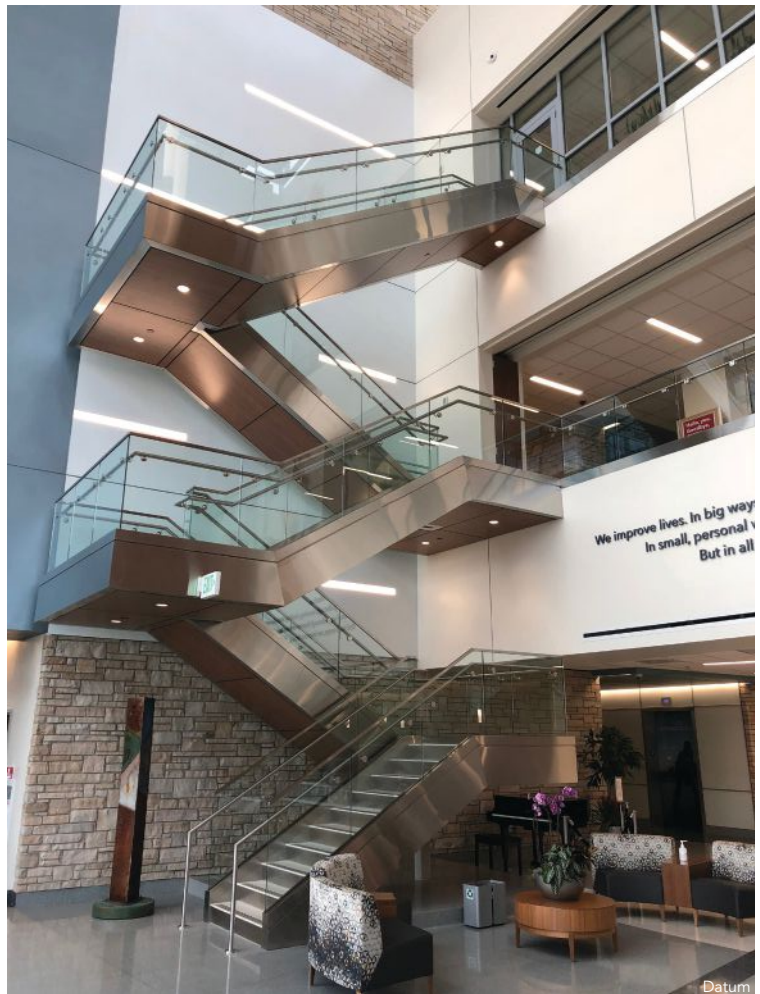

above: A grand stair is located at the opposite corner of the exposed steel framing of the lobby.

below: The “scoop” design of the ground-level entry canopy was designed to complement the exposed arch roof.



A Chicago fitness club becomes a sporty new athletic resort when a steel-framed expansion walks onto the court mid-design.

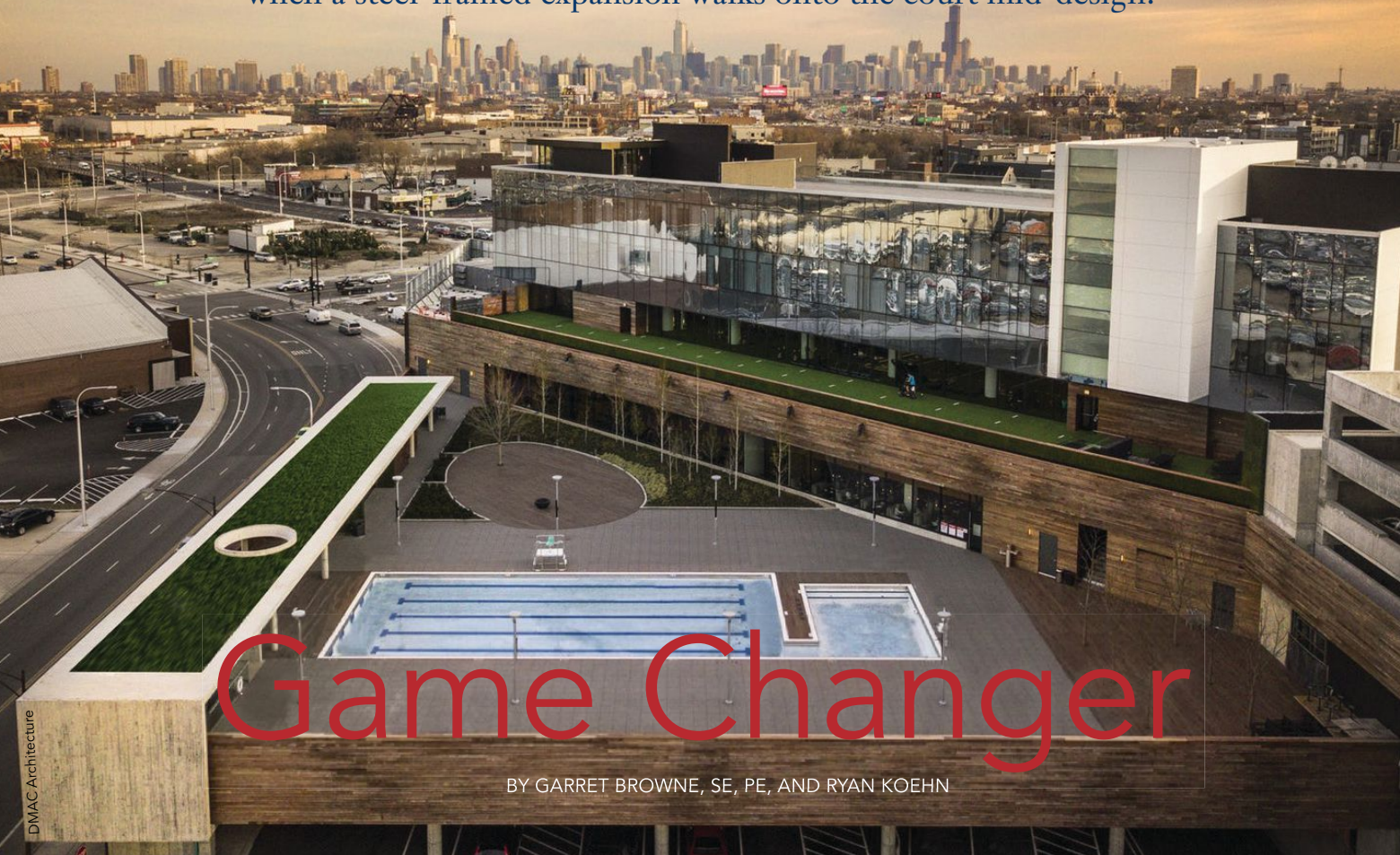

Game Changer

BY GARRET BROWNE, SE, PE, AND RYAN KOEHN

DMAC Architecture



Garret Browne (gbrowne@rockystructures.com) is a principal and **Ryan Koehn** (rkoehn@rockystructures.com) is a project engineer, both with Rocky Structures, LLC, in Chicago.

TENNIS, ANYONE?

How about a fully renovated gym? New indoor and outdoor pools? A restaurant? And perhaps a high-end hotel?

Chicago's Midtown Athletic Club, which had originally primarily served as an indoor tennis facility, with typical gym functions as a secondary component, was recently bolstered to include all of the above thanks to a \$75 million renovation and expansion project that adds 150,000 sq. ft. of space.

Initially, the intent of the expansion was purely to enhance typical athletic club functions, such as the gym, classrooms, and pool, as well as spruce up the landscaping. But during the foundation permit submittal phase of the project, the owner elected to double down (or rather, up) and add a two-story, 55-room hotel above the two-story fitness volume. The new hotel and club areas sit adjacent to the club's vast existing indoor tennis court building.

The entire former clubhouse, locker rooms, and fitness areas were demolished except for a ground-level electrical service room. The initial schematic design for the rebuilt club was composed of only the fitness and spa facilities, and when the hotel was added the goal was to minimize design changes at the lower levels—and many of the column locations for the existing building were kept in place so that the lower portion didn't require a complete structural overhaul.

On the first level, new areas consist of clubhouse functions including daycare space, a front desk, and back-of-house services, a tennis pro shop, spas, and locker rooms. Level 2 has open fitness areas, group fitness studios, and a full restaurant and bar, and level 3 houses a boxing studio, an open weightlifting and fitness area, and a sun deck. Levels 4 and 5 hold the hotel rooms, with level 6 serving as a large roof deck and penthouse.

opposite page: The design for Chicago's Midtown Athletic Club was updated to include a steel-framed hotel portion.

below: The new structure is adjacent to an existing parking structure and indoor tennis court building.



Guest usage patterns, long-term expansion plans, and planning and coordination with the Chicago Department of Transportation all had to be accounted for from the start. The mixed-use nature of the architectural program came with different demands for performance, serviceability, and detailing for the various types of spaces—e.g., the fitness areas required stiff floors and the group exercise rooms required long, open spans, with 38-ft by 27-ft, 4-in. spans being typical for the steel bays. The revamped health club aimed to change the game for resorts and fitness facilities in Chicago, and designing an innovative program on the unique site provided several challenges to be met when it came to the structural system.

The structural framing for the health club and hotel is steel (approximately 600 tons in all), with an adjacent outdoor landscaped pool deck using concrete. Steel provided crucial benefits in addressing sequencing, schedule constraints, and overall feasibility—especially in a project that integrated a new addition with an existing facility—all while keeping kept the tennis courts, along with some relocated fitness equipment and temporary locker rooms, operational.

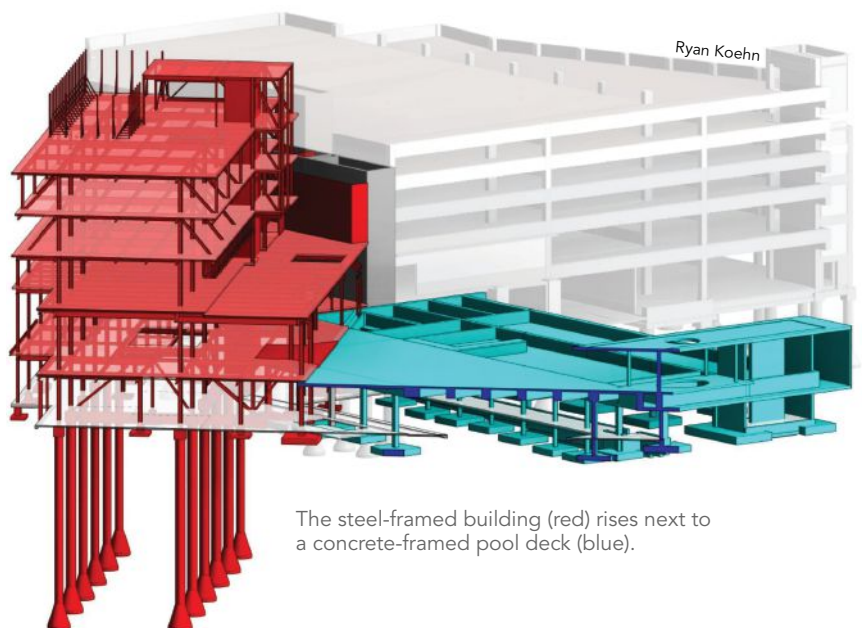

The steel-framed building (red) rises next to a concrete-framed pool deck (blue).



Ryan Koehn

The original tennis building (at left in photo) remained while the rest of the facility is completely new. The project used approximately 600 tons of structural steel in all.

.....

The building's location was, up until recently, both a blessing and a curse. It sits on a triangular parcel of land at what was a prominent but dreaded six-way intersection on Chicago's North Side—one of the city's most notorious in terms of delays. Luckily, that intersection has recently been improved, with the northwest-southeast street being transformed into a bypass that brings the intersection down to four ways.

As a matter of fact, both the club and the intersection achieved their improvements nearly simultaneously. The intersection overhaul took place in the early stages of construction for the Midtown Athletic Club, thus limiting access to the east edge of the site. Steel erection started off the east end of the site to allow completion of the intersection work. Bays of steel were erected to full height in approximately one-third of the total design length (the south face, the building's longest, is nearly 400 ft long) as this allowed the crane staging to work its way out of the corner of the site. The repetitive scheme of two main steel column lines with overhanging floor framing at the upper levels was assembled



A regular bay spacing of approximately 27 ft accommodates the compartmentalized spacing of the hotel rooms.

.....

quickly on the site. This took place concurrently with the forming of the cast-in-place concrete for the roof deck/outdoor pool, with the east end being finished up last. In addition, a portion of the roof deck was constructed last in order to leave access for the completion of the steel erection.

Design considerations for the steel framing included a regular bay spacing of approximately 27 ft to accommodate the open plan programming of the fitness areas as well as the compartmentalized spacing of the hotel rooms above. An existing high-voltage electrical room at ground level was required to remain, but it blatantly disrupted the regular grid spacing. To solve this irregularity, a 7-ft-deep steel truss spans 37 ft, 4 in. to transfer all four of the above levels over the electrical room.

The lateral system of the tall, broad hotel and fitness volume is accomplished with steel braced frames. In the early stages of design, the stair core of the adjacent concrete parking structure (built in an earlier phase) was coordinated to take some lateral loads from the smaller



The leading software package for designing and rating curved and straight steel girder bridges.

Used by Many State DOTs and Top Design Firms

(573) 446-3221 ■ www.mdxsoftware.com ■ info@mdxsoftware.com

two-story schematic design. After the scope was expanded to include the hotel, an entirely new lateral system was required since the additional lateral force from the taller building was too great for the previously coordinated loads on the as-built stair core. The steel bracing, using various chevron geometries, is able to achieve the required resistance and stiffness without the concrete stair core.

Cantilevers expand the floor plates of the upper floors beyond the two main column lines, facilitating the required space without adding more column rows. The cantilevers were made with the

diagonal hanging members, which were aligned with the room layouts, allowing for an efficient steel design without compromising the interior spaces.

In addition, the demand for open spaces in the main fitness levels combined with the dynamic loading of even more fitness programming above created the potential for floor vibration concerns. When designing the floor framing for these areas, the team looked to AISC Design Guide 11: *Vibrations of Steel-Framed Structural Systems Due to Human Activity* (available at www.aisc.org/dg). Accounting for aerobic rhythms, beam and girder sizes for the long-span areas were

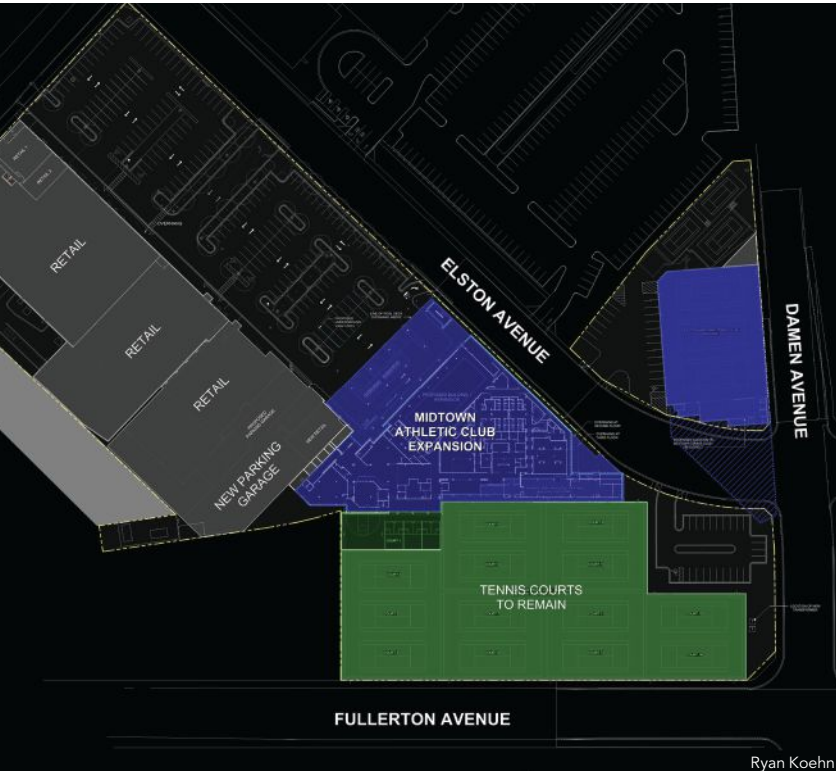

Ryan Koehn



above: The club sits on a triangular parcel of land at a busy intersection.

below: A 7-ft-deep truss transfers the upper building levels above an existing high-voltage room at ground level.

above and below: Exercise and amenity areas required long, open spans, and typical bays are 38 ft by 27 ft, 4 in.



Ryan Koehn

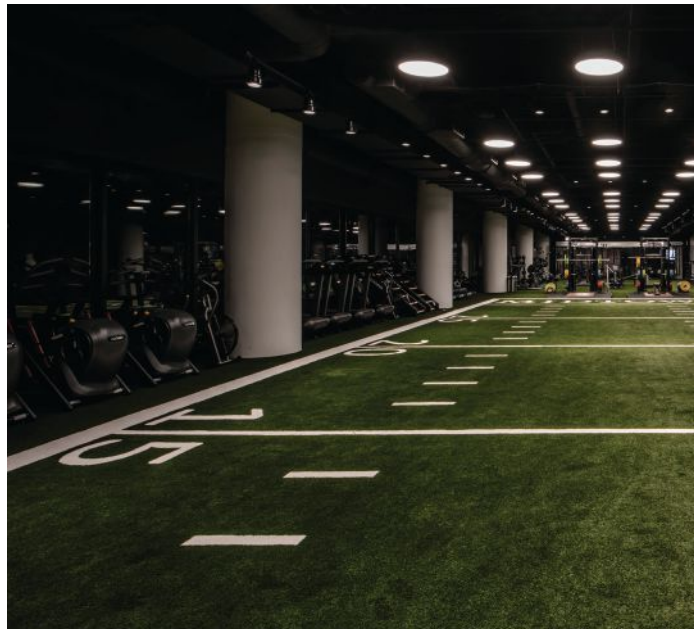

selected to keep vibrations within an acceptable frequency, and the typical sizes were W24×76, with typical girder sizes being W33×116 and typical columns being W14×90.

What started as a fitness club overhaul bulked up to become an athletic destination, complete with a luxury hotel. With the building permit already approved, this change challenged the initial structural system—initially a predominantly concrete design with a steel roof—which was adapted to become a steel structure with caisson foundations. Steel not only made for a better project but was, in fact, what made a better project possible in the first place. ■

Owner

Midtown Athletic Clubs, Chicago

General Contractor

Norcon, Inc., Chicago

Architect

DMAC Architecture, Chicago

Structural Engineer

Rockey Structures, LLC, Chicago

Steel Fabricator and Detailer

Scott Steel Services, Crown Point, Ind.



Anthony Tahlier



Anthony Tahlier

Trimble

Design, Fabricate and Erect Steel Structures on Time and Budget

Tekla Structures and FabSuite are powerful and flexible software for steel fabricators and detailers. The model-based fabrication workflow benefits your whole operations.

Join our webinars to learn more on latest software improvements and truly connected steel fabrication process.

 **Tekla 2019** Sneak Preview Webinar
www.tekla.com/us/about/webinar



TRULY CONSTRUCTIBLE.





Penn State's new steel-framed Chemical and Biomedical Engineering Building provides an education on vibration, collaboration, and structural system optimization.

Karen Jordan, Baker, Ingram and Associates

Common Ground

BY LARRY BAKER, PE, AND BRAD KIRKHAM, PE

ENHANCING THE NATURAL RELATIONSHIP between Penn State students and professors in the natural sciences, namely chemical and biomedical engineering, was the goal for the school's new Chemical and Biomedical Engineering Building (CBEB).

The six-story, 194,500-sq.-ft. steel-framed facility was built on the site of Fenske Labs, the former home of the School of Chemical Engineering, and houses classrooms, a lecture hall, student commons areas, and shared laboratory suites that support and facilitate research clusters.

Architecture and Bay Size

Many factors contribute to the architecture of every building. The shape of CBEB, however, was greatly influenced by the location of prized specimen trees along the greenway just north of the site. The architect, HOK, skillfully created a noticeably aesthetic building that not

only avoids interfering with the trees but also gives CBEB a strong identity on campus.

The façade that faces the heritage trees consists of a floor-to-floor glass curtain wall that is supported on steel spandrels at each floor and “fans” out on successive floors. The main entrance is identified by a double-cantilevered floor over the recessed storefront entrance.

As the building must stand the test of time and adapt to the changing research and education environment, finding the optimum bay size was critical. The design team of HOK and structural engineer Baker, Ingram and Associates initiated a bay size study, and the right size was ultimately determined, allowing the desired lab benches to fit neatly between columns. The final lab area bays are 31 ft, 6 in. × 21 ft with a 31-ft, 6-in. × 12-ft, 6-in. bay in between that serves as a “ghost” corridor, a corridor without walls and using shallow framing to allow space for utilities that serve the labs on each side.

opposite page and below: The building's shape was influenced by the location of prized specimen trees along the greenway just north of the site, and HOK's goal was to create a building that both avoided interfering with the trees yet projected a strong identity on PSU's campus.



Karen Jordan, Baker, Ingram and Associates

Vibration Criteria

The typical floor plan is composed of two primary function areas: laboratories and offices. Both areas require the floors adhere to a certain vibration criteria, and both were designed in accordance with AISC Design Guide 11: *Vibration of Steel-Framed Structural Systems Due to Human Activity* (www.aisc.org/dg). In accordance with Chapter 4, the offices were analyzed to achieve a maximum floor acceleration of 0.5% of the acceleration of gravity, and in most cases the composite beam designs (typical beams are W16x31 and typical columns are W12x72) required to meet the gravity loading also met the vibration criteria. Structural bays with longer-span beams were slightly upsized to accommodate a 35-ft span instead of the typical 31-ft, 6-in. span to achieve the desired vibration performance.

Laboratories were designed to meet or exceed a vibration of 2,000 μ -in./sec. in accordance with Chapter 6 of Design Guide 11 as well as the proprietary analysis of vibration consultant Colin Gordon Associates. The laboratories were analyzed based upon an occupant weighing 185 lb walking at a pace of 85 steps/minute centered on the structural bay. However, during the course of design the team was able to reduce the criteria to 4,000 μ -in./sec. by mapping the actual vibration of the floor. The influence of the ghost corridor running down the middle of the laboratories made a significant impact of the vibration performance of the floor. The short span of the beams and girders framing the ghost corridor stiffened the floor and influenced the adjacent floor bays enough to reduce the design criteria. The revised vibration criteria allowed for a reduction of 87 tons of steel and 6 in. in steel depth while still achieving the original goal of 2,000 μ -in./sec. for most of the laboratories.

In addition, the building employs concentrically braced frames with HSS6x6 chevron braces—in the north-south and east-west directions—to resist wind and seismic forces, and the open laboratory floor plan dictated that these frames would need to use the floor beams and occur along the exterior of the building. The gross weight of the project's steel framing was 1,340 tons.



Larry Baker (lbaker@bakeringram.com) is a founding principal and **Brad Kirkham** (bkirkham@bakeringram.com) is a senior engineer, both with the Lancaster, Pa., office of Baker, Ingram and Associates.

Target-Value, Design-Assist

In order to accurately track costs and deliver the building to Penn State on budget, a target-value design approach was employed. Cluster groups were formed by building components, with each cluster comprised of key design professionals and estimators tasked with tracking the evolution of the building design, continuously estimating cost, identifying innovations, and reducing costs where possible. Through the target-value design process, the project team was able to deliver the building without any cuts to programming or reductions in building area, and do so within budget at the conclusion of construction documentation.



Karen Jordan, Baker, Ingram and Associates

above: In order to achieve HOK's design vision, a double-cantilever frame was used, with a W44 cantilevering 20 ft to support a W40 that cantilevers off of it at 90° to extend 17 ft to the corner of the prow.

A key component of the target-value design process was the engagement of a design-assist partner. Stewart-Amos Steel was engaged early in design development as the steel fabricator and took on this partnership role for the steel framing portion. Early collaboration between Baker and Stewart-Amos allowed the former to tailor the details of the steel structure to the preferences of the latter. As detailing progressed, the use of bolts, both in the shop and the field, was maximized to reduce the amount welding. Input on connection designs, moment connections, and design options allowed the steel design to be streamlined and cost-efficient. For example, in an initial meeting between the design team and Stewart-



Baker, Ingram and Associates

above: HOK designed the recessed, column-free main entrance on the northeast corner of the building, under the cantilevered "prow" of the building.

below: A detail of the prow is shown below.

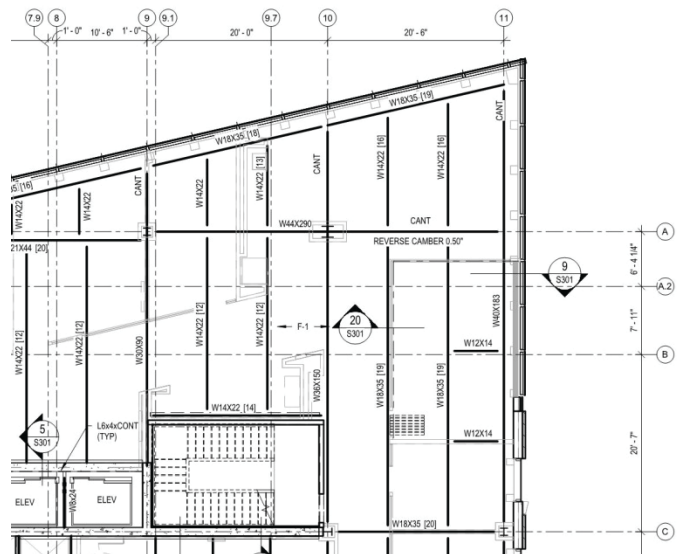

Baker, Ingram and Associates



Baker, Ingram and Associates

left: The façade that faces the heritage trees consists of a floor-to-floor glass curtain wall that is supported on steel spandrels at each floor and “fans” out on successive floors.

below: A 3D framing model of the building, which uses 1,340 tons of steel in all.

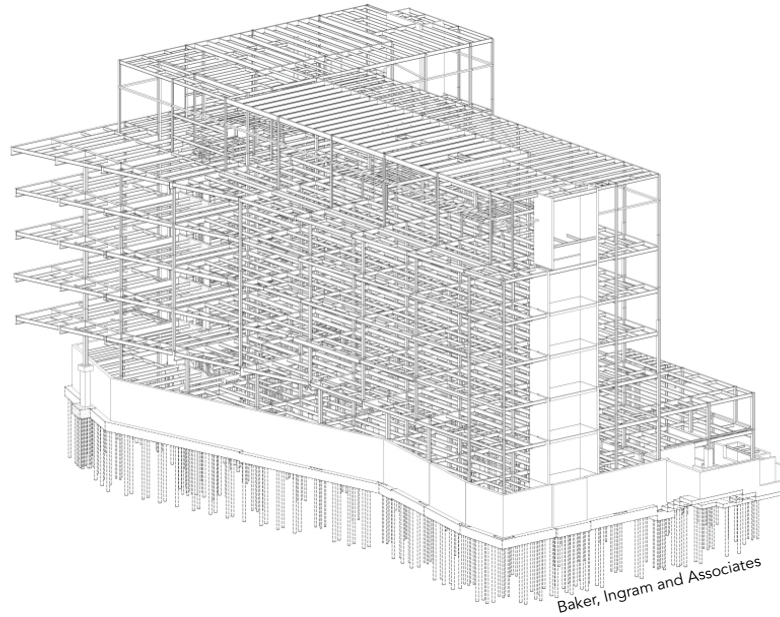

Baker, Ingram and Associates



Baker, Ingram and Associates

above: A glass panel support insert along a feathered wall.

right: A 31-ft, 6-in. × 12-ft, 6-in. bay between the lab spaces serves as a “ghost” corridor, a corridor without walls and with shallow framing, to allow space for utilities that serve the labs on each side.

.....

Amos—to review structural details and erection preferences—the majority of the focus was on the brick relief detailing and the interaction between the steel frame and the Fero brackets used to support the veneer at each level and provide a thermal break. The meeting resulted in the decision to weld short-threaded rods to the face of the slab edge bent plates, allowing the Fero brackets to be easily placed and secured by the masonry contractor.

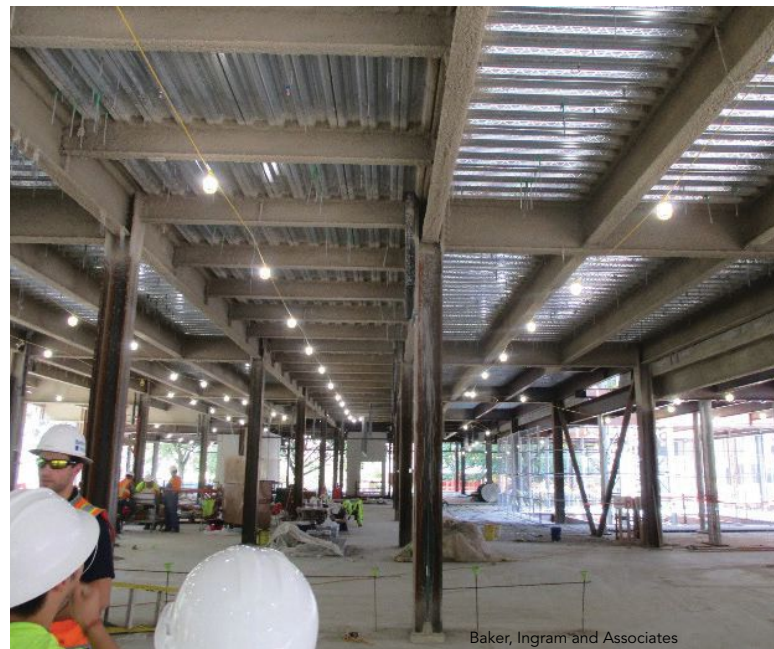

Baker, Ingram and Associates

In addition, Stewart-Amos was able to lock in the price of steel before the completion of design, then begin the shop drawing process during the design phase, allowing steel erection to begin early and condensing the critical path of construction. When it came to erection, a service alley on the south side of the building was used as the material lay-down area and was easily accessible by the tower crane since it was located on the opposite side of the building from the heritage trees.



Baker, Ingram and Associates

above: Lab spaces were designed to meet or exceed a vibration of 2,000 μ -in./sec. in accordance with AISC Design Guide 11 as well as the proprietary analysis of vibration consultant Colin Gordon Associates.

right: Exterior brick was relieved at each floor by a continuous L4x4x1/4 angle supported by a Fero bracket. The brick relief occurs along the edge-of-deck bent plate at the floor lines. However, custom cast stone jambs at the windows required the use of relief angles hung from the floor. Each cast stone jamb sits on a custom bent plate supported by two brackets connected to steel angle hangers with steel angle diagonal braces.



Baker, Ingram and Associates

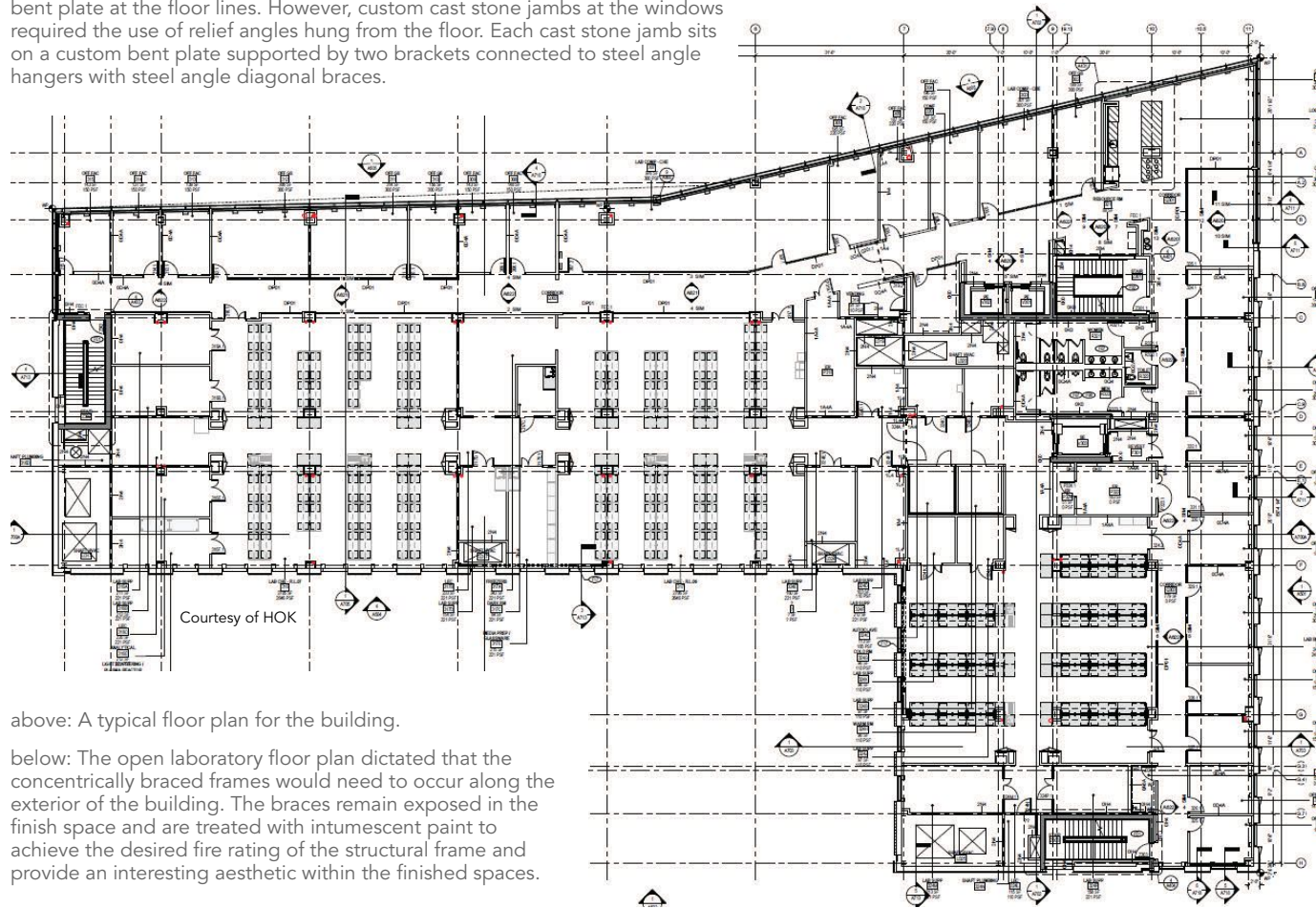

Courtesy of HOK

above: A typical floor plan for the building.

below: The open laboratory floor plan dictated that the concentrically braced frames would need to occur along the exterior of the building. The braces remain exposed in the finish space and are treated with intumescent paint to achieve the desired fire rating of the structural frame and provide an interesting aesthetic within the finished spaces.

below: The design team's bay size study resulted in a final lab area size of 31 ft, 6 in. x 21 ft.



Baker, Ingram and Associates



Baker, Ingram and Associates

The design-assist association also promoted collaboration on the steel framing and connection design over the recessed main entrance. HOK designed this immediately recognizable column-free main entrance on the northeast corner of the building, under the cantilevered "prow." In order to achieve the architect's vision, a double-cantilever frame was used, with a W44 cantilevering 20 ft to support a W40 that cantilevers off of it at 90° to extend 17 ft to the corner of the prow.

In addition, window support inserts at all floors were coordinated between the window contractor and Stewart-Amos in the Revit model. This team effort facilitated seamless installation of the glass panels with tight tolerances on all façades of the building.

Academic Enhancement

Building a structure on a college campus with a prominent structural engineering department offered an ideal opportunity to share the design process with engineering students and faculty. Students from Penn State's college of architectural engineering attended a presentation on the structural design of CBEB, then toured the building to see firsthand how the lines on paper and computer models become an attractive real-life, state-of-the-art steel-framed building.

In addition, the target-value design and design-assist approaches offered another learning experience for students, as well as a positive example of a real-world collaborative construction effort. The finished product, which opened this past spring, will no doubt be a crucial asset to Penn State in attracting new researchers, professors, and students that will share its common ground.

Owner

The Pennsylvania State University,
University Park, Pa.

Construction Manager

Barton Malow, Baltimore, Md.

Architect

HOK, New York

Structural Engineer

Baker, Ingram and Associates,
Lancaster, Pa.

Vibration and Acoustics Consultant

Colin Gordon Associates,
Brisbane, Calif.

Steel Fabricator and Detailer

Stewart-Amos, Harrisburg, Pa. 

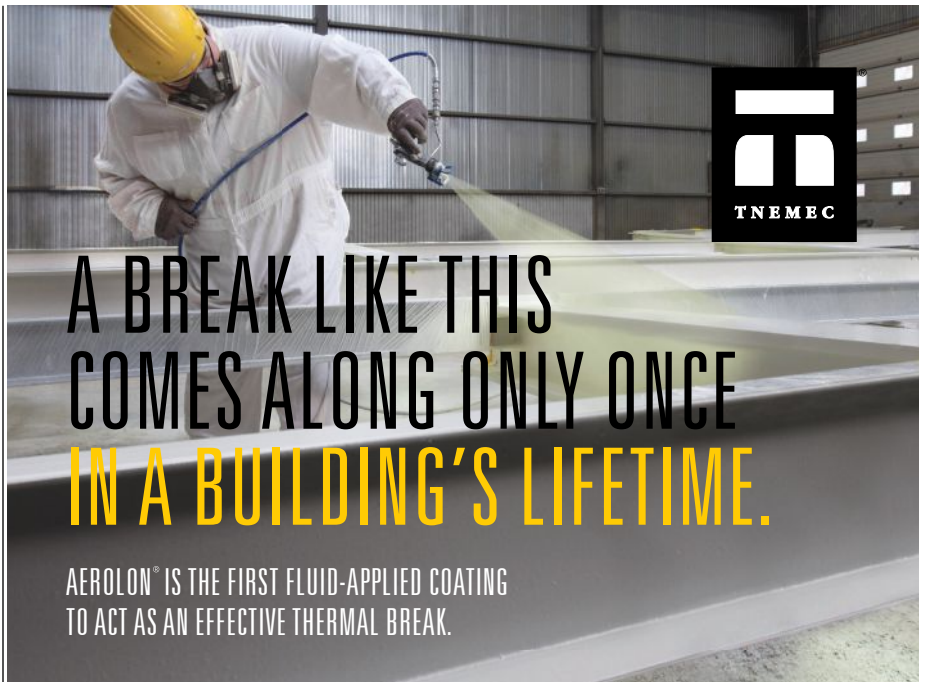

A BREAK LIKE THIS COMES ALONG ONLY ONCE IN A BUILDING'S LIFETIME.

AEROLON® IS THE FIRST FLUID-APPLIED COATING
TO ACT AS AN EFFECTIVE THERMAL BREAK.

A low VOC, water-based coating that can be easily spray-applied in the shop or in the field, Aerolon provides significant cost-saving advantages over structural thermal breaks, limiting design restrictions for architects and reducing application and labor time for contractors. **Find out more at tnelec.com/thermalbreak.**



COREBRACE® reCOREder

SELF-CONTAINED DISPLACEMENT TRANSDUCERS (SCDT)
AIDING IN POST-EARTHQUAKE RESIDUAL CAPACITY ASSESSMENT

Date and time stamp
on all recorded data
including events and
aftershocks

Internal or external
mounting of device

USB/SC
Input
and Output

Battery
and Data
Status
Indicator

10-Year Battery Life

- User replaceable
- Device sleeps between triggering events
- No data or power connections required

Internal data collection system with memory
to record and store hundreds of events

- User defined sensitivities can be adjusted to track various magnitude and frequency of events

Contact CoreBrace at:

5789 West Wells Park Road
West Jordan, UT 84081
801.280.0701
www.corebrace.com
info@corebrace.com

A steel-framed, egg-shaped theater serves as the beating heart of an updated arts-based high school in D.C.



Chris Ambridge (cambridge@cgsarchitects.com) is an associate principal with cg+s architects and **Bill Yun** (byun@yunassociates.com), formerly with ReStl Designers, is founder and principal of Yun Associates.

FAMED BIG BAND LEADER Duke Ellington was one of a kind—and so is his namesake school.

Established in 1974, the Duke Ellington School of the Arts is the only institution of its kind in Ellington’s hometown of Washington, D.C., to provide pre-professional training in the visual and performing arts for high school students. However, the public school, located just north of Georgetown University, has long struggled with the constraints of largely ill-suited historic buildings, particularly its outmoded auditorium. But a recent modernization effort was implemented to address the school’s significant program needs, update it to the standards of today’s students, and meet its aspirations to create a facility worthy of its national reputation—as well as achieve a LEED Gold rating.

The primary design move was to organize the 265,000 sq.-ft building around a central light-filled atrium and suspend a new state-of-the-art steel-framed egg-shaped theater in the middle as the metaphorical beating heart of the school. An agreement was reached with local historical review agencies and the community to retain and restore the National Landmarked front and back buildings, which dated back to the 1890s, while also removing subsequent outdated additions in the middle to allow for the extensive big box rehearsal and performance spaces required by the school.

The existing front building was constructed with cinder concrete on terracotta blocks supported by steel beams on masonry bearing walls. Due to program requirements, many of these bearing walls were partially or completely removed and replaced with new steel framing. Two new steel-framed stories were added to the back building by locating new columns in the existing shaft walls. By doing so, the loads in the existing columns and footings were not increased and thus avoided the need to reinforce the existing structural elements. The resulting building derives interest through the juxtaposition of old and new: Academic classrooms use the existing spaces of the classical structure at the front of the facility, and arts spaces occupy the new middle and rear sections, clustered by department on three sides of the atrium.

Heart and Soul

The theater, the focal point of the building, was both the most important architectural element and the most challenging to design and construct. While the theater is shaped like an egg, its steel framing actually does not form a closed loop because the structure is comprised of three distinctive, gradually expanding sections or “shells” and penetrates a steel-framed skylight that covers the entire central atrium. The theater is also accessed on three sides by multiple steel-supported catwalks that span the atrium at various levels, and the design team consulted AISC Design Guide 11: *Vibration of Steel-Framed Structural Systems Due to Human Activity* (www.aisc.org/dg) to address vibrations from foot traffic. Furthermore, the theater’s centers of mass and rigidity are far

.....
opposite page and right: The 265,000-sq.-ft building is organized around a central light-filled atrium with a new state-of-the-art steel-framed theater in the middle.

below: The building’s lobby, looking into the atrium, during construction and completed.



© Christopher Ambridge



© Christopher Ambridge

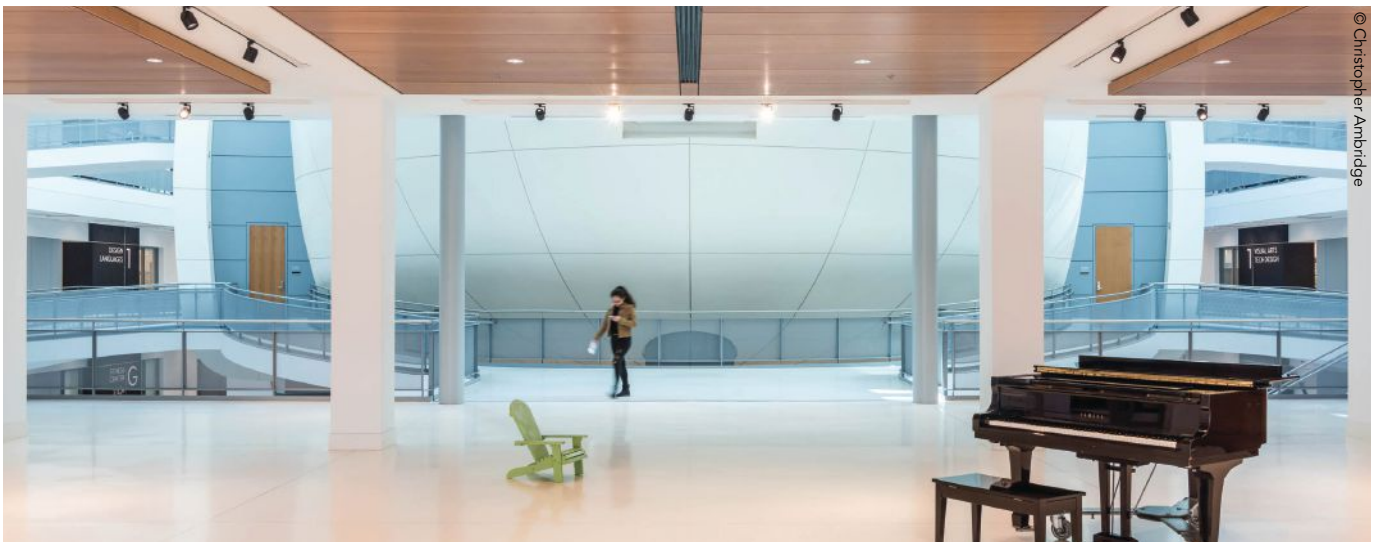

© Christopher Ambridge



© Christopher Ambridge

The school's classic design dates back to the 1890s. This aesthetic is maintained at the front of the building (above). However, the new steel-framed addition is much more apparent at the sides and back (below).



© Christopher Ambridge



© Christopher Ambridge

apart—closer to the back and closer to the center, respectively—thus accentuating the effect of seismic forces.

The main structural support for the egg-shaped theater consists of five concrete-encased steel columns that rest on the atrium floor. The original theater concept was supported on three columns, but the design team eventually determined that increasing the number of columns to five would significantly reduce costs and member sizes (the original members were box-shaped, built-up members as large as 36 in. by 20 in. by 1.5 in, and the new design incorporates wide-flange members). At the theater's platform level (at the base) deep wide-flange girders are moment connected to the columns and support a series of beams, spaced approximately 12 ft on center, spanning the width of the theater in the transverse direction. These beams cantilever out from the girders and columns and each supports a segmented wall. The design of the faceted steel wall columns was optimized to fit within the wall profiles, and the tops of these columns at the terrace level above the theater are moment connected to a series of steel beams that span the width of the theater. Bracing between the wall columns at strategic bays serves as the lateral system in the longitudinal direction. Directly below the terrace, steel ring bracing engages the discrete wall braces and ensures that the lateral system elements work as a cohesive unit. The wall braces are placed in the segmented plane of wall columns as much as possible, and the forces are transferred down to the theater platform diaphragm. Framing at the platform level is connected to the theater stage walls to help dissipate the lateral loads.

The complexity of this design-build project, particularly the theater, demanded close collaboration and teamwork from the outset, and the project was fully developed in a 3D model environment (ArchiCAD) with IFC model exchange between collaborators throughout the process. During the design phase, the architect (a joint venture between Lance Bailey and Associates and cox graae + spack architects) and structural engineer ReStl Designers worked closely in the 3D model, spending many hours of meetings entering steel members into the theater model. The outer skin geometry of the theater was fixed, necessitating steel members fit within these constraints.

.....

The theater is accessible on three sides via multiple steel-supported catwalks that span the atrium at various levels.

e.g., the complex “prow” column node was worked out over multiple meetings and resolved multiple moment connections in the steel for the platform and the rear section of the theater. If you imagine the theater platform as a wedge-shaped spatula, the prow column is situated at the end of it. It supports majority of the seating framing and collects loads from the theater wall framing that

supports the theater roof. The platform girder that passes through the prow is level, whereas the two girders coming from the columns slope up at a very steep angle when they meet at the column. Complicating the connection detail even further, two main wall framing columns also come down to this joint at a different angle and elevation. Because of the complex geometry, even though a

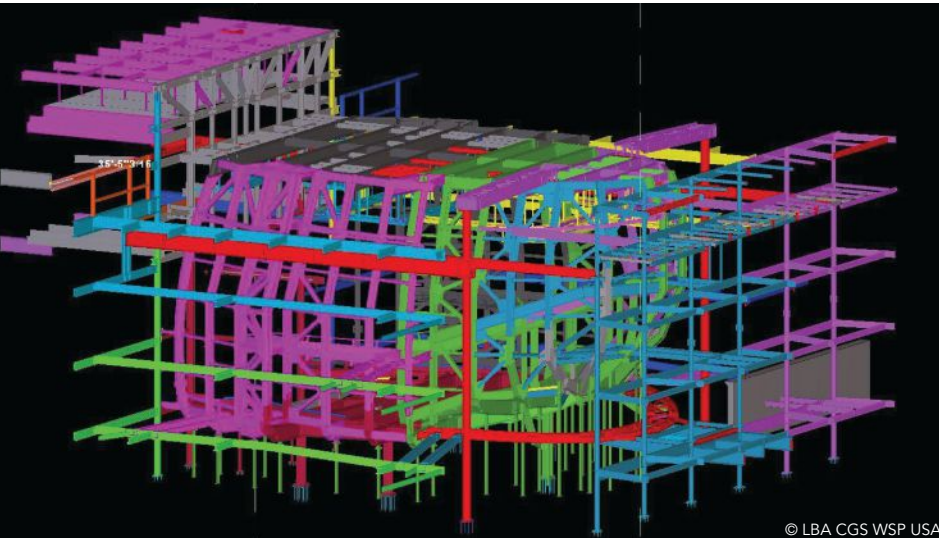

above: A Tekla model of the theater’s steel framing, with the various colors indicating different steel sequences.

below: The complexity of the project, particularly the theater, demanded close collaboration from the outset, and the project was fully developed in a 3D model environment, with IFC model data being exchanged between team members throughout the process.



© Christopher Ambridge

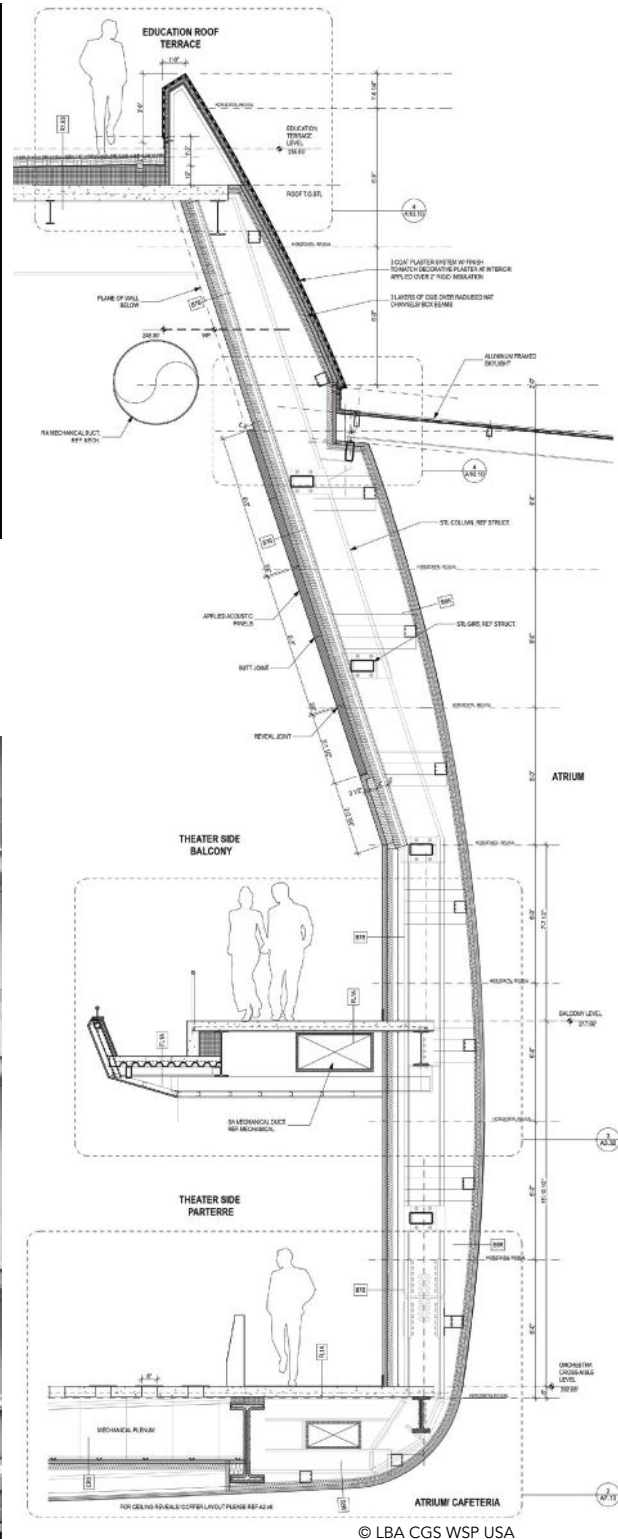

© LBA CGS WSP USA

above: A typical wall section of the theater.

Steel framing for the theater, the “beating heart” of the facility.

.....

welded connection could theoretically work, there was no access to make some of the welds. Eventually, the team came up with steel plates as thick as 6 in. to move the individual connections away for the congestion of the members and allow enough room to make individual connections.

Steel erection was complicated not only by the tight urban site but also by the fact that installing the theater was akin to building a ship in a bottle. Steel was delivered to the front of the building, and a crawler crane picked it over the building and placed it into the atrium. Once structural steel for the theater was in place, the framing was scanned using point cloud technology to establish a model for the theater’s façade team to work from. Multiple layers of gypsum wall board were applied over a light-gauge steel framing system attached to the main structural system, and the final finish was a hand-applied decorative plaster for the theater’s exterior inside the atrium and an exterior insulated finish system (EIFS) on the portion of the theater that projects through the skylight.

Despite the complex arrangement, the Duke Ellington School of the Arts renovation project came together like a fine-tuned, well-rehearsed jazz number. The modernized space will provide future generations of performing arts students with an updated, up-tempo learning space with a swinging steel theater at the center. ■

Owner
DC Department of General Services,
Washington, D.C.

General Contractor
GCS/SIGAL, LLC, Washington

Architect
LBA-CGS Joint Venture (Lance Bailey
and Associates-cox graae + spack
architects), Washington

Structural Engineer
ReStl Designers, Inc. Washington

Steel Team

Fabricator

Banker Steel Company, 
Lynchburg, Va.

Erector

L. R. Willson and Sons, Inc., 
Gambrills, Md.

Bender-Roller

Chicago Metal Rolled Products, 
Chicago



© Christopher Ambridge



Automated Layout of Stairs and Railings in a Fraction of the Time

The Lightning Rail is the first automated marking machine created specifically for the layout of stairs and handrails, but can be used for so much more. Forget about the countless hours spent with tape measures, squares and soapstone. The compact design will fit easily into your existing fabrication environment. Tables are offered in 4-ft and 8-ft widths with a length just under 30 ft.

➤ Cut Fabrication Time by
More Than 50%

➤ Ensure the Highest Level
of Accuracy

➤ Boost Your Profit Margins!



The maker of the Lightning Rail — the first automated marking machine
created specifically for the layout of stair stringers and railings.

603-402-3055 | SALES@AUTOMATEDLAYOUT.COM

TO LEARN MORE ABOUT THE LIGHTNING RAIL VISIT, AUTOMATEDLAYOUT.COM

A century-old service station becomes a steel-framed TV studio thanks in part to a creative column configuration and a fresh façade.

A Studio Grows in Brooklyn

BY MARCO SHMERYKOWSKY, PE

Cuppek Photography



Marco Shmerykowsky
(marco@sce-engineers.com) is
a principal with Shmerykowsky
Consulting Engineers in New York.

BROOKLYN IS WHERE IT'S AT.

Once the target of scorn from well-heeled Manhattanites, Brooklyn has established itself as the international capital of “cool.”

Whether you're looking for an organic, small-batch IPA, a cassette single from a band that's about to be moderately famous or a pop-up restaurant that serves \$50 artisanal chicken nuggets, Brooklyn is where members of today's creative class ply their trades. And if you're a media company looking to stay relevant in a rapidly changing entertainment landscape, there's no better place to be. For one such company, a four-story 1920s building, originally a Studebaker service station, in the borough's Crown Heights neighborhood proved to be an ideal location. But of course, such a building needed extensive renovation to become a 21st century television studio space.

Shmerykowsky Consulting Engineers was brought in to handle the structural design as well as to solve some of the inevitable challenges that crop up when retrofitting a nearly century-old building. The plan was to divide the building into three areas: one in the north for storage, one in the south for offices and, in between, a studio. For the studio space, the client had its eyes on a sizable one-story garage area measuring approximately 88 ft by 82 ft in plan. The garage met the basic criteria for a television studio: a large, column-free space with high ceilings (the top of the roof slab is approximately 19 ft above the ground floor slab, slightly higher than the original elevation). However, the structural team soon discovered that essential supporting features like ceiling lighting grids, new air handling units and acoustical walls would require several upgrades to the building. The existing structure was analyzed with a RAM structural model, using field measurements and observations of the existing framing and conditions. The analysis showed that the original roof structure did not have the reserve capacity to support the heavier superimposed loads of the new studio equipment.

opposite page: The studio space measures approximately 88 ft by 82 ft.

right: A structural analysis showed that the original roof structure did not have the reserve capacity to support the heavier superimposed loads of the new studio equipment, so a new steel roof was constructed.

After considering a variety of approaches, the design team determined that the best plan was to completely alter the space, adding a new steel column grid and an updated ceiling system. In the end, the only portions of the structure that would be retained were the existing southern and western CMU façade walls and their respective footing systems; everything else would go. In addition, following the geotechnical engineers' subsurface investigation, it was recommended that the new columns would be supported on the undisturbed soil of the glacial till stratum, thus providing an allowable bearing pressure of 4 tons per sq. ft.

New Column Lines

The new column layout accommodates an acoustically isolated television studio with plan dimensions of approximately 54 ft by 63 ft, 3 in. In order to maximize the studio space, the westernmost column line was placed within 2 ft of the property line. However, the design team realized that supporting these columns would be tricky, as an existing building was immediately adjacent to this column line. Since this neighboring building contained a cellar level, the engineers knew that its foundations, along with the foundations of the existing western CMU wall, would be located well below grade, and subsurface investigations confirmed this. As a result, the new footings would need to be extended down to the level of the existing foundation elements nearby.

Unfortunately, the location of the new steel columns and their corresponding structural loads meant that going with square concentric footings wouldn't be feasible. Instead, the structural team decided to build new spread footings at the level of the adjacent existing foundation elements. New concrete piers were built, beginning at the footings and reaching up to within approximately 4 ft of the finished grade, then a concrete strap beam was added, cantilevering out from one of the new interior steel columns to the face of the existing exterior CMU wall. This cantilevered strap beam provided a support point on which the new columns could bear.



above: The studio resides in a one-story portion of a 1920s-era four-story building that originally served as a Studebaker service station.

below: A framing model for the one-story portion.

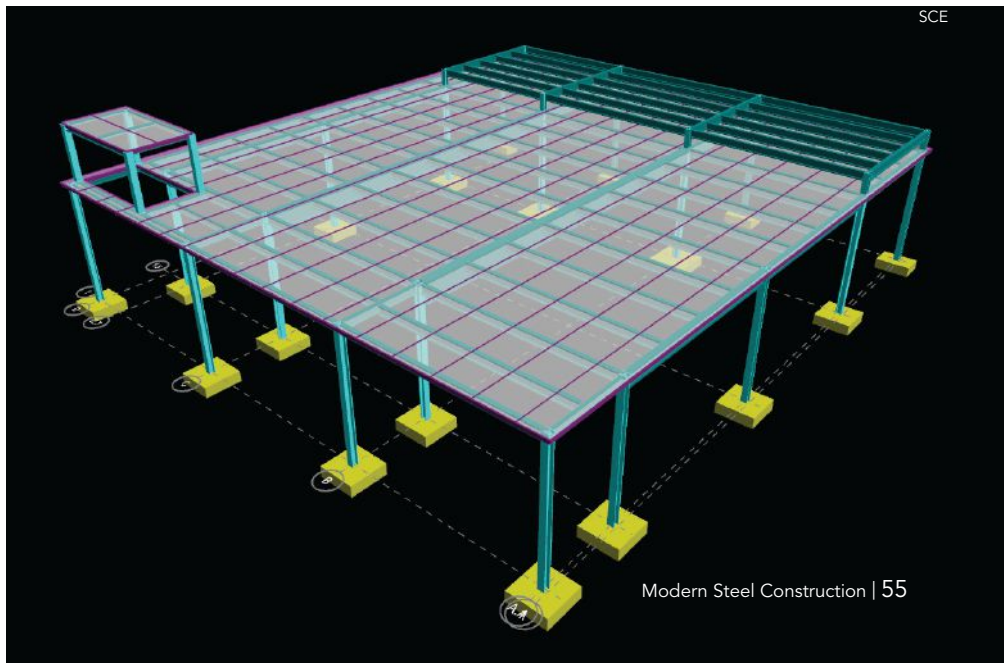

The east side of the garage provided its own challenges. As the garage was originally connected to the rest of the building, there wasn't much need to create a separate exterior wall. Accordingly, the original column line was located a fair distance away from the building's exterior wall. The design team employed a similar strategy to what was implemented on the west side, placing the new columns 5 ft to the west of the wall. But in this case, the column line offset facilitated concentrically loaded footings, which eliminated the need for eccentric footings or strap beams.

Another challenge was the garage space's independent lateral load-resisting system—specifically, the fact that it originally didn't have one. The team introduced a new lateral load-resisting system consisting of chevron braces (HSS6×6× $\frac{5}{16}$ brace elements and W24×76 girders), with one chevron brace being added to each face of the main studio area. To support these new braces, the team designed a spread footing system, above which concrete piers would connect to the columns of each chevron brace. However, since the spread footings needed to be placed at an elevation a few feet below the slab on grade, a concrete grade beam was added to

connect the piers. Following standard practice, the lateral loads were evaluated for both wind loading and seismic loading as per the New York City building code.

To the Roof!

With the new ground-level structure taken care of, the team moved on to the roof. To frame the new roof structure, the engineers designed a system that would cantilever eastward from the new column line to the face of the service station's exterior wall. The roof structure was made up of new W14×34 ASTM A992 members spaced at approximately 6 ft on center, supporting a new $\frac{3}{4}$ -in. lightweight concrete slab on 2-in.-deep galvanized composite metal deck. At the south end of the structure, the building columns were extended approximately 4 ft above the roof level to allow for the creation of a large dunnage platform. The new dunnage platform itself was framed with galvanized W14×38 beams and W16×36 girders, creating a plan area of approximately 76 ft, 6 in. by 21 ft, 6 in. for the placement of the new mechanical equipment. The platform



above: The roof structure was made up of new W14×34 ASTM A992 members supporting a new $\frac{3}{4}$ -in. lightweight concrete slab on 2-in.-deep galvanized composite metal deck.

right: The new column layout accommodates an acoustically isolated television studio with plan dimensions of approximately 54 ft by 63 ft, 3 in.

below: The engineering team introduced a new lateral load-resisting system consisting of chevron braces, with one chevron brace being added to each face of the main studio area.



“floor” was constructed of galvanized metal grating secured with mechanical fasteners.

The engineering team’s final consideration for this project involved the exterior wall facing the street. The original plan called for saving and reusing the existing wall in the final design. But as the project moved forward, it became apparent that with the modifications to the building’s entrances and the increase in height between grade and the roof level, it would be more cost-effective to construct a new façade. A key aspect of the new façade consisted of two large barn door-type sliding assemblies whose centerlines would be offset from the centerline of the building columns and the supporting steel. One door would be offset to the exterior and the second door would be offset to the interior. The support structure was designed to take advantage of the torsional properties of a HSS16×8 tube spanning between exterior columns. These hollow structural sections (HSS) were then moment connected to the new exterior building columns. Two additional barn door sliding assemblies were installed about 12 ft in from the façade leading into the studio space.

right: The new dunnage platform on the roof was framed with galvanized W14×38 beams and W16×36 girders, creating a plan area of approximately 76 ft, 6 in. by 21 ft, 6 in. for the placement of the new mechanical equipment.

below: A sample bracing detail.

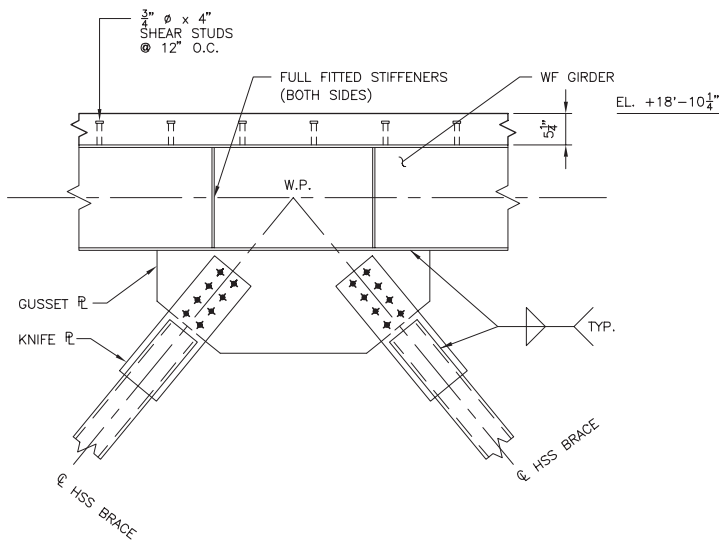

By devising a new column layout, lateral load-resisting system, and façade, the structural team was able to transform a nearly century-old structure into a state-of-the-art television studio, with a Manhattan-based engineering firm displaying some of the creativity and design chops for which the residents of Brooklyn have become famous. Most importantly, this new space gives its tenant a foothold in Brooklyn and will put the company in closer contact with the artists, designers, and directors who are forging the future of media.

And hey, it’s adaptive reuse. What’s more Brooklyn than that? ■

General Contractor

Talisen Construction Corp., New York

Architect

Meridian Design Associates Architects, PC, New York

Structural Engineer

Shmerkowsky Consulting Engineers, New York

Steel Fabricator and Erector

Babylon Iron Works, Inc., West Babylon, N.Y. 



above and left: The braces are supported by a spread footing system, above which concrete piers connect to the columns of each chevron brace.

An Accurate Declaration

BY LUKE JOHNSON, SE, PE

For steel projects with green goals, environmental product declarations provide a third party-verified breakdown of various steel products' impacts on the earth.



Luke Johnson (johnson@aisc.org) is a senior advisor with AISC's Steel Solutions Center.

EACH YEAR, more and more architects, engineers, building owners, and anyone involved in the construction industry look for ways to create more sustainable and environmentally friendly buildings.

These structures provide not only an immediate reduction in environmental impacts—e.g., in terms of greenhouse gas emissions—but also long-term sustainable and safe structures for occupants to live, work, and play in.

While the USGBC's (United States Green Building Council) LEED (Leadership in Energy and Environmental Design) rating system is now well-established and terms like resiliency, net-zero, and green continue to be thrown around, designers increasingly want to be assured that the products—structural and otherwise—that they specify are indeed sustainable—or more specifically, they want to know *how* sustainable they are, since environmental friendliness is not a checkbox but rather a spectrum. They want to know a product's or material's *measurable* environmental impact.

EPDs and Steel

A key tool for measuring a building material's environmental impacts is an environmental product declaration (EPD). By definition, an EPD is an independently verified and registered document that communicates transparent and comparable information about the life-cycle environmental impact of a product. In more simple terms, think of an EPD as a nutritional label, stating what a product is made of and how it impacts the environment across its entire life cycle, from raw material extraction to disposal. When designers, contractors, and owners have a better understanding of the impact each material has on their specific building through vehicles like EPDs, they can make the best choices achieve whatever sustainability goals they have for their buildings.

With an EPD containing such important information, its creation must be regulated to ensure that one is getting a vetted, accurate apples-to-apples comparison of products. When EPDs are created, they must follow the guidelines and requirements of a product category rule (PCR). (The current PCR regulating structural steel is the "North American Product Category Rule for Designated Steel Construction Products.") In addition, all EPDs must follow the requirements and guidelines of an International Organization for Standardization (ISO) standard; the structural steel industry average EPD is governed by ISO 14044. Note that the industry-average approach versus a company-by-company



approach is taken for structural materials like steel, as there are several steps in the structural steel supply chain and thousands of domestic steel fabricators, each with their own process and environmental impacts.

The Stages of Life

In looking at any construction product, you can break down its life span into four life-cycle stages, as shown in Table 1, along with one additional “Benefits and Loads” impact at the end of its life, which includes items such as reuse, recovery, and recycling potential. Per the requirements of the current PCR, the industry-average EPDs for structural steel will only include data in the “Product Stage,” which can also be referred to as “Cradle-to-Gate,” and includes three sub-stages, labeled **A1**: Raw Material Supply, **A2**: Transportation, and **A3**: Manufacturing. Here are descriptions of each stage (and see Figure 1 on the next spread for a breakdown of the various stages).

Stage A1 contains impacts from raw material extraction and processing, as well as processing of secondary material input, such as recycling processes. This includes all activities necessary for the production of structural steel, including the recovery or extraction and processing of feed-stock materials; furnace and related process operations at the melt shop; casting; and rolling into the final product. For products requiring secondary processing, all activities performed during this stage and transportation from the primary producer to the secondary producer are to be included. All upstream activities related to fuel use and/or electricity generation are also included in this stage. Therefore, most all of these impacts are seen at the steel mill level, where the hot-rolled shapes are actually created.

Documentation like AISC’s EPD for fabricated hot-rolled structural sections can help you achieve the requirements of projects working to adhere to LEED, ASHRAE 189.1, *IgCC*, or other green rating systems and standards.



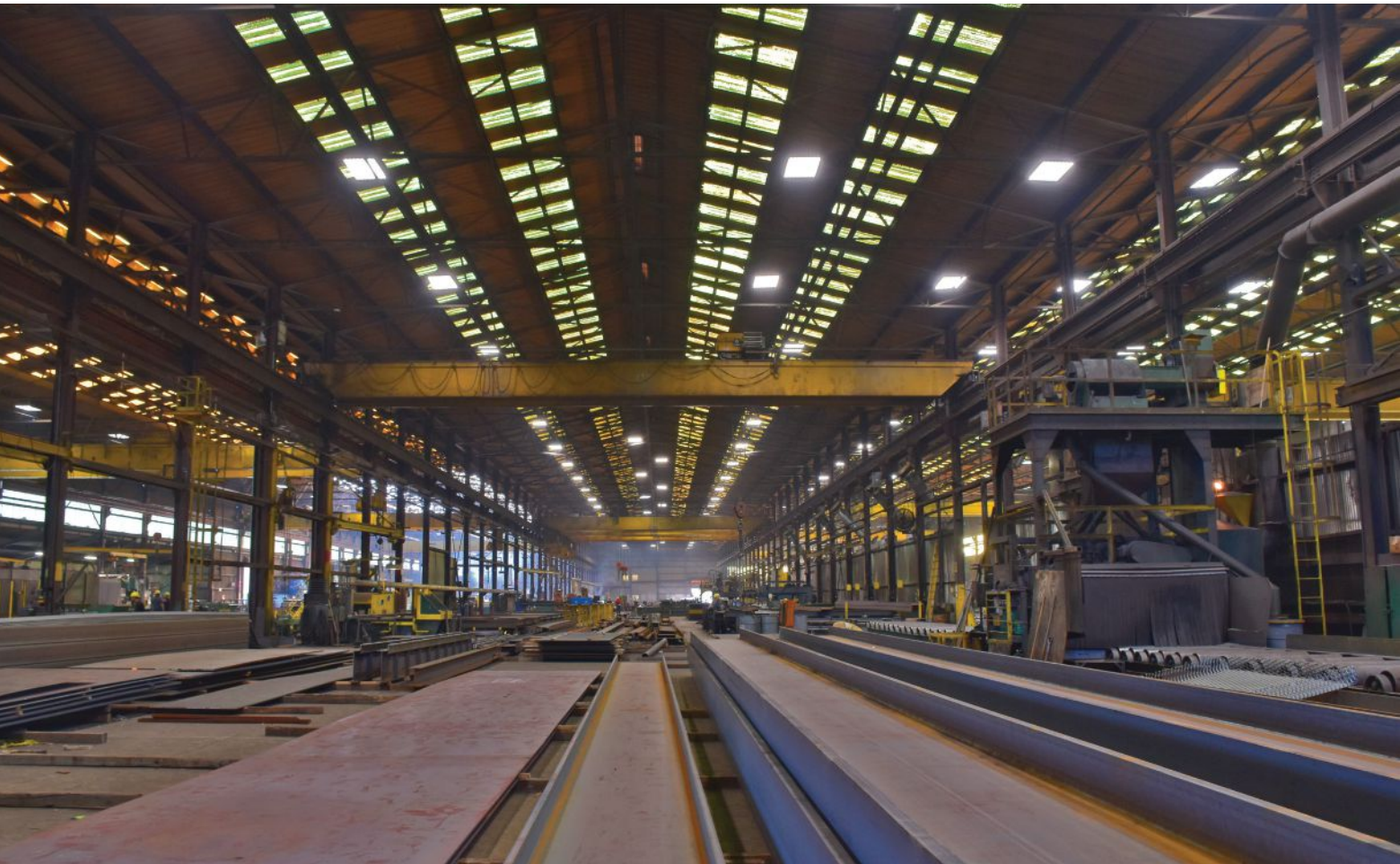

Domestically produced and fabricated structural steel boasts an industry average recycled content of 93% and a recovery rate of 98%—and steel is the most recycled material by weight on the planet. These are numbers that should certainly be considered alongside any material EPD.

.....

Stage A2 contains impacts for transportation to the “manufacturer,” or structural steel fabricator. This stage mostly contains transportation distances and modes from the mills and service centers to the fabrication facility for which materials are procured.

Stage A3 contains impacts from structural steel fabrication, which includes process materials such as welding gases and electrodes, as well as cutting supplies. Energy is also needed to perform the fabrication and move the materials, so items such as fuel and electricity consumption are required to be collected within this stage.

EPDs and Other Green Standards

In addition to using an EPD to better understand what goes into creating a specific product and how it impacts the environment, you can also use it to achieve the submission requirements on projects containing LEED, American Society of Heating, Refrigerating and Air-Conditioning Engineers (ASHRAE) 189.1: *Standard for the Design of High-Performance Green Buildings*, the ICC’s (International Code Council) *International Green Construction Code (IgCC)*, or other rating systems and standards.

Under the current LEED (v4) system, there are two credits that can be achieved using a structural steel EPD and framing system. The first is the “Building Product Disclosure and Optimization—Environmental Product Declarations” credit, which was created “To encourage the use of products and materials for which life-cycle information is available and that have environmentally, economically, and socially preferable life-cycle impacts. To reward project teams for selecting products from manufacturers who have verified improved environmental life-cycle impacts.” The second is the “Building Product Disclosure and Optimization—Sourcing of Raw

EPDs: The Next Generation (A Request for Fabricators)

EPDs, like many documents, must be periodically updated to reflect current practices, and AISC’s domestic fabricated structural steel EPDs are set to expire March 31, 2021. For the next version of our EPDs, in addition to providing updated, quantified impact values for our member mill processes, we are also required to update industry average per-ton environmental impact data from our member fabricator processes.

Once this data is collected, combined, and analyzed, AISC member fabricators will be granted access to the industry average EPD for fabricated structural steel for use as a submittal on projects. According to the current rules of the LEED program, only AISC members participating in the development of the EPD will be able to submit the EPD on LEED registered projects.

Visit www.aisc.org/epd for instructions on submitting your environmental data (from April 2019 through March 2020) and participating in the next version of our structural steel EPDs.

Materials credit,” which was created “To encourage the use of products and materials for which life cycle information is available and that have environmentally, economically, and socially preferable life cycle impacts. To reward project teams for selecting products verified to have been extracted or sourced in a responsible manner.”

For those designers, builders and owners who want an up-close look at the environmental impacts of structural steel, the EPD is a useful resource. But it’s only part of the whole story. Taking a big-picture approach, it’s important to remember that domestically produced and fabricated structural steel boasts an industry average recycled content of 93% and a recovery rate of 98%—and steel is the most recycled material by weight on the

planet. These are numbers that should certainly be considered alongside any material EPD.

For additional information on structural steel’s sustainable characteristics, visit www.aisc.org/sustainability. For information on EPDs as well as links to AISC’s current industry average EPDs for fabricated hot-rolled structural sections, steel plate, and hollow structural sections (HSS), visit www.aisc.org/epd. This page also lists AISC member producers and fabricators to which these EPDs apply. ■

Fig. 1. The various stages of a building’s life. Steel EPDs only include data from the Product Stage.

Product Stage			Construction Stage		Use Stage					End-of-Life Stage				Benefits & Loads
A1	A2	A3	A4	A5	B1	B2	B3	B4	B5	C1	C2	C3	C4	D
Raw Material Supply	Transport	Manufacturing	Transport	Installation	Use	Maintenance	Repair	Replacement	Refurbishment	Deconstruction	Transport	Waste Processing	Disposal	Reuse, Recovery, Recycling Potential



DETAILING YOU CAN TRUST!

SEEING IS BELIEVING ...

We invite you to come to **INDIA** for a visit on us see our systems meet our core team & form a strategic partnership

VISIT EVALUATE TRUST



TRANSPARENCY IS THE HALLMARK OF INTEGRITY

- 500+ Detailers, Designers, Checkers & PM’s generating 18,000+ tons/ mo.
- Offering both Structural & Misc. Steel Detailing services & Connection design
- Local Project & Client Coordinators and P.E.’s across 4 offices in the U.S.
- ISO Certified Processes, Established QA Systems & Procedures
- Competitive Pricing, NISD Certified PM’s, Effective Communication



Client’s Speak:

‘MoldTek is a true business partner as they truly align with our core values’





AWARDS

AISC Now Accepting Milek Fellowship Applications

University faculty are invited to apply for the 2020 AISC Milek Fellowship, a four-year fellowship given to a promising university faculty member to conduct structural steel research. The winning faculty member will receive \$50,000 per year (for a total of \$200,000) as well as free registration to NASCC: The Steel Conference for the four years following their selection as an AISC Milek Fellow.

The Milek Fellowship program is designed to contribute to the research careers of young faculty who teach and conduct research investigations related to structural steel, while producing research results beneficial to designers, fabricators and erectors of structural steel.

The program is also intended to support students with a high potential to be valuable contributors to the U.S. structural steel industry, and the selected faculty member is

required to fund a doctoral candidate with at least half of the fellowship money.

Recent recipients include John Judd from the University of Wyoming for his work on inelastic design methods for steel buildings subjected to wind loads; Gary Prinz from the University of Arkansas for his work on steel seismic systems with architectural flexibility; and Patricia Clayton from the University of Texas-Austin for her work on seismic performance of moment resisting frames with fuse-type systems.

Proposals will be accepted until August 31, 2019. For application information, visit www.aisc.org/milek.



This year's Milek Fellow, John Judd.

AWARDS

There's Still Time to Submit Nominations for 2020 Higgins Award

Nominations are still being accepted through July 15, 2019, for AISC's prestigious T.R. Higgins Lectureship Award, which includes a \$15,000 cash prize. Presented annually by AISC, the award recognizes a lecturer-author whose technical paper(s) are considered an outstanding contribution to engineering literature on fabricated structural steel. The winner will be recognized at the 2020 NASCC: The Steel Conference, April 22-24 in Atlanta, and will also present their lecture, upon request, at various professional association events throughout the year.

Nominations should be emailed to AISC's Rachel Jordan at jordan@aisc.org. Or if you'd prefer to mail your nomination, contact Rachel for mailing information. Nominations must include the following information:

- Name and affiliation of the individual nominated (past winners are not eligible to be nominated again)
- Title of the paper(s) for which the individual is nominated, including publication citation

- If the paper has multiple authors, identify the principal author
- Reasons for nomination
- A copy of the paper(s), as well as any published discussion

The author must be a permanent resident of the U.S. and available to fulfill the commitments of the award. The paper(s) must have been published in a professional journal between January 1, 2014 and January 1, 2019. In addition, the winner is required to attend and present at the 2020 Steel Conference and also give a minimum of six presentations of their lecture on selected occasions throughout the year.

The award will be given to a nominated individual based on their reputation as a lecturer and the jury's evaluation of the paper(s) named in the nomination. Papers will be judged for originality, clarity of presentation, contribution to engineering knowledge, future significance, and value to the fabricated structural steel industry.

For more information about the award, visit www.aisc.org/higgins.

People and Companies

- AISC member and certified fabricator **Banker Steel Company** has launched two new innovative vocational institutes to accommodate a secondary education leading to a career in steel fabrication. For current high school seniors, Banker High is an unpaid internship that offers high school credit and hands-on welding and fitting training. Banker Steel provides all tools and education, with a guaranteed career position upon successfully completing the required skills test. The 12-week, four-hour-per-day course began in January and includes 10 hours of training and blueprint reading as part of a personalized curriculum. Banker University, a wage-compensated six-week course, is geared toward those with an aptitude for, but without previous experience in, manufacturing/construction. Welding, fitting, and basic blueprint reading are taught, followed by a mentorship encompassing an additional two to four weeks of training. The training is provided at no cost to students, though the six-week program must be completed. For more information, visit www.bankersteel.com.

- Infrastructure consulting firm **T.Y. Lin International** announced that **Matthew (Matt) G. Cummings, PE**, has been named president and CEO. A proven executive leader with over 30 years of comprehensive experience in the engineering field, Cummings succeeds former president and CEO **Alvaro J. Piedrahita, PE**, who has transitioned roles to become the company's Chairman of the Board of Directors.

IN MEMORIAM

John Bailey, Former Prospect Steel President and AISC Board Member, Dies at 66

John William Bailey, president of Prospect Steel, a division of Lexicon, Inc., in Little Rock, Ark., and an AISC Board Member, passed away this past Sunday at the age of 66 after a brief fight with cancer.

John was born on November 15, 1952, in Jackson, Tenn., to parents William Hampton and Norreen M. Cassidy Bailey. He earned two degrees from the University of Tennessee, Knoxville—a bachelor's degree in civil engineering in 1975 and a master's degree in structural engineering in 1977—received an Outstanding Alumnus Award from the school's Department of Civil and Environmental Engineering in 2000, and was inducted into its Hall of Fame in April 2017. He was a passionate fan of the Tennessee Volunteers as well as the Kansas City Chiefs. He was also an avid, if admittedly average, golfer and enjoyed beating his sons in pool—and losing to them in pinball.

John spent the majority of his career focused on steel fabrication and erection. He joined Prospect as president in 2000 and before that, spent 14 years as the COO of Havens Steel Company in Kansas City, Mo. In addition to his duties with AISC, he also served on the Board of the Central Fabricators Association.

"I met John in 1988 and had the opportunity to work with him for several years since 1995," said Viji Kuruvilla, vice president with Prospect Steel. "If you ever worked with him, you would soon realize that he was very unique, extremely smart, and had the ability to discern facts and make decisions wisely. He was a great fighter for the steel industry, a great visionary, and expected honesty and complete transparency from everyone. The steel industry lost a great leader, and he will be missed dearly."

"I met John over 18 years ago," said Patrick Schueck, president of Lexicon. "He was many things to me: my boss, my mentor, and my buddy. He was a visionary, a hard-charger, a shrewd businessman, a horrible golfer, and one hell of a good time. He was an amazing card player and an incredible negotiator. He could estimate a complicated project on a cocktail napkin, seal the deal before dinner, and pop the cork for dessert. I often laughed when I wore

a Prospect Steel shirt in shops in China, Mexico, or Europe. People would see the shirt and would always ask me if I knew John Bailey. John was worldwide."

"All of us at Prospect Steel and Lexicon are very proud to have worked with John," said Thomas Schueck, Chair of Prospect Steel. "He has equipped each of us to carry on his legacy in every area of our operations. We will remember him as a strong leader, visionary, mentor, and, most importantly, a great friend. He was also very skilled in caring for our customers and ensuring that their expectations were met. Although he was a tough negotiator, John was a straight shooter who always treated everyone fairly."

"I have been competing and collaborating with John for 32 years," said R. Philip Stupp, Jr., executive vice president of Stupp Bros., Inc. "Though I am deeply saddened by his loss, I will always treasure the memories of working with John for the betterment of the fabricated structural steel industry and the camaraderie that always came at networking events."

"John was my best steel buddy," said Margaret Hanley, president of A. Lucas and Sons. "He was one of the last true gentlemen in the steel industry. He had a little black book in his head where he remembered the smallest details about every job he ever did, and always knew something to relate to you on a personal level. He always made sure to talk about his kids because he knew that work was work but life is what mattered. And what a life he lived! He was always the life of the party, keeping everyone smiling whether he was at a piano bar in Chicago or on a golf course in Little Rock. They don't make men like John anymore."

"I met John in 2006, when we both went onto the Board of AISC," recalled David Zalesne, president of Owen Steel Company and AISC's Board Chair. "We could not have come to the Board from two more opposite direc-

tions. Two years earlier, I had been a lawyer in Philadelphia, with absolutely no knowledge about structural steel. John was already decades into his career in the industry, and clearly knew more about steel than anyone I had ever met. There is an old saying about someone who has forgotten more about steel than I would ever learn, but I don't think John ever forgot anything about steel."

"Over the next 13 years, John became both a mentor and a friend," Zalesne continued. "We spoke regularly between board meetings, played golf many times, and even took a memorable trip to Europe with the Peddinghaus crew to look at the future of steel fabrication equipment. When John was talking about steel, his ability to transfer decades of historical experience into a vision for the future of the industry was extraordinary. But in quieter moments, we also talked a lot about our sons with great pride, sharing bonds about our experiences as fathers that were even stronger than steel."

"John will be sorely missed," expressed AISC president Charlie Carter. "He was enthusiastically dedicated to the advancement of fabrication technology. Perhaps his most admirable trait was that he was willing to share his knowledge and wisdom with everyone—even his competitors."

John is survived by his wife of 44 years, Marilyn Jane Bailey; son Andrew Craft Bailey and his wife Amy and their son Aidan; son Daniel Hampton Bailey; son Patrick William Bailey; and sister Linda Herring and her husband, Bartley.



news & events

ENGINEERING JOURNAL Third Quarter 2019 EJ Now Available

The third quarter 2019 issue of AISC's *Engineering Journal* is now available. You can access the current issue as well as past issues at www.aisc.org/ej. Below is a summary of this issue, which includes articles on gusset plate buckling, the equivalent axial load method, vibration considerations for sensitive equipment, and welded connections for hollow structural sections (HSS). The various AISC publications mentioned are all accessible at www.aisc.org/specifications.

Design for Gusset Plate Buckling with Variable Stress Trajectories

Bo Dowswell

Gusset plates are used in steel buildings and bridges to connect diagonal members to other framing members in the structural system. Gusset plates subjected to compression loads are currently modeled as rectangular columns with an effective cross section defined by a 30° stress trajectory known as the Whitmore Section. The buckling strength is calculated using the AISC column curve with empirical effective length factors. Previous research has shown local yielding allows the stresses to redistribute, increasing the effective width. Because the inelastic capacity decreases with gusset slenderness, a variable stress trajectory has been established, which is dependent on the flexural buckling slenderness parameter. This paper describes a design method for the buckling strength of gusset plates using variable stress trajectory angles. The proposed effective length factors for the equivalent column were evaluated using data from existing research. The design model is valid for single- and

double-plane corner gusset plates, including extended corner gusset plates commonly used for seismic design. Compared to the results of 162 specimens from 12 previously-published research projects, the proposed design model is shown to be more accurate than the methods that are currently available.

Updated Equivalent Axial Load Method for Design of Steel Beam-Columns

Mathew Reynolds and Chia-Ming Uang

The equivalent axial load method is a design aid that aims to select candidate wide-flange beam columns with minimal iteration. The method itself was described in previous editions of the AISC *Steel Construction Manual* but has been removed in recent editions. An expanded version of the tables for sizing of both shallow and deep beam-columns based on the latest edition the AISC *Manual* is presented. Several examples of uniaxial and biaxially loaded beam-columns are provided to demonstrate the effectiveness of the method. The method is validated using a programmed heuristic, which designed beam-columns from randomly generated scenarios.

Walking-Induced Vibration of Steel-Framed Floors Supporting Sensitive Equipment

Brad Davis and Di Liu

This paper explains the vibration evaluation methods for floors supporting sensitive equipment in the second edition of the AISC Design Guide 11: *Vibrations of Steel-Framed Structural Systems Due to Human Activity*. It presents new

experimentally verified equations that are simplified for practical implementation. Sensitive equipment tolerance limits are stated in numerous forms, including peak acceleration and various spectral acceleration and velocity. For this reason, response predictions are given in terms of all tolerance limit forms that are commonly used. The most severe responses of lower-frequency floors to walking are due to resonant build-ups, whereas the most severe responses of higher-frequency floors are due to a series of individual footsteps impulses, so equations are given for both. Because the sensitive equipment tolerance limit is objective, each equation includes a calibration factor that results in a high probability that the predicted response will exceed the actual response.

Weld Effective Lengths for Round HSS Cross-Connections under Branch Axial Loading

Kyle Tousignant and Jeffrey A. Packer

Recent experimental and numerical research performed on fillet-welded, round-to-round, HSS cross connections is reviewed, along with prior research on round HSS-to-rigid-plate connections. The data from these weld-critical tests are then interpreted to determine practical weld effective lengths for such connections, in conjunction with permitting the "directional strength-increase factor" for fillet welds to round HSS. Recommendations are made for the AISC *Specification for Structural Steel Buildings* (ANSI/AISC 360) Section K5, and a design example is given to illustrate the approach.

advertiser index

AISC	8 13 15 67	JGM Fabricators & Constructors	51	SidePlate Systems	33
Automated Layout Technology	53	Lindapter USA	32	St. Louis Screw & Bolt	14
Bull Moose Industries	back cover	MDX Software	39	Tnemec Company	47
Chicago Metal Rolled Products	insert	MOLD-TEK Technologies	61	Trimble	5 41
CoreBrace	47	Peddinghaus Corporation	2	Voortman	18
DuraFuse Frames	11	QuickFrames USA	12		
IES	3	SDS/2	7		

Structural Engineers

Are you looking for a new and exciting opportunity?

We are a niche recruiter that specializes in matching great structural engineers with unique opportunities that will help you utilize your talents and achieve your goals.

- We are structural engineers by background and enjoy helping other structural engineers find their "Dream Jobs."
- We have over 30 years of experience working with structural engineers.
- We will save you time in your job search and provide additional information and help during the process of finding a new job.
- For Current Openings, please visit our website and select Hot Jobs.
- Please call or e-mail Brian Quinn, PE (616.546.9420 or Brian.Quinn@FindYourEngineer.com) so we can learn more about your goals and interests.

All inquiries are kept confidential.

SE Impact by SE Solutions, LLC | www.FindYourEngineer.com

QMC Contract Auditor

Quality Management Company, LLC (QMC) is seeking qualified independent contract auditors to conduct site audits for the American Institute of Steel Construction (AISC) Certified Fabricators and Certified Erector Programs.

This contract requires travel throughout North America and limited International travel. This is not a regionally based contract and a minimum travel of 75% should be expected.

Contract auditors must have knowledge of quality management systems, audit principles and techniques. Knowledge of the structural steel construction industry quality management systems is preferred but not required as is certifications for CWI, CQA or NDT. Prior or current auditing experience or auditing certifications are preferred but not required. Interested contractors should submit a statement of interest and resume to contractor@qmconline.org.

Connect with AISC on SOCIAL MEDIA



facebook.com/AISCdotORG



@AISC



@AISC



youtube.com/AISCSteelTV

LATE MODEL STRUCTURAL STEEL FABRICATING EQUIPMENT

- Peddinghaus FPDB-2500 CNC Heavy Plate Processor**, 96" Width, (3) Drill Spindles, HPR260 Plasma, (1) Oxy, Siemens 840, 2008 #27974
- Peddinghaus FDB-2500A CNC Plate Drill with Oxy/Plasma Torches**, (3) Head Drill, 96" Max. Plate Width, 2003 #29542
- Controlled Automation DRL-336 CNC Beam Drill**, (3) 15 HP Spindles, 36" x 18", Hem WF140 Tandem Saw, 2005 #29344
- Peddinghaus PCD-1100 CNC Beam Drill**, 44" x 18", 900 RPM, 13.5 HP, (3) Spindles, 3" Max. Diameter, 13" Stroke, 2008 #29286
- Ficpe Gemini 324PG Plate Processor**, 10' x 40', 15 HP Drill, (1) Oxy, HPR260XD Plasma Bevel Head, 2014 #28489
- Ficpe 1001 DZB CNC Beam Drill Line**, 1-Drill Head, 40" Band Saw, 65' Max Length, 2006 #29947
- Peddinghaus Ocean Avenger II 1000/1B CNC Beam Drill**, 40" x 40' Max Beam, Siemens 840Di CNC Control, 2006 #29710
- Roundo R-13-S Angle Bending Roll**, 8" x 8" x 1.25" Leg In, 105 HP, 31.5" Diameter Rolls, Universal Rolls #29237
- Voortman V630/1000 CNC Beam Drill**, (3) Drill Units, Max Length 51", Power Roller Conveyor, 2016 #29726

www.PrestigeEquipment.com | Ph: +1.631.249.5566
sales@prestigeequipment.com

Interested in business development and making structural steel the material of choice?



now hiring in New York

to learn more visit www.aisc.org/mynextcareer

American Steel is looking for an **Estimator/Sales** with 3-5 years' experience in Structural and Miscellaneous steel Fabrication. Being efficient in: fabsuite, fabtrol, Microsoft word and excel experience will be beneficial. Benefits Includes: Salary plus commissions, Health insurances, 401k with matching, Holiday pay, Vacation Pay, Bonuses, Possible moving expenses and signing bonus. Salary depends upon experience. Located in Billings, Mt. *All information is held confidential.*

Send Resumes to: Paul Neutgens | pneutgens@amersteel.com

Modern Steel Construction

All of the issues from *Modern Steel Construction's* 58 years are now available as free PDF downloads at www.modernsteel.com/archives.

structurally sound



Casey Dunn

FOSSILIZED STEEL

AFTER 68 MILLION years, Quetzalcoatlus finally has a home.

A relic from the Late Cretaceous, this titanic pterosaur is one of the largest-known flying animals of all time and was first discovered in Big Bend National Park in Texas in 1971.

Until recently, there was no ideal way to display its fossilized skeleton, but it now hangs from the roof of the park's steel-framed Fossil Discovery Exhibit. The scale of the building—designed by architect Lake|Flato and structural engineer Datum Engineers, with steel fabricated by AISC member and certified fabricator

Rocky Mountain Steel—was driven by the reptile's 33-ft wingspan, resulting in a large central span that tapers out from 30 ft to 40 ft wide, with a lower 28-ft-wide roof on each side. All of the roofing is weathering steel and the framing for the structure, much of it comprised of hollow structural sections (HSS), is left uncoated thanks to the region's low humidity and low corrosion risk.

To read more about Fossil Discovery Exhibit and other fun projects, watch for our annual What's Cool in Steel section in the August issue.

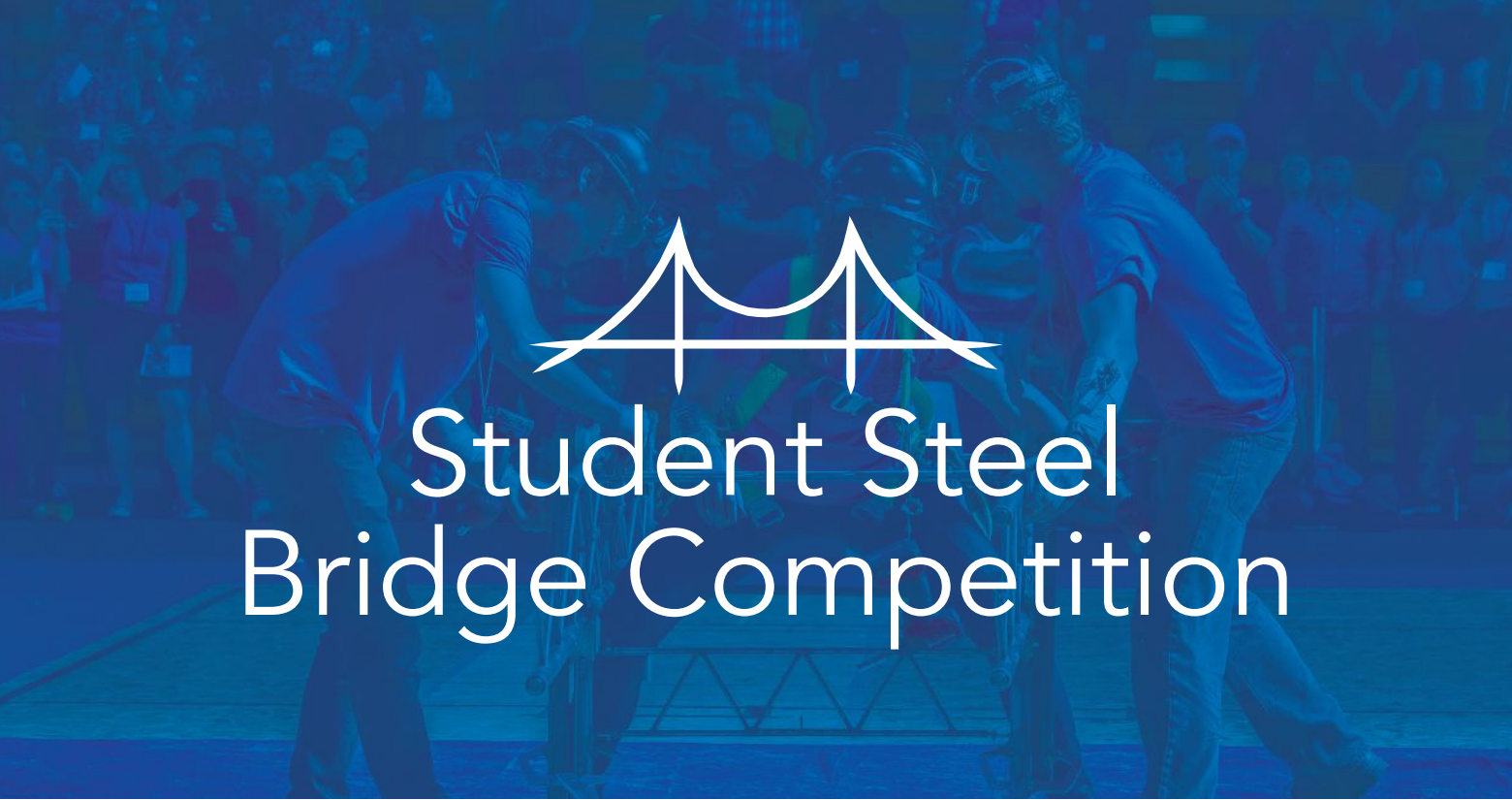

Student Steel Bridge Competition

Thank you to our National Sponsors!

NUCOR[®]



**Bentley
Institute**

SOLIDWORKS



COOPER STEEL
BUILD STRONG. STAND STRONG.



**Steel Tube
Institute**



Smarter. Stronger. Steel.

American Institute of Steel Construction
312.670.2400 | www.aisc.org

HOLLOW STRUCTURAL STEEL TUBE FROM BULL MOOSE

**BUILD A
LANDMARK.**



For projects that will stand the test of time, start with Bull Moose HSS tube.

Our direct-form manufacturing process enables us to use the highest grade HSLA steel...and form it directly into a tube.

With sizes ranging from 1.5" square to 18"x6", and wall thicknesses from 1/8" through 5/8", Bull Moose features one of the largest size ranges of HSS products in the industry.

For strength, versatility and reliability, build with Bull Moose.

BULL MOOSE ADVANTAGES

- Strength ranges of 46 KSI to 110 KSI
- Tighter tolerances, sharper edges, and straighter tubes
- Widest variety of custom sizes/lengths, including metric
- In-line NDT weld testing available on all tube
- Readily available weathering grade steel
- Fast delivery with 8 domestic sites



BULL MOOSE
For exceptional strength.

1819 Clarkson Rd.
Chesterfield, MO 63017

800.325.4467 | **BULLMOOSETUBE.COM**