

Modern Steel Construction

November 2019



HIGH SPEED ROBOTIC

STEEL BEAM ASSEMBLY

- Accomplishes work of 5 fitters per shift
- Maintains 1/24" accuracy over 60' profiles
- Fit and tack pieces at 1.5 minutes per part

www.peddinghaus.com/peddiassembler



THE
PEDDIASSEMBLER

Peddinghaus

STRONGER THAN
STEEL®

www.peddinghaus.com | info@peddinghaus.com | (815) 937-3800



Thousands of engineers succeed with

VisualAnalysis

Starting at just \$650/year. Learn more at www.iesweb.com.

Structural Software

Easy. Versatile. Productive.

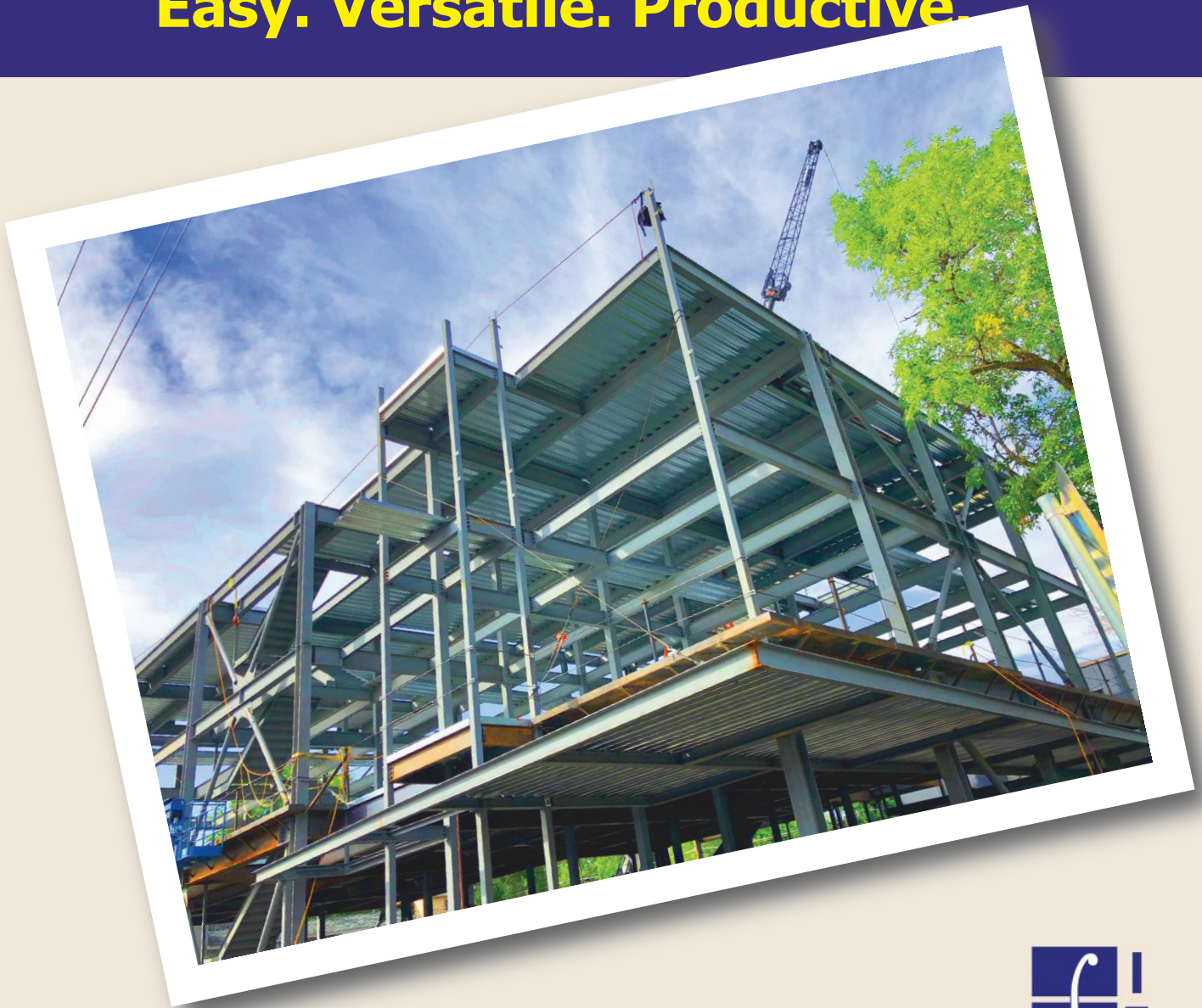

Download your free trial today:

iesweb.com

800.707.0816



Modern Steel Construction

November 2019



in every issue
departments

- 6 EDITOR'S NOTE
- 9 STEEL INTERCHANGE
- 12 STEEL QUIZ
- 60 NEWS & EVENTS
- 66 STRUCTURALLY SOUND

resources

- 65 ADVERTISER INDEX
- 65 MARKETPLACE & EMPLOYMENT

features

24 Winging It

BY CHRIS A. CHRISTOFOROU, PE, AND ILIANA KARAGIANNAKOU, PE

At a Florida aeronautical school, the sky's the limit for a new student union topped by an avian-inspired steel roof.

30 Steel Coliseum

BY ALLISON CLARK, PE

A steel-framed replica of an ancient architectural icon brings new capacity to a corporate headquarters with old-world charm.

36 Revisiting Redundancy

BY JASON B. LLOYD, PE, PhD

A look at historical considerations of redundancy and fracture-critical members in steel bridges.

40 You Can Get There From Here

The 20th annual Steel Design Student Competition challenged students to elevate the transit center concept, and the winners generated some out-of-this-world designs.

56 Safety in Numbers

BY KRIS CHIPMAN

Safety should be an ongoing discussion, and OSHA's annual lists of safety violations provide a good reference point in your own company's safety conversation.

columns

steelwise

16 Weight, Cost, Time, Happiness—and You

BY LARRY MUIR, PE, AND MARK HOLLAND, PE

How to keep your clients happy, make your life easier, and (maybe) get (sort of) rich(er) doing it.

business issues

22 Tidy Up

BY ANNE SCARLETT

How to maintain a client roster that sparks joy.

Statement of Ownership, Management, and Circulation	
Modern Steel Construction 130 E. Randolph St., Suite 2000, Chicago, IL 60601 Phone: (312) 670-5427 Website: www.modernsteel.com	Date: 09/13/2019 Title: Erika Salisbury Phone: (312) 670-5427
Monthly: 12 Annually: \$44.00	
American Institute of Steel Construction, 130 E. Randolph St., Suite 2000, Chicago, IL 60601 Scott L. Mehnick, 130 E. Randolph St., Suite 2000, Chicago, IL 60601 Geoff Weisenberger, 130 E. Randolph St., Suite 2000, Chicago, IL 60601	

Modern Steel Construction	September 2019
a. Total Number of Copies (Net press run) 63,814	b. Copies of Single Issue Produced/Net Total of Copies for Issue 62,943
c. Total Paid for Distribution (Sum of 10c, 11c, 12c, and 13c) 60,048	d. Total Paid for Distribution (Sum of 10c, 11c, 12c, and 13c) 59,105
e. Total Paid for Distribution (Sum of 10c, 11c, 12c, and 13c) 62,637	f. Total Paid for Distribution (Sum of 10c, 11c, 12c, and 13c) 62,366
g. Total Paid for Distribution (Sum of 10c, 11c, 12c, and 13c) 1,447	h. Total Paid for Distribution (Sum of 10c, 11c, 12c, and 13c) 575
i. Total Paid for Distribution (Sum of 10c, 11c, 12c, and 13c) 63,814	j. Total Paid for Distribution (Sum of 10c, 11c, 12c, and 13c) 62,943
k. Total Paid for Distribution (Sum of 10c, 11c, 12c, and 13c) 96%	l. Total Paid for Distribution (Sum of 10c, 11c, 12c, and 13c) 95%
Production Coordinator: 09/13/2019	

ON THE COVER: It's a bird! It's a plane! It's—OK, we were right the first time. It's a bird-inspired steel roof, p. 24. (Photo: Chad Baumer Photography)
 MODERN STEEL CONSTRUCTION (Volume 59, Number 12) ISSN (print) 0026-8445: ISSN (online) 1945-0737. Published monthly by the American Institute of Steel Construction (AISC), 130 E. Randolph Street, Suite 2000, Chicago, IL 60601. Subscriptions: Within the U.S.—single issues \$6.00; 1 year, \$44. Outside the U.S. (Canada and Mexico)—single issues \$9.00; 1 year \$88. Periodicals postage paid at Chicago, IL and at additional mailing offices. Postmaster: Please send address changes to MODERN STEEL CONSTRUCTION, 130 E. Randolph Street, Suite 2000, Chicago, IL 60601.

DISCLAIMER: AISC does not approve, disapprove, or guarantee the validity or accuracy of any data, claim, or opinion appearing under a byline or obtained or quoted from an acknowledged source. Opinions are those of the writers and AISC is not responsible for any statement made or opinions expressed in MODERN STEEL CONSTRUCTION. All rights reserved. Materials may not be reproduced without written permission, except for noncommercial educational purposes where fewer than 25 photocopies are being reproduced. The AISC and Modern Steel logos are registered trademarks of AISC.



Printed on paper made from a minimum of 10% recycled content.



The Best in Steel MIS Just Got Better

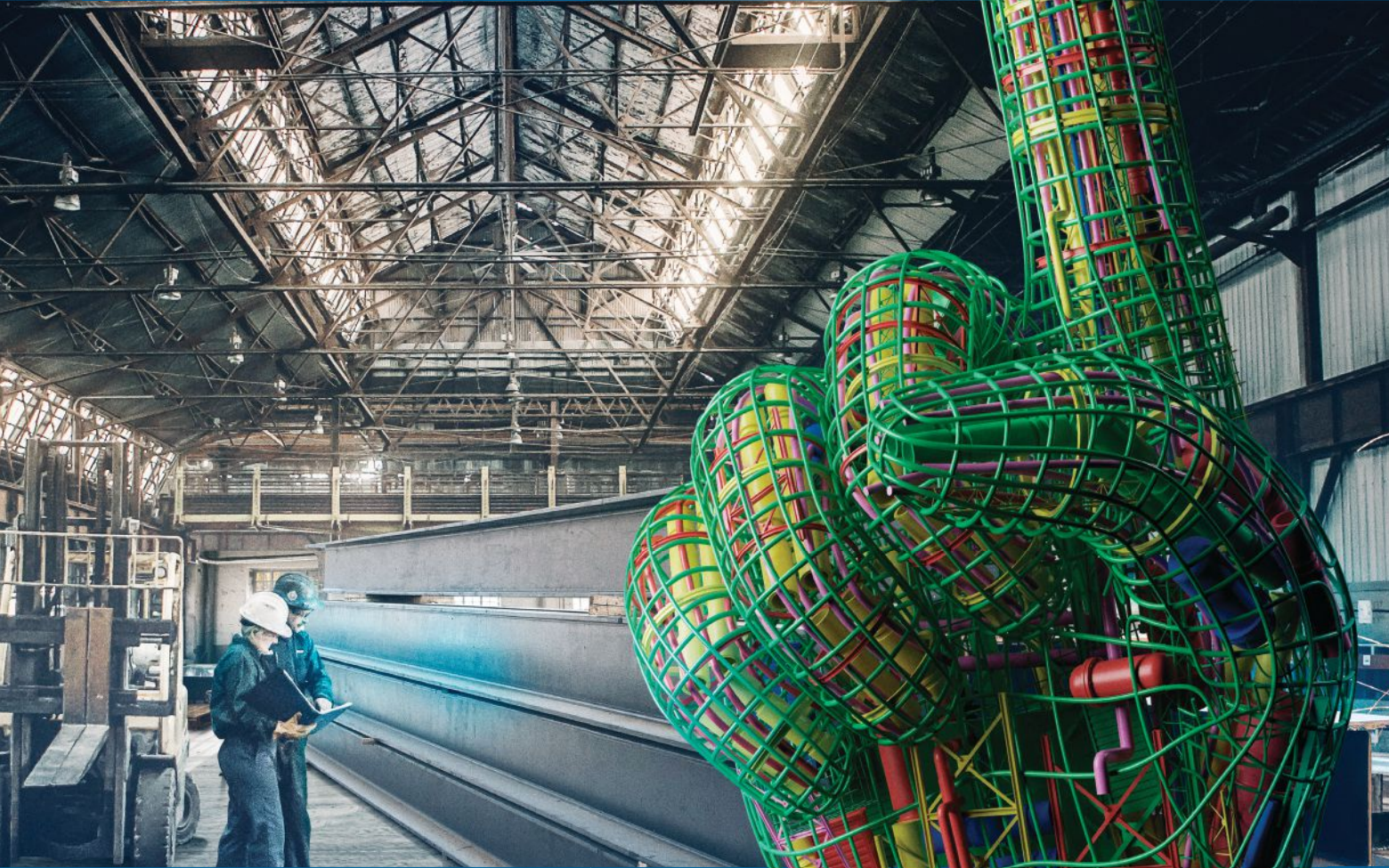

The Power of FabSuite Plus a Whole Lot More

The industry's next generation of steel fabrication management software is here. Tekla PowerFab is a software suite that combines the power of FabSuite with other Tekla solutions to deliver next-level performance in estimating accuracy and project collaboration.

Learn more at: www.TeklaPowerFab.com



IS NOW



editor's note



In my family, we like to argue about everything. Whether New York-style pizza is better than Chicago-style (and don't get me started on the growing movement towards Detroit-style)...which route is quicker between our house and the expressway...or even whether *Spider-Man: Into the Spider-Verse* is the best Spider-Man movie. So I can certainly appreciate a difference of opinion.

But when it comes to the built environment, there are three things I see over and over that I just don't get.

The first is when people design buildings as though least weight equals least cost. During the past three decades, we have published dozens of articles explaining what seems like a fairly simple concept: Material costs are increasingly less significant than labor costs. Therefore, adding a small amount of material (such as upsizing a column) will often save substantial project costs by eliminating labor-intensive operations such as adding doublers and stiffener plates. In this month's SteelWise (see page 16), Mark Holland and Larry Muir lay out the case for this simple concept once more and offer myriad fantastic sources presenting hundreds of tips on how to make your engineering services more valuable by reducing overall project costs. To that, I'd add there are also numerous free online seminars on AISC's website at aisc.org/educationarchives that provide amazing guidance (such as *30+ Good Rules of Connection Design* and *Rules of Thumb for Steel Design*.)

My second beef is: Why we are still suffering from a decline in the quality of construction documents? It's a rare week when I don't hear someone complain about the proliferation of incomplete—and in many cases inadequate—drawings and the constant bemoaning that it would be great if there were some guidelines for engineers about what should be shown in contract documents.

I find this discussion frustrating because there is a document from the Council of American Structural Engineers that does exactly that: CASE 962-D: *A Guideline Addressing Coordination and Completeness of Structural Construction Documents*. If you don't have a copy, go to CASE's website, acec.org/case, and buy it right now! If you need more convincing, visit aisc.org/2013nascconline and click on the CASE 962-D session.

Finally, I don't understand why people are so willing to ignore end-of-life concerns for structures when talking about sustainability. I recently read a fairly silly diatribe on how the world will soon move away from building with concrete due to its horrible environmental impact related to carbon dioxide emissions. The proposed solution is wood! After all, wood sequesters carbon dioxide, right? Of course, when the structure reaches the end of its life and all that wood is turned into mulch, thrown in a landfill, or burned, all of that carbon is released. Oops.

To summarize: Least weight does not equal least cost. You should be following CASE 962-D. A true life-cycle assessment must consider end-of-life concerns.

And New York-style pizza is the best.

Scott Melnick
Editor

Modern Steel Construction

Editorial Offices

130 E Randolph St, Ste 2000
Chicago, IL 60601
312.670.2400

Editorial Contacts

EDITOR AND PUBLISHER

Scott Melnick
312.670.8314
melnick@aisc.org

SENIOR EDITOR

Geoff Weisenberger
312.670.8316
weisenberger@aisc.org

DIRECTOR OF PUBLICATIONS

Keith A. Grubb, SE, PE
312.670.8318
grubb@aisc.org

PRODUCTION COORDINATOR

Erika Salisbury
312.670.5427
salisbury@aisc.org

GRAPHIC DESIGN MANAGER

Kristin Hall
312.670.8313
hall@aisc.org

AISC Officers

CHAIR

Jack Klump, Cianbro Fabrication
& Coating Corporation

VICE CHAIR

Stephen Knitter,
Geiger & Peters, Inc.

SECRETARY/LEGAL COUNSEL

Edward Seglias, Cohen Seglias
Pallas Greenhall & Furman, PC

PRESIDENT

Charles J. Carter, SE, PE, PhD

SENIOR VICE PRESIDENT

Scott Melnick

VICE PRESIDENT

Lawrence F. Kruth, PE

VICE PRESIDENT

Tabitha S. Stine, SE, PE

VICE PRESIDENT

Mark W. Trimble, PE

Editorial Advisory Panel

Caroline R. Bennett, PE, PhD,
University of Kansas

Amanda Dean, PE,
Huitt-Zollars, Inc.

Bryan Frazier,
Zalk Josephs Fabricators, LLC

Keith R. Griesing, PE,
Hardesty and Hanover

Steve Knitter,
Geiger and Peters

Advertising Sales

M.J. Mrvica Associates, Inc.
2 W Taunton Avenue
Berlin, NJ 08009
856.768.9360
mjmrvica@mrvica.com

Address Changes and Subscription Concerns

312.670.2401
subscriptions@aisc.org

Reprints

Erika Salisbury
312.670.5427
salisbury@aisc.org

INTELLIGENT AUTOMATION EQUALS PRODUCTIVITY

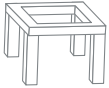

Recognizes and Automatically **ADAPTS TO FRAMING CONDITIONS**

SDS/2 takes a uniquely intelligent approach to its connection design by considering framing conditions and erectability.

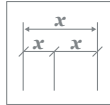

Reduces Detailing Time **WITH CUSTOM TEMPLATES**

SDS/2 allows detailing drawings to be customized to your detailing and fabrication standards, reducing time spent on cleanup.



Creates Multi-User Environment **TO STREAMLINE WORKFLOW**

With SDS/2, everyone works in the live model simultaneously; there's no need to check the model in or out.

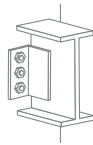

Conducts Code-Based **JOINT ANALYSIS**

Only SDS/2 automatically performs clash detection and prevention as part of its connection design, which leads to savings in the shop.



Integrates to the **SHOP, FIELD AND OFFICE**

SDS/2's intelligence allows for seamless transfer of information from start to finish.



ENSURES FIT-UP in Field

With SDS/2, if it fits in the model, it fits in the field.

See how SDS/2 can increase your bottom line at
[SDS2.COM/PRODUCTIVITY](https://www.sds2.com/productivity)



www.sds2.com
800-443-0782 // 402-441-4045 (fax)
1501 Old Cheney Rd., Lincoln, NE 68512



A NEMETSCHek COMPANY



Pile up the PDHs

with AISC Continuing Education.

Upcoming Daytime Webinars

- 11/6 Shear Connections, Part 1 *by Brad Davis*
- 11/13 Shear Connections, Part 2 *by Brad Davis*
- 12/3 Introduction to the FHWA Bridge Welding Reference Manual *by Ronnie Medlock*
- 12/5 Design of Curved Members, Part 1 *by Bo Dowswell*
- 12/12 Design of Curved Members, Part 2 *by Bo Dowswell*

aisc.org/webinars

Upcoming Night School Sessions

Welded Connections—A Primer for Engineers

by Duane K. Miller

- 11/5 Metallurgy and Cracking
- 11/19 Fatigue of Welded Connections
- 11/26 Seismic Welding Issues
- 12/3 Special Welding Applications
- 12/10 Problems and Fixes

aisc.org/nightschool21



Smarter. Stronger. Steel.

American Institute of Steel Construction
312.670.2400 | www.aisc.org

If you've ever asked yourself "Why?" about something related to structural steel design or construction,

Modern Steel's monthly Steel Interchange is for you!

Send your questions or comments to solutions@aisc.org.

steel interchange

All referenced AISC publications, unless noted otherwise, refer to the current version and are available at aisc.org/specifications. Modern Steel Construction articles can be found in the Archives section at www.modernsteel.com, and AISC Design Guides are available at aisc.org/dg.

Round HSS Connections

I am looking to design a welded moment connection between two rounded, custom-fabricated hollow structural section (HSS) members. The members are quite large, and they intersect at 90°.

I was looking to use Table K4.1 of the AISC *Specification for Structural Steel Buildings* (ANSI/AISC 360) to design the connection. However, the larger member exceeds the $D/t < 50$ applicability limit. I was hoping to gain some clarity on why this applicability limit is in place. Additionally, are there any other sections of the *Specification* that could be used to design the connection if Table K4.1 is not an option?

In my experience, the common approach to structural steel connection design, as facilitated and reflected in Chapter J, is to develop a design model usually based on statically admissible forces (and load paths) and then determine (based on engineering knowledge, experience, and judgment) the applicable limit states to be checked. Chapter K was largely developed by running tests and then including only those limit states that were observed in the tests. This means that the design procedures may only be valid within the same range as the tests. In effect, nothing outside the range of the tests has been addressed.

Chapter K was written largely as a series of procedures addressing very specific conditions into which the user substitutes in numbers (intended to represent physical parameters of the connection) and gets back strengths. As such, only a limited range of configurations are addressed as reflected by the limits of applicability, which primarily reflect the limit of the tests conducted but also reflect the judgment of the committee and can include such considerations as "good" engineering and fabrication practices.

I have been told that, like many of the limit states that are applied to rectangular HSS, the limit states applied to round HSS can be derived from basic mechanics. In prior editions of the *Specification*, Chapter K was often interpreted as explicitly prohibiting conditions outside the limits of applicability. This position was softened in 2016.

Section A1 states: "Where conditions are not covered by this *Specification*, designs are permitted to be based on tests or analysis, subject to the approval of the authority having jurisdiction." Much of the *Specification* is ultimately just a codification

and simplification of basic mechanics and basic mechanics always applies. A lot of the work done on large tubes involves off shore structures. I believe finite element analysis is relied on pretty heavily in the design of many structures involving large HSS. Such approaches are not explicitly prohibited by the *Specification*, but they are also not directly addressed.

Larry Muir, PE

Fillet Weld Designs at the Compression Flange

I am reviewing calculations for a beam-moment end-plate connection and have a question on how the fillet weld size was determined at the compression flange. The weld of the compression flange is taken as the minimum weld size from Table J2.4 of the *Specification* without any calculation. I want to know what the available strength for the fillet weld is under compression. What makes this difficult is that Table J2.5 in the *Specification* only addresses fillet welds loaded in shear or loaded in tension or compression parallel to the weld axis. For my case, I am trying to design a fillet weld loaded normal to the weld axis.

You have misinterpreted the intent of Table J2.5 of the *Specification*. All fillet welds that transfer load do so through shear—even when the parts joined are in tension, compression, or flexure. Compression delivered normal to the weld axis will produce shear in the weld, and the nominal available weld stress is $0.60F_{EXX}$, though as stated in the footnote: "The provisions of Section J2.4(b) are also applicable."

If you have a question about the design, you should discuss this with the designer. I believe the designer may have assumed that the compression is transferred through direct bearing between the parts. If this is the case, there is no demand on the weld, and it serves only to hold the parts in place. The December 2015 SteelWise article "Bear It and Grin" may be helpful.

Larry Muir, PE

Undersized Fillet Welds

Is there any amount of a fillet weld that AISC maintains as acceptable to be undersized on a particular project? Or is it the responsibility of the fabricator to ensure that all fillet welds meet the size required on the approved shop drawings?

Table N5.4-3 addresses inspection tasks after welding and indicates that welds need to meet visual acceptance criteria for crater cross section, weld profiles, weld size, undercut, etc., and this is

steel interchange



Carlo Lini (lini@aisc.org) is AISC's director of technical assistance.

Larry Muir is a consultant to AISC.

designated as a perform task for both QC and QA, indicating that it needs to be performed for each welded joint.

Section 6.9 in AWS D1.1 addresses visual inspection and states that all welds shall be visually inspected and shall be acceptable if the criteria of Table 6.1 or Table 9.16 (if tubular) are satisfied.

Item 6 in Table 6.1 addresses undersized welds indicating the allowable decrease in weld size, which is as follows:

- For fillet weld leg sizes of $\frac{3}{16}$ in. (5 mm) or less, weld sizes may be $\frac{1}{16}$ in. (2 mm) undersized.
- For fillet weld leg sizes of $\frac{1}{4}$ in. (6 mm), weld sizes may be $\frac{3}{32}$ in. (2.5 mm) undersized.
- For fillet weld leg sizes of $\frac{5}{16}$ in. (8 mm) or more, weld sizes may be $\frac{1}{8}$ in. (3 mm) undersized.

It also states: "In all cases, the undersize portion of the weld shall not exceed 10% of the weld length. On web-to-flange welds on girders, underrun shall be prohibited at the ends for a length equal to twice the width of the flange."

AISC Design Guide 21: *Welded Connections—A Primer for Engineers* provides additional guidance, stating: "These permitted reductions in weld size result in a theoretical decrease in the weld available strength of less than 4%, assuming that the rest of the weld is of the same size as specified. In many cases, when a weld is smaller in one location, it is larger in another, resulting in some compensation for the undersized portion. For girders, the same table disallows any undersized welds from the welds at the ends of the girder."

Carlo Lini, PE

Steel "Like New"

We are reviewing a customer's specification about materials that requires the material used for a project to be "like new." Do you know how this is defined? Would I be permitted to use stock materials?

I am not aware of a standard that addresses how steel would qualify as "like new." If the intent is unclear, then you should seek clarification from the specifier.

The use of stock material is addressed in the AISC *Code of Standard Practice for Steel Buildings and Bridges* (ANSI/AISC 303) in Section 5.2.1, which states: "If used for structural purposes, materials that are taken from stock by the *fabricator* shall be of a quality that is at least equal to that required in the ASTM specifications indicated in the *contract documents*."

Section 5.2.2 states: "Material test reports shall be accepted as sufficient record of the quality of materials taken from stock by the *fabricator*. The *fabricator* shall review and retain the material test reports that cover such stock materials. However, the *fabricator* need not maintain records that identify individual pieces of stock material against individual material test reports, provided the *fabricator* purchases stock materials that meet the requirements for material grade and quality in the applicable ASTM specifications."

You could follow up with the specifier to see if stock material meeting the requirements in Section 5.2.1 and 5.2.2 would satisfy the intent of the "like new" requirement.

Carlo Lini, PE



Steel Interchange is a forum to exchange useful and practical professional ideas and information on all phases of steel building and bridge construction. Contact Steel Interchange with questions or responses via AISC's Steel Solutions Center: 866.ASK.AISC | solutions@aisc.org

The complete collection of Steel Interchange questions and answers is available online at www.modernsteel.com.

The opinions expressed in Steel Interchange do not necessarily represent an official position of the American Institute of Steel Construction and have not been reviewed. It is recognized that the design of structures is within the scope and expertise of a competent licensed structural engineer, architect or other licensed professional for the application of principles to a particular structure.

THE ULTIMATE RESOURCE IN TUBULAR PRODUCTS

IS HERE

Independence Tube Corporation, Southland Tube, and Republic Conduit are now Nucor Tubular Products. As we come together as part of Nucor, North America's leading steel company, we remain dedicated to working with you, our customer.

As a result, our HSS line now boasts a wider product range. But one thing hasn't changed, our quality and service continues to be among the best in the industry. We pioneered on-line ordering with our 24/7 customer secure portal and our on time rolling schedule is considered to be second to none among our customers.

As part of our tubular family, Republic Conduit continues to offer its electrical conduit products designed to reduce installation costs and jobsite delays. This winning combination of products and innovation continues to support the reason why we have been so successful: working together and dedicated to providing our customers with the best products and services in the industry.

Our locations include: Birmingham, AL; Cedar Springs, GA; Chicago, IL; Decatur, AL; Louisville, KY; Marseilles, IL; and Trinity, AL.

NUCOR[®]
TUBULAR PRODUCTS

NTP Grades include:

- ASTM A500
- ASTM A252
- ASTM A1085
- ASTM A513
- A53 grade B Type E ERW
- ASTM A135 and
ASTM A795 Sprinkler Pipe

HSS Sizes include:

Squares: ½" x 16" gauge
through 12" x .625" wall

Rectangles: 1 ½" x 1" x 16 gauge
through 16" x .625" wall

Rounds: .840" OD x .109" wall
through 16" OD x .688" wall

Learn more at www.nucortubular.com



steel quiz

This month's Quiz is all about useful tips to help your next project run smoothly. (And no, this does not mean you should just skip straight to the answers.) All past *Modern Steel Construction* articles referenced can be found in the Archives section at www.modernsteel.com. For even more tips, see this issue's SteelWise (p. 16).

- 1 **True or False:** A fracture-critical member (FCM) is fabricated to the same standards as a non-fracture-critical member.
- 2 Which of the following is not true?
 - a. Simplicity of construction translates to better economy
 - b. Efficient connection design leads to reduced costs
 - c. An optimum design results in the least amount of material used
 - d. Greater economy can be achieved with fewer pieces
- 3 What issues, if any, can you find in the base plate detail found in Figure 1 to resist axial compression only (not including design specifics related to connection demand)?

(4) ¾ DIA.
F3125 Gr. A490 Rods

HSS6×6×¼
(A500 Gr. C)

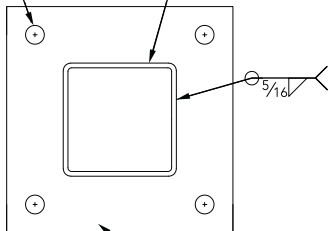

Fig. 1 10x10x½ PLATE (A36)
- 4 **True or False:** The engineer of record (EOR) should always specify bolt size and connection type on drawings, even when connection design is delegated.
- 5 **True or False:** The additional steel tonnage added when upsizing a column with localized loading is usually more costly than providing stiffeners and reinforcement.
- 6 **True or False:** A properly detailed connection using fillet welds can develop the full strength of the attached materials.
- 7 **True or False:** Weathering steel corrosion resistance is enhanced by applying a coating system.
- 8 There is a very important consideration when designing flange plate moment connections resisting large moments. What is it? (Hint: You *might* want to take a look at the November 2015 SteelWise article "Choosing the Moment.")

TURN TO PAGE 14 FOR THE ANSWERS

Innovation Highlights

- No Beam or Column Damage Under Severe Earthquake Loading
- Faster Repair Following a Severe Earthquake
- Less Steel + Less Fabrication Labor = Up Front Cost Savings
- No Field Welding + No Field Weld Inspection = Fast Erection

Easy to Design

- Stiffness Checks Performed in RAM or ETABS
- Complimentary Design Assistance
- Connection Design, Detail Sheets, and Connection Schedules Provided

DURA FUSE

FRAMES

durafuseframes.com
contact@durafuseframes.com
 801.727.4060

Resiliency

The bottom fuse plate in DuraFuse Frames protects the beams and columns and is the only part to be replaced after a severe earthquake.





Are You Redi?

REDICOR SIMPLIFIES AND ACCELERATES THE CONSTRUCTION OF REINFORCED CONCRETE CORES.

Conventional cast-in-place, pre-cast and masonry methods of constructing reinforced concrete shear cores often require long and



Pre-engineered load-bearing structural connections enable framing to begin immediately.

expensive schedules before structural framing can begin.

Now there's a better way.

RediCor is a pre-fabricated, ready-to-set modular steel form system that simplifies and accelerates concrete core construction. Our load-bearing modules are ready to set once on-site, and structural framing can be installed simultaneously – saving time, energy and money. Are you Redi?

VISIT US AT REDICOR.COM FOR THE REDICOR STORY.

NUCOR
VULCRAFT/VERCO

Powerful Partnerships.
Powerful Results.

REDICORTM
Modular Steel Form System
BY VULCRAFT

steel quiz ANSWERS

Everyone is welcome to submit questions and answers for the Steel Quiz. If you are interested in submitting one question or an entire quiz, contact AISC's Steel Solutions Center at 866.ASK.AISC or solutions@aisc.org.

- 1 **False.** Fabrication of FCMs is governed by the AASHTO/AWS D1.5 *Bridge Welding Code*, Clause 12: AASHTO/AWS Fracture Control Plan (FCP) for Non-redundant Members. The provisions of Clause 12 ensure the highest possible quality of fabrication by increasing the quality of materials (additional toughness), welding procedures, shop inspections, and weld repair provisions. There have been no reported fractures of FCMs designed and fabricated since the FCP was first implemented more than 40 years ago.
- 2 **c.** Least weight does not always translate to least cost. Many additional factors contribute to project cost, such as connection fabrication and erection procedures.
- 3 The anchor rods are specified incorrectly. The ASTM F3125 standard covers headed bolts, with limited thread length, generally available only up to 8 in. in length and governed by provisions for steel-to-steel joints only. ASTM F1554 would be the correct specification as it covers hooked, headed, and threaded/nutted rods. Additionally, it is best to avoid specifying all-around welds as these unnecessarily increase the labor required to complete the weld due to the welder having to make an out-of-position weld on the corners. In this case, specifying a fillet weld on four flat sides would suffice. For more information, see AISC Design Guide 1: *Base Plate and Anchor Rod Design* (aisc.org/dg).
- 4 **False.** Providing the end reactions and allowing the fabricator to select the connection type and size to achieve the required strength provides more flexibility. It also typically leads to a more efficient

configuration conducive to the shop's capabilities as well as a more economical project for the owner.

- 5 **False.** Keep in mind the additional labor cost to install reinforcement or stiffeners, as well as the cost to fabricate the "gingerbread" (little pieces of steel used for brace angles, relieving angles, bent plates, stiffeners, web double plates, and little beams). Some good rules of thumb to evaluate the costs of reinforcing members appeared in the February 1992 article "Designing for Cost Efficient Fabrication." And for an updated approach to that article, see the SteelWise article on page 16.
- 6 **True.** Complete joint penetration (CJP) welds are typically the most expensive weld type due to the material preparation and extensive inspection required. Thus they should be reserved for situations in which they are the only viable option. Many times engineers specify CJP welds when a fillet weld would have sufficed, incurring additional unnecessary cost. For more information, see the May 2008 SteelWise article "What Every Fabricator Wants You to Know about Welding."
- 7 **False.** When properly detailed and used in accordance with FHWA Technical Advisory 5140.22 (available at fhwa.dot.gov/bridge/t514022.cfm), weathering steel forms a protective oxide layer from its exposure to wet/dry cycles. The application of a coating system inhibits this process and only adds to the initial and long-term maintenance costs of the bridge. Research has shown that design and maintenance practices may be more influential than climate to the performance of weathering steel.
- 8 When designing flange-plated connections for large moments, it is important to consider the reduction in flange net section area when providing so many bolt holes in the beam flange required to attach the flange plates. The beam must maintain adequate capacity to resist the intended loading.

What You'll Get from a QuickFrames

LUNCH & LEARN

- ✓ Expert information about structural steel roof frames
- ✓ One hour of CE credit (NCSEA Diamond Review accredited)
- ✓ An introduction to the only roof frames that will delight your customers and make you a hero.



All that... AND a bag of chips.

QUICKFRAMES

QuickFrames.us
480-464-1500

FICEP Innovation Helps Our Business Grow



In 2012, ASC underwent an organizational restructuring. In keeping with the new vision there was a need to find a strong partner that we could depend upon to support our projected growth. We quickly realized that FICEP offered a level of technology, versatility and productivity that was not available from other vendors.

The level of professional support that we received from FICEP has enabled us to grow our business with multiple FICEP purchases over the past few years.

FICEP has proven to be a big part of our growth and success.



Shyamal Ganguly, President & CEO, ASC Inc.

FICEP is committed to annually reinvest in new product development to introduce to the industry new innovative technology to enhance your competitive edge. Give us a call to learn more about our commitment to leading edge product development and how it will benefit your firm!



FICEP Corporation | 2301 Industry Court | Forest Hill, Maryland 21050

(410) 588-5800 Fax (410) 588-5900

www.ficepcorp.com

steelwise WEIGHT, COST, TIME, HAPPINESS —AND YOU

BY LARRY MUIR, PE, AND
MARK HOLLAND, PE

How to keep your clients happy,
make your life easier, and (maybe)
get (sort of) rich(er) doing it.



Larry Muir is a consultant to AISC and **Mark Holland** is chief engineer with Paxton and Vierling Steel Company (an AISC member and certified fabricator).

BACK IN 1992, Bill Thornton of Cives Steel Company wrote a *Modern Steel Construction* article entitled “Designing for Cost Efficient Fabrication.”

In fact, the entire (February 1992) issue was heralded as a “SPECIAL REPORT: How Design Engineers Can Cut Fabrication Costs.” Nearly 30 years later, we were essentially asked to update the article. As we reread Thornton’s advice and the entire issue, it was difficult not to think about the fact that we had read much of this material before, over and over, in the years since (and before) 1992. It was also difficult not to keep returning to the old adage “Insanity is doing the same thing over and over again and expecting different results.”

AISC and steel fabricators have been hammering on some of the points in Thornton’s article for decades, sometimes seemingly with little to show in the way of results. This may not be all that surprising. Why should engineers care about fabrication costs? When I buy a car, it doesn’t come with a pitch from the manufacturer explaining how I can reduce the manufacturing costs of automobiles. Why? Because the auto manufacturers know I don’t care about their costs; I care about the quality and cost of *my* car. More directly, I care about *my* costs and the quality of *my* life.

Instead of telling you how you can make *fabricators’* lives easier and how you can cut *their* costs, we’ve taken a different approach this time around. We’ll give you advice on how to make *your* life easier and how you can cut *your* costs. And we’ll do this by reexamining some of the same topics from a different perspective: *yours*. We must apologize in advance: We couldn’t help being drawn back into the 1990s as we wrote this. There will be periodic 90s slang and references. You’ve been warned.

Weight and Cost: A Discussion

The February 1992 issue included an editorial called “Cutting Costs,” and many of the suggestions in the article are somehow tied to the idea that least weight does not equal least cost. Despite improvements in automation, the second paragraph is largely as true today as it was nearly 30 years ago: “In the past, most efforts concentrated on steel weight reduction as the most effective means of lowering frame costs, with little or no regard to the effect this had on shop costs. But as the price of steel has declined and the cost of labor has increased, the situation has reversed.” This is expressed in another manner in the following quote, which we believe was first stated by Robert Abramson: “Pounds per square foot is only a measure of economy in England!” It is a humorous means of restating the well-known myth “least weight ≠ least cost.”

Fabrication equipment suppliers have recently cracked the code on how to program robots to assemble a structural steel one unique part at a time. Fabricators are buying these machines not necessarily to lower their costs but rather to replace the pool of fitters that are retiring and not being replaced, so the same problem of shop labor costs will continue to exceed material cost for some time to come. Also, because these robots need clear paths for assembly, it is even more important that connection designs need to follow the same old rules we have been preaching all these years.



However, another lesson that has been learned over the intervening three decades is that it often does pay for the engineer to slightly increase a member size if it means that a stiffener can be eliminated. For whatever reasons, engineers overwhelmingly are not judged based on project cost; they are judged based on weight. Though it seems that cost should be the overriding concern of general contractors and owners, the evidence shows that it is not.

Anecdotally, a member of multiple AISC committees that also happens to produce structural design software has indicated that software includes routines to specify heavier members to eliminate reinforcement and provide more logical framing conditions—but alas, this is not the default setting in the software. If the option to eliminate reinforcement in members was selected when running the software, the weight of the structure would increase, and his customers would then provide designs that are heavier than those of other engineers using other (arguably less sophisticated) software, but at a lesser cost to the owner by eliminating the extra fabrication required to install reinforcement in members.

Before abiding by the adage that least weight does not equal least cost, the industry must be provided with a more compelling argument than has been offered for the last three decades. Until the contractors and owners stop thinking of in terms of pounds per square foot and start thinking about total installed costs, the

process and the pain will remain the same. It is difficult to illustrate and affect the total installed cost in the estimating phase unless contractors and owners are willing to involve fabricators and erectors early in the project.

Time is Money

The argument presented in the 1992 article is that material costs had been decreasing, making labor costs the dominant factor in the overall cost of construction projects. Labor costs are the product of the per-hour cost of labor *plus* the hours spent in fabrication and erection. Assuming that the per-hour cost of labor remains steady (or increases), in order to reduce the cost of construction, one must reduce the labor hours spent in fabrication and erection. The logic implicit in much of the February 1992 issue is that if engineers can reduce the cost of construction, they will be rewarded with more work and the rewards these good practices will propagate throughout our industry. It is time to admit the model is flawed. General contractors and owners have shown that they place more emphasis on a simple metric (least weight) than cost. A reduction in the fabricator's or erector's time is not money in the engineer's pocket. A reduction in the *engineer's* time is money in the engineer's pocket. How can the ideas in the 1992 issue save engineers time and put money into their pockets?



The 1992 Thornton article unintentionally makes the argument for providing beam end reactions based on the uniform design load (UDL) and states: “The uniform design load (UDL) is a great crutch of the engineer because it allows him to issue design drawings.” Providing UDL is quicker and easier than providing actual loads. It gets drawings out the door faster, and three decades of experience has shown engineers that performing more work to reduce construction costs is generally not well rewarded in the marketplace. So why not provide UDL? Let’s take a look at a few UDL fallacies.

UDL Fallacy #1: It is difficult to provide actual loads.

Reality: Many popular structural design programs will generate shear loading diagrams automatically.

UDL Fallacy #2: UDL reactions provide extra capacity, which is useful in accommodating changes.

Reality: While there may be some truth to this in some instances, most of the really expensive changes to projects do not involve relative minor increases in load. If changes are anticipated, either during construction or over the life of the structure, there is a middle ground. Many popular structural design programs allow users to include multipliers in shear loading diagrams automatically. In a lot of cases, a significant multiplier can be included before one reaches the demand predicted by UDL.

UDL Fallacy #3: UDL reactions are safe.

Reality: As the name implies, the uniform design load assumes uniform loading. While uniform loading is common, it is not ubiquitous. As stated in the AISC *Steel Construction Manual* (aisc.org/specifications):

“When beams support other framing beams or other concentrated loads occur on girders supporting beams, the end reactions can be higher than 50% of the total uniform load.” An actual load that is higher than the specified load is an unsafe condition. In my experience, it is not uncommon for detailers and delegated connection designers to identify unsafe conditions related to UDL. When this occurs, it is often associated with change orders and increased cost—and it must also be embarrassing to the engineer. More importantly, when it is not caught a condition exists that is potentially unsafe. Even setting aside the potential for property damage and loss of life, the engineer is figuratively living with this problem hanging over their heads for the rest of their lives. One might want to stop and think about this before typing “0.5UDL” into their project specifications.

UDL Fallacy #4: UDL is quick and easy.

Reality: Thornton describes UDL as “a great crutch.” This is a pretty good description. If I find I have injured leg, I would very much appreciate a great crutch to get me through the difficulty, but I doubt there is a crutch made that is great enough for me to continue using it once my leg is healed.

If it is 7:00 p.m. and my kid’s recital is at 8:00 p.m. and I have to catch that noon flight tomorrow and these drawings *have* to be in the architect’s hands in the morning, then maybe I use UDL. Maybe I am looking for “a great crutch”—but as I do so, I have to recognize there is a price to pay. What is expedient in the short term is not necessarily the best long-term solution. On top of that, a quick glance in the crystal ball reveals my future in this situation:

- “What do we do with ‘short’ beams?”
- “Please confirm this load.”
- “Do I need a doubler?”
- “You can’t put that haunch there.”
- “That was not shown in the drawings. It’s going to cost you.”

Risk is Money

Contract documents should not be like a box of chocolates. You *should* know what you are going to get when bidding a project. Assigning a fair or reasonable cost to risk is difficult; assessing a fair or reasonable cost to an unknown risk is likely impossible. If you ask someone to do the impossible, you should expect two things: (1) it is going to cost a lot and (2) they will fail. Not really the best situation. Incomplete drawings, catch-all specifications, recycled and unrealistic details, and variations from common practice all add uncertainty to projects, and all increase the perception of risk and ultimately the cost of the project. What Dave Ricker stated back in his own article in the February 1992 issue (“Value Engineering and Steel Economy”) is just as true today:

- “The bids will undoubtedly be inflated to cover whatever might be ‘implied.’ **This is unfair to the client.**”
- “A complete design is the best assurance that those who must use that design will accurately interpret the intent of the designer. There will be far less chance for ambiguities, misinterpretations, errors and/or omissions. Design shortcuts can only hurt the other members of the construction team. **A complete design benefits everyone in the long run, including the designer and the client.**”

One big source of uncertainty involves local reinforcing at connections. Has the column been sized to eliminate it? Was it shown in the bid documents? Is it included in the bid? Is this “extra” reasonable?

We are sure that somewhere on the planet, there is someone who really enjoys spending late nights and weekends answering these sorts of RFIs. If you know this person, please do not introduce us. If you are this person, you have our sympathies and we hope you recover. If you are not this person, then we have good news for you. AISC makes a tool that will save you time and money and eliminate those pesky RFIs that are clogging up your inbox and making you look old and tired. It is called Clean Columns, and you can download it at steeltools.org/column.php.

It is true that the 2016 AISC *Code of Standard Practice for Steel Buildings and Bridges* (ANSI/AISC 303, aisc.org/specifications) has formalized the process of addressing this uncertainty, making it far easier to spend your time tearing out your hair and gnashing your teeth. But why bother when you can simply bump up the column and spend the time you save doing something you enjoy? Thornton endorsed the use of “clean columns” way back in 1992. It’s all that and a bag of chips. Word.

Make Your Life Easier

To paraphrase one of the top hits from 1992, “I like big bolts, and I cannot lie.” If you are like us, there is nothing you like more than reading about bolts, sitting in hotel meeting rooms far from your loved ones talking about bolts, and arguing about bolts with people who prominently pronounce the “n” in column. If on the other hand you’d rather be chillin’ out than worrying about bolts, then stop worrying about bolts. It is a no-brainer. Use snug-tight bearing connections.

Every detail shown in Thornton’s article uses “bearing bolts.” And Ricker’s article states: “Do not specify slip-critical values for the purpose of obtaining an extra factor of safety.” It also states: “Allow the use of tension control (twist-off) high strength bolts.” Bill Dyker and John D. Smith agree, in their February 1992 article “What Design Engineers Can Do to Reduce Fabrication Costs”: “Designers should

A Challenge to Owners

Mainstream economics assumes that people are driven by the rational pursuit of self-interest, and self-interest is a powerful motivator. This article is directed toward engineers and attempts to make the argument that some practices that have long been known to reduce the cost of steel structures should be adopted by engineers based solely on the self-interest of the engineer. However, for self-interest to be a rational driver of the economy, economics systems cannot be a zero-sum game.

A successful and well-run structural steel project produces multiple winners and no losers. The goal of the owner should be to optimize profit (of interest here by minimizing construction costs) and reduce risks (as risks endanger profits). Recognizing that practices that reduce the cost of steel structures and eliminate uncertainty are more likely to increase profits, owners should be rewarding engineers who reduce costs and risks by awarding them projects and also potentially through greater fees or other incentives—in other words by appealing to the engineer’s self-interest.

The October 2017 article “Reinforcing the Point” offered advice to owners and included the statement “The fallacy that the cost and weight of steel structures are correlated distorts the proper functioning of the marketplace by introducing incentives that increase both cost and exposure to risk.”

According to the Construction Management Association of America, “Construction management is a professional service that provides a project’s owner(s) with effective management of the project’s schedule, cost, quality, safety, scope, and function. Construction management is compatible with all project delivery methods. No matter the setting, a construction manager’s (CM) responsibility is to the owner and to a successful project.”

The next time a CM gives you the weight of your structure as a metric, ask him or her why.

- Ask, “How does the weight relate to the cost of the project?”
- Ask, “How does minimizing the weight reduce the owner’s risk?”
- Ask, “How many RFIs (requests for information) were sent?”
- Ask, “What amount of money was represented by these RFIs?” This is a measure of uncertainty and your risk.
- Ask, “Why did information that should have been provided have to be requested?”

We challenge owners to change the incentives for structural steel projects so that they can fully realize the benefits of structural steel—in other words, we challenge them to act in their own self-interest.

This Modern World

Data, data everywhere.

We live in an age of big data analytics, a much different landscape than 1992, when the articles referenced in this article were published. Since the 1990s, the number of universities offering degrees in construction management has grown. Presumably the skills exist and data can be obtained and analyzed to validate or refute the proposition that least weight does not equal least cost. Presumably the uncertainty associated with member reinforcing, incomplete documents, and unrealistic loads—which lead to RFIs, controversies, arguments, extras, and in the worst cases lawsuits—do not ultimately benefit the owner. Or if, surprisingly, they do benefit the owner, the benefit can be demonstrated and quantified.

Science and technology increasingly drive our practices. According to the American Iron and Steel Institute (AISI), “Labor productivity [in steel making] has more than tripled since the early 1980s, going from an average of 10.1 man-hours per finished ton to an average of two man-hours per finished ton in 2006.” This increase in productivity is arguably more substantial than the increase that occurred in the preceding six decades. Steel production, and production in general, is more science than art today than it once was. Many workers in steel mills today spend much of their time in front of monitors doing what, from the perspective of the uninitiated, might appear to be very little. They are, however, ensuring things run smoothly. This is a lesson that needs to be translated into construction.

For many workers today, their email inbox serves as a proxy for their “work” or even their worth. The thinking goes that the more emails one has processed, the harder they have worked and the more they are worth. This is another poor metric. The email (RFI) count on a construction project more likely is a measure of uncertainty and risk. Every RFI reflects an unanticipated need for information. For a well-run project, a significant amount of time should not be spent putting out fires but rather preventing the fires in the first place. It is called being proactive, a word that oddly enough became quite popular with management types back in the 1990s.



not call for A325-SC bolts unless they are meeting the criteria for the use of such bolts as listed in the ASTM A325 *Specification*. In its publications, AISC is placing more emphasis on using bearing type connections.” And don’t forget Barry Barger, who in the same article urged engineers to “stop using friction bolts (slip-critical) when bearing bolts are adequate.”

The idea behind a bearing connection is that you have a hole, a rod that goes through hole to keep things from moving, and a nut holds everything in place. It is that simple. Don’t sweat it—and don’t “screw” it up. Some facts:

- Snug-tight, bearing connections have been in the AISC *Specification for Structural Steel Buildings* (ANSI/AISC 360, aisc.org/specifications) since 1989. Ah, the much beloved “Green Book” (no relation to the recent film).
- Slip-critical bolts are almost never required in buildings.
- Pretensioning of bolted connections is not required for floor beam connections.
- There are no specific minimum or maximum tension requirements for snug-tight bolts. Bolts that have been pretensioned are permitted in snug-tight connections. Tighten them, don’t tighten them, whatever. It’s all good.
- Tension-control (TC) bolts can be used in snug-tight, bearing connections. Feel free to break the spline if you like.

Similar things can be said of welding. Do you even own a copy of AWS



D1.1? Then why would you over-specify welds? Stick to the information required in AWS D1.1. Don't have a copy? Contact the AISC Steel Solutions Center. They won't give you a copy, but they can provide guidance. Email them: solutions@aisc.org.

Want More?

If you want to ride the time machine too, then read the February 1992 issue yourself. It is available for free download, like all back issues of *Modern Steel Construction*, at modernsteel.com/archives.

Apparently we really, really like writing about this topic. If you really, really like reading about it, check out the additional resources in the "Tips, Tips, and More Tips" sidebar. There's a lot of advice there, and let's be honest, most of you aren't going to follow any of it. But you should at least consider doing some of the stuff above that will save you time, money, and headaches. We are sure once you start improving your life, you will find lots of other hacks (whoa, that was an abrupt shift back to the 2010s). In the process, you will probably save us all time, money, and headaches as well. It is a win-win. Peace out. ■

Tips, Tips, and More Tips

Do you like reading? Do you like tips about how to design more efficiently? Here are several past *Modern Steel Construction* articles—all available at modernsteel.com/archives—that collectively offer literally hundreds of design tips.

- Economy in Steel – April 2000
- Reducing Fabrication Costs – April 2000
- Value Engineering for Steel Construction – April 2000
- 59 Tips and More for Economical Design – January 2008
- 24 Tips for Simplifying Braced Frame Connections – May 2006
- 20 Tips from the Top Project Managers – October 2011
- 57 Tips for Reducing Connection Costs – July 2003
- 98 Tips for Designing Structural Steel – September 2010
- Tips to Take your Team to the Top – February 2014
- Best Tips of the 21st Century: Connections – February 2011
- Tips for Designing Constructable Steel-Framed Buildings – March 2011
- 30 Good Rules for Connection Design – May 2004
- An Ounce of Prevention – May 2004
- Reinforcing the Point – October 2017

**UNIVERSAL PIN CONNECTORS™
+ ARCHITECTURAL TAPERS™**

CASTCONNEX™
innovative components for inspired designs

ROY BICKELL PUBLIC SCHOOL

www.castconnex.com

business issues TIDY UP

BY ANNE SCARLETT



Anne Scarlett is president of Scarlett Consulting, a Chicago-based company specializing in AEC-specific strategic marketing plans, marketing audits, and coaching. She is also on the adjunct faculty at Columbia College of Chicago and DePaul University. She can be contacted via her website, www.annescarlett.com.

What makes an existing client a good fit versus a bad fit? It's up to individual firms to decide for themselves.

How to maintain a client roster that sparks joy.

THERE ARE AMAZING CLIENTS, decent clients, and all-out bad clients.

As the end of this year approaches, while you're likely taking a hard look at your business strategy, it's also a good time to carefully assess your client base. Enter a riff off the KonMari method.

The KonMari method—Marie Kondo's approach to life change through massive de-cluttering—rose to prominence this year, thanks to her Netflix series *Tidying Up with Marie Kondo*. In brief, Kondo places special emphasis on selecting items to keep rather than items to discard. Further, she insists those keep-worthy items must spark *joy*, or alternatively, spark an *appreciation* for their usefulness. It's no surprise that people are applying relevant KonMari lessons to aspects beyond their home: relationships, office environments, and their social media outlets. I propose applying it to your client list as well.

While there's no surefire rule of thumb for the number of clients to divest annually, suffice to say that many AEC firm leaders have learned that bad clients are a detriment to a firm's overall health and prosperity. While this is true in all economic climates, it's especially true during stable times (which, admittedly, we aren't currently experiencing), where firms have more confidence in dismissing their difficult clients.

Good or Bad Fit

What makes an existing client a good fit versus a bad fit? It's up to individual firms to decide for themselves. My suggestion is to bring together business, marketing, and human resources to identify and prioritize your firm's criteria. Just a few loosely organized examples could include:

Business strategy and health.

- Brings profitability (obviously!), measured both by percentage of profit margin as well as actual dollar amount.
- Offers repeat business opportunities, with low (or no) marketing costs to secure those projects.
- Keeps valuable staff busy and on payroll.
- Fits with strategic vision and goals.
- Maintains balance by helping to attain the right composition of large and small clients that your firm can service.

Versus:

- Repeatedly breaks even or loses money.
- Prioritizes low price over results, quality, and experience.
- Provokes scope creep.
- Slow to pay.

Marketing.

- Expands foothold within market sector (education; commercial; etc.) and/or project type (new construction; renovation; etc.).
- Offers entry into a new strategically identified sector.
- Provides brand name exposure if client is high-profile.
- Builds relationships with external business partners on the project team.

Versus:

- Doesn't add depth or breadth to portfolio.
- Resides within a market sector no longer desired.
- Distracts from efforts towards other client pursuits (opportunity costs).

Human Resources.

- Provides joy to the project team members—if stimulated by intrigue, challenge, opportunity, innovation.
- Interacts with respect and honesty.
- Maintains their end of the agreement during every step of the project.

Versus:

- Causes burnout, frustration, low esteem.
- Communicates poorly, or is unresponsive, negligent, even negative.

Making It happen

In the KonMari method, Kondo encourages a proper “thank you for your service” before saying goodbye to a material object. Divesting a client takes it to a higher level, requiring human-to-human respect, consideration, and clarity. Occasionally, such as in the public sector, you may be able to simply stop submitting proposals for new projects. But in most cases, it will require a direct, honest conversation between the project manager (or principal in charge) and the client contact. A few tips:

- *Of course* complete any project(s) still under contract. Collect outstanding monies.

- Break the news by voice—either in person or via phone. Follow up in writing for complete clarity.
- Offer an explanation to the level of detail you feel most comfortable. It could be as simple as: “In creating our strategic business plan, we realize that we need to make changes in our client roster. As such, we will no longer be able to serve your organization.”
- If possible, craft your message to appeal to the soon-to-be-former-client’s own self-interest. “This move makes good sense for you too, as it’s best for you to work with a provider that is equipped to handle your unique needs.”
- Be clear on the expectations and next steps, such as the final service your firm will provide, wrapping up loose ends, transferring information, etc.
- If you have a solid relationship with the client contact, you can also informally (by voice) offer names of service providers that could be a better fit for their goals, project types, personalities, business model, etc.

If your firm already makes a habit of assessing and shedding bad clients on a regular basis, kudos to you. If you are new to this notion, the question is this: Are you ready to take the steps to declutter your client list, make room for new opportunities, and infuse joy and positive change into your business for 2020? ■

NEW!

SEE IT AT
FABTECH
BOOTH A2169

**ACCELERATING
YOUR
PERFORMANCE**



VOORTMAN STEEL MACHINERY

**ALL-IN-ONE
MACHINE
DO IT ALL IN
A SINGLE
PASS!**

IN STOCK NOW!

- ▶ FINANCING AVAILABLE
- ▶ FASTEST ROI

**VOORTMAN
V807**

ROBOTIC THERMAL
PROFILE PROCESSOR



- ▶ Fully automated processing from loading to unloading
- ▶ Footprint reduced 50%
- ▶ Copers, rat holes, slots, block outs, jay allan, dog bone, layout marking and more
- ▶ Capable of plasma and oxy-fuel cutting
- ▶ Stock systems available in North America

FABTECH

NOVEMBER 11-14, 2019 **BOOTH A2169**

Chicago, IL USA



VOORTMAN USA

26200 S. Whiting Way +1 708 885 4900
Monroe, IL 60449 info@voortmancorp.com
United States of America www.voortmancorp.com





coping



oxy-fuel cutting



plasma cutting



bevel cutting



layout marking







Winging It

BY CHRIS A.
CHRISTOFOROU, PE,
AND ILIANA
KARAGIANNAKOU, PE

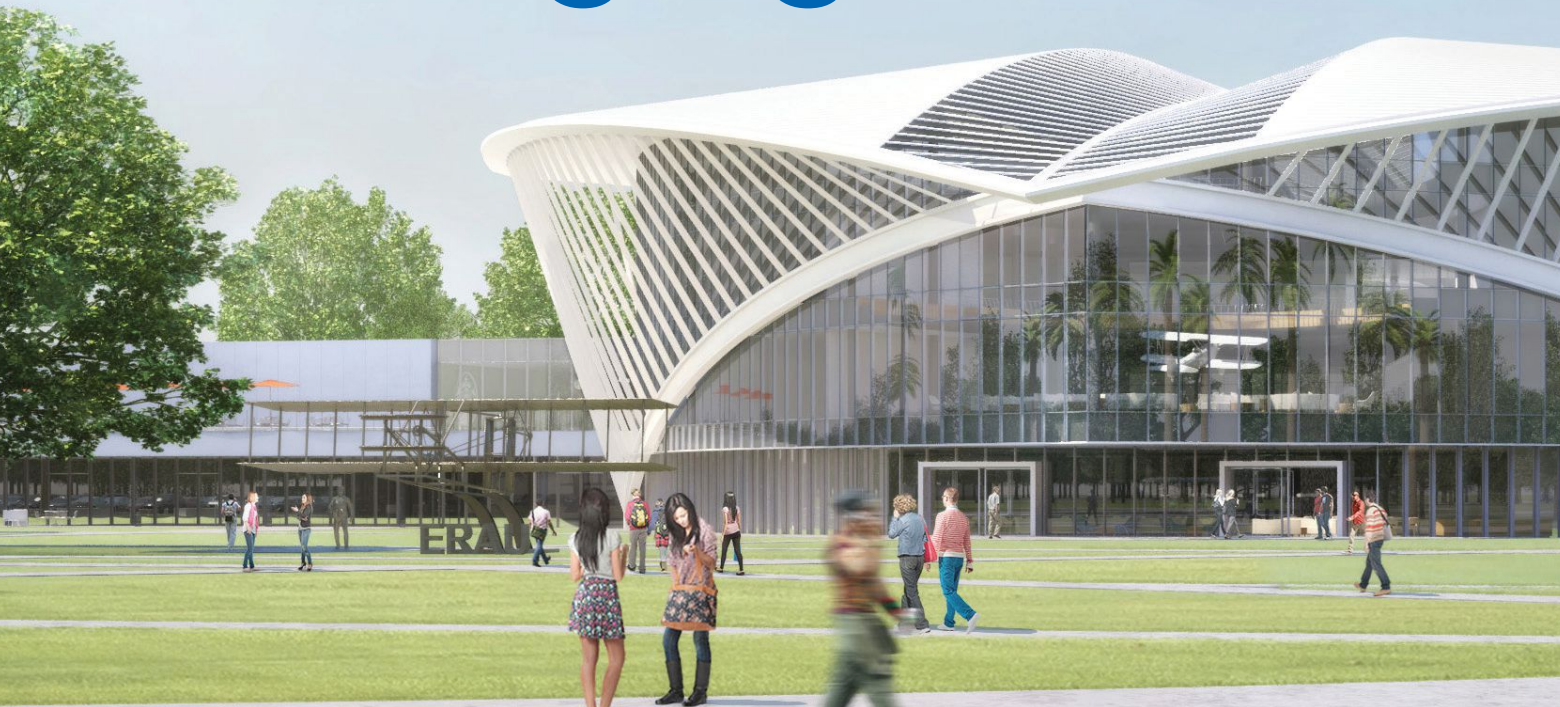

Chris A. Christoforou is a principal and office director and **Iliana Karagiannakou** is a project engineer, both with Thornton Tomasetti's Newark, N.J., office.

THE EAGLE HAS LANDED.

In this case, not on the moon but rather on the top of Embry-Riddle Aeronautical University's (ERAU) stylish new student union building at the center of the school's campus in Daytona Beach. The monumental double-curved steel roof, the building's signature element, is designed to invoke the wings of a bird in flight—specifically an eagle, the school's mascot.

Designed by ikon.5 architects, the new steel-framed building sits on the southeast side of ERAU's Connolly Quad and replaces an existing three-story masonry building that formerly housed the school's library. The 178,000-sq.-ft development consists of two components (using nearly 2,000 tons of steel in all), separated by an expansion joint: a 120,000-sq.-ft four-story main building and an adjacent 58,000-sq.-ft two-story event space featuring a 100-ft span whose roof is supported by 7-ft-deep trusses. The new union brings together a range of amenities and services for the campus' 5,000-plus students, including learning and social areas, an event space that can accommodate up to 900 people, student resource offices, a dining facility, the university library, and a soaring three-story commons area capped by a 300-ft-long, 50-ft-wide arching skylight that runs down the center of the building. Named after notable alumnus and chair of ERAU's board of trustees, Mori Hosseini, the \$75,000,000 Mori Hosseini Student Union was officially dedicated last fall.

The framing system at levels two, three, and four consists of 6½-in.-thick (3½-in. light-weight concrete on 3-in. metal deck) composite flooring spanning approximately 11 ft between floor beams. The beams, typically W18, span between W21 girders, which in turn span between hollow structural section (HSS) columns—typically HSS16 as tall as 42 ft and using 7½-in.-thick continuity plates—set on an approximately 22-ft by 34-ft grid, with a lon-

At a Florida aeronautical school,
the sky's the limit for a
new student union topped by
an avian-inspired steel roof.



above: A view from ground level showing an exterior arch and struts during construction.

left: The new facility, whose three-story commons area is capped by a 300-ft-long skylight, uses nearly 2,000 tons of structural steel in all.

below: One portion of the commons space features a ceiling adorned with stars.

ger span at the center axis (50 ft at level 4). Lateral stability is provided by conventional steel chevron braced frames, which were designed to resist hurricane-level wind forces (147 mph per the 2014 *Florida Building Code*). Level one consists of conventional slab-on-grade construction, and the foundation consists of isolated footings beneath the columns and combined footings beneath the braced frame cores to resist the uplift forces.

Wing Span (and Spine)

The geometrically complex roof framing consists of architecturally exposed structural steel (AESS) elements—some as Category 1 and some as Category 2—and features a double-girder central spine off of which stretch a series of moment-connected “wing” beams. The spine spans the full length of the building’s north-south axis, extending beyond the façade approximately 50 ft at both the north and south tips. Similarly, the wing beams cantilever outwards 20 ft to 40 ft, creating a perimeter overhang at the roof. This overhang is supported by vertical struts as well as external arches that rise from the ground to reach the roof at its lowest points at the north and south tips. These arches, also AESS, are made from 4-ft-deep built-up box girders that are curved both in plan and in elevation. The plates were cold-formed and cut to size to create the curve of the beams.

The main roof framing consists of 3-in. metal deck spanning approximately 8 ft between secondary roof purlins (W12 beams).



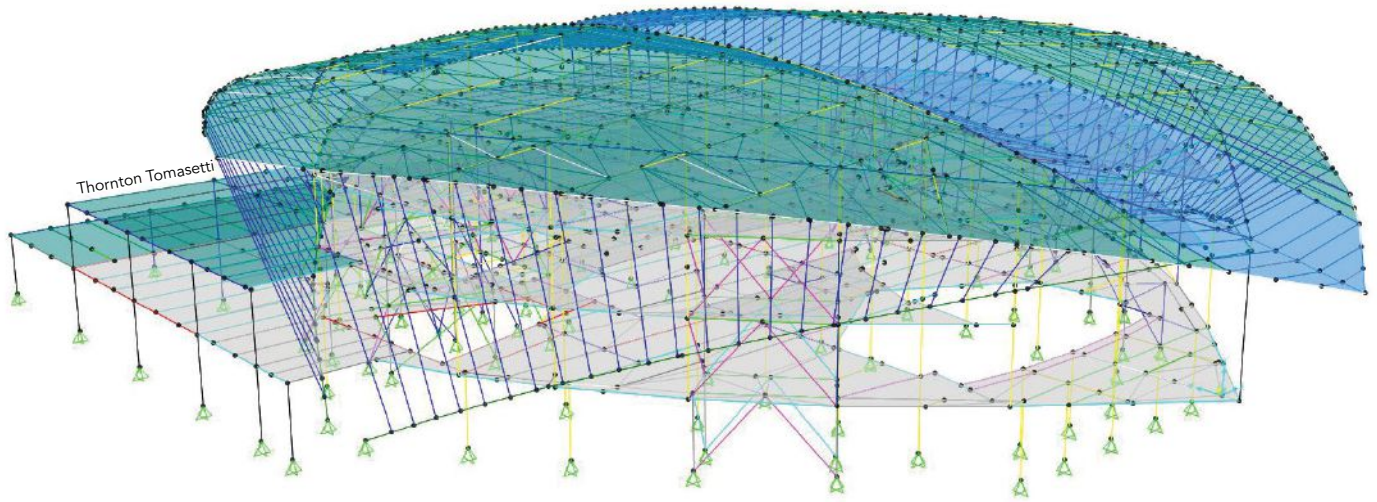

above: A SAP 3D analysis model of the two connected buildings. Once built, the structure behaved very closely to what was predicted in the analysis model.

below: In staying true to the school's aeronautical focus, the roof of the new facility is designed to resemble the wings of a bird in flight.



Chad Baumer Photography

The purlins are supported by the main girders, which are W30 beams, and span between and are moment connected to the HSS columns. Due to the complex geometry and in order to facilitate deck attachment without warping the deck, the secondary purlins are curved in elevation and are set approximately 3 in. higher than the main girders, which are straight members that slope in elevation following the roof geometry.

The central spine beam is an AESS element consisting of two adjacent wide-flange shapes (W21) with a continuous top steel plate

formed into one element, which is curved in elevation. HSS10×4 elements spaced 4 ft on center provide lateral stability to the central spine beam moment frame and also act as support members for the 50-ft-wide central skylight purlins. The spine beam and wing girders that form the perimeter roof overhang are designed as cantilevers to support construction loads. The wind deflections are controlled by the perimeter struts (HSS12×8), which are in turn supported by the arches. In order to avoid transferring loads to the struts during construction, the connection of the strut to

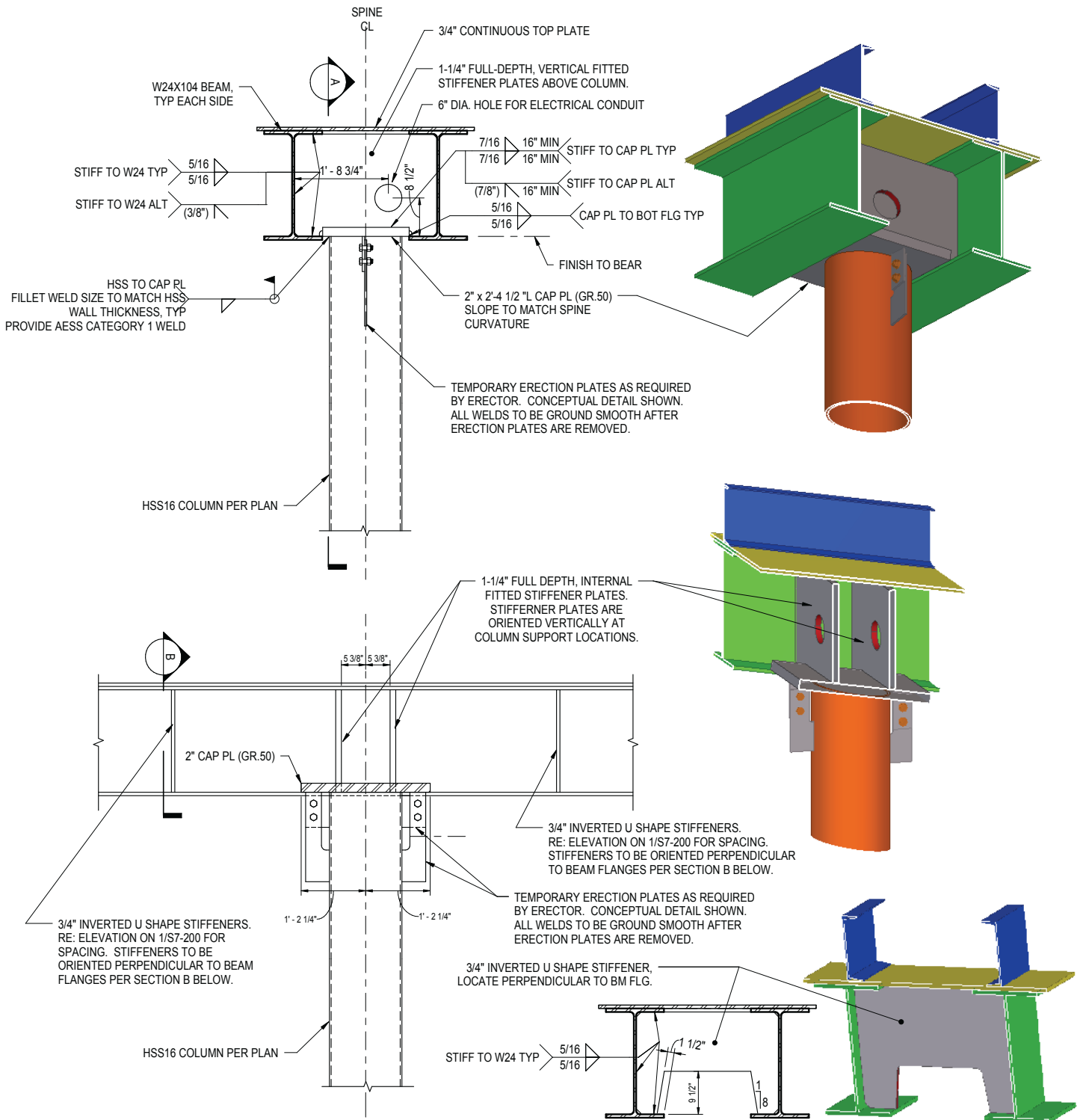

Main-spine-beam-to-column connections as detail drawings and modeled in Tekla.

the roof beams was detailed with slotted holes, which allowed roof deflection during construction. The overall lateral stability of the roof is provided by a combination of moment frames between the roof girders and the columns and the indirect bracing action of the curved arches.

Transferring Complex Geometry

Curved elements always bring an extra layer of complexity to a project. As design progresses, updating geometries can become a

time-consuming process and increase the chances of inaccuracies in the building model.

In order to avoid these issues, CORE studio, the research and development arm of the project's engineer, Thornton Tomasetti, wrote a Grasshopper script to translate the complex geometry of the roof structure, arches, and struts from the architectural Rhino model to the structural analysis model. Additionally, Konstru, a cloud-based automation tool developed by CORE studio, allowed the model to be constructed in one platform



Steel, LLC

above: Steel framing for the two-story event building with framing for the four-story main building rising behind it.

below: A 3D Revit model of both portions of the project, which are separated by an expansion joint.

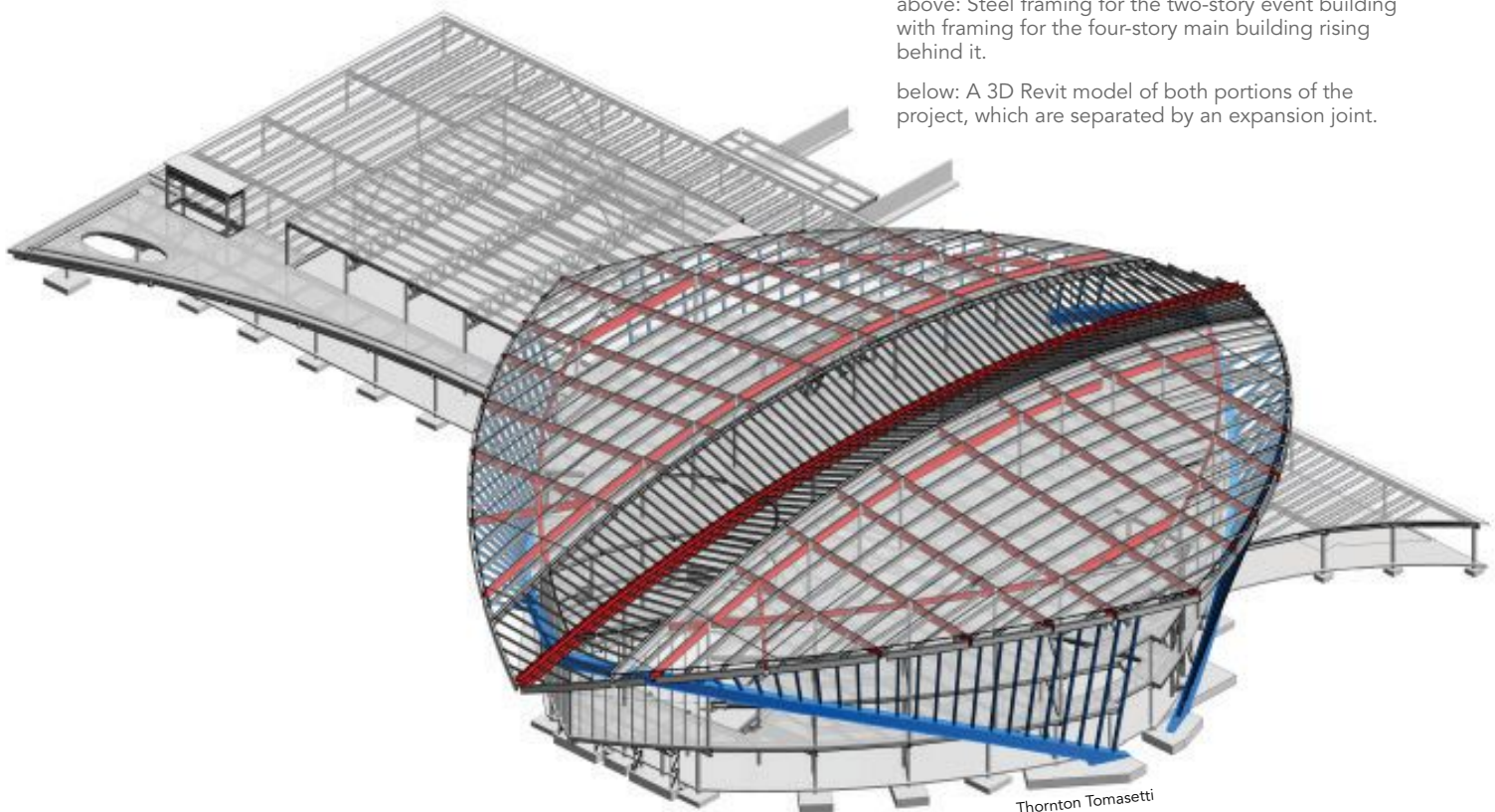

Thornton Tomasetti

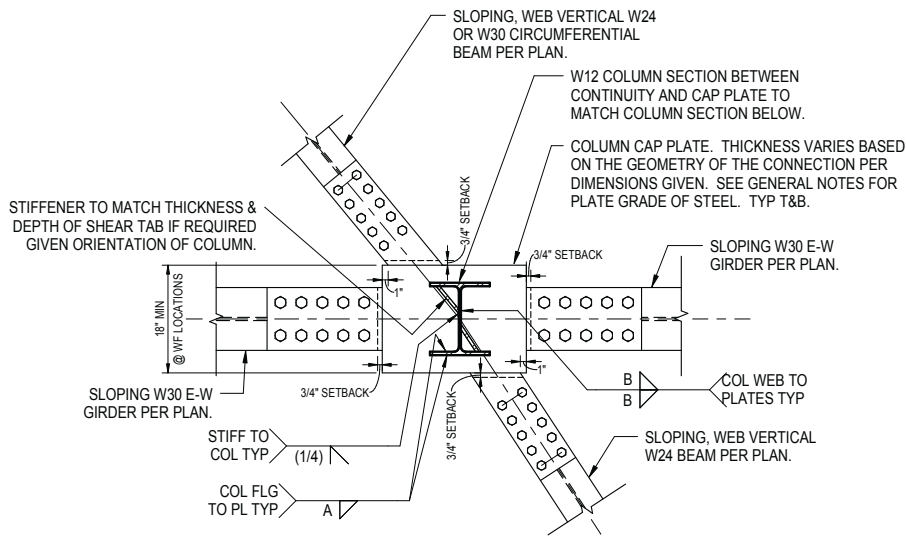

PLAN VIEW - ALTERNATE AT WF COLUMN LOCATIONS

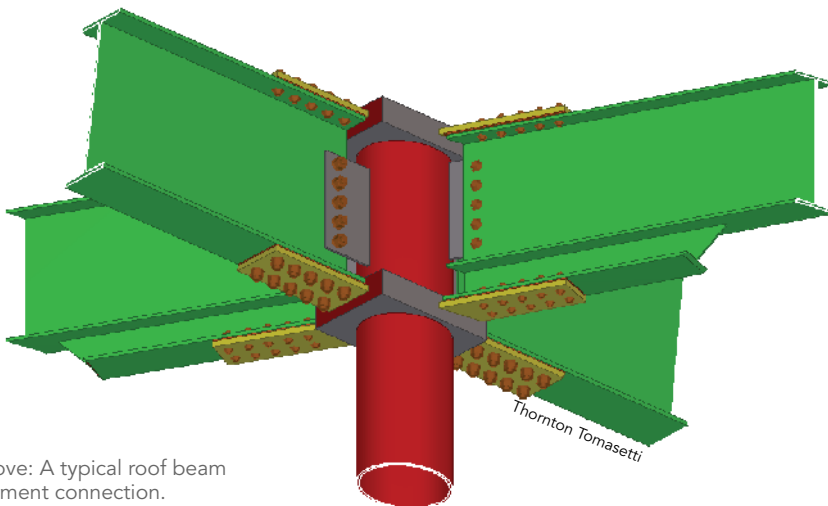

above: A typical roof beam moment connection.

below: A view of the spine beam during construction.



while providing the flexibility to transfer the exact same geometry to another platform and link both models so that they updated identically as design progressed. This process ensured accurate design and documentation and resulted in a structure that, once built, behaved very closely to what was predicted by the analysis model.

Another design challenge arising from such a complex structure was detailing the connections of the individual roof piece marks to form the desired geometry. Because of exposed steel connections and curved geometry, designer ikon.5 architects wanted to control the final appearance of the connections from an early design stage. As a result, Thornton Tomasetti designed all the roof connections and created a 3D Tekla model that helped ikon.5 understand the final look of the exposed connections. Despite the roof's complexity and uniqueness, Thornton Tomasetti's engineers delivered an extremely efficient steel structure that demonstrates engineering excellence and reflects the close collaboration between architect and engineer.

Although working on a complex structure, the team's approach to the steel construction was to use typical erection methods with temporary shoring under the spine beam and arches until all steel was fully erected and all connections were complete. The building was erected in separate quadrants, from ground to roof. At the final condition, the spine beam, arches, and wind beams deflected exactly as predicted. ■

Owner

Embry-Riddle Aeronautical University, Daytona Beach, Fla.

Construction Manager

Barton Malow, Daytona Beach, Fla.

Architect

ikon.5 architects, Princeton, N.J.

Structural Engineer

Thornton Tomasetti, Newark, N.J.

Connection Designer and Erection Engineer

McGill Engineering, Tampa, Fla.

Steel Team

Fabricators

Steel, LLC, Scottsdale, Ga. 

Greiner Industries, Mount Joy, Pa. 

(Exterior box girders)

Erector

Superior Rigging and Erecting

Company, Inc., Atlanta 



All photos except left portion of above image: SDL

Steel Coliseum

BY ALLISON CLARK, PE

A steel-framed replica of an ancient architectural icon brings new capacity to a corporate headquarters with old-world charm.

IF YOU VISIT Jackson Healthcare's headquarters in the Atlanta suburb of Alpharetta, you may think you've suddenly been transported to Rome.

This is thanks to Jackson's founder and CEO, Richard Jackson, and his son, Shane, its president, who have both developed a love of classic Italian architecture after several trips to Italy. And when planning a multi-structure expansion of the company's headquarters, they envisioned an Italian piazza. Now open, the addition's centerpiece is a three-story, steel-framed amenity building designed to look like the Roman Colosseum. (Alas, no gladiator fights are scheduled to take place.)

The programing for this building, called the Coliseum, includes a cafeteria at grade level (complete with a stone hearth

pizza oven); a fitness area, locker rooms, and a pool on the second level; and an additional fitness space and outdoor terrace on the third level. A monumental stair connects the level 2 and level 3 fitness spaces, and above the roof is a 14-ft-tall parapet with a partial high roof at the perimeter of the building.

Lateral and Vibration Considerations

One of the first challenges for the Coliseum was determining the best lateral system. The desire for large open interior areas and windows between almost every exterior column made it difficult to locate braced frames. The tall floor-to-floor heights (20 ft at the first level and 16 ft at levels 2 and 3) and the building's oval shape made a moment frame solution challenging as well. However, the shape

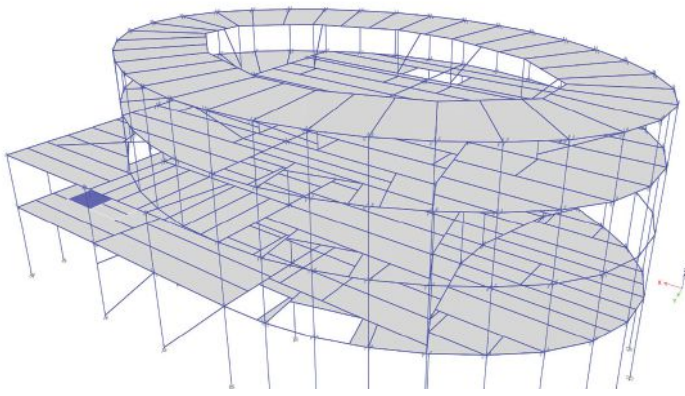

above: An ETABS analysis model of Jackson Healthcare's new Coliseum amenity building, whose floor plan transitions from part rectangle and part oval at the bottom two floors to a complete oval at the third floor.

opposite page: The new steel-framed building was inspired by the Roman Colosseum.

right: The three-structure expansion uses nearly 1,000 tons of structural steel, the majority of which is in the Coliseum.

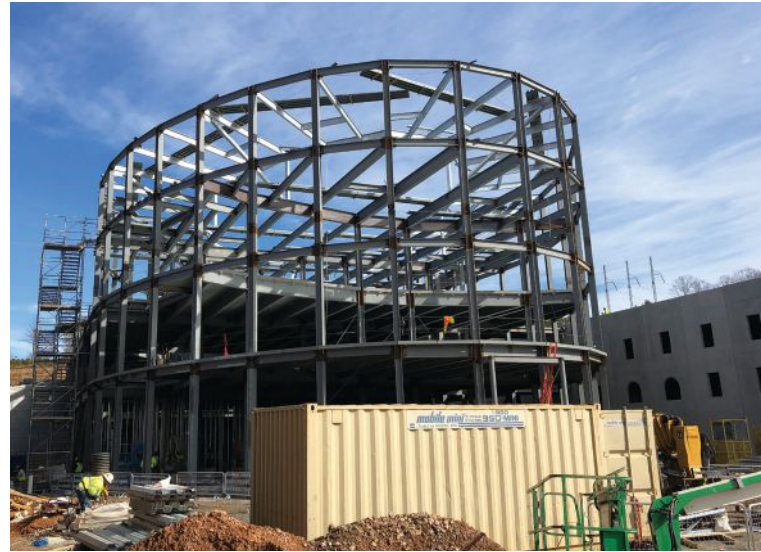

Spurred by multiple visits to Italy and an appreciation for the Las Vegas interpretation of classic Italian architecture, Jackson Healthcare's CEO and president instructed the design team to make their headquarters' expansion look like an Italian piazza.

opened the door for another option. As the curved design resulted in a greater number of columns than would normally be seen in a more traditional rectangular footprint, this created an ideal opportunity to employ partially restrained moment frames, using all of the columns, perimeter beams, and interior girders as frames in the lateral system. W12s were used for the columns and beams ranged from W14x48s for the moment frames up to W36s where beams had to pick up transfer beams. As partially restrained moment frames typically use all-bolted connections, field welding for the moment connections was kept to a minimum.

A related challenge was the steep grade between an existing office building (the original headquarters) and the new plaza area. At the amenity building's location, a 30-ft-tall permanent tie-back wall was needed to retain soil due to the desired finished grade elevations. During the project's design development phase, the team explored the idea of tying the building into the tie-back wall and designing the wall to resist some of the building's lateral forces. But due to construction schedule considerations and concerns over temporary earth



Allison Clark (aclark@sdlal.com) is a senior structural engineer with Stanley D. Lindsey and Associates in Atlanta.

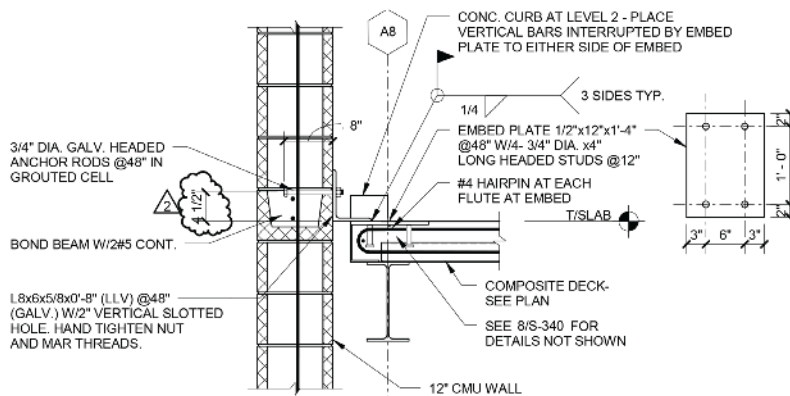

The building's foundations, with the CMU and tie-back wall at top of photo.

movements, they ultimately decided to separate the permanent tie-back wall from the structure. The final design includes a CMU wall built parallel to, and 3 ft away from, the tie-back wall. The CMU is connected to the building at levels 2 and 3 and used as a shear wall to resist lateral loads. As gravity loads from the second-story pool were determined to be too large for the CMU wall to support, connections from the steel framing to the CMU wall were designed to transfer only lateral loads and included slots to allow for slab deflection to prevent gravity loads from being transferred to the wall.

When it came to vibration considerations, the planned aerobic activity in the fitness center was of particular concern. AISC Design Guide 11: *Vibrations of Steel-Framed Structural Systems Due to Human Activity* was used to evaluate the vibrations, resulting in a thicker, heavier slab with heavier and deeper beams and girders being used at level three to keep the vibrations within acceptable limits (with W18 and W21/W24 beams being used on level 2 and W27 and W30 beams on level 3). The design guide was also consulted for the building's monumental stair between the second- and third-floor fitness areas to confirm that vibrations would not be an issue. The stair is composed of architecturally exposed structural steel (AESS)

above: Connections from the steel framing to the CMU wall were designed to transfer only lateral loads and included slots to allow for slab deflection to prevent gravity loads from being transferred to the wall.

right: A SAP2000 model of the monumental stair between the second- and third-floor fitness levels.

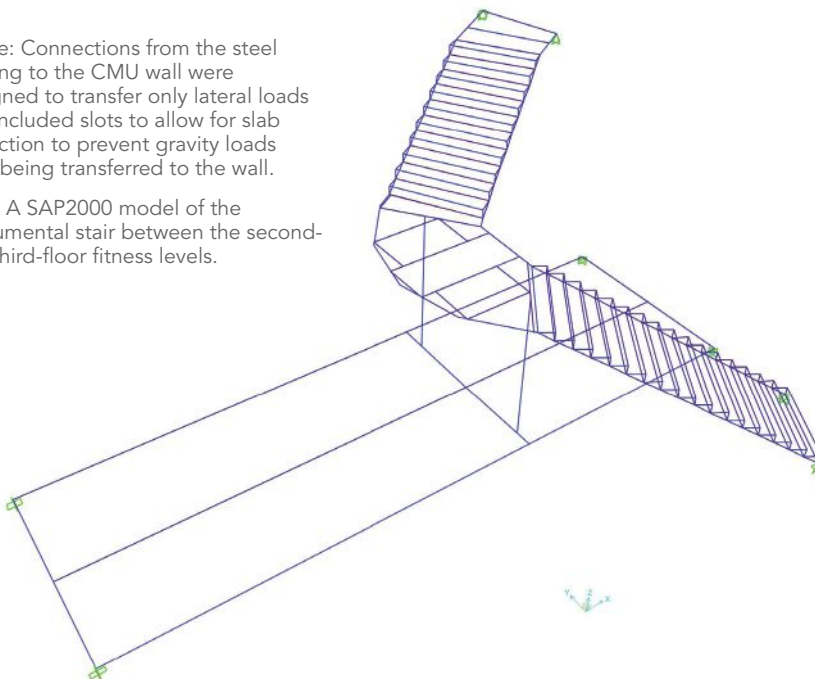

HSS12x2 stringers and HSS6x6 support posts at the landing.

The team modeled the building in ETABS, which has the capability to create moment curvature graphs for custom non-linear links to model the partially restrained moment connections. Two moment curvature graphs were created for each connection: one was used for serviceability checks and a second was modified with a reduced stiffness for use in the direct analysis method strength checks. The unique geometry of the building required close coordination between Stanley D. Lindsey and Associates and steel fabricator Stein Steel during the shop drawing phase of the project, and a few variations of the partially restrained moment connection were added to the drawings during this phase to improve the constructability.

Working around the Pool

At the third level, the building footprint changes shape, resulting in nearly half the columns above that level needing to be transferred out. (The building's shape is half-oval, half-rectangular until it reaches above grade on the back side, at the tie-back wall, where the entire floor plate becomes an oval.) To further com-

.....
right and below: The stair is composed of architecturally exposed structural steel (AESS) HSS12x2 stringers and HSS6x6 support posts at the landing.

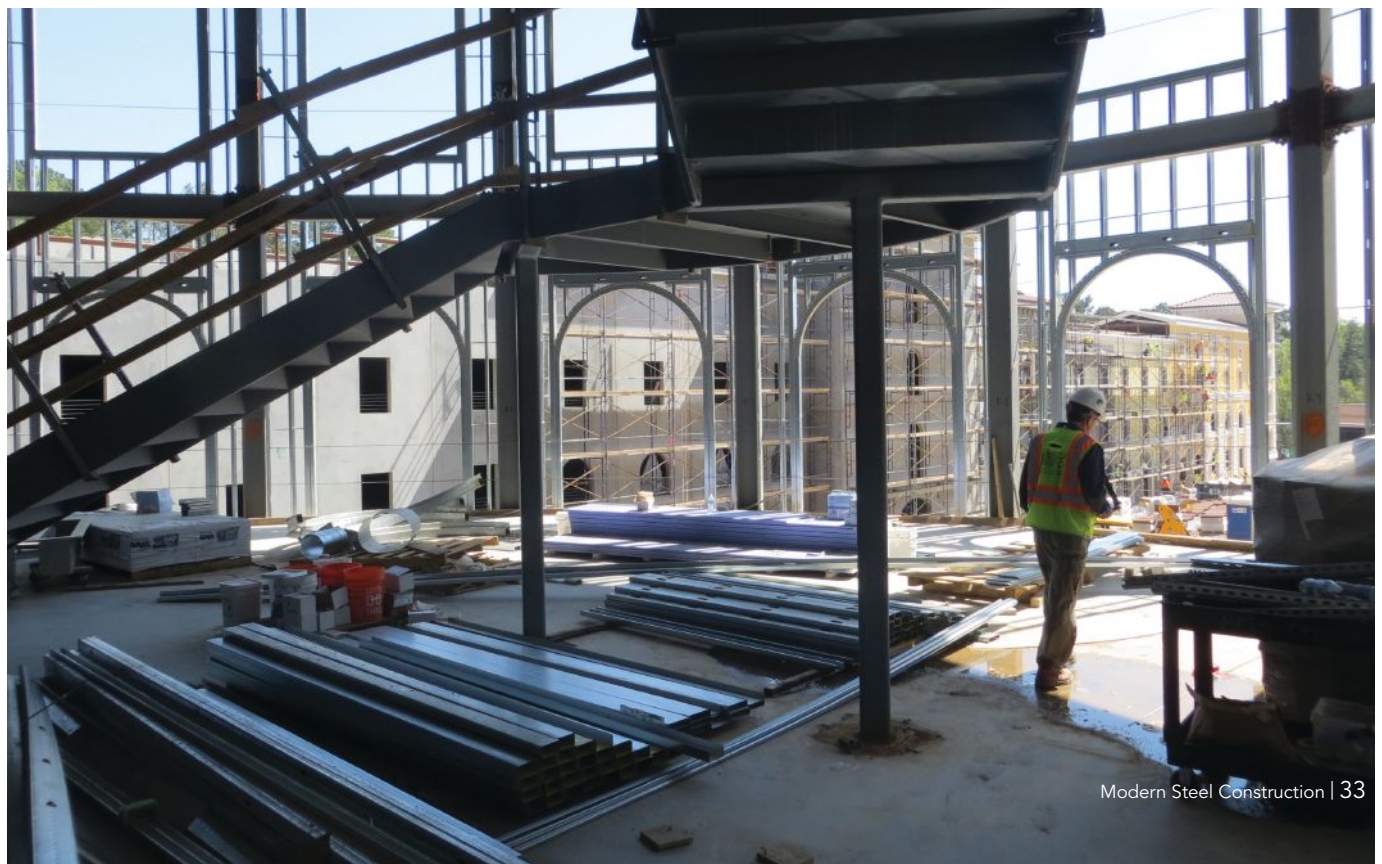
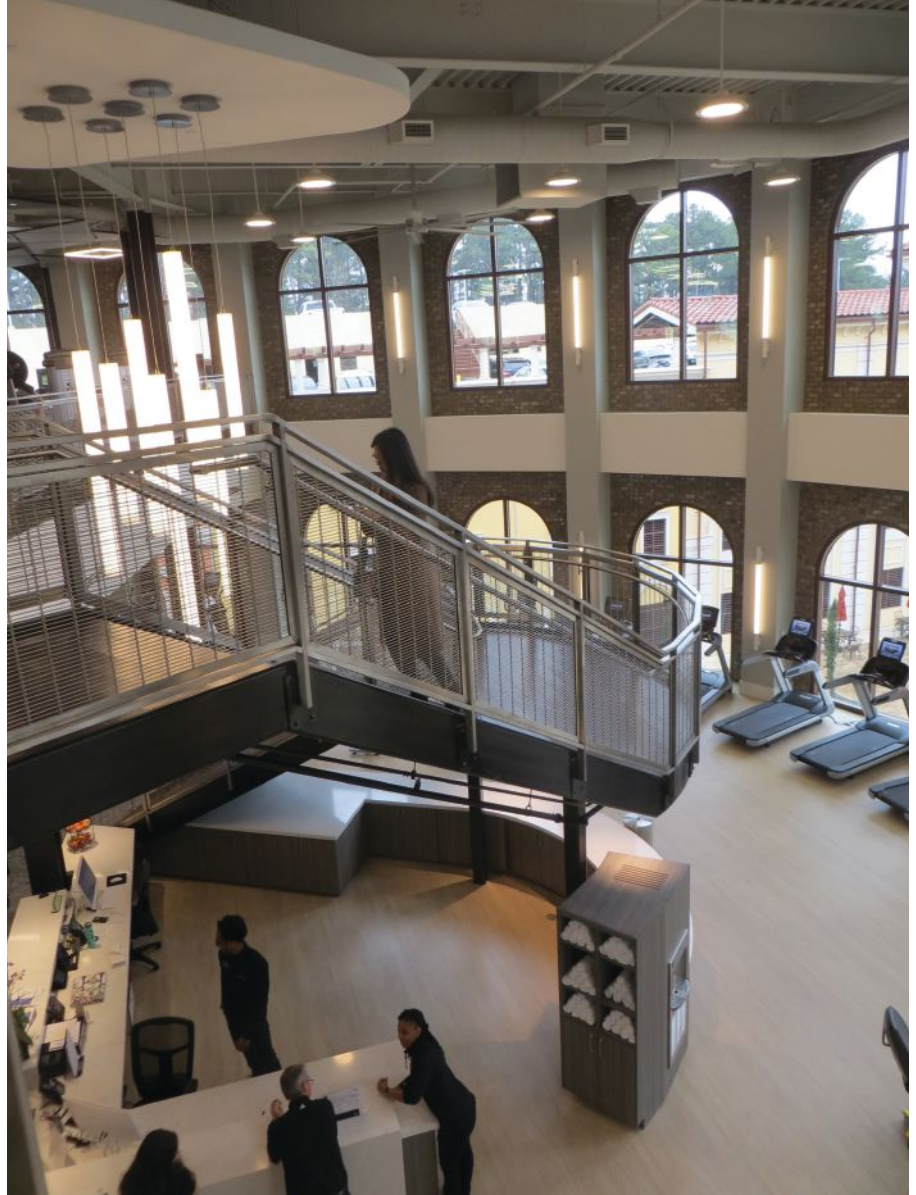



above: The building includes a cafeteria, multiple fitness areas, locker rooms, a pool and outdoor terrace space.



above and left: During the shop drawing phase, discussion between the engineer and fabricator resulted in the development of multiple variations of a partially restrained moment connection to improve constructability.

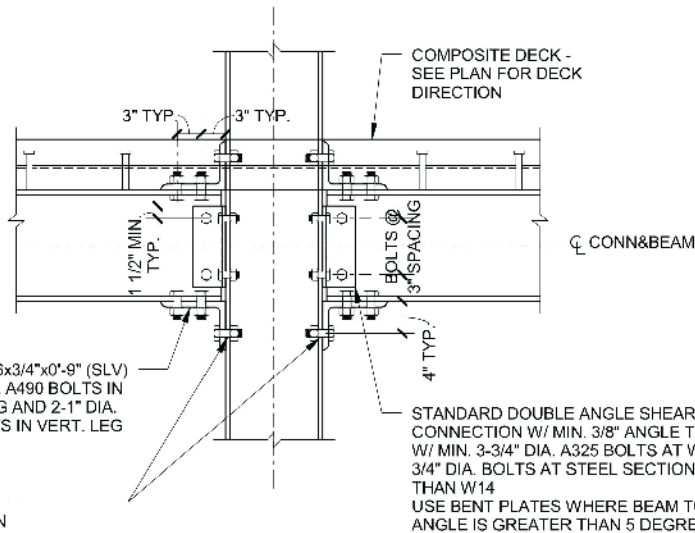

right and below: A radial scheme was used for the W36 transfer beams extending through the middle of the two-story pool area. This design accomplishes the open aesthetic desired by the architect, with natural light from the windows shining through the spaces between the transfer beams and into the pool area.

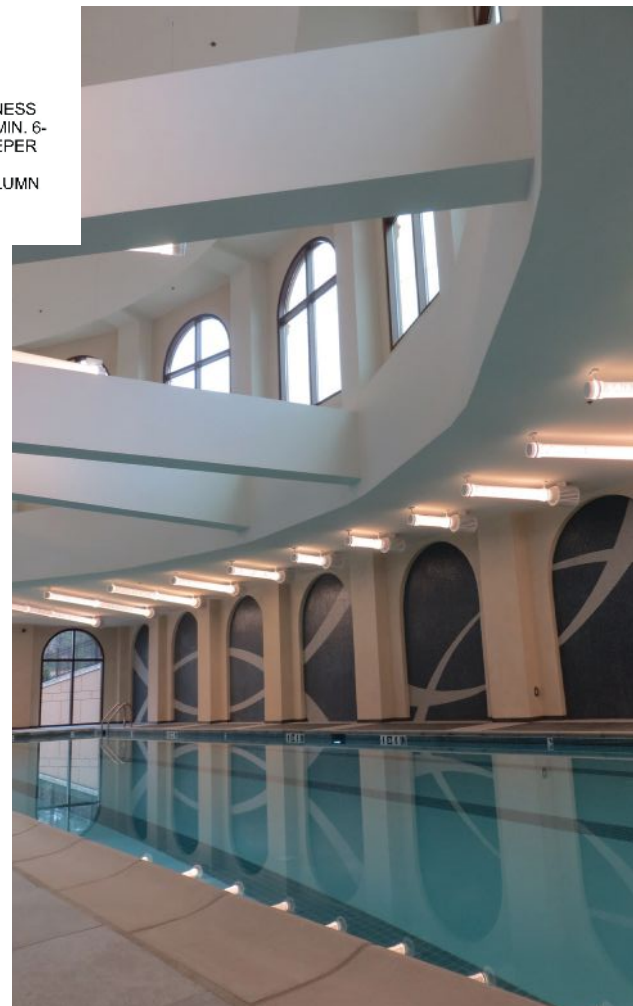

Need A New Muffler?

Of Elliptically Curved Structural Steel?

- 52 tons of W12 x 58# beams roll-curved the “hard way” to form a series of half ellipses with radii of approximately 34’, 24’, and—an extremely tight—12’ radius.
- The steel fabricator praised the AESS roll-curved beams for being distortion-free and for having a profile tolerance of less than 3/8”: “The product that we got from Chicago Metal Rolled Products was almost perfect—they’ve always done a great job for us.”
- The resulting tube muffles the train noise as the “El” passes over the student center designed by Rem Koolhaus at the Illinois Institute of Technology.



Call us at 866-940-5739

When you need quality roll-curving
of structural steel and plate



**CHICAGO METAL
ROLLED PRODUCTS COMPANY**

CHICAGO • KANSAS CITY
cmrp.com



1 Angle Leg Out We bend ALL sizes up to:
 10" x 10" x 1" Angle

2 Angle Leg In
 10" x 10" x 1" Angle

3 Flat Bar The Hard Way
 24" x 12" Flat

4 Flat Bar The Easy Way
 36" x 12" Flat

5 Square Bar
 18" Square

6 Beam The Easy Way (Y-Y Axis)
 44" x 335#,
36" x 925#

7 Beam The Hard Way (X-X Axis)
 44" x 285#

8 Channel Flanges In
 All Sizes

9 Channel Flanges Out
 All Sizes

10 Channel The Hard Way (X-X Axis)
 All Sizes

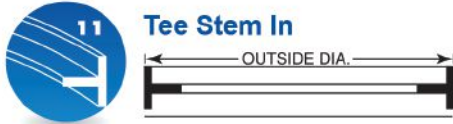
11 Tee Stem In
 22" x 142¹/₂# Tee

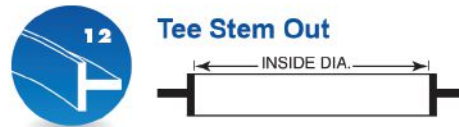
12 Tee Stem Out We bend ALL sizes up to:
 22" x 142¹/₂# Tee

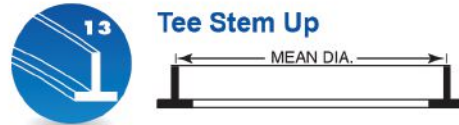
13 Tee Stem Up
 22" x 142¹/₂# Tee

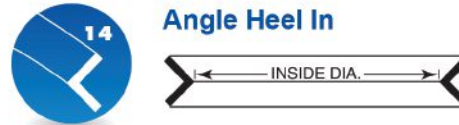
14 Angle Heel In
 8" x 8" x 1" Angle

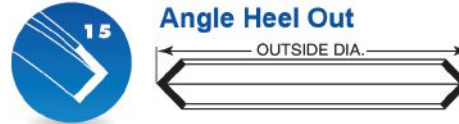
15 Angle Heel Out
 8" x 8" x 1" Angle

16 Angle Heel Up
 8" x 8"x1" Angle

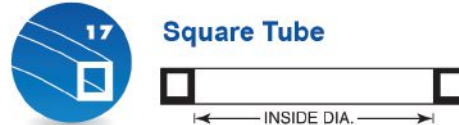
17 Square Tube
 24" x 1¹/₂" Tube

18 Rectangular Tube The Easy Way (Y-Y Axis)
 20" x 12" x 5/8" Tube

19 Rectangular Tube The Hard Way (X-X Axis)
 20" x 12" x 5/8" Tube

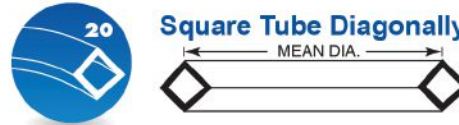
20 Square Tube Diagonally
 12" x 5/8" Square Tube

21 Round Tube & Pipe
 24" Sched. 80 Pipe

22 Round Bar
 All Mill Produced Sizes

We also roll stair stringers, helical hand rails, off-axis bends, formed shapes and extrusions.

Visit cmrp.com for more information.



CHICAGO METAL
ROLLED PRODUCTS COMPANY

CHICAGO • KANSAS CITY



pliate things, transfer beams are located over the pool area where the architectural intent was for a two-story space. After investigating several layouts, a radial scheme was used, with the W36 transfer beams extending through the middle of the two-story space. This design accomplishes the open, two-story-high aesthetic desired by the architect, with natural light from the windows at level 3 shining through the spaces between the transfer beams and into the pool area. Deflections of the transfer beams were carefully considered to keep differential deflection of adjacent columns to a minimum. Maximizing the head room under the transfer beams was a challenge, and mechanical ducts were carefully coordinated in that area, with ducts passing through openings in the beam webs at several locations. Given the humidity in the pool area, the steel is coated with protective paint and covered with a box finish that is also protected with a high-performance coating.

The pool configuration created a framing zone 5 ft lower than the rest of level 2, and the team coordinated with the pool designer to create a coping detail and determine the best solution for sloping the bottom of the pool. In addition to the lower framing at the pool, a 5-in. depression was needed to accommodate gradual sloping as well as waterproofing at the pool deck and locker room. In response, the top of the steel beams in these areas was depressed by 5 in. and was designed and detailed to accommodate the step.

Opened this past spring, the Coliseum (and the rest of the Jackson Healthcare expansion) creates a unique environment for a 21st century American corporate headquarters thanks to an ancient history-inspired exterior and a modern steel-enabled structural system. The gladiators would be impressed. ■

Owner

Jackson Healthcare, Alpharetta, Ga.

General Contractor

Choate Construction, Atlanta

Architect:

Rule Joy Trammell + Rubio, LLC, Atlanta

Structural Engineer

Stanley D. Lindsey and Associates, Ltd., Atlanta

Steel Team

Steel Fabricator

Stein Steel and Supply Company, Atlanta 

Steel Erector

Williams Erection Co., Inc., Smyrna, Ga. 

InfoSight
Corporation
"We BARCODE Difficult Stuff"

Chillicothe, Ohio USA 45601
+1-740-642-3600
www.infosight.com
sales@infosight.com

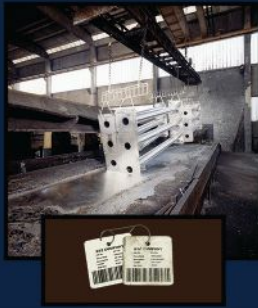

Identification and Traceability Solutions for Galvanizers and Fabricators

FABTECH
Booth A3555
Chicago, IL November 11-14, 2019

POWERGEN INTERNATIONAL
Booth 4154
New Orleans, LA November 19-21, 2019

HEXPOR[®]

Save valuable time and money. Never search for bolting documents ever again!

- Test Reports
- Invoices
- Packing Lists
- DOT Approvals
- Order Tracking
- Proof of Delivery

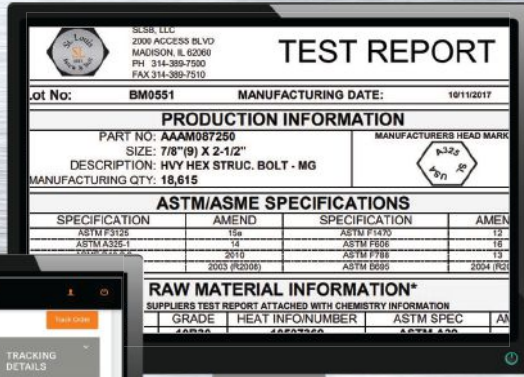

Call or Go Online to find out more
St. Louis Screw & Bolt

stlouisscrewbolt.com
800-237-7059

Structural Bolting Experts



Revisiting Redundancy

BY JASON B. LLOYD, PE, PHD

A look at historical considerations of redundancy and fracture-critical members in steel bridges.

THE CHALLENGE of engineering innovation is often balancing the tradeoffs between different performance characteristics—and of course, cost.

Take planes, for example, where innovation has been driven by a desire to improve powered flight, increasing the performance of the aircraft in terms of weight, lift, thrust, and drag in order to produce the fastest and highest-flying airplane possible. Early developments in aviation engineering often produced planes using a stacked-wing configuration, allowing them to achieve more lift with less engine power and without the weight of the wing becoming prohibitive.

One such example is the Sopwith Triplane, manufactured by the Sopwith Aviation Company, which was introduced during World War I. Some advantages of the triplane were a shorter and lighter wing that provided more lift, a wider field of view for the pilot, and improved elevator response (vertical pitch), enhancing maneuverability—a clear advantage for a fighter plane.

Triplanes and biplanes were contrasted by monoplanes (planes having a single fixed wing), which came with their own advantages. These included reduced drag (via eliminating the exposed bracing between wings and internally carrying all of the wing forces) as well

as superior aerodynamic efficiency, allowing faster flight. However, they also required higher-powered engines to fly the heavier frames, whereas multi-wing planes possessed superior structural efficiency, allowing smaller and lighter wings, lower-powered engines, and slower stall speeds. As aviation innovation continued, thanks to significant advancements in aerodynamics-related knowledge, engines became more powerful while wing materials became lighter and stronger, moving the aircraft industry almost exclusively toward the monoplane designs that we see today.

Perhaps you're wondering how this relates to steel bridges. Some time ago, a good friend and mentor facetiously made a comparison between a fracture-critical member (FCM) in a bridge (typically classified as such through engineering judgment for being non-load-path redundant) and the wing of a monoplane. On occasion, we would encounter engineers who were uncomfortable with non-load-path redundant members in steel bridges, but who didn't seem to have a problem with flying on a monoplane. It begged a somewhat humorous question: Why wouldn't that engineer also insist on flying on a multi-wing plane, or a plane with multiple sets of landing gear, in order to have load-path redundancy during their 36,000-ft commute? (If you



opposite page: Twin, built-up riveted, two-girder bridges carrying US-41 over the White River in southern Indiana.

left: More isn't always better—especially when it comes to wings. Thanks to advancements in aviation technology, the only places we see aircraft such as the Sopwith Triplane these days are museums and air shows.

below: The built-up riveted floor truss of the Golden Gate Bridge in San Francisco.



want to hear more about this comparison straight from the source, check out Rob Connor's 2018 AISC T.R. Higgins Lecture "Towards an Integrated Fracture-Control Plan for Steel Bridges" at aisc.org/2018nascconline.)

Clearly, the aviation industry is motivated to use reliable and redundant structures. So why don't they use multi-wing planes for the case of catastrophic wing failure? Wing failures have occurred in the past in older planes. The simple answer is that they have developed alternative methods to design, fabricate, inspect, and maintain critical elements of their air frames by exploiting forms of redundancy other than load-path redundancy, such as fail-safe and damage-tolerant design methods. These methods recognize that structures must withstand service loads even when damaged or cracked until reliable inspection methods can identify the damage. For example, the wing structure of the plane might possess multiple load paths internal to the wing, mechanically fastened composite layered structures that offer strength and crack arrest capability, other crack arrest detailing, experimental fatigue testing to develop life-prediction models, and inspection programs that are linked to the design, fabrication, fatigue life, and probability of detecting defects.

When it comes to steel bridge design, can we borrow a chapter from the aviation industry's book? Can we exploit other modes of redundancy in steel bridges that might allow for more economical design options? And can we integrate the fracture-control plan (FCP) and link material, design, fabrication, and field inspection frequency to damage tolerance? The answer to all of these questions is Yes!



Jason B. Lloyd (lloyd@aisc.org) is NSBA's bridge steel specialist – West Region.

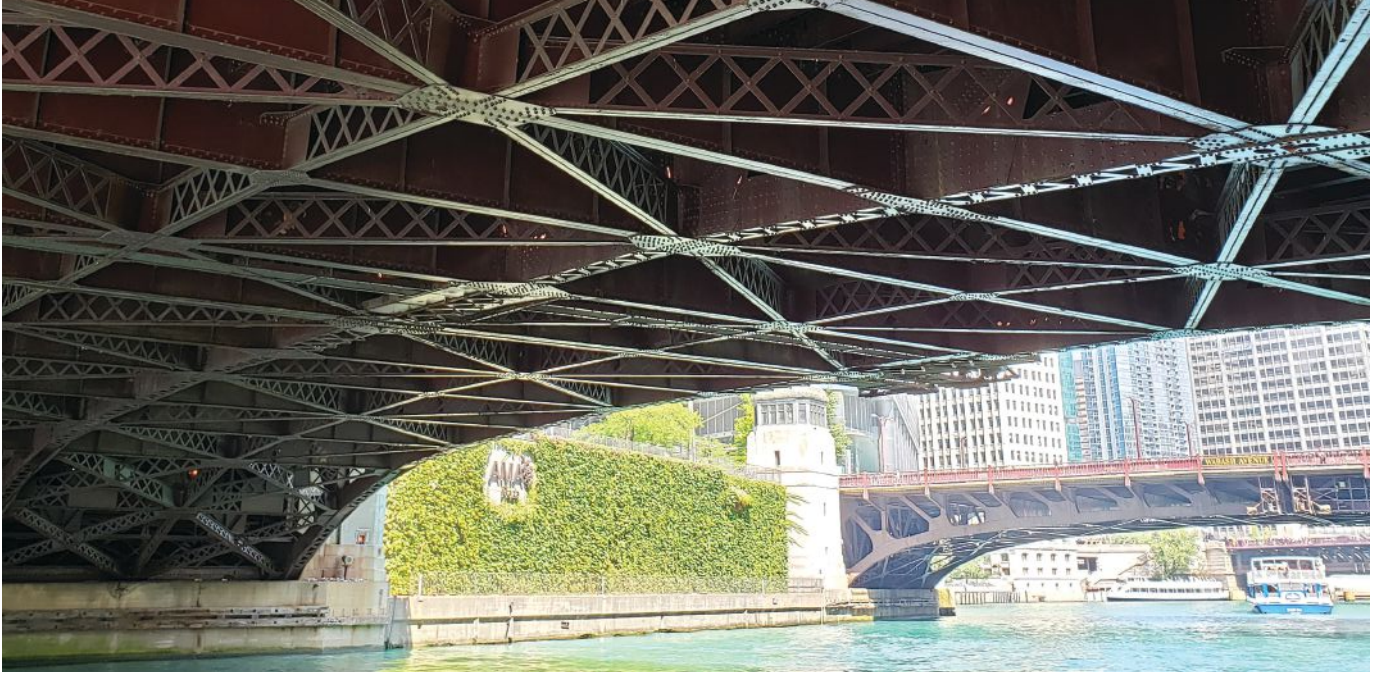

Built-up riveted bascule bridges carrying vehicular traffic over the Chicago River in downtown Chicago.

Historical Context

First, we should understand how we, as an industry, arrived at current practices and policies for bridge redundancy and FCMs. Following the infamous collapse of the Silver Bridge over the Ohio River in 1967, the Federal-Aid Highway Act of 1968 originated a requirement for the Secretary of Transportation to establish the National Bridge Inspection Standards (NBIS) to help ensure the safety of the nation's bridges. The NBIS is overseen by the Federal Highway Administration (FHWA) and is defined by the *Code of Federal Regulations*. Later, the Federal-Aid Highway Act of 1970 limited the NBIS to bridges on the Federal-Aid highway system.

However, the Surface Transportation Assistance Act of 1978 extended the NBIS requirements to all bridges greater than 20 ft on public roads. Then, the Surface Transportation and Uniform Relocation Assistance Act of 1987 expanded the scope of bridge inspection programs to identify FCMs and establish inspection procedures for them. This was possibly motivated by the partial failure of the Mianus River Bridge in 1983 (which was not caused by fracture). Currently, the inspection period for bridges containing FCMs in the United States is mandated at a maximum of 24 months and inspection of FCMs must be performed at “arms-length.” This inspection frequency was first defined in the NBIS beginning in 1988. It was based on expert consensus, not necessarily on scientific research or statistical modeling.

In parallel with development of the abovementioned statutes, research was conducted to address concerns related to steel bridge members subjected to tension, specifically as related to the fatigue and fracture limit states. The research resulted in significant additions to the 1974 American Association of State Highway and Transportation Officials (AASHTO) bridge design specifications, including Charpy V-notch (CVN) testing requirements to ensure a minimum toughness (i.e., resistance to fracture in the presence of a crack) at the lowest anticipated service temperature of the non-load path redundant member. Also, the first comprehensive fatigue design provisions were added, introducing the fatigue categories and their respective fatigue resistances.

In 1978, AASHTO published the first edition of the *Guide Specifications for Fracture Critical Non-Redundant Steel Bridge Members*, becoming known as the “AASHTO Fracture-Control Plan.”

This was the document that introduced the term “fracture critical” and implemented reduced fatigue stress range limits and improved fabrication quality control measures for FCMs. Eventually, the 1978 *Guide Specifications* were abandoned when the FCM requirements were incorporated into ASTM A709 *Standard Specification for Structural Steel for Bridges*, the AASHTO *Bridge Design Specifications*, and AASHTO/AWS D1.5 *Bridge Welding Code* (Clause 12).

While legislation and research helped to shape policy for FCMs, including frequency and depth of inspection, it remained incumbent upon the engineer of record (EOR) to identify FCMs in new design and upon inspectors in existing bridges. The *Code of Federal Regulations* Title 23, Part 650, defined an FCM as a “steel member in tension, or with a tension element, whose failure would probably cause a portion of or the entire bridge to collapse.” However, without further guidance, it became state-of-practice to designate any tension member that appeared to not be load-path-redundant, as fracture-critical (such as in a two-girder bridge). But the authors of NCHRP (National Cooperative Highway Research Program) Synthesis 354 pointed out that this designation was not applied consistently by owners.

After several decades, the end result is that many bridge engineers are now accustomed to determining redundancy through engineering judgment that is married to a single approach: load path (or number of girder lines). And as an industry, we became comfortable with many girder lines and uncertain, or even afraid, of anything less. That uncertainty was perhaps reinforced for some by the tragic collapse of the I-35W Bridge in Minneapolis in 2007. However, the collapse was actually caused by a design error that resulted in a buckling-induced failure mode. It was not a result of fracture, nor was it related to FCMs. Yet prominent documents such as the *Bridge Inspectors Reference Manual (BIRM)* and countless fracture-related papers and presentations continue to incorrectly promulgate it as an FCM-related collapse.

An Outdated Approach?

Adding girder lines is not an exclusive approach to increasing reliability and in some cases may not be the most efficient design approach either. According to an international scan of other industrialized countries (*Steel Bridge Fabrication Technologies*

in *Europe and Japan*, Report FHWA-PL-01-018) the U.S. appears to be unique in its view of non-load-path-redundant structures. The report suggests that the U.S. design philosophy for non-redundant bridges should be reconsidered. This speaks to a need to revisit outdated practices as well as redundancy in order to allow for design optimization.

We should ask ourselves this: When it comes to redundancy, are we still designing the bridge equivalent of a triplane in some ways? Can we reduce the drag of outdated design philosophies to soar to new heights through innovations that still produce reliable and redundant steel bridges? Reliability of our structures is not load-path-dependent. It can also be achieved through improved materials, design and detailing methods, and fabrication practices. This is anecdotally supported by the fact that there have been no known fractures of FCMs designed and fabricated to FCP standards since its implementation over 40 years ago (for more information, see the fourth quarter 2019 AISC *Engineering Journal* article “Simplified Transformative Approaches for Evaluating the Criticality of Fracture in Steel Members” via aisc.org/ej). And innovation continues to power the steel bridge industry forward in areas such as corrosion resistance, material toughness, material strength, welding processes, non-destructive testing, and infinite fatigue life.

These innovations make reliable bridges possible with alternate modes of redundancy, such as system redundancy and internal member redundancy. System-level redundancy prevents the partial or full collapse of a bridge following failure of a system-redundant member (SRM) by redistribution of load through the interconnected system of primary and secondary members and the deck. Member-level redundancy prevents the partial or full collapse of a

bridge following failure of a single component within an internally redundant member (IRM) by redistribution of load into adjacent mechanically fastened components of the member itself. System redundancy and member-level redundancy following failure of FCMs (that were built prior to the FCP) have been observed several times over many decades. The empirical evidence demonstrating these forms of redundancy, combined with advancements in fracture control and structural analysis, left leaders in the steel bridge industry asking good questions, like:

- In the absence of load-path redundancy, how can we identify what is an FCM?
- What load case(s) is appropriate and what level of analysis should be required?
- If a member is found to be an SRM or an IRM, how do we link the damage tolerance and the inspection interval?

The basis of these questions was recently researched at Purdue University under state pooled-fund and NCHRP research grants. Researchers studied the fracture resistance, after-fracture load redistribution behavior, and after-fracture fatigue life of members that would have traditionally been considered non-redundant members or FCMs. The research to date has resulted in two newly published AASHTO *Guide Specifications*: the AASHTO *Guide Specifications for Identification of Fracture Critical and System Redundant Members* and the AASHTO *Guide Specifications for Internal Redundancy of Mechanically-fastened Built-up Steel Members*. These new publications offer forward progress in innovative thinking for redundancy in the steel bridge industry. We'll provide more detailed discussions of each *Guide Specification* in upcoming issues of *Modern Steel Construction*. ■

THE SAFEST HOSPITALS USE SIDEPLATE

SidePlate Brings Your Project:

- Field Bolted Construction
- Schedule Savings
- Design Flexibility
- Greater Open Space
- Simple Future Expansion
- Significant Steel Savings



Contact us for a FREE evaluation of your project



www.sideplate.com
949-238-8900
info@sideplate.com



You Can Get There From Here

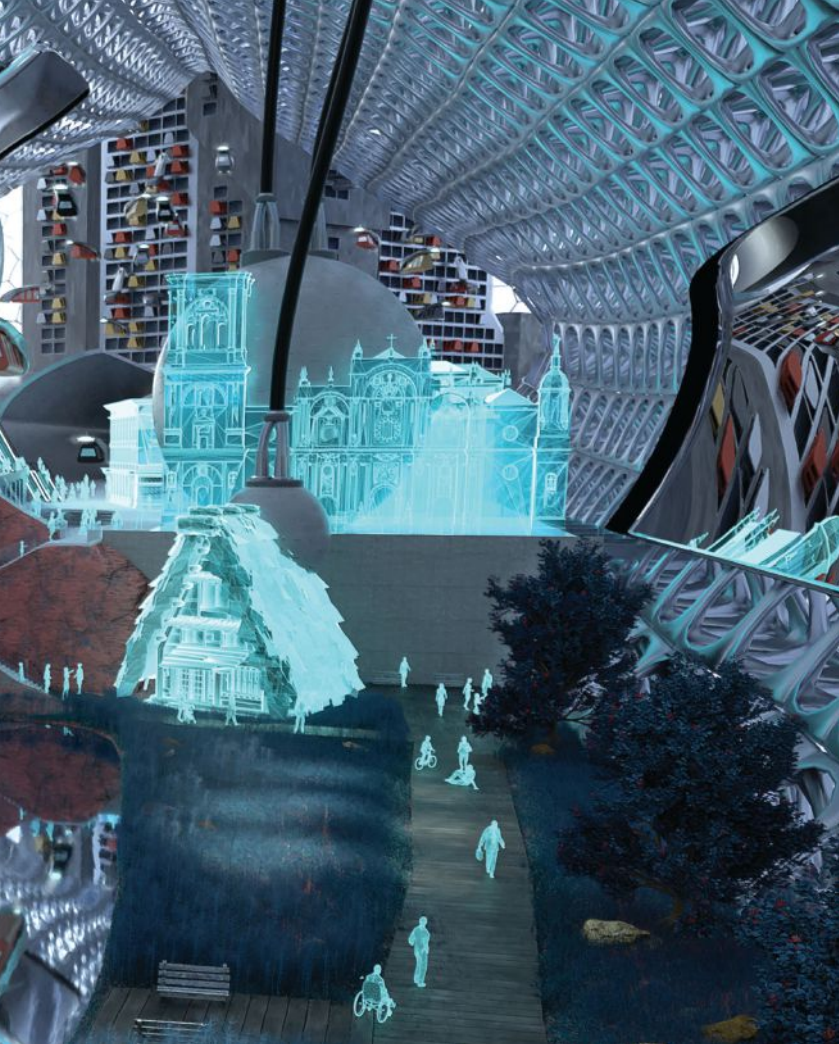

The 20th annual Steel Design Student Competition challenged students to elevate the transit center concept, and the winners generated some out-of-this-world designs.

WHAT DOES the intermodal transit station of tomorrow look like?

More than 300 college-level students provided their visions of the future of travel via the 20th annual Steel Design Student Competition. Administered by the Association of Collegiate Schools of Architecture (ACSA) and sponsored by AISC, the competition encourages architecture students from across North America to explore the many functional and aesthetic uses for steel in design and construction. A total of \$14,000 in prizes was awarded to the 12 winning students and their faculty sponsors for the 2018–19 academic year.

Participants entered projects in one of two categories. The Transportation Center category challenged students to design a cohesive intermodal transit system including components such as international, regional, and local train stations, bus terminals, ports, airports and even spaceports in a major urban location. In the Open category, students were given the flexibility to select and design a site and building program using steel as the primary material.

This year's Category I judges were Seung K. Ra, Oklahoma State University; Mindy Viamontes, EXP; and Yolande Daniels, Studio SUMO. Winifred Elyse Newman, Clemson University, and Kevin Alter, University of Texas, Austin, were the Category II judges.

The winning projects will be on view at the 2020 ACSA Annual Meeting in San Diego, the American Institute of Architects (AIA) 2020 Convention in Los Angeles, and AISC's NASCC: The Steel Conference in Atlanta, April 22–24 (visit aisc.org/nascc for information). You can see more renderings of all the winners at aisc.org/studentdesign.

Next year's competition main category (in addition to the Open category) is Urban Food Hub: Life of a Steel Building. Interested students must register by April 1, 2020, and submissions are due May 20.

Read on for this year's winners and see some truly visionary designs for transit centers and other steel facilities!

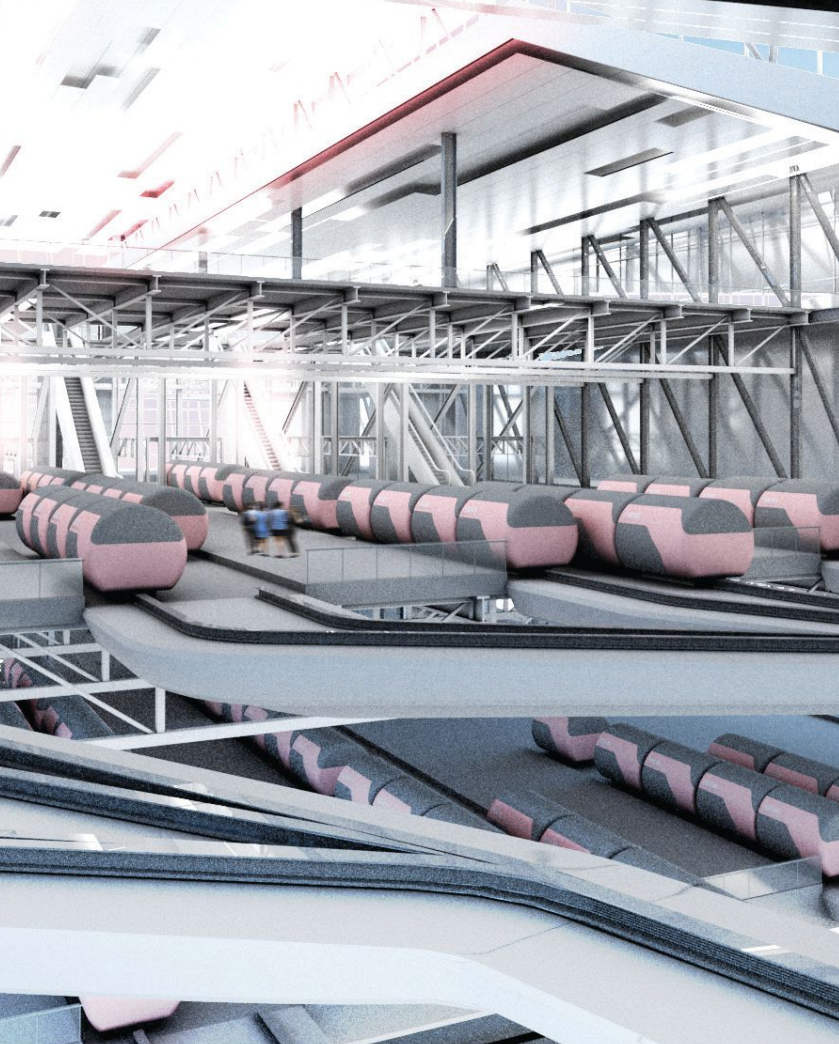

**CATEGORY I:
INTERMODAL TRANSPORTATION CENTER**
Winners

1st

Interlace

Student: Curt Budd, California Polytechnic State University
Faculty Sponsor: Margarida Yin

Los Angeles remains burdened by decades of rapid suburbanization and neglected public transportation networks. As a result of auto-centric development, Angelenos struggle to navigate through their city via any means other than the automobile. At Union Station, Highway 101 and regional rail lines isolate the station and L.A.'s historic core from the civic center, downtown, and the arts district.

Interlace hopes to change all of this and rewrite the car-centric story that so many associate with L.A. The intermodal transit center, located at Union station, accommodates hyperloop, high-speed rail, L.A. Metro, and bus systems, in addition to extensive community-based programs. In addition, a mixed-use tower development to the south end of the project exemplifies the concept of transit-oriented living.

The design places a heavy emphasis on community-focused spaces, with the idea of activating the site in a social manner while at the same time providing much-needed transportation services. The massing of the building sees transit systems barred from the ground plane, which is reserved for people. High-speed rail and Metro systems are located on subgrade levels, enabling the unification of the east and west sides of the site. In contrast, the hyperloop station is elevated to become a new icon for L.A. The community-focused programs, including retail, dining, urban farming, office sharing, and gallery spaces, are housed in interwoven program containers that become the canopy that covers the underground rail systems, and the massing's emergence from the ground enables multiple points of access to an extensive roof garden. The façade is angular and porous, evocative of movement and inviting to both people and natural light. Visitors explore the void created by weaving program containers, easily accessing a variety of amenities, and travelers find and access their system of choice via a quick escalator or elevator ride.

The separation of human- and transit-focused programs allows for a series of intriguing experiences regarding the interface between people and transit machines. A visitor may simply observe hyperloop pods moving overhead in the exhibition space and spend the majority of their time inspecting the intricate paneling of the spaces. Meanwhile, a traveler might spend little time among these refined finishes, instead moving through quickly and circulating vertically alongside the hyperloop pod elevators, ultimately entering the hyperloop system in a space dominated by exposed structural elements.

In summary, Interlace is a transit center that blurs the line between transit and social infrastructure, aiming to activate the site in a social manner and providing much-needed transportation services.

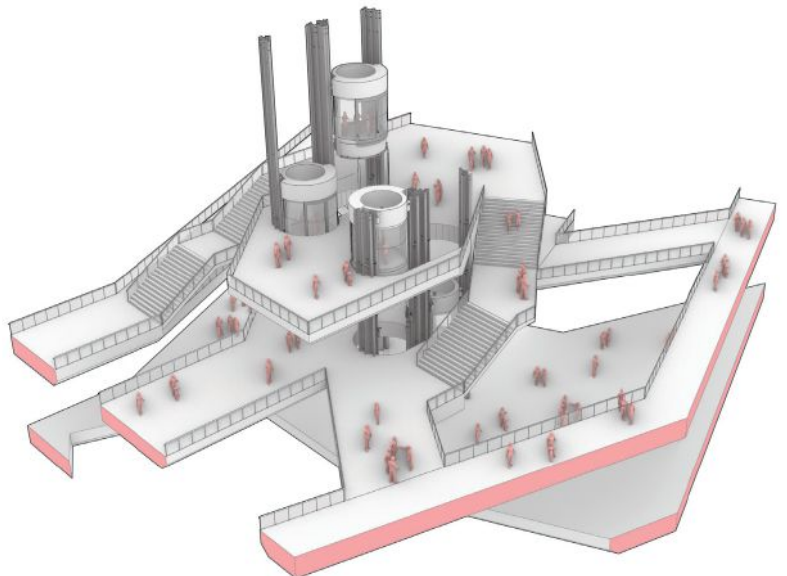
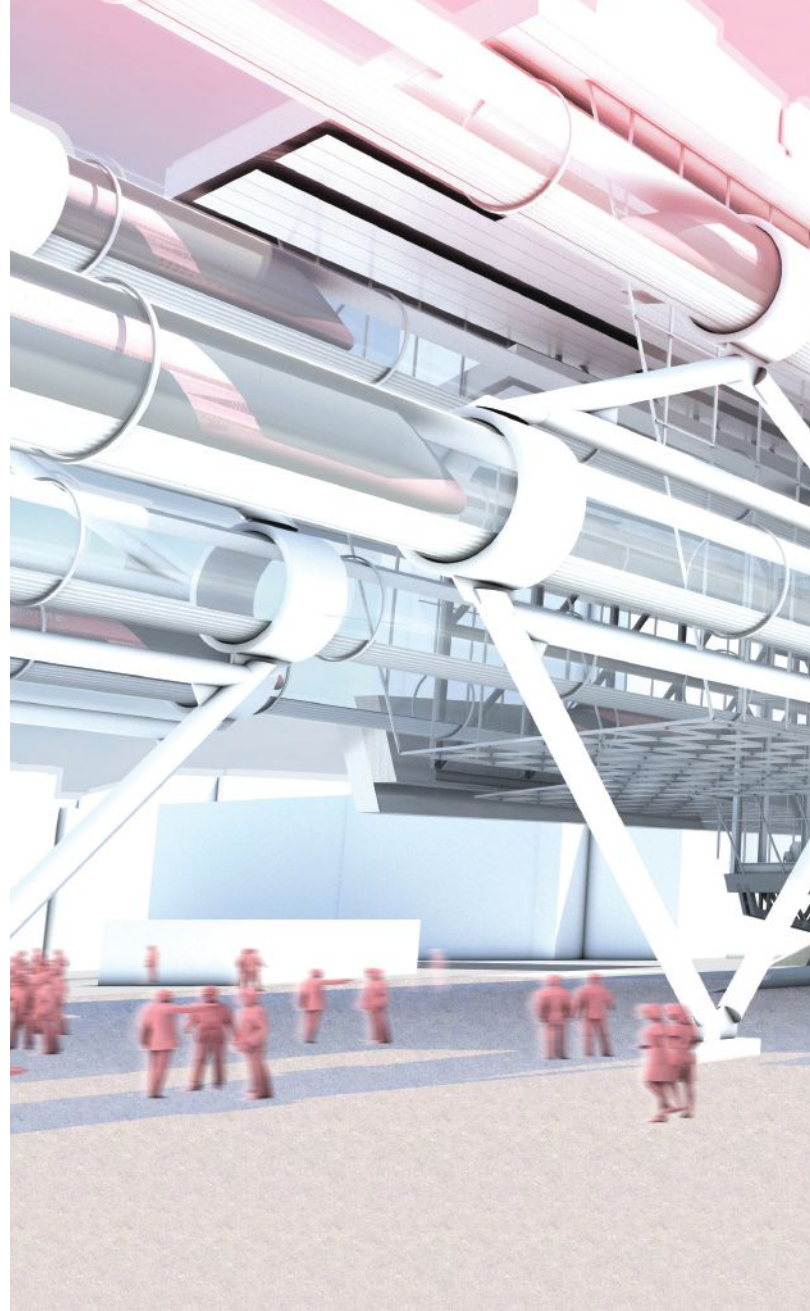

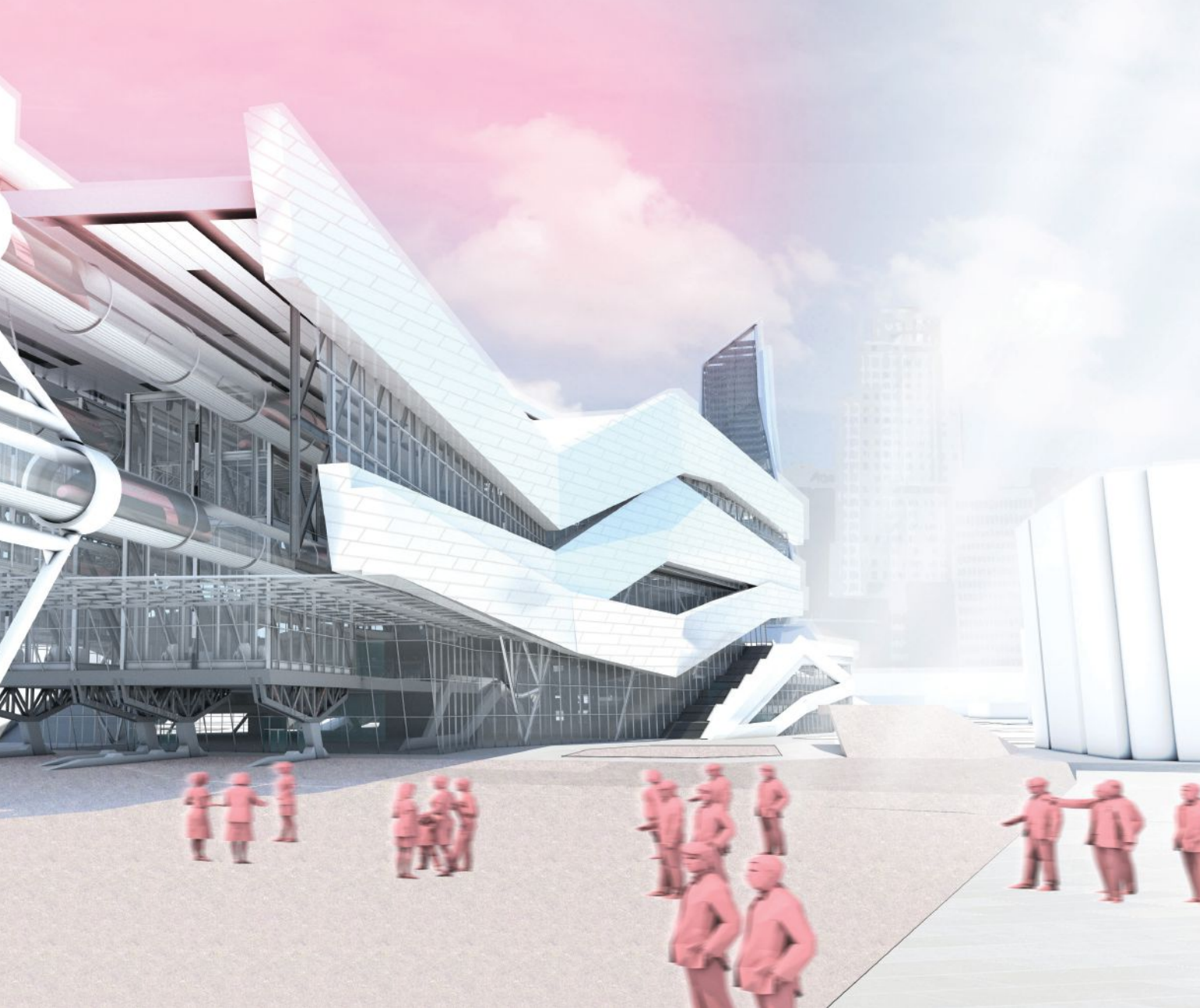

**CATEGORY I:
INTERMODAL
TRANSPORTATION
CENTER**
Winners

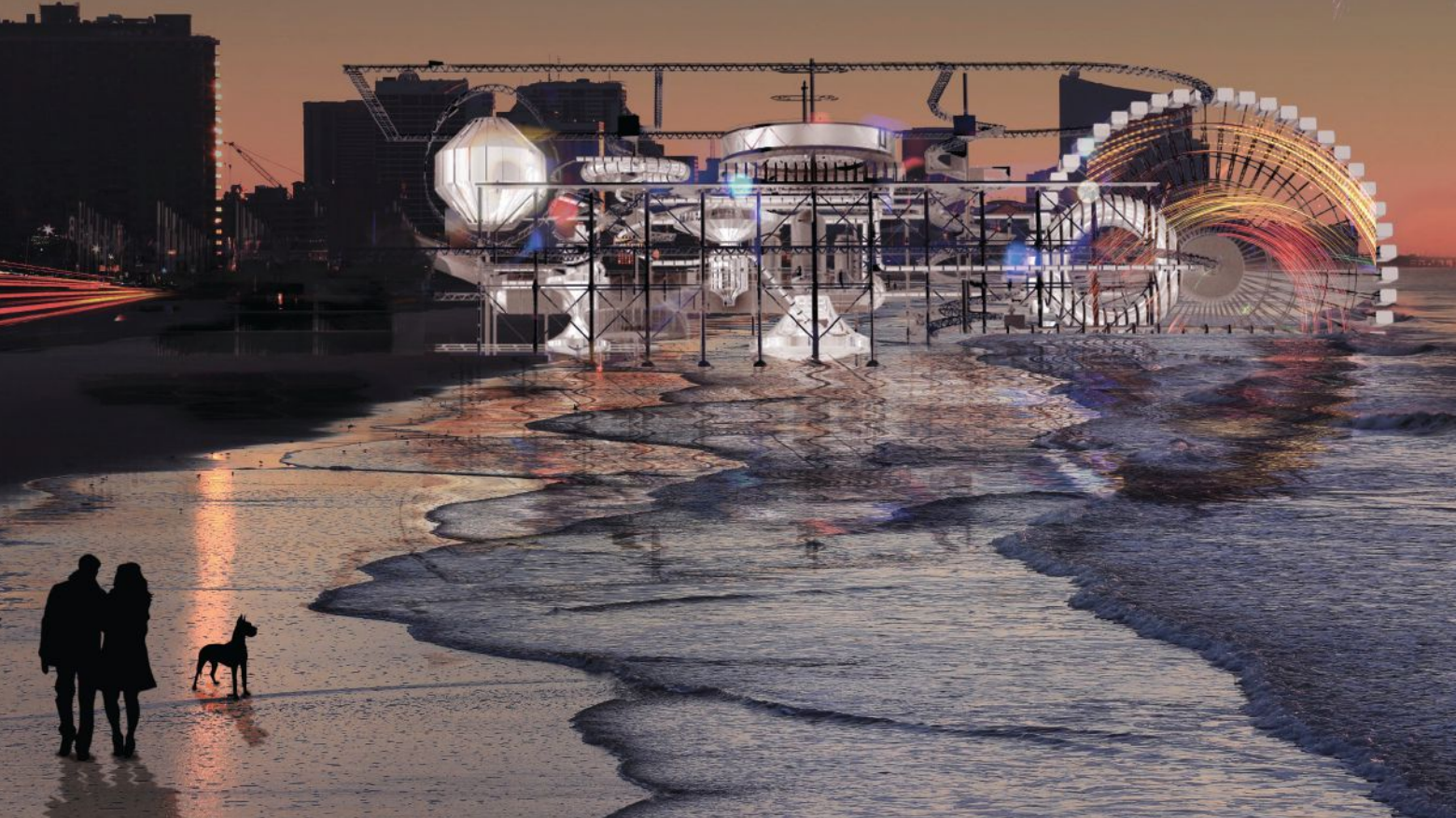

2nd

The Trans-Pier: Where Entertainment Meets Travel

Student: Tatiana Estrina, Ryerson University
Faculty Sponsor: Vincent Hui

Atlantic City has a long history of booms and busts. Its close proximity to multiple population centers on the eastern seaboard is key to its survival as a tourist destination. As transportation methods have evolved over the years, Atlantic City's role as a casino mecca and beach destination has become more and more redundant, as other cities in the South have risen to become easily accessible vacation spots and many casinos have also opened in that region.

The Trans-Pier reinvigorates Atlantic City with a transportation hub that becomes a destination in itself. It reflects the character of the city: a community with a focus on entertaining visitors. The facility emphasizes the experience of those who transition through the spaces within the transportation hub and allows them to become participants in other traveler's journeys. They are able to not only engage with the activities and entertainment hubs available but can also see firsthand the processing of cargo, baggage, and other generally hidden elements of transit architecture. By combining port activities such as cruises, ferries, and cargo ships with air travel, the hub caters to a variety of visitors traveling to and from nearby cities.



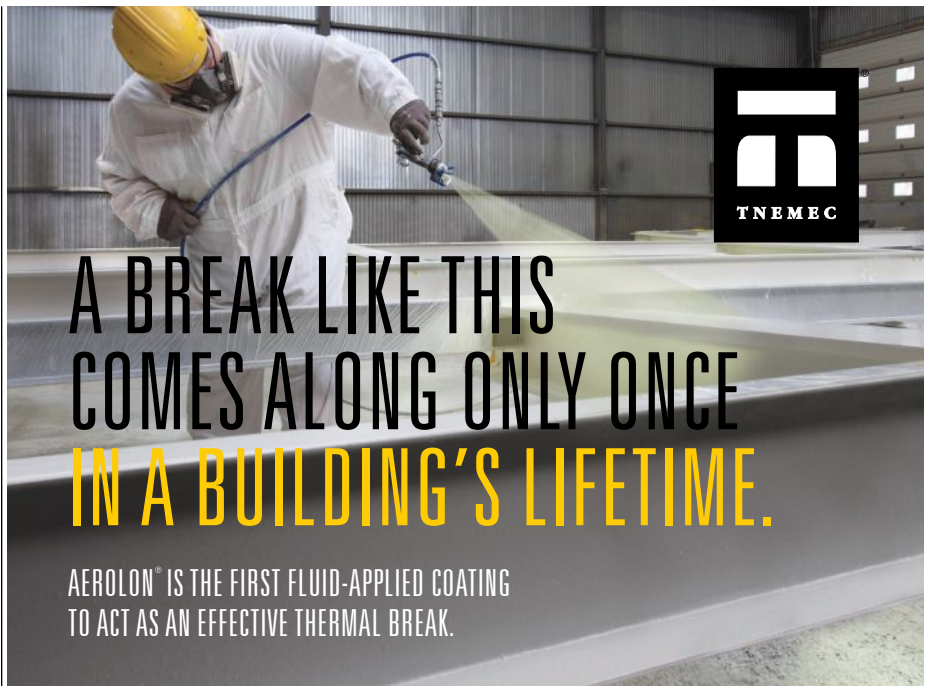

A BREAK LIKE THIS COMES ALONG ONLY ONCE IN A BUILDING'S LIFETIME.

AEROLON® IS THE FIRST FLUID-APPLIED COATING
TO ACT AS AN EFFECTIVE THERMAL BREAK.

A low VOC, water-based coating that can be easily spray-applied in the shop or in the field, Aerolon provides significant cost-saving advantages over structural thermal breaks, limiting design restrictions for architects and reducing application and labor time for contractors. **Find out more at tneec.com/thermalbreak.**

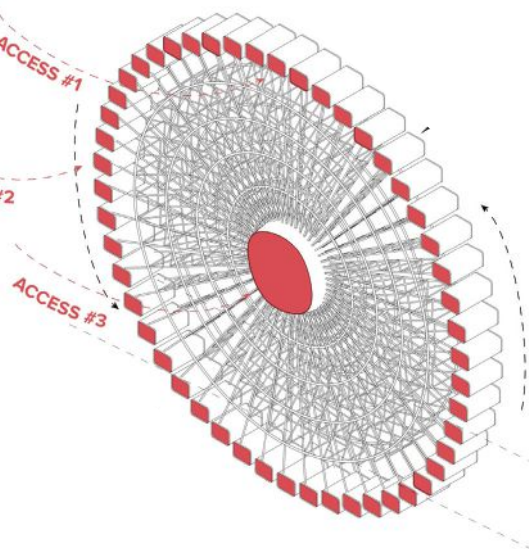

Affordable, extra heavy-duty and reliable, with state-of-the-art cutting options.

Contact PCS to discuss your requirements!



brian@usapcsinc.com

1-800-656-1903 | www.profilecuttingsystems.com

**CATEGORY I:
INTERMODAL
TRANSPORTATION
CENTER**
Winners



3rd

Steel Bones Coastal PCH/LAX Transit Center

Student: Stephanie Green,
Woodbury University
Faculty Sponsor: Bailey Shugart

Los Angeles has a well-known traffic problem that continues to grow exponentially, putting increased stress on people and the environment. PCH Transit Center offers a solution that connects people traveling to and from Los Angeles International Airport (LAX), residents along the Pacific Coast Highway, and beyond. Designed to support the community's current needs, it also retains the ability to expand—for future galactic travel and space tourism.

Inspired by the ghost residential neighborhood of Manchester Square and Surfridge from the 1940s, PCH Transit Center blossomed from the curvature of the old street topography. A proposed monorail connects Playa Del Rey to El Segundo, using the hub as a transfer point from north to south, and a subway is proposed to shuttle back and forth to LAX. The third and underground levels host the main pedestrian circulation around these trains, and to the north are helicopter terminals on the first and second floors. These helicopters tap into the growing network of private shared-ride services such as Uber.

Much like an organism, the steel rib structure holds the interior program together, with the exterior envelope skin holding the ribs in place. These ribs are inspired by the structural integrity of flying buttresses in gothic cathedrals, with loads being transferred downward and out into the ground, and allowing for longer spans and larger open interiors.



ROOF SKIN AND GLASS

TRUSS SYSTEM FOR GLASS ATRIUMS

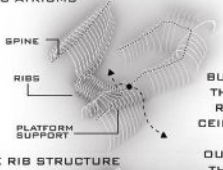

BONE RIB STRUCTURE

THE STEEL BUTTRESSES CARRY THE WEIGHT OF THE ROOF SKIN, GLASS CEILING ATRIUM, AND DISTRIBUTES IT OUTWARD REDUCING THE SKIN SYSTEM'S WEIGHT AT THE ROOF.

WALL SKIN



FLOORS

EXPLODED AXON DIAGRAM

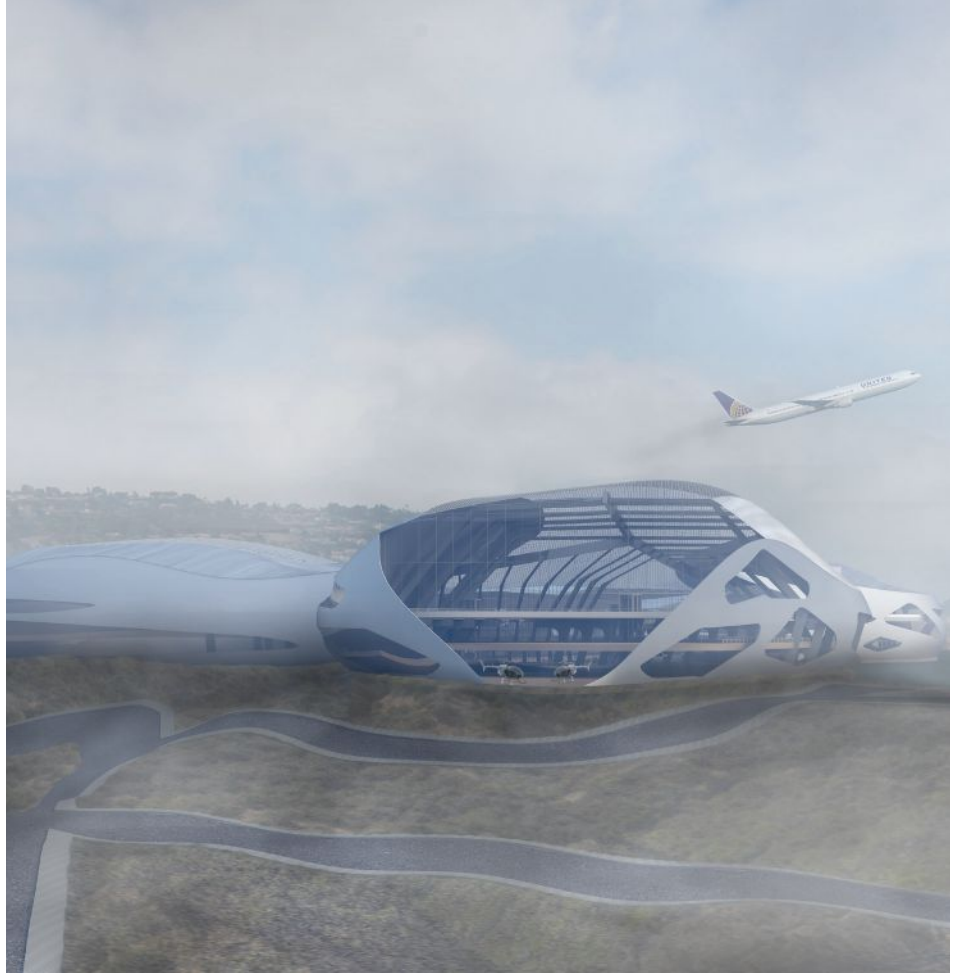

See... the bolts are tight!

with **DuraSquirt®** DTIs



800 552 1999

802 460 3100

appliedbolting.com

info@appliedbolting.com

the best way to bolt!



**CATEGORY I:
INTERMODAL
TRANSPORTATION
CENTER**
Honorable Mentions

ARCH 2082

Student: Andrew Swaim,
California Polytechnic State University
Faculty Sponsor: Margarida Yin

By 2082, the air is clouded and the oceans have risen. We attempt to alleviate our issues by implementing nuclear fusion, providing us with a clean, near infinite source of energy.

With this energy source, we are able to eliminate the burning of fossil fuels and prevent photovoltaics and wind farms from overwhelming natural habitats. A new era of transportation is also sparked, allowing for hyperloop-style networks to become commonplace. Improved battery and thrust engine technologies give way to the flying car, eliminating the traditional automobile and allowing cities to reclaim much of the auto-oriented infrastructure built in the 20th and early 21st centuries. However, our ambitions are not limited to the surface of the earth. Space elevators are constructed in order to quickly and efficiently move industrial products into orbit to build long-range spacecraft. With these new starships, the universe is our oyster.

Such far-reaching transit initiatives must of course rely on equally ambitious transit facilities. Hence, ARCH 2082 a, transit center that combines three modes of travel: a hyperloop, space elevator, and autonomous drones. Here, an observation deck allows visitors to peer out of either of the transit center's large cantilevers. An ethylene tetrafluoroethylene (ETFE) skin clads the facility and relies on a constant flow of air in order to stay pressurized, providing a small insulative effect. A fire-resistant layer is wrapped around the space frame in order to prevent fire and protect the structure from moisture, and a steel substructure is used to connect the ETFE with the space frame. An extensive network of nutrient-enriched water feeds the plants. A green wall filters incoming air while also providing an evaporative cooling effect. A residential section functions both as a hotel and a permanent living platform. And a shopping mall and museum attract the general public. And then there's the space elevator, which provides a quick, efficient method of transporting spaceship parts and crew members to and from a spaceship factory in low orbit via two cables, one for upwards travel and one for downwards travel.

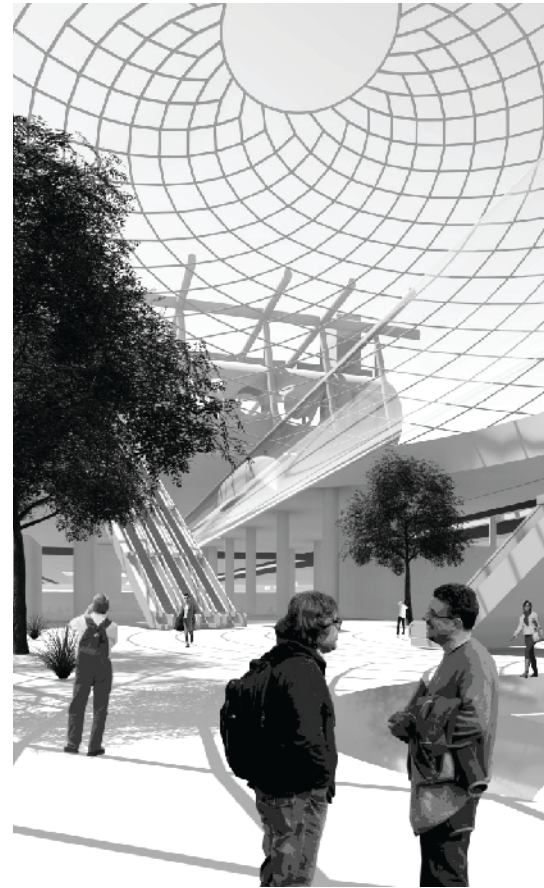

Interchange

Student: Scott L'Esperance,
California Polytechnic State
University

Faculty Sponsor: Margarida Yin

From the 1960s through the 1980s, Interstates were plowed through America's cities, tearing neighborhoods apart and fostering suburban flight. These interstates are beginning to reach the end of their lifespans, and cities like San Francisco, Milwaukee, and Toronto have successfully removed freeways to reconnect communities, reduce pollution, and spur economic growth through new development. Hyperloop transportation may be viable in the near future, and its arrival offers a chance to reconsider America's cities, as 700-mph travel can reshape the entire notion of transportation. Hyperloop stations may require four city blocks' worth of contiguous space, and in crowded city centers space is hard to come by. Urban highways facing redevelopment provide a solution, as these sites offer plenty of contiguous land to build stations and supporting programs, as well as access to the Interstate right-of-ways that lead out of the city.

The hyperloop systems can be located below grade, and an example station in

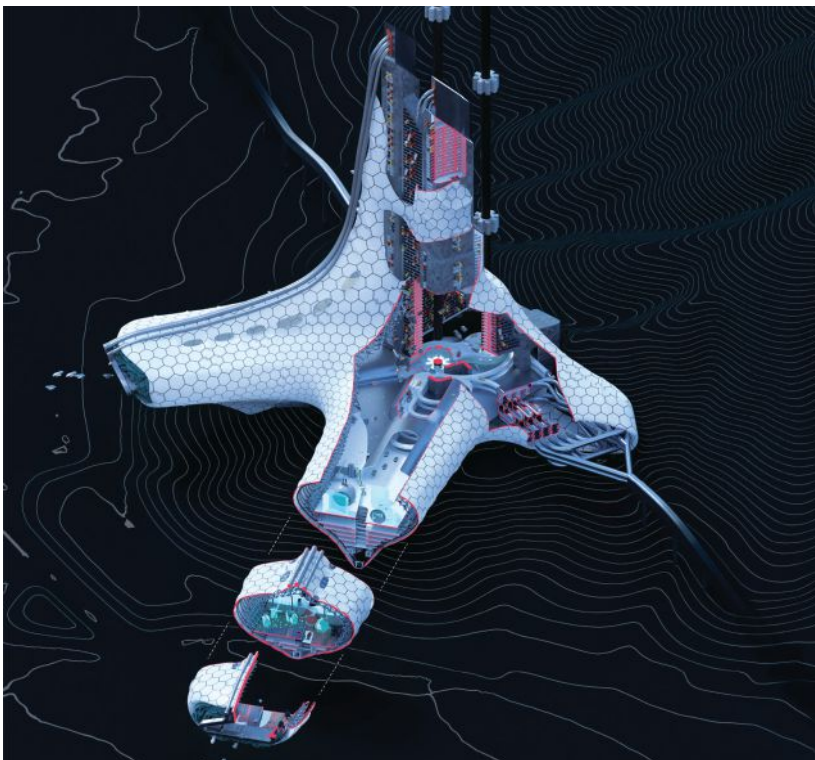

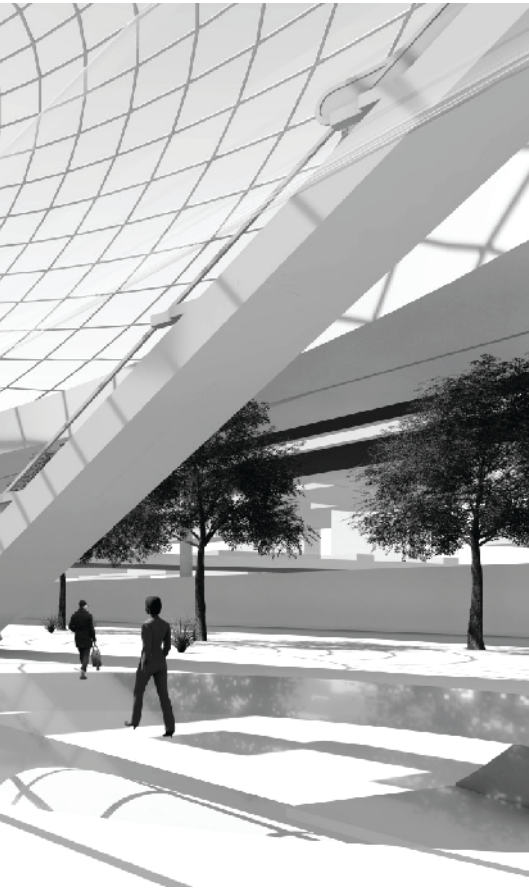

Detroit locates the bus and auto terminal below grade as well, resulting in programmatic freedom above grade. A market, museum, community center, hotel, and retail are included to provide amenities for locals and travelers alike. Rather than pursuing a uniform language for all of these programs, steel is used differently in each structure to create varied pedestrian-scale architecture. Pedestrians are welcomed to the terminal under two large canopies that lead into the main terminal hall. The journey on foot to and from the station is pedestrian-friendly thanks to the removal of the Interstate and new surface streets with wide sidewalks. Outdoor plazas with active edges make for compelling public spaces. Automobile access is provided to the terminal one level below grade, with cars entering from the I-75 interchange. No parking is provided, as autonomous vehicles are soon to be adopted and there is an abundance of existing parking garages nearby. The hyperloop portion consists of a 24-passenger pod that travels inside of a vacuum-sealed tube 11 ft in diameter. An interconnected network of stations is capable of connecting upwards of 80% of the population in significantly less time than it takes to fly. Stations are optimally spaced at 150 miles or more.

Perpetual Motion

Student: Alexander Brosh, University of Illinois at Urbana-Champaign
Faculty Sponsor: Erik Hemingway

The Perpetual Motion rail terminal provides an intermodal transportation hub that connects three critical forms of transportation for the Chicago area. The first, the Airport Transit System, is a system of elevated rail lines that connect the rail terminal with Chicago's O'Hare International Airport.

The lower levels of the building host the Chicago Express Loop, a new method of transportation developed by Elon Musk's Boring Company, which allows passengers to travel from O'Hare to downtown in just 12 minutes using automated vehicles that move through a tunnel. However, the (third) main mode of transportation supported by the facility is high-speed rail. The design is driven by a connection to five train platforms, through which passengers will be able to access the suburbs of Chicago as well as major cities throughout the Midwest. Through these means of transportation, the terminal acts as a gateway to the city of Chicago, the Midwest, and to the rest of the country.

The building's design has a close relationship with steel. The floor plates are composed of 4-ft-deep steel trusses. The main interior space, the large concourse that provides access to the high-speed rail platforms, is light and airy, with few columns despite its size. This is made possible through a second, more robust steel truss system, which is nearly 10 ft deep.

The defining visual feature of the building is the façade system, which covers the large expanses of glass on the concourse. Functioning as a sun-shading system, a grid of slim steel members support thousands of lightweight galvanized steel panels that work together to shelter the interior from the sun. These panels are hinged on their top edge, allowing wind to freely lift them, creating an astonishing ripple effect along the façade for millions of travelers to physically see the perpetual motion of the Windy City.

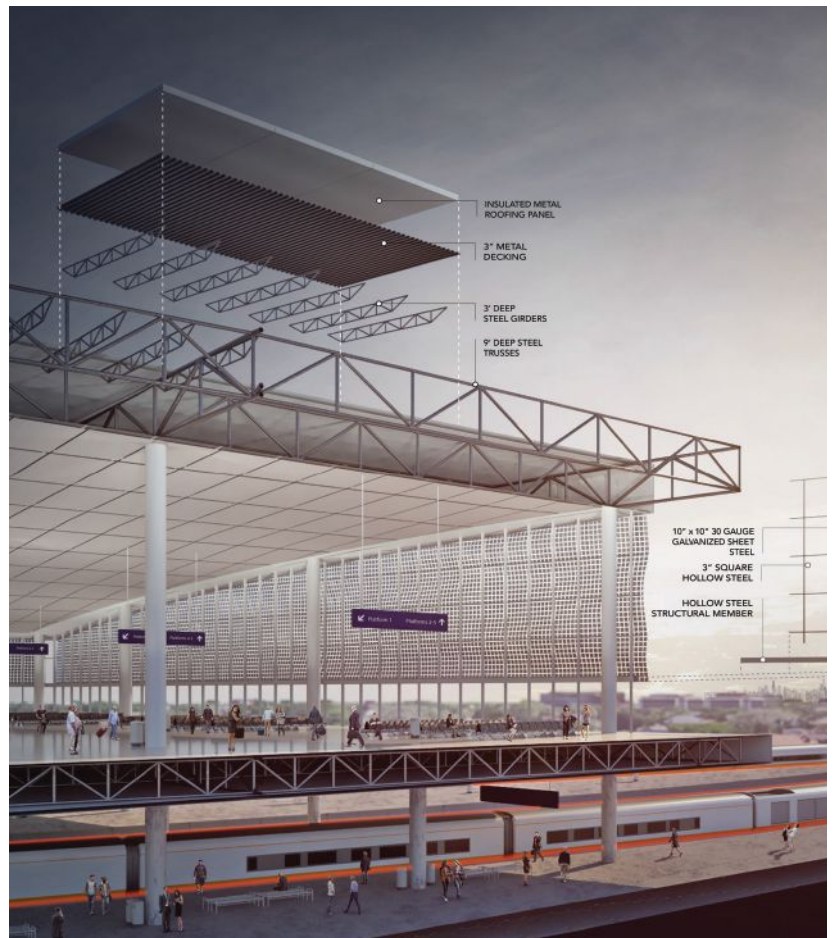

CATEGORY II: OPEN
Winners

1st

Fluid Knowledge

Student: Brenton Rahn,
University of Nebraska-Lincoln
Faculty Sponsor: David Newton

The world of digital design and robotic fabrication offers dynamic and exciting ways to create buildings with a more innovative method.

Using this workflow, Fluid Knowledge is comprised of a steel space frame structure, covered by a paneling system that allows natural light to reach the main spaces where knowledge is being fostered, such as laboratories, collaboration areas, fabrication spaces, and classrooms. A central boulevard serves the users as an engager of creativity, inspiration, and wonder while also providing an ample space for circulation and interdisciplinary collaboration.

To create the steel frame, long tubes of steel are cut by an industrial waterjet cutter to the required dimensions, then bent through a CNC roller to precisely achieve the desired curvature. Next, each steel member is arranged and laid out with its counterparts, and small sections of the space frame are constructed. Each constructed section is assembled and then welded together by a CNC welder, then the assembled sections are transported to the site for placement and construction.

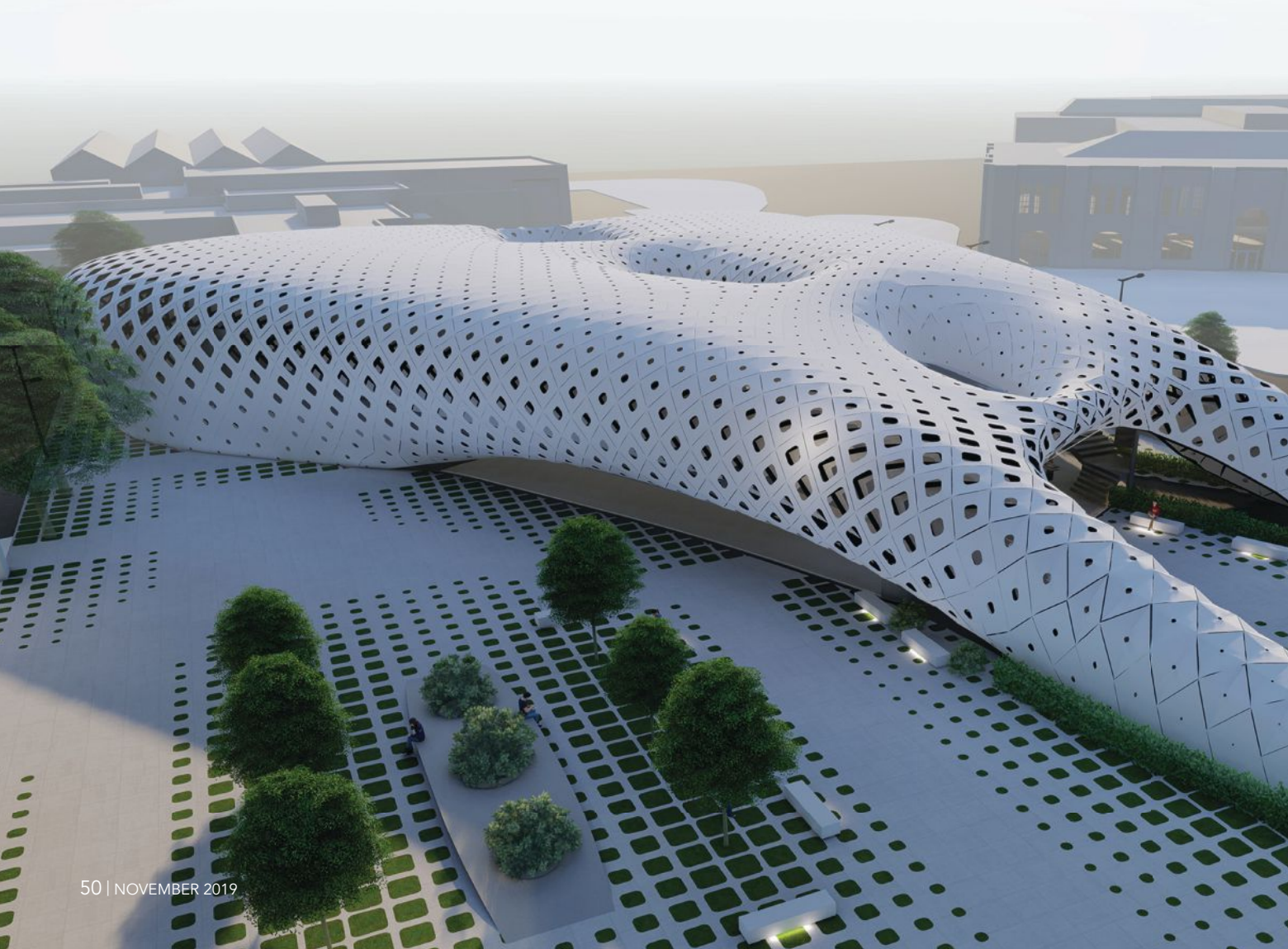
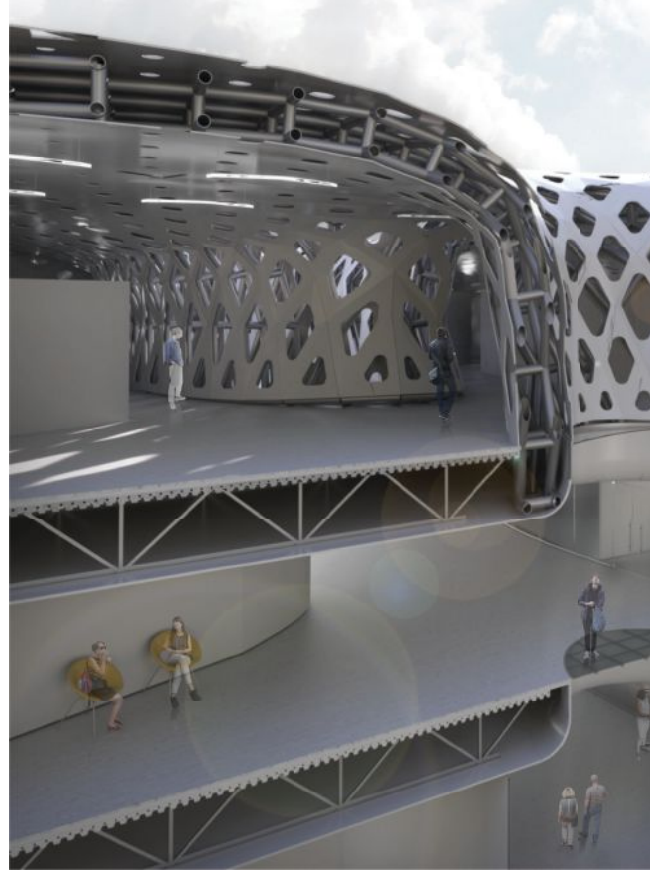

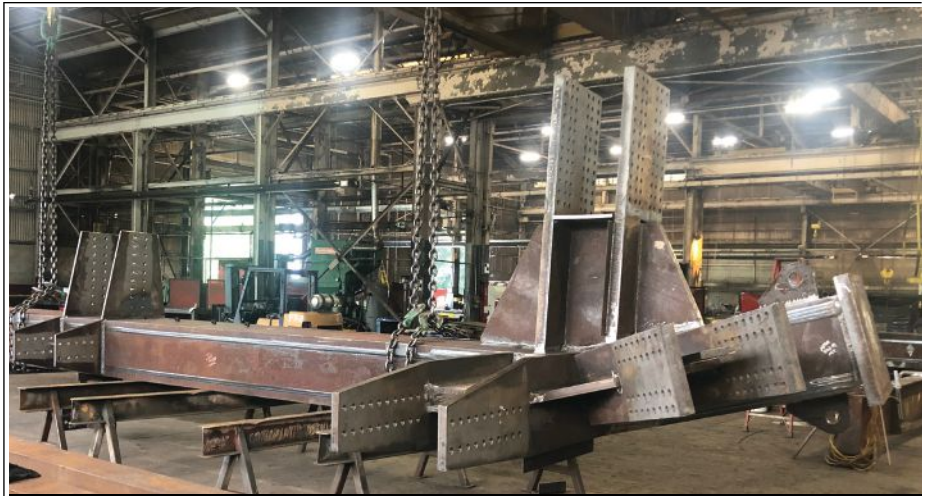
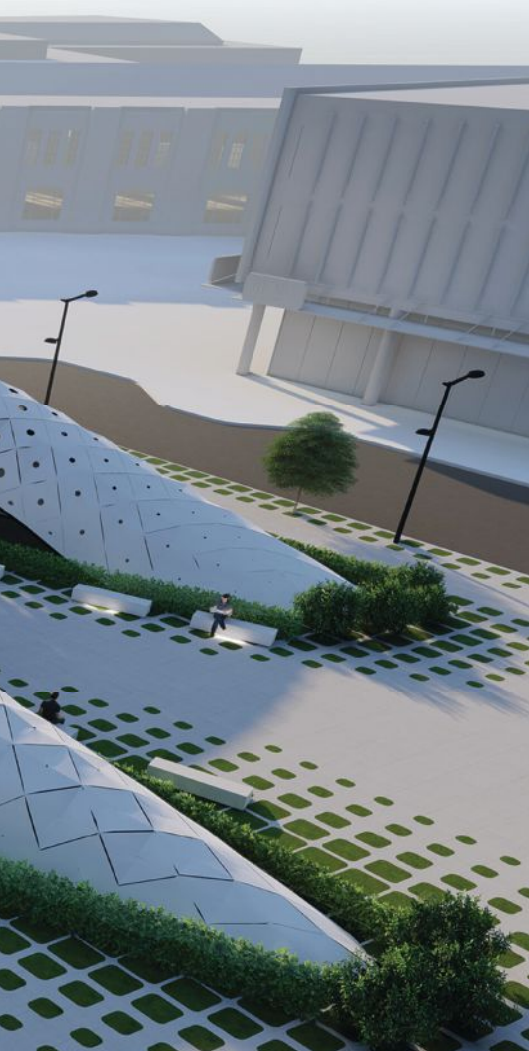
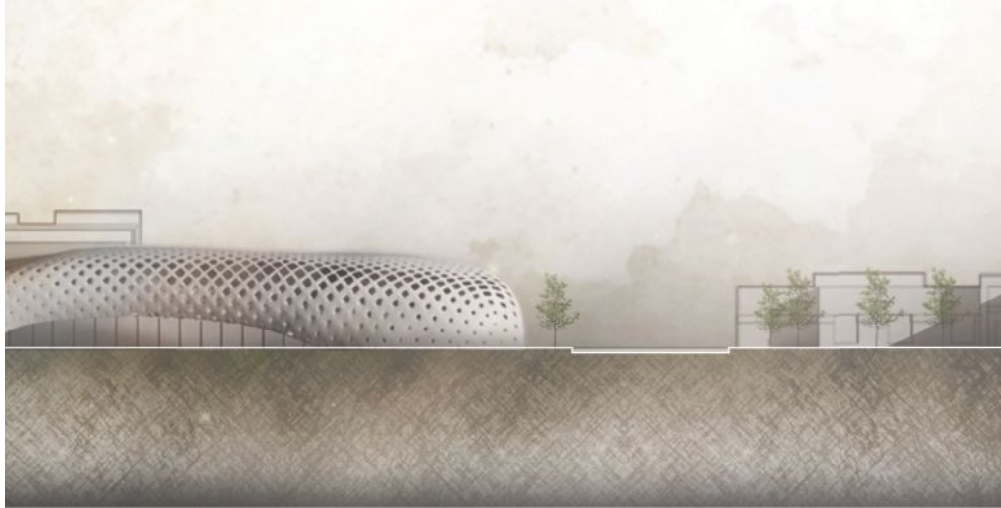

Fast track, complex fabrication and hauling challenges? No problem.

JGM can do *for you* what it did for one of the largest steel fabricators in the country on a high rise project in NYC.

When you need additional support for speed, efficiency and quality craftsmanship, choose JGM to handle any or all of the complex fabrication and welding.

Why JGM?

- Strategically located with convenient access to the Northeast and NYC
- Ability to remain on call and deliver last-minute items and fixes to support the erectors
- Close proximity to ArcelorMittal plate mill in Coatesville, PA
- JGM's transportation group handles all logistics for overweight, over-sized, over-length and super loads
- NYCDOB Certified fabricator
- Sandblasting and sophisticated coatings

A TRUE partner. When you need it yesterday, JGM delivers. Challenge us!



610-873-0081 | solutions@jgmusa.com



JGMUSA.COM

CATEGORY II: OPEN
Winners



2nd

The Power of Place

Student: Pimpakarn Rattanathumawat,
Illinois Institute of Technology
Faculty Sponsor: Catherine Wetzel

U.S. Steel closed its South Works site in 1992 after more than 100 years of steel production. Since then, an EPA-supervised cleanup was conducted and two large-scale mixed-use developments have been planned and abandoned. The 440-acre former industrial site continues to be plagued by soil contamination issues, but a new project hopes to tackle them while also allowing the public to view the progress firsthand.

The Power of Place research center incorporates the original 30-ft-high walls from the South Works to provide a walkway and observation decks to provide visitors with a panoramic view of the soil remediation process. The research center itself uses the excellent load-bearing capacity of the wall to suspend itself on both sides of the wall. Steel I-beams placed on top of the wall are attached to tension rods and cables to provide a support for the concrete slab and glass enclosure. The facility incorporates a suspended roof (without interior columns), under-floor air ducts, and in-floor radiant heating to create a universal space that can be adapted to new uses once remediation is completed.



3rd

Stadio Della Roma
Student: Christy Yu,
Oklahoma State University
Faculty Sponsor: Paolo Sanza

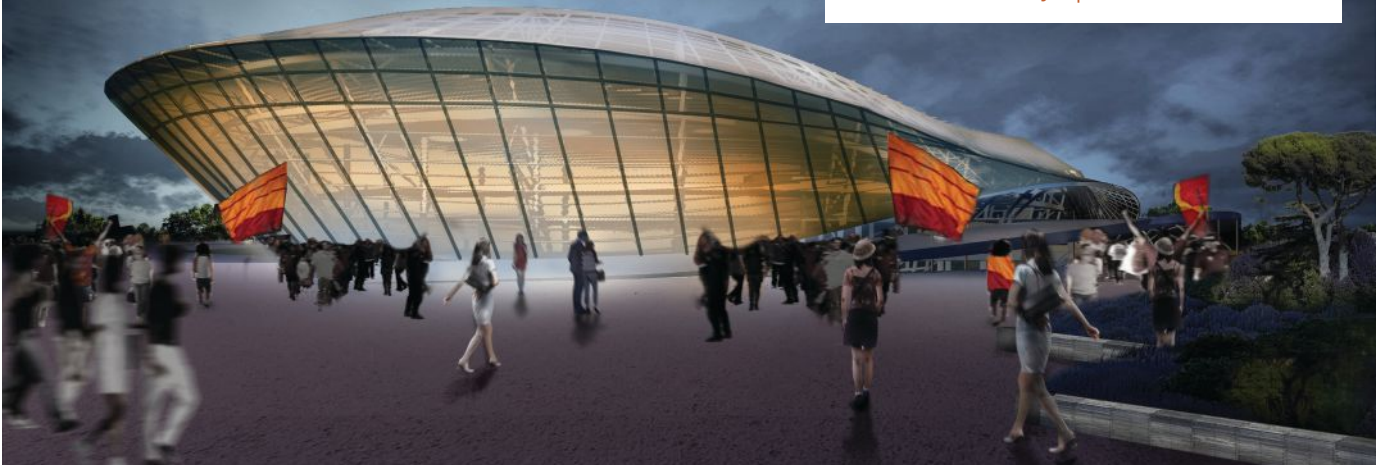

Located in the Tor di Valle neighborhood of Rome, Stadio Della Roma is a complex composition of functional spaces and open plazas. The stadium, built for the AS Roma soccer team and the city of Rome, acts as a gathering space for the vibrant soccer culture of the area. In addition to the stadium, which can accommodate 50,000 spectators, the site also contains a retail area, support-

ing facilities, and office space. Through the creation of a sunken plaza and a series of dynamic ramps and side bridges, a connection is made between the retail area and the stadium grounds, and people are led from the ground floor up the bridge to the higher entrance. During the off-season, the area continues to provide services as a retail mall and park.



ONE MACHINE DOES IT ALL

Save time and money with all-in-one plasma cutting, milling & drilling

Visit Us At Fabtech Booth #A4942



Kinetic KineticUSA.com
1.800.606.2954

Organic Recurrence: A Lightweight Monocoque System

Student: Richard Moore, Clemson University
Faculty Sponsor: Daniel Harding

A new natatorium stretches the idea of what a community pool can be. The facility actually contains three pools, all designed and placed so as to maximize natural light into the facility while still allowing ample space for spectators to view swim meets. Surrounding the two competition pools are spaces that allow for meetings, as well as offices to help maintain the natatorium, and a third pool functions as a therapy pool. In addition, a 10,000-sq.-ft gym offers the public a dry place to exercise.

All of this programming occurs within a monocoque system, a structural system where loads are supported through an external skin. Following this premise, the system, clad by lightweight aluminum panels, allows for structural integrity in not only the joints, but also in the skin itself. This lightweight monocoque system allows for quick solutions to unique structures that are unique not only qualitatively but also quantitatively. Organic forms tend to take on the persona of the architect that designs them, as each one has a unique system that is constant to the architect themselves.

By implementing form-based data, taken from a feasibility study, and plugging it into an algorithm that gives a unique shape based on the site as well as the program, a design team is able to create a gem within the city no matter where it is placed. Further investigation into this project will be examined to progress the algorithm's past testing phases and refine the system's efficiency based on other building types besides natatoriums. The hope is that this project can change the way we consider long-span structures for efficiency and beauty.

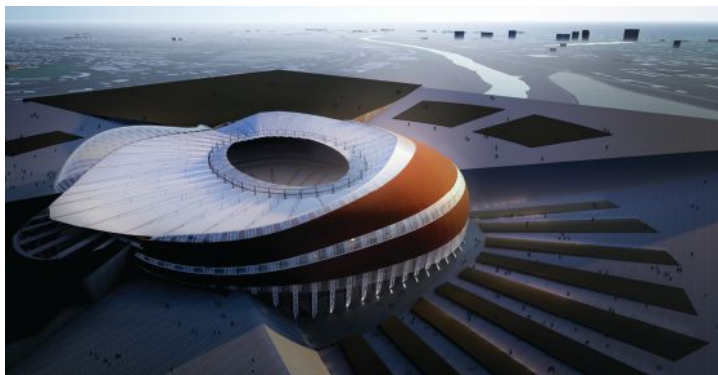

Stadio Della Roma

Student: Esteban Ley, Oklahoma State University
Faculty Sponsor: Paolo Sanza

As the new home for AS Roma, the Stadio della Roma, located in the south of Rome and flanking the Tiber River, speaks of the vitality and energy of the AS Roma soccer team's fans—and it does so without neglecting those characteristics that make of Rome a remarkable city. Paramount in the design was addressing the entrance sequence into the stadium.

Like a relic of old Roman construction, the stadium lies embedded in the earth. All its layers are created by the intersection of massive earthen architecture and cutting-edge steel structure, which, with its repeating vertical trusses, draws the eye upwards. An emphasis on the human and spatial experience leads this design to consider scale, materials, and circulation of the stadium building typology. With a unique consideration of the variety of users, which gather for soccer matches, the earth was integrated as part of the facade to create intentional moments of underplayed elegance and monumental entrance.

Approaching the glass and terracotta form bellowing out from the ground, fans are drawn into the airy lace of elegantly lit white steel trusses. Both the monumental façade, exposed by the carved land, and the cavernous concourse space, stretched by sculptural bridges, celebrate the team and its fans. Terracotta was incorporated alongside a steel structural system to call back to deep tradition and common materials of Rome. To create a variation of how different users experience the stadium, the land itself was altered. The variety of sectional quality investigates the visual interaction that fans have with each other and the stadium. By placing the building partially underground and peeling back the surface of the earth, people are guided inward towards the stadium. As the ground rises and falls, the skin of the stadium interacts with the fans in different ways.

Spatial zones and functional spaces are stratified in plan first, and directional circulation traverses a concentric organization of spaces, with the stadium as the center. Retail and stadium masses are articulated radially through wedged zones, and entrances for different fan groups are separated from one another.

Retroactively, the earth pushes against the stadium form, creating a variety of building scales across the façade. Areas where the ground is recessed create a monumental entrance, while areas that are mostly covered by earth lead the visiting teams through an underplayed and simply elegant entrance, leaving them with a feeling of anticipation. Finally, once the ground is peeled away from the façade, bridges are added for circulation up to the third-tier stadium seating. The overall system of steel and terracotta forms a rhythm and pattern to the skin akin to the diverse textures found in Ancient Roman construction.

The Seattle Water-ing Hall: A Public Waters Research and Education Center

Student: George Lee, University of Washington

Faculty Sponsor: James Nicholls

Water is a universal and powerful force in all our lives, deserving to be celebrated. The Seattle Water-ing Hall (Water Research and Education Center) celebrates the importance of water research through an inviting public interior space along the Seattle waterfront.

The building collects and invites water to penetrate the structure, using the combination of water and architecture to subvert relationships of interior and exterior and giving a sense of place on the working waterfront.

Three platforms develop a theatrical and programmatic interpretation of unique experiences of water:

1. collected volumes of water to be processed, studied, and used
2. planes of water and a space of respite
3. droplets of water contrasted with access to Elliot Bay

The building is an organized vertically as an open steel framework under a canopy of water and an envelope of ethylene tetrafluoroethylene (ETFE). The ground floor activates the street edge through an exhibition hall, cafe, take-out restaurant, and presentation space. The research office is a separated volume and platform. A strong cylindrical volume invites the public to journey down underneath the waterfront piers to discover and access the underworld of the waterfront, which is mostly built on piers and piles. A rooftop bar becomes a lookout point from which both the natural context of the Olympic Mountains, Puget Sound, and downtown Seattle are visible all at once. ■

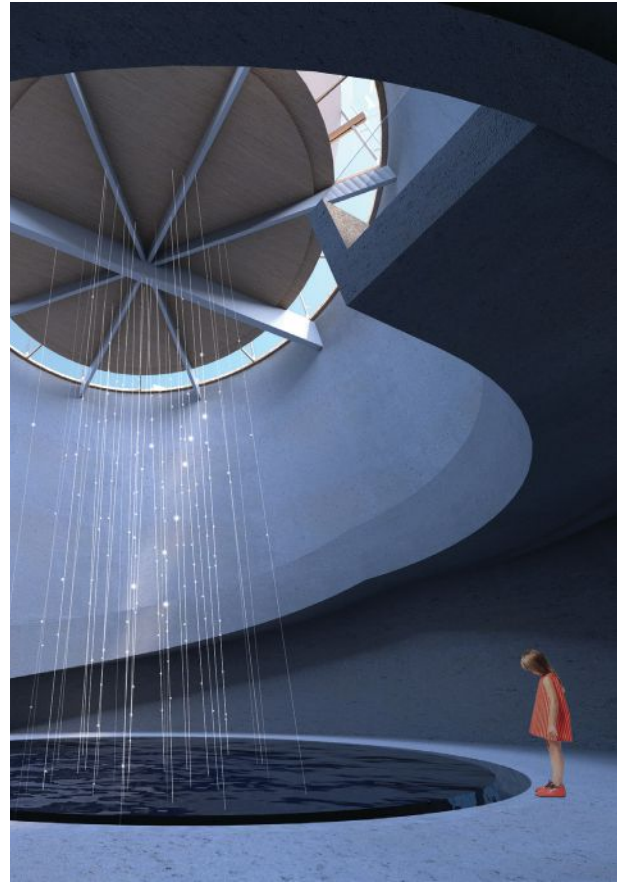

IT'S ALL ABOUT STEEL DECK

25 plants in North America

Annual production capacity of 860,500 tons

Design and fabrication for over 50 years



CANAM

canam-construction.com

1-866-466-8769

Safety in Numbers

BY KRISTEN CHIPMAN

Safety should be an ongoing discussion, and OSHA's annual lists of safety violations provide a good reference point in your own company's safety conversation.

WHEN IT COMES TO CREATING a safe workplace, one of the most crucial components is awareness.

And while many think of the Occupational Safety and Health Administration (OSHA) as the safety police and dread the thought of committing an OSHA violation, the organization is just as geared toward safety awareness and hazard prevention as it is to enforcing safety rules.

This is why it releases an annual series of lists of top safety violations—so workers know what the biggest risks are and can stay on the lookout for them—and it recently announced the most common violations for 2018. Employers can compare these lists with their own safety records, adjusting their safety programs as necessary, and use them as a barometer to determine whether their facilities and construction as a whole are operating more or less safely every year.

Below is the 2018 list of top 10 violations, by general category, for all industries:

1. Fall protection – general requirements: 6,010 violations
2. Hazard communication: 3,671
3. Scaffolding: 2,813
4. Lockout/tagout: 2,606
5. Respiratory protection: 2,450
6. Ladders: 2,345
7. Powered industrial trucks: 2,093
8. Fall Protection – training requirements: 1,773
9. Machine guarding: 1,743
10. Personal protective and life-saving equipment – eye and face protection: N/A

The changes from the 2017 list are minimal. In 2017, “Electrical wiring methods” was in the 10th spot but was replaced by “Personal protective and life-saving equipment – eye and face protection” in 2018. This is a minor change in rank but nevertheless a good reminder that eye and face protection is something we can continue

to improve—especially since it effects many if not all workers in fabrication and other steel facilities, as well as on job sites.

As steel fabricators and erectors, our industry has its own specific hazards. While the OSHA violations for our industry are slightly different from the overall violations list, they are similar in that they do not change much from year to year. The good news is we know what the risks are and can take action to reduce or even prevent these types of accidents, injuries, and violations in the future.

Here is the list of top ten violations for steel fabricators (the full list is available at tinyurl.com/osh332312; note that all citations stem from OSHA inspections):

Citations	Inspections	Penalty	Description
60	25	\$54,886	Respiratory protection
53	44	\$193,902	General requirements for all machines
50	32	\$156,941	The control of hazardous energy (lockout/tagout)
47	27	\$48,219	Hazard Communication
29	22	\$62,320	Powered industrial trucks
18	9	\$19,087	Occupational noise exposure
18	12	\$79,445	Overhead and gantry cranes
17	15	\$25,510	General requirements
17	13	\$20,064	Wiring methods, components, and equipment for general use
14	8	\$17,620	Abrasive wheel machinery

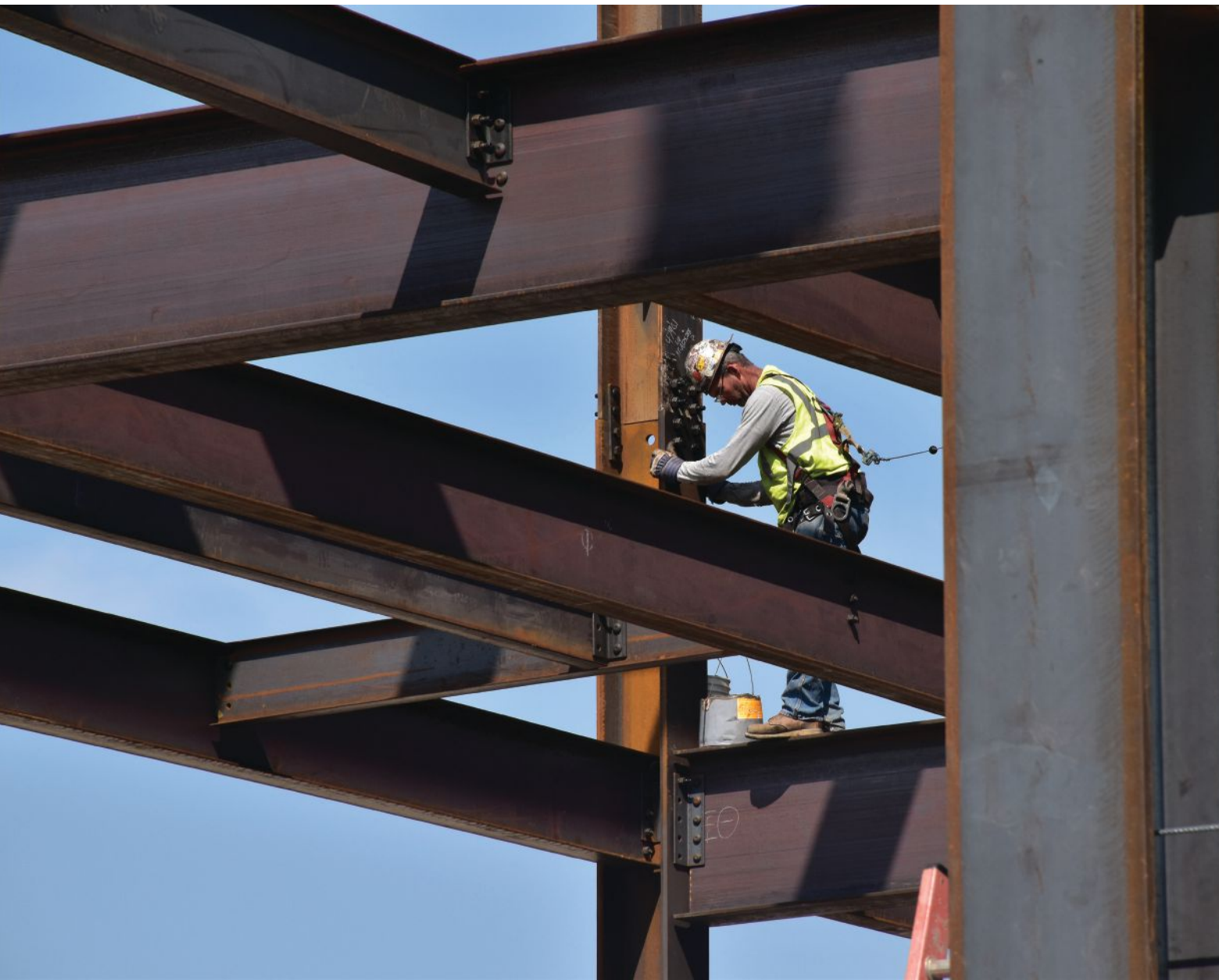

Erectors fall under construction, and the top nine construction violations are as follows (no description was included for the tenth item; the full list is available at tinyurl.com/osha238120):

Citations	Inspections	Penalty	Description
65	65	\$332,849	Fall protection
59	52	\$143,371	Aerial lifts
42	39	\$199,908	Duty to have fall protection
41	29	\$131,421	General requirements
26	17	\$58,674	Fall protection systems criteria and practices
25	21	\$58,172	Ladders
18	18	\$93,144	Training
17	10	\$15,788	Hazard communication
14	11	\$15,949	Powered industrial trucks



Kristen Chipman (kchipman@cianbro.com) is an environmental, health, and safety professional with AISC member Cianbro Fabrication and Coating Corporation and a member of AISC's Safety Committee.



World's **FASTEST** Structural Marking System

FOUR independent fiber lasers

LASER MARKING
layout system

by **Controlled Automation**
www.controlledautomation.com | 501-557-5109

Information printed directly from the 3D model

NO consumables or gases needed

What we should not do with these lists is limit our attention to only those hazards shown. We are responsible to our employees for providing a safe workplace, so all potential hazards are important. But we can use these lists as a reminder of the problems OSHA finds in our shops and on our job sites and add their items to our own list of hazards to consider when performing inspections and evaluating and updating our safety plans.

For example, looking at the list for erectors, we see that fall protection-related violations (“Fall protection,” “Duty to have fall protection,” and “Fall protection systems criteria and practices”) add up to a total of 133 citations, so making fall protection a primary focus of every walkthrough seems warranted. From there, it might make sense to review “Aerial lifts,” second on the list, and make an extra effort to ensure that those requirements are met and workers are aware of them (aerial lifts could be a tool box talk topic that week, followed by ladders the following week).

On the fabrication side, “Respiratory protection” is the most frequently cited hazard, but its monetary penalty (\$54,886) is significantly lower than those of “General requirements for all machines” (\$193,902) and “Lockout/tagout” (\$156,941). Keep in mind that the number of accidents and injuries due to each hazard would also be a good way to analyze and rank hazards, but since that information is not readily available, the penalty amounts noted provide some measure of the seriousness of each listed hazard.

Safety is an essential topic, but it can be difficult to keep workers engaged in thinking about it. These OSHA lists can help inject a sense of timeliness into the safety conversation and give them something different to think about while also allowing you to reinforce the essentials. And they certainly don’t trump your company’s own list of most frequent incidents and most



injurious hazards in your own facility. After all, no one knows your facility and safety policies as well as you and your employees (and keep in mind that OSHA is the minimum safety standard; your own policies can and often should be even more stringent). But weaving these industry-wide lists into your localized safety goals

can help keep your designated safety professionals, supervisors, and workers up-to-date on the wide breadth of safety issues, and also serve as an annual reminder that our workplaces and their inherent risks aren't static. And they further reinforce your commitment to providing a safe workplace for your employees. ■

lindapter[®]

ICC-ES APPROVED

Celebrating 85 years of Innovation

Faster Steel Connections

Lindapter's Girder Clamp (Type AF / AAF) and Holo-Bolt[®] provide a faster, cost-effective alternative to drilling or welding in the field and are **ICC-ES approved** for structural use in Seismic Design Categories.

- ✓ No drilling or welding in the field!
- ✓ High strength capacities
- ✓ Faster installation reduces labor costs
- ✓ Compliant with the International Building Code
- ✓ Free connection detailing service



Request an ICC-ES brochure for design data. Call **866 566-2658** or visit **www.LindapterUSA.com**

news & events

FABRICATOR NEWS

Dave Steel Company Paints Project Pink for Breast Cancer Fundraising Campaign

Steel sure looks pretty in pink, especially when it's raising awareness and funds for breast cancer research. AISC member fabricator Dave Steel Company, in conjunction with contractor Beverly-Grant and building owner Sixty-West Funds/Preserve Communities, has painted the balcony steel of an Asheville, N.C., building project pink. Their campaign, Pink Strong | Steel Strong, will raise money for the American Cancer Society to fund breast cancer research, education, and comprehensive support for breast cancer patients.

Babette Freund, executive vice president of Dave Steel Company and an AISC board member, has been looking for the ideal opportunity to use pink steel for breast cancer awareness. The project at 145 Biltmore Avenue provided the perfect

team and location for the effort. Dave Steel Company, Beverly-Grant, and Sixty-West/Funds Preserve Communities share the belief that giving back to the community is of paramount importance. That checked one box for Freund. Location checked the other: Biltmore Avenue is a high-traffic and high-exposure stretch of road that extends into downtown Asheville, where many people will see the pink condominium balconies during their commute. The pink steel remained visible through October (Breast Cancer Awareness Month).

"As the community is what supports and sustains us, it is our privilege to pay it forward," said Freund. "Breast cancer is a disease that has touched so many of us, and we appreciate the opportunity to work together to raise funds in search of a cure."



TRAINING

SEAA Expands Craft Training Program to Community and Technical Colleges

The Steel Erectors Association of America (SEAA) is making its SEAA/NCCER (National Center for Construction Education and Research) Ironworker Craft Training Program available to students at technical and community colleges. This expansion will bring NCCER-accredited testing for craft professions to more local communities.

Colleges will be able to become members of SEAA, providing them with access to the Craft Training program and other NCCER craft curriculum and assessments.

"As demand for skills training grows,

SEAA seeks to provide communities with the resources and students with the pathways necessary to get the training, qualifications, and certifications necessary for careers in construction," said Tim Eldridge, president of Education Services Unlimited and SEAA's Craft Training and Assessment administrator.

Post-secondary institutions may join SEAA for a fee of \$700, giving them the opportunity to become an accredited training unit and/or an authorized assessment site. Find out more about the program at www.seaa.net.

People and Companies

- As of January 1, 2020, **Thornton Tomasetti** managing director **Peter DiMaggio** and managing principal **Michael Squarzini** will become co-CEOs of the company, with current CEO and chairman **Tom Scarangelo** assuming the role of executive chairman. Managing principal **Wayne Stocks** will become president and, along with managing director **Gary Panariello**, will co-lead the firm's business units. **Raymond Daddazio**, who currently serves as president, will become senior consultant.

- **Nucor Corporation's** chairman and CEO, **John J. Ferriola**, will retire effective December 31, 2019. Ferriola began his tenure at Nucor as the manager of maintenance and engineering at **Nucor Steel-Texas** in 1991.

"We are better for the leadership of John Ferriola in his work at Nucor and the meaningful involvement he has fostered for Nucor in the activities of the industry and AISC," said **AISC** president **Charles J. Carter**.

Leon J. Topalian, Nucor's current president and chief operating officer, will succeed Ferriola as CEO effective January 1, 2020.

"Leon has provided great support to AISC as a member of our Board for the past several years, and we are excited for him—and for Nucor—in his new role," said **David Zalesne**, chair of the AISC Board of Directors and president of AISC member fabricator **Owen Steel Company, Inc.** "I have been fortunate to have the opportunity to work closely with Leon on many issues affecting the industry, and I have no doubt that he will continue to provide tremendous leadership to Nucor and to the American steel industry."

SCHOLARSHIPS

Annual AISC Scholarship Winners Announced

AISC has announced the winners of its 2019–2020 scholarships.

A total of \$262,500 in scholarships has been awarded to 73 deserving undergraduate and masters-level students for the 2019–2020 academic year.

The AISC David B. Ratterman Fast Start Scholarships program awarded a total of \$64,000 in scholarships to 20 students this year. The program awards children of AISC full member company employees who will be freshmen and sophomores during the upcoming academic year. The students may attend two- or four-year programs and may choose any area of study.

For the second straight year, Puma Steel in Cheyenne, Wyo., held a student welding competition where local high school students competed to win scholarships to attend the welding program at Laramie County Community College (LCCC). AISC administered funding to three students who entered LCCC’s welding program this fall. You can read more about the competition in the article “Winning Welding in Wyoming” in the September issue (www.modernsteel.com).

For the Student Steel Bridge Competition (SSBC), AISC funds \$12,000 in scholarships to select students from five teams that participated in the SSBC National Finals. These awards include the top three team finishers as well as two team awards for spirit and ingenuity.

Finally, the AISC Education Foundation, in partnership with several other structural steel industry associations, awarded \$186,500 to 47 students. AISC is thankful for the growing support of our industry partners and offers our sincerest thanks for their generous, continued contributions.

If you are interested in donating to the AISC Education Foundation scholarship program, please visit aisc.org/scholarships for more information.

Without further ado, here are the winners of the 2019–2020 academic year AISC scholarships:

Puma Steel SteelDay Welding Scholarships

- Erick Beltran : *Note: All three winners attend Laramie County Community College and are not pictured.*
- Agustin Loya
- Edgar Vega

David B. Ratterman Fast Start Scholarships



\$2,000 Award Recipients

- Chloe Auxier (*not pictured*), Triton College
- Nathan Box, Jefferson State Junior College
- Amy Corneliusen, Ridgewater College
- Logan Dalton, New Life Church College
- Matthew Fleischer, Asheville–Buncombe Technical Community College
- Joseph Richter, Bismarck State College
- Emma Schlossman, Montgomery County Community College
- Eric Unger (*not pictured*), Blue Ridge Community College

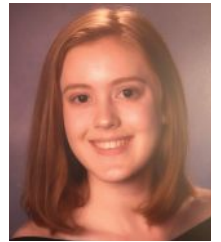
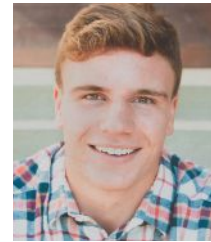

\$4,000 Award Recipients

- Mick Bailey, University of Wyoming
- Aaliyah Biamby, Thomas College
- Samuel Blaser, University of Nebraska Omaha



- Daniel Breault, The University of Rochester
- Drew Grismer, Purdue University
- Estrella Leos, University of Texas at Arlington
- Zai Medina (*not pictured*), California State University, Fullerton
- Kendyll Meyer, Indiana University of Fort Wayne
- Andra Raibulet, Butler University
- Isabella Timmons, Hobart and William Smith Colleges
- Marissa Tucker, Alfred State College
- Reyna Vialpando (*not pictured*), Metropolitan State University of Denver

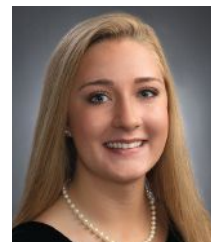
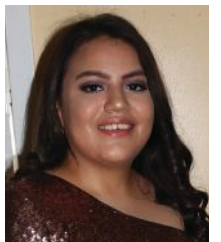

news & events

AISC Scholarships for Juniors, Seniors, and Masters Students:



Education Foundation Scholarships

- Eric Bianchi, Virginia Polytechnic Institute and State University
- Haley Bigando, Syracuse University
- Madison Broers, Washington State University
- Lisa Brown, University of Cincinnati
- McHugh Carroll, University of Michigan
- Mindy Castle, South Dakota School of Mines & Technology
- Seth Caudle, Virginia Polytechnic Institute and State University
- Annie Clark, University of Cincinnati
- Rebecca Dempewolf, Oklahoma State University
- Tarah Driver, New York University
- David Gawryla, The Pennsylvania State University
- Kiel Ise, Colorado State University
- Mary Juno, University of Kansas
- Alexandra Kavar, Massachusetts Institute of Technology
- Michael Kearns, University of California, Berkeley
- Daniel Leipter, Southern Illinois University
- Allison McEntee, Virginia Polytechnic Institute and State University
- Angie Mitchell, Kansas State University
- Scott Overacker, University of Minnesota Twin Cities
- Adam Schulz, The University of Texas at Austin
- Ronald Slaven, Virginia Polytechnic Institute and State University
- Ryan Stevens, Virginia Polytechnic Institute and State University
- Jennifer Ventrone, University of Illinois at Chicago
- Ella Yazbeck, University of Michigan
- Rachel Zable, Case Western Reserve University



AISC Scholarship winners continue on pages 63 and 64.

AISC/Associated Steel Erectors of Chicago

- Jacob Behnke, Illinois Institute of Technology
- Isaias Colombani, University of Illinois at Urbana-Champaign
- Hannah Golden (*not pictured*), Illinois Institute of Technology
- Joshua Harmon, Purdue University
- Evan Harms, Southern Illinois University Edwardsville
- Mary Lazar (*not pictured*), Northwestern University
- Karolina Urban, University of Illinois at Urbana-Champaign
- Andrew Witte, Valparaiso University

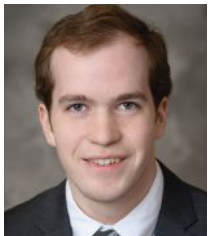

AISC/Southern Association of Steel Fabricators

- Malaak Araujo, University of South Florida
- Stephen Day, University of Kentucky



AISC/ Great Lakes Fabricators and Erectors Association

- Jared Millman, University of Michigan



AISC/ Ohio Steel Association

- Lisa Brown, University of Cincinnati



**Owners, Contractors and Ironworkers:
You're Invited!**



**Tuesday, April 14 - Friday, April 17, 2020
SHERATON GRAND CHICAGO**

Owners will witness first-hand the incredible developments in SAFETY and technology. Contractors and ironworkers understand that the conference is attended by the best minds in the construction industry and geared toward their success and continued growth.

— This is how: —

- Multiple world-class breakouts led by industry-leading experts and developed for your success
- Two days of networking opportunities with decision-makers who are normally inaccessible
- Panel discussions that will keep you ahead of the curve, providing insight into how the industry is changing and evolving

DON'T MISS THE INDUSTRY'S PREMIER CONSTRUCTION CONFERENCE!

Visit the Events Tab on the **IMPACT** website
(WWW.IMPACT-NET.ORG) Or scan the QR code below.



news & events

AISC Scholarships for Juniors, Seniors, and Masters Students:

Student Steel Bridge Competition

- Kawthar Ahmed Alahmed, Purdue University Northwest
- Anthony Fadke-Giblin, Purdue University Northwest
- Matthew Hone, Youngstown State University
- Drew House, Youngstown State University
- Shoshanna Johnson, University of Alaska Anchorage
- Patricia Notti, University of Alaska Anchorage

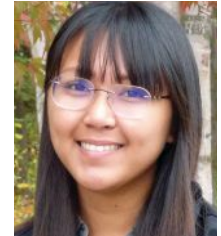

Note: The first place (Lafayette College) and second place (University of Florida) team scholarships were not decided at the time of print.

AISC/W&W Steel/Oklahoma State University (program includes sophomores, juniors, and seniors)



- Evan George, senior, Civil Engineering
- Jesse Matthews, senior, Construction Management
- Jacqueline Fuller, junior, Civil Engineering
- Nathaniel Northcutt, junior, Construction Management
- Kirby Lough (*not pictured*), sophomore, Architectural Engineering
- Jeffrey Collier (*not pictured*), sophomore, Civil Engineering
- Kelsey Hooper (*not pictured*), sophomore, Construction Management



AISC/Rocky Mountain Steel Construction Association

- Isabella Baumann, University of Colorado Boulder
- Emily Tran, Colorado School of Mines



AISC/Indiana Fabricators Association

- Joshua Harmon, Purdue University
- Cameron Horan (*not pictured*), Trine University
- Marcus Gahagen, University of Evansville



The AISC Scholarship jury consisted of the following individuals:

- Benjamin Baer, Baer Associates Engineers, Ltd.
- David Bibbs, Cannon Design
- Christopher Brown, Skidmore, Owings & Merrill, LLP
- Luke Johnson, AISC
- Rose McClure, Simpson Gumpertz & Heger
- Steven Offringa, EXP
- Kristi Sattler, AISC
- Matthew Streid, Magnusson Klemencic Associates

The David B. Ratterman Scholarship Jury consisted of the following individuals:

- David B. Ratterman, Scholarship Committee Chair
- Jack Klimp, Vice Chair, Board of Directors
- Lawrence Cox, AISC Board Member
- Babette Freund, AISC Board Member
- Patrick Leonard, AISC Board Member
- Hugh McCaffrey, AISC Board Member

AISC/UIUC Architecture Scholarship

- Musa Muhammad

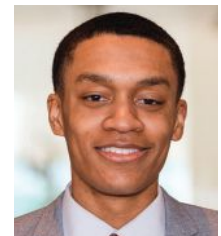

marketplace & employment

Structural Engineers

Are you looking for a new and exciting opportunity?

We are a niche recruiter that specializes in matching great structural engineers with unique opportunities that will help you utilize your talents and achieve your goals.

- We are structural engineers by background and enjoy helping other structural engineers find their "Dream Jobs."
- We have over 30 years of experience working with structural engineers.
- We will save you time in your job search and provide additional information and help during the process of finding a new job.
- For Current Openings, please visit our website and select Hot Jobs.
- Please call or e-mail Brian Quinn, PE (616.546.9420 or Brian.Quinn@FindYourEngineer.com) so we can learn more about your goals and interests.

All inquiries are kept confidential.

SE Impact by SE Solutions, LLC | www.FindYourEngineer.com



PROJECT MANAGER, STEEL DETAILING

Responsible for leading projects start to finish, ensuring that detailing and connection design scope is completed on time and within budget. Nashville Metro Area, TN

- 10 years experience managing steel detailing projects
- Able to read construction documents, project specs, structural & architectural drawings
- Strong knowledge of construction process, steel fabrication & erection, plus AISC, AWS, OSHA, Joist Codes, etc.
- Advanced 3D modeling using SDS, Tekla Structures
- Team player

Submit your resume today! | trchr@trcww.com

QMC Contract Auditor

Quality Management Company, LLC (QMC) is seeking qualified independent contract auditors to conduct site audits for the American Institute of Steel Construction (AISC) Certified Fabricators and Certified Erector Programs.

This contract requires travel throughout North America and limited International travel. This is not a regionally based contract and a minimum travel of 75% should be expected.

Contract auditors must have knowledge of quality management systems, audit principles and techniques. Knowledge of the structural steel construction industry quality management systems is preferred but not required as is certifications for CWI, CQA or NDT. Prior or current auditing experience or auditing certifications are preferred but not required. Interested contractors should submit a statement of interest and resume to contractor@qmconline.org.

LATE MODEL STRUCTURAL STEEL FABRICATING EQUIPMENT

Controlled Automation DRL-336 CNC Beam Drill, 36" x 18", (3) 15 HP Spindles, Hem WF140 Tandem Saw, 2005 #29344
Ficpep Gemini 324PG CNC Plasma Cutting System, 10' x 40', (1) Oxy, 15 HP Drill, HPR260XD Plasma Bevel Head, 2014 #28489
Peddinghaus FPDB-2500 CNC Heavy Plate Processor, 96" Width, (3) Drill Spindles, HPR260 Plasma, (1) Oxy, Siemens 840, 2008 #27974
Peddinghaus FDB-2500A CNC Plate Drill with Oxy/Plasma Torches, (3) Head Drill, 96" Max. Plate Width, 2003 #29542
Peddinghaus PCD-1100 CNC Beam Drill, 44" x 18" Capacity, 13.5 HP, 900 RPM, (3) Spindles, 3" Max. Diameter, 13" Stroke, 2008 #29286
Peddinghaus Ocean Avenger II 1000/1B CNC Beam Drill, 40" x 40' Max Beam, Siemens 840Di CNC Control, 2006 #29710
Peddinghaus AFCPS 833A Revolution CNC Anglemaster Angle Line, 8" x 8" x 1", Loader, Conveyor, Fagor 8055 CNC, 2011 #29959
Voortman V630/1000 CNC Beam Drill, (3) Drill Heads, Max Length 612", Power Roller Conveyor, 4-Side Layout Marking, 2016 #29726

www.PrestigeEquipment.com | (631) 249-5566
sales@prestigeequipment.com

Search employment ads online at www.modernsteel.com. To advertise, contact M.J. Mrvica Associates, Inc.: 856.768.9360 | mjmrvica@mrvica.com

advertiser index

AISC	8	Lindapter USA	59
Applied Bolting Technology	47	Nucor Tubular Products	11
Bull Moose Industries	back cover	Nucor Vulcraft-Vercor Group – RediCor	13
Canam Buildings and Structures	55	Peddinghaus Corporation	2
Cast Connex Corporation	21	Profile Cutting Systems	45
Chicago Metal Rolled Products	insert	PythonX, A Lincoln Electric Company	67
Controlled Automation	58	QuickFrames USA	14
DuraFuse Frames	12	SDS/2	7
FICEP Corporation	15	SidePlate Systems	39
IES	3	St. Louis Screw & Bolt	35
IMPACT	63	Tnemec Company	45
InfoSight Corporation	35	Trimble	5
JGM Fabricators & Constructors	51	Voortman Corporation	23
Kinetic Cutting Systems	53		

structurally sound



STEELDAY DEEP IN THE (HOT) HEART OF TEXAS

DRIPPING SPRINGS, TEXAS, a few miles southwest of Austin, is known as the “Gateway to the Hill Country.”

It’s also home to Patriot Erectors (an AISC member and certified fabricator and erector), which hosted a Texas-sized crowd of more than 450 people for its SteelDay event on an unseasonably scorching (100 °F!) September 27. Now in its 11th year, SteelDay is AISC’s nationwide celebration of the domestic structural steel industry—and Patriot Erectors has been involved from the very beginning.

“When SteelDay was first introduced, we recognized that the formal declaration could be a great way to showcase the advancements and opportunities in our industry as well as the talents of the American craft worker,” said Patriot’s president and CEO, Parley Dixon. “Our SteelDay beginnings were fairly humble, with a desire and vision to expand the event to celebrate the various partners involved in keeping the steel industry vibrant. The celebration has grown into a significant event, with architects, engineers, contractors, vendors, suppliers, community partners, Patriot employees, a local boys’ home, and high school students attending. We had four different high schools show up this year!”

The four-hour event included a mixer, shop tours, presentations, awards, vendor demonstrations, lunch (Tex-Mex, of course), and—mercifully, given the heat—a shaved ice truck (it wouldn’t be a proper Austin-area event without a food truck of some sort). In addition, several attendees (and employees) were given the opportunity to show off their welding, cutting, and anchoring skills, including cutting a round steel bar with an oxygen torch.

This was just one of dozens of SteelDay events taking place across the country. See next month’s issue for more SteelDay coverage and photos. And for more on SteelDay in general (it’s never too early to start planning an event for 2020!) visit aisc.org/steelday. ■

One Stop, Countless Solutions

PYTHONX[®]
PLATE

PYTHONX[®]
STRUCTURAL

PYTHONX[®]
SPG

TORCHMATE[®]
A Lincoln Electric Company

Vernon Tool[®]
A Lincoln Electric Company

Visit the world of Lincoln Electric Cutting Solutions at FABTECH, Booth A1457

Lincoln Electric has combined the resources and expertise of several leading companies to create a single cutting group to address every possible customer need. From round pipe to 3D processing of structural sections to 2D plate processing, we're the one source and the one partner you'll ever need.

For more information on our revolutionary Cutting Solutions:

Call: 1-833-PYTHONX

Email: info@pythonx.com



©2019 Lincoln Global, Inc. All Rights Reserved.

LINCOLN[®]
ELECTRIC

HOLLOW STRUCTURAL STEEL TUBE FROM BULL MOOSE

**BUILD A
LANDMARK.**



For projects that will stand the test of time, start with Bull Moose HSS tube.

Our direct-form manufacturing process enables us to use the highest grade HSLA steel...and form it directly into a tube.

With sizes ranging from 1.5" square to 18"x6", and wall thicknesses from 1/8" through 5/8", Bull Moose features one of the largest size ranges of HSS products in the industry.

For strength, versatility and reliability, build with Bull Moose.

BULL MOOSE ADVANTAGES

- Strength ranges of 46 KSI to 110 KSI
- Tighter tolerances, sharper edges, and straighter tubes
- Widest variety of custom sizes/lengths, including metric
- In-line NDT weld testing available on all tube
- Readily available weathering grade steel
- Fast delivery with 8 domestic sites



BULL MOOSE
For exceptional strength.

1819 Clarkson Rd.
Chesterfield, MO 63017

800.325.4467 | **BULLMOOSETUBE.COM**