

# Modern Steel Construction

October 2019



# STRONGER THAN STEEL®

HIGH SPEED ROBOTIC STEEL BEAM ASSEMBLY

ACCOMPLISHES WORK OF 5 FITTERS PER SHIFT

MAINTAINS 1/24" ACCURACY OVER 60' PROFILES

FIT AND TACK PIECES AT 1.5 MINUTES PER PART

WATCH  
VIDEOS  
HERE

[www.peddinghaus.com/videos](http://www.peddinghaus.com/videos)

**Peddinghaus**

[www.peddinghaus.com](http://www.peddinghaus.com) | [info@peddinghaus.com](mailto:info@peddinghaus.com) | (815) 937-3800

**PEDDIASSEMBLER**  
STEEL BEAM ASSEMBLER

**WIN A BEAM ROTATOR**  
TEXT KEYWORD 'WINNER' TO 69922

Prizes: PeddiRotator, \$500 gift card, or \$100 gift card. Three (3) winners will be selected per year. Eligibility limited to United States/Canada steel industry.

3 Msgs/Month. Reply STOP to cancel, HELP for help. Msg&data rates may apply.

Terms: <https://www.peddinghaus.com/terms/1>





# The Best in Steel MIS Just Got Better



## The Power of FabSuite Plus a Whole Lot More

The industry's next generation of steel fabrication management software is here. Tekla PowerFab is a software suite that combines the power of FabSuite with other Tekla solutions to deliver next-level performance in estimating accuracy and project collaboration.

Learn more at: [www.TeklaPowerFab.com](http://www.TeklaPowerFab.com)



IS NOW



# Modern Steel Construction

October 2019

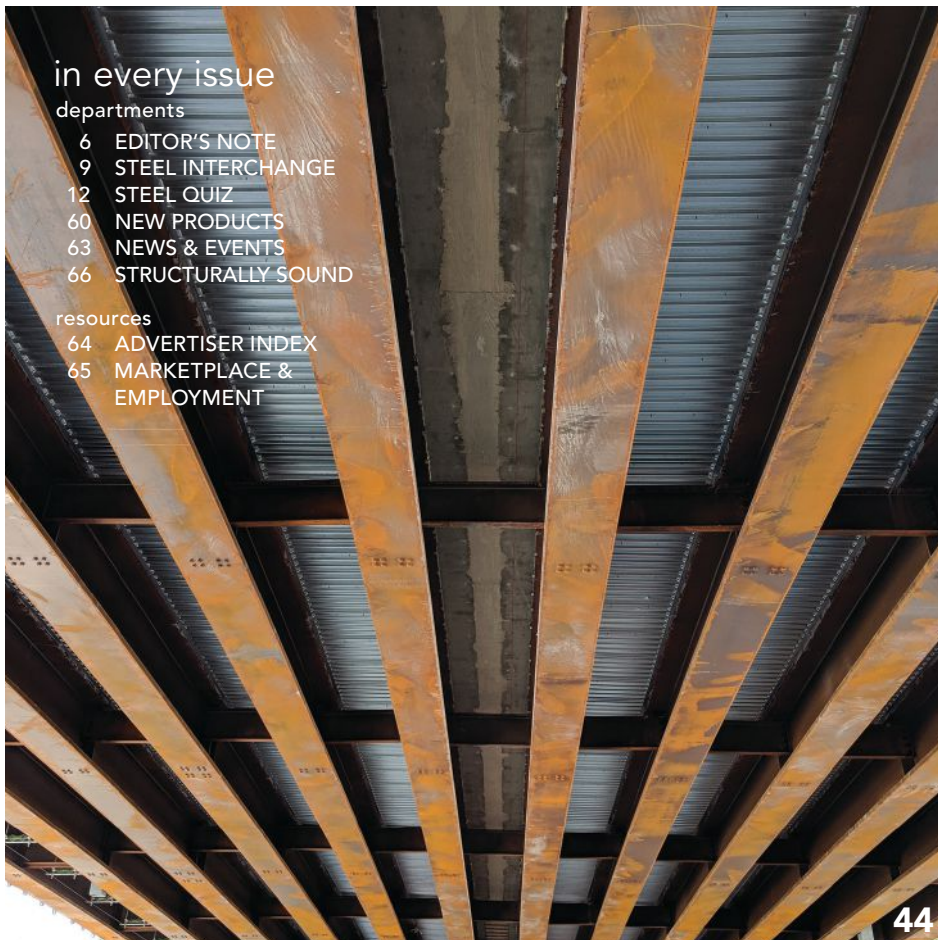

## in every issue

### departments

- 6 EDITOR'S NOTE
- 9 STEEL INTERCHANGE
- 12 STEEL QUIZ
- 60 NEW PRODUCTS
- 63 NEWS & EVENTS
- 66 STRUCTURALLY SOUND

### resources

- 64 ADVERTISER INDEX
- 65 MARKETPLACE & EMPLOYMENT

## features

### 26 A New Leaf

BY CURTIS FENTRESS, FAIA

At one end of a pedestrian bridge in suburban Denver, a towering steel leaf plays the dual roles of artistic beacon and important structural element.

### 32 Lesson Plan

BY NICOLE MCGRATH-PATTI

Steel successfully supports a STEM addition to a suburban Chicago high school.

### 38 Open Channels

BY BRUCE A. BURT, PE

Both waterways and vehicular traffic were kept free of interruption during a major steel bridge replacement over the Missouri River.

### 44 A Bridge Replacement in Four Parts

BY JAKE WILLIAMS, PE, AND CHRIS KELLEY, PE

Steel construction makes quick work of a quartet of neighboring bridge structures requiring replacement or repair in Memphis.

### 50 Wanted: Old Steel Bridges

BY GEOFF WEISENBERGER

A unique facility at Purdue University gives decommissioned steel bridge components a second life as learning tools.

### 56 Bridging Bolivia

BY GEOFF WEISENBERGER

It's a hat trick of pedestrian bridges for NSBA, as the group builds its third Bridges to Prosperity project, this one in the mountains of Bolivia.

## columns

### steelwise

### 16 Bringing Bridges Back from the Brink

BY DAN McCAFFREY, PE

Aging steel bridges can be often be refurbished to extend their service life. Here are some considerations for bridge repair and rehabilitation.

### business issues

### 22 Reinforce Your Desired Culture

BY DAN COUGHLIN

Your ideal company culture doesn't just happen. It has to be planned, discussed, reinforced, and refined.

**ON THE COVER:** A suburban Denver pedestrian bridge doubles as a civic icon, page 26. (Photo: © Jason A. Knowles, courtesy of Fentress Architects)

MODERN STEEL CONSTRUCTION (Volume 59, Number 11) ISSN (print) 0026-8445; ISSN (online) 1945-0737. Published monthly by the American Institute of Steel Construction (AISC), 130 E Randolph Street, Suite 2000, Chicago, IL 60601. Subscriptions: Within the U.S.—single issues \$6.00; 1 year, \$44. Outside the U.S. (Canada and Mexico)—single issues \$9.00; 1 year \$88. Periodicals postage paid at Chicago, IL and at additional mailing offices. Postmaster: Please send address changes to MODERN STEEL CONSTRUCTION, 130 E Randolph Street, Suite 2000, Chicago, IL 60601.

**DISCLAIMER:** AISC does not approve, disapprove, or guarantee the validity or accuracy of any data, claim, or opinion appearing under a byline or obtained or quoted from an acknowledged source. Opinions are those of the writers and AISC is not responsible for any statement made or opinions expressed in MODERN STEEL CONSTRUCTION. All rights reserved. Materials may not be reproduced without written permission, except for noncommercial educational purposes where fewer than 25 photocopies are being reproduced. The AISC and Modern Steel logos are registered trademarks of AISC.



Printed on paper made from a minimum of 10% recycled content.

# FICEP Innovation Helps Our Business Grow



“ *In 2012, ASC underwent an organizational restructuring. In keeping with the new vision there was a need to find a strong partner that we could depend upon to support our projected growth. We quickly realized that FICEP offered a level of technology, versatility and productivity that was not available from other vendors.*

*The level of professional support that we received from FICEP has enabled us to grow our business with multiple FICEP purchases over the past few years.*

*FICEP has proven to be a big part of our growth and success.* ”

*Shyamal Ganguly, President & CEO, ASC Inc.*

---

*FICEP is committed to annually reinvest in new product development to introduce to the industry new innovative technology to enhance your competitive edge. Give us a call to learn more about our commitment to leading edge product development and how it will benefit your firm!*



FICEP Corporation | 2301 Industry Court | Forest Hill, Maryland 21050  
(410) 588-5800 Fax (410) 588-5900

[www.ficepcorp.com](http://www.ficepcorp.com)

## editor's note



Every decade has its share of defining movies. For the 1980s, the list includes such classics as *The Breakfast Club*, *Blade Runner*, and *Back to the Future*.

But for some, the movie of the decade was *Top Gun*. And for those in awe of *Goose* and *Maverick*, the line that defined the movie was "I feel the need—the need for speed!" Fast-forward three decades and this line has been adopted as the rallying cry for the structural steel industry.

On SteelDay, AISC announced a new initiative with a goal of increasing the speed by which structural steel buildings and bridges can be designed and constructed by 50% by the end of 2025. And while it might seem overly ambitious and pie-in-the-sky, I think it's actually too conservative.

In the past few years, we've already seen a number of innovations that have jump-started the speed program. Here are just a few examples:

- Rainier Square Tower is definitely the poster child for the effort. The use of the new SpeedCore system reduced erection time by around 40%—and we've been told additional time save savings should be expected on future SpeedCore projects as the industry gains more experience.
- Qnect is revolutionizing connection design and conservatively reduces the time it takes design engineers and fabricators to collaborate on approved shop and erection drawings by more than 70%.
- A just-completed six-story dorm for the Rhode Island School of Design used a

steel frame combined with a CLT flooring system to reduce the erection time of the entire superstructure to just 2.5 weeks.

- Robotic welding systems are starting to find their way into shops and reduce fabrication time by around 15% (see a video example at [aisc.org/roboticwelding](https://aisc.org/roboticwelding)).
- Accelerated Bridge Construction is rapidly becoming a mainstay in steel bridge design, but we're also seeing incredible new systems, such as the folded plate girder system, that allows the installation process to be measured in days not weeks.
- Girder-Slab and other systems that use asymmetric steel members are touted for their ability to reduce the floor-to-floor height of buildings, but another benefit is incredibly rapid construction.
- Other systems, such as CastConnex, ConXtech, SidePlate, C-Beams, Deltabeam, Comslab, Ecospan, Versa-Floor, Integrity Wall, Pueblo Building System, Re-Fuse Braced Frames, Black Rock Fireproof Columns, RediCor, and Z-Modular, all provide substantial benefits and are highlighted in a new free guide from AISC at [aisc.org/innovations](https://aisc.org/innovations).

What new systems have you used? What areas of design and construction do you think are ripe for a speed boost? Let me know and I'll share it with AISC's Speed Team!

  
Scott Melnick  
Editor

# Modern Steel Construction

## Editorial Offices

130 E Randolph St, Ste 2000  
Chicago, IL 60601  
312.670.2400

## Editorial Contacts

EDITOR AND PUBLISHER

Scott Melnick  
312.670.8314  
[melnick@aisc.org](mailto:melnick@aisc.org)

SENIOR EDITOR

Geoff Weisenberger  
312.670.8316  
[weisenberger@aisc.org](mailto:weisenberger@aisc.org)

DIRECTOR OF PUBLICATIONS

Keith A. Grubb, SE, PE  
312.670.8318  
[grubb@aisc.org](mailto:grubb@aisc.org)

PRODUCTION COORDINATOR

Erika Salisbury  
312.670.5427  
[salisbury@aisc.org](mailto:salisbury@aisc.org)

GRAPHIC DESIGN MANAGER

Kristin Hall  
312.670.8313  
[hall@aisc.org](mailto:hall@aisc.org)

## AISC Officers

CHAIR

David Zalesne,  
Owen Steel Company, Inc.

VICE CHAIR

Jack Klump, Cianbro Fabrication  
& Coating Corporation

SECRETARY/LEGAL COUNSEL

Edward Seglias, Cohen Seglias  
Pallas Greenhall & Furman, PC

PRESIDENT

Charles J. Carter, SE, PE, PhD

SENIOR VICE PRESIDENT

Scott Melnick

VICE PRESIDENT

Lawrence F. Kruth, PE

VICE PRESIDENT

Tabitha S. Stine, SE, PE

VICE PRESIDENT

Mark W. Trimble, PE

## Editorial Advisory Panel

Caroline R. Bennett, PE, PhD,  
University of Kansas

Amanda Dean, PE,

Huitt-Zollars, Inc.

Bryan Frazier,

Zalk Josephs Fabricators, LLC

Keith R. Griesing, PE,

Hardesty and Hanover

Steve Knitter,

Geiger and Peters

## Advertising Sales

M.J. Mrvica Associates, Inc.

2 W Taunton Avenue

Berlin, NJ 08009

856.768.9360

[mjmrvica@mrvica.com](mailto:mjmrvica@mrvica.com)

## Address Changes and Subscription Concerns

312.670.2401

[subscriptions@aisc.org](mailto:subscriptions@aisc.org)

## Reprints

Erika Salisbury

312.670.5427

[salisbury@aisc.org](mailto:salisbury@aisc.org)

# INTELLIGENT AUTOMATION EQUALS PRODUCTIVITY

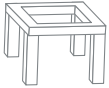

## Recognizes and Automatically **ADAPTS TO FRAMING CONDITIONS**

SDS/2 takes a uniquely intelligent approach to its connection design by considering framing conditions and erectability.

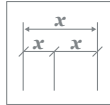

## Reduces Detailing Time **WITH CUSTOM TEMPLATES**

SDS/2 allows detailing drawings to be customized to your detailing and fabrication standards, reducing time spent on cleanup.



## Creates Multi-User Environment **TO STREAMLINE WORKFLOW**

With SDS/2, everyone works in the live model simultaneously; there's no need to check the model in or out.

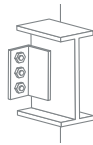

## Conducts Code-Based **JOINT ANALYSIS**

Only SDS/2 automatically performs clash detection and prevention as part of its connection design, which leads to savings in the shop.



## Integrates to the **SHOP, FIELD AND OFFICE**

SDS/2's intelligence allows for seamless transfer of information from start to finish.



## **ENSURES FIT-UP** in Field

With SDS/2, if it fits in the model, it fits in the field.

See how SDS/2 can increase your bottom line at  
[SDS2.COM/PRODUCTIVITY](https://www.sds2.com/productivity)



www.sds2.com  
800-443-0782 // 402-441-4045 (fax)  
1501 Old Cheney Rd., Lincoln, NE 68512



# EVERY **DETAIL** MATTERS



## Why choose High Steel for your next project?

- A reputation built on nine decades of service
- Cost-saving design suggestions to meet budget goals
- Plate girders and complex weldments to help vision become reality
- Transportation solutions that provide delivery directly to job sites

At High Steel Structures, we know that every detail matters. From project inception to completion, you can count on High Steel to be attentive to project needs, budget, scope and timelines. Whether you need one girder to complete your job or 100 girders to complete your bid, call us for competitive pricing, quality fabrication and a commitment to detail that ensures the job is done right the first time.

  
**HIGH**  
**STEEL**  
**STRUCTURES** LLC  
*An Affiliate of High Industries Inc.*



Lancaster, PA | 1-800-468-9570 [HighSteel.com/details](https://HighSteel.com/details)



If you've ever asked yourself "Why?" about something related to structural steel design or construction,

*Modern Steel's* monthly Steel Interchange is for you!

Send your questions or comments to [solutions@aisc.org](mailto:solutions@aisc.org).

# steel interchange

All referenced AISC publications, unless noted otherwise, refer to the current version and are available at [aisc.org/specifications](http://aisc.org/specifications). Modern Steel articles can be found in the Archives section at [www.modernsteel.com](http://www.modernsteel.com), and AISC Design Guides are available at [aisc.org/dg](http://aisc.org/dg).

## Rules of Thumb

I remember when designing structures before computers, more experienced engineers would recommend limiting the depth-to-span ratio for beam design. With the software available to today's designers, where deflections of individual beams can more easily/quickly be evaluated, do rules of thumb such as the depth-to-span ratio still serve a purpose?

Many structural engineers I know still employ rules of thumb, so in my opinion, they can still be useful. (And concerning depth-to-span ratio, a good rule of thumb for beams is 1:24.)

Rules of thumb develop because someone notices some relationship between a set of variables that appears to be useful. Often the variables are related to some underlying mechanistic model but not in a way that is clear or immediately useful. In some instances, rules of thumb are used to address problems that are difficult to define or involve a large number of variables or competing goals.

If you choose to employ rules of thumb, then you will have to evaluate each one's effectiveness relative to your practice. The February 2000 article "Rules of Thumb for Steel Design" provides good information on depth-to-span ratio and other items, bearing in mind that you might need to make adjustments to better suit your needs.

Larry Muir, PE

## Upset Rods

Note [d] in Table J3.2 of the 2005 AISC Specification for Structural Steel Buildings (ANSI/AISC 360) states: "The nominal tensile strength of the threaded portion of an upset rod, based upon the cross-sectional area at its major thread diameter,  $A_D$ , which shall be larger than the nominal body area of the rod before upsetting times  $F_y$ ."

1. Is the major thread diameter, the same as the nominal diameter of the rod?
2. Why was this footnote removed in subsequent versions of the Specification?

1. No, the major thread diameter is not the same as the nominal diameter of the rod. Upset rods are rods in which the ends have been compressed such that the effective area at the threads is increased (see Figure 1). As you can see from the figure provided, the major thread diameter will be greater than the nominal diameter of an upset rod. This means that  $A_D$  will be greater than  $A_b$  as well. However, keep in mind that the nominal tensile stress values

in Table J3.2 were obtained from the equation  $F_{nt} = 0.75F_u$ . The factor of 0.75 included in this equation accounts for the approximate ratio of the effective area of the threaded portion of the bolt to the area of the shank of the bolt for common sizes.

2. The footnote was removed from the Specification because upset rods are no longer commonly used in the structural steel industry.

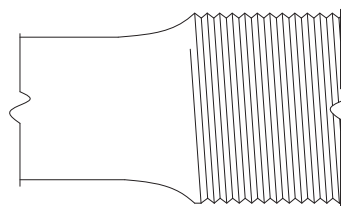

Fig. 1.

Jonathan Tavarez, PE

## AWS Comparator Sample 1

The AWS surface roughness guide for oxygen cutting (see Figure 2) has 4 samples on it. I have seen references to AWS C4.1 Samples 2 through 4 in user notes provided in the AISC Specification and also in AISC's Prequalified Connections for Special and Intermediate Steel Moment Frames for Seismic Applications (ANSI/AISC 358) but not Sample 1. When is Sample 1 typically used?



Fig. 2.

Sample 1 of the comparator is not commonly utilized in the structural steel industry. While there may be other instances of its use, the one standard I could find that refers to Sample 1 is the Specification for the Welding of Hydraulic Cylinders (AWS D14.9/D14.9M:2013), which refers to it in Section 8.4.3.

Carlo Lini, PE



**Jonathan Tavarez** ([tavarez@aisc.org](mailto:tavarez@aisc.org)) is a staff engineer with AISC's Steel Solutions Center. **Brad Davis** of Davis Structural Engineering, LLC, **Bo Dowswell**, principal with ARC International, LLC, and **Larry Muir** are all consultants to AISC.



Steel Interchange is a forum to exchange useful and practical professional ideas and information on all phases of steel building and bridge construction. Contact Steel Interchange with questions or responses via AISC's Steel Solutions Center: 866.ASK.AISC | [solutions@aisc.org](mailto:solutions@aisc.org)

The complete collection of Steel Interchange questions and answers is available online at [www.modernsteel.com](http://www.modernsteel.com).

The opinions expressed in Steel Interchange do not necessarily represent an official position of the American Institute of Steel Construction and have not been reviewed. It is recognized that the design of structures is within the scope and expertise of a competent licensed structural engineer, architect or other licensed professional for the application of principles to a particular structure.

## Section Property Changes

I am looking at the section properties for C4×4.5 and noticed that there is a difference in some section property values ( $r_{ts}$ ,  $S_x$ ,  $I_x$ ,  $C_w$  ...etc.) from 13th to the 15th Edition AISC *Manual*. What was the basis for these changes?

While I was unable to track down the specific documentation tied to these updates, I suspect that the updates were a result of two separate modifications. Note that ASTM A6 provides certain cross-sectional properties for shapes that our manual tables copy from directly. ASTM A6-05a lists a flange width of 1.58 in.. The ASTM A6 standard more recently revised the flange width from 1.58 in. to 1.50 in. This change likely accounts for the slight variation in the calculated section property values between what was listed in the 13th Edition and what is currently listed in the 15th Edition.

*Jonathan Tavarez, PE*

## Headed Stud Anchors

I noticed that steel headed stud anchors have been removed from Table 2-6 in the 15th edition AISC *Manual* and the reference to ASTM A108 has been removed from the material discussion in Part 2. We typically reference ASTM A108 on our drawings when specifying steel headed stud anchors. Should we be referencing a different ASTM standard?

Headed stud anchors are sort of an odd case. For various reasons the headed stud anchor manufacturers developed a path into the codes through AWS rather than through ASTM. The April 2018 *Modern Steel Construction* article "Are You Properly Specifying Materials" states: "Shear studs are specified as given in AWS D1.1 Clause 7, with material as required in Clause 7.2.6. Type B is usual and the corresponding mechanical requirements are stated in AWS D1.1 Table 7.1 ( $F_y = 51$  ksi,  $F_u = 65$  ksi)."

Though various documents (including the *Manual*) have attempted to use various ASTM standards to define/specify headed stud anchors, a reference to AWS D1.1 Clause 7 is likely the most complete means—as odd as this may seem.

*Larry Muir, PE*

## Moment Connected Channel Shapes

Is it possible to use a bolted flange plate moment connection to splice two channel shapes together? I have never seen it done before.

Yes, it is possible. I would approach the design in a manner similar to that shown in AISC Design Example II.B-1 ([aisc.org/manualresources](http://aisc.org/manualresources)). That example is for a beam-to-column connection, but many of the same limit states apply. Of course, you would only have one row of bolts instead of two shown in the example.

*Brad Davis, SE, PhD*

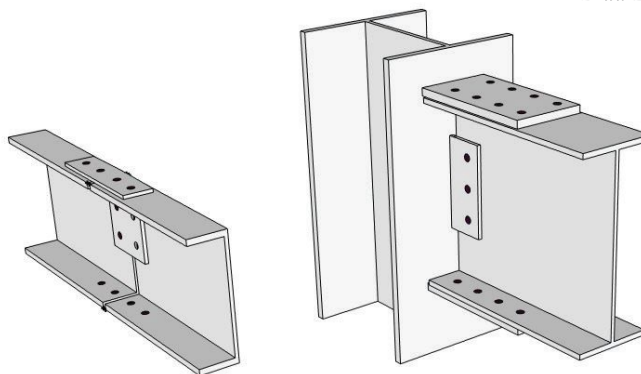

Channel splice (left) and Design Example II.B-1 (right).

“ IES tools keep me  
focused on design ”



# Structural Software

Easy. Versatile. Productive.

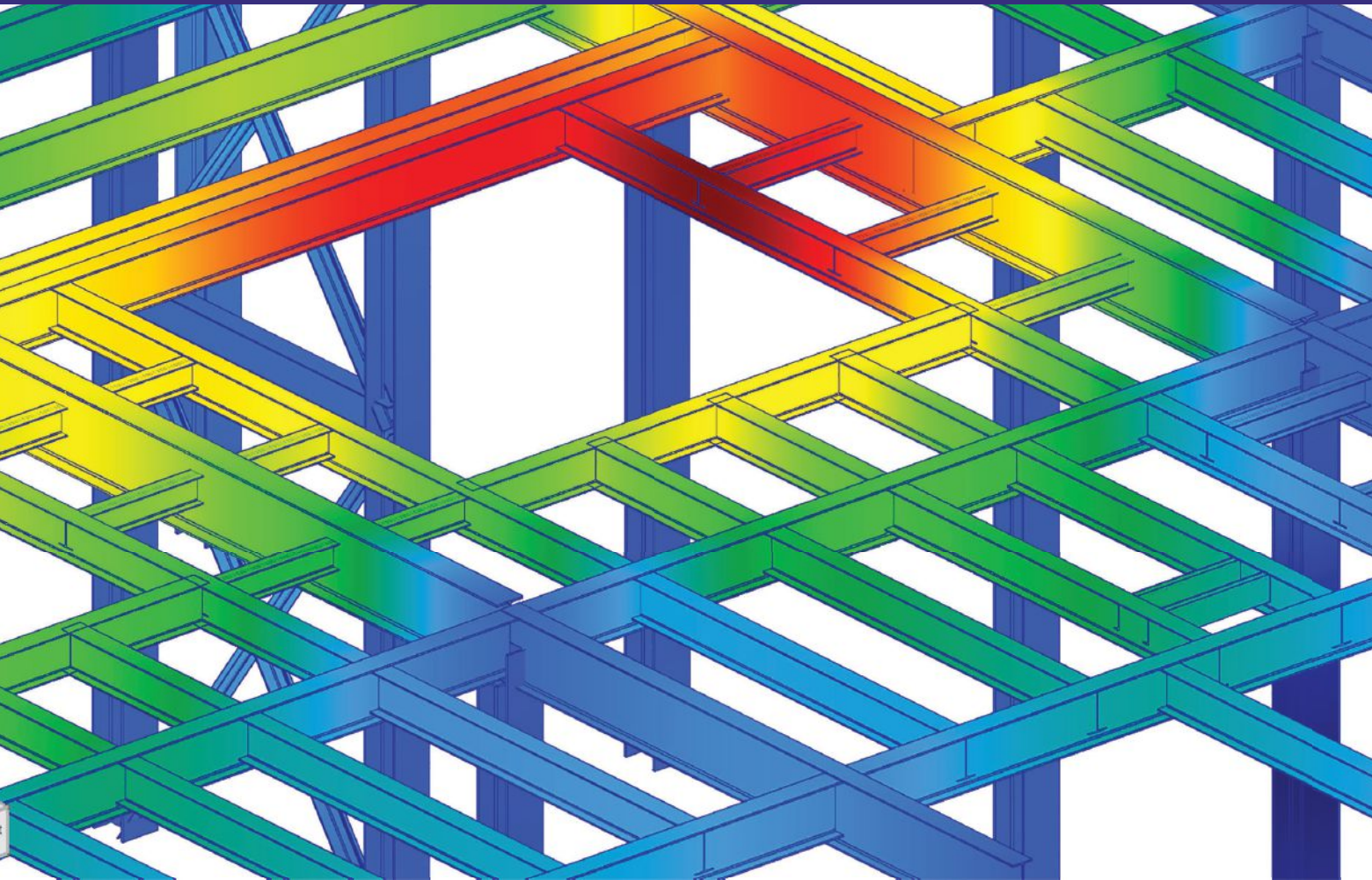

Download your free trial today:

[iesweb.com](http://iesweb.com)

800.707.0816



# steel quiz

This month's quiz is all about bridges.

The answers can be found in AASHTO/NSBA Highway Administration Technical Advisory ([www.fhwa.dot.gov](http://www.fhwa.dot.gov)).

The answers can be found in AASHTO/NSBA Collaboration G12.1: Guidelines to Design for Constructability ([aisc.org/nsba/constructability](http://aisc.org/nsba/constructability)), S2.1: Steel Bridge Fabrication Guide Specification ([aisc.org/nsba/fabrication](http://aisc.org/nsba/fabrication)), AASHTO LRFD Bridge Design Specification, AASHTO Bridge Construction Specification ([store.transportation.org](http://store.transportation.org)), AWS D1.5: Bridge Welding Code ([www.aws.org](http://www.aws.org)), and a Federal

**1 True or False:** If a plate girder is designed with a 120-in. web depth, you should order plate that is exactly 120 in. wide.

- 2** When major-axis moment gradient within a field section indicates that a change in flange area is economical, how should you make the change?
- Change the flange width, keeping the thickness constant
  - Change the flange thickness, keeping the width constant
  - Change both the width and thickness
- 3** When transitioning the thickness of a flange within a field section, a good rule of thumb is for the thinner plate to have a thickness no less than \_\_\_\_\_ the thickness of thicker plate it adjoins?
- One-quarter
  - One-half
  - Three-quarters
- 4** For horizontally curved I-girders, it can be more practical to fabricate the main member straight and then curve them using heat (i.e., "heat curving") rather than building them curved. Which of the following properties can affect whether a girder can be heat curved?
- Horizontal radius of curvature of the girder
  - Flange width
  - Flange thickness
  - Web thickness
  - Web depth
  - Yield strength of material
  - All of the above
- 5 True or False:** For skewed and horizontally curved I-girder bridges, the engineer of record is responsible for clearly stating the intended erected position of the girders and the condition under which that position is to be theoretically achieved.
- 6** Consider a 230-ft-long simple-span steel I-girder bridge with a skew angle of 35° and a width of 103 ft. Using the NSBA *Skewed and Curved Steel I-Girder Bridge Fit* summary document (available at [aisc.org/nsba/skewed-curved](http://aisc.org/nsba/skewed-curved)) what is the recommended fit condition?

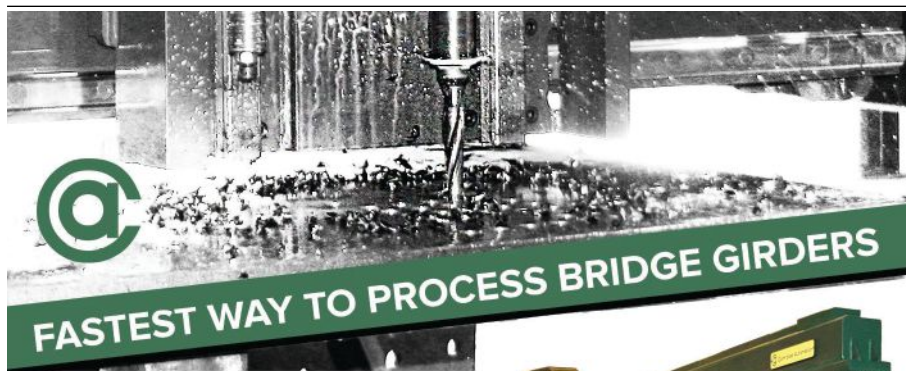

## GIRDER DRILL

- > No Pre-Drilling required
- > Simultaneous drilling of girder and splices
- > Laser guided



**Controlled Automation**

501-557-5109  
[www.controlledautomation.com](http://www.controlledautomation.com)

.....  
 TURN TO PAGE 14 FOR THE ANSWERS



# Are You Redi?

## REDICOR SIMPLIFIES AND ACCELERATES THE CONSTRUCTION OF REINFORCED CONCRETE CORES.

Conventional cast-in-place, pre-cast and masonry methods of constructing reinforced concrete shear cores often require long and



Pre-engineered load-bearing structural connections enable framing to begin immediately.

expensive schedules before structural framing can begin.

Now there's a better way.

**RediCor** is a pre-fabricated, ready-to-set modular steel form system that simplifies and accelerates concrete core construction. Our load-bearing modules are ready to set once on-site, and structural framing can be installed simultaneously – saving time, energy and money. Are you Redi?

VISIT US AT [REDICOR.COM](http://REDICOR.COM) FOR THE REDICOR STORY.

**NUCOR**  
VULCRAFT/VERCO

Powerful Partnerships.  
Powerful Results.

**REDICOR**<sup>TM</sup>  
Modular Steel Form System  
BY VULCRAFT

# steel quiz ANSWERS

1 **False.** Structural plate will often have irregular edges when it is produced, and fabricators will trim and square the edges of the plate, thus reducing the overall length and width of the plate. So what was a 120-in.-wide plate is now less than that, which means that in this case, a fabricator would have to order a wider plate (e.g., 123 in. or wider). However, this is a simplified scenario and most bridge girders will have some degree of camber cut into the web plate, further increasing the need for a wider plate. Engineers should be conscious of how chosen sizes compare to the length and width boundaries of available steel plate, as a difference of an inch may force a fabricator to the next larger available plate size. (For more on plate availability, see the September 2011 SteelWise article “Steel Plate Availability for Highway Bridges” at [www.modernsteel.com](http://www.modernsteel.com).)

2 **b.** According to the AASHTO/NSBA Collaboration G12.1, changing the flange thickness while leaving the width constant allows the fabricator to fabricate several flanges by slabbing plates, which involves connecting two or more wide plates together with a CJP weld. Individual flanges are then stripped from this plate and then welded to the web. This process greatly reduces the number of welds required, and the figures below demonstrate the general process. Flange widths should only be changed at the field splices.

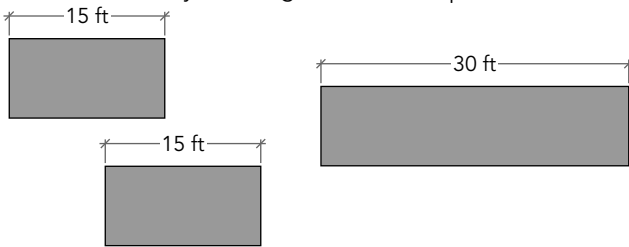

Fig. 1. Individual slabs of two 96-in. × 1-in. and one 96-in. × 2-in. plate.

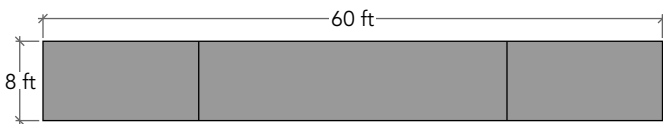

Fig. 2. Plates are butted together, and two CJP welds are made connecting all three plates into a single 8-ft × 60-ft plate.

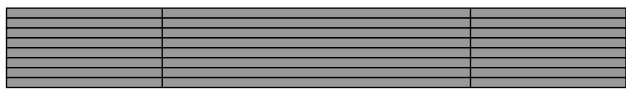

Fig. 3. The 8-ft × 60-ft plate is then stripped into eight separate 12-in.-wide plates.

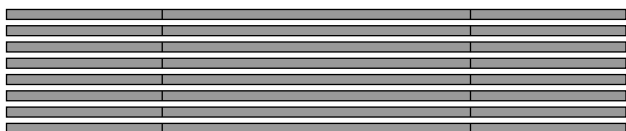

Fig. 4. Each stripped plate will be an individual flange that is welded to a web plate.

3 **b.** According to the AASHTO/NSBA Collaboration G12.1, at welded flange splices within a field section, the thinner plate should not be less than one-half the thickness of the thicker plate. Also, during preliminary design, the engineer should consider grouping flange thicknesses to minimize the number of thicknesses of plate that must be ordered. By minimizing the number of flange plate thicknesses, you can reduce mill quantity extras and simplify fabrication and inspection operations.

4 **g.** According to the AASHTO/NSBA Collaboration S2.1, for some fabricators heat curving is the preferred method of fabricating horizontally curved steel I-girder bridges. This method reduces material waste and makes the girders easier to handle in the fabrication shop. The 8th Edition AASHTO LRFD *Bridge Design Specifications* Article 6.7.7.2 requires the engineer to indicate where heat-curving is permitted, based on the equations in Article 11.4.12.2.2 of the AASHTO LRFD *Bridge Construction Specifications*.

5 **True.** The 8th Edition AASHTO LRFD *Bridge Design Specification* states, in Article 6.7.2:

“The contract documents should state the fit condition for which the cross-frames or diaphragms are to be detailed for the following I-girder bridges:

- Straight bridges where one or more support lines are skewed more than 20° from normal;
- Horizontally-curved bridges where one or more support lines are skewed more than 20° from normal...”

This ensures that the preferences of the owner and engineer of record regarding the fit condition are clearly conveyed to those involved in the fabrication and construction of the bridge. Early communication between all parties can help to ensure that a reasonable and proper “fit decision” is made for a particular bridge project. Refer to the NSBA *Skewed and Curved Steel I-Girder Bridge Fit* document for more information regarding fit.

6 **b.** In this scenario, the skew index is calculated using equation (1):

$$I_s = (w_g \times \tan\theta) / L = (103 \times \tan(35^\circ)) / 230 = 0.31$$

So the recommended fit condition is steel dead load fit (SDLF) per Table 2. For most skewed and/or curved girders, detailing and fabricating cross frames to fit under steel dead load is recommended.



Everyone is welcome to submit questions and answers for the Steel Quiz. If you are interested in submitting one question or an entire quiz, contact AISC’s Steel Solutions Center at 866.ASK.AISC or [solutions@aisc.org](mailto:solutions@aisc.org).

# Leading Technology Solutions

## Customer Portal

- Access to Real-time Information
- Manage Mill Test Reports
- Open Orders, Purchases and Shipments
- Download LEED Documentation

## Electronic RFQ and Purchasing

- SteelXML Compliant
- Multiple MRP software platforms supported.
- Send us your electronic lists for the fastest response in the business!

# CUSTOMER SATISFACTION BUILT WITH STEEL

**INFRA-METALS**

[www.Infra-Metals.com](http://www.Infra-Metals.com)



**DELTA STEEL, INC.**

[www.DeltaSteel.com](http://www.DeltaSteel.com)



Full Member



## With many locations to serve you:

<b>A</b>	Wallingford, CT	800-243-4410
<b>B</b>	Langhorne, PA	800-899-3432
<b>C</b>	Baltimore, MD	800-235-3979
<b>D</b>	Petersburg, VA	800-435-0850
<b>E</b>	Atlanta, GA	800-833-9175
INFRA-METALS / IMS		
<b>F</b>	Tampa, FL	800-693-1361
<b>G</b>	Hallandale, FL	800-432-1146
<b>H</b>	Marseilles, IL	800-987-5283
<b>I</b>	New Boston, OH	877-741-8806
<b>J</b>	Houston, TX	800-324-0220
<b>K</b>	San Antonio, TX	800-292-5828
<b>L</b>	Fort Worth, TX	800-772-2762
<b>M</b>	Cedar Hill, TX	800-284-7321
<b>N</b>	Chicago Heights, IL	800-772-2762

# steelwise BRINGING BRIDGES BACK FROM THE BRINK

BY DAN McCAFFREY, PE



Dan McCaffrey ([demccaffrey@modjeski.com](mailto:demccaffrey@modjeski.com)) is a structural project manager with Modjeski and Masters.

Aging steel bridges can be often be refurbished to extend their service life.

Here are some considerations for bridge repair and rehabilitation.

**AMERICA'S BRIDGE INFRASTRUCTURE IS VAST.** And much of it is past its prime.

Of the roughly 600,000 bridges in the U.S., approximately 40% are over 50 years old. And while there's much talk by politicians about the need to inject more money and effort into building new bridges and replacing old ones, the approach has been piecemeal to date and the sheer volume of work required is overwhelming.

Luckily, in many cases, full replacement isn't necessary and steel bridges can see their lives extended through rehabilitation of certain areas or components. Here, I'll present some considerations and advice on rehabilitating steel bridges to bring them back to full strength and keep them that way for as long as possible.

## Cast or Band-Aid?

Rehabilitation becomes necessary when even our best efforts of maintenance and preservation are not enough to win the battle against nature, or it may become required simply due to increased weight and traffic volume over time. When considering rehabilitation, the first question to ask is if this will be a long-term rehab or a temporary solution until replacement is possible. Knowing what your expectations are for a bridge will keep you from taking unnecessary steps and incurring additional expenses or minimizing the risk of having to implement a series of Band-aid solutions. This requires an evaluation of not just the bridge in question, but also the remainder of the system using the bridge. If a replacement is inevitable for other reasons in 15 to 20 years, then the scope for the rehab project should be adjusted accordingly. Similarly, if the desired timeline for additional bridge life is 40 to 50 years or even beyond (100?) do the best with what is known, but keep in mind that technology and material science will be advancing during the upcoming decades.

Rehabilitations often arise due to low load ratings, but sometimes there are also deterioration issues that don't show up in a rating because they are not in the direct load-carrying path. This shouldn't minimize the need to address these items, and it's often best to take care of these serviceability-related issues before they lead to a strength-related problem, and to include them in the rehab scope of work.

## Eliminating Deck Joints

One of the most successful changes in the design of new bridges is the elimination or reduction of deck joints. Many older bridges were built as a series of simple spans, often with deck joints at each pier. While some of these older bridges are now being replaced, others don't warrant that type of investment. Instead, they are being re-decked and rehabilitated, and as part of these projects, some owners have incorporated the concept of eliminating deck joints. Although there are several ways of accommodating the elimination of a joint, one way is through the use of link slabs. A link slab causes the deck to be continuous, while allowing the steel superstructure to continue to act as a simple span.



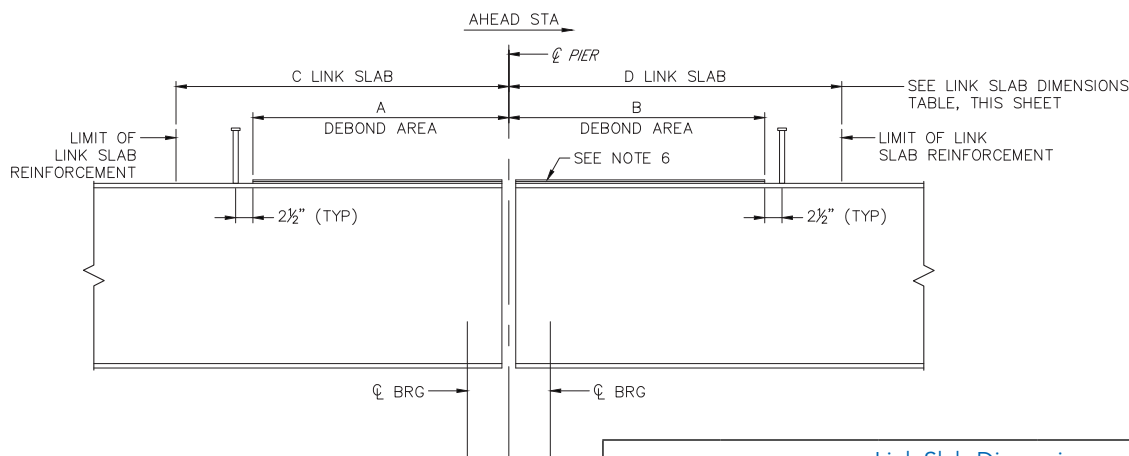

A typical link slab detail and link slab dimensions for the 15th Street Bridge in Philadelphia, which underwent re-decking. The rehabilitation project involved replacing the deck with a new composite concrete deck, replacing the bearings, and making repairs to the abutments and piers.

Link Slab Dimensions				
Location	Dimension A	Dimension B	Dimension C	Dimension D
Pier 1	1ft 11½in.	3ft 6½in.	5ft ½in.	6ft 7½in.
Pier 2	3ft 5in.	3ft 5in.	6ft 0in.	6ft 0in.
Pier 3S	3ft 6½in.	10½in.	6ft 7½in.	3ft 11½in.
Pier 3N	10in.	2ft 2in.	3ft 11in.	5ft 3in.
Bent 4	2ft 0in.	1ft 4½in.	5ft 1in.	4ft 5½in.

A bridge with a link slab is different than one using continuous girders. Essentially, the moment in the girder still drops down to zero at the support, because the adjacent spans are still allowed to rotate relative to one another. This is accomplished by ensuring that at least one of the bearing lines at each pier is not fixed in the longitudinal direction. Even though the positions of the top flanges of the girders are locked, as long as the bottom flanges can move relative to one another, a force couple cannot be developed. In other words, instead of the hinging location being at the bearings and having a deck joint that opens and closes, the hinge point is now the deck, and the space between the bottom flanges opens and closes. This hinging action of the deck of course puts moment in the deck, and additional steel reinforcement is necessary. However, this is a deformation-induced stress, not a load-induced deformation, and even if small cracks do develop, they won't affect the load-carrying characteristics of the bridge.

At Modjeski and Masters, we've employed link slabs in several recent rehabilitation projects, one of which was the re-decking of the 15th Street Bridge over Callowhill Cut in Philadelphia. This steel bridge included six simple spans with a non-composite concrete deck and four total deck joints (three of the piers had a deck construction joint, not a real movement joint). This project involved replacing the deck with a new composite concrete deck, replacing the bearings, and making repairs to the abutments and piers. Link slabs were used at all pier locations and the final configuration only had two deck joints, one at each abutment. As is typical for this type of project, the joints at the abutments needed to be larger to accommodate the increased thermal movement that was shifted here from the joints at the piers. During the bearing replacement design, some fixity configurations were rearranged to ensure that no pier had two lines of fixed bearings. Also, the new shear studs were omitted over the last several feet of the beam, and

a bond breaker was added on top of the flange to enable the deck and beams to act more independently. An additional benefit of the fully connected bridge is that it is expected to act more favorably during a seismic event. (For more on eliminating joints and incorporating link slabs, see "Piece by Piece" in the September 2014 issue, available at [www.modernsteel.com](http://www.modernsteel.com).)

### Coating Considerations

Once the rehab scope of work is determined, planning how best to perform the work is the next step. This usually depends on a lot of factors that aren't strength related, but professional engineers need to be well versed in all aspects of the project, not just what is necessary from a load-carrying standpoint. Some of those factors are environmental, safety, impact to the travelling public, or schedule. Nearly always, decreasing the duration of a project or task is beneficial for all the above factors, and "get in and get out" is the new rehab theme. For a steel bridge rehabilitation project, where a procedure requires existing steel to be uncovered and prime painted prior to new material being added, choosing the right faying surface primer can make all the difference.

Many owners have approved product lists that include coating systems, some of which have required cure times of over 150 hours to develop the Class B slip coefficient. By specifying a typical coating without considering schedule impacts, or worse, not providing any information, the project schedule can be extended, while the contractor literally waits for paint to dry. Alternatively, many paint manufacturers have compatible primers with much shorter cure times. The catch is that these primers sometimes have additional restrictions on application conditions, such as temperature and/or surface preparation. However, depending on the project, it may be worthwhile to accommodate these additional conditions to expedite construction.



M&M  
A primer with a cure time of 19 hours was used on a steel railing replacement project on the Ambassador Bridge between Detroit and Windsor, Canada.

---

Ideally, the potential advantage of an alternate primer would be identified during the plans, specifications, and estimate (PS&E) development phase, discussed with the owner, and incorporated into the special provisions. Many owners have already taken the step of including alternate primers in their approved product listing, and it is just a matter of specifying the alternate. Consulting the coating manufacturer for specific recommendations is also a good practice.

For example, when it came to select steel repairs that were part of a recent railing replacement project on the Ambassador Bridge in Detroit, we applied a Carbozinc 11 HS primer (with a cure time of 19 hours) in lieu of the project's typical Carbozinc 859 (100-hour cure time) because the contractor had to first remove concrete deck, blast clean existing steel, and fasten new strengthening material prior to forming and placing new concrete. Going with the alternate primer enabled the contractor to maintain a linear progression of repair steps, remain in the same general area of work until complete, and not hold up subsequent rehabilitation work. For a different repair to wind bracing elements, we specified the Carbozinc 11 WB primer, which only requires a 4-hour cure time before bolt-up but can only be applied in warmer temperatures. This enabled the repair at each location to be performed in one work shift, which was important due to wind restrictions during disassembly, and the unreliability of wind forecasting beyond the present day. (For more on

corrosion resistance, visit [aisc.org/nsba/nsba-publications](https://aisc.org/nsba/nsba-publications) and peruse the "Corrosion Protection of Steel Bridges" portion of the *Steel Bridge Design Handbook*.)

### Verifying Loads

Although engineering may appear to be an exact science to the public, those in the industry know that it involves a lot of probability considerations, conservatism, and judgement. Like the load and resistance factor design (LRFD) method, we manage risks based on the likelihood of the existence and magnitude of loads, combined with potential variations in material properties and geometry.

Oftentimes, rehabilitation projects are born out of a structure's rating that indicates a less-than-desirable factor of safety. If the engineer suspects that over-conservatism is leading to a ballooning of the scope of work, it may make sense to perform field testing to verify actual structural responses under known live loading conditions. There are usually more load paths than accounted for in design, and actual stresses are often lower or more evenly distributed. This is one reason why there can be bridges with a calculated rating of zero that show no signs of distress. Strain gauges, used with controlled loads, can be used to determine actual stresses and force distributions and to refine the analyses used in the ratings. Bottom line, better information will lead to better rehabilitation decisions.

Similarly, existing dead loads can be different than expected, as can be seen on projects that include lifting the existing structure. In our experience, the actual lifting load is often up to 120% of the weight that would be conventionally calculated, so we take this into account when sizing jacks and temporary supports. Other times, depending on the structure type (especially if the structure is statically indeterminate or cable supported) the actual required jacking load can be lower than anticipated. If temporary supports are a significant portion of the construction effort, it may make sense to verify the anticipated jacking load using a test lift as a way to reduce the design requirements for those temporary supports.

On the rocker link replacement project at the Ambassador Bridge, we recommended the use of a test lift to verify the dead load present at each of the four corners. On this cable-supported bridge, geometry and suspender rope tensions play a big part in the link reactions. The conceptual temporary support was to be cantilevered from the tower to avoid interference with the actual work. However, for the test lift, a relatively small jacking assembly was easily placed in line with the existing link. The resulting dead loads were then combined with the calculated live load, wind and temperature effects. In the end, the temporary link and supports were designed and detailed for a maximum load of 500 kips, significantly less than the 1,020 kips that the permanent links were designed for. Considering that the temporary link was supported on a bracket that was cantilevered from the tower, this reduction in design load had a significant impact on the size, complexity, time to construct, and cost of the temporary support—and no temporary strengthening of the tower was required.

### Pulling Ideas from Elsewhere

One thing to remember when attempting to solve complex rehabilitation problems is that you are not alone. If you seem to be stuck finding a solution, look outside your sandbox. It may be as simple as looking to what was done on other bridge types or even looking to other industries for material, detail and process ideas.

A recent example is the anchor link replacement project we conducted for the Blue Water Bridge in Port Huron, Mich. One of the biggest challenges was that the original tension link was entirely inside of the box tower leg, with the end of the truss penetrating the leg to produce a nearly vertical link, severely limiting access. Replacing the existing link with a new link in the same position required a temporary support that was located outside of the tower and out of the way of the work. Trusses should only be loaded at their panel points, not within members, and fortunately a portion of the end gusset plate extended outside of the tower, which could

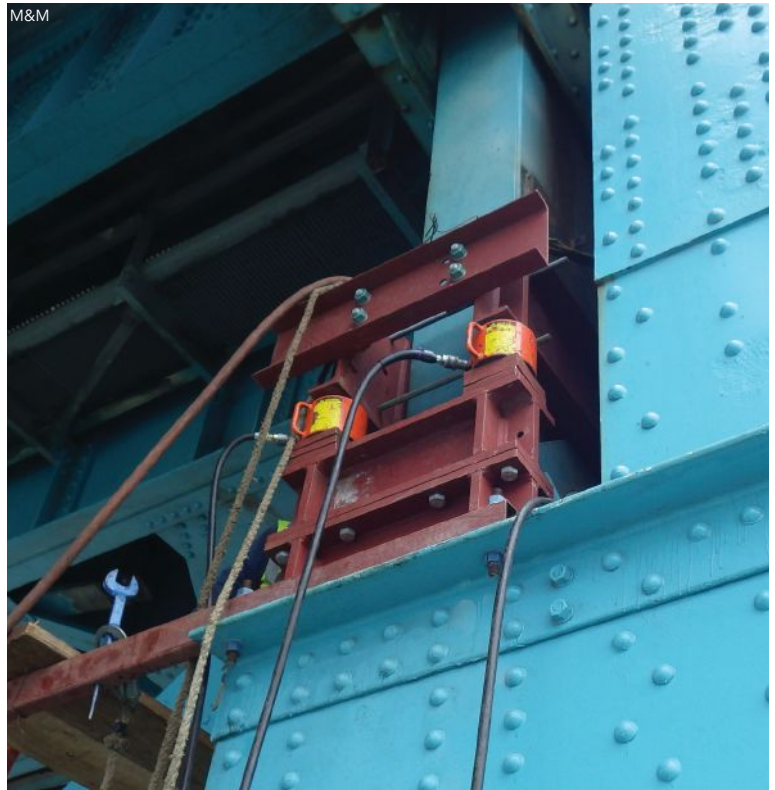

above and below: The rocker link replacement for the Ambassador Bridge. A test lift was used to verify the dead load present at each of the four corners.





OHM Consultants

above and right: The Blue Water Bridge in Port Huron, Mich., underwent an anchor link replacement, where the fasteners were replaced with new bolts with extra-long threading.



PCL Construction

be connected to. The load was large enough that many fasteners were needed, but the existing gusset plate fasteners were already carrying the truss load and couldn't simply be removed to connect a temporary support; so we chose a method that has been used in a small number of cases for gusset plate strengthening.

The challenge is that although all fasteners cannot be removed at the same time to install new material, they can be removed and replaced one at a time. The trick is that they are replaced with new bolts with extra-long threading, and this extra stick-thru can be used to attach the new material. A special fill plate, or "cheese" plate, is placed over the first set of nuts, providing a flat surface to install new material against. To fasten the new material, a second nut is added to the bolt's shank and fully tightened, and now the whole stack of plates acts in unison. The original material will have locked-in stresses from its current state, while the new material will be at a zero-stress state.

For the Blue Water Bridge, this concept was used to attach a temporary "knuckle" plate to the gusset, which supported a temporary link via a 9.5-in.-diameter pin. Once the new permanent link was installed and the load transferred, the installation process for the temporary connection was reversed to remove the knuckle plate and cheese plate and the fasteners were once again replaced one at a time, this time with permanent bolts of normal length. Compared to other temporary support options, such as extending 80 ft to the ground, connecting to the gusset plate in this manner enabled the use of a more compact temporary support that was controllable and predictable, used less material, and reduced contractor access requirements.

## Embrace Innovation

In a world where knowledge and technology are advancing rapidly, it's easy to be left behind. Due to the very nature of our profession of minimizing and managing risks to provide dependable infrastructure, we tend to rely heavily on tradition and what's been proven. But if we're going to reach our industry's 100-year-bridge-life goal (and beyond), we need to look beyond conventional solutions. Being open to unusual or new ideas, flexible, and willing to think outside of the box (even in simple ways) can help the project and the entire industry advance. Ultimately, when we embrace innovation, share ideas, and improve the state of the art, we all win. ■



M&M

An outboard view of the knuckle plate on the Blue Water Bridge.



## Getting Its Bearings

Seismic upgrades are the impetus for some steel rehabilitation projects. As an example, the steel-framed approach ramps for the RFK Bridge in Manhattan, while in good structural condition, weren't up to current seismic standards, so the steel superstructure was retrofitted to include a seismic isolation system. A "floating deck" isolation system was developed that isolated the new deck and floor system from the existing steel rigid-frame substructure below. The scheme resulted in a reduction in seismic demands such that only a handful of strengthening retrofits were required—all of which were located at regions that were relatively easy to access.

The design team at Modjeski and Masters implemented a hybrid system, using both sliding bearings and elastomeric bearings, with the sliding bearings carrying all vertical loads and dissipating energy through friction, and only a small number of isolation bearings being needed to provide the required restoring force. At the service load level, the friction developed at the sliding bearings resists the lateral design forces of wind, live load braking and live load centrifugal force (where applicable on the curved section of the on ramp). The system also resulted in most of the expansion joints being removed, thereby reducing the major source of deterioration (namely chloride-laden water infiltrating the steel) and creating a more maintenance-free structure. (The project is a 2018 NSBA Prize Bridge Award winner; see the June 2018 issue at [www.modernsteel.com](http://www.modernsteel.com) to learn more about it.)

## Innovation Highlights

- No Beam or Column Damage Under Severe Earthquake Loading
- Faster Repair Following a Severe Earthquake
- Less Steel + Less Fabrication Labor = Up Front Cost Savings
- No Field Welding + No Field Weld Inspection = Fast Erection

## Easy to Design

- Stiffness Checks Performed in RAM or ETABS
- Complimentary Design Assistance
- Connection Design, Detail Sheets, and Connection Schedules Provided

**DURA FUSE**  
FRAMES

[durafuseframes.com](http://durafuseframes.com)  
[contact@durafuseframes.com](mailto:contact@durafuseframes.com)  
801.727.4060



## Resiliency

**The bottom fuse plate in DuraFuse Frames protects the beams and columns and is the only part to be replaced after a severe earthquake.**



# business issues

## REINFORCE YOUR DESIRED CULTURE

BY DAN COUGHLIN



**Dan Coughlin** ([dan@thecoughlincompany.com](mailto:dan@thecoughlincompany.com))

equips business executives to consistently deliver excellence in management, leadership, and teamwork. Visit his website at [www.thecoughlincompany.com](http://www.thecoughlincompany.com).

Your ideal company culture doesn't just happen. It has to be planned, discussed, reinforced, and refined.

### CULTURE IS CRUCIAL.

It is what people across an organization believe is so important that it shapes their values and drives their behaviors on a consistent basis.

Every organization has a culture, and it takes intentional effort to create the one you want for your organization. Here are five questions to consider:

- What are the consistent behaviors in our organization right now?
- What values are driving those current behaviors?
- What behaviors do we want to see across our organization?
- What values do we want driving those behaviors?
- How can we reinforce the desired behaviors?

### Observe Behaviors

Try this: For the next 30 days, just observe what happens in your organization and write it down. Don't judge behaviors. Don't write down names. Just write down your observations. I actually encourage you to have several people in your organization write down the behaviors they see.

Your notes might reveal such behaviors as:

"A manager asks an employee for help on a project, and the employee says she doesn't have any time to help for the next three weeks."

"An employee goes up to a manager in the hallway, asks a question, and is told to just do her job."

"A group of managers sit around a boardroom table and patiently listen as each person gives an update on his or her projects."

Whatever the behaviors are, just write them down. At the end of 30 days you will have a pretty darn good recorded version of the actual culture in which you work. If you compare all of your notes and all of the notes of anyone else who recorded observed behaviors, you might start to see consistent patterns of behaviors. Those are the clues to your organization's current underlying belief system.

### Clarify the Beliefs that Drive these Behaviors

Now the more challenging part is to figure out what beliefs are driving those behaviors. Why are people saying they are too busy to help on a project for the next three weeks? Why are managers telling employees to stop asking questions and just do their job? Why are managers listening patiently to each other in meetings? Why are people in your organization consistently doing whatever they are doing?

Figuring this out requires empathy. You have to really work to understand what other people are thinking and feeling. You have to ask questions and really listen to understand what people believe is so important that it is driving their behaviors. Don't cut people off if you hear what you don't want to hear. Work to understand what is driving their behaviors.

You can talk with people privately or in small groups. It requires time and effort to understand what other people believe is really important.

## Decide on the Behaviors You Want to See

At this point, you have a fairly clear understanding of what is really happening in your organization. You understand the engine underneath the daily actions. And remember this: The values across the organization are driving the behaviors you see. What people believe to be important is what is causing them to behave the way they do. Those behaviors are driving the organization's performance.

Make three lists of behaviors. First list: the behaviors you want to continue to see in your organization. Second list: the behaviors you don't want to have happen anymore in your organization. Third list: the behaviors you want to start happening in your organization.

Don't just tell people what to do, what to stop, and what to start. That is a very short-term approach that will have no lasting impact on the culture. The place to start is to focus on changing what people believe is so important that it drives their behaviors on a consistent basis. If you can change their values regarding their work life, then you will have made a lasting impact on the culture of the organization.

## Choose Appropriate Values to Guide Behaviors

Now you are at the stage where lasting change begins to happen. You and the other members of the management group get to decide on what you want the values of the organization to be from here on out. That sounds so easy, right? Should take about fifteen minutes, don't you think? You can just Google what other companies do and cut and paste those as your values. And then post them on the wall. Voila. You are all done. (I'm kidding.)

Think of it this way. You get to choose three to five things that people believe are so important that they drive behaviors on a daily basis across your organization. If you try to focus on ten things, then you have diluted your impact on the future performance and results of the organization. You get three to five values. That's it. And those three to five values determine how people interact with each other, what they spend their time doing, what decisions they make, and how they interact with employees and customers and prospective customers.

Now do you see how incredibly important this stage is in impacting the future of your organization? Invest the time and energy it takes to determine the values you want guiding behaviors in your organization.

Here are five values, some of which are quite contrarian to what I typically see stated on the wall in organizations, that I suggest for organizations:

**Value 1: Learn, tweak, and apply.** The best companies, I think, get better on a regular basis. They don't just do a task and then move on to the next task. They do a task, and then they pause and reflect on what happened. They identify what worked well and why, what did not work well and why, what to keep doing, what to stop doing, and what to start doing. They identify the lessons they learned or relearned, and they apply those lessons the next time they do the task. Learn something, tweak it so it fits your situation, and apply it.

**Value 2: Being reasonable produces great long-term results.** Many organizations I've worked with seem to operate on the belief that an insane work schedule is the best way to produce great results. I disagree with that.

Sixty hours of work a week plus travel plus late nights plus poor eating can generate some short-term good business results, but it can also lead to a host of problems that hurt long-term business results, not to mention the health of your employees.

Think of a great meal at an expensive restaurant. They don't shove piles of food on the plate. They place a reasonable amount of really good food on your plate. It tastes delicious, and you don't feel overly stuffed when you're done. I encourage you to value reasonableness in what you are expecting of yourself and others. It's extraordinary what people can do with fresh energy and a clear mind.

**Value 3: Empathy first, problem-solving second.** Many groups are filled with A-type personalities who want to run in and solve the problem as soon as they hear about it. I suggest you slow down and work to understand what the other person is thinking and feeling. Gain confirmation from the person that you really do understand those things accurately. Only after you understand what the person, or the group, is thinking and feeling about the topic are you really in a position to help develop a solution.

**Value 4: Discuss what the right thing is to do, and then act on what you have agreed to do.** The "right" thing to do is almost always a matter of opinion. What you think is right might very well be appalling to another person. Before you move on doing the "right" thing, value discussing it with other people. By broadening your perspective you might very well land on a different interpretation of what is "right."

**Value 5: Contribute real value in every customer interaction.** It is not enough just to do a given job. The ultimate job for all of us is to add value to other people. Value is anything that increases the chances that the other person will achieve what he or she wants to achieve. With this value, every employee regardless of title becomes an added value to your customers.

The best companies  
get better on a regular basis.

.....

They don't just do a task and  
then move on to the next task.

.....

They do a task, then pause and  
reflect on what happened.

# business issues

---

Now that we've discussed what I see as important values to implement, here are three commonly stated values that I think need to be rethought:

**Value 1: Integrity.** Almost every organization states "integrity" as one of their values. Integrity means doing what you think is the right thing to do even if no one else is watching.

Imagine an employee who thinks that doing the right thing is calling customers up and telling them that they should not buy the company's new product because the competitor makes a better product. Is the employee's boss going to say, "You acted with integrity! Wonderful!?" I doubt it. I think it's more likely the employee will be reprimanded or fired.

If you say you value integrity, you might be guiding your employees to major problems within the organization. Integrity is a matter of opinion. I suggest it's better to emphasize discussions with other people to land on an agreement of what is the right thing.

**Value 2: Honesty.** Imagine an employee who thinks that being honest means telling the CEO in front of a group of people he dresses sloppily and comes across as a pig. Is the CEO going to say, "Thanks for your honesty!?" Again, I doubt it. As with integrity, while it sounds good to say that "honesty" is one of your organizational values, I think a more accurate

statement of what companies want is "awareness generated through conversations."

**Value 3: The customer is always right.** This one can reach ridiculous proportions. I worked at a frozen custard stand for my summer job while I was in college. The milkshakes were known for their thickness, and we had a policy that you could turn them upside-down and not a drop would spill out of the cup and that nothing would come out. On one occasion, a customer ordered a milkshake with multiple flavors (which was known to soften them up), stood in the parking lot, turned it upside-down, then yelled at one of my peers and demanded his money back when the milkshake spilled. This is just one of countless examples of how the customer is not always right.

Now it's your turn to clarify the values that you want to determine the behaviors in your organization. Do this with the other key leaders in your organization. Gain input in this process from people throughout your organization. This doesn't mean you have to include every person's thoughts in the final version, but I do encourage you to consider every person's thoughts.

## Reinforce Your Values

It is now up to you to consistently reinforce the three to five values you have agreed upon with others that need to drive



**See... the bolts are tight!**  
with **DuraSquirt® DTIs**

800 552 1999  
802 460 3100  
appliedbolting.com  
info@appliedbolting.com

the best way to bolt!





## business issues

behaviors in your organization—otherwise the whole process of creating your desired culture falls apart. This is all about leadership, the ability to influence how other people think so they make decisions that improve results in a sustainable way. So how do you do this?

**Model the values.** The fastest way to reinforce the desired culture is for you to actually act in accordance with the stated organizational values. The fastest way to ruin the desired culture is for you to act in ways that are opposite to your stated organizational values.

I was once a board member of a not-for-profit organization. One day, our executive director called a meeting, saying, "Our culture is based on collaboration. We need an open discussion between staff members and board members. We're going to have a special meeting to discuss the future of the organization." Five minutes into the meeting, he said, "I've heard your thoughts, and realistically we only have one direction to go, and that is to continue what we've been doing the last ten years." A beautiful example of ruining a desired culture.

**Deliver values-driven messages.** You can also reinforce your desired culture by what you highlight in your messages to the people in your organization. Whatever examples you highlight says to the rest of the organization what is really important. If you want "great teamwork" and you always highlight the same person over and over, you are sending a contradictory message.

Connect rewards with your stated values. What you reward (financially or otherwise) is what you are saying is important in your culture. Regardless of what is posted on the wall, if you reward innovation and disregard day-to-day operations than you are not about operational excellence.

Everything you do and everything you say emphasizes something over something else. I encourage you to know clearly the values that you want driving behaviors in your organization, and then consciously make decisions and statements and behaviors that reinforce those desired underlying beliefs about what is really important in your organization. ■



# THE HOLE SYSTEM AT A FAIR PRICE!

SEE OUR NEW  
**Xcelcut**  
PLASMA CUTTING TECHNOLOGY  
**FABTECH**  
BOOTH A5755

You need equipment that achieves your needs. No more, no less. The PCS EHD series is the answer.

Affordable, extra heavy-duty and reliable, with state-of-the-art cutting options.

Contact PCS to discuss your requirements!



brian@usapcsinc.com

1-800-656-1903 | [www.profilecuttingsystems.com](http://www.profilecuttingsystems.com)

**InfoSight**  
Corporation  
"We BARCODE Difficult Stuff™"

Chillicothe, Ohio USA 45601  
+1-740-642-3600  
[www.infosight.com](http://www.infosight.com)  
sales@infosight.com

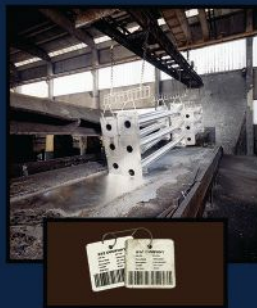

## Identification and Traceability Solutions for Galvanizers and Fabricators



**FABTECH**

Booth A3555  
Chicago, IL November 11-14, 2019

**POWERGEN**  
INTERNATIONAL

Booth 4154  
New Orleans, LA November 19-21, 2019

At one end of a  
pedestrian bridge in  
suburban Denver,  
a towering steel

leaf plays the  
dual roles of  
artistic beacon  
and important  
structural  
element.

# A New Leaf

BY CURTIS FENTRESS, FAIA

left and below: The design team refined the bridge's pylon leaf design while retaining structural integrity. From the leaf, six pairs of cables extend to the north to support the bridge. Soaring 100 ft above Lincoln Avenue, the bridge's unique form is seen from many vantage points throughout the city of Lone Tree, Colo., and creates a memorable image for those traveling on and over the busy thoroughfare.



© Michael Tamburello, courtesy of Fentress Architects

**LINCOLN AVENUE**, an east-west corridor in Lone Tree, Colo., sees a traffic load of 90,000 cars per day.

The busiest thoroughfare in this southern suburb of Denver, it divides Lone Tree Elementary School and residential communities on the north from local retail, workplaces, and parkland on the south. Given the area's growth and Lincoln Avenue's significant traffic load, it became increasingly treacherous for pedestrians and cyclists to cross at street level.

But a new pedestrian bridge at a strategic crossing point—near vibrant commercial strips and the school—now allows children from the elementary school to avoid Lincoln Avenue's traffic and safely reach open space parkland for scientific and ecology education. It also lets workers on the north side easily get to eateries on the south side and provides runners and cyclists with unhindered access to a network of recreational trails that the road interrupts.

### Symbolic Design

Completed last year, the new 170-ft-long, steel-framed Lone Tree Pedestrian Bridge achieves these goals rather stylishly. In the preliminary stages of the project, the city challenged Fentress Architects to design not only a pedestrian bridge, but one with flair, an



**Curtis Fentress** ([fentress@fentressarchitects.com](mailto:fentress@fentressarchitects.com)) is president and principal in charge of design at Fentress Architects.



above: The bridge provides safe pedestrian passage over a major road with a traffic load of 90,000 vehicles per day.

right: The pylon is a 3D lattice truss constructed of steel members, with a twist in the geometry to create a sculptural form.

below: Stainless steel mesh on the sides and an ETFE roof on top protect bridge users from severe weather while enabling them to enjoy the elements on pleasant days.



© Jason A. Knowles, courtesy of Fentress Architects



© Michael Tamburello, courtesy of Fentress Architects

icon that would reference the city itself. Lone Tree's logo is a tree and the Lone Tree Art Center's (near the bridge on the south side of Lincoln) is a leaf, and the city wanted this foliage theme incorporated in the design.

Fentress and structural engineer Thornton Tomasetti delivered. The steel main pylon, in the shape of a leaf, rises 100 ft above the road, creating a highly visible landmark. From the leaf mast, six pairs of cables extend down to support the bridge deck. The deck is defined by an in-plane steel truss created by longitudinal edge beams, cross beams, and diagonal bracing—all using conventional rolled steel members, mostly W18s (fabricated by King Fabrication)—below the slab to provide lateral stiffness and stability to the span. The bridge deck consists of a 3-in.-thick reinforced concrete

topping slab over 3.5-in.-thick precast concrete panels. The topping slab was poured onto the steel beam between the panels, providing a structural connection between the slab and the beams. In addition, a steel “knuckle” at the base of the leaf pylon incorporates a 10-in.-diameter by 4-ft-long stainless steel pin inside of a steel sleeve, resulting in a true pinned base with no rotational restraint at the base of the pylon.

While Fentress has worked on pedestrian bridges that connect offices, laboratories, and airport buildings, this was the firm's first major pedestrian bridge over a busy roadway. The design team studied a number of structural systems, initially presenting a box truss option and a suspension option along with the chosen cable-stay option. The cable-stay format was eventually chosen as it was a lighter



© Kurt Brown



© Jason A. Knowles, courtesy of Fentress Architects

above: The bridge was erected in only one weekend closure of Lincoln Avenue.

left: Transporting the completed leaf pylon to the job site.

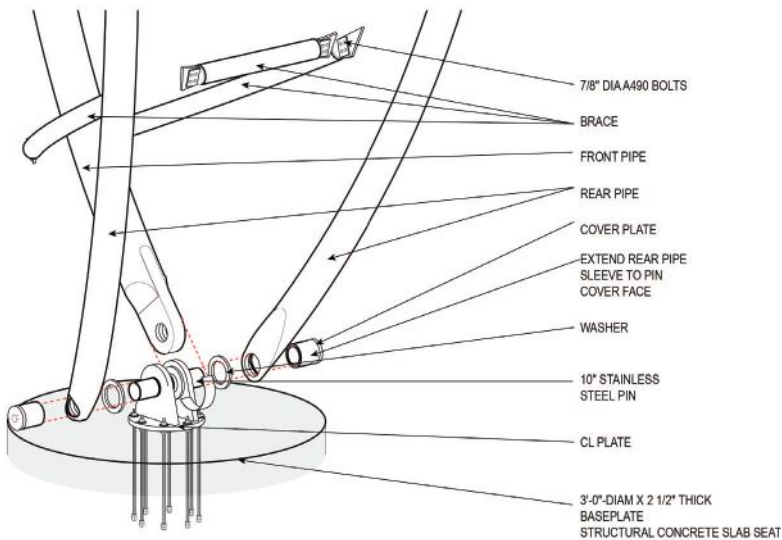

© Jason A. Knowles, courtesy of Fentress Architects

above and left: A steel knuckle at the base of the leaf pylon incorporates a 10-in.-diameter by 4-ft-long stainless steel pin inside a steel sleeve.

than a deep-girder bridge while also being stiffer than a suspension bridge. It also allowed much of the structure to be located at the pylon rather than within the span, creating a thinner profile for the span itself—minimizing the impact on views to the Colorado mountains and downtown skyline and also meeting the clearance requirement of 17 ft, 6 in. for pedestrian bridges that cross major arteries—and reducing the structure’s weight as well as material costs.

### Light as a Leaf

The bridge uses roughly 100 tons of structural steel in all, coated with a zinc-rich epoxy primer topped with fluoropolymer urethane. The leaf is formed from thick-walled pipe, 24-in.-diameter for the primary and 18-in.-diameter for the secondary members, with 10-in.-diameter

“veins” in between. The thick walls allowed the sections to have a thinner profile while still achieving the required structural properties.

The leaf was delivered to Lone Tree in one piece, and the spans were delivered in two pieces, all from King’s shop in Houston. Thanks to the bridge essentially arriving at the job site in only three major components, it was erected with only one weekend closure of Lincoln Avenue. Once the road closure began (8:00 p.m. on a Friday), the leaf, including the pin at the base, was driven to the road beneath its pedestal. Two cranes were used to lift it, one at the base (300-ton) and one at the tip (500-ton). Once lifted horizontally, the base crane slowly lowered the bottom, then released it. With the installers guiding it, the leaf was lowered onto its pedestal, and adjustments were made to rotate it so that it would align with the anchor bolts. Once the leaf

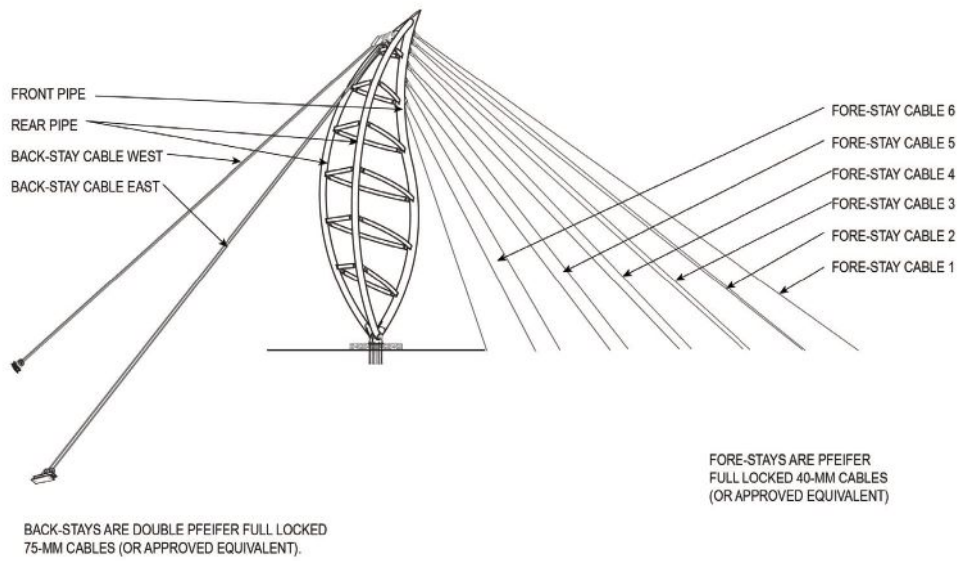

left: Looking down on Lone Tree. The bridge, at center in the image, provides a vital link in an extensive pedestrian and cyclist trail system.

above: The backstay and forestay cables as they connect to the pylon.

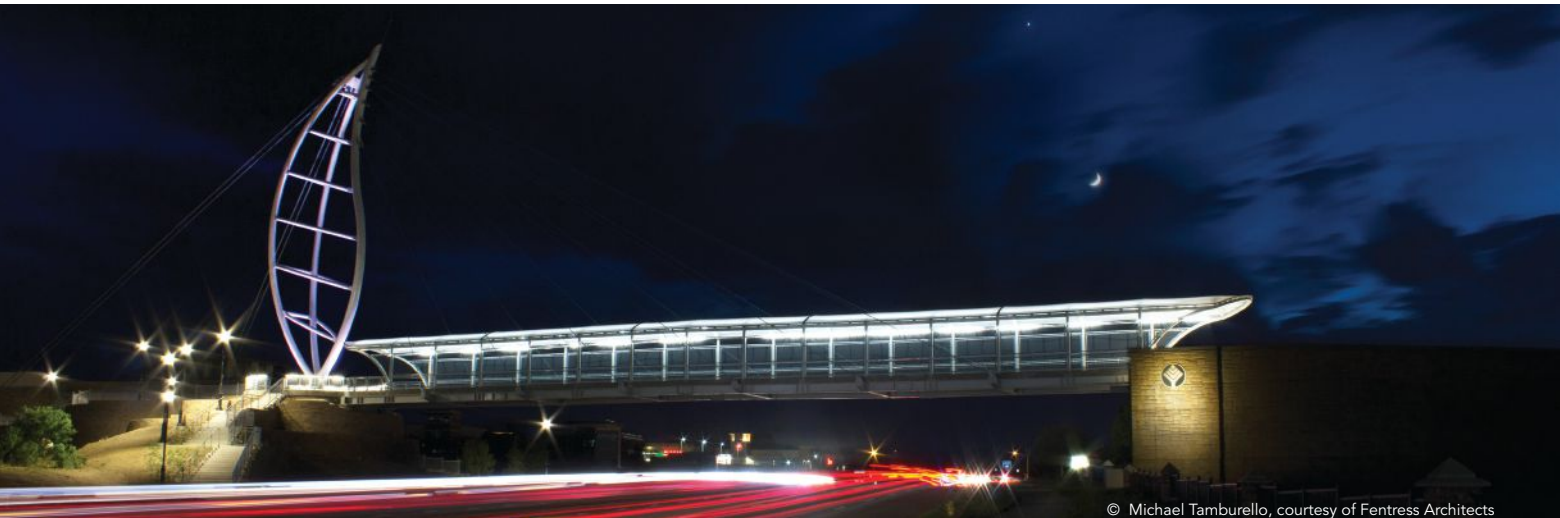

© Michael Tamburello, courtesy of Fentress Architects

© Jason A. Knowles, courtesy of Fentress Architects

above and below: As a critical connection for local pedestrian traffic, the new bridge spans across the rapidly growing area's busiest east-west road.

left: For the leaf pylon, the team focused on the sensitivities of the cable and pylon geometry to harmonize steel's efficiency with an artistic design.



© Michael Tamburello, courtesy of Fentress Architects

pylon was in place, the backstay cables were connected while the other crane was still holding it erect.

While the leaf was going up, another crew was installing a shoring tower at mid-span. As work continued on the leaf pylon, the two spans were installed and joined at mid-span. Next came the 1½-in.-diameter forestay cables, which connected to the leaf and the bridge spans. The forestays are a fixed length, so the 3-in.-diameter backstays were jacked in order to tension them. The cables are connected to the pylon at their tops and to the slab at their bottoms via large tension-cable sockets, providing field adjustability during installation and allowing for rotation of the cables during construction. The backstay cables are connected with similar sockets to long steel rod anchors that transfer the bridge cable forces into the earth.

The roof of the bridge consists of a thin ethylene tetrafluoroethylene (ETFE) membrane stretched between pretensioned steel cables anchored at each end. The ETFE system keeps the bridge roof light yet still stiff enough to support snow loads of the roof without significant sagging, while also allowing light through into the covered span. A simple portal frame supported on the main span deck, featuring mesh panels down either side, provides the infrastructure for the enclosure. Ramps on each end of the bridge facilitate accessible design, multimodal access and connect students, residents, and workers to the amenities on both sides.

The new Lone Tree Pedestrian Bridge celebrates the unification, both socially and physically, of Lone Tree's north- and south-side communities. The structure's memorable form creates a major landmark for the city and establishes a model of its vision for the future: a more easily accessible community with safe passage for pedestrians. ■

**Owner**

City of Lone Tree, Colo.

**General Contractor**

Hamon Infrastructure, Denver

**Architect**

Fentress Architects, Denver

**Structural Engineer**

Thornton Tomasetti, Denver

**Steel Team**

**Fabricators**

King Fabrication, LLC, Houston  (also Detailer)

FabriTec Structures, Dallas  (ETFE Framing)

**Bender-Roller**

Bendco, Pasadena, Texas 

# HEXP<sup>®</sup>ORT<sup>®</sup>

Save valuable time and money. Never search for bolting documents ever again!

- Test Reports
- Invoices
- Packing Lists
- DOT Approvals
- Order Tracking
- Proof of Delivery



Call or Go Online to find out more  
**St. Louis Screw & Bolt**

[stlouisscrewbolt.com](http://stlouisscrewbolt.com)  
800-237-7059

## Structural Bolting Experts



Tired of waiting on mechanical locations?

With QuickFrames, you don't have to.

Learn more at [quickframes.us](http://quickframes.us)

**QUICKFRAMES<sup>™</sup>**  
quickframes.us 480-464-1500

Steel successfully supports a STEM addition  
to a suburban Chicago high school.

# Lesson Plan

BY NICOLE  
MCGRATH-PATTI



**Nicole McGrath-Patti**  
([nmcgrath-patti@larsonengr.com](mailto:nmcgrath-patti@larsonengr.com))  
is the marketing manager at  
Larson Engineering. **Jerry Tobola,**  
**SE,** with Larson also contributed.

**PLENTY OF SCHOOLS** are dedicated to the sciences, as the STEM (science, technology, engineering, and mathematics) format has risen to prominence in recent years.

But how many of them have a façade designed to resemble the periodic table of elements?

The new STEM addition to Mundelein High School does. Located in the northern Chicago suburb of Mundelein, the school recently completed a three-story 55,000-sq.-ft addition, expanding and improving classrooms and laboratories dedicated to STEM curriculum in a public high school setting. The use of a structural steel frame provided the flexibility to realize architect Legat's vision while also facilitating the load path transfers necessary to bridge over existing construction.

Designed to provide more and modern space for STEM education, the building includes movable glass walls, a monumental staircase—made of structural steel channels and plates to provide a sharp-cornered appearance, concrete platforms, and glass handrails—flexible work spaces, floor-to-ceiling windows, extra-wide hallways, labs twice the size of those in the original building, state-of-the-art equipment, and ample exhibition





© James Steinkamp, Steinkamp Photography

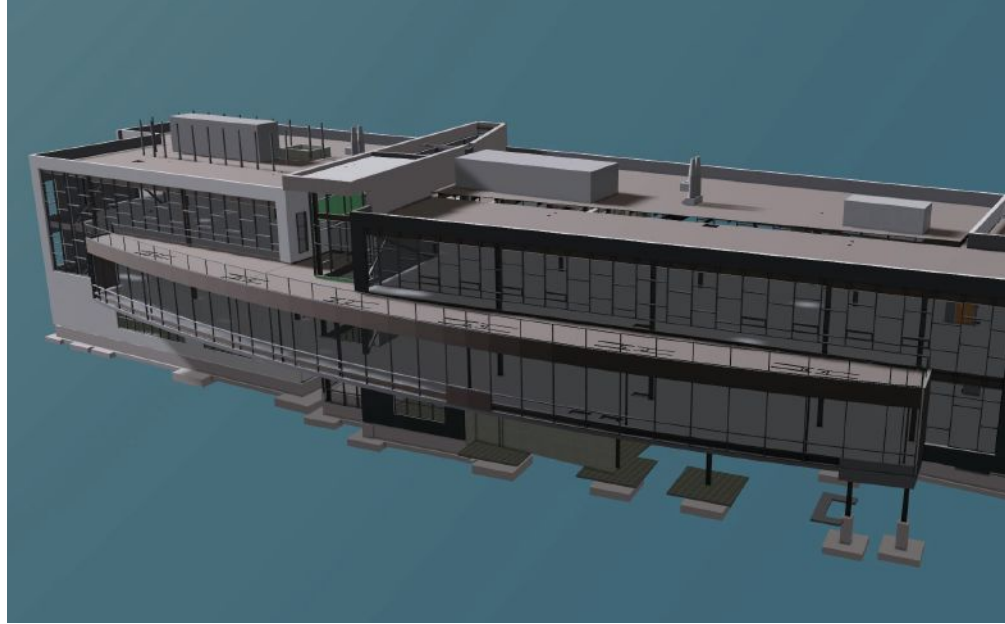

left: The use of a structural steel frame for the three-story 55,000-sq.-ft addition to Mundelein High School provided the flexibility to realize architect Legat's vision—including the grid pattern on the façade, which is meant to resemble the periodic table of elements—while also facilitating the necessary load path transfers to bridge over existing construction.

above and below: The addition uses approximately 300 tons of structural steel in all.

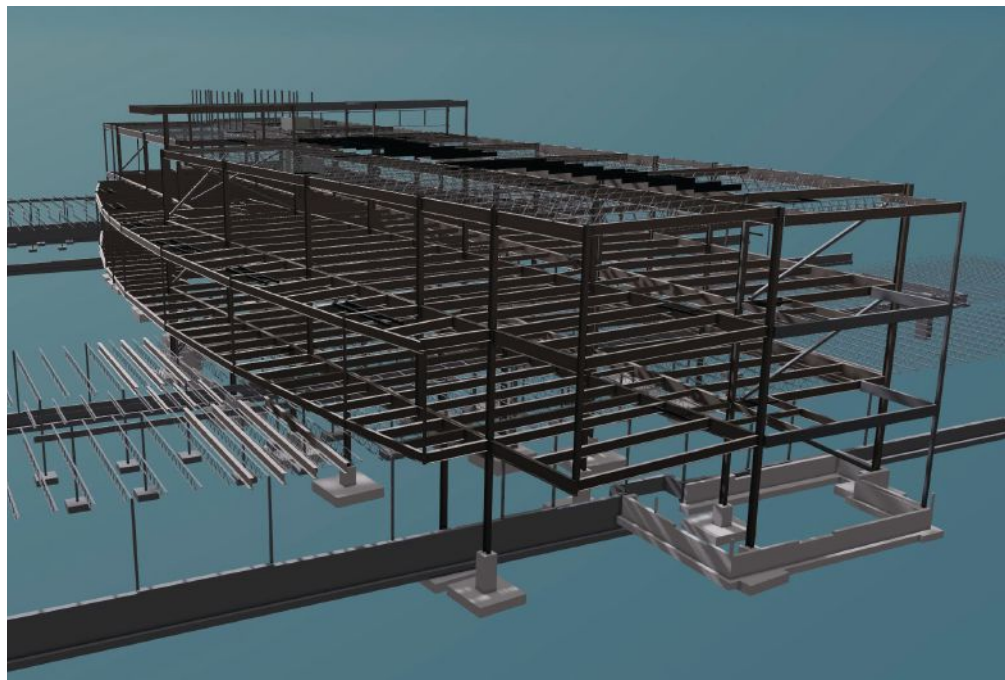

space for special initiatives like the school's business incubator and its pre-engineering program.

And it's not just the façade that puts science on display. The \$23.7 million project tailors every detail to its high-tech purpose, exposing rather than concealing the building's inner workings, including its steel framing system, which uses approximately 300 tons of structural steel. Designing the frame with steel simplified construction in a logistically challenging location as erection was staged in a courtyard with limited space and surrounded by the existing building on three sides. In addition, the new construction is partially located over the existing building.

The floor system is a steel-concrete composite system with wide-flange beams at 7 ft to 8 ft on center supporting a 3-in. concrete slab on a 2-in. galvanized composite metal deck. Wide-flange

composite girders were used along with wide-flange (W10×54 and W24×68) and hollow structural section (HSS4×4<sup>5/16</sup> and HSS6×6×<sup>5/16</sup>) columns. When it came to addressing lateral loads, architectural considerations restricted bracing in the east-west direction. As such, lateral loads are resisted by concentric braced frames in the north-south direction and moment-resisting frames in the east-west direction.

Cantilevers also play a major role in the building's design. At the second floor on the west side of the building are a series of break-out rooms that form a cantilevered arc, extending the classrooms on that side of the facility, with the roof of this area designed as an accessible outdoor learning space. These cantilevers range from 7 ft, 6 in. to 17 ft, 6 in. At the east end of the building, the southeast corner cantilevers 16 ft over a recessed first-floor entry plaza.

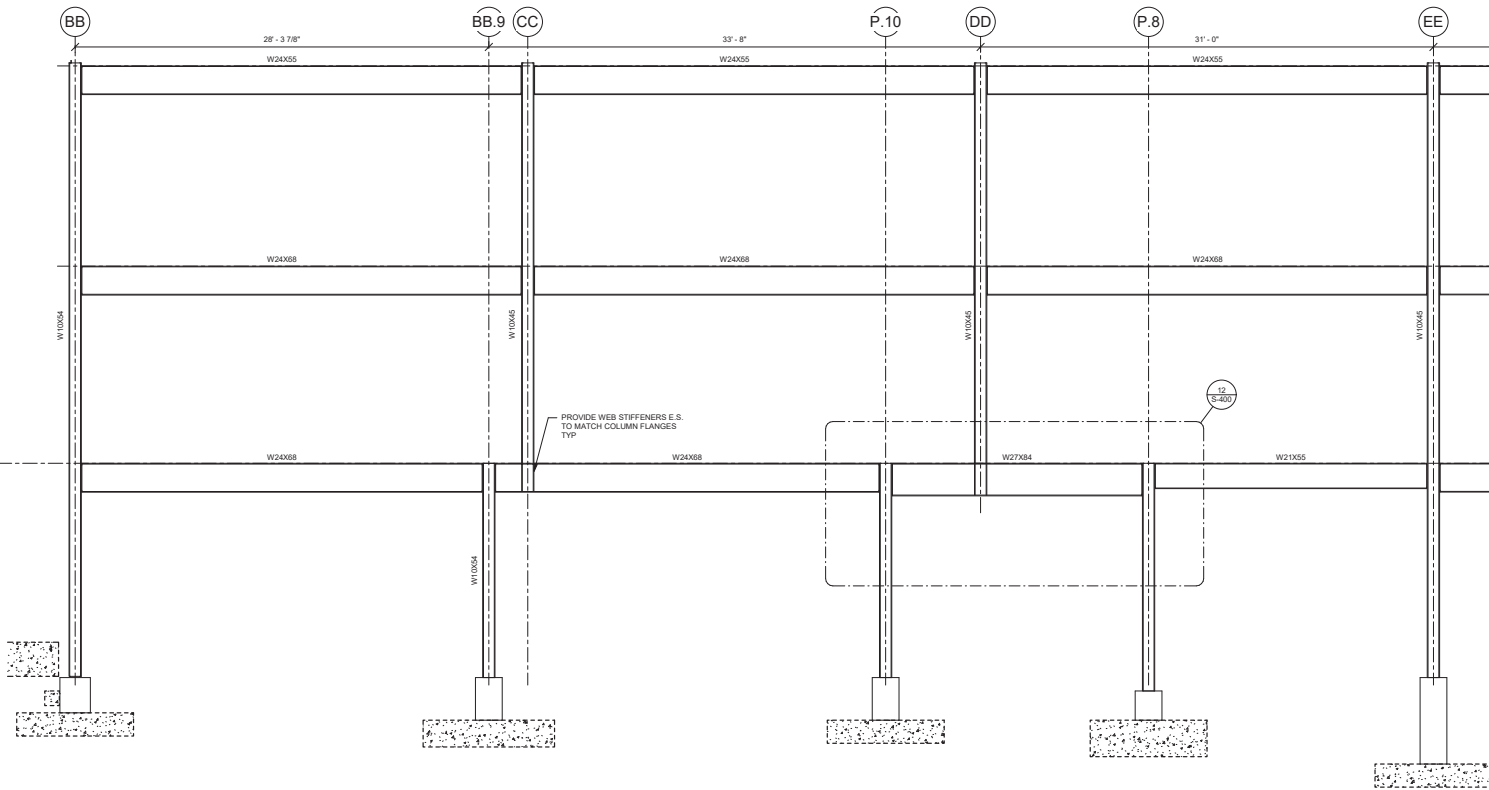

above: Multiple transfer girders using W27×84 and W27×94 members were employed in the second-floor framing.

below: Cantilevers, which play a prominent role in the building's design, range from 7 ft, 6 in. to 17 ft, 6 in.



Larson Engineering, Inc.

# Stimulate Your Infrastructure With Steel Curved by Chicago Metal Rolled Products

## ◀ 17-92 Pedestrian Bridge (Longwood, FL)

It doesn't matter how complex the curve is. For this project Chicago Metal Rolled Products curved 66 tons of 14" square tubing up to 70' long with both sweep and camber.

## Highland Bridge (Denver, CO) ▶

This award-winning bridge is both dramatic and economical. Chicago Metal Rolled Products' Kansas City facility was able to curve 153 tons of 18" outside diameter tubing up to 100' long, which reduced splicing costs.

## ◀ Tempe Town Bridge (Tempe, AZ)

Winner of multiple prestigious awards, each of the four 228' long arching sections consists of 16" diameter HSS pipe curved up to 46' in good arc...a pedestrian bridge providing both function and aesthetics.

Our nation needs infrastructure improvements. Let Chicago Metal Rolled Products help you build bridges, tanks, tunnel supports, cofferdams, culverts, man ways, guard rails, viaducts, reinforcing columns and other structures.

**Call us at 866-940-5739**

**When you need high-quality, high-value curving of steel.**



**CHICAGO METAL  
ROLLED PRODUCTS COMPANY**

CHICAGO • KANSAS CITY  
[cmrp.com](http://cmrp.com)



**1 Angle Leg Out** We bend ALL sizes up to:  
 10" x 10" x 1" Angle

**2 Angle Leg In**  
 10" x 10" x 1" Angle

**3 Flat Bar The Hard Way**  
 24" x 12" Flat

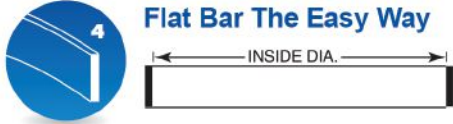
**4 Flat Bar The Easy Way**  
 36" x 12" Flat

**5 Square Bar**  
 18" Square

**6 Beam The Easy Way (Y-Y Axis)**  
 44" x 335#,  
36" x 925#

**7 Beam The Hard Way (X-X Axis)**  
 44" x 285#

**8 Channel Flanges In**  
 All Sizes

**9 Channel Flanges Out**  
 All Sizes

**10 Channel The Hard Way (X-X Axis)**  
 All Sizes

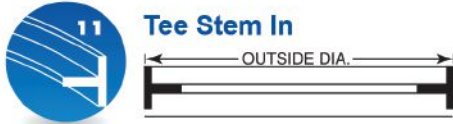
**11 Tee Stem In**  
 22" x 142<sup>1</sup>/<sub>2</sub># Tee

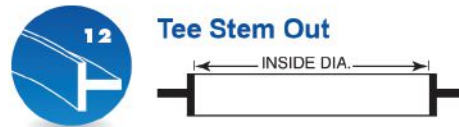
**12 Tee Stem Out** We bend ALL sizes up to:  
 22" x 142<sup>1</sup>/<sub>2</sub># Tee

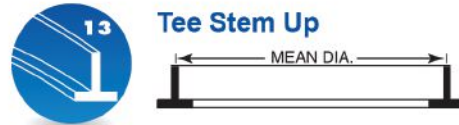
**13 Tee Stem Up**  
 22" x 142<sup>1</sup>/<sub>2</sub># Tee

**14 Angle Heel In**  
 8" x 8" x 1" Angle

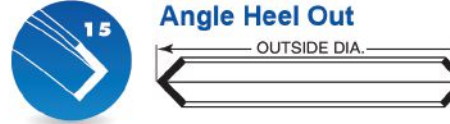
**15 Angle Heel Out**  
 8" x 8" x 1" Angle

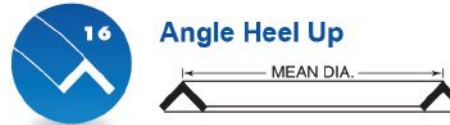
**16 Angle Heel Up**  
 8" x 8"x1" Angle

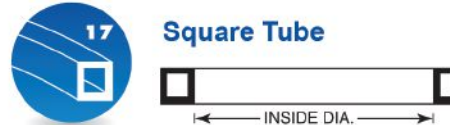
**17 Square Tube**  
 24" x 1<sup>1</sup>/<sub>2</sub>" Tube

**18 Rectangular Tube The Easy Way (Y-Y Axis)**  
 20" x 12" x 5/8" Tube

**19 Rectangular Tube The Hard Way (X-X Axis)**  
 20" x 12" x 5/8" Tube

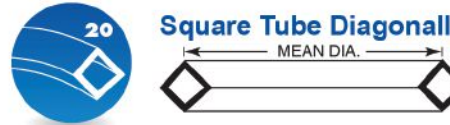
**20 Square Tube Diagonally**  
 12" x 5/8" Square Tube

**21 Round Tube & Pipe**  
 24" Sched. 80 Pipe

**22 Round Bar**  
 All Mill Produced Sizes

We also roll stair stringers, helical hand rails, off-axis bends, formed shapes and extrusions.

Visit [cmrp.com](http://cmrp.com) for more information.



**CHICAGO METAL**  
**ROLLED PRODUCTS COMPANY**

CHICAGO • KANSAS CITY



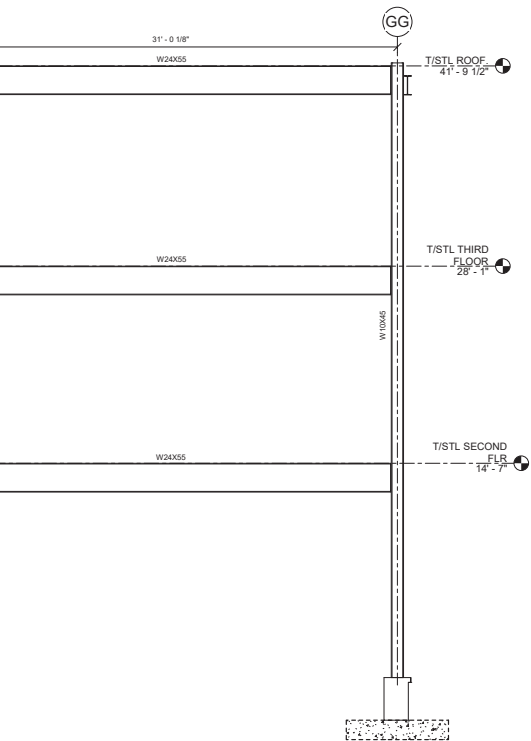

# ONE MACHINE DOES IT ALL

Save time and money with all-in-one plasma cutting, milling & drilling

Plus Automated Part Unloading

## Kinetic

[KineticUSA.com](http://KineticUSA.com)  
1.800.606.2954

The portion of the new building over the existing single-story building was originally designed to minimize disruption to the existing facility by using story-deep Vierendeel trusses to bridge the area. This was revised due to changes in construction manager IHC's construction sequencing plan, as well as the fact that the large trusses would have required a much larger crane. Instead, the team was able to locate a number of columns within the existing spaces. However, the grid required in the classroom areas on the second and third floors could not be fully extended down. As such, multiple transfer girders using W27×84 and W27×94 members were employed in the second-floor framing.

The building's roofs were typically constructed with a 1½-in. wide rib deck on steel joists spaced at 6 ft on center. Some areas of the main corridor are framed with 10-in.-deep steel channel sections to accommodate the large rooftop mechanical units and main duct runs without increasing the overall height of the structure. In addition, the roofs of a single-story STEM lab and pre-engineering areas are designed to support a pipe grid of miscellaneous steel that allows the rigging of various experimental setups.

Much of the modeling and design was done in Trimble's Fastrak software, and the

## THE PROVEN STEEL BRIDGE DESIGN SOLUTION

**FREE 15-DAY TRIAL\***

\*see website for details



The leading software package for designing and rating curved and straight steel girder bridges.

**Used by Many State DOTs and Top Design Firms**

(573) 446-3221 ■ [www.mdxsoftware.com](http://www.mdxsoftware.com) ■ [info@mdxsoftware.com](mailto:info@mdxsoftware.com)



© James Steinkamp, Steinkamp Photography

above: The monumental staircase is made of structural steel channels and plates to provide a sharp-cornered appearance.

below: The addition was constructed partially in a courtyard at the existing school and partially over a one-story portion of the existing building.

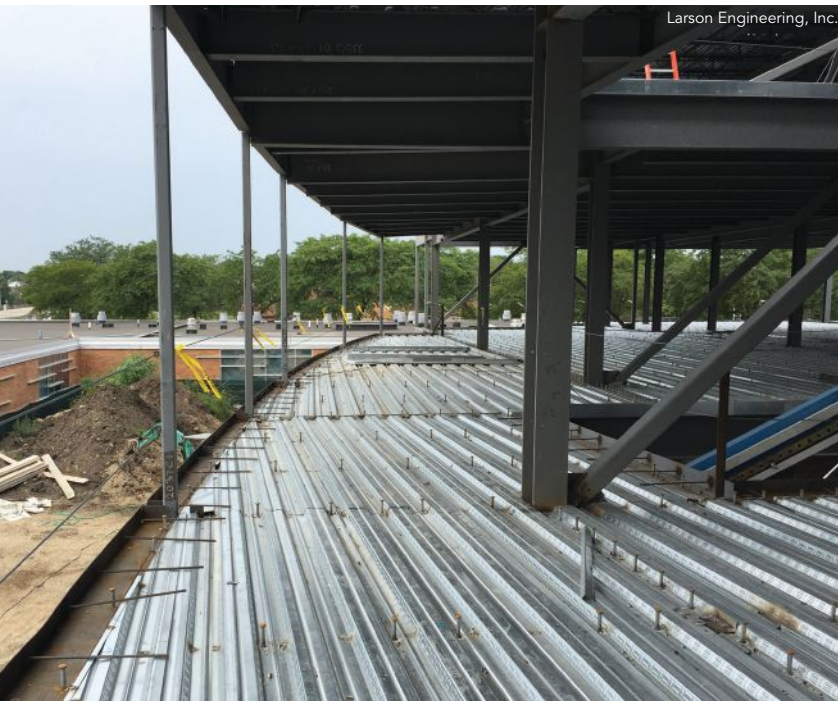

Larson Engineering, Inc.

model was transferred to Autodesk Revit to create the construction documents and allow for coordination with the other disciplines. What helped facilitate the process was the fact that the design team had access to Revit models of both the existing building and the new addition, which made it much easier to coordinate areas where the two connected.

Now open, Mundelein High School's new addition serves as a physical example of the sciences, educating students not only within the classrooms but also via the building's framework itself. ■

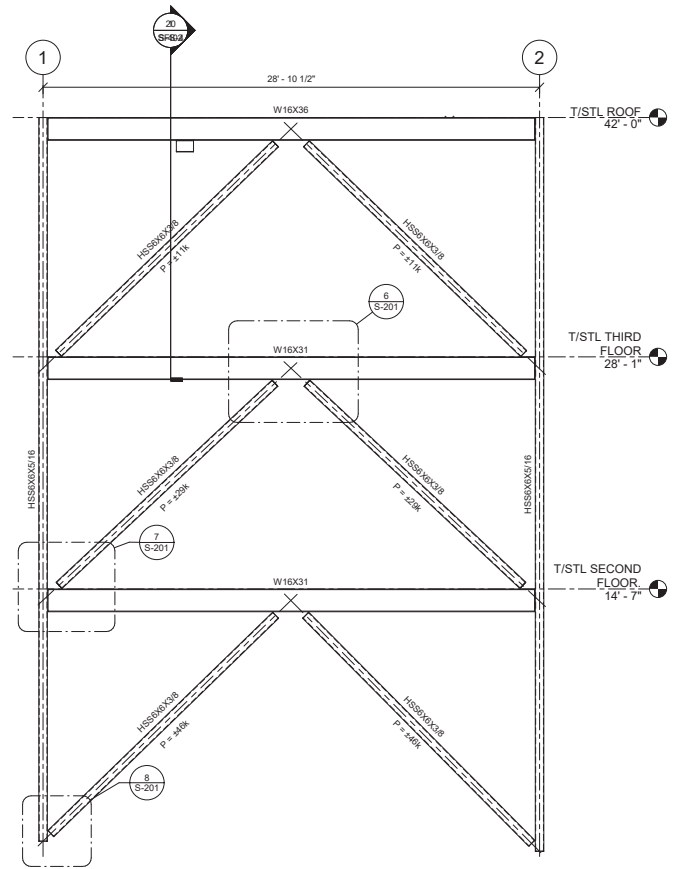

above: Lateral loads are resisted by concentric braced frames in the north-south direction.

below: An expanded and improved student experience with STEM-focused curriculum was a major goal for the addition.



© James Steinkamp, Steinkamp Photography

**Owner**

Mundelein High School District 120, Mundelein, Ill.

**General Contractor**

IHC Construction Companies, Elgin, Ill.

**Architect**

Legat Architects, Oak Brook, Ill.

**Structural Engineer**

Larson Engineering, Inc., Naperville, Ill.

**Steel Fabricator, Erector, and Detailer**

Waukegan Steel, LLC, Waukegan, Ill. 



© James Steinkamp, Steinkamp Photography

At the second floor on the west side of the building, a series of break-out rooms form a cantilevered arc, extending the classrooms on that side of the facility. The roof of this area provides an accessible outdoor learning space.

**NEW!**

**ACCELERATING  
YOUR  
PERFORMANCE**



**VOORTMAN STEEL MACHINERY**

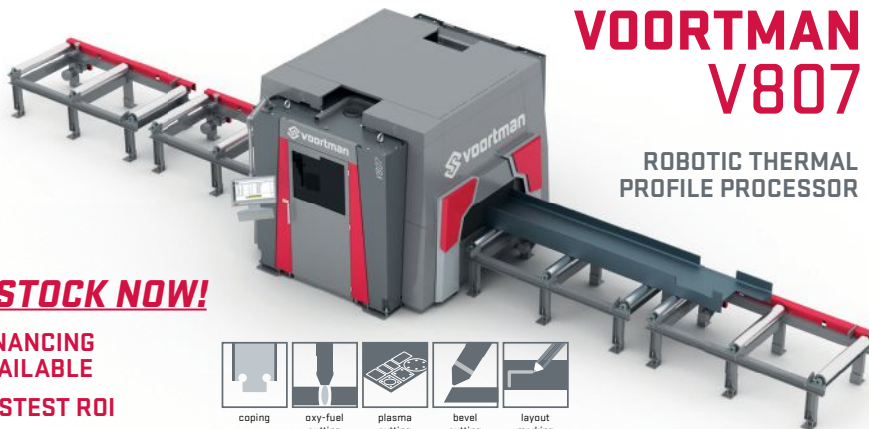

**VOORTMAN  
V807**

**ROBOTIC THERMAL  
PROFILE PROCESSOR**

**IN STOCK NOW!**

- ▶ FINANCING AVAILABLE
- ▶ FASTEST ROI

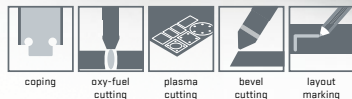

- ▶ Fully automated processing from loading to unloading
- ▶ Footprint reduced 50%
- ▶ Easy maintenance and installation
- ▶ Capable of plasma and oxy-fuel cutting
- ▶ Stock systems available in North America

**FABTECH**

NOVEMBER 11-14, 2019  
Chicago, IL USA

**BOOTH A2169**



**VOORTMAN USA**

26200 S. Whiting Way +1 708 885 4900  
Monee, IL 60449 info@voortmancorp.com  
United States of America www.voortmancorp.com



Both waterways and vehicular traffic were kept free of interruption during a major steel bridge replacement over the Missouri River.

# Open Channels

BY BRUCE A. BURT, PE | PHOTOS COURTESY OF MoDOT



**Bruce Burt** ([bburt@rubyandassociates.com](mailto:bburt@rubyandassociates.com)) is a principal with Ruby+Associates, Inc.

**SINCE OPENING IN 1936**, the two-lane Route 47 Bridge in Washington, Mo., has provided a prominent vehicular crossing over the Missouri River roughly 50 miles west of downtown St. Louis. Unfortunately, the historic two-lane steel truss bridge had become functionally obsolete in recent years and required replacement.

Just 15 ft upstream from where it once stood is its brand-new structural steel replacement (the distance between the new and old bridge centerlines is 60 ft), which provides a 52-ft vertical clearance for river traffic. The new 1,770-ft-long main span bridge, which opened to traffic in December 2018, features 12-ft lanes, 10-ft shoulders, and a protected 10-ft bicycle/pedestrian path. Structurally, the new bridge consists of five concrete 160-ft approach spans and four steel main spans. The main spans are each comprised of five steel plate girders whose depths range from 18 ft at the support piers to 10 ft, 6 in. at their midspans. The two outer spans are 385 ft long, and the two central spans are 500 ft long. In total, 5,800 tons of structural steel, including 75 girder sections, 346 cross-frames, 336 lateral braces, and 24 diaphragms, were used in its construction.

## Minimizing Falsework

Close collaboration between general contractor Alberici Constructors and erection engineer Ruby+Associates resulted in an efficient erection plan that minimized falsework and





left: The superstructure for the new bridge, which uses 5,800 tons of structural steel in all, nearing completion.

below: A bird's-eye view of the temporary shoring towers, which were founded on compacted gravel and timber crane mats. The original bridge remained open to traffic during construction of the new bridge.

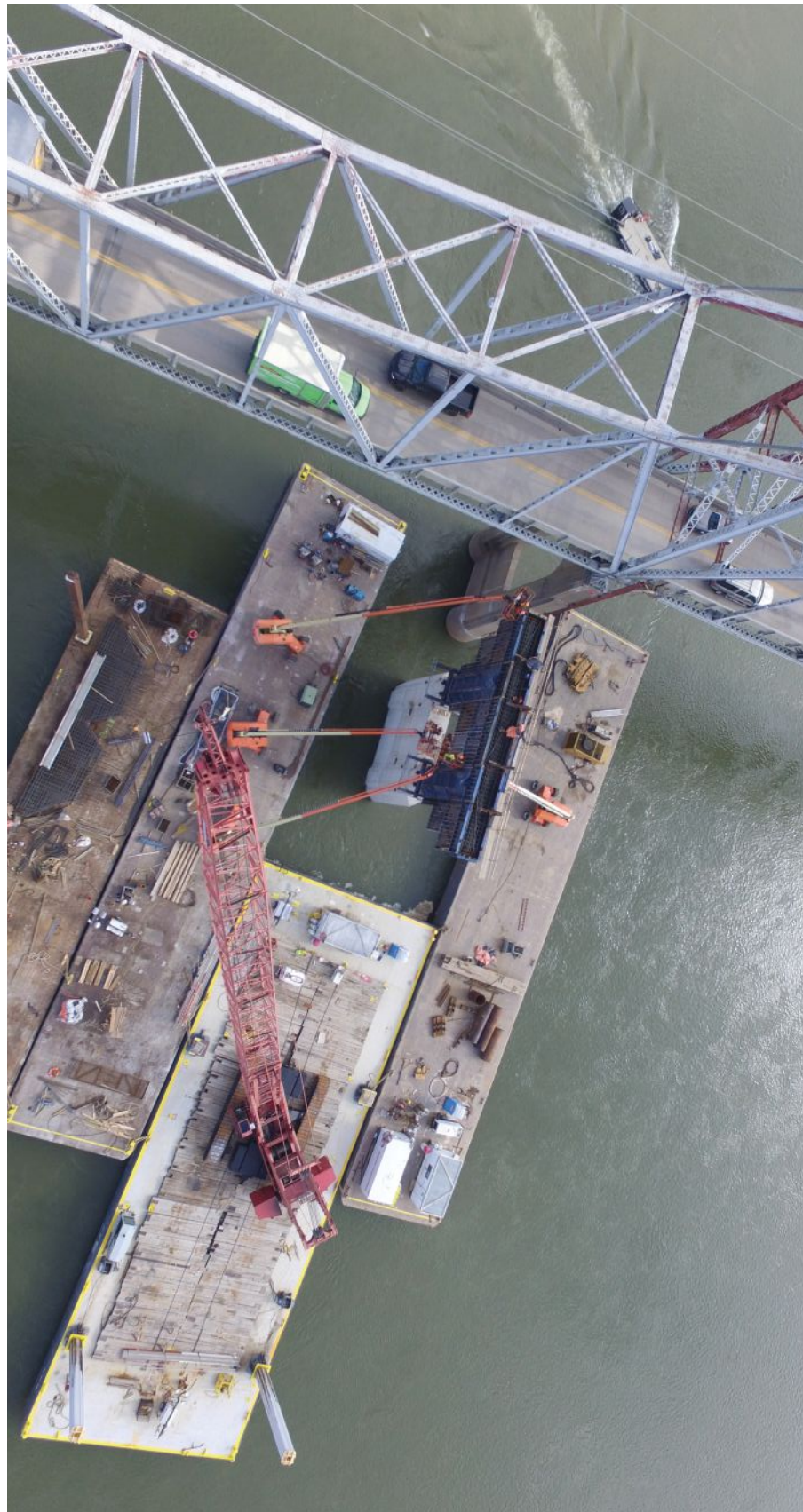

temporary shoring for the bridge. A flexible support bracket system was developed to reduce the length of girder cantilevers during erection. The bracket system was designed to move from pier to pier, resulting in a significant weight savings in steel falsework and river-based shoring.

Thanks to a comprehensive stability analysis and careful planning, the team was able to reduce the number of shoring locations to just three, with one shore placed on a temporary causeway and two within the waterway. A hybrid shoring system was developed for the two shoring bents located in the river. Salvaged 42-in.-diameter steel pipe was driven in the riverbed in four-pile groups, then cut to elevation above river high water datum. Temporary shoring towers were attached to the pile groups using conical transition pieces, allowing positional adjustability to account for pile-driving tolerances. A temporary support girder



above: Girders were raised using a pair of crawler cranes.

left: The out-to-out distance between the new and old bridges is 15 ft.

below: Lifting one of the massive plate girders from the ground.



spanned between adjacent tower sections, and each hybrid tower—consisting of pipe piles, transition elements, and rented tower sections—was designed as a cantilevered column to eliminate the need for custom-fabricated, field-installed bracing between the towers.

To eliminate the need for piledriving at the third shoring location, a temporary causeway was extended and the temporary shoring towers were founded on compacted gravel and timber crane mats. To provide lateral stability of the shoring system without the need for expensive field bracing between tower sections, one shoring tower was designed as a cantilevered column and the adjacent tower was designed to lean on the cantilevered tower. Base fixity for the cantilevered tower was achieved by mounting it on outrigger beams and casting concrete blocks on the outriggers to provide overturning and sliding resistance.

To further reduce shoring requirements as well as the number of “air splices,” the ironworker crews needed to assemble two girder sections—one 100 ft long and the other 114 ft long—for the outer two bridge spans end-to-end on the ground. These pre-assembled girders, which combined to form 214-ft-long girder sections weighing more than 100 tons apiece, were raised using a pair of crawler cranes working in tandem. A midspan support was required to provide lateral stability for the first preassembled girder section, and a lightweight shoring tower was repurposed

from a previous Alberici project to provide the necessary support. Subsequent girder assemblies were erected using the same two-crane lift method, then laced back to the previously erected girder before being released from the crane. Due to the increased lateral strength of the now interlaced girders, intermediate shoring was not required beneath the remaining girders.

The temporary pier brackets mounted to the piers provided stability to the double-cantilever girder sections and were designed to deflect in order to accommodate deformations induced during erection as additional girder sections were added. This support bracket system was mounted to one concrete pier, then dismantled and reused at subsequent piers, and spacers of varying depths were placed at the tips of girder brackets to account for different girder profiles at each bridge pier.

### Erection Sequence Proves Critical

One of the project’s main challenges required maintaining the 400-ft-wide shipping lane in the Missouri River, necessitating the erection of the 500-ft-long central bridge span above the shipping lane without the use of shoring or other waterway obstructions. A sequenced erection plan was developed to ensure the stability of the long cantilevers that resulted from the un-shored method, and a



The original bridge was demolished via synchronized demolition charges. The new bridge is fully visible in the third photo.

.....  
procedure was developed for installing the final “key-stone” girder sections (called this because they are at the center of the middle 500-ft span).

In order to safely install the long cantilevers required to partially close the 500-ft span, the adjacent bridge spans had to be completed first. This entailed erecting the double-cantilever girder section on the concrete pier, using the temporary support bracket for stability, erecting girder sections at the opposite end of the span using the shoring towers for temporary support, and then completing the span with infill girder sections. Once the adjacent spans were installed, girders were erected from the double-cantilever girder sections to form 180-ft-long cantilevers projecting from the piers.

The shoring towers in the adjacent spans were equipped with hydraulic jacks that could raise or lower the adjacent bridge spans, which in turn affected the elevations of the ends of the cantilevers. This jacking system allowed precise elevation adjustment of the ends of the cantilevers to ensure the girder ends were properly aligned for the installation of the 140-ft-long keystone girder sections. The girders were installed slightly offset longitudinally from their final position to leave a gap for installing each keystone piece. The girders were placed on temporary low-friction polytetrafluoroethylene (PTFE) slide pads to facilitate the required longitudinal movement. With the necessary preparations

### Overcoming Fabrication Complexity

General contractor Alberici Constructors partnered with fabricator Industrial Steel Construction (ISC) on the project for three key strategic and economic reasons: 1) ISC is AISC certified, 2) it can perform large girder line assemblies under roof (thanks to its 900-ft-long shop bay and 100-ton-capacity crane) to ensure proper fit-up, and 3) its location in Gary, Ind., gives it access to Lake Michigan, which facilitates barge shipping.

With 112-ft-long haunch girders over the piers varying in depth from 10 ft, 6 in. to 18 ft, ISC not only employed vertical butt splices but also horizontal butt splices in the web for 45 out of the 75 girders on this complex project. Butt splicing is typically used to join two steel plates together, but for this project four separate 1-in.-thick steel plates had to be joined together to make a web plate for one girder. The longest girder line assembly involved five girder segments with a total length of 612 ft, which ISC accomplished under roof. This moved the schedule forward by at least three months, since these assemblies could be achieved inside during the winter months.

In addition to the plate girders, the project also involved several secondary steel members, such as 346 cross frames, 336 lateral bracings, and 24 diaphragms that had to be fabricated in tandem with the plate girders in order to deliver the steel to the site on time. Luckily, ISC was able to dedicate another entire shop bay to process these members.

ISC shipped 50 girders by barge, from Lake Michigan to the Illinois river to the Mississippi river to the Missouri river, and finally to the job site, which helped reduce land transportation costs. A total of 10 barges was sent to the job site with approximately five girders loaded on each barge, and the girders were erected directly from the barges. The other 25 girders and the secondary steel members were transported by truck and erected from rock causeways on either side of the river. The transportation costs incurred by the materials transported via land were offset by the lower cost of erecting from land-based cranes in lieu of barge-mounted cranes, which typically takes twice as long.

—Ankit Shah, Senior Project Manager, Industrial Steel Construction



above: The secondary structural steel contained 346 cross frames, 336 lateral bracings, and 24 diaphragms.

right: The contrasting framing schemes of the old and new bridges.

below: Children span the bridge's width on its opening day.

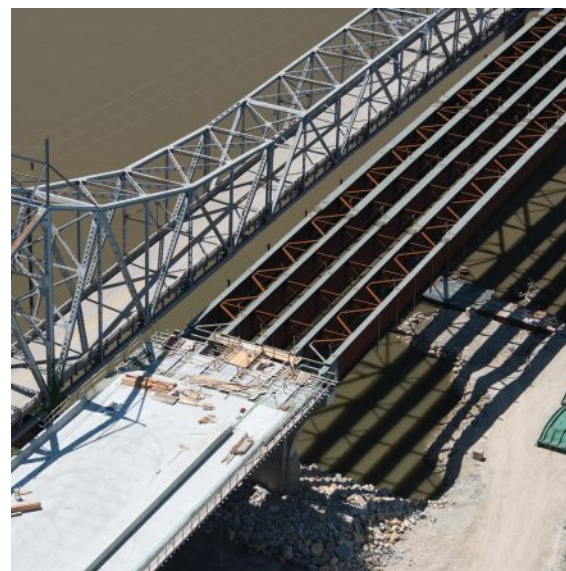

above and left: The bridge's superstructure is made up of 75 individual plate girders whose lengths vary from 100 ft to 140 ft and whose depths range from 18 ft at the support piers to 10 ft, 6 in. at the midspans.

complete, each keystone girder was lifted in place early in the morning. As the temperature of the steel increased throughout the morning, thermal expansion closed the gap left between girders, allowing ironworkers to bolt the girders together.

The entire project was performed without interrupting river or vehicular traffic, as the original bridge remained open during construction, and the new crossing accommodates a daily traffic volume of 13,000 vehicles. In April, the original bridge was demolished via synchronized demolition charges and its steel salvaged for reuse, perhaps as a future iconic steel structure. ■

**Owner**

Missouri Department of Transportation

**General Contractor**

Alberici Constructors, Inc., St. Louis

**Bridge Designer**

HDR Engineering, Inc., St. Louis

**Erection Engineer**

Ruby+Associates, Inc.,  
Bingham Farms, Mich.

**Steel Fabricator**

Industrial Steel Construction, Inc.,  
Gary, Ind. 



**COREBRACE**<sup>®</sup>  
SUPERIOR SEISMIC PERFORMANCE

**BUCKLING RESTRAINED BRACES...**

**...IN BRIDGES TOO!**

**Contact CoreBrace at:**  
5789 West Wells Park Road  
West Jordan, UT 84081  
801.280.0701  
www.corebrace.com  
info@corebrace.com

**Rigorous Analysis**

Fine-tuning the erection sequence and minimizing falsework required significant pre-planning by Alberici and sophisticated analysis from Ruby's engineering team, which performed a staged erection analysis using LARSA 4D bridge design software. This analysis allowed deflections of the steel to be accurately determined at each stage of construction, essential for ensuring proper fit-up of the steel during erection, developing the means for dimensional control, and allowing for critical girder stability checks. Due to their excessive weight—over 100 tons each—the steel plate girders were installed one at a time instead of in a more stable paired configuration. And the long cantilevers that resulted from un-shored erection of the 500-ft span also necessitated a rigorous stability review. Once confirmed in the staged erection model, girder stability was verified via empirical methods. In addition, the team used RISA 3D to design the flexible pier brackets, the hybrid shoring system, and the midspan girder support shores, and also used UT Bridge—a 3D finite analysis program developed by the University of Texas—to perform a validation review of girder stability.



**Automated Stair & Railing Layout**

**WWW.AUTOMATEDLAYOUT.COM**

**603-402-3055**

# A Bridge Replacement in Four Parts

BY JAKE WILLIAMS, PE, AND CHRIS KELLEY, PE

Steel construction makes quick work of a quartet of neighboring bridge structures requiring replacement or repair in Memphis.



**Jake Williams** ([jwilliams@benesch.com](mailto:jwilliams@benesch.com)) is a senior project manager and **Chris Kelley** ([ckelley@benesch.com](mailto:ckelley@benesch.com)) is a project engineer, both with Alfred Benesch and Company.

**ASK ANY MEMPHIS COMMUTER** to describe I-240, and “traffic nightmare” would be a typical response.

Over the past six years, this corridor, which curls around the eastern side of the city and connects motorists to the Memphis International Airport, has been under constant construction. When the Tennessee Department of Transportation (TDOT) was faced with the urgent need to replace or repair four deficient structures all spanning I-240 within a quarter-mile of each other, shutting the Interstate down for weeks at a time to make it happen simply wasn’t an option. With traffic levels of approximately 180,000 vehicles per day, TDOT wanted this critical project, dubbed MemFix 4, completed quickly and with minimal impact to travelers—and structural steel was at the center of the solution.

The high seismic demands of the region, which is near the New Madrid Fault Line, had increased the urgency to replace or repair the four 58-year-old structures, including two bridges at the busy Poplar Avenue interchange; a Norfolk Southern Railroad (NSR) bridge that serves as a critical east-west connector over the Mississippi River; and the concrete Park Avenue bridge. Due to the complexity of this \$54 million endeavor, TDOT opted to use the construction manager/general contractor (CM/GC) project delivery method, which is designed to maximize efficiency and enable close collaboration between the owner, design team, and contractor during design and construction.

MemFix 4 is only the second project in Tennessee to be delivered using the CM/GC method. More traditional design delivery methods, such as design-bid-build and the use of concrete, would have required three years to construct. CM/GC, coupled with the use of structural steel and accelerated bridge construction (ABC) techniques, including new substructures constructed under traffic and modular bridge superstructures, made it possible to complete the project in just 19 months. These methods also reduced the impact to vehicular and rail traffic and resulted in minimal change orders at a signifi-



Kiewit Infrastructure South Co.

cantly lower level than the industry average—especially on a project of this size.

Again, implementing a steel solution was integral to the success and constructability of the project. Limited space and weight constraints made concrete an unsuitable option. And with an increased chance of impact from earthquakes and other seismic activity, steel was the ideal choice because of its lightweight, slim nature and structural integrity.

### Tight Space

For the NSR bridge replacement portion, the key challenge was overcoming tight spatial constraints. The railroad’s *Public Projects Manual* listed five acceptable concrete superstructure options for the bridge—none of which could accommodate the site constraints, which included limits on how high the bridge could be raised due to the adjacent profile as well as clearance requirements for the highway bridge beneath (i.e., it could not be lowered). Conventional concrete beams would not have been shallow enough to fit, making steel the optimum choice. Structural steel framing—in the form of welded steel plate girders with bolted diaphragms, walkway brackets, and steel floor plates, with a total steel weight of 950 tons and a maximum span of 88 ft—allowed the designers to

above: The MemFix 4 project involved repairing or updating four deficient bridges over Interstate 240 on the east side of Memphis.

below: A temporary shoofly structure was constructed adjacent to the existing NSR bridge, then the permanent steel superstructure supporting a ballasted track was erected on the shoofly alignment.

All images credited to Alfred Benesch & Company except as noted.





above: Sliding in the second NSR bridge. This replacement railroad crossing comprised a total steel weight of 950 tons and a maximum span of 88 ft.



left: The "bridge farm" where the Poplar Avenue bridges were built along the side of I-240.



.....

meet the railroad's span length and height criteria while reducing bridge mass for seismic design, further minimizing demands on the supporting bridge components and thus improving cost-effectiveness. These inherent design efficiencies of using steel reduced construction costs when compared to concrete girders.

The NSR corridor, which has both a mainline and a siding track, required continuous operation of both tracks, allowing only two 12-hour interruptions to a single track at a time. To replace this bridge, a temporary shoofly structure was constructed adjacent to the existing bridge, comprised of temporary concrete piers supported by micropile foundations to minimize ground disturbance, then the permanent steel superstructure supporting a ballasted track was erected on the shoofly alignment. With trains traveling on the shoofly structure, the old bridge was demolished and the new substructures built. The two new, 1,100-ton superstructure sections were then slid 35 ft into place, one track at a time, during two weekend Interstate closures.

#### Two of a Kind

When it came to the two concrete Poplar Avenue structures (one with four spans and other with five), their condition was poor enough that repair wasn't an option—and again, concrete wasn't viable as a replacement option. Instead, a two-span steel girder design for both bridges satisfied current seismic codes and significantly improved

Following construction at the bridge farm, the Poplar Avenue structures were rolled two miles down I-240 to the project site on self-propelled modular transporters (SPMTs).



A close-up look at the ends of one of the Poplar Avenue modules. A total of 900 tons of weathering steel was used to create low-profile superstructures stretching to a maximum span of 150 ft.

.....

the long-term reliability and flexibility of the corridor. A total of 900 tons of weathering steel was used to create low-profile superstructures stretching to a maximum span of 150 ft, meeting severe grade modification restrictions and accommodating a widened corridor. On average, opting for steel instead of concrete reduced the depth of each structure by about 30% and the weight by more than half.

The superstructure for each bridge was split into four modular units and constructed off-site two miles down the road on temporary substructures at ground level in an open section of roadside right-of-way known as a bridge farm. The units were then rolled down I-240 itself on self-propelled modular transporters (SPMTs). Using steel not only made the bridges structurally feasible, but steel also required fewer, lighter



## *THE SAFEST HOSPITALS USE SIDEPLATE*

### SidePlate Brings Your Project:

- Field Bolted Construction
- Schedule Savings
- Design Flexibility
- Greater Open Space
- Simple Future Expansion
- Significant Steel Savings



Contact us for a FREE evaluation of your project



[www.sideplate.com](http://www.sideplate.com)  
949-238-8900  
[info@sideplate.com](mailto:info@sideplate.com)



above and below: The Poplar Avenue roll-ins required only two 56-hour closures of I-240, significantly less time than would have been required had the bridges been built in place using concrete.

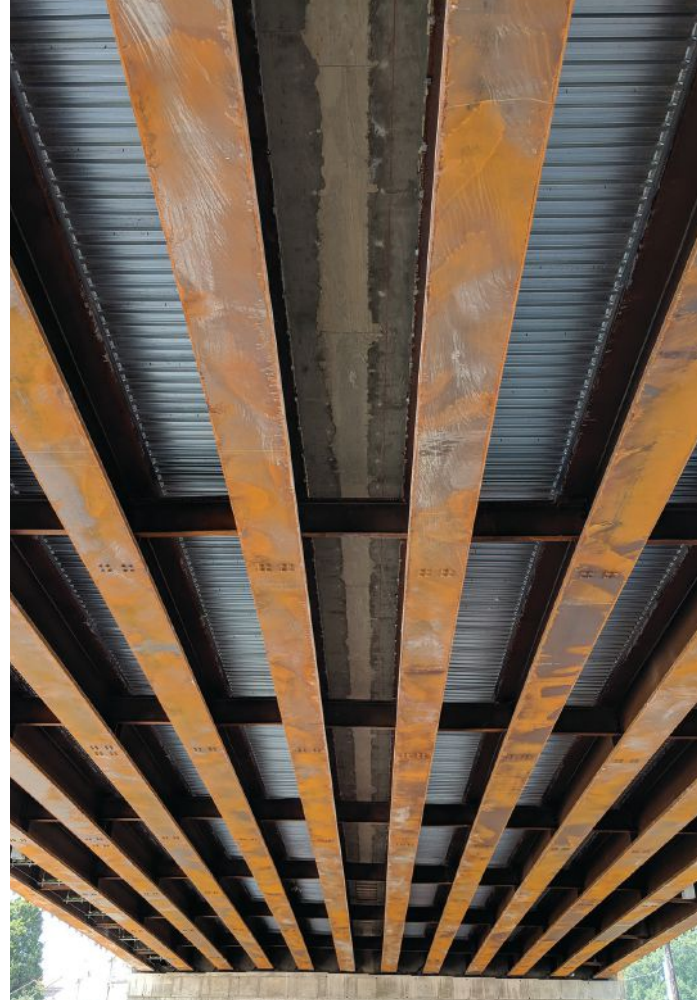

above: On average, opting for steel instead of concrete reduced the depth of the Poplar Avenue structures by about 30% and the weight by more than half.  
below: After demolishing the existing bridges, the modular superstructure units—with the heaviest being six girders wide, 150 ft long, and 550 tons—were slid into place.



pieces to assemble and move. The roll-ins necessitated only two 56-hour closures of I-240, significantly less time than would have been required had the bridges been constructed in place using concrete. In addition, custom steel bearings eliminated the need to adjust the existing pier cap elevations while also transmitting significant seismic loads, and additional lateral framing elements mitigated lateral load path discontinuities imposed by the superstructure construction techniques. The existing bridges were successfully demolished and the modular superstructure units were slid into place, the heaviest unit being six girders wide, 150 ft long, and 550 tons.

#### Critical Casings

The fourth structure on the MemFix 4 project was the Park Avenue Bridge, adjacent to the NSR bridge. While the bridge has a concrete superstructure, it was preserved using a novel steel foundation retrofit design to optimize its seismic behavior. Essentially, all 16 existing concrete columns were retrofitted with 3-ft, 9-in.-diameter, 3/8-in.-thick steel casings to improve their ductility and bring them into conformance with current design standards without adding weight or rigidity to the structure.

By addressing the area's seismic design criteria, further complicated by tight spatial constraints, steel was in the driver's seat for successfully completing the quartet of critical infrastructure components that made up MemFix4. Fully completed in July, the project successfully transformed I-240's aging infrastructure with minimal impact to the travelling public and improved the highway's—and Memphis'—mobility for years to come. ■

#### Owner

Tennessee Department  
of Transportation

#### Structural Engineer

Alfred Benesch and Company

#### Construction Manager and General Contractor

Kiewit Infrastructure South Co.

#### Steel Fabricator and Detailer

W&W/AFCO Steel,  Little Rock, Ark.

# High Strength Weathering & High Strength Steels



**Central Steel Service, Inc.**

*Serving Our Customers Since 1981*

P.O. Box 1506 • Pelham, Alabama 35124  
205.664.2950 • 800.868.6798 • f: 205.663.3391  
[www.centralsteelservice.com](http://www.centralsteelservice.com)

#### GRADES

**A588 • A847  
A572-50 • A709-50  
A709-50W**

#### PRODUCTS

**PLATES • ANGLES  
FLATS • CHANNELS  
ROUNDS • PIPE  
SQUARES • TUBING**

## FREEDOM

**...TO PUT YOUR  
EQUIPMENT  
WHERE YOU  
WANT IT!**

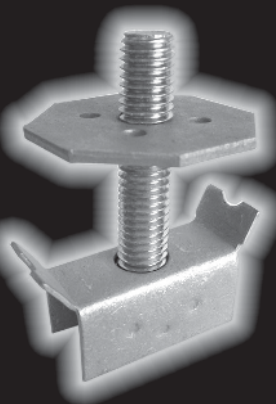

Shown Above  
P/N: GM-1/2x3

Sometimes, the best place to attach safety equipment and control panels isn't the most convenient. You might have to drill, cut, or weld to make everything fit securely. **Not anymore!** You have the freedom to put your stuff where you want it by creating mounting points using our model GM mounting fasteners.

- ➔ With the GM, you can attach your equipment to a secure grating surface with hand tools.
- ➔ Install the GM from above the grating with no drilling, cutting, tapping or welding. (Just like a G-Clip!)
- ➔ The GM resists 1000 pounds of upward pull force without deforming.

Mount your equipment right where you need it with GM mounting fasteners. Available in 316 stainless steel or galvanized carbon steel.

**Call Toll-Free:  
800-227-9013**



P.O. Box 6438, New Orleans, LA 70174  
[www.gclips.com](http://www.gclips.com) • Email: [sales@gclips.com](mailto:sales@gclips.com)



A unique facility at Purdue University gives decommissioned steel bridge components a second life as learning tools.

# Wanted: Old Steel Bridges

BY GEOFF WEISENBERGER

All photos except for page 55: Geoff Weisenberger



**Geoff Weisenberger**  
([weisenberger@aisc.org](mailto:weisenberger@aisc.org)) is senior editor of *Modern Steel Construction*.

**JUST A COUPLE OF MILES** to the southwest of Purdue University's main campus in West Lafayette, Ind., is an open-air site sporting an impressive array of complete steel bridges and bridge components.

Part training facility, part teaching and research lab, and part antique steel bridge museum, this is the school's Center for Aging Infrastructure (CAI), a 22-acre site focused on studying and improving the country's infrastructure, especially as much of it is reaching an advanced age and in need of rehabilitation and repair. By far the facility's largest user is another Purdue initiative, the Steel Bridge Research Inspection Training and Engineering Center, or S-BRITE.

The name says it all. While S-BRITE serves as a hands-on, real-world lab of sorts for Purdue graduate and undergraduate engineering students alike, it also exists to provide training for bridge inspectors. Open to the elements, students and others can study the bridges and bridge sections in their "natural habitat" (though no longer having to endure vehicular or train traffic) during daylight hours and at night, in any weather, and in all seasons.

So how did these various bridge assemblies get here? They didn't just fall out of the sky.

Robert Connor, Purdue's Jack and Kay Hockema Professor of civil engineering and director of CAI and S-BRITE, notes that all have been donated and transported by various departments of transportation (DOTs).



above: The first statistically significant probability of detection (POD) study for visual inspection of fatigue cracks was conducted at S-BRITE. Weathered painted specimens are shown on the left, and uncoated weathered specimens are on the right.

below: A portion of a former fascia girder over an Interstate now illustrates how a bolted girder splice can be used to repair a fracture.



“It’s all word of mouth,” he explains. “When we hear about a bridge being taken out of service and think it would be a suitable addition, we contact the DOT and work to get it here.” (Connor is also AISC’s 2018 T.R. Higgins Lectureship Award winner. To see his Higgins Lecture “Towards an Integrated Fracture-Control Plan for Steel Bridges” from the 2018 NASCC: The Steel Conference in Baltimore, visit [aisc.org/2018nasconline](http://aisc.org/2018nasconline).)

Portions of steel bridges—and three complete ones (the longest is 91 ft!)—are positioned throughout the site on gravel pads and concrete slabs, with roughly 75 pieces in all. A complete 65-ft span railroad bridge here, a section of a highway bridge there, the effect is almost that of a steel bridge sculpture garden. And there’s plenty of room for more, with new specimens being donated periodically. S-BRITE’s most recent acquisition is a complete 1930s riveted railroad bridge donated by Norfolk Southern that used to carry rail traffic for the Wabash Railroad.

“It has cracks, weld repairs, and quite a bit of corrosion,” says Connor. “A great specimen for us.”

This is a portion of an all-welded 1956 railway bridge from the Pennsylvania Railroad in New Jersey. The girder sustained a brittle fracture at a detail now known to be susceptible to constraint-induced fracture (CIF). The girder sports a complex bolted repair. Though unrelated to the fracture, holes were drilled to arrest the fatigue cracks at the top of the vertical stiffener.



Other recent finds include multiple plate-girder assemblies. One is a bay of two girders that are still connected via X-bracing, a second is a portion of a multi-span bridge, and yet another comprises two units complete with pins and hangers. There are plans to place a concrete deck with some defects on the latter to train inspectors in sounding a deck. In addition, the center has also acquired failed joints from the collapsed I-35W bridge in Minneapolis—and in fact, S-BRITE is the holder of the only remaining major components from the bridge.

And in addition to the new specimens, the site has recently gained a new building intended to house specimens that should be kept out of the weather, such as fractured girders and a U10 joint from the I-35W bridge. Researchers at Purdue built a steel frame from which the U10 joint is suspended, in several pieces, to illustrate the relative positions of the components prior to the collapse. This greatly aids when explaining to students and visitors the mechanics of the failure and gives insight into forensic investigations.



left: A 90-ft-long pony truss obtained from China Township, Mich. The structure contains considerable corrosion damage and includes many welded repairs.

above: A portion of a BNSF bridge originally built over the Mississippi River at Burlington, Iowa, in 1893. This floor beam joint contains many repair welds and strengthening members.

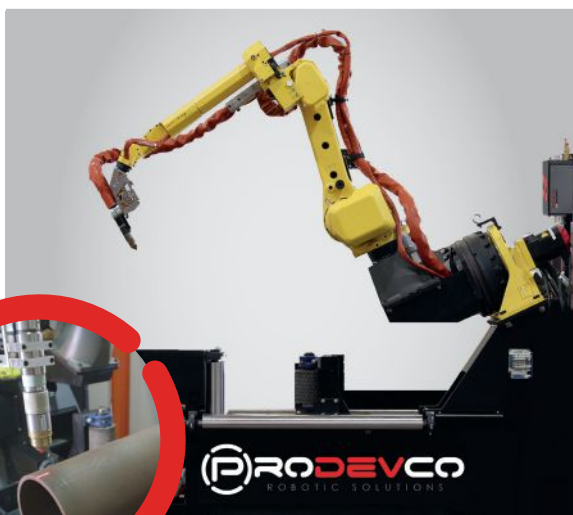

PRODEVCO ROBOTIC SOLUTIONS OFFERS THE PCR42  
ADVANCED ROBOTIC PLASMA STEEL CUTTING SYSTEM

Plasma cutting of standard structural steel profiles, and round tubes from 4 to 26", cuts copes, notches, holes and weld preps, splits beams, and scribes and marks on all four faces of H-beams, channels, angles and HSS using automated robotic technology. The all-in-one system reduces fabrication time, man-power and materials to meet everyone's goal: lower manufacturing costs.

.....

Asked if there's anything of particular interest that Connor is keeping an eye out for, he says, "We could really use a few very large gusset-plated joints. While we have a complete truss and a few joints, some very large, even shingled, truss joints would be wonderful to have. We are also looking to obtain about 600 ft of railroad track. We have erected signals and hope to install the track to show students how block signals work and track bed is constructed, and many other aspects related to railway engineering."

There isn't a "typical" day for site. Connor notes that he uses it for his graduate steel design and fatigue and fracture classes and also in undergraduate steel design curriculum. With this usage and that of other professors and other training, the site might host visitors a few times a month to every day for three or four weeks at a time.

When it comes to professional training, the most typical is geared toward inspecting bridges for fatigue; in fact, the center just wrapped up a course in early August. It's been valuable for inspection training not only in terms of helping inspectors develop a keen eye for defects—"We have a treasure map for the cracks," laughs Connor—but also in teaching more general lessons.

"Inspection is not an exact science as people think," he notes. "If you talk to three different inspectors, you will likely get three different answers." In addition, he stresses that inspectors also learn that inspection shouldn't just be performed on a routine schedule.

Please visit us at  
FABTECH Chicago Nov. 11-14 2019 booth # 1462  
www.prodevcoind.com 1-877-226-4501 ext 204



above: A group of engineers is dwarfed by 23-ft-deep girder sections from the Dresbach Bridge—provided by the Minnesota DOT and Ames Construction—which carried I-90 across the Mississippi River between La Crosse, Wis., and Dresbach, Minn.

right: The Indiana Railroad provided several components, including this pin-connected lower chord section, when the White River railroad bridge near Elnora, Ind., built in 1899, was replaced in 2015.



S-BRITE has also worked with the Army Corps of Engineers—a partner with the center—for the last two years. As a matter of fact, the Corps also plans to do all of its fracture-critical training at S-BRITE in the future.

“One of the main Corps personnel, Phil Sauser, had a great comment,” recalls Connor. “He said, ‘You could spend 20 years inspecting steel bridges and not see all the details and defects that you could see at S-BRITE in two hours.’”

Besides actual steel specimens, S-BRITE also provides living, breathing expertise in the form of the Distributed Expertise Network (DEN), a “Jedi Council” of 11 bridge experts—some at Purdue but most elsewhere—who have extensive knowledge in bridge-related topics ranging from coatings and corrosion to non-destructive testing to field instrumentation and monitoring and much more. The idea is to provide “on call” expertise as needs or questions arise and establish S-BRITE as a go-to resource for complex issues related to steel bridges. (For a full list of the DEN personnel and their areas of expertise, visit [engineering.purdue.edu/cai/sbrite](http://engineering.purdue.edu/cai/sbrite).)

How did S-BRITE become a reality? It started in the early 2010s with a collaborative effort between the Indiana Department of Transportation’s Joint Transportation Research Program and Purdue, with both entities recognizing that the concept of an outdoor research and education facil-

## PROJECT: Historic Bridge Recovery

**CHALLENGE: No Welding Permitted**  
Rehab of a 115-year-old bridge into a pedestrian walkway without environmental contamination to the river below

**SOLUTION: BeamClamp®**  
Selected for their ease of installation to connect new decking to existing structure without welding



### BeamClamp® Connectors

- Clamps directly to existing structure
- Hot-Dip Galvanized corrosion-resistant finish
- Guaranteed loading and factor of safety
- No drilling or welding required
- Easy installation



LNA Solutions, Inc.  
100 Stradtman Street  
Buffalo, New York 14206  
tel: (888) 724 2323  
email: [inquiries@LNAsolutions.com](mailto:inquiries@LNAsolutions.com)  
[www.LNAsolutions.com](http://www.LNAsolutions.com)



above: One of the more unique specimens at S-BRITE is this large nested roller bearing from one of the main river piers of the I-35W bridge.

below: A close-up of the bolted splice used when S-BRITE engineers re-erected the Indian Trail Bridge.



above: S-BRITE also contains many miscellaneous bridge components, such as these from the I-35W collapse.

## The B-Team

S-BRITE also makes house calls (bridge calls, actually) thanks to its field vehicle.

Remember the A-Team van? Think of that but newer and sporting Purdue black and gold instead of black with a red stripe. And instead of a weapons cache and other strike team-type equipment, the 2008 Dodge Sprinter 3500 acts as a mobile lab outfitted with data acquisition equipment, tools, and materials to allow the A-Team—er, a rotating team of research engineers assisted by Purdue civil engineering students—to perform research, testing, and investigation of steel bridges across the country. The lab on wheels, which has performed work in more than a dozen states, provides space for planning, discussion, and preliminary analysis at the site or on the way.

“The vehicle has been to several states for many, many projects,” says Connor. “The furthest project was here in California and the closest bridge was here in Lafayette, on I-65. The most recent long-haul trip was to Wyoming for a project to monitor the vibration of four high-mast lighting towers throughout the state over a period of about two years.”

The experience is mutually beneficial as it exposes the students to real-world field testing and monitoring. And in some cases, the field work is directly related to a particular student’s research project. While many of the projects are planned well in advance, the vehicle is also equipped for rapid and emergency response and can potentially mobilize within hours of being notified. In one such case, Milton-Madison Bridge over the Ohio River experienced a bearing failure during construction. The vehicle and its team were on-site within 12 hours at the request of the engineer. In another scenario, an I-465 bridge was exposed to a propane tanker explosion. The team mobilized the night of the accident to inspect the bridge to ensure public safety.





ity could have tremendous benefits to and a positive impact on bridge design, construction, and inspection. The idea caught on and today, S-BRITE is supported by several states through Transportation Pooled Fund Project TPF-5 (281). Civil engineering graduate students helped design and build the first portions of the facility, and later a consultant was hired to perform the full site design, with a general contractor completing the final construction.

In the mid- to long term, Connor hopes to eventually incorporate classroom and laboratory space for on-site training. Further down the road, he anticipates that other users will expand the breadth of the research and training to include buildings and façade systems. But for now, he says, bridges are a full-time job and the next step for the center is to form a corporate sponsor/advisory panel, noting that the industry has expressed interest and has been very supportive in recognizing the value of the program.

“You don’t want to just find a bridge in service, take a bunch of photos, then throw it away,” he says. “Instead, why not seize the opportunity for training and research using the real thing?” ■



Purdue University

Failed joints from the collapsed I-35W bridge in Minneapolis on display in a new building intended to house specimens that need to be kept out of the weather.



## BENT ON SATISFACTION

### 11 Bending Machines

Easyway and Hardway: Beams, Tubes, Angles, Tees, Channels, Flats, Pipe & Rail

### Sheet/Plate

Shearing (to 1/2" x 20'), Forming, Rolling (to 1 1/4"), and Coning

### 6 Press Brakes

1000 Ton x 30'	750 Ton x 24'
400 Ton x 23'	3-225 Ton x (10', 12', 14')

### CNC Machining

### Quality

WhiteFab's patented structural bending process minimizes deformation and provides smoother curvatures. Each bent section is verified for accuracy along its arc.

### Facilities

170,000 sq. ft. of production area, under roof

**"IF QUALITY IS WHAT YOU NEED,  
LET WHITEFAB TAKE THE LEAD"**



**Phone 205-791-2011**  
**Fax 205-791-0500**  
**E-mail: sales@whitefab.com**  
**Web: www.whitefab.com**

# Bridging Bolivia

BY GEOFF WEISENBERGER

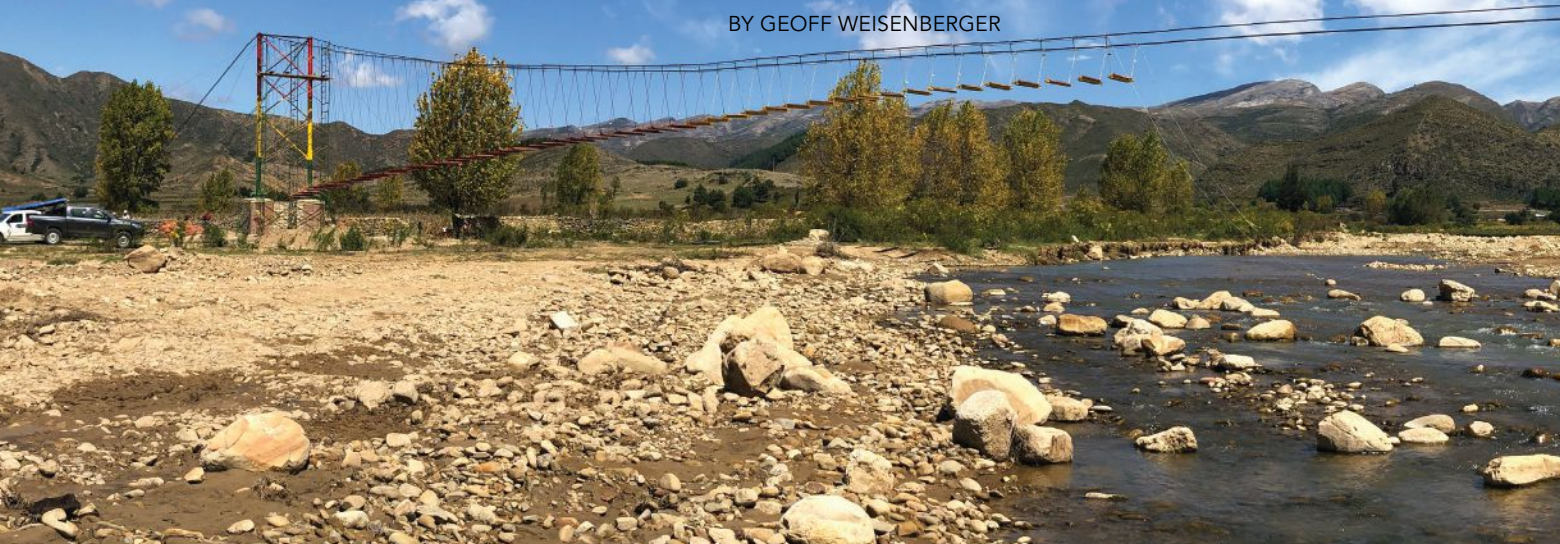

**FOR YEARS**, the National Steel Bridge Alliance (NSBA), AISC's bridge division, has promoted the proliferation of structural steel bridges across the U.S.

And more recently, it has been involved in bridge building on a much smaller—but nevertheless equally important—scale. Since 2016, it has partnered with Bridges to Prosperity (B2P)—a nonprofit organization whose mission is to build footbridges for isolated, typically poor communities around the world—on three separate occasions to provide Central and South American villages with safe passage over treacherous waterways.

While the first two bridge projects (in 2016 and 2018) were in Panama, NSBA's most recent project with B2P, which was built this past April, took the team to the highlands of Bolivia. There, near the town of Azurduy at an elevation of around 8,000 ft, ten volunteers and three B2P staff built the 361-ft-long, 3-ft, 7-in.-wide La Marca Suspension Bridge. The new span provides pedestrian access across the La Marca River to healthcare and schools, and also gives residents a route to bring their goods to markets on the other side. The NSBA team was comprised of David Alameda (Fought and Company, Inc.), Brad Dillman (High Steel Structures, LLC), Curt Duncan (Tennessee DOT), John Hastings (NSBA), Larry O'Connell (Stupp Bridge Company), Anthony Schoenecker (Modjeski and Masters), Craig Smart (HDR), Craig Stevens (Delaware DOT), Scott Walls (Delaware DOT), and Jackie Wong (a volunteer from California).

The team began their two-week Bolivian adventure in the city of Sucre, which sits at roughly 9,200 ft above sea level, then headed to Azurduy, which is the closest town to the bridge site, roughly a 15-minute drive away. As the crow flies, the two towns are less than 100 miles apart but thanks to the winding mountain roads, the drive takes about seven

It's a hat trick of pedestrian bridges for NSBA, as the group builds its third Bridges to Prosperity project, this one in the mountains of Bolivia.



hours. There, the team helped build the bridge along with members of the community, working 11 straight days. During their time off, they did some sightseeing and enjoyed the local culture—e.g., cheering at local football (soccer) games in the evenings.

NSBA's John Hastings led the team, and the Bolivia project was his second with B2P (though his first as an NSBA employee, as he represented the Tennessee Department of Transportation on last year's trip).

"I enjoy volunteering and building things, so this was an opportunity to do both of those and use my engineering skills to help a community have access to the basics," he said. "It was also an opportunity to build relationships with a diverse group of individuals in the bridge industry."

"I was honored to help provide a community with a piece of infrastructure that we take for granted here in the U.S.," noted Stevens. "The gratitude the community showed for the bridge we built was awesome and humbling."

"While working with community members, as they learned some of the skills we had to share, they were also happy to teach us their language and to share their culture and way of life with us," said Schoenecker. "This experience made the difference in that we didn't just build a bridge to cross a river, but that we built a bridge to connect a community."

"In our profession, we work on building bridges every day in some way, and this was that in its most basic form," recalled Wong. "It was a good reminder of why we do what we do: help move people and goods."

The La Marca Suspension Bridge is NSBA and B2P's longest bridge yet together, and the third-longest for B2P overall. The first trip, to Lura, Panama, in 2016, culminated in a 167-ft bridge. The second project took place last year in El Macho, Panama, and was nearly 100 ft long. Together, the three bridges serve more than 1,300 people. NSBA will sponsor another B2P project next year, also in Bolivia.

Following is a "slide show" from the trip. You can also view a video of the trip and project at [youtube.com/user/AISCSteelTV](https://youtube.com/user/AISCSteelTV). ■

Workers installing suspenders and cross beams from both sides of the 361-ft-long La Marca Suspension Bridge near Azurduy, Bolivia.



**Geoff Weisenberger** ([weisenberger@aisc.org](mailto:weisenberger@aisc.org)) is senior editor of *Modern Steel Construction*.



above: A local resident crossing the La Marca River during the dry season. During the rainy season, the river will flow at capacity for several months and will be impassable for days at a time.

right: Craig Stevens and John Hastings installing cross frames on the towers. The nearly 33-ft-tall towers were made from 10 3/4-in.-OD pipe and L3x3x1/2 cross frames, all connected with 3/4-in. A325 bolts.



above: Larry O'Connell locates the bracket to stop the columns once they are raised.



left: The tower, in position to be raised, with lifting devices installed on the scaffolding.

It's cable day once again! ("It seemed like it was every day," observed Hastings and Wong.) These are the wind guy cables (above). With help from the local community, the team members install the main cables (below).





left: The team pulls the main cables as tight as possible before using a winch to set the final tension.

above: All of the suspenders and crossbeams are installed. Next up: the decking.

below: Craig Smart, John Hastings, and a B2P representative working the decking toward the middle of the bridge.



### Built to Serve

Building bridges through local engagement, from regional governments to members of each partner community, Bridges to Prosperity (B2P) is committed to a sustainable model that puts the focus on people and the opportunities that make it possible for them to thrive. In 2019, B2P will complete 29 new footbridges, increasing its overall total to 314 bridges and impacting more than 1,149,000 people since 2001. To learn more about B2P, how you can become a volunteer or industry partner, or to support the mission, visit [www.bridgestoprosperty.org](http://www.bridgestoprosperty.org).



left: Crews working on decking from both sides of the bridge toward the middle.

above: With the decking finished, the crew begins to place protective fencing.

above: The colors for the bridge represent the stripes of the Bolivian flag.

right: The team gathers on the bridge on its inauguration day.

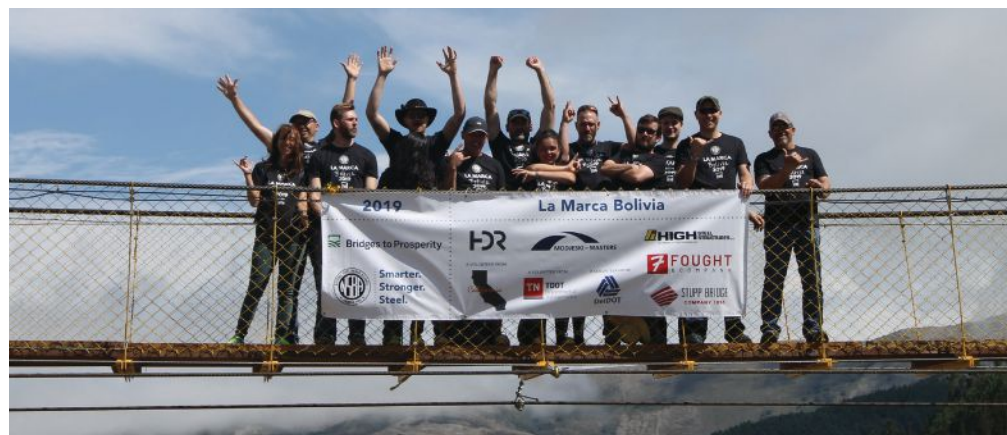

# new products

## FICEP KRONOS

FICEP Corporation has announced the expansion of the Kronos plate processor to incorporate a high-performance “Direct Drive” drilling spindle with an automatic tool changer to the system gantry. This configuration permits not only drilling but also other spindle operations such as tapping, countersinking, and more. The Kronos traveling gantry is available with multiple plasma and oxy-fuel torches to address users’ specific requirements. The plasma torch can also be configured with a programmable bevel head to generate weld prep configurations as required. The Kronos is available in different gantry widths up to 8 ft and lengths up to 40 ft.

For more information, visit [www.ficepcorp.com](http://www.ficepcorp.com) or call 410.588.5800.



## PEDDINGHAUS PEDDIASSEMBLER

Tack and weld options on the PeddiAssembler allow fabricators to stay more nimble with each future project. Bottlenecks at the welding process can be alleviated with the tacking function of this robotic beam assembler. Give welders a time boost by getting the most costly tasks finished prior to weld stand operations. The key to production is to only use shop cranes when absolutely necessary. Each time a piece of material is picked up and rotated with a crane, a business can lose money. The PeddiAssembler makes loading and unloading with fork trucks seamless in the shop flow.

For more information, visit [peddinghaus.com/peddiassembler](http://peddinghaus.com/peddiassembler) or call 815.937.3800.

## AUTOMATED LAYOUT TECHNOLOGY LIGHTNING RAIL

Automated Layout Technology, LLC, offers fabricators the newly designed Lightning Rail. The first automated marking machine created specifically for the layout of stairs and handrails, it can also be used for many other miscellaneous metal items. Forget about the countless hours spent with tape measures, squares, and soapstone. Your layout times will be reduced to a fraction of the time and can be performed right on top of the Lightning Rail table surface. The machine works with any DXF file, and the marking ink washes off quickly and easily. The compact design will fit easily into your existing fabrication environment, and units are offered in 4-ft and 8-ft widths, with a length of just under 30 ft.

For more information, visit [www.automatedlayout.com](http://www.automatedlayout.com) or call 603.402.3055.



## QNECT QUICKQNECT

Fabricators and engineers asked for efficient and optimized HSS vertical bracing, and Qnect has delivered. Engineer and optimize new connections including Shear-Plate-Single-Angle-Bolted-Bolted and Shear-Plate-Single-Angle-Bolted-Welded. As with other “Qnections,” simply fill in your preferences, select the members to connect, export to Qnect with Button #1, and import back to your Tekla model with Button #2. Speed is always our friend. With Qnect, steel just got smarter.

For more information, visit [www.qnect.com](http://www.qnect.com) or call 413.387.4375.

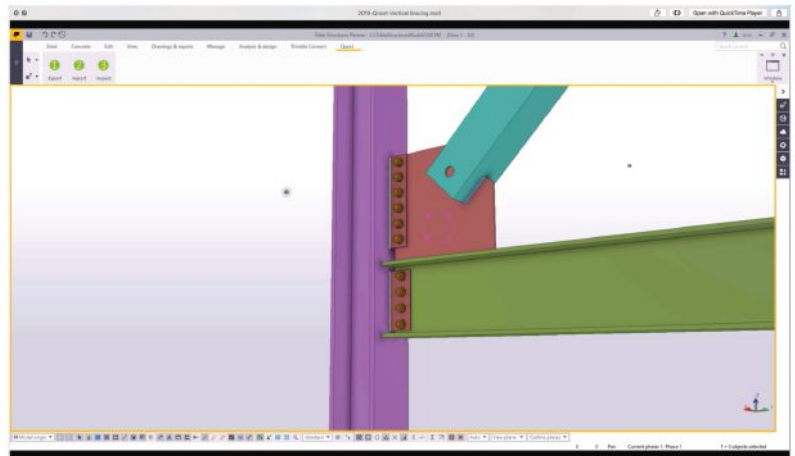

## VOORTMAN V807 ROBOTIC THERMAL PROFILE PROCESSOR

The new Voortman V807 robotic thermal profile processor brings the versatility and capabilities of robotic plasma and oxy-fuel processing into a footprint reduced by more than 50%, and reduced labor costs thanks to fully automatic material handling. The V807 is designed to fit seamlessly in existing processing lines with an all-in-one frame for “single-drop” installation when using the roller feed measuring system design. A powerful cutting robot is attached to the innovative radial mount so all sides of the material can be reached. The V807 roller feed measuring system is ideal for both standalone configuration or connecting to an existing processing line to replace a less productive machine, and full automation with Voortman’s Multi System Integration is available as your capacity and business grows. If your current dated oxyfuel profile processing machine is failing to live up to expectations, you should see what your capacity and potential revenue could be with Voortman! Stock systems are available in North America.

For more information, visit [www.voortman.net](http://www.voortman.net) or call 708.885.4900.



## DAITO DCM1050

Daito’s DCM1050 is a multitasking machine combining a CNC drill (with three spindles), a CNC robotic copier for standard or complicated plasma cuts, and a marking machine for part number marking and welding/layout marking. Each drill has an automatic tool changer to cover tapping, milling, chamfering holes, and boring blind holes. The wide range of functions makes the DCM the most versatile machine for non-repetitive structural steel processing. Daito DCM: the machine of the future.

For more information, visit [www.daitousa.com](http://www.daitousa.com) or call 847.437.6788.

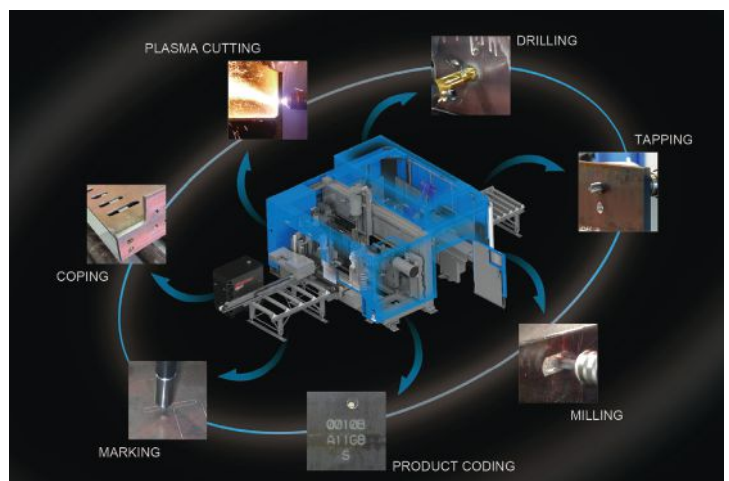

# Rake in the PDHs

with AISC Continuing Education.

## Fall Night School

### Fundamentals of Welded Connections

presented by Duane K. Miller  
Tuesdays at 7:00 p.m. Eastern  
Eight 90 minute sessions  
Earn up to 12 PDHs  
Class starts October 8!

[aisc.org/nightschool21](http://aisc.org/nightschool21)

## Fall Webinar Series

### Fundamentals of Connection Design

presented by Brad Davis  
Wednesdays at 1:30 p.m. Eastern  
Four 90 minute sessions  
Earn up to 6 PDHs  
Series begins October 23!

[aisc.org/webinars](http://aisc.org/webinars)



**Smarter. Stronger. Steel.**

American Institute of Steel Construction  
312.670.2400 | [www.aisc.org](http://www.aisc.org)



## ENGINEERING JOURNAL

## Fourth Quarter 2019 EJ Now Available

The fourth quarter 2019 issue of AISC's *Engineering Journal* is now available. You can access the current issue as well as past issues at [aisc.org/ej](http://aisc.org/ej). Below is a summary of this issue, which includes articles on the effects of detailing on cross-frame forces, evaluating fracture-critical members, gusset plate compressive capacity, and hollow structural section (HSS) research.

### Simplified Method to Determine the Effect of Detailing on Cross-Frame Forces

*Jawad H. Gull and Atorod Azizinamini*

The objective of this paper is to introduce different methods that can be used to calculate lack-of-fit effects for the steel dead load (SDL) fit detailing method at the total dead load (TDL) stage and the TDL fit detailing method at the steel dead load (SDL) stage. A comparison of different methods is done to recommend a single simplified method of analysis that can be used to calculate lack-of-fit effects for both SDL fit and TDL fit detailing methods with reasonable accuracy. Analysis methods are proposed to estimate the fit-up forces. The main conclusion of this research is that improved 2D grid analysis can be used to estimate lack-of-fit effects for both TDL fit and SDL fit detailing methods and can also be used to determine fit-up forces for connecting girder and cross-frame detailed with TDL fit.

### Simplified Transformative Approaches for Evaluating the Criticality of Fracture in Steel Members

*Robert J. Connor*

There has been considerable research and interest in the topic of fracture-critical members (FCM) during the past decade. As a result, the entire concept of what constitutes an FCM is being revisited, and many long-standing ideas and opinions related to this classification of members are being shown to be overly conservative. Significant advances in the understanding of fracture mechanics, material and structural behavior, fatigue crack initiation, fatigue crack growth, fabrication technology, and inspection technology have allowed other indus-

tries to address fracture—or, more importantly, control of fracture—in a more integrated manner. After years of research, new stand-alone AASHTO guide specifications that give codified direction on how to perform 3D system analysis to verify system redundancy, as well as guide specifications to evaluate internal member-level redundancy of mechanically fastened built-up members for both new and old bridges, have been proposed. Additional research demonstrating the benefits of exploiting the improved toughness of modern high-performance steel (HPS) grades has been completed. Through these advances, it is now possible to create an integrated fracture control plan (FCP) combining the original intent of the 1978 FCP with modern materials, design, fabrication, and inspection methodologies. Further, an integrated FCP provides economic benefits and improved safety to owners by allowing for a better allocation of resources by setting inspection intervals and scope based on sound engineering rather than based simply on the calendar. In summary, an integrated FCP encompassing material, design, fabrication, and inspection can ensure fracture is no more likely than any other limit state, ultimately allowing for a better allocation of owner resources and increased steel bridge safety. This paper summarizes some of the recent advancements related to the topic of the FCM and provides a suggested approach to providing more rational treatment of such members without compromising reliability.

### Empirical Formulation for Compressive Capacity of Gusset Plates

*Meisam Safari Gorji and J.J. Roger Cheng*

In this research, a powerful genetic programming (GP) tool is employed to develop an empirical formulation for compressive capacity of corner gusset plates using a comprehensive database collected from previously published test results and test-validated finite element models. The predictive model correlates the ultimate compressive strength of gusset plates with their mechanical and geo-

metrical properties. A comparative study is performed to evaluate the performance of the derived expression compared to the results of the well-known effective length factor method. The results indicate that the GP-based equation accurately estimates the compressive capacity of gusset plates and its prediction performance is significantly better than that of the current procedures.

### Steel Structures Research Update Advances in Design with Hollow Structural Steel Members

*Judy Liu*

Recent advances in design of steel-frame systems with hollow structural steel (HSS) members are highlighted. The featured work includes new and updated design guides that are co-authored by Jeffrey Packer and Jason McCormick. Dr. Packer's experimental, numerical, and analytical research informs the design of HSS for various loading conditions, with a bias toward code/specification-related issues and guidance for practicing engineers. Dr. McCormick's research on HSS members and connections ranges from research on steel HSS-based seismic moment frames to the use of innovative materials (e.g., polymer foam) to control the structural response of HSS members under seismic and wind loads.

Selected studies are featured along with a preview of the new design guides. Research on HSS columns under axial and lateral loads fills knowledge gaps in seismic behavior and design. Foam-filled brace and bending member experiments show improved seismic performance with a light-weight polyurethane fill. Field tests, laboratory experiments, and numerical modeling are used to study behavior and develop design methods for hollow and concrete-filled HSS subject to blast and impact loading. Research on single-sided fillet welds of HSS members leads to improved design recommendations. Improved design procedures are also recommended based on research on HSS connections that are in branch compression, near chord ends, or offset laterally.

# news & events

## STUDENT STEEL BRIDGE COMPETITION 2020 Student Steel Bridge Competition Rules Released

Each year, the Rules Committee creates a new mock scenario and set of rules for the Student Steel Bridge Competition (SSBC), keeping the competition challenging and exciting for the student teams.

This year's problem statement involves creating a steel bridge to cross a new waterway created by flooding along a recreational trail in Katy Trail State Park in Missouri. The bridge must be skewed, with the new waterway running parallel to the skew. As in past competitions, the rules include design, construction, equipment and safety requirements. After building their bridges, teams will perform vertical and lateral load tests.

Starting in early spring of 2020, 18 Regional Events will be hosted by universities and organizations nationwide. AISC will offer funding and assistance in finding sponsors for bridge teams and host schools. Depending on the number of teams at each competition, between one and four teams will move onto next year's National Finals, taking place May 22–23 at Virginia Tech in Blacksburg, Va.

For the complete problem statement, rules, and sponsorship opportunities, visit [aisc.org/ssbc](http://aisc.org/ssbc).



Steve Buhman, New Leaf Studio

### correction

In the “Cool Gateway” item in our August “What’s Cool in Steel” feature, we inadvertently left out one of the Greater Rochester International Airport canopy project’s two

AISC member bender-rollers. In addition to Greiner Industries, Chicago Metal Rolled Products also curved hollow structural sections (HSS) for the project.

## advertiser index

AISC	62	LNA Solutions	53
Applied Bolting Technology	24	MDX Software	35
Automated Layout Technology	43   60	Nucor Vulcraft-Vercro Group	13
Bull Moose Industries	back cover	Peddinghaus Corporation	2   60
Central Steel Service	49	Prodevco Robotic Solutions	52
Chicago Metal Rolled Products	insert	Profile Cutting Systems	25
Controlled Automation	12	PythonX, A Lincoln Electric Company	67
CoreBrace	43	Qnect	61
DuraFuse Frames	21	QuickFrames USA	31
FICEP Corporation	5   60	SDS/2	7
Grating Fasteners	49	SidePlate Systems	47
High Steel Structures	8	St. Louis Screw & Bolt	31
IES	11	Trimble	3
InfoSight Corporation	25	Voortman Corporation	37   61
Infra-Metals	15	Whitefab	55
Kinetic Cutting Systems	35		

## People and Companies

- The Steel Bridge Task Force Oversight Council of the **American Iron and Steel Institute (AISI)**, the **National Steel Bridge Alliance (NSBA)**, and the **American Association of State and Highway Transportation Officials (AASHTO)** T-14 Technical Committee for Structural Steel Design have named **Matthew H. Hebdon, PE, PhD**, assistant professor in the Charles Edward Via, Jr. Department of Civil and Environmental Engineering at **Virginia Polytechnic Institute and State University (Virginia Tech)** as the recipient of the **2019 Robert J. Dexter Memorial Award Lecture**. The program was instituted in 2005 in memory of **Robert J. Dexter**, an associate professor of civil engineering at the **University of Minnesota**, who was an internationally recognized expert on steel fracture and fatigue problems in bridges. Hebdon is also a **2019 AISC Early Career Faculty Award** recipient.
- **Zekelman Industries**, parent company of AISC member **Atlas Tube**, recently announced it will build the largest continuous electric resistance welding (ERW) tube mill in the world. The new mill will be located in Blytheville, Ark., adjacent to the existing Atlas Tube mill. Startup of the new mill is scheduled for September 2021. The mill, which will be the Atlas's fifth in the U.S., will produce hollow structural sections (HSS) in square, rectangular, and round shapes in sizes ranging from 8-in. square by 0.75-in. wall to 22-in. square by 1-in. wall. The largest rectangular section produced at the facility will be 30-in. by 14-in. by 1-in. wall, and the largest round section will be 28-in.-OD by 1-in. wall.

# marketplace & employment

## Structural Engineers

Are you looking for a new and exciting opportunity?

We are a niche recruiter that specializes in matching great structural engineers with unique opportunities that will help you utilize your talents and achieve your goals.

- We are structural engineers by background and enjoy helping other structural engineers find their "Dream Jobs."
- We have over 30 years of experience working with structural engineers.
- We will save you time in your job search and provide additional information and help during the process of finding a new job.
- For Current Openings, please visit our website and select Hot Jobs.
- Please call or e-mail Brian Quinn, PE (616.546.9420 or [Brian.Quinn@FindYourEngineer.com](mailto:Brian.Quinn@FindYourEngineer.com)) so we can learn more about your goals and interests.

*All inquiries are kept confidential.*

SE Impact by SE Solutions, LLC | [www.FindYourEngineer.com](http://www.FindYourEngineer.com)

Struggling to create compliant  
Welding Procedure Specifications?

## Atema can create compliant and user friendly WPSs.

Take a short survey and our  
Quality Systems Specialists will create  
easy-to-read WPSs with a fast turnaround.

[www.atema.com](http://www.atema.com)

316.861.3000

[info@atema.com](mailto:info@atema.com)



## QMC Contract Auditor

Quality Management Company, LLC (QMC) is seeking qualified independent contract auditors to conduct site audits for the American Institute of Steel Construction (AISC) Certified Fabricators and Certified Erector Programs.

This contract requires travel throughout North America and limited International travel. This is not a regionally based contract and a minimum travel of 75% should be expected.

Contract auditors must have knowledge of quality management systems, audit principles and techniques. Knowledge of the structural steel construction industry quality management systems is preferred but not required as is certifications for CWI, CQA or NDT. Prior or current auditing experience or auditing certifications are preferred but not required. Interested contractors should submit a statement of interest and resume to [contractor@qmconline.org](mailto:contractor@qmconline.org).

## LATE MODEL STRUCTURAL STEEL FABRICATING EQUIPMENT

**Controlled Automation DRL-336 CNC Beam Drill, 36" x 18", (3) 15 HP Spindles, Hem WF140 Tandem Saw, 2005 #29344**  
**Ficpep Gemini 324PG CNC Plasma Cutting System, 10' x 40', (1) Oxy, 15 HP Drill, HPR260XD Plasma Bevel Head, 2014 #28489**  
**Peddinghaus FPDB-2500 CNC Heavy Plate Processor, 96" Width, (3) Drill Spindles, HPR260 Plasma, (1) Oxy, Siemens 840, 2008 #27974**  
**Peddinghaus FDB-2500A CNC Plate Drill with Oxy/Plasma Torches, (3) Head Drill, 96" Max. Plate Width, 2003 #29542**  
**Peddinghaus PCD-1100 CNC Beam Drill, 44" x 18" Capacity, 13.5 HP, 900 RPM, (3) Spindles, 3" Max. Diameter, 13" Stroke, 2008 #29286**  
**Peddinghaus Ocean Avenger II 1000/1B CNC Beam Drill, 40" x 40' Max Beam, Siemens 840Di CNC Control, 2006 #29710**  
**Peddinghaus AFCPS 833A Revolution CNC Anglemaster Angle Line, 8" x 8" x 1", Loader, Conveyor, Fagor 8055 CNC, 2011 #29959**  
**Voortman V630/1000 CNC Beam Drill, (3) Drill Heads, Max Length 612", Power Roller Conveyor, 4-Side Layout Marking, 2016 #29726**

[www.PrestigeEquipment.com](http://www.PrestigeEquipment.com) | (631) 249-5566  
[sales@prestigeequipment.com](mailto:sales@prestigeequipment.com)

Interested in business development  
and making structural steel the  
material of choice?



now hiring in  
New York

to learn more visit [aisc.org/mynextcareer](http://aisc.org/mynextcareer)

## SALES OPPORTUNITIES

A leading distributor of structural steel is seeking Sales Engineers for their Connecticut facility. Interested individuals must have the ability to work in a fast paced environment, develop and grow customer accounts by means of cold calling and customer visits and work harmoniously with other departments to meet business and customer expectations. Excellent interpersonal and communication skills required. 4-year degree or equivalent work experience, time management, CAD & ERP experience required. 10% travel. Relocation benefits available. Submit resumes to [hr-ct@infra-metals.com](mailto:hr-ct@infra-metals.com).

## structurally sound



## STEEL STATION

**"THE YEAR IS 2082.** Humanity is at a crossroads. The air is clouded, the oceans have risen, and our biology has grown ambiguous. Technology continues to pervade our lives, enslaving us to convenience and the nirvana of instant gratification. The more we innovate, the more obsolete we become as our creations begin to supersede our primitive bodies."

While this might sound like the beginning of a science-fiction novel, it's actually the impetus for one of this year's Steel Design Student Competition winners: ARCH 2082, the creation of California Polytechnic State University (Cal Poly) student Andrew Swaim. Administered by the Association of Collegiate Schools of Architecture (ACSA) and sponsored by AISC, the competition encourages architecture students from across North America to explore the many functional and aesthetic uses for steel in design and construc-

tion. This year's competition included two categories. Category I—for which ARCH 2082 was an honorable mention—focused on transportation centers, and Category II was an open competition.

ARCH 2082, which responds to the dystopian future outlined above, is a massive transit center connecting autonomous drones, hyperloop vehicles, and even a space elevator that provides access to an in-orbit factory. The entire steel-framed structure, which also houses a shopping mall, a public museum, a hotel, and residential space, is clad in a layer of ethylene tetrafluoroethylene (ETFE) cushions that provide an insulative effect while also allowing natural light to reach the interior.

You can learn more about ARCH 2082, as well as all of this year's winners, in next month's issue (you can also view the winners at [aisc.org/student-design-competition](https://aisc.org/student-design-competition)).

# One Stop, Countless Solutions

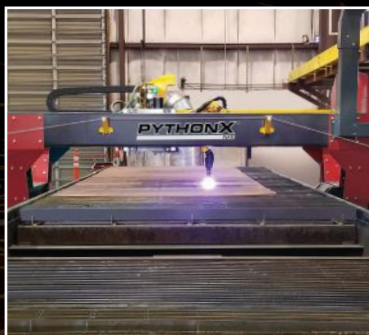

**Visit the world of Lincoln Electric Cutting Solutions at FABTECH, Booth A1457**

Over the past decade, we have combined the resources and expertise of several leading companies – PythonX, Inovatech Engineering, Vernon Tool, Torchmate and Burny Kaliburn – to create a single cutting group to address every possible customer need. From round pipe to 3D processing of structural sections to 2D plate processing, we're the one source and the one partner you'll ever need to address it all.

For more information on our revolutionary Cutting Solutions:

Call: 1-833-PYTHONX

Email: [info@pythonx.com](mailto:info@pythonx.com)



©2019 Lincoln Global, Inc. All Rights Reserved.



# HOLLOW STRUCTURAL STEEL TUBE FROM BULL MOOSE

**BUILD A  
LANDMARK.**



For projects that will stand the test of time, start with Bull Moose HSS tube.

Our direct-form manufacturing process enables us to use the highest grade HSLA steel...and form it directly into a tube.

With sizes ranging from 1.5" square to 18"x6", and wall thicknesses from 1/8" through 5/8", Bull Moose features one of the largest size ranges of HSS products in the industry.

*For strength, versatility and reliability, build with Bull Moose.*

## BULL MOOSE ADVANTAGES

- Strength ranges of 46 KSI to 110 KSI
- Tighter tolerances, sharper edges, and straighter tubes
- Widest variety of custom sizes/lengths, including metric
- In-line NDT weld testing available on all tube
- Readily available weathering grade steel
- Fast delivery with 8 domestic sites



**BULL MOOSE**  
For exceptional strength.

1819 Clarkson Rd.  
Chesterfield, MO 63017

**800.325.4467**

**BULLMOOSETUBE.COM**