

Modern Steel Construction

August 2020



RODGERS METAL CRAFT

ROBOTIC STEEL PRODUCTION



DILLAN RODGERS
CNC Operator

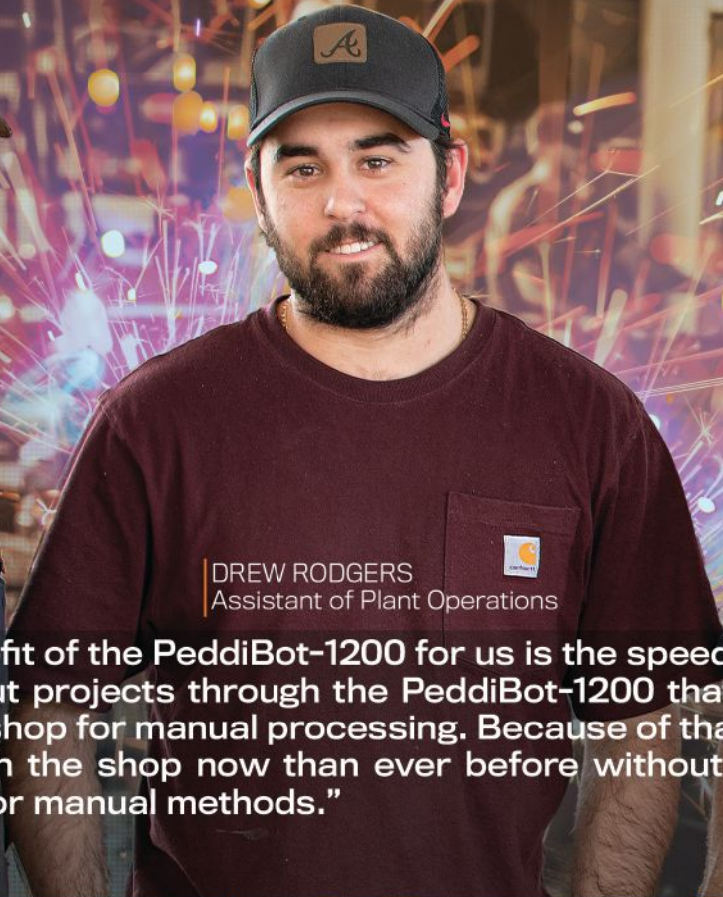

DREW RODGERS
Assistant of Plant Operations

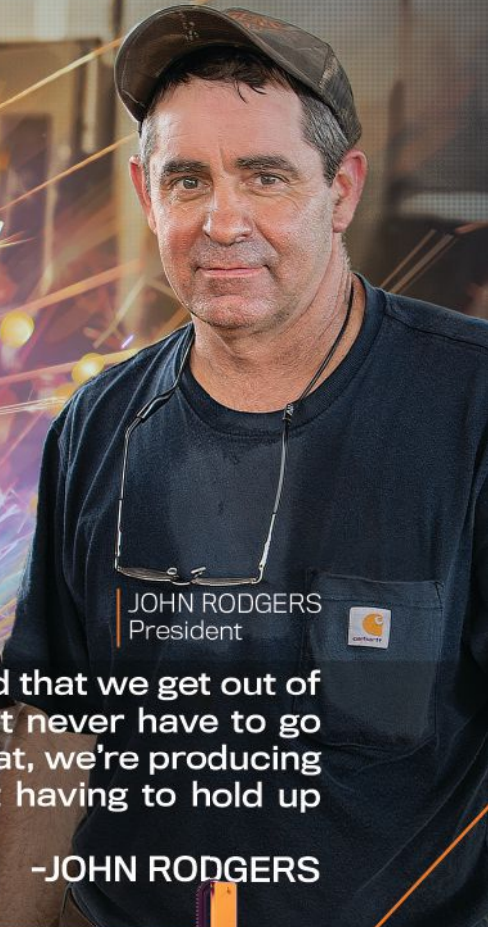

JOHN RODGERS
President

"A huge benefit of the PeddiBot-1200 for us is the speed that we get out of it. We can put projects through the PeddiBot-1200 that never have to go through the shop for manual processing. Because of that, we're producing more through the shop now than ever before without having to hold up production for manual methods."

-JOHN RODGERS



THE
PEDDIBOT-1200

Peddinghaus

STRONGER THAN
STEEL®

www.peddinghaus.com | info@peddinghaus.com | (815) 937-3800

Steel Fabricator's Competitive Advantage

Steel Fabrication Management Software That Can Help You Win More Business

Steel fabricators that use Tekla PowerFab avoid the need to add a margin of error to their competitive bids because they have a high degree of confidence in their cost estimates. PowerFab users are able to submit bids that are as competitive as possible while accurately meeting their desired profit margin.

Don't get left behind, visit teklapowerfab.com to learn all the ways Tekla PowerFab can help you increase your competitive advantage including improving bid accuracy.

Modern Steel Construction

August 2020

52

in every issue

departments

- 6 EDITOR'S NOTE
- 9 STEEL INTERCHANGE
- 12 STEEL QUIZ
- 62 NEWS & EVENTS
- 66 STRUCTURALLY SOUND

resources

- 65 ADVERTISER INDEX
- 65 MARKETPLACE & EMPLOYMENT



features

- 24 Serving Veterans**
BY RYAN CURTIS, PE
Historic congressional legislation allowed special funding for the design and construction of a steel-framed ambulatory care center serving the veterans of eastern Nebraska and western Iowa.
- 32 A Steel "Base-Lift"**
BY ERIC WHEELER, SE, TAYLOR DODSON, PE, AND STEPHANIE CHIRICUTA
An ambitious steel-framed rethinking of Willis Tower's ground-level presence was designed to elevate the famed tower's bottom to the status of its top.
- 40 Building a Community**
BY TRINA AGNELLO, PE
As a Charlotte community college grows in enrollment, steel helps the campus quickly catch up.

- 46 Campus Keystone**
BY ALLISON L. LUKACHIK, SE, PE
A new steel structure takes shape, transforming an underused sliver of land and unifying a busy corner of the University of Pennsylvania campus in West Philadelphia.
- 52 Forging the Future**
The final round of AISC's Forge Prize program resulted in three steel-framed visions of the future.
- 56 2020 Hot Products**
Hot offerings from The Virtual Steel Conference.

columns

steelwise

- 16 Heavy Lifting**
BY CHAD FOX, SE, PE
An expert provides tips on designing lifting devices for steel erection.

business issues

- 19 Engaging the C-Level**
BY ANNE SCARLETT
Want to sell services to executives? For starters, move beyond your assumptions.

field notes

- 22 Lifetime Advocate**
INTERVIEW BY GEOFF WEISENBERGER
Hollie Noveletsky's experience in the world of geropsychiatry and structural steel fabrication has made her a passionate advocate for the wellbeing of her patients, the business that her father started, and the steel industry as a whole.

ON THE COVER: VA facility design gets a makeover at a new care center in Omaha, thanks to ample AECS and an eye-catching curtain wall (page 24). (Photo: Ryan Curtis/LEO A DALY)

MODERN STEEL CONSTRUCTION (Volume 60, Number 8) ISSN (print) 0026-8445; ISSN (online) 1945-0737. Published monthly by the American Institute of Steel Construction (AISC), 130 E Randolph Street, Suite 2000, Chicago, IL 60601. Subscriptions: Within the U.S.—single issues \$6.00; 1 year, \$44. Outside the U.S. (Canada and Mexico)—single issues \$9.00; 1 year \$88. Periodicals postage paid at Chicago, IL and at additional mailing offices. Postmaster: Please send address changes to MODERN STEEL CONSTRUCTION, 130 E Randolph Street, Suite 2000, Chicago, IL 60601.

DISCLAIMER: AISC does not approve, disapprove, or guarantee the validity or accuracy of any data, claim, or opinion appearing under a byline or obtained or quoted from an acknowledged source. Opinions are those of the writers and AISC is not responsible for any statement made or opinions expressed in MODERN STEEL CONSTRUCTION. All rights reserved. Materials may not be reproduced without written permission, except for noncommercial educational purposes where fewer than 25 photocopies are being reproduced. The AISC and Modern Steel logos are registered trademarks of AISC.



Printed on paper made from a minimum of 10% recycled content.



YOUR VISION. OUR STEEL. NO LIMITATIONS.

Your projects depend on having the right products in the right places at the right time. The Nucor team is focused on providing you with high quality products and unmatched customer service. Our eight locations are conveniently located across the United States to meet the demands of your industry fast.

That's our promise – every ton, every time.

Learn more at www.nucortubular.com

NUCOR[®]
TUBULAR PRODUCTS

editor's note



One of the most common questions I hear is: What is the difference between AISC membership and AISC certification?

For structural engineers, AISC membership is almost a no-brainer. It's inexpensive and for most people, the benefits (discounts on publications, conferences, and seminars as well as access to thousands and thousands of pages of technical information) typically far outweigh the cost. If you're not currently a member, stop reading, visit aisc.org/join, and join right now!

But for fabricators, the calculation is different. Fabricator membership is far more expensive and the direct benefits don't always justify the cost. So why do they join? The answer is simple: To support the industry. AISC's membership dues directly help to support the development of AISC's Specifications, Manuals, and Design Guides. Membership dues subsidize scholarships, fellowships, and other educational programs. Dues underwrite essential research. And AISC membership helps to pay for AISC's marketing activities that promote the increased use of domestically fabricated structural steel. In other words, they join because they're not freeloaders and are willing to pay their fair share for the work AISC does to support the domestically fabricated structural steel industry.

AISC certification is different. While any domestic fabricator who wishes to support AISC's activities can become a member, certification instead is only awarded to those who can demonstrate they have the experience,

knowledge, staff, and procedures necessary to successfully fabricate a specific type of structure. Some fabricators become certified as a marketing tool to demonstrate their level of proficiency. Others become certified to bid on projects that require certification.

But the most successful fabricators look at certification as a business improvement tool. They know that the process of becoming certified—of examining their business practices, staffing, and procedures—helps to make them better fabricators. And recertifying, via an annual continuation audit, continues this improvement process (you can learn more about the details of AISC certification at aisc.org/certification).

In other words, AISC membership helps the entire steel industry while AISC certification demonstrates your company's commitment to quality and improvement.

For me, both are important. If you're a fabricator, I encourage you to be both a member and certified. And if you're a specifier, I urge you to always require certification—and when choosing a certified fabricator, pick an AISC member who supports not just their company's needs, but also the entire industry's.

A handwritten signature in black ink that reads "Scott Melnick". The signature is fluid and cursive, written over a white background.

Scott Melnick
Editor

Modern Steel Construction

Editorial Offices

130 E Randolph St, Ste 2000
Chicago, IL 60601
312.670.2400

Editorial Contacts

EDITOR AND PUBLISHER

Scott Melnick
312.670.8314
melnick@aisc.org

SENIOR EDITOR

Geoff Weisenberger
312.670.8316
weisenberger@aisc.org

DIRECTOR OF PUBLICATIONS

Keith A. Grubb, SE, PE
312.670.8318
grubb@aisc.org

PRODUCTION SPECIALIST

Erika Salisbury
312.670.5427
salisbury@aisc.org

GRAPHIC DESIGN MANAGER

Kristin Hall
312.670.8313
hall@aisc.org

AISC Officers

CHAIR

Jack Klump, Cianbro Fabrication
& Coating Corporation

VICE CHAIR

Stephen Knitter
Geiger & Peters, Inc.

SECRETARY/LEGAL COUNSEL

Edward Seglias, Cohen Seglias
Pallas Greenhall & Furman, PC

PRESIDENT

Charles J. Carter, SE, PE, PhD

SENIOR VICE PRESIDENT

Scott Melnick

VICE PRESIDENT

Lawrence F. Kruth, PE

VICE PRESIDENT

Mark W. Trimble, PE

Editorial Advisory Panel

Caroline R. Bennett, PE, PhD
University of Kansas

Amanda Dean, PE
Walter P Moore

Bryan Frazier,
Zalk Josephs Fabricators, LLC

Keith R. Griesing, PE
Hardesty and Hanover

Stephen Knitter
Geiger & Peters, Inc.

Advertising Sales

M.J. Mrvica Associates, Inc.
2 W Taunton Avenue
Berlin, NJ 08009
856.768.9360
mjmrvica@mrvica.com

Address Changes and Subscription Concerns

312.670.2401
subscriptions@aisc.org

Reprints

Erika Salisbury
312.670.5427
salisbury@aisc.org

INTRODUCING THE COREBRACE PLUGIN

VIEW PAGE 39



3D steel detailing software designed to optimize
your fabrication.

PVS Structures produces quality structural steel products for projects up to 20,000 tons around the world. Top of the line detailing and fabrication software like SDS/2 help make it possible. Learn how PVS Structures is boosting their fabrication efficiency with SDS/2 at SDS2.com/PVS-Structures.

SDS/2 customer Tom Horswill, Robot Technician at PVS Structures in Carter Lake, Iowa



A NEMETSCHEK COMPANY

CALLING ALL INNOVATORS!

If you recently worked on an amazing project that featured structural steel, we want to hear from you. Submit it for a 2021 IDEAS² award!

Entries close on October 15, 2020.

.....

enter now at aisc.org/ideas2



2020 IDEAS² National Award
**Mori Hosseini Student Union—
Embry-Riddle Aeronautical University,**
Daytona Beach, Fla.
Photo: Brad Feinknopf



2021
**IDEAS²
AWARDS**

Innovative Design in Engineering and
Architecture with Structural Steel

If you've ever asked yourself "Why?" about something related to structural steel design or construction,

Modern Steel's monthly Steel Interchange is for you!

Send your questions or comments to solutions@aisc.org.

steel interchange

All mentioned AISC codes and standards, unless noted otherwise, refer to the current version and are available at aisc.org/specifications. Modern Steel Construction articles can be found at www.modernsteel.com.

What Side of a Groove Weld Is Backgouged?

For the complete-joint-penetration (CJP) groove weld TC-U4b-GF shown on page 8-45 of the 15th Edition AISC Steel Construction Manual (and illustrated below), is the backing weld performed first or will it be performed last?

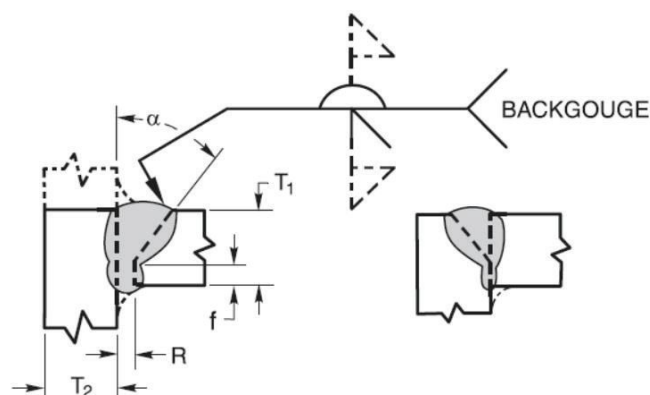

Fig. 1. Prequalified Welded Joint – Joint Designation TC-U4b.

Typically, the main part of the groove weld (side of the plate bevel preparation) is performed first. However, it is permitted to weld either side first. Prior to backgouging and placing the backing weld, the joint would resemble a partial-joint-penetration (PJP) weld. And similar to a PJP weld, the quality of the weld near the root would be uncertain. The root of the weld is then backgouged to sound metal and then backwelded. Backgouging is defined in AWS D1.1/D1.1M:2020 as “the removal of weld metal and base metal from the weld root side of a welded joint to facilitate complete fusion and complete joint penetration upon subsequent welding from that side.”

Carlo Lini, PE

Removing Requirements

The June 2020 Steel Interchange included a question and answer that looked at the removal of requirements in Section J1.10 from the 2010 AISC Specification for Structural

Steel Buildings (ANSI/AISC 360). The Q&A mentioned that the requirements were added to the Specification in 1942. Why did it take the task committee so long (from 1942 until 2010) to notice that these requirements were “arbitrary and cannot be supported by technical rationale”?

I cannot provide a definitive response as I was not around for much of the time frame involved in your question. All I can offer is my understanding of events.

When first introduced, high-strength bolts were used as a one-to-one replacement for rivets and had to be pretensioned. Over time, their design strength was increased but the pretensioning requirements remained. It was not until 1989 that research and increased comfort with snug-tight bolted joints caused the pretensioning requirements to be relaxed to some degree. So from the 1940s to 1989, it was simply not an option to use high-strength bolts that were not pretensioned. The answer provided in the previous Interchange item, while correct, only tells part of the story.

The 1942 Specification required turned bolts, if bolts were to be used, because it directly prohibited “unfinished bolts” per Section 20(d). When high-strength bolts were introduced, they were all required to be pretensioned. In effect, this was a requirement for pretensioning.

In 1989, the requirement shifted from an indirect requirement for pretensioning to a direct pretensioning requirement. I suspect, but do not know for certain, that this was seen to be a conservative response to a change (the use of snug-tight conditions) as it related to a requirement that probably was not well understood.

From 1989 to sometime during the 2016 cycle, the provisions did not cause any significant harm or inconvenience and were not a priority for the committee. I recall that the committee was looking more generally at tensioning requirements, and someone questioned the current need for these requirements. As we investigated, we found that we could uncover no information related to these requirements and concluded essentially what is in the published response, that “these requirements were arbitrary and cannot be supported by technical rationale.”

I recollect that we found that the 1942 requirement originally came from a local building code—I believe in New York. I suspect the addition to the 1942 Specification probably felt to be a good idea since allowing bolts was a new practice that was viewed with a good deal of suspicion by engineers at the time. A similar thing likely happened in 1989; it was probably felt to be a good idea to err on the conservative side when snug-tight bolts were introduced.

Larry Muir, PE



Carlo Lini (lini@aisc.org) is AISC's director of technical assistance.

Devin Altman (altman@aisc.org) is a bridge steel specialist with NSBA.

Larry Muir is a consultant to AISC.

Intermittent PJP Weld Spacing

Is there a maximum weld spacing required by AWS for PJP welds?

I do not believe it is common to use intermittent PJP welds and do not personally recall ever seeing this done. However, intermittent PJP welds are permitted for certain cases. AWS D1.1/D1.1M:2020 states, in Clause 4.8.3: "Intermittent PJP groove welds, flare bevel, and flare-groove welds may be used to transfer shear stress between connected parts."

Clause 4.12 addresses built-up members and provides maximum spacing requirements of intermittent welds. Note that the 2020 version of D1.1 has moved some sections around. If you are working from an older copy of D1.1, you can find the requirements for built-up members in Clause 2.

Carlo Lini, PE

Chapter K Ductility Requirement

Some of the tables in Chapter K of the AISC Specification include the following ductility requirement: $F_y/F_u \leq 0.8$. A500 Grade C is the current preferred material specification for hollow structural sections (HSS) and has an $F_y/F_u = 50/62 = 0.806$. Is this acceptable?

Yes. I believe that everywhere the limit is provided in the AISC *Specification*, it is accompanied by a note that states: "Note: ASTM A500 Grade C is acceptable." The note was intended to address this concern.

Larry Muir, PE

Clarification on NSBA Splice Spreadsheet

I am having a hard time finding information on what the "deck casting" moment and shear are in the NSBA Splice Spreadsheet ([aisc.org/nsba/design-resources](https://www.aisc.org/nsba/design-resources)). Could you provide some clarification on this?

The deck casting moment and shear are the demands on the non-composite steel girder at the point of the splice from the deck pour sequence of the bridge, and are used to check against slip of the flanges and webs. The demand from the deck pour sequence on the non-composite section can hold control over the Service II demands in the final erected state of the bridge. AASHTO suggests looking at both deck casting and Service II in section 6.13.6.1. For flanges, AASHTO states: "The factored moment for checking slip shall be taken as the moment at the point of splice under Load Combination Service II, as specified in Table 3.4.1-1, or the moment at the point of splice due to the deck casting sequence, whichever governs." And for web splices: "The factored shear for checking slip shall be taken as the shear in the web at the point of splice under Load Combination Service II, as specified in Table 3.4.1-1, or the shear in the web at the point of splice due to the deck casting sequence, whichever governs." You may also want to refer to the NSBA document *Bolted Field Splices for Steel Bridge Flexural Members* as it provides these types of answers and more ([aisc.org/nsba/boltedfieldsplices](https://www.aisc.org/nsba/boltedfieldsplices)).

Devin Altman, PE



STEEL SOLUTIONS CENTER

Steel Interchange is a forum to exchange useful and practical professional ideas and information on all phases of steel building and bridge construction. Contact Steel Interchange with questions or responses via AISC's Steel Solutions Center: 866.ASK.AISC | solutions@aisc.org

The opinions expressed in Steel Interchange do not necessarily represent an official position of the American Institute of Steel Construction and have not been reviewed. It is recognized that the design of structures is within the scope and expertise of a competent licensed structural engineer, architect or other licensed professional for the application of principles to a particular structure.

The complete collection of Steel Interchange questions and answers is available online at www.modernsteel.com.

In these uncertain times, we proudly serve your essential business now and into the future.

INFRA-METALS

www.Infra-Metals.com



DELTA STEEL, INC.

www.DeltaSteel.com



With many locations to serve you:

- | | | |
|--------------------|---------------------|--------------|
| A | Wallingford, CT | 800-243-4410 |
| B | Langhorne, PA | 800-899-3432 |
| C | Baltimore, MD | 800-235-3979 |
| D | Petersburg, VA | 800-435-0850 |
| E | Atlanta, GA | 800-833-9175 |
| INFRA-METALS / IMS | | |
| F | Tampa, FL | 800-693-1361 |
| G | Hallandale, FL | 800-432-1146 |
| H | Marseilles, IL | 800-987-5283 |
| I | New Boston, OH | 877-741-8806 |
| J | Houston, TX | 800-324-0220 |
| K | San Antonio, TX | 800-292-5828 |
| L | Fort Worth, TX | 800-772-2762 |
| M | Cedar Hill, TX | 800-284-7321 |
| N | Chicago Heights, IL | 800-772-2762 |



Full Member

**CUSTOMER SATISFACTION
BUILT WITH STEEL**

steel quiz

Did you know AISC has a standard for designing nuclear power plants? We do! And it's the focus of this month's Steel Quiz.

See if you can answer the questions below based on our *Specification for Safety-Related Steel Structures for Nuclear Facilities* (ANSI/AISC N690-18), which, along with any other AISC specifications and standards mentioned in this month's Steel Quiz, can be found at [aisc.org/specifications](https://www.aisc.org/specifications).

- 1 True or False:** The AISC N690 *Nuclear Specification* is a standalone document that provides design requirements specifically for safety-related steel structures for nuclear facilities.
- 2** Define "safety-related" and explain the reason for the differentiation of requirements when compared to those specified for conventional steel structures.
- 3 True or False:** Steel used for pressure-retaining structures needs to be designed using AISC N690 because of the additional dynamic effects and fatigue implications.
- 4 True or False:** Flexural members within a safety-related nuclear facility must not be designed using the plastic section modulus because of the additional uncertainty introduced by inelastic material behavior.
- 5** A break in a high-energy piping system causing compartment pressurization, short-term high temperatures, and dynamic loads of reaction and/or impingement can be categorized as what kind of load?
- 6** A wide-flange beam whose design is governed by load effects resulting from jet impingement and pipe whip has a calculated ductility ratio of 11. Is the design of this member adequate for the impactive/impulsive force effects using inelastic analysis?
- 7 True or False:** When designing steel plate composite (SC) walls, it is acceptable to use a slender plate because the concrete provides enough stiffness for the wall to act compositely.
- 8** Explain the difference between the QA/QC requirements used in the nuclear industry compared to what is typically used in conventional building design.

TURN TO PAGE 14
FOR THE ANSWERS



STEEL SOLUTIONS
CENTER

No Shop or Field Welding! All-Bolted SidePlate Connections

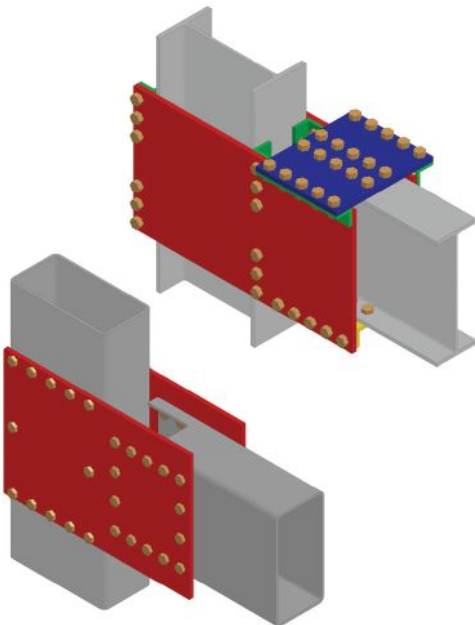

"This new all-bolted connection is something we are really excited about, SidePlate continues to innovate and our partnering relationship allows us to be on the cutting edge of connection technology."

-Marsh Spencer, President SteelFab Inc.

"The new all-bolted HSS solution enables our industry to reduce lead times for steel framed buildings. We look forward to seeing this innovation support a movement in the industry and are excited to be working with SidePlate to make this happen."

-Tom Muth, President of Atlas Tube

949-238-8900
www.sideplate.com

 **SIDEPLATE**[®]
POWERED BY **MiTek**

Sit. Stay. Seismic.

The new 3rd Edition [Seismic Design Manual](#) includes more than 800 pages of comprehensive design examples covering most types of steel and composite seismic force resisting systems, including $R = 3$ systems.



**RETRIEVE
YOURS
TODAY!**

\$100 Members | \$200 Non-Members
aisc.org/publications | 800.644.2400



Smarter. Stronger. Steel.

American Institute of Steel Construction
312.670.2400 | www.aisc.org

steel quiz ANSWERS

Everyone is welcome to submit questions and answers for the Steel Quiz. If you are interested in submitting one question or an entire quiz, contact AISC's Steel Solutions Center at 866.ASK.AISC or solutions@aisc.org.

- 1 False.** The *Nuclear Specification* is a supplement to the requirements found in the *Specification for Structural Steel Buildings* (ANSI/AISC 360). It modifies the provisions and takes exceptions as required for the nuclear power industry.
- 2** The preface to the *Nuclear Specification* provides a definition as it relates to structural steel: "Safety-related steel structures in nuclear facilities, which provide support and protective functions to equipment vital to the facility, are subjected to certain unique design forces and loads resulting from postulated accidents (such as turbine-generated missiles and jet forces from high-energy line breaks) and from extreme natural phenomena (tornadoes and earthquakes)." Conventional steel structures are not categorized as "safety-related" because their failure does not contain the same level of

impact on human life and the environment as can be found in a nuclear facility. The Nuclear Regulatory Commission provides the following definition: "In the regulatory arena, this term applies to systems, structures, components, procedures, and controls (of a facility or process) that are relied upon to remain functional during and following design-basis events. Their functionality ensures that key regulatory criteria, such as levels of radioactivity released, are met. Examples of safety-related functions include shutting down a nuclear reactor and maintaining it in a safe-shutdown condition."

- 3 False.** Pressure-retaining components such as pressure vessels, valves, pumps, and piping are expressly excluded from the *Nuclear Specification*. For the materials, design, fabrication, and examination of plate and shell component supports, readers

are directed to the requirements of Subsection NF of Section III of the *ASME Boiler and Pressure Vessel Code* (www.asme.org).

- 4 False.** The *Nuclear Specification* makes no changes to Chapter F of the *AISC Specification* and thus allows the use of the plastic section modulus.
- 5** This loading would be an example of an abnormal load, as indicated in Commentary Section NB2.4.
- 6 No.** The considerable influence of the jet impingement and pipe whip load effect suggests that load combination NB2-9 governs. Section NB3.14 allows members experiencing these load effects to be determined using inelastic analysis. The option found in Section NB3.14(b) can be used in this case, directing the designer to Table NB3.1, which shows the ductility ratio must be below 10 for open sections.
- 7 False.** Section N9.1.1(f) states that the face plates of SC walls must not be slender and directs the designer to the detailing requirements in Section N9.1.3. The Commentary states that this is to prevent the SC specific limit state of face plate local buckling from occurring before yielding in compression.
- 8** The nuclear industry specifies QA and QC differently than does typical building construction. The Commentary to Section NN explains it this way: "ASME NQA-1 (ASME, 2015b) stipulates the requirements for the establishment and execution of quality assurance programs for nuclear facilities. QA programs are pertinent to the designer, engineer, material supplier, fabricator, erector, and constructor, and each entity is required to establish such a program. The provisions of the *Nuclear Specification* are intended to supplement the NQA-1 requirements." Each level of a safety-related nuclear project pipeline must contain a rigorous QA/QC program. For other structural steel, QA and QC are specified in Chapter N of the *AISC Specification*.



QUICKFRAMES

**NO OFFENSE, BUT...
THESE AREN'T YOUR
GRANDPA'S
OLD STEEL
FRAMES**

Engineered Bolt-in Structural Frames
45K+ INSTALLS • ZERO RETURNS • SAME DAY SHIPPING*

DOWNLOAD PRICING & GET A FAST QUOTE
www.QuickFrames.com

*On most orders received by 11:00 am MST daily.

AISC

Night School

Industrial Building Design and Design of Non-Building Structures

presented by

Bo Dowswell, Robert MacCrimmon, John Rolfes,
and Jules Van de Pas

Tuesday nights
7:00 p.m. Eastern Time
90 minutes each

Upcoming Sessions:

8/4 Non-building Structures – Part 1

8/11 Non-building Structures – Part 2



Smarter. Stronger. Steel.

American Institute of Steel Construction
312.670.2400 | www.aisc.org

aisc.org/nightschool

steelwise

LIFTING DEVICES

BY CHAD FOX, SE, PE



Chad Fox (cfox@rubyandassociates.com) is a project manager with Ruby + Associates, Inc., Structural Engineers and leads Ruby's Heavy Lift Service. He is a member of the ASME BTH-1 Standard Committee.

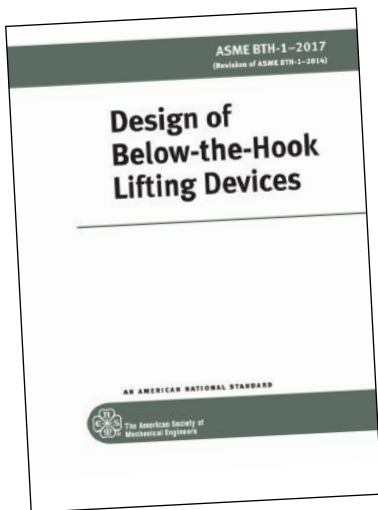

ASME BTH-1 provides guidance on designing heavy lift systems.

An expert provides tips on designing lifting devices for steel erection.

TECHNOLOGICAL ADVANCES IN MODELING have helped simplify the design and fabrication of more complex steel structures in recent years. Steel erection has also seen advancements, with cranes and other heavy-lift equipment continuing to increase in lifting capacity.

To keep pace with these developments, steel erectors are increasingly challenged to develop safe and efficient means and methods for lifting. This is where heavy-lift engineering, including the design of unique lifting devices, comes in.

Below the Hook

An essential tool set to assist with these challenges is below-the-hook lifting devices. Some of the most common types of below-the-hook lifting devices in steel erection include:

Spreader beams. As their name indicates, spreader beams are used to “spread” out the attachment points to a lifted load, typically using slings. This capability is particularly useful in lifting trusses or joists, where added compression due to rigging forces has the potential to cause buckling in the chord members.

Clamps. When lift points (typically lift lugs) are not possible and sling baskets or choker hitches are not safe, clamping fixtures, which rely on friction, can provide options for erection of unique fabrications. Section 4-9 of ASME BTH-1 (see Design and Construction Standards below) addresses clamping devices, requiring a minimum factor of safety of 2.0 on friction resistance.

Bolt-on attachment points. Repetitive objects can lend themselves to the use of reusable attachment fixtures, such as bolted lifting lugs. Since these are lifting attachments that can be removed and reused, ASME B30.20 (see Design and Construction Standards below) and BTH-1 consider these to be below-the-hook lifting devices. Lifting attachments that remain permanently attached to the lifted load are not subject to the requirements of B30.20 or BTH-1. Clarity in the delineation between lifting attachments and below-the-hook lifting devices will be included in the 2020 revision.

Triangular plates or frames. Triangles can provide a variety of functions in the lifting of objects. When crane capacity limitations require the use of more than one hook, triangles provide a convenient means to equalize loading between cranes. Triangles can also be used for the attachment of a third line, typically adjustable, which allows for geometry manipulation of the lifted object.

Design and Construction Standards

There are several resources that can provide guidance when designing heavy-lift systems. The American Society of Mechanical Engineers (ASME) has developed domestic industry standards for both the design (ASME BTH-1) and construction (ASME B30.20) of these devices. ASME BTH-1 was first published in 2005, and an updated version is set to be published later this year. Chapter 3 of the standard, “Structural Design,” may look familiar to structural engineers, as it largely follows the 1989 version of AISC’s *Specification for Structural Steel Buildings*. (Be aware that since 1989,

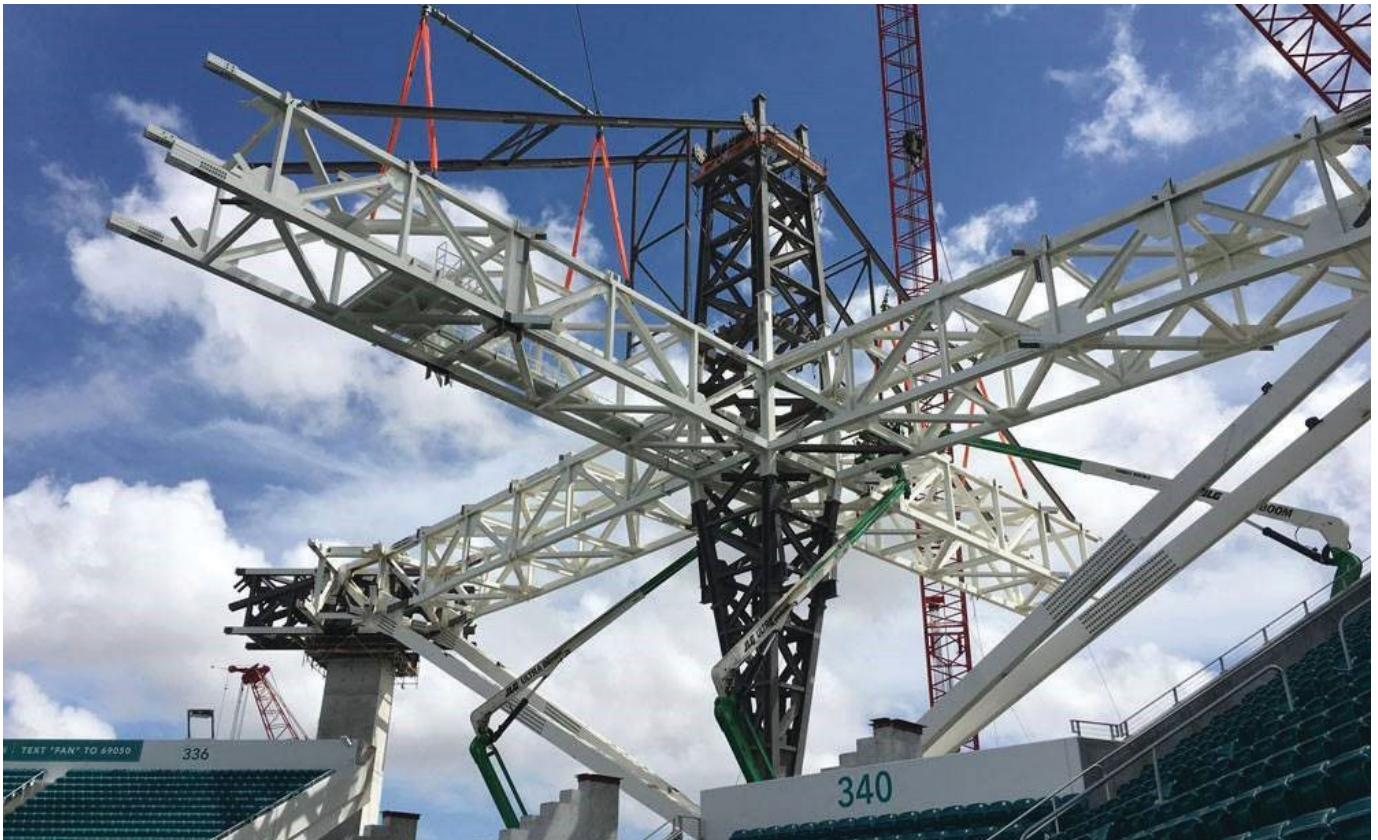

A spreader beam (above) and a multi-crane lift using triangular frames (right) were employed to erect the Hard Rock Stadium Shade Canopy in Miami Gardens, Fla. (The project was a 2018 AISC IDEAS² Award winner. See the May 2018 issue at www.modernsteel.com.)

the AISC *Specification* has been updated many times to correct issues.) However, designers should be mindful of some important differences between the two publications. Since ASME governs lifting devices and not building design, the ASME standard should govern. Here are the main differences:

1. **Safety Factor.** Lifting devices, for reasons such as lack of redundancy, dynamic loading, and a high risk to human safety in the event of failure, require safety factors higher than those found in the AISC *Specification* for the building design. Chapter 2 of ASME BTH-1 prescribes different safety factors based on Design Category (type of use) and Service Class (frequency of use).
2. **Pin Plates.** Pin plates, commonly known as lift lugs or pad eyes, are regularly used in lift devices for attaching rigging components such as shackles. BTH-1 includes an entire section (3-3.3) dedicated to their design. Many of the checks included differ from or are not included in the AISC *Specification*.
3. **CLTB.** Lift devices, typically known as lift beams, are subject to bending and require a reduction in buckling strength due to a lack of resistance to twist or lateral displacement at the ends of their unbraced lengths. The lateral-torsional buckling strength coefficient (CLTB) attempts to account for this reduction.
4. **Combined Normal and Shear Stresses.** Section 3-2.5 requires a combined normal and shear stress check based upon the Energy of Distortion Theory.





above: Lift beams were used for gantry crane erection at the Consumers Energy Pumped Storage Hydroelectric Plant project in Ludington, Mich.

below: A below-the-hook lifting device with identifying information per ASME B30.20 section 20-1.2.1



Clamping fixtures on the Interstate 94 Gateway Bridge arch section lift, a tied-arch bridge in Taylor, Mich.

5. Fillet Weld Load Direction Factor. ASME BTH-1, as of 2020, does not include the fillet weld directional strength increase included in AISC Specification Equation J2-5.

Another standard that covers lifting devices is ASME B30.20: *Below-The-Hook Lifting Devices*, first published in 1985. ASME B30.20 includes provisions for the marking, construction, installation, inspection, testing, maintenance, and operation of below-the-hook lifting devices, but refers to BTH-1 for their design. It should be noted that per B30.20, all welding should be in accordance with ANSI/AWS D14.1.

Load testing of below-the-hook lifting devices is of critical importance to ensure the device will lift its rated load, and ASME B30.20 Section 20-1.3.8.2 describes load testing requirements. And although B30.20 states that a load test “should” be performed, it is important to note that OSHA 1926.251(a)(4) states that special custom design grabs, hooks, lamps, or other lifting accessories “shall” be proof-tested prior to use. Both B30.20 and the OSHA standard specify that the load test shall be performed at 125% of the rated load, the lifting device shall be visually inspected following the test, and a test report should be developed and made available.

In addition, ASME B30.20 Section 20-1.2.1 states that below-the-hook lifting devices should be marked with the following identifying information:

- Rated load
- Manufacturer’s name and address
- Serial number
- Lifting device self-weight
- ASME BTH-1 Design Category
- ASME BTH-1 Service Class

Inspection requirements are described in Section 20-1.3.1, and Table 20-1.3.3-1 (“Minimum Inspection for Below-the-Hook Lifting Devices”) is particularly useful to spelling them out for designers.

Steel erectors face many challenges when building steel structures. But when designed by a qualified structural engineer with the guidance of ASME BTH-1, and constructed per ASME B30.20, lifting devices can provide safe and efficient tools to assist in development of practical erection solutions. ■

Want to sell services to executives?
For starters, move beyond your assumptions.

WITHIN ORGANIZATIONS, executive leadership is composed of those who possess decision-making authority, power, and influence.

Commonly coined the C-Suite, it often includes the CEO, CFO, COO, CMO, CTO, CIO, and so forth. Chief this and Chief that.

As business development professionals in the AEC world, on both the design and construction side, it can be tricky to navigate our way into the minds and hearts of these folks. After all, *cultures* vary. Some organizations encourage buying decisions at a range of levels, while others primarily make buying decisions at the topmost level. In addition, *structures* vary, ranging from hierarchical to flat. There is no general one-size-fits-all approach to reaching your prospect's decision-makers. And finally, *market sectors* vary. Your paths to decision-makers will change, depending upon if your target audience resides within the realm of corporate, academia, government, healthcare, and nonprofit.

In an effort to challenge my own assumptions on selling to C-Level decision-makers, I interviewed two trusted colleagues. John is the COO of a multi-office, international environmental engineering firm. He's no stranger to sales pitches from sub-consultants. The other colleague, Chris, is a top producing representative, focused specifically on C-Suite buyers. In this digital age, Chris especially has his work cut out for him, as he represents a Fortune 500 company offering among other things (gasp!) commercial printing solutions!

In short, here was my top takeaway from these conversations: *Senior leaders are human like the rest of us*. This nugget of truth is common sense, and yet some of us (present company included) find it intimidating to engage with them. But others, namely the consummate sales performers, view interacting with senior leaders as a golden opportunity!

I aimed to categorize and synthesize the insights from these two professionals in order to gain a better understanding of differences—and similarities—when pitching business to the C-Suite versus decision-makers at every other level.

From the Buyer

Here is John's (the CEO) advice.

1. When it comes to conversations:

In a first meeting with a C-Level executive, **begin with two to three minutes of small talk**. Don't just jump right in. Use that opportunity to become quickly attuned to their communication style, and then adjust to match. (Dominant, collaborative, introverted, etc.)

Keep content to overarching trends, not details. Just because someone is at the C-Level doesn't mean they know everything. In fact, the smart ones acknowledge that they don't know everything and are actually open to ideas and opinions.

business issues **ENGAGING THE C-LEVEL**

BY ANNE SCARLETT



Anne Scarlett is president of Scarlett Consulting, a Chicago-based company specializing in AEC-specific strategic marketing plans, marketing audits, and coaching. She is also on the adjunct faculty at Columbia College of Chicago and DePaul University. She can be contacted via her website, www.annescarlett.com.

business issues

Pay close attention to objections. Consultants need to balance what the prospect wants, versus what they think the prospect needs—and versus what they are selling, which may not be what the prospect either wants or needs!

Work your research into conversations. Weave in as much of your research as possible by framing your comments: “I see you are an xyz fan...” “I read your firm has an affiliation with...” “It was inspiring to see that your firm has such a commitment to the community...” etc.

Please don’t hard sell! I’m turned off by the sales approach. Ask me about my problems and use open-ended questions. Consultative-based selling works best for me.

In a networking scenario. At a networking function, ask some simple questions. “How’s business?” “Tell me about your company?” (Caveat: If it’s a prominent brand, then steer clear from questions where the answers are universally known due to vast media exposure.)

Regarding phone check-ins (personal touchpoints), I like check-ins. Alert me that you’re still there. Use a soft approach. Whenever possible, bring ideas and value. Say something like: “If you need something, I’m right here.” Obviously don’t be a pest, and yet don’t ignore me. Other good statements that resonate with me: “What does value look like to you?” “So what I’m hearing you say is...” “I want to be respectful of your time...”

Just because someone is at the C-Level doesn’t mean they know everything. In fact, the smart ones acknowledge that they don’t know everything and are actually open to ideas and opinions.

2. On written documentation:

If you need time to formulate a ‘solution’, then say, “I want to give you my very best thinking. Let me make sure I understand your challenges, and then I’ll get back with you on (specify a date).” Set the expectations on what they will receive and when they will receive it. “On Thursday, I’ll send you an outlined approach...” And then follow through!

3. When compiling fee proposals:

- A menu approach works well for me, so I can ascertain which elements are most valuable. (Author note: This can be tricky when you don’t believe your process can be easily deconstructed.)
- Assess the person to whom you are selling, and then incorporate their words/vision/etc. into your proposal.
- Demonstrate past results; articulate expected outcomes.

4. Other considerations:

I want to work with someone that:

- a. I trust.
- b. I like.
- c. Is easy, not complicated.
- d. Offers sound advice—keeping me out of trouble, or better yet, making me look good.
- e. Follows through. Your actions must align with your promises. For some business developers, it’s all about the chase, not about the deliverable. Not cool.

Biggest pet peeve: What *really* irritates me is when I pay a premium (which I’m personally often willing to do) and yet I don’t get premium value. This is a deal-breaker for future projects.

Magic formula when dealing with C-Level decision makers: There isn’t one! It’s a mistake to treat all C-Level people the same. We are individuals, and you simply can’t generalize.

Cost versus results/value/experience: I believe that many C-Level decision-makers still go for the lowest bid. (Author note: This was surprising and disconcerting!) That said, the best consultants solve problems and prove their worth. For me, personally, my selection is never about the fees.

From the Seller

Here are notes from Chris (global senior sales representative) on how to sell services to executives.

1. Be the person that others want to work with and buy services from. When it comes to dynamics and relationship-building:
 - **Be enjoyable and genuine.** Take your time. (Don’t rush to get to the sale.)
 - **Get them talking about themselves.** Once something unique is revealed, I make a mental note to reference it in the future. This keeps me memorable, especially in initial interactions.
 - **Respect them (and yourself).** Find a balance where you are respecting their position, but you are also asserting yourself to a place where they will listen to you. If you behave in a subservient manner, they will treat you as such. Intellectually, you deserve to have respect reciprocated.
 - **Do something that might engage the person.** Reflect on it later. If at first you don’t succeed, try, try again. I have a rule of three: Try three times. You don’t want to be too pushy; if you are not clicking with the person and yet you honestly feel you can add value, then you need to go a different route (perhaps weaving another person into the fold).
 - **Take care not to overstep boundaries.** Watch for subtle cues that indicate a possible breach.
 - **On days when you simply don’t have mojo, sit it out.** Select opportunities when you will put your best foot forward.
 - **As the selling cycle progresses (it can be long, especially in AEC) treat the person with warmth**—like a cousin or an old friend from college.

business issues

2. When it comes to selling:

- **Believe in the service you offer.** If you don't, it will be obvious.
- **Make sure that you stay laser-focused on how they will benefit and/or how your service will make them look good.** They must find it relevant.
- **When checking in (no more than monthly) try to offer content that is "watching out for them and their best interests."** Maybe it's something about their competitors. Maybe it's something about an industry trend that sparked your own interest. While she or he may already know this information, they seem to appreciate the outreach and the non-self-serving approach.

No Silver Bullet

I had hoped these two conversations would result in a silver bullet method for selling to the C-Suite, or at least some "Aha!" lessons to apply. For the most part, their insights were common-sense knowledge for someone with a depth of business development experience. That said, here are three final thoughts that you may find useful:

1. Could you conduct the same sort of informal interview with a key C-Level buyer (even if outside our industry) and/or someone who successfully sells to the C-level on a regular basis? If so, do it! It's fun, and you'd be surprised at how it may relax you as you move forward to market your company and yourself.
2. To squelch moments of intimidation, I plan to take Chris's advice, which is to remind myself: Executives were not always in this position. They rose to it, and they were likely once walking in my shoes.
3. Just *breathe*: The C-Suite is not all-knowing! They are humans, just like you and me. They deserve our respect and we deserve theirs. So get it done, and make it a mutual win-win! ■



Over the Top Pallet Wrap

The industry's toughest, most weather resistant pallet wrapping!

Call or email us your inquiry!
St. Louis Screw & Bolt

sales@stlouisscrewbolt.com

800-237-7059

Protects labels & custom tagging!

Lunch & Learn online...

Attend our bolting clinic, and we'll donate a meal to your local food bank.

Call for details.

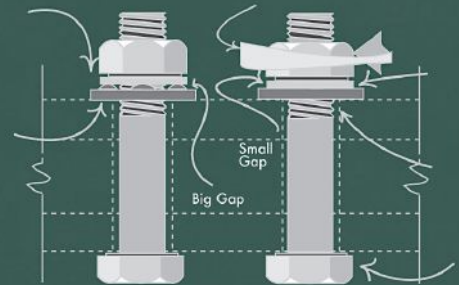

DuraSquirt® DTIs

the best way to bolt!

1 800 552 1999
1 802 460 3100

info@appliedbolting.com
appliedbolting.com

field notes

LIFETIME ADVOCATE

INTERVIEW BY
GEOFF WEISENBERGER



Geoff Weisenberger
(weisenberger@aisc.org) is senior editor of *Modern Steel Construction*.

To hear more from Hollie, visit www.modernsteel.com, where you can listen to the interview podcast in its entirety.

Hollie Noveletsky's experiences in the world of geropsychiatry and structural steel fabrication have made her a passionate advocate for the wellbeing of her patients, the business that her father started, and the steel industry as a whole.

WELCOME TO FIELD NOTES, *Modern Steel Construction's* podcast series, where we interview people from all corners of the structural steel industry with interesting stories to tell.

Our subject this time is **Hollie Noveletsky**, CEO of Novel Iron Works in Greenland, N.H., an AISC member fabricator (she's also an AISC board member). Hollie grew up around steel, visiting and working for her father's fabrication business before embarking on a career in nursing, specializing in geropsychiatry. She now runs the company her father started and is grooming her son to eventually take over for her—and she still practices nursing. Hollie talks about making her mark in the family business, applying her healthcare background to the manufacturing world, and how both roles have helped her company—and her home state of New Hampshire—weather the current pandemic.

Let's start with the nursing side of things. Can you tell me a little bit about your history in the profession and how you got into it?

I started out in college in engineering in the 1970s. At that time I was the only woman in the program, and there was no camaraderie. Everything was scaled. I can remember being so happy that I got a 9 out of 10 on a quiz—and I failed because it was scaled! And I went home one time to get my wisdom teeth out, and I had a student nurse and I thought, "Oh, I can do that!" So I transferred into the nursing program and it became my passion.

I started at Lawrence University in Appleton, Wis., and transferred to Rush University in Chicago, where I got my bachelor's, and from there I went to Boston University and got a master's in geriatric nursing and became a geriatric nurse practitioner. And after that—I like school if you can't tell—I went to Boston College and got my doctorate in nursing research and then after *that*, I went to MGH Institute of Health Professions in Boston and got a post-master's certificate in psychiatric nursing and combined the geriatric and the psyche and became a nurse practitioner specializing in home care for people with dementia.

Wow! So you have an extensive history in nursing, and now you're the CEO of a steel fabrication business. How on earth did that happen?

Well, my dad started the company back in 1956, and I, my sister, and my cousins all worked in the business growing up. We were the blueprint girl, the blueprint boy, the errand girl, and so on, and then while I was in nursing school, I worked in estimating and the computer room, inputting data, so I've always been in the company on some level.

And then the last couple years that my dad was alive, I would have coffee with him every day, and we would talk about his philosophy on business and how it's evolved as well as how the steel industry has evolved. So I always knew I'd be here—and I always *was* here on some level—but it became full-time after his death in 1999.

Was he supportive of your career in nursing, or did he have hopes that you'd start working full-time for Novel right from the get-go?

My dad was the best. He was he was my biggest supporter and he always said I could be anything I wanted to be when I was a little kid. I was the first in my immediate family to graduate college. So anything that had to do with education, he was very supportive of. And while he was working on the company leadership transition, he told me that all I really needed to know is how to read a financial statement. And how to fire somebody. And also, don't mess it up! That was one of his "Ralph-isms" and he had a bunch of them that would always stick with you. He also told me that if everybody likes you, you're doing something wrong, because at times throughout life you're going to have to draw a line. You have to make a stand for what you think is right or wrong. And when you draw a line, somebody's always going to be on the other side.



So obviously you learned the business from your father, and I understand your son is eventually going to take over. Are you giving him the same advice your father gave you? Are there "Hollie-isms?"

It was a hard transition for me because my father was an extrovert and I'm an introvert, and people would come to me all the time and say, "Your father would be doing it this way." And it took a little while to realize that I wasn't failing, I just wasn't him and they needed me to be him. But if I was him, I wouldn't be true to myself. So I tell my son you have to make it your own. Make the business *yours*, put *your* own mark on it, bring *your* strengths to it, because they're not the same as mine and mine weren't the same as my father's.

What's the biggest challenge with running a family business?

Family. [laughs] It's a huge responsibility running a family business. We're three generations into it now, and many of our employees have worked for us for two or three generations, so now they're family to us. It's sometimes hard to draw a line between family and employee, because I know three generations of their families.

Right, I would imagine one of the interesting elements of a family business is that the "family" becomes much larger than you ever thought it was going to be.

Yes, it does, and it just keeps expanding. My father used to say in business, you no longer need a business degree, you need a psych degree because it's all about managing the various personalities.

That falls perfectly into your realm of expertise! On that note, do you apply anything from your nursing background to your role in the fabrication world?

When I first started here full-time, I knew I didn't have the technical background that many people in our industry had, but I needed to make a mark so I looked at nursing, knowing that it is a profession of advocacy. We advocate for patients. So I thought, "Well, I can apply that to steel." I can advocate for steel. Foreign trade was a big issue at the time, so that became my focus, the political aspect, advocating for structural steel. It also gives me balance because if we don't get a job, it's not life-threatening.

How has COVID-19 affected business?

It hasn't affected our bidding but it has affected our production, because as our knowledge of COVID evolved and the list of symptoms increased, I would monitor anyone who called in sick and I would call them up and ask them what their symptoms were, or I would walk the shop and see if anyone had symptoms and if they had even a slight symptom, I would enforce the two-week quarantine period, which is down to a few days now.

Luckily, when they were talking about shutting down the state, I actually texted Governor [Chris] Sununu and said, "Please keep us open. There are three fabricators in our state and between us, you'll keep over 300 people off of unemployment." And we were able to stay open. People were even saying because we kept such a tight eye on everybody and every symptom, some felt even safer here than at home.

Have you been doing any COVID-related work outside of the shop?

Yes, the state has a program called the New Hampshire COVID Alliance Senior Support Team. As you know, COVID is having the worst effect on our long-term care facilities. So the program coordinates with DHHS, and we monitor facilities for outbreaks and PPE needs. We make sure that if a facility does have an outbreak, they're getting the proper guidance. And then the governor also set up the Governor's Office for Economic Recovery and Relief, where \$1.25 billion of federal money came into the state for COVID relief, and he asked me to be on the stakeholders advisory board, so I have been participating in that. We listened to people from the community and different sectors of industry to get their input on financial impacts from COVID and being closed, and then we made recommendations to the governor on how that money should be distributed. ■

Historic Congressional legislation allowed special funding for the design and construction of a steel-framed ambulatory care center serving the veterans of eastern Nebraska and western Iowa.



Serving Veterans

BY RYAN CURTIS, PE



Ryan Curtis (rbcurtis@leoadaly.com) is a senior structural engineer and project manager with LEO A DALY in Omaha.

CONGRESS HAS CHIPPED IN for a new Veterans Affairs facility in Omaha.

The 144th Congress passed the “CHIP IN for Vets Act” in 2016 that authorized the Department of Veterans Affairs (VA) to carry out a pilot program that may accept donations from non-federal entities to help fund construction projects on VA campuses.

This landmark legislation allowed LEO A DALY to enter a first-of-its-kind, public-private partnership to design an \$86 million Ambulatory Care Center on the Omaha VA Medical Center (VAMC) campus. The architectural and structural design included multi-story curtain wall blast-hardened facades, architecturally exposed structural steel (AESS) framing members, vibration-designed operating room structural bays, soil-nail walls, and varying types of foundation systems serving multiple types of structures.

The building comprises approximately 160,000 sq. ft on three levels, as well as a mechanical penthouse. It includes eight primary care units, a specialty care unit, an ambulatory surgery suite, radiology facilities, and a dedicated women’s clinic. There are multiple



left and below: The new Ambulatory Care Center on the Omaha VA Medical Center (VAMC) campus comprises approximately 160,000 sq. ft on three levels, as well as a mechanical penthouse. It includes eight primary care units, a specialty care unit, an ambulatory surgery suite, radiology facilities, and a dedicated women's clinic.

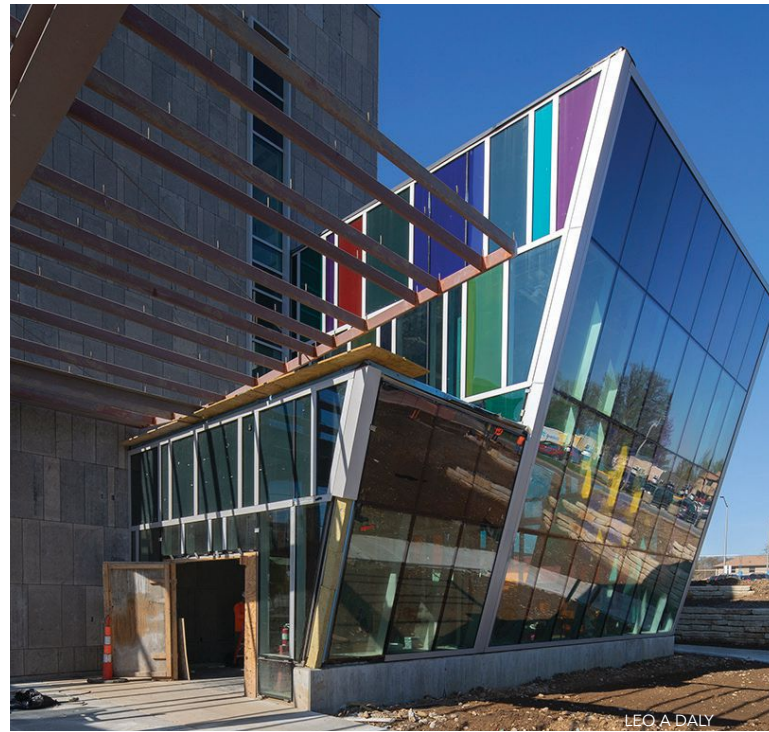

rooftop gardens for the occupants, and the new facility connects to the existing hospital building via a single-story pedestrian bridge. LEO A DALY architects and engineers began the design process in the summer of 2017 and construction started in the spring of 2018, with substantial completion targeted for later this summer.

Super and Sub

The superstructure consists of structural steel framing—approximately 1,400 tons in all—with a concrete-filled metal deck floor system: 2-in. composite deck with 3½ in. of normal-weight concrete topping. The majority of beams and columns are wide-flanges, though hollow structural sections (HSS) were employed extensively within much of the building footprint to

reduce the impact on the programmed spaces. Tapered wide-flange shapes and HSS members were used for many of the exterior AESS members.

Headed studs were placed in the floor beam and girder framing for composite action, joining the steel frame and concrete deck system. Lateral wind and seismic force-resisting systems were made of steel moment frames with rigid beam-to-column connections varying from flange-plated fully restrained moment connections (bolted), extended bolted end-plate fully restrained moment connections, and directly welded-flange fully restrained moment connections.

The substructure was built as a deep-foundation system using auger cast-in-place (ACIP) piles, extending an average of 80 ft below ground, that developed gravity capacity through



above: The main canopy structural system, 40 ft wide by 100 ft long, consists of wide-flange columns and built-up tapered WT members that vary from 24 in. in depth at center to 12 in. deep at the ends.

below: A structural model of the building, which incorporates 1,400 tons of steel in all.

skin friction against underlying soil stratum. To support the exterior wall construction at ground level, reinforced concrete grade beams span from pile supported locations, with reinforced concrete pile caps accepting the grade beam and column loads and transmitting these forces to the underlying pile groups.

Exposed Steel

While steel structural elements are nothing new to VA construction, the aesthetic flourish of AESS is unique to this VA project. The design team employed AESS in locations such as the main front canopy, a site trellis/canopy, and a rooftop garden trellis/canopy. The AESS levels vary at each condition, but all were designed to ensure a premium aesthetic appearance. The AESS design incorporates the latest AISC provisions, which differentiate levels of steel fabrications and erection. The main canopy structural system, 40 ft wide by 100 ft long, is designated as AESS Category 3 (Feature Elements in Close View) and consists of wide-flange columns and built-up tapered WT members that vary from 24 in. in depth at center to 12 in. deep at the ends. Spanning above and perpendicular to the column and WT-frames, HSS purlins are installed in a randomized pattern to support the translucent panel roofing system. Steel tension rods are installed at the ends of the canopy where the HSS purlins cantilever outboard away from the center of the structure, and these rods provide both aesthetic appeal and deflection control for the canopy structure at the perimeter.

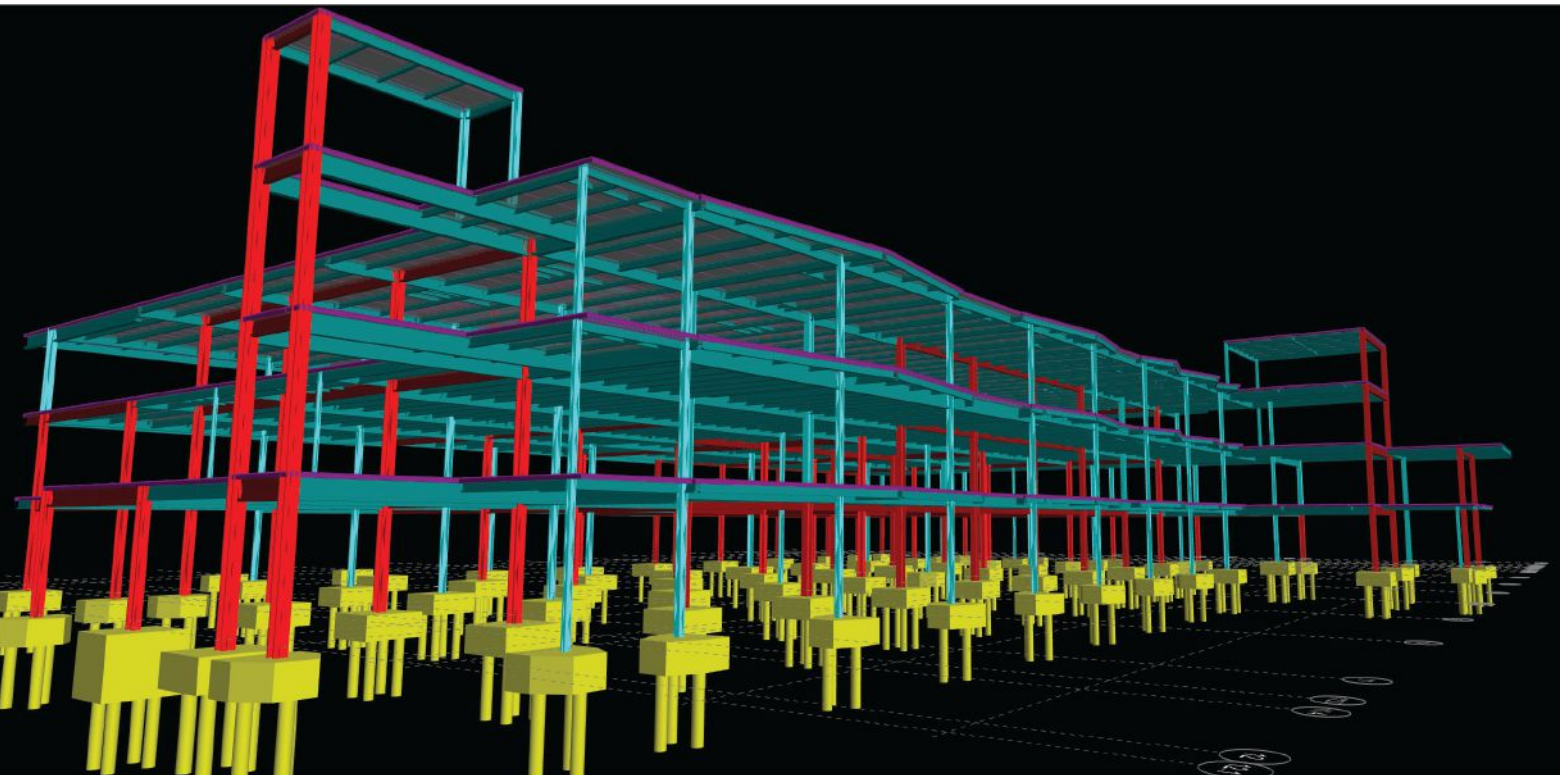



Ryan Curtis

The main canopy is designated as AESS Category 3 (Feature Elements in Close View).

The two remaining outdoor canopy systems have been designed to AESS Category 1 (Basic Elements) and also contain tapered built-up steel members and HSS purlins in a randomized pattern. All three locations of exposed structural steel are protected with a three-layer coating system to withstand the harsh exterior environmental conditions—especially in winter—of the Midwest. The first coat is a shop-applied Tnemec zinc coating. On top of that is an epoxy for increased abrasion, chemical, and corrosion resistance, and the top coat of modified polycarbamide (also Tnemec) provides the steel with needed color and semi-gloss retention for long-term exposure to the elements.

The design team required mock-ups of the canopy structures prior to procurement, and the structural engineers and architects visited fabricator PVS Structures’ shop to visually inspect the quality and anticipated final product of the exposed systems prior to delivery to the site in order to ensure that the final product met the AESS requirements and the VA’s expectations. This process allowed the design team to review and mark up areas of concern on the steel, with particular focus on minimizing weld splatter and providing a clean painting system without the appearance of any paint runs on the visible steel surfaces. (For more on AESS and the various categories/levels, see “Maximum Exposure” in the November 2017 issue, available at www.modernsteel.com.)

Vibration Consideration

When it came to laying out the facility’s program, the design team worked with frontline stakeholders (doctors, nurses, and administrators) to arrange the various spaces according to need and actual usage. This led to placing operating rooms on the

second floor, as most visitors will enter the building for services other than surgery and many will have mobility restrictions. While placing the operating rooms on the second floor solved a traffic flow issue, it presented a challenge in terms of vibration due to the high level of precision required during surgery—e.g., consider the impact of structural vibrations on a surgical laser.

The team looked to AISC Design Guide 11: *Vibrations of Steel-Framed Structural Systems Due to Human Activity* (available at aisc.org/dg) for design advice for vibration in the ORs (as well as for a monumental stair in the main public area) and stiffened the floor beam and girder members to W24 and W33 wide-flanges, respectively. The team also increased the slab thickness in the operating room to provide more mass dampening to reduce the vibration translations through the floor system. On top of that, cantilevered floor framing adjacent to the operating rooms had the potential to increase vertical movements caused by footfall, so the team introduced additional columns, bearing on transfer girders below, at precise locations to minimize these cantilevered-floor effects.

Connection Methods

The construction schedule, with the majority of steel erection beginning in late fall of 2018 and continuing through the winter, meant cold weather could play a troublesome part in fit up and welded connections of lateral moment frame members. To expedite erection, minimize field inspections, and remove almost all cold-weather welding preparations, LEO A DALY, PVS Structures, and general contractor McCarthy Building Company discussed alternate connection methods. Ultimately, LEO A DALY had PVS

At the floor levels, the curtain wall ties back “laterally” to the structure and transmits wind and blast-specific reactions to the composite floor system.

.....

design an all-field-bolted assembly for moment connections. This delegated design option followed AISC’s Option 3 (connection design work delegated to a licensed engineer working for the fabricator) in the AISC *Code of Standard Practice for Steel Buildings and Bridges* (ANSI/AISC 303, aisc.org/specifications). As part of the shop drawing package, PVS included steel calculations for all moment-connected beam-to-column connections, leading to reduced field inspection requirements as approximately 150 field-welded connections were revised to field-bolted connections. Connections that were exposed to view in areas such as open multistory interior gathering spaces and exterior canopies remained as detailed in the initial contract document submittal and were not included as a delegated design item.

In the contract documents, steel column erection called for a column splice above the second level, creating installed member lengths of 37 ft and 26 ft. To expedite steel erection and the overall construction schedule, McCarthy elected to install columns as a single member from foundation to roof level, which resulted in several 63-ft-long column pieces shipped and erected. With steel deliveries coming in multiple sequences, the erection crew was able to place approximately 75 pieces per day.

Approximate labor hour savings, thanks to using bolted moment connections versus welded connections, totalled 1,500, and eliminating column splices yielded an approximate labor savings of 500 hours. Overall, the estimated erection time saved by this plan of alternate moment frame connection methods and single-column erection was three to four weeks. This approach allowed construction work to avoid a significant portion of the brutal 2018-2019 winter in the area, complete with record snowfall.

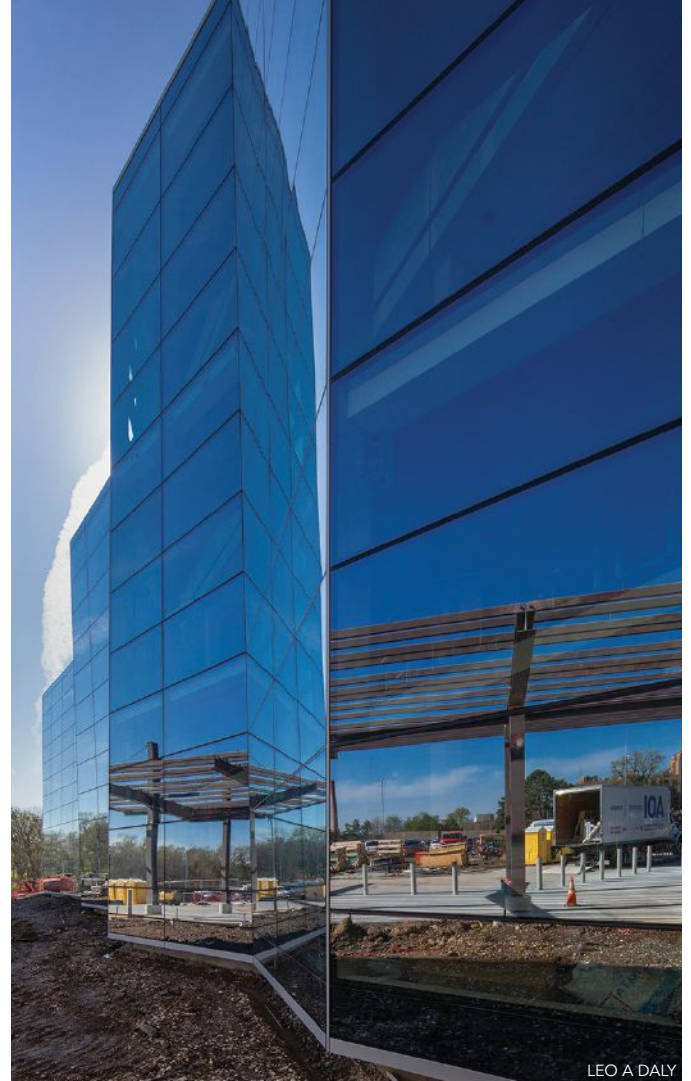



LEO A DALY

above: Traversing the west elevation of the building, the curtain wall system changes to a vertical colored “ribbon” wall symbolizing service ribbons of the veterans that the healthcare facility serves.

below: A monumental stair highlights the main public area.

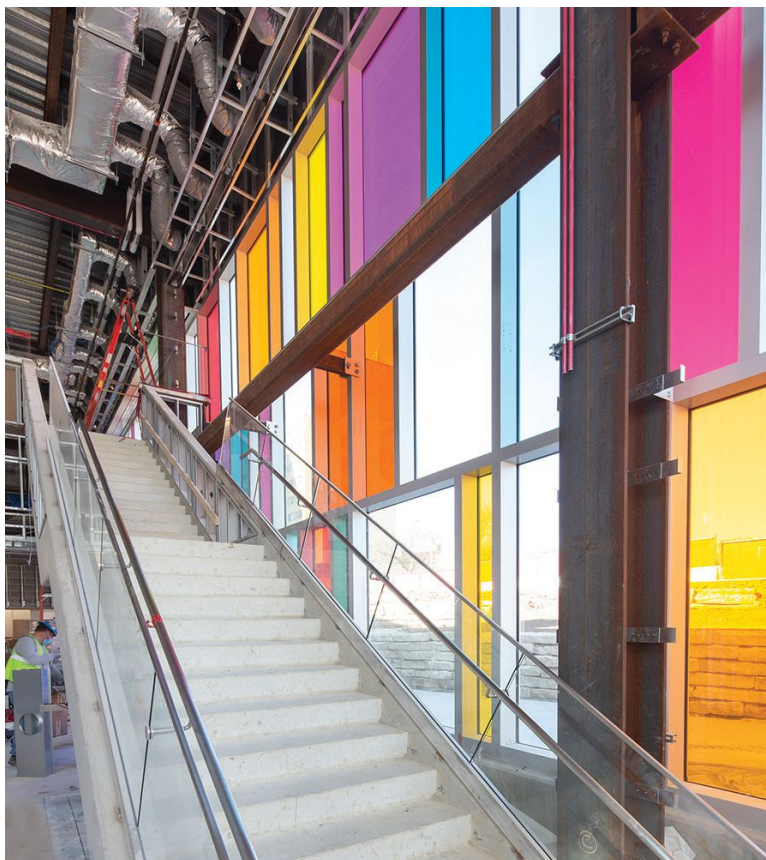

Soil Nails and Surcharging

Topography required that the design team site the new building at a lower elevation than the existing grade within the majority of the building footprint. In order to level the site for construction, soil nailing and surcharging were necessary. The use of a soil nail wall allowed the construction team the ability to remove soil vertically on a shorter schedule and without interrupting entry/exit drives into the main hospital entrance. This innovation saved time and money by negating the need for a temporary entry and exit during excavation. It was also critical to allow the existing VA facility to provide continuous care to veterans. The soil nails consisted of horizontal-auger grout piles inserted into the earth at lengths varying from 29 ft to 33 ft. The retained height of the soil-nail wall is approximately 20 ft immediately adjacent to the hospital’s drop-off road, and the approximate length is 80 ft.

The building’s geometry required additional off-site fill material to level existing grade. To adequately level and compact the new fill on-site, a surcharging procedure and monitoring method were applied. With maximum surcharging heights in the range of 8 ft, the surcharging program lasted two months with up to 6 in. of consolidation and settlement of compressible soils. Once settlement values began to plateau and the additional top surcharge soil was removed, foundation installation was able to begin.

Curtain Wall as Flag

As a VA facility with high aesthetic standards, it was important to include an eye-catching exterior highlight, and this came in the form of a curtain wall resembling a windblown American flag. This structure, which spans vertically from the ground level to the roof level along the main north façade of the building, meets blast-hardened physical security requirements to protect occupants from potential threats. At the floor levels, the curtain wall ties back “laterally” to the structure and transmits wind and blast-specific reactions to the composite floor system. Attaching the curtain wall to the structural floor system allowed the floors to deflect under specific live loading and also facilitates material expansion and contraction during significant temperature changes, a common occurrence in the Midwest. The “flag” wall cuts towards and away from the building along the longest façade of the building, and these cut locations vary at each level as the glass frame is also tilted towards and away from the building to give a leaning appearance from the exterior vantage



right: The structural engineers and architects visited PVS Structures’ shop to visually inspect the quality and anticipated final product of the exposed systems prior to delivery to the site.

below: Details of the slab plan and floor framing at the curtain wall.

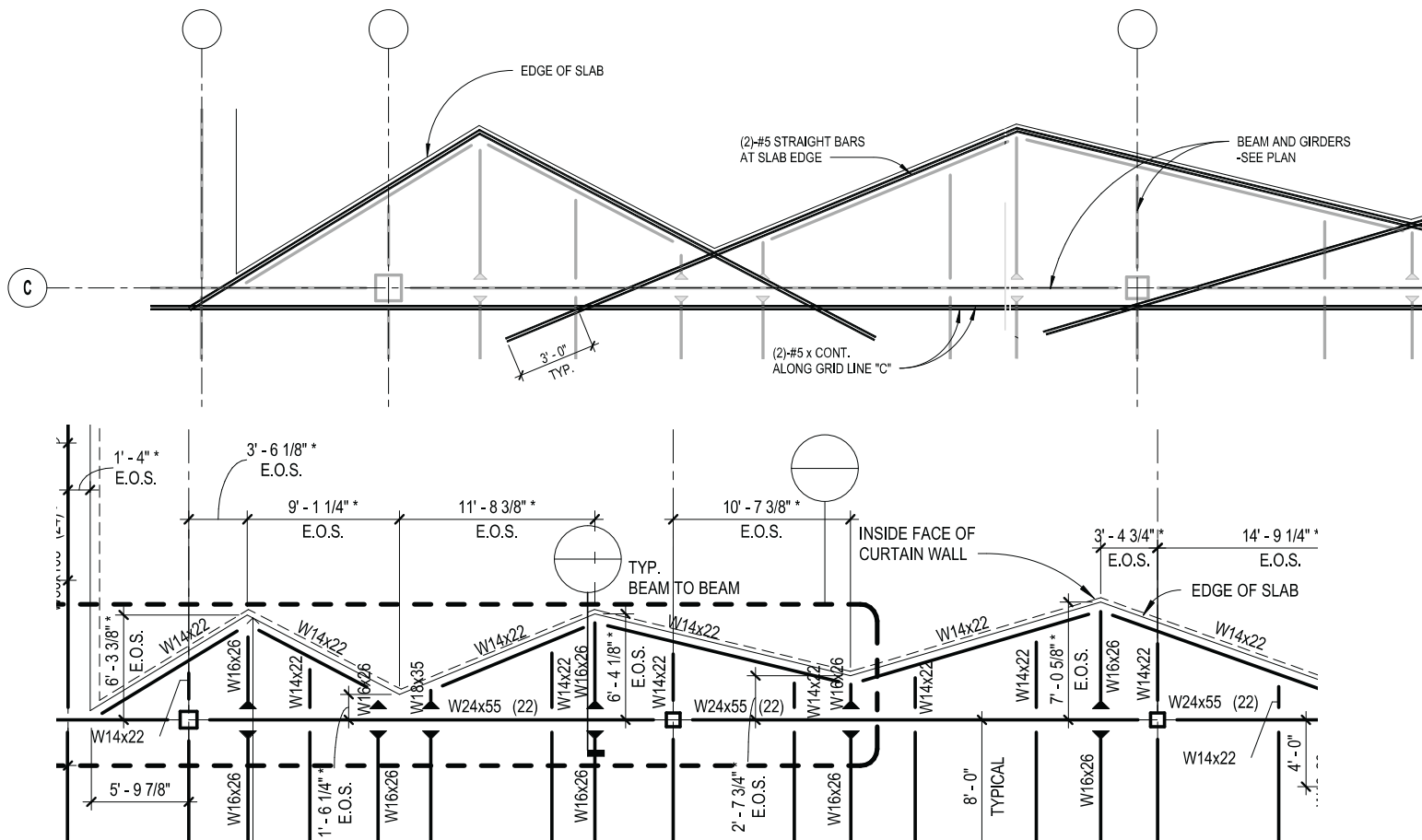

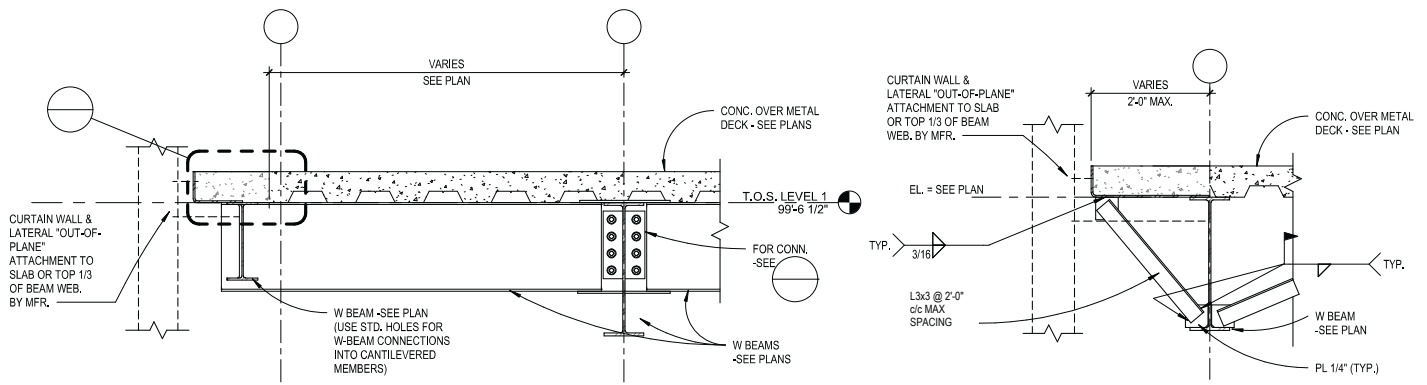

Details of beam sections at the curtain walls.

point. To respond to these geometrical challenges, the floor framing and exterior spandrel beams at each level run parallel to the shifting curtain wall skin. LEO A DALY and the glazing contractor successfully realized this framing partnership by sharing 3D modeling in early phases of design. This modeling allowed both parties to make real-time updates and modifications to the curtain wall system while staying current with vital geometrical coordination. Traversing the west elevation of the building, the curtain wall system changes to a vertical colored “ribbon” wall symbolizing service ribbons of the veterans that the healthcare facility serves. While the ribbon and colors maintain a staggered and random pattern, the wall system’s vertical mullions periodically match between stories, allowing the system to span from ground level to the roof, resisting lateral blast and wind load cases.

With the completion of the new VA Ambulatory Care Center, servicemen and women and veterans in the area can receive continued quality healthcare services in this landmark facility. An estimated 400 additional occupants will be able to visit the medical center each day. This building embraces Abraham Lincoln’s charge to all Americans “To care for him who shall have borne the battle and for his widow, and his orphan.”

Owner

U.S. Department of Veterans Affairs, Omaha

General Contractor

McCarthy Building Company, Omaha

Architect and Structural Engineer

LEO A DALY, Omaha

Steel Team

Fabricator

PVS Structures,  Council Bluffs, Iowa

Detailer

H & R Steel Detailing LLC,  Liberty, Mo.

GET CONNECTED WITH LNA SOLUTIONS

- CLAMPS DIRECTLY TO EXISTING STRUCTURES
- EASY INSTALLATION
- HOT-DIP GALVANIZED
- NO DRILLING
- GUARANTEED LOADING + FACTOR OF SAFETY
- NO WELDING

LNA SOLUTIONS
A KEE SAFETY COMPANY

LNA Solutions, Inc. | Buffalo, New York | (888) 724 2323
email: inquiries@LNAsolutions.com | www.LNAsolutions.com



A Steel "Base-Lift"

BY ERIC WHEELER, SE,
TAYLOR DODSON, PE, AND
STEPHANIE CHIRICUTA

An ambitious steel-framed rethinking of Willis Tower's ground-level presence was designed to elevate the famed skyscraper's bottom to the status of its top.



AS ITS 50TH ANNIVERSARY approaches, Chicago’s iconic Willis (formerly Sears) Tower is undergoing a massive steel-supported “base-lift.”

Much attention has been paid to the building’s height (1,354 ft to the top floor, 1,450 ft to the roof, and 1,729 ft to the tip of the antennae) and the incredible views from the observation deck. But at street level, the tower’s public entrances, built and remodeled at various times, created an incongruent and confusing base. This new renovation and addition, using approximately 2,000 tons of structural steel in all, hopes to flip the script and make the base of the building as much of a destination as the top, drawing in tenants, workers, and visitors with an array of new spaces, restaurants, and amenities.

This milestone project adds approximately 300,000 sq. ft of new dining, retail, entertainment, and rooftop park space within a new podium around the building, highlighted by a five-story atrium. The new podium rises three stories above the street, preserving views of the tower while repositioning the block as a destination for the coming decades. It replaces an expanse of Carnelian granite and disparate entrance structures, which were added after the original tower was built. Thornton Tomasetti’s Chicago office (TT) provided integrated structural engineering, façade engineering, construction engineering, and protective design services to realize the owner’s vision. The new west and south entrances and atrium opened in the summer of 2019, and the remainder of the project is scheduled to be completed this year.

Respecting the Existing

Updating a massive, high-profile project that has captured the world’s attention for a half-century required careful consideration of structural updates, replacements, and additions, and included several areas of particular interest and importance.

No new foundations. Although the tower held the title of the tallest building in the world for nearly a quarter-century following its completion in 1973—yielding the title to the twin Petronas Towers in Kuala Lumpur, Malaysia, when they were completed in 1996—the original vision for the city block was never fully developed. The plaza foundations, meant to support an unbuilt hotel, consist of belled caissons with an irregular layout and varying capacities. However, the rock caissons supporting the tower sit on an independent grid system. The new podium grid aligns aesthetically with the original tower columns. To distribute loads from the current to the existing column grids, TT Renewal engineers designed 72 transfer columns and approximately 80 transfer girders. This strategy allowed the team to optimize a design requiring no new foundations. Four transfer beams supporting the new columns are W40×503 sections (ASTM A992), the heaviest steel shapes produced in the United States. The average weight of each W40 transfer girder is approximately 7.5 tons. The project schedule dictated ordering the transfer beams early in the design phase, ahead of the rest of the steel bid package.



Eric Wheeler is a senior associate, **Taylor Dodson** is a senior engineer, and **Stephanie Chiricuta** is a senior engineer, all with Thornton Tomasetti. **William Bast, SE, PE, Diarmuid Kelleher, SE, PE, Peter Konopka, SE, PE, and Karl Bettinger**, also all with Thornton Tomasetti, contributed to this article.



above and below: The main erection crane for most of the structure was set on a dunnage platform (made from fabricated steel that was eventually removed) located at the Jackson entrance, as there wasn't ample room outside the building footprint for a crane.

right: Deep plate girders fly over an 8,000-sq.-ft event space while supporting a rooftop garden.



Also, at level 4, a half-dozen, 60-in.-deep plate girders fly over an 8,000-sq.-ft event space while supporting a garden retreat. In order to allow building tenants and patrons to step directly out onto the park, the girders are 2 ft lower than the tower's level 4 top of steel. Erector Chicago Steel Construction lifted most of the 105-ft long plate girders with a single crane. The easternmost girder's position required lifting it as two separate pieces, one at a time, and then splicing them together. All steel deliveries were coordinated and scheduled precisely on a just-in-time basis, as there was little to no space on the tight, urban site for material storage.

Various reinforcing schemes helped fortify the existing steel columns for the new loads and modified floor plates. Most of the lower-level plaza columns outside of the hotel footprint could not support more than one additional floor. Engineers in TT's Renewal group determined that roughly 20 existing steel wide-flange columns required strengthening to support the vertical addition, and the resulting design welded headed studs to the column webs and encased these columns in concrete to share the load between the steel section and the concrete encasement. Where existing site constraints prohibited concrete encasement, the engineers designed partial-

height flange-reinforcing plates for the existing columns. This design scheme also required evaluating the columns as stepped members that considered the unreinforced and reinforced column sections.

Spandrel beam relocation. When engineering the podium superstructure, TT's team faced a particularly complicated design challenge at the new Wacker Drive (west) entrance. The new feature stair was to span from street elevation to level 2, passing through the existing prefabricated "tree-column" modules that form the tower's famous bundled tube system (in case you didn't know, the tower consists of a three-by-three grid of 75-ft by 75-ft "tubes," creating a 225-ft by 225-ft square footprint). Lowered by 4 ft, three existing 42-in.-deep built-up steel plate spandrel beams required removal and replacement with new built-up beams. Relocating these spandrel beams interrupted the tower's continuous load path and altered the stiffness of the redundant bundled tube system, so TT designed the three new built-up steel plate girders, as well as local reinforcing for the adjacent 110-story megacolumns, to take the redistributed forces.

Construction engineering. TT's Construction Engineering team provided structural engineering expertise to assist the general

Things are Heating Up at CMRP

Chicago Metal Rolled Products now offers Heat Induction Bending of carbon, stainless and alloy steel pipes – round, square or rectangular.

Consistent and high quality bends with:

- Limited wall thinning
- Limited Rippling
- Limited Ovality
- 24-hour lead time



Call us at
866-940-5739

When little to no wall thinning
and minimal ovality is mandatory.



**CHICAGO METAL
ROLLED PRODUCTS COMPANY**

CHICAGO • KANSAS CITY
cmrp.com



1 Angle Leg Out We bend ALL sizes up to:
 10" x 10" x 1" Angle

2 Angle Leg In
 10" x 10" x 1" Angle

3 Flat Bar The Hard Way
 24" x 12" Flat

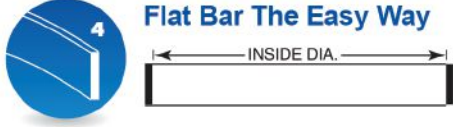
4 Flat Bar The Easy Way
 36" x 12" Flat

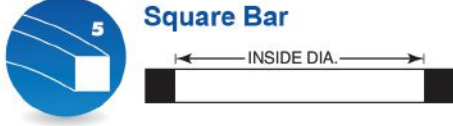
5 Square Bar
 18" Square

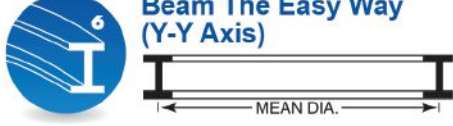
6 Beam The Easy Way (Y-Y Axis)
 44" x 335#,
36" x 925#

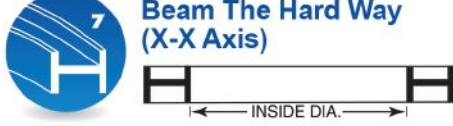
7 Beam The Hard Way (X-X Axis)
 44" x 285#

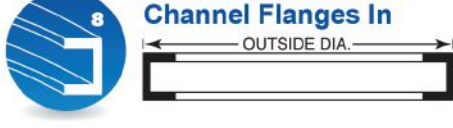
8 Channel Flanges In
 All Sizes

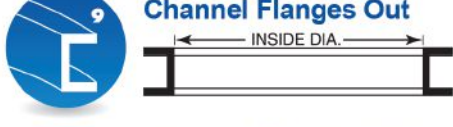
9 Channel Flanges Out
 All Sizes

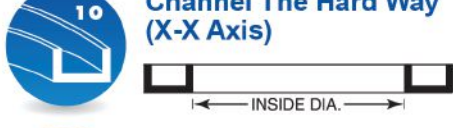
10 Channel The Hard Way (X-X Axis)
 All Sizes

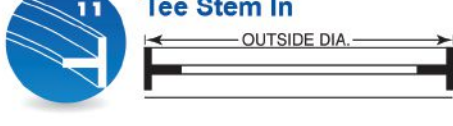
11 Tee Stem In
 22" x 142¹/₂# Tee

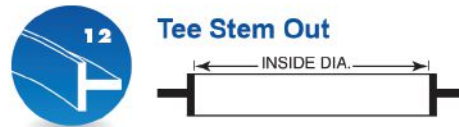
12 Tee Stem Out We bend ALL sizes up to:
 22" x 142¹/₂# Tee

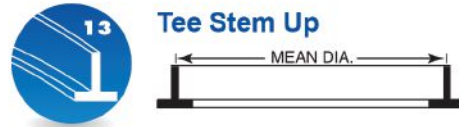
13 Tee Stem Up
 22" x 142¹/₂# Tee

14 Angle Heel In
 8" x 8" x 1" Angle

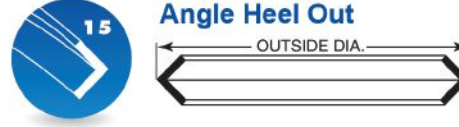
15 Angle Heel Out
 8" x 8" x 1" Angle

16 Angle Heel Up
 8" x 8" x 1" Angle

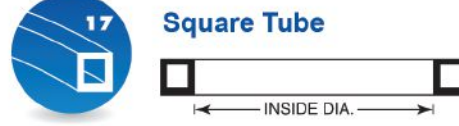
17 Square Tube
 24" x 1¹/₂" Tube

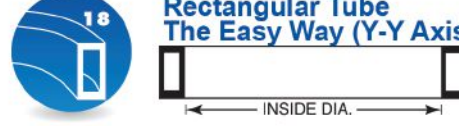
18 Rectangular Tube The Easy Way (Y-Y Axis)
 20" x 12" x 5/8" Tube

19 Rectangular Tube The Hard Way (X-X Axis)
 20" x 12" x 5/8" Tube

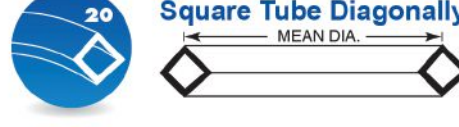
20 Square Tube Diagonally
 12" x 5/8" Square Tube

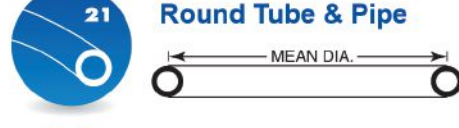
21 Round Tube & Pipe
 24" Sched. 80 Pipe

22 Round Bar
 All Mill Produced Sizes

We also roll stair stringers, helical hand rails, off-axis bends, formed shapes and extrusions.

Visit cmrp.com for more information.



CHICAGO METAL
ROLLED PRODUCTS COMPANY

CHICAGO • KANSAS CITY



below: While the tower's observation deck has long drawn crowds, the base of the tower was not seen as a destination for office workers and visitors. The newly renovated and expanded spaces aim to change that.



above and below: Framing for the new Wacker entrance. To see the below model "dance," see the Project Extras section at www.modernsteel.com.

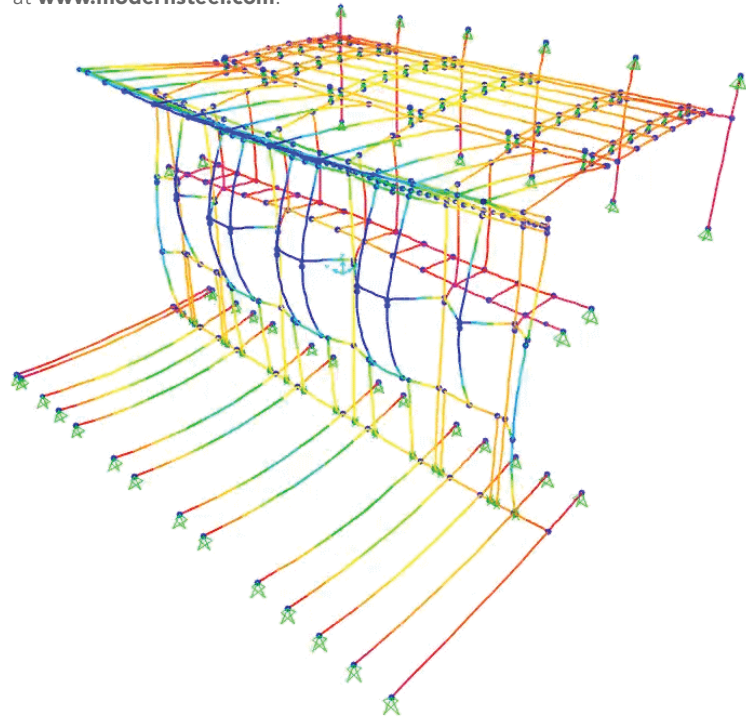

contractor, a joint venture between Turner Construction Company and Clayco, in detailing and sequencing renovations. The team's tasks included a menagerie of tasks that varied from permanent connection design to temporary shoring and bracing designs. Designing new structural steel connections for the project's fabricator, Zalk Josephs, included challenges resulting from existing conditions and geometry. In some cases, for example, the designed connections needed to address large eccentricities between new and existing members. TT connection engineers worked seamlessly with the primary structural design team to achieve the overall design intent with realistic, constructable connection details.

In addition to connections, the Construction Engineering team designed temporary supports for the building as it underwent selective demolition tasks, which included slurry wall brace design, temporary column bracing, temporary support of utility pipes, review of crane and equipment loads, and construction and demolition sequencing. (For example, to accomplish the above-mentioned alterations to the tube system while the tower remained fully occupied, TT's Construction Engineering team sequenced the removal and addition of the spandrel beams.) TT worked with

Turner/Clayco directly to eliminate any instability during demolition, keeping the project safe for those working on the active construction site as well as those in adjacent occupied building spaces.

Protecting the public. Standing sentry around the new podium are more than 300 steel pipe bollards designed to protect pedestrians and building occupants from potential vehicle impacts, whether accidental or intentional. Their simple appearance above grade is akin to an iceberg projecting above the surface of the ocean. Below the sidewalks, reinforced concrete grade beams support the bollards. Dense urban environments like Chicago have myriad existing structures below grade that constrain and conflict with these footings. Engineers in TT's Protective Design group customized the footings to squeeze past high-voltage equipment rooms, avoid fire hydrants, span manholes (sometimes two in a row), skim the edges of tree planters, and retain maintenance access—all while marching in an orderly line down each block. At the viaduct along Wacker Drive, the bollard footings are integrated with the building's elevated structural slab, their design and detailing streamlined by having the structural and protective design engineers working together in the same office.

Embracing the New

By adequately addressing and respecting existing conditions, the design and construction team set the stage for the creating the elements that would make a half-century-old building seem new again.

AESS grid shell at Jackson Boulevard (south) entrance. TT's Façade Engineering team took a high-tech approach for the new skylight on Jackson Boulevard. Given the tower's prowess as a revolutionary feat of structural engineering, architect Gensler wanted the skylight to celebrate its structural steel roots and created an architecturally exposed structural steel (AESS) support system in the form of a lightweight, undulating grid shell to cap off the new "Catalog" atrium, named as an homage to Sears.

The grid shell design went through many iterations, starting as an extremely freeform structure involving built-up steel members and hot-formed curved glass. From there, the façade engineers rationalized the form into a more logical and economical design that retained the desired undulating form: a doubly curved shell but with planar glass panels throughout. The final design of the 75-ft by 90-ft grid shell is comprised of an AESS Category 2 (Feature Elements not in Close View) stick-built system using hollow structural sections (HSS) with high-strength bolted moment connections at each node. In keeping with the AESS requirements, access holes on the top faces of these HSS elements allowed the tension bolts to remain hidden and eventually be covered by the glazing. (For details on the various AISC AESS categories, see "Maximum Exposure" in the November 2017 issue, available at www.modernsteel.com.)

Carefully analyzing the stability of this expressive structure was crucial. In addition to employing the AISC-prescribed direct analysis method for the strength of individual members, TT's façade engineers evaluated global buckling of a shell—where the curved form could "snap through"—using the Dallard method, a technique that takes natural buckling mode shapes and scales them to a predicted imperfection, which is a combination of fabrication and erection tolerances. The load is then ramped up until the loss of stability, with a safety factor of two.

The shell was similarly sensitive to the stiffness of its supporting boundary. While a flat skylight would have only imparted vertical reactions to its supporting structure, the undulating shell also imparted a significant amount of horizontal thrust to all four edges. TT carefully modeled the gravity and lateral systems supporting the shell and calculated the spring stiffness of the boundary conditions. The resulting shell structure was as light as 8 lb per sq. ft of structural steel. Engineering for the lateral thrust of the skylight played a large part in sizing and locating the podium roof geometry, braced frames, and in-plane bracing, requiring close coordination with the Renewal team.

Integrated façade and structure at Wacker Drive entrance. An AESS Category 3 (Feature Elements in Close View) glazed structure encloses the Wacker Drive entrance and permits a straight line of sight from street level to the top of the 110-story tower. The skylight girders are supported on the existing tower columns and span over the lobby to 40-ft-tall steel mullion columns along the entry façade. A bridge connecting the podium on either



above and below: An AESS support system in the form of a lightweight, undulating grid shell caps off the new "Catalog" atrium, named as an homage to Sears.



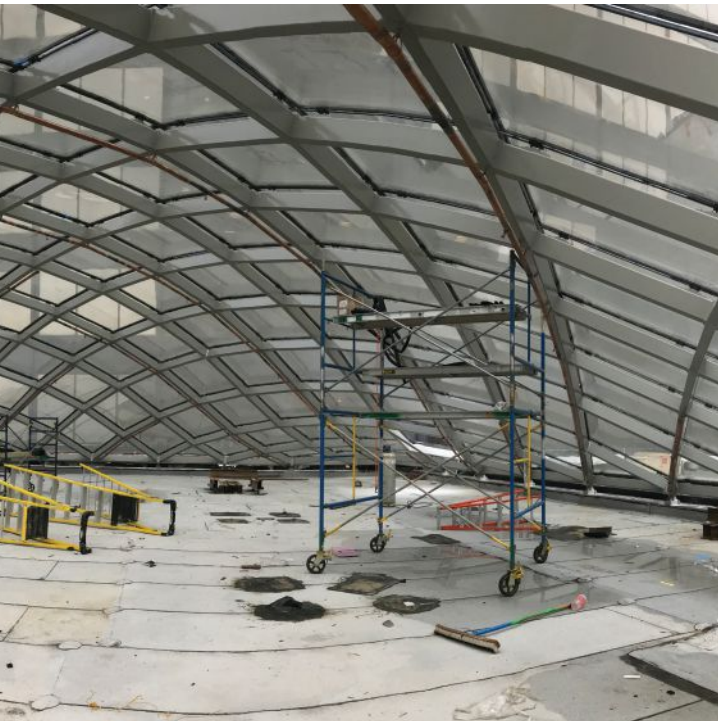

above and below: The previous “lunchbox” entrance at Wacker Drive was disassembled and replaced.

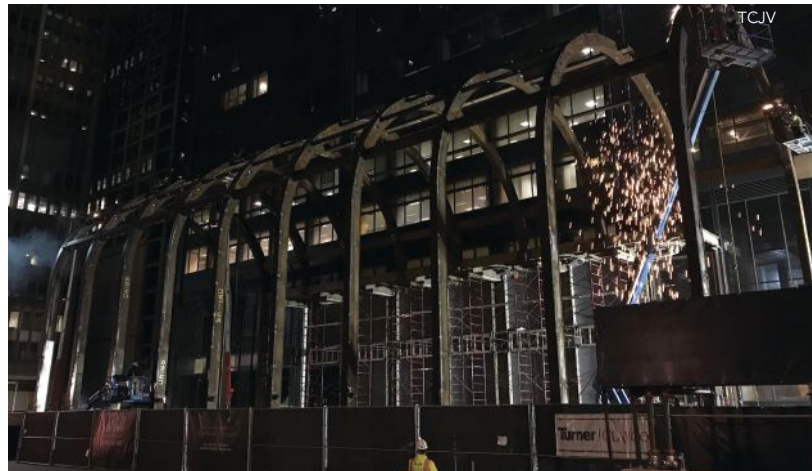

above: An AESS glazed structure encloses the Wacker entrance and permits a straight line of sight from street level to the top of the 110-story tower.

right: Framing for a portion of the new podium, which rises three stories above street level.

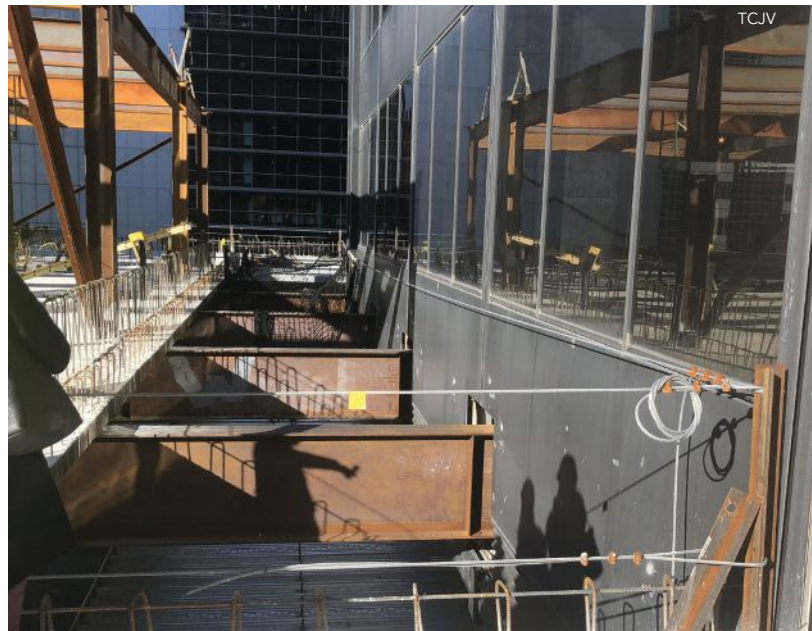



Zalk Josephs



Gensler

above: The 300,000 sq. ft. of new dining, retail, entertainment, and rooftop park space is highlighted by a five-story atrium.

left: An AESS mock-up in Zalk Josephs' shop.



Gensler

above: The new west and south entrances and atrium opened in the summer of 2019, and the remainder of the project is scheduled to be completed this year.

right and below: The south atrium following and during construction.



TCJV



TCJV

side of the Wacker lobby at Level 3 is gravity-supported at each end, and via tension rods hanging from the skylight girders above. The bridge laterally supports itself in addition to the façade mullion columns, thereby making the mullions as slender as possible. The bridge is also integral to the Wacker entrance's lateral system, providing another load path for wind forces to enter the podium's diaphragm and find their way back to the tower. The result is a circuitous but elegant structure.

The steel, made up of solid bar stock, is 3.5 in. wide to mimic a mullion profile and is 9 in. to 18 in. deep. This approach was inspired by the previous lunchbox-shaped Wacker Drive atrium, which also used steel for both façade and structure. A low-profile veneer assembly was attached to the mullions, to which the glass was toggled, and visual mockups ensured quality control of the final product.

Fazlur Kahn, Sears Tower's original structural engineer and structural engineering legend, cautioned against being too immersed in our "own technology" and encouraged the appreciation of life and the people within it. Through the technology of steel and, more importantly, collaboration and creative thinking across the project team, this update is giving the people of Chicago a new appreciation for—and a new way to enjoy—Kahn's landmark tower. ■

Owner

EQ Office

Owner's Representative

RL Edward Partners

General Contractor

Turner Construction Company/
Clayco Joint Venture

Architect

Gensler, Chicago

Structural Engineer, Construction Engineer, Façade Engineer, and Protective Design Consultant

Thornton Tomasetti, Chicago

Steel Team

Fabricators

Zalk Josephs Fabricators, LLC,  Stoughton, Wis. (also detailer)

Novum Structures, LLC,  Menomonee Falls, Wis. (grid shell)

Erector

Chicago Steel Construction, LLC,  Merrillville, Ind.

Detailer

Ken Boitz and Associates, Inc.,  Bloomingdale, Ill.

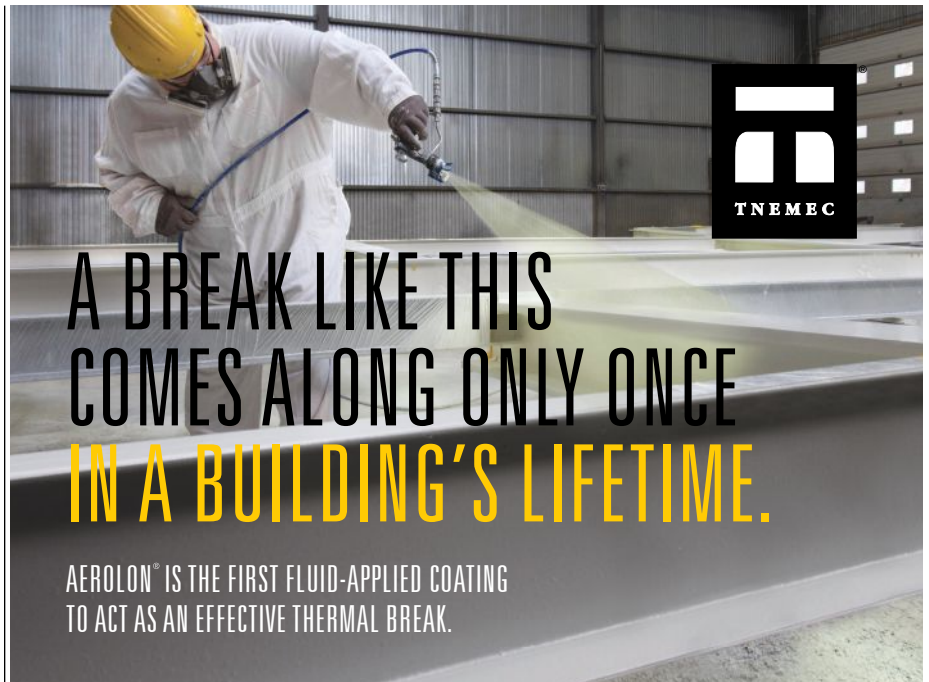

A BREAK LIKE THIS COMES ALONG ONLY ONCE IN A BUILDING'S LIFETIME.

AEROLON® IS THE FIRST FLUID-APPLIED COATING TO ACT AS AN EFFECTIVE THERMAL BREAK.

A low VOC, water-based coating that can be easily spray-applied in the shop or in the field, Aerolon provides significant cost-saving advantages over structural thermal breaks, limiting design restrictions for architects and reducing application and labor time for contractors. **Find out more at tne mec.com/thermalbreak.**

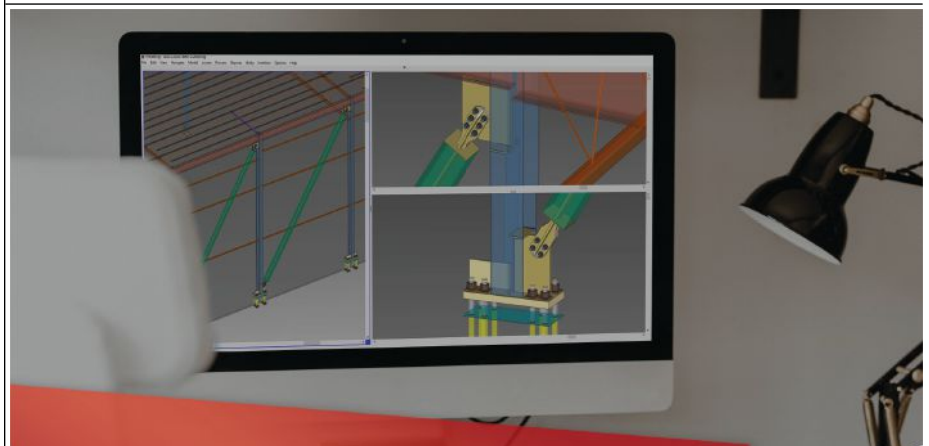

NOW INTEGRATED WITH SDS/2 SOFTWARE TO EXPEDITE YOUR NEXT PROJECT

visit us at corebrace.com



A NEMETSCHek COMPANY



As a Charlotte community college grows in enrollment, steel helps the campus quickly catch up.



Rodgers Builders



Trina Agnello ([@tagnello](https://www.linkedin.com/in/tagnello)
[@stewartinc.com](https://www.stewartinc.com)) is a project manager, structural engineering, with Stewart.

CENTRAL PIEDMONT COMMUNITY COLLEGE in Charlotte is one of the largest and fastest-growing community colleges in the Southeast. As the school's population continues to grow, updates to buildings on campus have followed suit, with several renovations and new buildings on the horizon.

Central Piedmont's investment in new infrastructure is part of its mission to provide exceptional education and globally competitive training in an engaging, supportive environment, and the new North Classroom Building is one of the largest buildings ever constructed on campus, bringing a variety of new offerings to the college. Stewart, an interdisciplinary design, engineering, and planning firm with a prominent office in Charlotte, has fingerprints on many projects on the growing Central Campus as well as Central Piedmont's other campuses across Charlotte, and the firm's structural engineering team played an integral role in the steel-framed North Classroom Building.

Foundation for the Future

The North Classroom Building is an expansive project that will provide enhanced learning opportunities for both students and faculty. The building is home to a new 200-seat auditorium, 51 classrooms, and six biology and chemistry labs, as well as 55 offices, including new office space for the dean of the college. Standing six stories and encompassing 150,000 sq. ft (including a basement level) the new space is centrally located on the campus quad and replaces a three-story classroom building.



Standing six stories and encompassing 150,000 sq. ft, Central Piedmont Community College's new North Campus Building is centrally located on the campus quad and replaces a three-story classroom building.

Stewart provided an early site and steel package for the building, laying the foundation for the other partners and design team members. Stewart's hand in the early site and steel packages required detailed coordination with architecture, civil, mechanical, plumbing, electrical, and foundation improvement engineers prior to finalizing the building package. In all, the building uses 270 tons of structural steel for the framing. Grids are centered around the corridors, elevators, and stairs, allowing for 42-ft-long spans using W18 beams across the classroom spaces. Shorter girder spacing on the perimeter, using W24 beams, relieves the brick veneer at each level. Steel elements, including cast stone supports, storefront, railings, stairs, and horizontal fire shutters were detailed early in the process, before the architectural package, allowing the steel package to be fabricated and delivered to the site on time to meet the aggressive construction schedule.

There were many logistical challenges that required creative and strategic thinking. First was an aggressive construction schedule to get the building delivered 26 months after demolition of the existing facility. Also, working on an active campus

limited the spaces where crews could bring in machinery, construction equipment, and materials; at one point, the quad was used as a lay-down area.

In addition, the college was keen on having minimized mechanical units on the exterior of the building, requiring the design team to think through efficient framing and lateral bracing locations while working with the architect's desired open spaces, such as a large open area in the center of the building at the elevators, as well as collaborative seating areas for students that connect the floors together.

The team was also tasked with fitting a new building onto an existing building footprint with limitations from grade at the ground level to the first-floor height, which made mechanical coordination challenging. To address this, the team implemented multiple beam penetrations for the mechanical, sprinkler, electrical, and plumbing systems between the ground level and first floor framing so as to maximize the floor-to-ceiling height. The building also had to connect to an existing energy plant via underground piping, creating another coordination challenge. Implementing building information modeling (BIM), using Revit, helped the various team members

reduce ductwork, plumbing, and fire sprinkler clashes. For example, there were large openings, reinforced with stiffener plates, in some steel beams. And in some locations, where contractors did not build according to the model, piping needed to be relocated.

A Solution-Focused Approach

Stewart prioritized the student experience at every step of the structural engineering process. The solutions to the challenges required by the Central Piedmont campus were solved by thinking through what would best serve the needs of students and faculty for the upcoming semester and into the future. To ensure that the details of the building would meet the needs of the community, Stewart worked with the architectural team to design the building to their exact specifications.

With the limited site storage, the building was broken into thirds and constructed vertically one third at a time, including the roof. Once the building was erected, concrete was poured on the steel deck from the roof down, allowing plumbing and electrical to be laid out correctly into the slab as other areas of the building were being worked on.

To “hide” the mechanical units, the design team arranged for a sunken mechanical basement and mechanical room on the fifth floor. Both locations required coordination with mechanical equipment placement and allowance for future replacement needs. A heavier composite floor construction (8 in. total here in contrast with 5.25 in. total in other areas) was used on the fourth floor to handle the additional loads as well as incidental sound and vibration.

The classical symmetrical building design made locations of large hollow structural section (HSS) lateral brace frames easier to hide at the classroom levels. With the stairs located in the center core of the building and equally spaced, Stewart identified this area as the prime location for the lateral braces. Keeping the grid spacing equal at the stairs allowed for consistent lateral framing throughout the stairs, and braced frames and stairs were repeated using the same geometry.

The location of Central Piedmont’s campus provides direct sight lines to Charlotte’s uptown skyline. To capitalize on this, the Stewart team engineered the fourth-floor terrace area to provide views for the students and staff to enjoy, and the building footprint is stepped in 6 ft at floors five and six with W27×178 transfer beams to create the terrace space. This design included lowering the steel framing 1.5 ft at the patio level to create space for waterproofing and a paver system, as well as a seamless transition from interior to exterior.





Rodgers Builders



Rodgers Builders

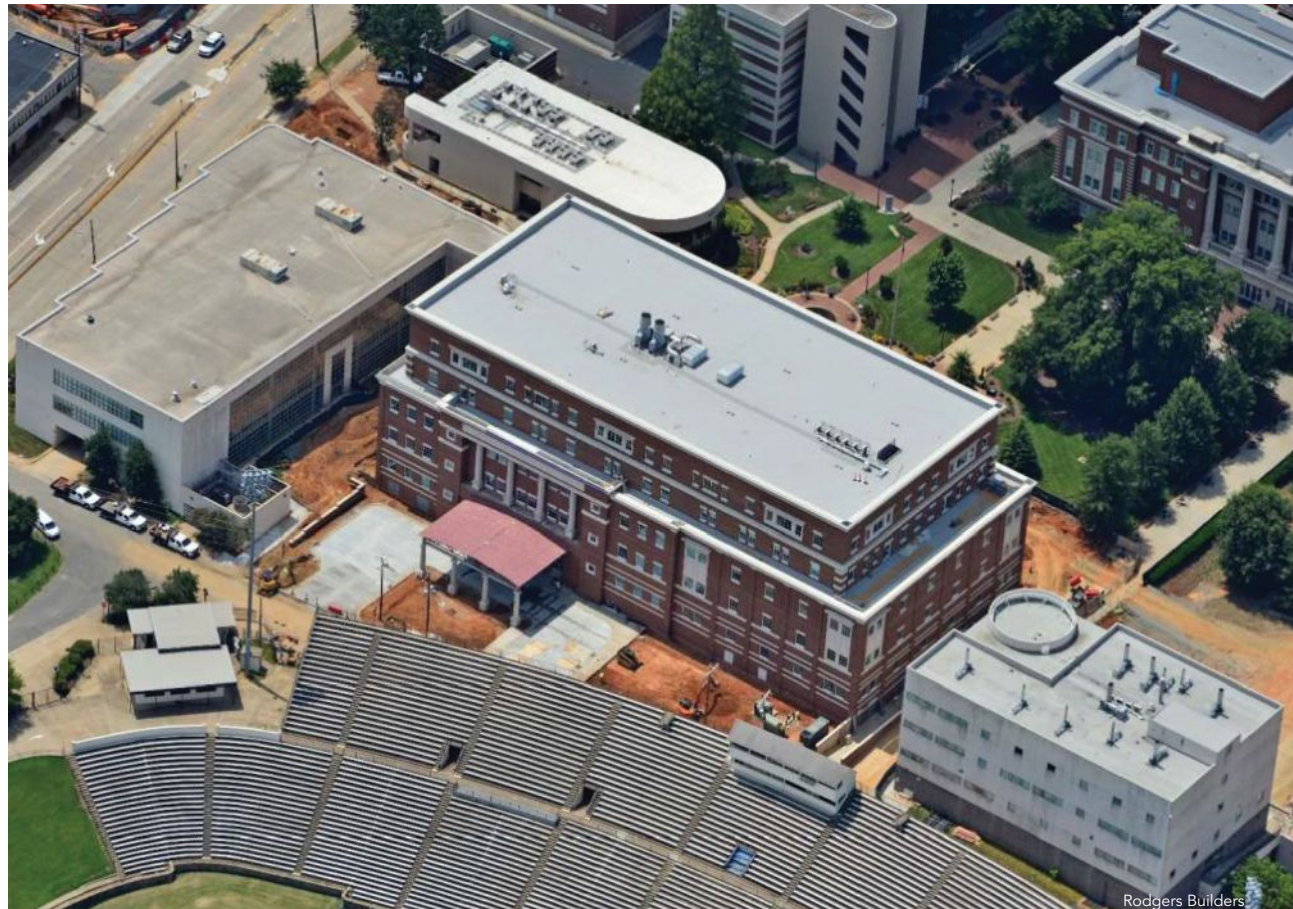

Rodgers Builders

left and below: Grids are centered around the corridors, elevators, and stairs, allowing for 42-ft-long spans using W18 beams across the classroom spaces. W24 beams at the perimeter relieve the brick veneer at each level.

Rodgers Builders

left: In all, the building employs 270 tons of structural steel for the framing.

above: Space was limited and toward the end of the project, the adjacent quad had to be used for material lay-down.



Rodgers Builders



Rodgers Builders

Central Piedmont's location provides direct sight lines to Charlotte's uptown skyline.

The architect's desired open vision included large open spaces such as collaborative seating areas for students.



BENT ON SATISFACTION

11 Bending Machines

Easyway and Hardway: Beams, Tubes, Angles, Tees, Channels, Flats, Pipe & Rail

Sheet/Plate

Shearing (to 1/2" x 20'), Forming, Rolling (to 1 1/4"), and Coning

6 Press Brakes

1000 Ton x 30' 750 Ton x 24'
400 Ton x 23' 3-225 Ton x (10', 12', 14')

CNC Machining

Quality

WhiteFab's patented structural bending process minimizes deformation and provides smoother curvatures. Each bent section is verified for accuracy along its arc.

Facilities

170,000 sq. ft. of production area, under roof

**"IF QUALITY IS WHAT YOU NEED,
LET WHITEFAB TAKE THE LEAD"**



Phone 205-791-2011
Fax 205-791-0500
E-mail: sales@whitefab.com
Web: www.whitefab.com

The Future Is Now

The building was completed in late 2019, three months ahead of schedule, providing the staff a long lead time to transition into the building. While many construction jobs have less than a month to get everything and everyone moved in and established, the North Classroom Building residents were given a comfortable three months to get acquainted and situated in their new home.

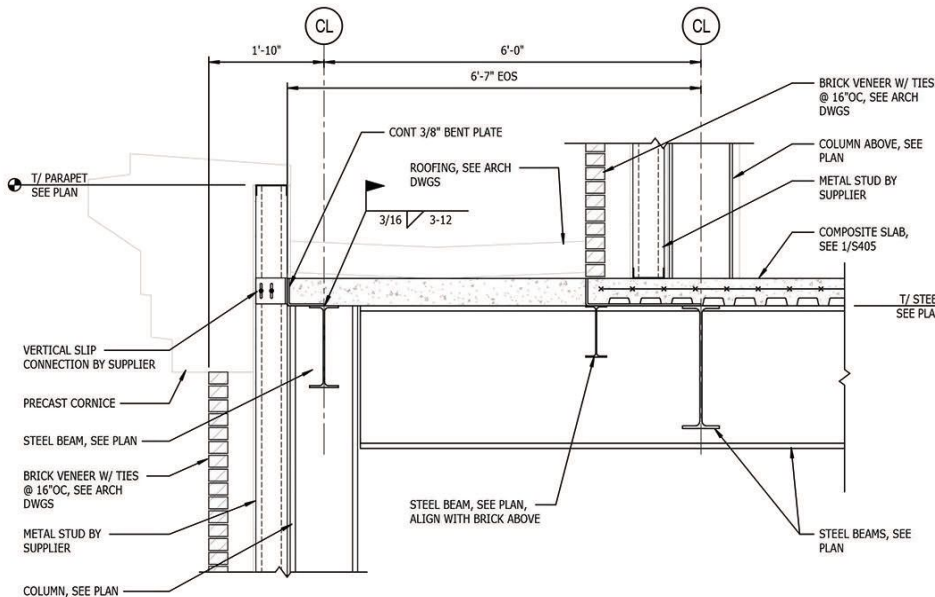

A detail of a column transfer where the building steps in.

With admissions numbers on the rise at Central Piedmont and new majors and extracurricular offerings added every semester, this expansion could not have come at a better time. The North Classroom Building, among other new projects across campus, provides students with the capabilities and opportunities for their diverse interests and passions, now and into the future.

Owner

Central Piedmont Community College, Charlotte

General Contractor

Rodgers Builders, Charlotte

Architect

WHN Architects, Charlotte

Structural Engineer

Stewart, Raleigh, N.C.

Steel Team

Fabricator

SteelFab, Inc., Charlotte



Erector

Eastern Constructors, Inc., Geismar, La.



Detailer

Prodraft, Inc., Chesapeake, Va.



Lindapter®

ICC-ES APPROVED

Faster Steel Connections



Lindapter's cost-effective alternatives to drilling or welding in the field are ICC-ES approved for structural use in all Seismic Design Categories (A through F).

- ✓ No drilling or welding in the field!
- ✓ Faster installation reduces labor costs
- ✓ Approved high strength capacities
- ✓ Compliant with the IBC and LA Codes
- ✓ Free connection detailing service

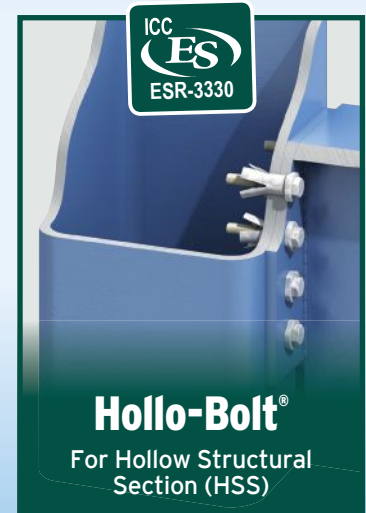

NEW

Lindapter Catalog out now! Call **866 566-2658** or visit www.LindapterUSA.com

Campus Keystone

BY ALLISON L. LUKACHIK, SE, PE

A new steel structure takes shape, transforming an underused sliver of land and unifying a busy corner of the University of Pennsylvania campus in West Philadelphia.

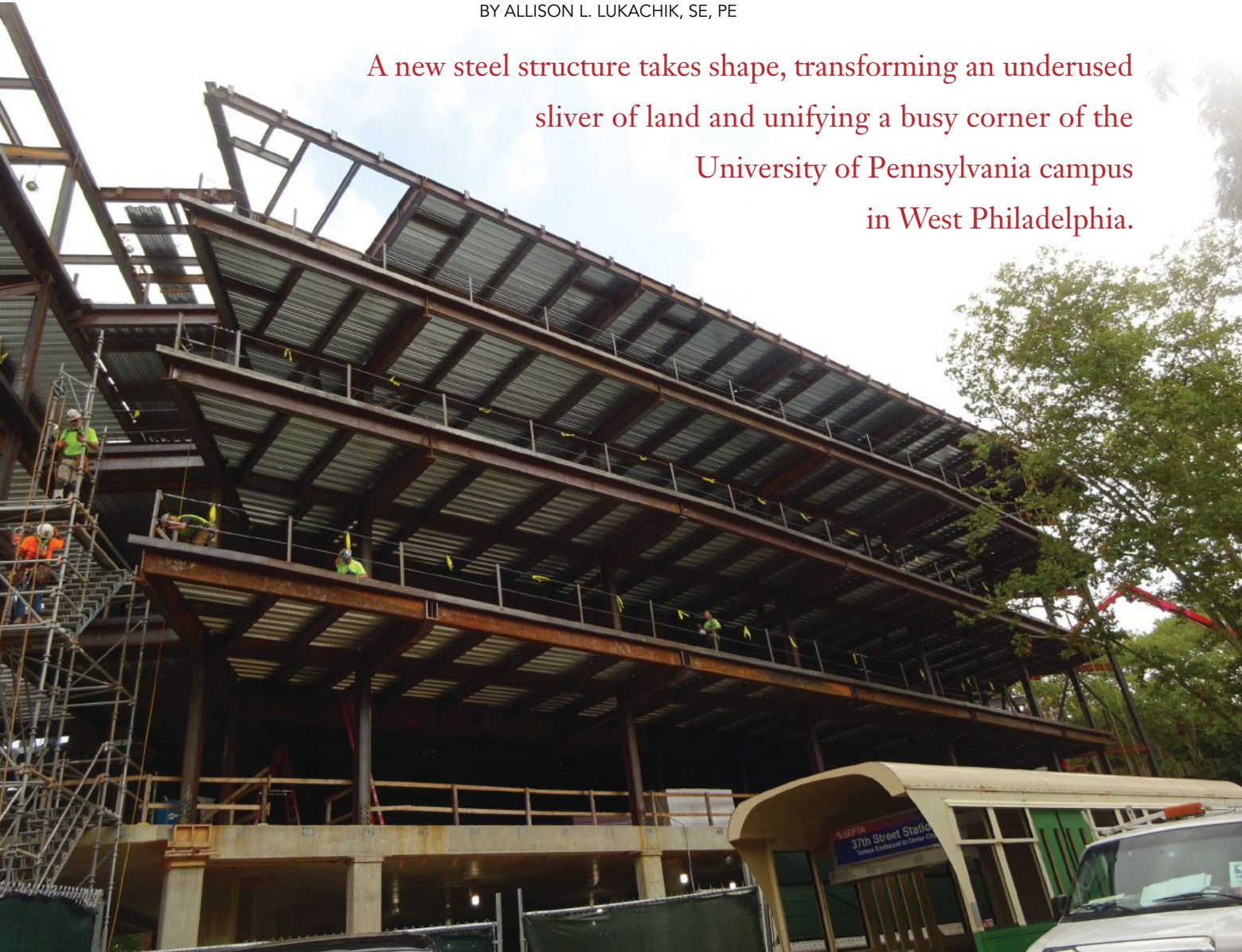

AT FIRST GLANCE, the University of Pennsylvania's new Wharton Academic Research Building (WARB) appears to be a relatively straightforward addition to a college campus.

However, looks can be deceiving. As is typical with many city projects, the limitations imposed on the new building's shape and structure were significant. The project site is located at the highly trafficked and highly visible confluence of the 37th Street Walkway, Woodland Walk, and Spruce Street on the school's Philadelphia campus. Scheduled to open this fall, the five-story, 80,450-sq.-ft steel-framed structure (using 467 tons of steel) will feature four levels of classrooms, group study rooms, research centers, and

shared conference rooms. Operational functions are located at ground level and include a new electrical substation that powers half the campus and an enclosed loading dock that services multiple buildings. These elements cohabitate with a grand three-story lobby entrance featuring a monumental, spiraled circulation stair framed with architecturally exposed structural steel (AESS).

While the framing design itself was fairly straightforward, undermining this relative simplicity were significant constraints such as SEPTA setback requirements, avoiding major underground utility lines, and the inclusion of an underground substation below half of the building footprint. The ground level is pri-



above: The new Wharton Academic Research Building is located at a highly trafficked and highly visible intersection on the University of Pennsylvania campus in West Philadelphia.

opposite page and below: The five-story building uses 467 tons of structural steel for its framing system.



marily driven by the functional needs of a campus—where space for both a loading dock and primary campus substation were carved out—and a building height limitation set to prevent the addition from overshadowing neighboring properties. This laundry list of constraints required a higher degree of creativity from the design team to provide a building that is both functional and architecturally significant. The completed project reflects elements of its neighboring structures while creating a new feature building on campus. Multiple opportunities for structural inspiration informed structural engineer Keast and Hood's final design, resulting in a creatively detailed steel framing system.

Architectural firm MGA Partners designed this striking addition to Penn's campus, gracefully balancing the ground level operational needs of facilities and the academic needs of Wharton students and faculty. The result is a design that features the openness of a rising, unfolding cantilevered glazed curtain wall system, the elegance of porcelain



Allison L. Lukachik ([@alukachik](https://www.linkedin.com/in/alukachik)) is an associate with Keast and Hood.

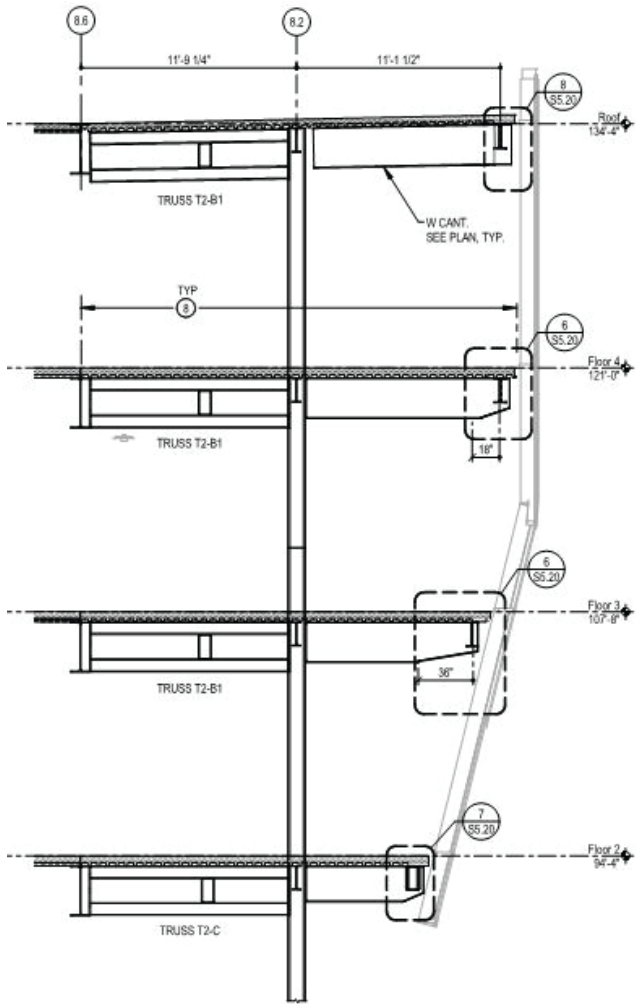

Jeffrey Totaro Photography

above and below: The feature stair in the building's West Lobby is a grand, spiraling steel structure that connects the ground, first, and second floors. AISC's Design Guide 11: *Vibrations of Steel-Framed Structural Systems Due to Human Activity* (aisc.org/dg) was consulted for its design.

left: An elevation drawing showing truss framing at various levels and the extent of cantilevered framing to create a column-free façade.

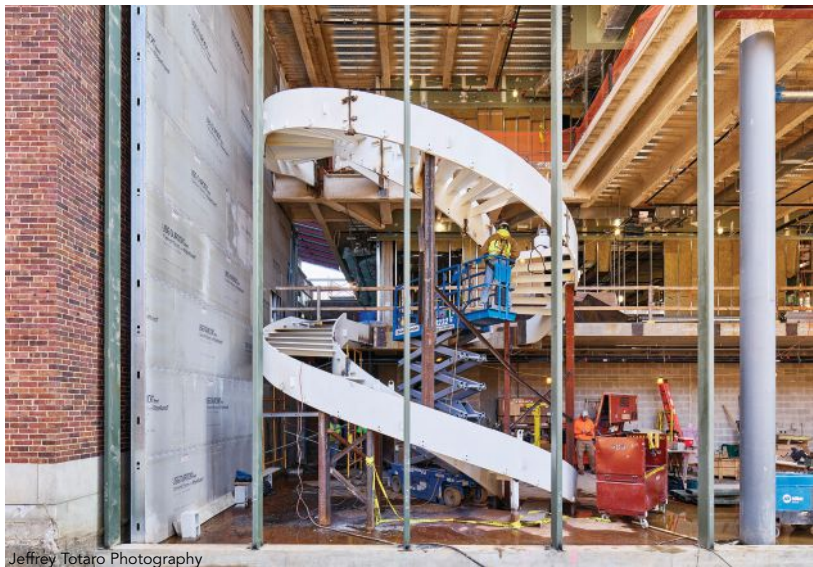

Jeffrey Totaro Photography

left: An analysis model for the vertical trusses in the southwest tower.

below: The building consists of four levels of structural steel framing above a concrete flat-plate podium level. Vierendeel trusses allow for easy distribution of MEP systems within the limited ceiling space.

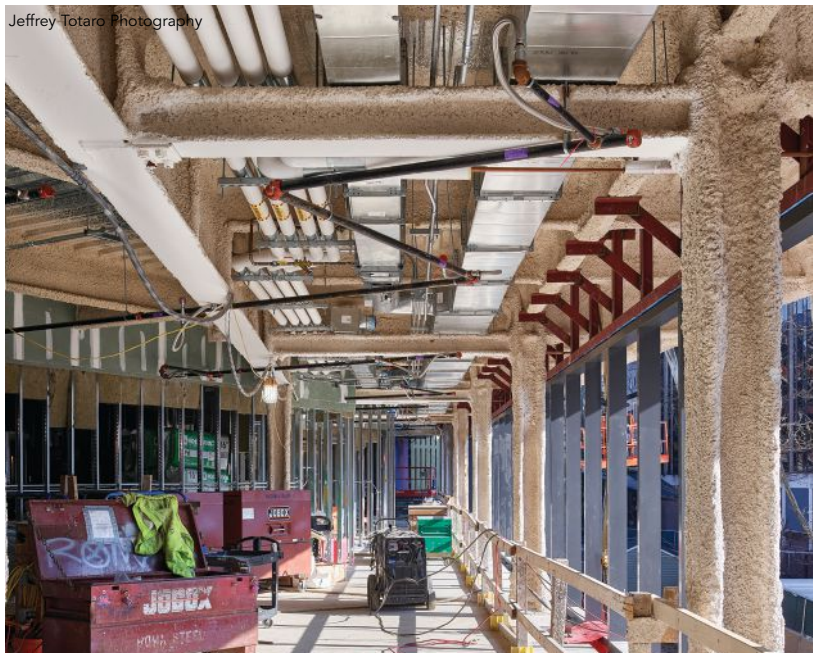

Jeffrey Totaro Photography



wall panels, and the strength of traditional brick masonry in a composition that does not compete with, nor hide from, the surrounding buildings. The \$87.65 million project is comprised of not only the new WARB structure, but also the aforementioned electrical substation (a replacement for a dated, underground facility from the 1950s), restorations to the campus' Woodland Walk, and necessary underground utility upgrades.

Design Limitations and Structural Ingenuity

WARB consists of four levels of structural steel framing above a concrete flat-plate podium level. Steel braced frames—employing wide-flange columns and beams with hollow structural section (HSS) braces in both Chevron and V-oriented bracing layouts—serve as the lateral system for the full building height, resisting wind and seismic loading. The structure was designed and detailed to accommodate the need for a phased construction approach, allowing the new ground floor electrical substation to be constructed and operational as part of Phase 1 before the decommissioning of the existing below grade substation along 37th street and the subsequent construction of the Phase 2 WARB superstructure commenced.

The building footprint fills out a triangular section on the University's campus, bound to the north by the existing Steinberg-Dietrich Hall, to the west by the 37th Street Walkway, and the southeast by the Woodland Walk. On this southeastern side, a below-grade SEPTA trolley line with setback requirements and above-grade right-of-way restrictions limited where building foundations, structural columns, and exterior walls could be located. In response, MGA created a glazed façade that respects the setback at grade, but as the building rises, the sloping curtain wall folds outward over and above, creating a spacious corridor above Woodland Walk.

The building cantilevers out beginning on the second floor from a series of structural columns held back at the ground floor. The length of cantilever varies (extending as far as roughly 15 ft) increasing both with building height and along the length traveling north. Additionally, at the curtain wall face at each level, a column-free expression was desired. To achieve this, Keast and Hood employed Vierendeel trusses (20 in all) to serve as the back span to deep-beam cantilevers that extended out beyond a column line, held back to respect the SEPTA setback requirements at grade; Vierendeel



Automated Stair & Railing Layout

WWW.AUTOMATEDLAYOUT.COM

603-402-3055

YOUR DESIGN
COULD
CHANGE THE WORLD.

The
Forge Prize
2021

Enter to win \$15,000!

Entry Deadline:
November 1, 2020
forgeprize.com



Smarter.
Stronger.
Steel.



A view from the southwest, showing one of the building's vertically oriented trusses.

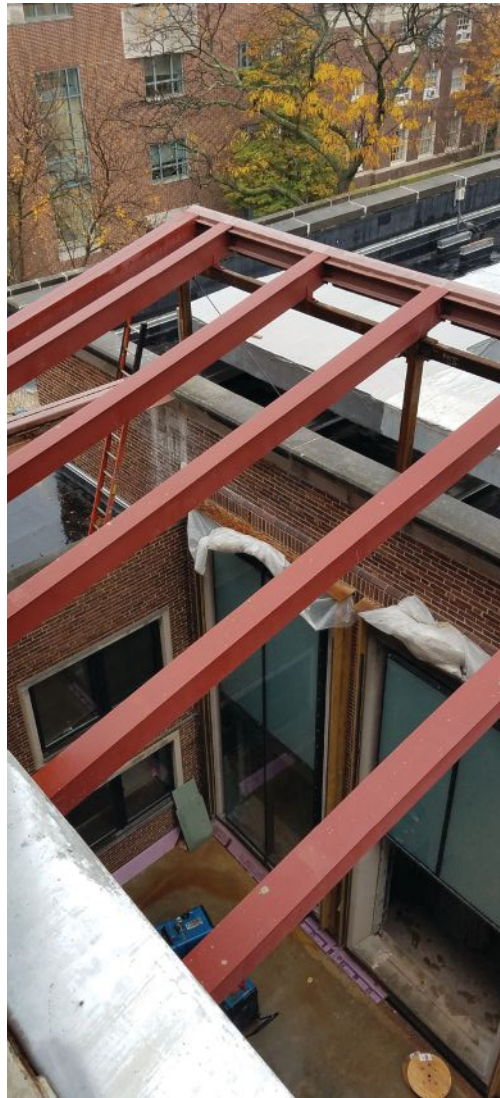

Bridging the gap between WARB and the existing Steinberg Hall is a two-story atrium topped by a skylight. The space is framed by a series of AESS rafters comprised of plate members joined to create a double-T profile.



Jeffrey Totaro Photography

trusses differ from traditional trusses in that they consist of rectangular, rather than triangular, frames. In this application, Keast and Hood designed the trusses to span over the main corridors to open up the ceiling cavity and to permit with ease mechanical and plumbing lines to travel within this space. The engineers used several programs within the Bentley RAM software suite to work through the interaction of these trusses with the more traditional composite floor system.

Within, In-Between, and Out in the Open

At the southwest corner of the site, where 37th and Spruce intersect, a large masonry tower cantilevers 13 ft over an outdoor seating area—again, with steel columns held back for both aesthetic effect and in response to SEPTA setback limitations. The original architectural vision included an exposed concrete column and beam system shown supporting this tower, and at first glance it appears that a concrete structure is indeed what was built. However, to mitigate deflection issues resulting from the significant masonry weight and the long cantilever span (coupled with an architectural request for a structure that is “as shallow as possible”)

steel framing was selected for the structure. At grade, two round concrete columns rise, supporting what appears to be a heavy concrete frame supporting the massive masonry tower above. But concealed within the concrete columns and beams is an integral wide-flange steel structure extending up throughout either side of the tower in the form of two vertically oriented trusses, working as a system to support the massive weight of the building skin while managing deflection.

Another prominent design feature is the two-story atrium space unifying WARB with Steinberg-Dietrich Hall. Bridging the gap between these two spaces is a series of AESS rafters comprised of plate members joined to create a double-T profile. These built-up members, in turn, support a glazed skylight roof, allowing natural light to spill into the space below and onto the adjoining corridor balconies of the new building. (The AESS category used is AESS 3: Feature Elements in Close View. For more on the various AESS categories, see “Maximum Exposure” in the November 2017 issue at www.modernsteel.com). To allow for the different structural effects of the existing and new buildings, an expansion joint was introduced using Con-Serv slide bearings

beneath the base plates of each skylight frame post.

Another element putting steel framing on display is the feature stair in the building's West Lobby, a grand, spiraling steel structure that connects the ground, first, and second levels. At the second floor, it ties into a horizontal steel truss introduced within the floor framing; at the first floor it anchors to large steel embedment plates cast within the flat-plate concrete slab system; and at ground level it bears on top of a massive concrete base that cantilevers partially over the repurposed existing substation basement. The stair itself primarily consists of 2-in. by 24-in. flat-plate curved steel stringers supporting built-up T-shaped steel plates that support precast terrazzo treads. A curved, glazed guardrail assembly anchored to the curved steel stringers provides the finishing touches. To provide the necessary stability and stiffness and ensure proper support and load transfer, a hidden network of structural steel plates was introduced at the floor landings and is concealed by decorative metal plating.

Keast and Hood engineers used RAM Elements to assist MGA during design of the stairs, modeling various iterations of the feature stair to better understand anticipated loading on the main building structure, projecting deflections of the stair assembly at critical points, and providing anticipated structural member depths and layouts. During the shop drawing and submittal process, Keast and Hood coordinated with the detailers and engineers at project fabricator Crystal Steel to confirm design parameters and correlate their analysis results to compatibility between analysis models.

Like all successful projects, creating something successful in the face of a significant list of constraints, while still providing a building that meets user needs, requires the continued cooperation and collaborative efforts of the entire project team—from architect to engineer to contractor to steel team. It also requires creativity and stepping outside the box of familiarity. The structural creativity implemented on the WARB project includes a mixture of steel elements that remain hidden, as well as plenty that are prominently displayed, all while navigating the constraints of a small, triangular parcel of land adjacent to a busy urban transit system. The resulting building is a functional and stately addition to the University of Pennsylvania's campus, one whose creative-thinking-within-known-bounds design methodology echoes that of a modern academic facility. ■

Owner

University of Pennsylvania, Philadelphia

Construction Manager

Hunter Roberts Construction Group, Philadelphia

Architect

MGA Partners, Architects, Philadelphia

Structural Engineer

Keast and Hood, Philadelphia

Steel Team

Fabricators

Crystal Steel Fabricators, Inc.,  Delmar, Del. (and detailer)

JGM Fabricators and Constructors,  Coatesville, Pa.

Erector

XLE Metals Corporation,  Prospect Park, Pa.

Bender-Roller

Greiner Industries, Inc.,  Mount Joy, Pa. (stairs)

BFC-530-2



ALL NEW

The all new **BFC-530-2**, a 10-press model of our beam punching line, now with automated 2-Punch capacity

- Process holes faster than any drill line or robotic plasma coping system
- Now possible to have 10 different hole sizes in one part
- Processes holes, slots and shaped holes in structural shapes up to 1" thick
- Inexpensive punch and die tooling with an overall lower machine cost

The Controlled Automation **Slug-Sucker** is the quick way for punch process slug removal with beam punching

- Available on the new BFC-530-2
- Removal of slugs from processed members on the shop floor can take up time, money and often be trip hazards
- The easy automated solution



Controlled Automation





www.controlledautomation.com | 501.557.5109

The final round of AISC's Forge Prize program resulted in three steel-famed visions of the future.

Forging the Future



ONE OF THE BEST THINGS about the Forge Prize is that it's not about thinking outside the box—because there is no box.

Established by AISC in 2018, the program recognizes designs that embrace steel as a primary structural component and capitalize on steel's ability to increase a project's speed. It is a unique opportunity for emerging architects to experiment with a conceptual design, without imposing limits to scope or complexity.

"Competitions provide a context for reimagining," said one of this year's Forge Prize judges, David Sadinsky with Turner Exhibits. "Opportunities like the Forge Prize allow research and idea exploration through a free process to develop project possibilities. When you are free from physical constraints, the sparks of optimism are free to ignite."

"With the Forge Prize, we eliminated all constraints to creativity," echoed Alex Morales, AISC's structural steel specialist for the Houston market, who leads the award program. "The Forge Prize presents emerging architects with an opportunity, on a national

platform, to be forward-thinking, daring, and innovative in design proposals that highlight the dynamic characteristics of structural steel and how their visions may fit into our buildings of the future. Our finalists took full advantage of this creative freedom and I'm excited to see what they do next."

Three 2020 finalists were judged in a live event streamed on YouTube, which you can view at youtube.com/AISCsteelTV. Each finalist won \$5,000 and got to work with a steel fabricator before presenting their ideas to the judges, who selected an overall champion. The winner received a \$10,000 grand prize and an invitation to present their design at the Architecture in Steel conference, which will take place in conjunction with NASCC: The Steel Conference in Louisville, April 14-16, 2021 (visit aisc.org/nascc/architects for information).

The 2021 Forge Prize is open for entries until November 1, 2020. Visit www.forgeprize.com for more information. And read on for descriptions and images of this year's winner and finalists.



2020 Forge Prize Judges

This year's judges were:

Matt Dumich, FAIA, SmithGroup
 Rebekah Gandy, AIA, Gensler
 David Sadinsky, Turner Exhibits

These individuals also generously devoted their time and efforts to the program:

Jennifer Anna Pazdon, PE, Vice President, Cast Connex
 Darren J. Cook, Vice President, SteelFab, Inc.,
 Texas Division
 Glenn R. Tabolt, PE, President, STS Steel, Inc.

In the landscape of competitions, the Forge Prize offered us a unique opportunity to design a project with the realities of fabrication as an integral part of its architectural premise and proposition. Our aspiration for the Footbridge was to consider structural performance and steel craft as equal parts critical to the formal character and speed of assembly for a large-scale piece of public infrastructure. In our experience, these factors are so frequently at odds with each other in the design and construction process. Our challenge was to integrate aesthetics and utility into an efficient use of material that serves a social function and takes it to a point of believability that poses a provocation in our industry.

—Rosannah Harding, AIA, and
 Matthew Ostrow, AIA

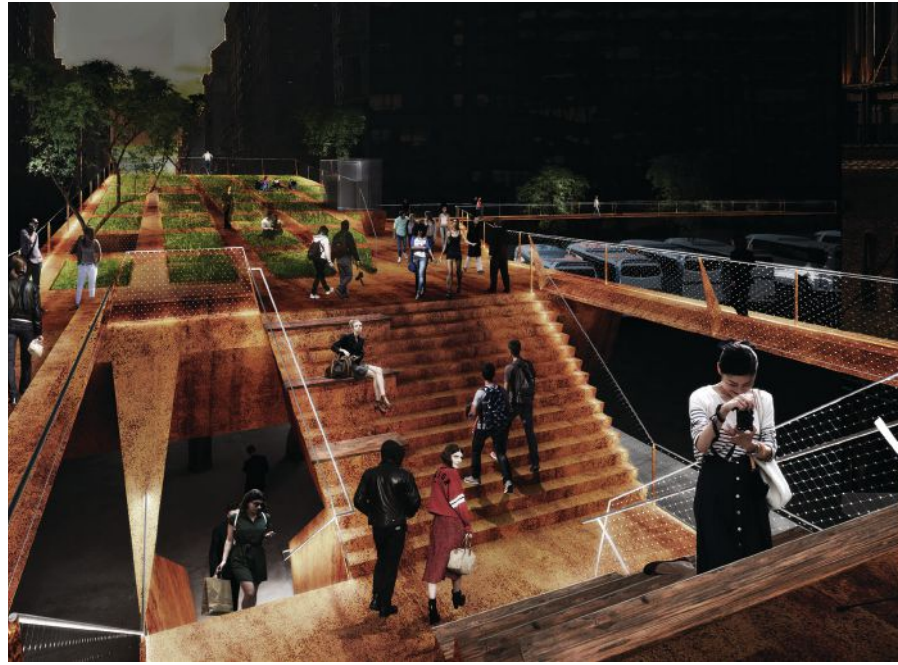

1st

Footbridge

Rosannah Harding and Matthew Ostrow
 HardingOstrow

A striking cantilevered pedestrian bridge and elevated park concept by Rosannah Harding and Matthew Ostrow of HardingOstrow took top honors in this year's competition.

Called Footbridge, the concept is intended for a site in Manhattan that connects to the existing High Line elevated park, marrying the raw look of weathering steel with the shine of hammered stainless steel planters that hold trees and other vegetation. Stormwater runoff would drip into bespoke weathering steel bollards on the plaza below, creating an immersive visual and auditory effect in inclement weather.

Harding and Ostrow worked with AISC member fabricator STS Steel, Inc., to refine their design, which capitalizes on the aspects of steel that make it ideal for such a project. Relying on the inherent strength of plate steel and the weather-resistant properties of hardy weathering steel, much of the structure could be fabricated off-site for rapid erection, and the cantilevered design would minimize the structure's footprint.

To hear more details about the project and some perspective from Harding and Ostrow, keep an eye out for their upcoming Field Notes podcast column.

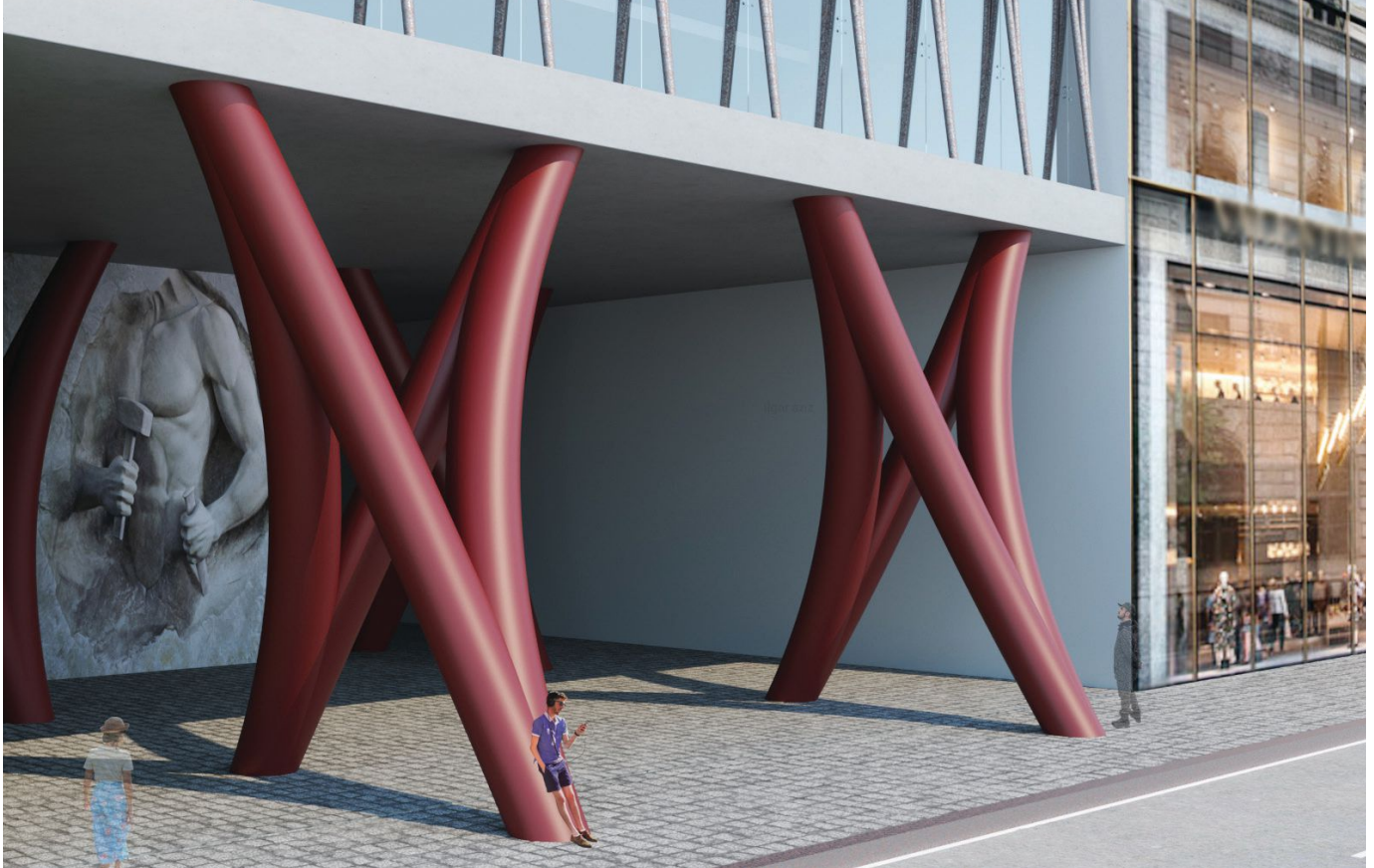

2nd Twig Structural System
 Ilgar Aziz | SBLM Architects

Ilgar Aziz of SBLM Architects proposed the Twig Structural System of organically inspired, modular structural steel components that can be used as load-bearing columns or simply as art installations.

Aziz worked with AISC member Cast Connex to further develop the design, which “moves outside of conventional methods of steel construction and proposes advantages to both shop and field work through modularization and repetition of connections,” according to Cast Connex vice president, Jennifer Anna Pazdon, PE.

“Close collaboration between engineers, architects, and builders at the outset of a project leads to the best outcome,” said Pazdon. “With the Forge Prize, we’re able to go with this best practice for future realizations.”

TWIG SYSTEMS

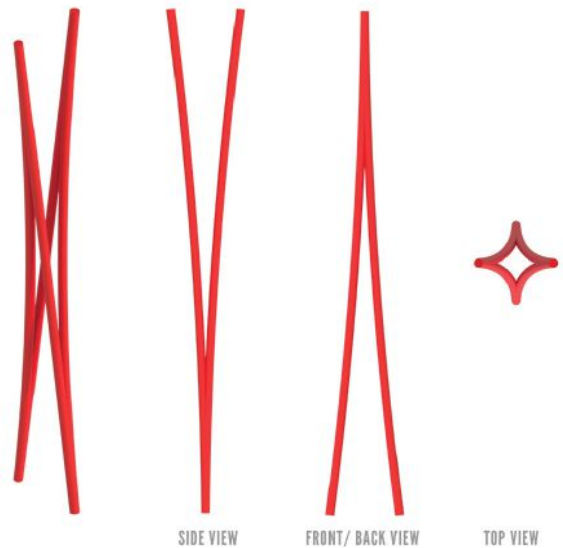

Twig systems are inspired by the natural structures found in twigs of the birch tree, legs of the blackbird, and head of the Guianan cock-of-the-rock. By mimicking the joints that are already available in nature, I designed a steel structural system that addresses design and construction challenges like practicality, aesthetics, resilience, and speed. Being part of the Forge Prize team not only motivated me to design an innovative and ambitious steel structure, but also gave me an opportunity to develop my design further under the mentorship of highly skilled and knowledgeable industry experts. It was a priceless experience.

—Ilgar Aziz

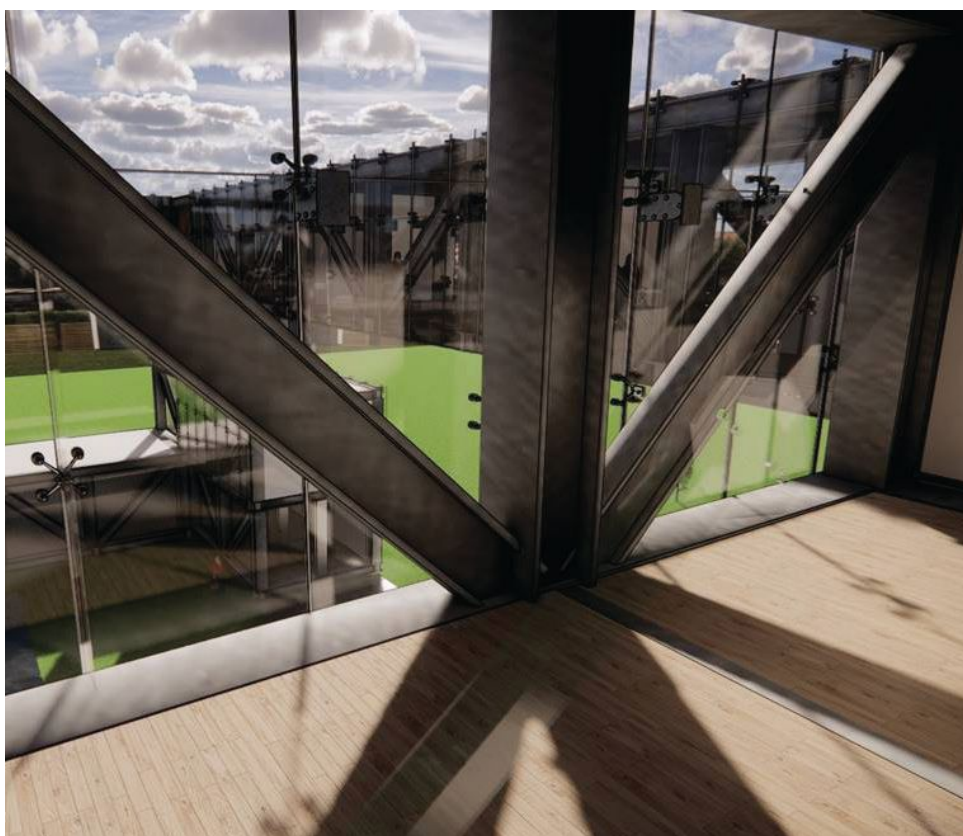

New technologies have allowed the opportunity to fireproof steel with intumescent coatings, which allow steel to be exposed on the exterior façade. On exterior applications, top coats such as fluoropolymer or aliphatic acrylic polyurethane can be used to protect steel from corrosion deterioration and offer a metallic aesthetic similar to a natural steel look. In addition, factory-controlled modular units could be produced with the aid of BIM technology and welding robots speeding construction and making steel an ideal material for construction.

—Daphne M. Florán-Meléndez, AIA

3rd

Tallahassee Multi-Purpose Complex Housing Unit

Daphne M. Florán-Meléndez
Lockwood, Andrews, and Newnam, Inc.

Daphne M. Florán-Meléndez of Lockwood, Andrews, and Newnam, Inc., created a multipurpose pedestrian complex design that uses stackable steel-framed housing units, which came in third place in this year's competition. The project is intended to rejuvenate an abandoned Tallahassee, Fla., site using steel-framed housing units that are stackable so that the complex can grow vertically as needed. Florán-Meléndez worked with AISC member fabricator SteelFab, Inc., in the second stage of the competition.

“Any opportunity to work alongside architects to showcase what steel construction has to offer is great for the steel construction business as a whole,” said SteelFab, Inc., Texas Division vice president, Darren J. Cook. ■

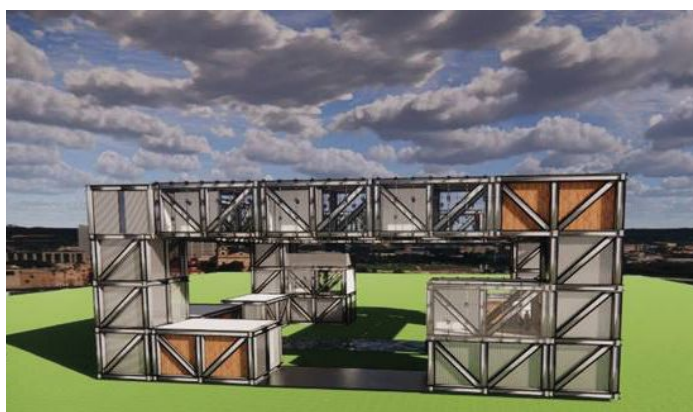

2020 HOT PRODUCTS

While would-be 2020 NASCC: The Steel Conference attendees weren't able to see the latest structural steel industry innovations in person this year, they were able to peruse them in a virtual exhibit hall as part of The Virtual Steel Conference.

This year's Hot Products were all on display and represent the wide range of machinery, technology, and other products and services that bolster the structural steel industry.

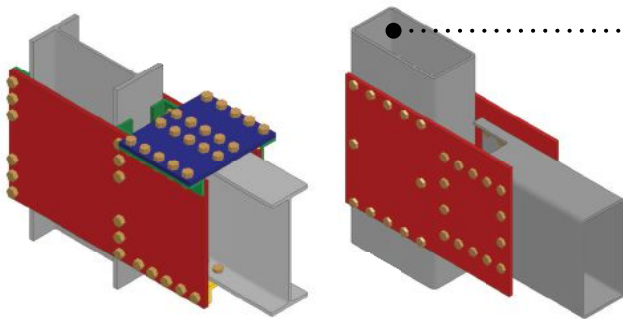

HOT BOLTED CONNECTION

SidePlate All-Bolted Moment Frame Connection

SidePlate started out with an all-welded connection design in 1995. But the construction industry wanted an easier connection design, so in 2013 the SidePlate Field-Bolted Connection was introduced. Eliminating field welding in climates with cool temperatures meant faster erection times—no preheating for welds, no weather delays. In 2020, SidePlate listened to the industry—again—and introduced the SidePlate All-Bolted connection. Available in WF-to-WF, HSS-to-HSS (available late 2020), and HSS-to-WF, these connections eliminate the need for welding in the shop and in the field!

For more information, visit www.sideplate.com.

HOT AUGMENTED REALITY

Eterio Realities, Inc., FabStation

FabStation-STEEL is bringing augmented reality (AR) steel production tools to the fabrication floor with real-time reporting and infrastructure for data exchange with the office. Drawings, 3D models, status updates, and time and material tracking are the basis of a system that will help level up your operations. At the heart of this toolset is a proprietary augmented reality technology that acts like a digital template and works by virtually placing a 3D model over the physical material it represents. This allows the fabricator to see (as viewed through a tablet or HoloLens 2) what they are building before it is built or inspect it when it is complete.

For more information, visit www.fabstn.com.

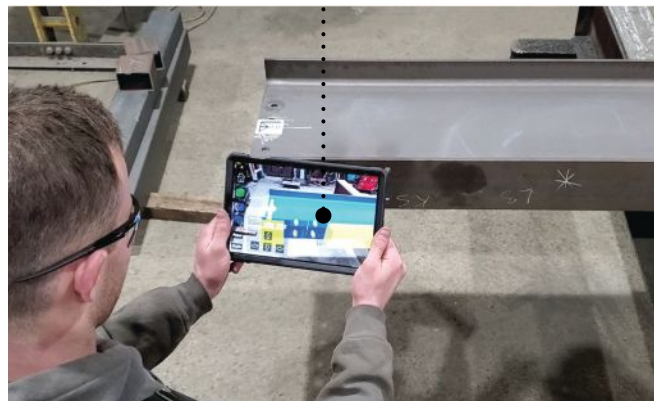



HOT ANCHOR

J-Edge Anchor System

Enclose and support façades faster with the new J-Edge continuous pour stop and anchor system. Replace old, wavy bent-plate slab edges with a high-tolerance, straight-edge design that allows bolted connections in place of field welding. Architects: Reduce building costs and potential thermal bridging. Engineers: Increase load cladding support by 200%. General and façade contractors: Take advantage of an adjustable bolted connection with the same attachment point for all façade types, as well as an optional quick-release reusable safety railing.

For more information, visit www.jedgeanchor.com.

HOT HANGER

Morgan C L Hangers, LLC, MCL Hanger

MCL center load bearing hangers affix products such as pipe, HVAC, and electrical conduit to open-web steel joists and strut bars. The concentrically installed hangers are cost-effective and designed to make installations easier, stronger, and safer. The system is designed to place the hanger and threaded rod in the gap between the joist chord angles, thus hanging concentrically from either the top or bottom chord. The hanger's low profile allows installation within 6 in. of panel points, can be used with threaded rods, carriage bolts, or standard hex-head bolts. Hangers are available in ¼-in., ⅜-in., and ½-in.-diameter rods.

For more information, visit www.mclhangers.com.

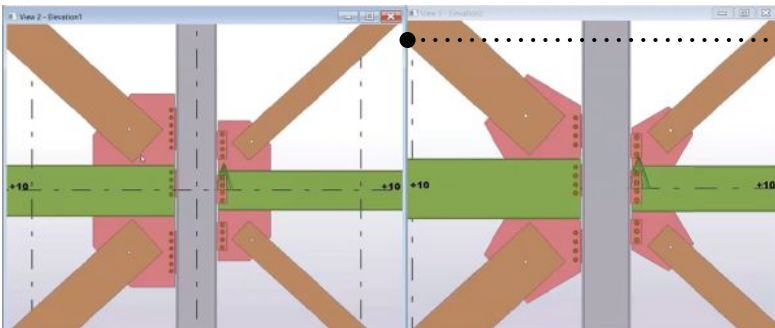
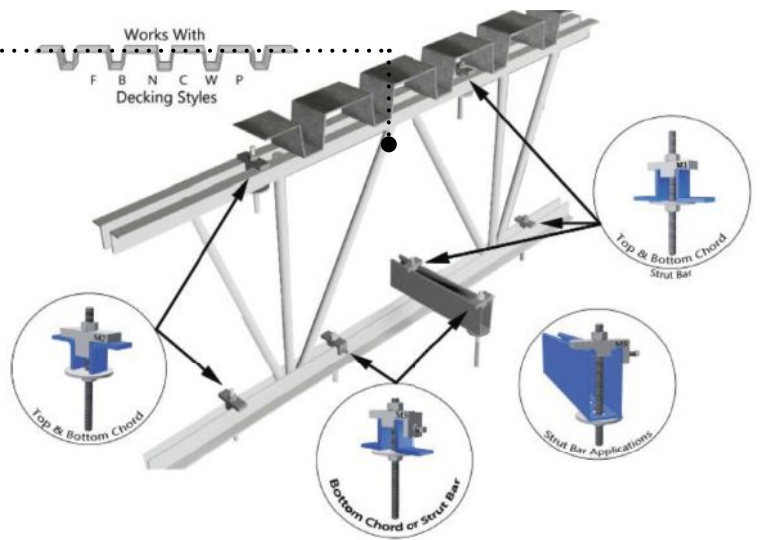

HOT CONNECTION OPTIMIZATION

Qnect, LLC, HSS Vertical Bracing

Qnect's recent update expands the software's connection optimization breadth and provides additional time and money savings to steel detailers, fabricators, and structural engineers. Vertical bracing now rounds out the full spectrum of optimized connections for the package, from gravity connections to moment connections to the lateral bracing system. What makes Qnect's vertical bracing so efficient is its patented, iterative process for optimizing all of the engineering variables. In addition, users can produce detailed reports for easy review. This new feature, combined with existing capabilities such as Preference Optimization and Bolt Optimization, can produce connection savings of 30% to 60%.

For more information, visit www.qnect.com.

All product, software, and service information was submitted by the manufacturers/developers/providers. This list does not constitute an endorsement by Modern Steel Construction or AISC.

HOT SHOP AND FIELD SOLUTIONS

Cutting (via saw or plasma), punching, welding, and construction can all be simplified thanks to these new and updated shop and field solutions.

Soitaab USA Lineatech

Soitaab's plasma grate cutting system cuts interrupted surfaces like steel or aluminum grating at high speeds, both efficiently and with high quality results. Using indirect plasma cutting, it offers the fastest, cleanest cuts on grating or expanded metals available today, and is five to ten times faster than oxy-fuel cutting. No expensive rotating head, no preheating, no loss of plasma arc, no starts and stops on each bar to damage consumables, and continuous cutting at high speeds.

For more information, visit www.soitaabusa.com.

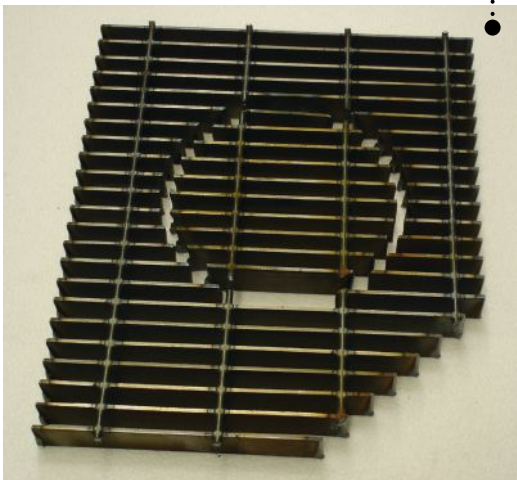

Ficep CNC Band Saw

The SN 100 CNC band saw is the latest addition to Ficep's family of automated sawing systems. All positioning functions of this new model are controlled actions to deliver optimum performance. When changing section sizes, the clamps and blade guides adjust to the desired location, and the blade feed is accomplished with a ball-screw system. This controlled axis enables rapid positioning of the blade to the ideal start-of-cut position. As the cross section of the part being processed changes, the system software, in conjunction with the ball-screw feed, adjusts the blade feed to the optimum condition for each specific portion of the cut. The company has also introduced a new technology for the unit that uses an exclusive air-dampening system to reduce blade vibration to improve cutting performance and blade life. Integrated into the fixed datum of the band saw is a magnetic back fence. This unique design, in conjunction with a rack-and-pinion positioning mechanism, enables the system to remove material that has just been cut. This capability is ideal for the automatic removal of trim cuts, short parts, and remnants without operator involvement.

For more information, visit www.ficepcorp.com.



Controlled Automation BFC-530-2

The new BFC-530-2 addition to Control Automation's beam-punching line now has an automated two-punch capacity for all punch frames. This 10-press option allows for dual-punching on all frames; it is now possible to have 10 different hole sizes in one part without changing the tooling. The machine processes holes, slots and shaped holes in structural shapes up to 1 in. thick. In addition, the company's new Slug-Sucker, available for the BFC-530-2, is a quick, automated solution for punch process slug removal, eliminating the time, money, and trip hazards related to slugs that end up on the shop floor.

For more information, visit www.controlledautomation.com.

Kobelco Welding of America, Inc., ARCMAN Structural Steel Welding Robot System

This robotic welding system features a user-friendly platform capable of high-quality, cost effective structural beam welding as well as a variety of other applications.

For more information, visit www.kobelcowelding.com.



..... **Miller Electric Mfg. LLC, XMT 350 FieldPro Multi-Process Welder**

The XMT 350 FieldPro system eliminates the time-consuming and unproductive time of walking back to the welding power source to change parameters or processes. These power sources are compatible with all ArcReach accessories, including multiple wire feeder and stick/TIG remote process options. Operators make adjustments at the point of the weld using the wire feeder or stick/TIG remote without a control cable, which can save companies hundreds or even thousands of dollars every day in downtime. The accessories provide maximum flexibility, delivering remote control capabilities for stick, MIG, TIG, and flux-cored welding. Cable Length Compensation (CLC) technology makes proper setup of welding parameters faster and easier by automatically compensating for voltage drops in the weld cable, and Adjust While Welding (AWW) technology allows for precise adjustments and parameter changes at the wire feeder or remote without stopping the arc.

For more information, visit www.millerwelds.com.

DuraFuse AXIS

AXIS includes the same superior seismic resilience and reparability of DuraFuse Frames, but now in biaxial form. Approved for SMF/IMF applications, it can be used in cruciform WF, box, and HSS configurations. Highlights include no SMF/IMF beam bracing, seismic compactness, or beam aspect ratio limits and, additionally, no field welding, simpler fabrication, and faster erection.

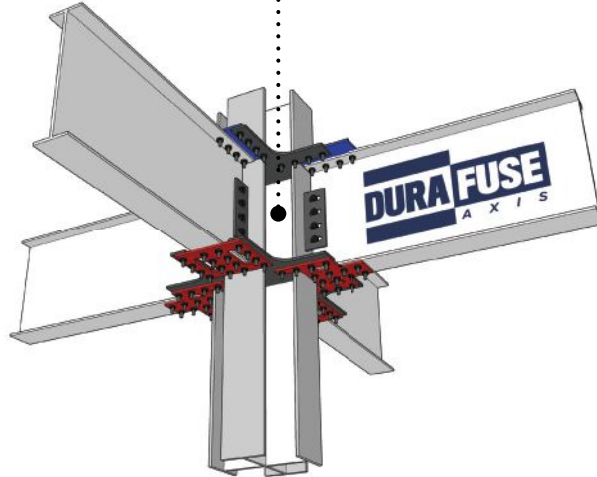

For more information, visit www.durafuseframes.com.

..... **Voortman USA V807**

The Voortman V807 has production capacity proven to be up to three times more than other suppliers in robotic thermal profile processing, without sacrificing product quality. Input for designing the V807 came from Voortman Steel Group's own experience and expertise in structural steel fabrication. Priority was placed on reducing the footprint of the machine while improving maintenance access. Installation is also simplified with a "pick-and-place" design where nearly all of the machine hardware and electronics are contained in the main unit. Automated cross-transporters and roller conveyors can get the next profiles ready for processing while the current piece is being processed, to maintain an unmatched machine on time. The V807's robot can reach all four sides of the material without needing to turn the profile, so layout marking, bolt holes, slots, weld-access holes, and more can all be processed in a single pass, giving you more finished cut-to-length parts in a normal day's production compared to other thermal profile processing machines.

For more information, visit www.voortman.net.

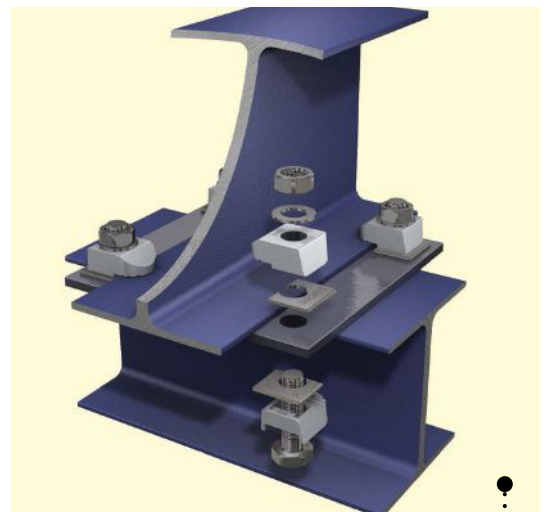

..... **LNA Solutions BeamClamp**

BeamClamp is ideal for steel-to-steel connections that don't require on-site welding or drilling. With six unique variations available in a wide range of sizes, Custom BeamClamp Assemblies are extremely versatile and can be used for connections of any shape, size, or load. BeamClamp Assemblies don't require skilled labor or power on-site for installation, making them perfect for a variety of applications, and the assemblies do not weaken, alter, or compromise the steel members being connected. Additionally, modifications can be made in order to design connections for dissimilar metals, such as steel-to-aluminum.

For more information, visit www.lnasolutions.com.

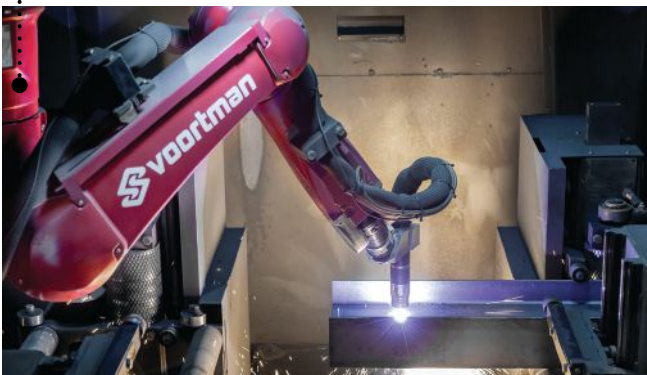

HOT SOFTWARE

Hot software offerings include updates for newer bridge types, simplified programming of robots, AI-driven algorithms, and optimized connection design.

SDS/2 Estimodeling

SDS/2 Estimodeling is the only structural steel estimating software currently available with built-in connection optimization. Powered by the intelligence of SDS/2's all-in-one 3D steel detailing model with automated connection design, it enables fabricators to generate fast and accurate model-based estimates without relying on tables or third-party software. Users can tailor estimates to their current shop standards, identify expensive fabrication conditions, and quickly compare alternative designs for cost-optimized fabrication. A robust set of tools, such as the cost estimator, allows users to spot check model costs, pre-identify RFIs, import design models, and even get a jumpstart on project detailing. As an added bonus, the 3D model serves as a great sales presentation tool to help win projects.

For more information, visit sds2.com/estimodeling.



Hypertherm, Inc., Robotmaster

Hypertherm's Robotic Software team released Robotmaster Version 7.2, the world's leading CAD/CAM based offline robot programming software. Its revolutionary state-of-the-art architecture harnesses robot flexibility to exploit the full capabilities of any robotic cell while dramatically improving the profitability of those high-mix, low-volume productions. Robotmaster's intuitive Cell and Tolling Creator gives users a new interface with real-time visual feedback enables users to calibrate, optimize, validate, and commission their robotic cell and tooling faster and more efficiently, with unparalleled ease! Robotmaster V7.2 also includes brand new welding tools that highlight how easy path creation can be in welding. The welding selection method improves path creation in a visual method, which virtually eliminates the need to modify the geometry to select the welding seams while minimizing the number of clicks. This method simplifies the overall workflow. The new Geometry Filtering feature automatically filters out bad geometry edges to create quality paths allowing path creation and smoother robotic motion.

For more information, visit www.hypertherm.com.

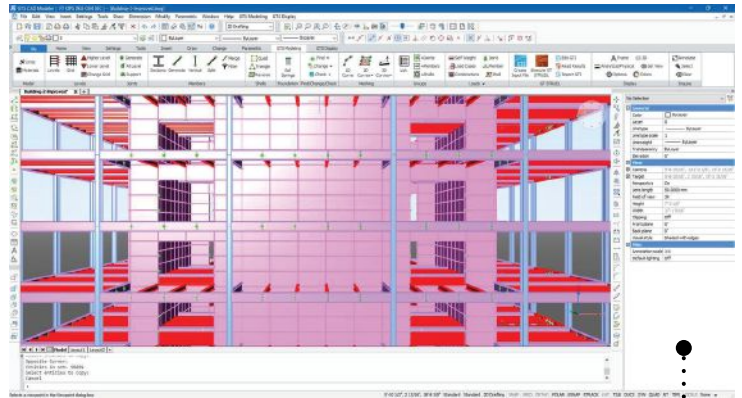

Hexagon GT STRUDL

Hexagon's trusted structural analysis and design solution for beam and FEA elements can now be run inside a CAD environment. Whether your firm uses AutoCAD or BricsCAD, GT STRUDL's CADModeler expands basic CAD tools by adding functional ribbons for creating analysis model geometry, defining loads and combinations, running analysis, and viewing results all inside a familiar CAD interface. Quite simply, this tool was created to meet the needs of structural engineers who are required to do more in less time. Additionally, a powerful FEA meshing tool empowers engineers to easily mesh planar objects defined by standard CAD arcs, lines, and circles. And by leveraging other Hexagon solutions in conjunction with CADModeler, engineers now have a workflow for converting point clouds to analytical models for expansion or retrofit projects.

For more information, visit www.hexagonppm.com.

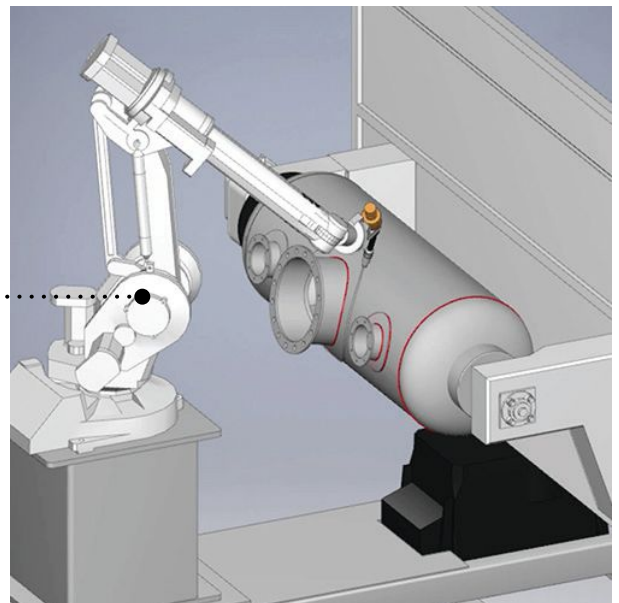

SSSBA eSPAN140

The Short Span Steel Bridge Alliance's (SSSBA) eSPAN140 is a free-to-use, interactive web-based design tool for short span steel bridges up to 140 ft long, providing bridge professionals with an all-in-one resource to design rolled beam, plate girder and buried soil structures. eSPAN140 provides standard designs and details, which expedite the overall design of the structure to ultimately reduce the overall project delivery time. Over 5,000 preliminary design solutions have been generated by bridge owners and designers since 2012, and the online tool was updated in 2020 to include press-brake tub girder solutions and simplified buried bridge options. It also includes design details such as elastomeric bearings, bearing stiffeners, intermediate, and end diaphragms and connections provided by SSSBA member companies.

For more information, visit www.shortspansteelbridges.org.

Typical Section

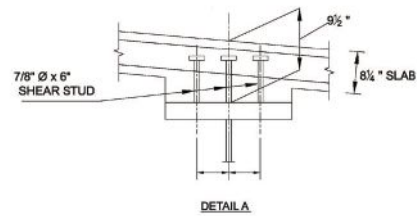
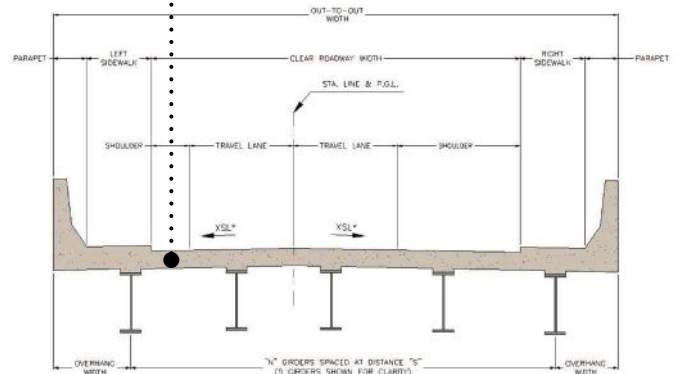

Steel Projects Corp Workshop Assistant Android and Production Manager

Manage the entire production process: import drawings from the detailing office, manage the administrative side of projects, check parts according to actual capabilities of the shop floor, make section and plate nesting, organize production before it begins, optimize workflows, create CNC data automatically for machines and automatic conveyors, digitalize work orders for manual stations, and get live feedback from production for monitoring, analyzation and traceability purposes. Finally, digitalize the management of manual workstations such as fitting, welding, painting, quality control, non-CNC machines or shipping thanks to our mobile application Workshop Assistant for Android.

For more information, visit www.steelprojects.com.

VIRTUELE

Scheduled for release in September, the VIRTUELE software suite aims to help ease connection design, fabrication, and cloud collaboration of project teams spread across the globe. VIRTUELE is an industry partner of Autodesk, and the software is integrated with Autodesk Revit, BIM360, and Forge for true cloud collaboration. VIRTUELE QTO (Quick Take Off) helps fabricators, general contractors, and engineers create an accurate material takeoff report from a Revit design stick model to prepare steel fabrication estimates during the bidding stage. It takes about 30 minutes to create a material takeoff report for a 2,000-ton job. As a true BIM platform, VIRTUELE Connect allows users to make use of engineer-created Revit structural steel design stick models and continue to work further on the steel connection design and detailing without having to start from scratch. Finally, VIRTUELE AI uses an AI-based algorithm to read design drawings in the background and links them automatically, thus saving a lot of time and frustration while searching for information in design drawings. Click on a section reference on your PDF annotated by VIRTUELE AI, and the application will display the reference section in a small pop-up window. No need to open multiple drawings to find one tiny piece of information anymore.

For more information, visit www.virtuele.us. ■

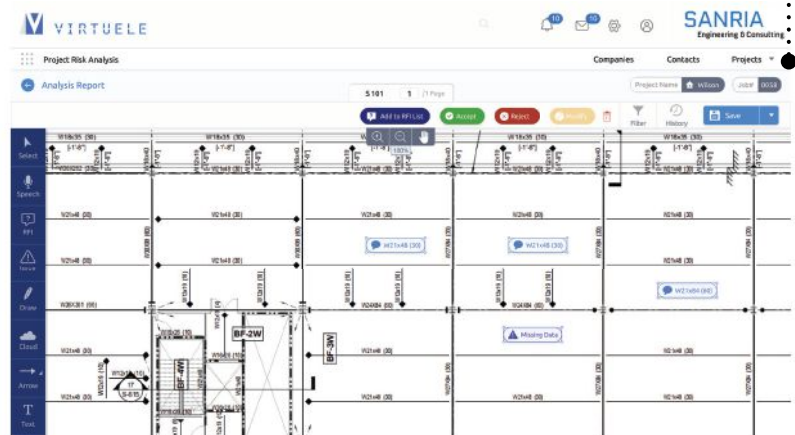

news & events

MILEK FELLOWSHIP

AISC Now Accepting Applications for Milek Fellowship

University faculty members are invited to apply for the 2021 AISC Milek Fellowship, a four-year fellowship given to a promising university faculty member to conduct structural steel research. The awarded faculty member will receive \$50,000 per year (for a total of \$200,000) as well as free registration to NASCC: The Steel Conference for the four years following their selection as an AISC Milek Fellow.

The Milek Fellowship program is designed to contribute to the research careers of young faculty who teach and conduct research investigations related to structural steel, while producing research results beneficial to steel designers, fabricators, and erectors. The program is also intended to

support students with high potential to be valuable contributors to the U.S. structural steel industry, and the selected faculty member is required to fund a doctoral candidate with at least half of the fellowship money.

Recent recipients include Matthew Yarnold from Texas A&M University for his work on optimizing rolled asymmetric beams, John Judd from the University of Wyoming for his work on inelastic design methods for steel buildings subjected to wind loads, and Gary Prinz from the University of Arkansas for his work on steel seismic systems with architectural flexibility.

Proposals will be accepted until September 18, 2020. For application information, visit aisc.org/milek.

MEMBERS

AISC Board Approves New Full and Associate Members



Full

APC Emmert Manufacturing, Marion, Iowa
Bludau Fabrication, Inc., Hallettsville, Texas
High Plains Steel Services, LLC,
Windsor, Colo.
Porter Corp., Holland, Mich.

Quality Iron and Steel, LLC, Selmer, Tenn.
Raser Steel, Reading, Pa.
Red River LLC, Gillette, Wyo.
Resolute Performance Iron, Inc.,
Tempe, Ariz.



Associate

3-WAY Steel Detailing, LLC,
Columbia, S.C., Detailer
Appz Solutions Pvt., Ltd., Vidyanagr,
Hubli, Karnataka, India, Detailer
Cavaion Baumann USA, Fredericksburg,
Va., Used Equipment Dealer
Central Industrial Group,
Wixom, Mich., Erector
Foster's Structural Detailing,
Denham Springs, La., Detailer
Golden State Bridge, Inc.,
Benicia, Calif., Erector
Gridiron Steel, Inc., Dillsburg, Pa., Erector
Industrial Construction Specialists, LLC,
Eau Claire, Wis., Erector
Infiniti Solutions,
Karvenagar, Pune, India, Detailer

J&H Erectors, Inc., Buffalo, Minn., Erector
Lunar Steel Construction,
Helmetta, N.J., Erector
M&M Steel Detailing,
Conroe, Texas, Detailer
MDI and Associates, LLC,
Houston, Texas, Detailer
NYC Constructors, LLC,
New York, Erector
RNR Steel Detailing,
West Jordan, Utah, Detailer
South Atlantic Galvanizing,
Wilmington, N.C., Coating Applier
Symbiosys Technologies, Inc.,
Chino Hills, Calif., Detailer
USICA Teknoservices, Inc.,
Vancouver, Canada, Detailer

People and Companies

- **George D. Blankenship, Lincoln Electric Holdings'** executive vice president and president of the company's Americas Welding segment, recently retired. **Christopher L. Mapes**, Lincoln's chairman, president, and CEO will oversee the Americas Welding organization until an internal successor to Blankenship is named.
- Six steel erection companies have been named as recipients of the **Steel Erectors Association of America's (SEAA)** annual Project of the Year awards. Chosen by an independent panel of judges, the winning projects topped out in either 2018 or 2019. Two AISC member erectors were among the winners: **Alliance Riggers and Constructors** for its work on Bel Air High School in El Paso, Texas, and **Peterson Beckner Industries** for the Kinder Building at the Museum of Fine Arts in Houston. (You can read all about the Bel Air High School project in "Clear Winner" in the June issue, available at www.modernsteel.com.) For more on all of the winners, visit www.seaa.net.
- The **American Society of Civil Engineers (ASCE)** has elected **Dennis Truax, PE, PhD**, as its president for the 2022–2023 term. Truax is currently the James T. White Endowed chair, department head, and a professor in **Mississippi State University's (MSU)** Department of Civil and Environmental Engineering. He is also director of MSU's Mississippi Transportation Research Center and brings experience working in the private sector as a consulting engineer and with various governmental agencies as an advisor or regulatory consultant.

Welcome to Safety Matters, which highlights various safety-related items. This month's topics include mechanical power transmission and rigging equipment for material handling.

Mechanical Power Transmission

Mechanical power transmission is any mechanical link between a motor and the machine it drives, or between parts of a machine. Often, it takes the form of belts, shafts, or drive chains. The most well-known hazard of mechanical power transmission is the danger of having a body part, hair, or clothing caught in a pinch point or by a rotating piece of the equipment, and lost fingers and more serious injuries still occur in spite of regulations to guard this equipment. A second potential hazard is that as parts rotate, sometimes at great speed, they can detach and fly from the machine. (An example is an overhead door motor that disintegrated, resulting with a part being projected from the unit and embedded in a wall 75 ft away.) A third, less dramatic hazard is the risk of scrapes and burns.

Much of the safety response to the hazards of mechanical power transmission involves machine guarding. OSHA has an eTool to help determine guarding requirements: [osha.gov/SLTC/etools/machineguarding/presses/mechanical.html](https://www.osha.gov/SLTC/etools/machineguarding/presses/mechanical.html).

ASME B15.1 and OSHA 1910.219 both provide regulations regarding guarding machines. OSHA requires that guards be inspected every 60 days. ASME B15.1 has been updated since the OSHA standard was written and has more explicit guidance regarding what constitutes sufficient guarding. Of course, training is also an important element of safety around power transmission.

Rigging Equipment

Employers must use qualified riggers during hoisting activities for assembly and disassembly work (1926.1404(r)(1)). Additionally, qualified riggers are required whenever workers are within the fall zone and hooking, unhooking, or guiding a load, or doing the initial connection of a load to a component or structure (1926.1425(c)). An OSHA fact sheet is available at [osha.gov/publications/cranes-qualified-rigger-factsheet.html](https://www.osha.gov/publications/cranes-qualified-rigger-factsheet.html).

Alloy chain slings are some of the most overused and abused pieces of rigging equipment in a facility. There is a common misconception that because they're made from alloy steel, they are not as susceptible to damage as wire rope or synthetic slings and they can lift loads far beyond their recommended limits, thus they are often misused and strained. Potential chain damage issues include:

- Cracks or breaks
- Excessive wear, nicks, or gouges
- Stretched links or fittings
- Heat damage or weld splatter
- Excessive pitting or corrosion
- Chain or fittings don't move freely

Another sling type—nylon slings—must also be properly maintained. These slings have colored threads that indicate when the sling has been worn beyond safe use. (See red, you're dead). Dirt, oil, and grease cause wear in nylon slings and reduce their usable life. Keep in mind that nylon and other synthetic slings are more susceptible to damage from environmental factors like extreme temperatures, prolonged UV exposure, and chemically active environments. They're also not as durable as steel wire rope slings or alloy chain slings when it comes to abrasion and cut resistance.

Good Business

Part of the commitment to a safe work environment means understanding that safety is good business. That's a core principle of OSHA's Safe + Sound campaign and one of the reasons we encourage every one of our organizations to look at OSHA's Safe + Sound page at [osha.gov/safeandsoundweek](https://www.osha.gov/safeandsoundweek).

Why participate? Consider these statistics: According to the U.S. Bureau of Labor Statistics, the rate of worker deaths and reported injuries in the United States has decreased by more than 60% in the past four decades since the Occupational Safety and Health (OSH) Act was passed. However, every year more than 5,000 workers are killed on the job (a rate of 14 per day) and more than 3.6 million suffer a serious job-related injury or illness.

In addition, serious job-related injuries or illnesses don't just hurt workers and their families; they can also hurt business in a variety of ways. Implementing a safety

and health program, however, can improve small- and medium-sized businesses' safety and health performance, save money, and improve competitiveness.

Safety and health programs help businesses:

- Prevent workplace injuries and illnesses
- Improve compliance with laws and regulations
- Reduce costs, including significant reductions in workers' compensation premiums
- Engage workers
- Enhance social responsibility goals
- Increase productivity and enhance overall business operations

Dates to Note

- National Immunization Awareness Month. Month of August, www.cdc.gov
- Children's Eye Health and Safety Month. Month of August, www.preventblindness.org
- Safe + Sound Week. August 17–21, [osha.gov/safeandsoundweek](https://www.osha.gov/safeandsoundweek)

We are always on the lookout for ideas for safety-related articles and webinars that are of interest to AISC member companies. If you have safety-related questions or suggestions, we would love to hear them. Contact us at schlafly@aisc.org. And visit AISC's Safety page at [aisc.org/safety](https://www.aisc.org/safety) for various safety resources. In addition, AISC has established its own resource page with information on employment, contract, and safety issues regarding COVID-19. It's at [aisc.org/covid19](https://www.aisc.org/covid19).

Off-the-job safety is an important part of your overall safety efforts.

If you are committed to safety at work, you must also be committed to safety at home.

RENEWABLE ENERGY

Gerdau Implements Massive Solar Initiative at Texas Plant

Gerdau Long Steel North America (an AISC member producer) and solar energy company 174 Power Global have entered into a 20-year power purchase agreement (PPA) to develop one of the largest behind-the-meter (BTM) solar facilities in the nation.

The 80-megawatt Gerdau Solar project, located adjacent to the Gerdau Midlothian Steel Mill in Midlothian, Texas, will be comprised of more than 231,000 solar panels spanning more than 700 acres. The BTM system will provide power directly to

the Midlothian steel mill, reducing energy consumption and costs. The Gerdau Solar project plans to use Gerdau's solar beam pilings, offset the emissions of more than 13,000 average Texas households, create more than 200 construction jobs, and generate \$19 million in tax revenue over the next 30 years.

"Gerdau has a culture of sustainability," said Gerdau Long Steel North America's president, Chia Yuan Wang. "The products from our Midlothian facility are already made from 100% recycled scrap metal.

Developing and utilizing green energy is an innovative way to further enhance our environmental contributions."

"The Gerdau Solar project will provide near-term stimulus, revenue for the city and schools, as well as long-lasting economic benefits, added Midlothian mayor Richard Reno. "Midlothian is a great place to do business, and we are pleased that Gerdau continues to invest in our community."

Construction on the Gerdau Solar facility is expected to commence by the end of 2020 and be completed at the end of 2021.

IN MEMORIAM

Bernard Dave, Former AISC Board Chair, Dies at 94

Bernard "Bernie" Dave, a former member of the AISC Board of Directors who was instrumental in AISC's relocation to Chicago, passed away on June 20. He was 94.

Bernie was president of Dave Steel Corp. (sister company to Dave Steel Company, Inc.) in Lebanon, Ohio, until its closing in 1984. He served on the AISC Board of Directors from 1970 to 1976 and was Chair of the Headquarters Study Task Force, which was created to determine the feasibility of moving AISC's headquarters from New York to Chicago, where it is currently located.

Bernie's father, Joseph Dave, also served on the AISC Board from 1959 to 1965, and his nephew, Jeffrey E. Dave, president of

Dave Steel Company in Asheville, N.C., is currently serving on the Board (since 2003) and was Board Chair from 2013 to 2015.

Bernie served as a medic in the 36th Infantry Division—European Combat Theater of the U.S. Army. He received a Purple Heart for injuries sustained in World War II and also received a Bronze Star.

He was the husband of the late Roselyn G. Dave, and is survived by daughter Teresa D. (Robert) Harrod and son Leonard Dave, grandchildren Joanna (James) Amendola, Allison (Nick) Neumeister, Dena Dave, and Avi Dave, and great-grandchildren Will Neumeister, Lila Neumeister, Ellie Neumeister, Bobby Amendola, and Henry Amendola.



PUBLICATIONS

Public Review Periods for AISC *Stainless Specification*, Code now Open

A draft of the 2022 edition of the AISC *Specification for Structural Stainless Steel Buildings* (AISC 370) will be available for public review from August 3 until September 14, 2020. This is the first public review of this specification, which is expected to be completed and available in late 2022.

The new AISC *Code of Standard Practice for Structural Stainless Steel Buildings*

(AISC 313) is available for public review until August 14, 2020. This new standard sets forth criteria for the trade practices involved in the design, purchase, fabrication, and erection of structural *stainless steel buildings*.

The drafts and review forms for both publications are available for download at aisc.org/publicreview. Hard copies are

also available (for a \$35 charge) by calling 312.670.5411. Please submit comments using the form provided online to Cynthia J. Duncan, AISC's director of engineering (duncan@aisc.org), for consideration. Again, comments for the *Stainless Steel Specification* are due by September 14, and comments for the *Stainless Steel Code* are due by August 14.

marketplace & employment



SMITH-EMERY

Inspection • Testing • Metallurgy

Assuring Structure & Life Safety Since 1904

Non-Destructive Testing

- PAUT
- Visual (CWI, CWB, CSWIP)
- MT
- UT

Owner QA

- Fabrication Oversight
- Specification Review
- Field Inspections
- WPS Reviews

Metallurgical Laboratory

- Environmental Laboratory
- Firestop Inspection

Supplier Audits

- IAS
- IAPMO
- City of Los Angeles
- Clark County, NV

Contractor QC

- Fabrication Shop NDT, CWI
- Vendor Audits
- QMS Development
- WPS and PQR Testing

Curtain Wall Performance Testing

- Concrete Testing
- Chemical Laboratory

☎ 1.833.405.0536
 ✉ steel@smithemery.com
 🌐 www.smithemery.com



Structural Engineers

Are you looking for a new and exciting opportunity?

We are a niche recruiter that specializes in matching great structural engineers with unique opportunities that will help you utilize your talents and achieve your goals.

- We are structural engineers by background and enjoy helping other structural engineers find their "Dream Jobs."
- We have over 30 years of experience working with structural engineers.
- We will save you time in your job search and provide additional information and help during the process of finding a new job.
- For Current Openings, please visit our website and select Hot Jobs.
- Please call or email Brian Quinn, PE: 616.546.9420 | Brian.Quinn@FindYourEngineer.com so we can learn more about your goals and interests. *All inquiries are kept confidential.*

SE Impact by SE Solutions, LLC | www.FindYourEngineer.com



Contract Auditor

Quality Management Company, LLC (QMC) is seeking qualified independent contract auditors to conduct site audits for the American Institute of Steel Construction (AISC) Certified Fabricators and Certified Erector Programs.

This contract requires travel throughout North America and limited International travel. This is not a regionally based contract and a minimum travel of 75% should be expected.

Contract auditors must have knowledge of quality management systems, audit principles and techniques. Knowledge of the structural steel construction industry quality management systems is preferred but not required as is certifications for CWI, COA or NDT. Prior or current auditing experience or auditing certifications are preferred but not required. Interested contractors should submit a statement of interest and resume to contractor@qmconline.org.

LATE MODEL STRUCTURAL STEEL FABRICATING EQUIPMENT

Peddinghaus AFCPS 823-B CNC Anglemaster Angle Punch & Shear, 8" x 8" x 3/4", 400 T Shear, 130 T Punch, PC Based, 2017 Upgrade, #30583

Peddinghaus FPB-1800/3 Punch/Plasma Plate Fabricator, 70 T Punch, 72" Max. Plate Width, HPR260XD, Siemens CNC, 2013, #30727

Peddinghaus AFPS 623M 6" x 6" x 1/2" CNC Anglemaster Punch & Shear Line, PC Touch Screen CNC, 250 Ton Shear, 2002, #30723

Peddinghaus PCD1100/3B 40" Beam Drill and ABCM 1250/3D Coping Line, 60' In/Out Conveyor & Transfers, 2013, #30825

Peddinghaus Ocean Liberator 5-Axis Oxy Fuel Beam Cutting & Coping Machine, 44" x 24" Max. Profile, Siemens CNC, 2016, #30821

PythonX Robotic Plasma Cutting System, HPR 260XD Plasma, 65' Infeed, 45' Outfeed Conveyor, 2012, #30687



We are actively looking for used Structural Steel Equipment, Contact claire@prestigeequipment.com

www.PrestigeEquipment.com | (631) 249-5566

Search employment ads online at www.modernsteel.com. To advertise, contact M.J. Mrvica Associates, Inc.: 856.768.9360 | mjmrvica@mrvica.com

advertiser index

| | | | |
|-------------------------------|------------------|-------------------------|----|
| AISC | 8 13 15 49 | LNA Solutions | 31 |
| Applied Bolting | 21 | Nucor Tubular | 5 |
| Automated Layout Technologies | 49 | Peddinghaus Corporation | 2 |
| Bull Moose Industries | back cover | QuickFrames USA | 14 |
| Burlington Automation | 67 | SDS/2 | 7 |
| Chicago Metal Rolled Products | insert | SidePlate | 12 |
| Controlled Automation | 51 | St. Louis Screw & Bolt | 21 |
| CoreBrace LLC | 39 | Themec Company | 39 |
| Infra-Metals | 11 | Trimble | 3 |
| Lindapter | 45 | Whitefab, Inc. | 44 |

structurally sound



SOUND (AND VISUAL) ADVICE

NEED SOME EXPERT ADVICE?

Caroline Hetzel, AISC's digital communications specialist, has interviewed this year's AISC Lifetime Achievement, Early Career Faculty, and Special Achievement Award recipients—13 industry experts in all. And you can listen to them all! One interview will be posted per week on the AISC website through late September.

The interviews include insightful input from an array of fabricators, engineers, and professors who are moving steel design and construction forward. For example, W. Samuel "Sam" Easterling, PE, PhD (pictured) gives advice to graduates from his engineering program at Iowa State University. Despite the difficult times brought on by the pandemic, he assures them that "It's a great time to be an engineer!"

You can view the interviews at youtube.com/user/AISCSteelTV. ■

Here are the 2020 winners:

Lifetime Achievement Award

- Carol Drucker, SE, PE, PEng, Principal, Drucker Zajdel Structural Engineers, Inc.
- W. Samuel Easterling, PE, PhD, Dean of Engineering, Iowa State University
- Daniel G. Fisher, Sr., Founding Partner, Girder-Slab Technologies, LLC
- Ronnie Medlock, Vice President, Technical Services, High Steel Structures, LLC
- Chia-Ming Uang, PhD, Professor, University of California, San Diego
- John M. Yadlosky, PE, Senior Bridge Engineer, HDR, Inc.

Special Achievement Award

- Michel Bruneau, PhD, PEng, SUNY Distinguished Professor, University at Buffalo
- Ron Klemencic, SE, PE, Hon. AIA, Chairman and CEO, Magnusson Klemencic Associates
- Rex I. Lewis, President, Puma Steel
- Amit H. Varma, PhD, Karl H. Kettelhut Professor of Civil Engineering, Purdue University

Early Career Faculty Award

- Emily Baker, AIA, Assistant Professor of Architecture, University of Arkansas
- Negar Elhami-Khorasani, PhD, Assistant Professor, University at Buffalo
- Julie Fogarty, PE, PhD, Assistant Professor, California State University, Sacramento

The Most Powerful Single-Source Solution in the Market



New FineLine 300HD Power Supply Now Available

Lincoln Electric® advances cutting technology by adding the FineLine® High Definition Plasma Power Source to the PythonX® STRUCTURAL System. This powerful 300A, 100% duty cycle delivers exceptional cut quality and consumable life for all-day production. The combination of our proven inverter technology with our patented 1.5" (38 mm) diameter Magnum® Pro plasma torch and consumables allow for repeatable cuts, fast gas response, arc stability, and less secondary processing, by helping to reduce operating costs.

For more information on our revolutionary technology:

Call: 1-833-PYTHONX
Email: info@pythonx.com
www.pythonx.com

PYTHONX
STRUCTURAL



©2020 Lincoln Global, Inc. All Rights Reserved.

LINCOLN
ELECTRIC

HOLLOW STRUCTURAL STEEL TUBE FROM BULL MOOSE

**BUILD A
LANDMARK.**



For projects that will stand the test of time, start with Bull Moose HSS tube.

Our direct-form manufacturing process enables us to use the highest grade HSLA steel...and form it directly into a tube.

With sizes ranging from 1.5" square to 18"x6", and wall thicknesses from 1/8" through 5/8", Bull Moose features one of the largest size ranges of HSS products in the industry.

For strength, versatility and reliability, build with Bull Moose.

BULL MOOSE ADVANTAGES

- Strength ranges of 46 KSI to 110 KSI
- Tighter tolerances, sharper edges, and straighter tubes
- Widest variety of custom sizes/lengths, including metric
- In-line NDT weld testing available on all tube
- Readily available weathering grade steel
- Fast delivery with 8 domestic sites



BULL MOOSE
For exceptional strength.

1819 Clarkson Rd.
Chesterfield, MO 63017

800.325.4467 | **BULLMOOSETUBE.COM**