

# Modern Steel Construction

July 2020



# HIGH SPEED ROBOTIC

## STEEL BEAM ASSEMBLY

- Accomplishes work of 5 fitters per shift
- Maintains 1/24" accuracy over 60' profiles
- Fit and tack pieces at 1.5 minutes per part

[www.peddinghaus.com/steel/assembler](http://www.peddinghaus.com/steel/assembler)

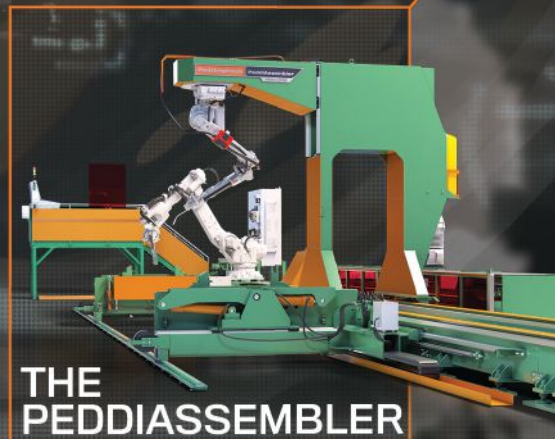

THE  
PEDDIASSEMBLER

**Peddinghaus**

**STRONGER** THAN  
STEEL®

[www.peddinghaus.com](http://www.peddinghaus.com) | [info@peddinghaus.com](mailto:info@peddinghaus.com) | (815) 937-3800

# EVERY **DETAIL** MATTERS



## Why choose High Steel for your next project?

- A reputation built on nine decades of service
- Cost-saving design suggestions to meet budget goals
- Plate girders and complex weldments to help vision become reality
- Transportation solutions that provide delivery directly to job sites

At High Steel Structures, we know that every detail matters. From project inception to completion, you can count on High Steel to be attentive to project needs, budget, scope and timelines. Whether you need one girder to complete your job or 100 girders to complete your bid, call us for competitive pricing, quality fabrication and a commitment to detail that ensures the job is done right the first time.

**High**  
**STEEL**  
**STRUCTURES** LLC  
*An Affiliate of High Industries Inc.*



Lancaster, PA | 1-800-468-9570 [HighSteel.com/details](https://HighSteel.com/details)

# Modern Steel Construction

July 2020

## in every issue

### departments

- 6 EDITOR'S NOTE
- 9 STEEL INTERCHANGE
- 12 STEEL QUIZ
- 62 NEWS & EVENTS
- 66 STRUCTURALLY SOUND

### resources

- 65 ADVERTISER INDEX
- 65 MARKETPLACE & EMPLOYMENT

23

## features

### 23 2020 Prize Bridge Awards

The winners of this year's Prize Bridge Awards span everything from a rugged section of Lake Tahoe's shoreline to a tight Idaho Canyon to a wide stretch of railroad tracks along Chicago's lakefront to a high-profile expressway in Philadelphia's Center City to the Hudson River's massive Tappan Zee.

### 60 Essential and Available

BY GEOFF WEISENBERGER

While the COVID-19 pandemic has taken a massive toll in terms of lives, jobs, and industries, the domestic structural steel industry remains vibrant.

## columns

### steelwise

### 16 How Low Can You Go?

BY WILLIAM A. THORNTON, PE, PhD

A brief look at the lower bound theorem of limit analysis.

### field notes

### 18 There and Back Again

INTERVIEW BY GEOFF WEISENBERGER

AISC's next board chair started off as an engineer—just not the type you'd think for the president of a prominent structural steel fabrication company.

### business issues

### 20 Opportunity Knocks

BY BILL ISSLER

Want to attract a new generation of shop labor? Try technology.



New York State Thruway Authority

**ON THE COVER:** The Portageville Bridge spans the "Grand Canyon of the East" in Upstate New York. Read all about it and the rest of this year's Prize Bridge Award winners, starting on page 23. (Photo: John Kutcho)

MODERN STEEL CONSTRUCTION (Volume 60, Number 7) ISSN (print) 0026-8445; ISSN (online) 1945-0737. Published monthly by the American Institute of Steel Construction (AISC), 130 E Randolph Street, Suite 2000, Chicago, IL 60601. Subscriptions: Within the U.S.—single issues \$6.00; 1 year, \$44. Outside the U.S. (Canada and Mexico)—single issues \$9.00; 1 year \$88. Periodicals postage paid at Chicago, IL and at additional mailing offices. Postmaster: Please send address changes to MODERN STEEL CONSTRUCTION, 130 E Randolph Street, Suite 2000, Chicago, IL 60601.

**DISCLAIMER:** AISC does not approve, disapprove, or guarantee the validity or accuracy of any data, claim, or opinion appearing under a byline or obtained or quoted from an acknowledged source. Opinions are those of the writers and AISC is not responsible for any statement made or opinions expressed in MODERN STEEL CONSTRUCTION. All rights reserved. Materials may not be reproduced without written permission, except for noncommercial educational purposes where fewer than 25 photocopies are being reproduced. The AISC and Modern Steel logos are registered trademarks of AISC.



Printed on paper made from a minimum of 10% recycled content.

# Steel Fabricator's Competitive Advantage

## Steel Fabrication Management Software That Can Help You Win More Business

Steel fabricators that use Tekla PowerFab avoid the need to add a margin of error to their competitive bids because they have a high degree of confidence in their cost estimates. PowerFab users are able to submit bids that are as competitive as possible while accurately meeting their desired profit margin.

Don't get left behind, visit [teklapowerfab.com](http://teklapowerfab.com) to learn all the ways Tekla PowerFab can help you increase your competitive advantage including improving bid accuracy.

## editor's note



Nearly three decades ago, I witnessed the end of a positive working relationship.

Two of my colleagues who never really liked each other much to begin with were debating a technology-related issue. I can't remember the specific topic, but one statement is forever seared in my memory. During the disagreement, one of my colleagues claimed the other was ignorant. The problem was he was technically correct; the classic definition of ignorant is "lacking knowledge, information, or awareness about a particular thing." But almost everyone who is called ignorant doesn't think of the classic definition—rather they think they're being called stupid. And so the relationship ended.

When I talk about AISC, I sometimes have a similar issue. By purposeful intent, AISC is a conservative organization. Unfortunately, the word "conservative" today is too often used in a political context and carries a lot of either positive or negative baggage depending on your viewpoint. But I use it for its classic definition: to purposely exercise caution. Because one of AISC's guiding principles is scrupulous regard for public safety, we write specifications with the goal to leave sufficient room for unknown factors. My former colleague Geerhard (Jerry) Haijjer used to call this "the reserve strength of steel."

Recently, AISC has received questions about the apparent brittle fracture on a significant new building in San Francisco. Technical inquiries are not unusual and AISC has a specific procedure for addressing them.

If the issue is clearly addressed in established technical information, AISC provides an answer based on that information. You can see many examples of this in our vast archives of monthly Steel Interchange columns. We also answer hundreds of questions each month that are sent to AISC's Steel Solutions Center (email your question to [solutions@aisc.org](mailto:solutions@aisc.org) or visit [aisc.org/solutions](http://aisc.org/solutions)).

When we don't have enough information to answer, we don't guess. Rather, we seek information from others who do have the necessary information. In a case like the Salesforce Transit Center, where there remains a need for further information, we bring together a panel of leading experts to study and address the issue. In this case, an ad hoc committee was established last November and is examining what happened and whether any changes to AISC's or other design specifications and recommendations are needed; we're also collaborating and coordinating with relevant groups

within AWS and ASTM. Until that study is complete, we won't be able to offer a specific recommendation regarding the Salesforce Transit Center.

However, we do know that because AISC and, in general, engineers tend to be conservative, the requirements of the *Specification* and other resources used in design establish common design, detailing, fabrication, and inspection practices that have historically been sufficient to prevent brittle fracture. While brittle fracture is rare, especially in buildings, there are cases where it must be considered, including loading, material toughness, temperature, and design and detailing to avoid conditions that are susceptible to such fractures.

Some of the available resources include:

- Part 2 of the *Manual* contains a discussion titled "Avoiding Brittle Fracture."
- The commentary to *Specification* Section A3 discusses material properties related to brittle fracture including toughness and the effect of temperature.
- The commentary to *Specification* Section J1.5 discusses brittle fracture as it relates to splices in heavy sections.
- The commentaries to *Specification* Sections 3.1 and 3.5 also briefly touch on the subject of brittle fracture.
- Chapter 13 of AISC Design Guide 21: *Welded Connections—A Primer for Engineers* (a free download for AISC members at [aisc.org/dg](http://aisc.org/dg)) addresses fracture-resistant welded connections.

In addition, Duane Miller, manager of engineering services at The Lincoln Electric Co. and one of the world's foremost experts on welding, has over the years offered a large number of sessions at NASCC: The Steel Conference. You can view many of these for free at [aisc.org/educationarchives](http://aisc.org/educationarchives).

Finally, there is also the book *Fracture and Fatigue Control in Steel Structures* by Stan Rolfe and John Barsom. It has been the seminal reference on the topic since it was first published in the 1970s.

Few in the design community are experts on all of these issues, and these resources provide the tools we need to prevent brittle fracture.

  
Scott Melnick  
Editor

# Modern Steel Construction

## Editorial Offices

130 E Randolph St, Ste 2000  
Chicago, IL 60601  
312.670.2400

## Editorial Contacts

EDITOR AND PUBLISHER

Scott Melnick  
312.670.8314  
[melnick@aisc.org](mailto:melnick@aisc.org)

SENIOR EDITOR

Geoff Weisenberger  
312.670.8316  
[weisenberger@aisc.org](mailto:weisenberger@aisc.org)

DIRECTOR OF PUBLICATIONS

Keith A. Grubb, SE, PE  
312.670.8318  
[grubb@aisc.org](mailto:grubb@aisc.org)

PRODUCTION SPECIALIST

Erika Salisbury  
312.670.5427  
[salisbury@aisc.org](mailto:salisbury@aisc.org)

GRAPHIC DESIGN MANAGER

Kristin Hall  
312.670.8313  
[hall@aisc.org](mailto:hall@aisc.org)

## AISC Officers

CHAIR

Jack Klimp, Cianbro Fabrication  
& Coating Corporation

VICE CHAIR

Stephen Knitter  
Geiger & Peters, Inc.

SECRETARY/LEGAL COUNSEL

Edward Seglias, Cohen Seglias  
Pallas Greenhall & Furman, PC

PRESIDENT

Charles J. Carter, SE, PE, PhD

SENIOR VICE PRESIDENT

Scott Melnick

VICE PRESIDENT

Lawrence F. Kruth, PE

VICE PRESIDENT

Mark W. Trimble, PE

## Editorial Advisory Panel

Caroline R. Bennett, PE, PhD  
University of Kansas

Amanda Dean, PE

Walter P Moore

Bryan Frazier,

Zalk Josephs Fabricators, LLC

Keith R. Griesing, PE

Hardesty and Hanover

Stephen Knitter

Geiger & Peters, Inc.

## Advertising Sales

M.J. Mrvica Associates, Inc.

2 W Taunton Avenue

Berlin, NJ 08009

856.768.9360

[mjmrvica@mrvica.com](mailto:mjmrvica@mrvica.com)

## Address Changes and Subscription Concerns

312.670.2401

[subscriptions@aisc.org](mailto:subscriptions@aisc.org)

## Reprints

Erika Salisbury

312.670.5427

[salisbury@aisc.org](mailto:salisbury@aisc.org)



# 3D steel detailing software designed to optimize your fabrication.

PVS Structures produces quality structural steel products for projects up to 20,000 tons around the world. Top of the line detailing and fabrication software like SDS/2 help make it possible. Learn how PVS Structures is boosting their fabrication efficiency with SDS/2 at [SDS2.com/PVS-Structures](https://SDS2.com/PVS-Structures).

SDS/2 customer Tom Horswill, Robot Technician at PVS Structures in Carter Lake, Iowa

 **SDS/2**  
A NEMETSCHek COMPANY

# CALLING ALL INNOVATORS!

If you recently worked on an amazing project that featured structural steel, we want to hear from you. Submit it for a 2021 IDEAS<sup>2</sup> award!

Entries close on October 15, 2020.

.....

enter now at [aisc.org/ideas2](https://aisc.org/ideas2)



2020 IDEAS<sup>2</sup> National Award  
**Mori Hosseini Student Union—**  
**Embry-Riddle Aeronautical University,**  
Daytona Beach, Fla.  
Photo: Brad Feinknopf



2021  
**IDEAS<sup>2</sup>**  
**AWARDS**

Innovative Design in Engineering and  
Architecture with Structural Steel



If you've ever asked yourself "Why?" about something related to structural steel design or construction, *Modern Steel's* monthly Steel Interchange is for you! Send your questions or comments to [solutions@aisc.org](mailto:solutions@aisc.org).

## steel interchange

All mentioned AISC codes and standards, unless noted otherwise, refer to the current version and are available at [aisc.org/specifications](http://aisc.org/specifications). Design guides can be found at [aisc.org/dg](http://aisc.org/dg), Modern Steel Construction articles can be found at [www.modernsteel.com](http://www.modernsteel.com), and Engineering Journal articles can be found at [aisc.org/ej](http://aisc.org/ej).

### Standard for SpeedCore

**Will there be a separate standard to address the design of SpeedCore structures?**

No. The design of SpeedCore will be addressed through the AISC *Specification for Structural Steel Buildings* (ANSI/AISC 360) and AISC *Seismic Provisions for Structural Steel Buildings* (ANSI/AISC 341). Note that the most up-to-date information about and resources for the SpeedCore system is available at [aisc.org/speedcore](http://aisc.org/speedcore).

Here is a list of the standards and codes that currently address SpeedCore (concrete-filled composite steel plate shear walls) and the status of incorporating the coupled version of the system in the same standards and codes. Please note that the 2022 AISC standards are still in development and subject to change:

#### AISC Specification

- Current (360-16) Chapter I: Design of Composite Members generally addresses all composite construction.
- In progress for the next edition (360-22): A new section for composite walls is being considered in Chapter I.

#### AISC Seismic Provisions

- Current (341-16) Section H7: Composite Plate Shear Walls—Concrete Filled (C-PSW/CF) addresses uncoupled walls (no link beam to couple two walls).
- In progress for the next edition (341-22): Coupled Composite Plate Shear Walls—Concrete Filled (CC-PSW/CF), if approved, is intended to address all of the system-specific requirements such as detailing. Updates to C-PSW/CF are also being considered to reflect recently completed research as well.

#### AISC Design Guide

A new AISC Design Guide is in development. The Pankow Foundation has published its own design guide, which is conservative but correct in its content. The AISC Design Guide will take into account all of the research currently underway.

#### ASCE 7 Standard

- Current (ASCE 7-16): Steel and concrete composite shear walls are included in Table 12.2-1 as a recognized system. Section 14.3 lists the applicable codes and standards for composite design.
- In progress for the next edition (ASCE 7-22): Coupled "Steel and concrete composite shear walls" have been FEMA P695 tested and has been approved with an  $R=8$  for inclusion in ASCE 7-22. Ultimately, the goal is for Table 12.2-1 to include the coupled system and all the design and detailing requirements would be in the AISC *Seismic Provisions*.

#### Fire

Recent research was completed and documented in *Performance-Based Fire Engineering of Buildings with Concrete-Filled Composite Shear Walls (SpeedCore)*, which shows that you can obtain a 2-hour fire rating on a 12-in.-thick wall with no fireproofing being applied. The report is available at [aisc.org/research](http://aisc.org/research) under "Research Updates."

There is a lot in the works right now, but the hope is that by 2022, all of the new standards should have SpeedCore systems integrated.

*Jennifer Traut-Todaro, SE*

### Collaboration with AISI

**I heard that the AISC committee that manages Appendix 4: Structural Design for Fire Conditions in the AISC Specification is working together with the American Iron and Steel Institute (AISI). What is the benefit of this collaboration?**

AISI serves as the voice of the North American steel industry in the public policy arena and advances the case for steel in the marketplace as the preferred material of choice. The organization has a long history of being a leader in fire testing and research for steel, with some of their publications dating back as far as the 1960s. The partnership for the AISI/AISC Fire Committee (TC 8) was formed in 2016 to foster collaboration and unify efforts. For example, there are plans for the 2022 AISC *Specification* to adopt AISI content into Appendix 4 as it relates to fire resistance calculations for structural steel.

For more insight on the various task committees involved in the development of the AISC *Specification* and *Seismic Provisions*, see the article "Raising the Standard" in the January 2020 issue, available at [www.modernsteel.com](http://www.modernsteel.com).

*Kristi Sattler, SE, PE, PhD*

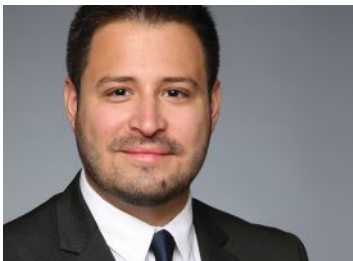

**Jennifer Traut-Todaro** is a senior staff engineer and **Jonathan Tavarez** is a staff engineer, both with AISC's Steel Solutions Center. **Kristi Sattler** and **Nate Gonner** are both senior engineers with AISC's education department.



**STEEL SOLUTIONS CENTER**

Steel Interchange is a forum to exchange useful and practical professional ideas and information on all phases of steel building and bridge construction. Contact Steel Interchange with questions or responses via AISC's Steel Solutions Center: 866.ASK.AISC | [solutions@aisc.org](mailto:solutions@aisc.org)

The complete collection of Steel Interchange questions and answers is available online at [www.modernsteel.com](http://www.modernsteel.com).

## AISC 342: Seismic Evaluation and Retrofit of Existing Structural Steel Buildings

**Will AISC 342-20 be completely different from ASCE 41-17?**

AISC 342 is expected to be the successor to ASCE 41-17 Chapter 9. There will be an immediately noticeable change in its organization. Many of the sections will be dedicated to components rather than lateral systems, and there will be some technical developments one would expect to see from one iteration of the code to the next. However, AISC 342 will not stray from the overarching design philosophies of ASCE 41, and will continue to be dependent on the earlier chapters of ASCE 41.

*Nate Gonner, SE*

### ASD vs. LRFD

**I am a structural engineer working on a project for which I recently submitted a design to another engineer for approval. I designed the structure using load and resistance factor design (LRFD). The engineer checking the design decided to rerun the design using allowable strength design (ASD). Several of the members failed, and the engineer claims that our design is not satisfactory. We believe the design is okay since the members are adequate when using LRFD. Could you share your thoughts on this?**

The AISC *Specification* provides design requirements for both the LRFD and ASD methodology. They are both acceptable alternatives, as the Commentary for Section B3.1 states: "Load and resistance factor design (LRFD) and allowable strength design (ASD) are distinct methods for satisfying strength limit states. They are equally acceptable by this *Specification*, but their provisions are not interchangeable. Indiscriminate use of combinations of the two methods could result in unpredictable performance or unsafe design. Thus, the LRFD and ASD methods are specified as alternatives. There are, however, circumstances in which the two methods could be used in the design, modification, or renovation of a structural system without conflict, such as providing modifications to a structural floor system of an older building after assessing the as-built conditions."

AISC affirms that designs based on either LRFD or ASD will either be identical or very similar. For additional insight, note that the LRFD and ASD methods are calibrated at a live-to-dead load ratio of 3/1. If  $L/D = 3$ , then the design should essentially be the same. Consider the two load combinations when  $L/D = 3$ :

$$\text{LRFD: } 1.2D + 1.6L = 1.2 \times 1 + 1.6 \times 3 = 6$$

$$\text{ASD: } D + L = 1 + 3 = 4$$

The difference between LRFD and ASD is  $6/4 = 1.5$

1.5 is the same value if you compare the resistance and safety factors provided in the *Specification*. At an  $L/D$  ratio greater than or less than 3, the required member size may be different depending on which method is used, but in these cases, the resulting design for both methods is acceptable. The magnitude of difference would increase slightly the further you get away from the 3/1 ratio, but overall should still result in similar designs.

It is not advisable to mix design methods on a project. If the structure is designed using LRFD, the checking should be done using LRFD. Even though LRFD and ASD are calibrated, different load combinations are used in each design method, which can lead to slightly different result.

*Jonathan Tavarez, PE*



# SMITH-EMERY

Inspection • Testing • Metallurgy

## Assuring Structure & Life Safety Since 1904

Our knowledge and expertise assure your project's critical structural components are compliant with the prevailing requirements.

### Fabrication & Field Services

Full range of quality assurance and quality control services; inspections, testing, audits, Inspection Test Plan (ITP) development, QMP's and more to meet the needs of the owner or contractor.

### Advanced NDT & Laboratory Services

Phased Array Ultrasonics comprehensive field testing using the most advanced technology, including Phased Array Ultrasonic.

### Global & Domestic Reach

Resources, personnel and operations ready to deploy worldwide.



1.833.405.0536



steel@smithemery.com



www.smithemery.com



Los Angeles, CA  
San Francisco, CA  
Anaheim, CA  
Fresno, CA  
Oakdale, WA

New York, NY  
Montreal, Quebec, Canada  
Shanghai, China  
Chumphon, Thailand



# steel quiz

This month's quiz is based on bridges. The questions span (pun intended) from specifications to design to constructability.

The answers can be found in: AASHTO/NSBA Collaboration G12.1: *Guidelines to Design for Constructability* (available at [aisc.org/gdocs](https://www.aisc.org/gdocs)), S2.1-2018: *Steel Bridge Fabrication Guide Specification* (available at [aisc.org/sdocs](https://www.aisc.org/sdocs)), AASHTO *Bridge Construction Specification*, AASHTO *LRFD Bridge Design Specification*, Federal Highway Administration *Technical Advisory*, and AWS D1.5: *Bridge Welding Code*. AASHTO specifications may be purchased at [store.transportation.org](https://store.transportation.org).

- 1 True or False:** Cross frames and diaphragms on horizontally curved bridges are considered "primary" and shall conform to the applicable Charpy V-notch impact testing.
- 2** Name the four specifications that form the basis of the AASHTO fracture-control plan (FCP).
- 3 True or False:** A fracture-critical member (FCM) is fabricated to the same standards as a non-fracture-critical member.
- 4 True or False:** Weathering steel's corrosion resistance is enhanced by applying a coating system.
- 5** Compact and non-compact sections, when used as a steel composite beam, shall satisfy which of the following equations to meet the ductility requirement as required by the AASHTO *LRFD Bridge Design Specification*?  
**a.**  $D_p \leq 0.1D_t$       **b.**  $D_p \leq 0.42D_t$       **c.**  $D_p \leq 0.84D_t$   
Where  
 $D_p$  = distance from top of the deck to the neutral axis of the composite section at the plastic moment.  
 $D_t$  = total depth of composite section.
- 6** For a given span length of 175 ft, what is the recommended girder spacing? (Hint: Check out the AASHTO/NSBA G12.1-2016: *Guidelines to Design for Constructability*.)
- 7** According to ANSI B46.1 or S2.1-2018: *Steel Bridge Fabrication Guide Specification*, what is the maximum permitted surface roughness for sliding bearings?
- 8 True or False:** When performing a refined analysis, cross frame forces due to load-induced fatigue should be computed by positioning the fatigue truck in two different transverse positions such that the largest range of stress or torque is achieved.

TURN TO PAGE 14 FOR THE ANSWERS

## INNOVATE FREELY

**Creative.**  
**Integrated.**  
**Transformative.**

**CAST CONNEX**® provides custom casting design-build services for projects that benefit from a holistic design composition unachievable by conventional fabrication methods.

### Customizable Solutions

- Simplifies complex connections
- Ideal for architecturally exposed applications
- Resolves connections subject to very high loading and fatigue
- Economically addresses repetitive details with high-quality and consistency



**CUSTOM CASTING**  
[www.castconnex.com](https://www.castconnex.com)

**CASTCONNEX**®  
innovative components for inspired designs

Salesforce Transit Centre, CA  
Designed By: Pelli Clarke Pelli  
Structural Engineers: Thornton Tomasetti with  
Schlaich Bergermann Partner  
Photography by: Jason O'Beirne Photography

# Sit. Stay. Seismic.

The new 3rd Edition **Seismic Design Manual** includes more than 800 pages of comprehensive design examples covering most types of steel and composite seismic force resisting systems, including  $R = 3$  systems.



**RETRIEVE  
YOURS  
TODAY!**

\$100 Members | \$200 Non-Members  
[aisc.org/publications](http://aisc.org/publications) | 800.644.2400



**Smarter. Stronger. Steel.**

American Institute of Steel Construction  
312.670.2400 | [www.aisc.org](http://www.aisc.org)



- 1 **False.** Article 11.3.1.1 of the AASHTO *LRFD Bridge Construction Specification* now exempts cross frames and diaphragms from Charpy V-notch impact testing.
- 2 The FCP addresses material toughness, design, fabrication, and field inspection. Material toughness is addressed by ASTM A709-13a, design by the AASHTO *LRFD Bridge Design Specification*, fabrication by Section 12 of the AASHTO/AWS D1.5M/D1.5 *Bridge Welding Code*, and inspection by the AASHTO *Manual for Bridge Evaluation*.
- 3 **False.** Fabrication of FCMs is governed by the AASHTO/AWS D1.5 *Bridge Welding Code*, Clause 12: AASHTO/AWS Fracture Control Plan (FCP) for Non-Redundant Members. The provisions of Clause 12 ensure the highest possible quality of fabrication by increasing the quality of materials (additional toughness), welding procedures, shop inspections, and weld repair provisions. There have been no reported fractures for FCMs designed and fabricated since the FCP was first implemented more than 40 years ago.
- 4 **False.** When properly detailed and used in accordance with FHWA Technical Advisory 5140.22 (available at [fhwa.dot.gov/bridge/t514022.cfm](http://fhwa.dot.gov/bridge/t514022.cfm)), weathering steel forms a protective oxide layer from its exposure to wet/dry cycles. The application of a coating system inhibits this process and only adds to the first time and long-term maintenance costs of the bridge. Research has shown that design and maintenance practices may be more influential to the performance of weathering steel than climate.
- 5 **b.** According to Section 6.10.7.3 of AASHTO *LRFD Bridge Design Specification*, compact and non-compact sections shall satisfy  $D_p \leq 0.42D_t$ . This is to ensure significant yielding of the bottom flange when the crushing strain is reached at the top of the deck and to protect the concrete deck from premature crushing.
- 6 **Between 11 ft and 13 ft.** According to Section C1.2 of *Guidelines to Design for Constructability*, there is no appreciable difference in the structural steel unit weight for greater span lengths. For a bridge with span length of 175 ft, average girder spacing between 11 ft and 13 ft trends to a lighter steel superstructure and hence fewer bolts and connections, fewer girders to fabricate, inspect, transport, etc. But there are also tradeoffs to this, and the designer's decision must consider all relevant factors.
- 7 **ANSI 125  $\mu\text{in.}$  (3  $\mu\text{m}$ ).** See Table 4.2.1-1 in the *Steel Bridge Fabrication Guide Specification*.
- 8 **False.** The maximum load-induced fatigue stress range for cross frames should be based on the fatigue truck confined to one critical transverse position only. Introduced in the 7th Edition AASHTO *LRFD Bridge Design Specification*, Article C6.6.1.2.1 states that there is an extremely low probability of a truck being located in two critical relative transverse positions over millions of cycles, and it recommends that the fatigue truck be positioned to determine the maximum range of stress or torque with the truck confined to one critical transverse position per each longitudinal position throughout the length of the bridge in the analysis. The alternative would likely result in cross frames that are unnecessarily oversized.

**THE PROVEN STEEL BRIDGE DESIGN SOLUTION**

**FREE 15-DAY TRIAL\***  
\*see website for details



The leading software package for designing and rating curved and straight steel girder bridges.

**Used by Many State DOTs and Top Design Firms**

(573) 446-3221 ■ [www.mdxsoftware.com](http://www.mdxsoftware.com) ■ [info@mdxsoftware.com](mailto:info@mdxsoftware.com)

Everyone is welcome to submit questions and answers for the Steel Quiz. If you are interested in submitting one question or an entire quiz, contact AISC's Steel Solutions Center at 866.ASK.AISC or [solutions@aisc.org](mailto:solutions@aisc.org).

AISC

# Night School



## Industrial Building Design and Design of Non-Building Structures

presented by

Bo Dowswell, Robert MacCrimmon, John Rolfes, and Jules Van de Pas

Tuesday nights

7:00 p.m. Eastern Time

90 minutes each

Upcoming Sessions:

- 7/7 Industrial Buildings – Part 2
- 7/14 Crane Supporting Structures
- 7/21 Fatigue Design for Industrial Structures
- 7/28 High & Low Temperature Design  
for Industrial Structures
- 8/4 Non-building Structures – Part 1
- 8/11 Non-building Structures – Part 2



**Smarter. Stronger. Steel.**

American Institute of Steel Construction  
312.670.2400 | [www.aisc.org](http://www.aisc.org)

[aisc.org/nightschool](http://aisc.org/nightschool)

# steelwise

## HOW LOW CAN YOU GO?

BY WILLIAM A. THORNTON, PE, PhD



**Bill Thornton** ([bthornton@cives.com](mailto:bthornton@cives.com))

is a corporate consultant with Cives Engineering Corporation. He is the winner of the AISC 1995 T.R. Higgins Lectureship Award and the 2003 AISC Lifetime Achievement Award, and was inducted into the National Academy of Engineering in 2013. He currently serves as a member of multiple AISC technical committees and was Chairman of the AISC Committee on Manuals and Textbooks from 1985 to 2011.

A brief look at the  
lower bound theorem  
of limit analysis.

**“YOU CAN MAKE STRUCTURES** act the way you want them to.”

Whatever your thoughts on this statement, it was made to my senior class by an experienced practicing structural engineer in 1960. At the time, I thought it was nonsense. The engineer said that in school, we were learning many sophisticated methods of structural analysis but very little about structural design. And out in the real world, we would need to know *a lot* more about design and how structures actually work.

Of course, this was before desktop computers and analysis programs were available. And when it came to designing moment frames, there were two methods available: the portal method and the cantilever method. For braced frames, you used the tower method.

These methods were all based on *assumed* force distributions, not *actual* internal force distributions, in the structure. The designer assumed internal force distributions that to some extent suited his or her fancy. Enter the professional engineer’s statement: “You can make structures act the way you want them to.” And while I mentioned before that it sounded like nonsense at the time, I can assure you that it’s not—provided the internal forces assumed satisfy equilibrium, and the members chosen based on these forces satisfy all their failure modes (including non-ductile limit states).

### The Lower Bound Theorem

The last sentence of that last paragraph is an essential part of the lower bound theorem of limit analysis. The lower bound theorem predicts the minimum load at which there is an onset of plastic deformation or plastic hinge formation. Along with the upper bound theorem, it predicts design loads in structural engineering. Here’s how it was stated—in this form, for ductile structures—circa 1950 by Baker, Neal, Greenberg, and others:

#### For Connections

##### Lower bound theorem

- Given:** Admissible internal force field  
(internal forces in equilibrium with applied load)
- Given:** Satisfaction of the limit states
- Result:** The load in equilibrium with the internal force field  
is less than or at most, equal to the connection capacity

This statement of the theorem specializes it for connections. The theorem goes further than saying that we can make structures (a connection is a structure) act the way we want them to. It says that among the infinity of acceptable admissible internal force fields, the one that produces the largest load capacity is closest to the collapse solution.

This theorem is a real boon to the structural designer. While the designer is free to choose any admissible force field to make the structure act in the way he or she wants, they also know that when comparing possible designs, the one with the maximum



capacity is the best design from a load standpoint. Available possible designs can then be compared for cost, aesthetics, architect's requirements, etc.

**An Example**

Over the last 30 years or so, three methods for designing bracing connections have been developed and are presented in AISC Design Guide 29: *Vertical Bracing Connections—Analysis and Design* ([aisc.org/dg](http://aisc.org/dg)). These are the uniform force method (UFM), the parallel force method (PFM), and the KISS (keep it simple, stupid) method. All of these satisfy the requirements of the lower bound theorem, and a designer is free to use any of these or any other method that satisfies the lower bound theorem.

Let's look at an example. Consider the bracing connection in Figure 1.

The designer of this connection used the PFM. The same connection was designed by another designer by the UFM and is shown in Figure 2.

The connections in both figures are capable of carrying the load of 300 kips, though the UFM design is much more economical as it has no column stiffeners or a beam web doubler plate and a thinner end plate. While both connections satisfy the lower bound theorem, only one—by definition—is the least-cost solution. For steel to continue to be competitive in the marketplace, procedures outlining the least-cost solution need to be developed while still achieving the technical demands. This has been my quest in my 40 years with Cives Engineering Corporation.

The design of connections in general, and of bracing connections in particular, has undergone great changes in the last quarter-century. The statement of a consulting engineer in my university class in 1960, which I didn't understand at the time, nevertheless haunted me through the years but finally came to fruition for me in the example given here, which originally occurred in the 1970s, when I was a professor teaching a graduate-level course on plastic design. And now, decades later, the lower bound theorem is still the fundamental basis for much of what I do professionally. ■

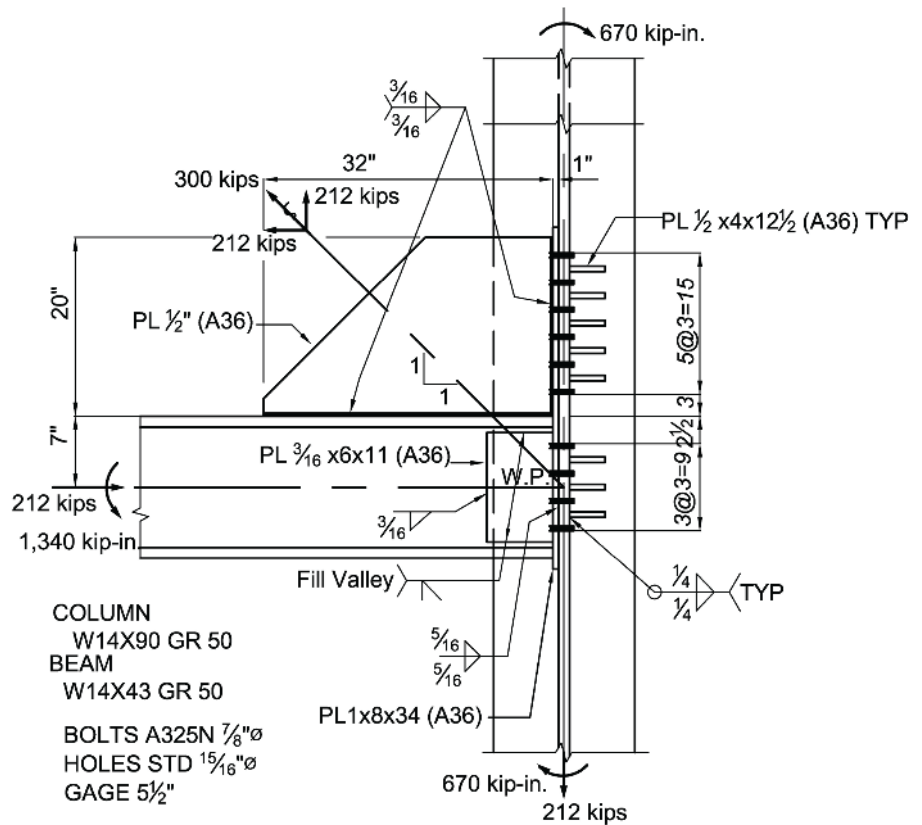

Fig. 1.

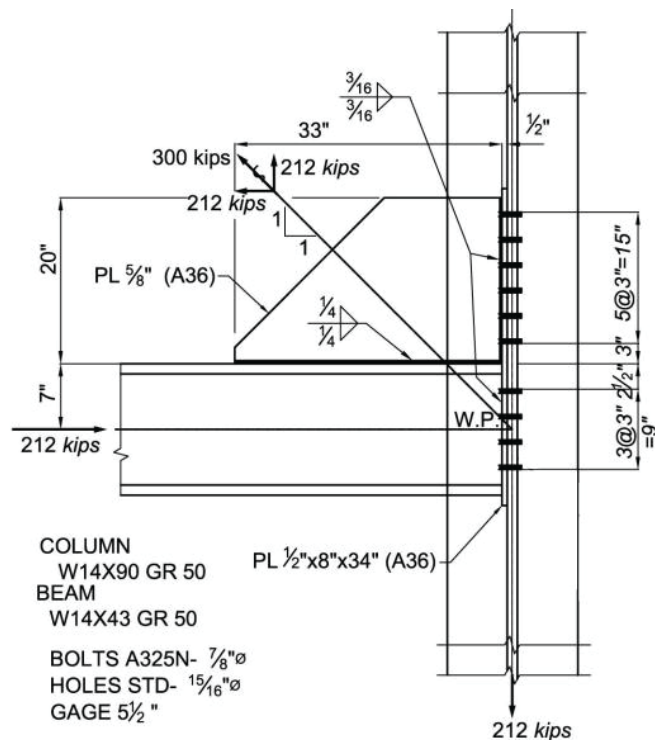

Fig. 2.

# field notes

## THERE AND BACK AGAIN

INTERVIEW BY  
GEOFF WEISENBERGER



**Geoff Weisenberger**  
([weisenberger@aisc.org](mailto:weisenberger@aisc.org)) is senior editor of *Modern Steel Construction*.

To hear more from Steve, visit [www.modernsteel.com](http://www.modernsteel.com), where you can listen to the interview podcast in its entirety.

AISC's next board chair started off as an engineer—just not the type you'd think for the president of a prominent structural steel fabrication company.

**WELCOME TO FIELD NOTES**, *Modern Steel Construction's* podcast series, where we interview people from all corners of the structural steel industry with interesting stories to tell.

Our subject this time is **Steve Knitter**, president of AISC member fabricator Geiger and Peters in Indianapolis and AISC's board vice chair. Steve talks about how his career evolved from robotics to steel fabrication (which uses robotics), how he ended up on deck to become AISC's next board chair, why he prefers skiing to snowboarding, what is like racing to the finish on a project at the Indianapolis Motor Speedway, and how he found his way back to Hoosier State (twice).

**You were born in Indiana, and then you left, and now you're back.**

Yeah, it was a strange sort of circumstance that I was actually born a Hoosier, in Fort Wayne, lived in the state for a few years, and then we migrated east, where I spent most of my years growing up in Vermont, then I ended up back at Purdue University, where I met my (Indianapolis) wife. And after taking a job farther away for a little while, I ended up coming back in the Hoosier State, and so now I've been here three different times.

**Do you miss anything about Vermont?**

Absolutely. It is a gorgeous place, a neat place to grow up. I have lots of aunts and uncles and cousins that are scattered around that region, so we still try to go back as much as we can to visit. It gave me a love for skiing and hiking and generally being outdoors.

**Have you found an outdoor fix in Indianapolis?**

Yes, I can still enjoy the outdoors, though I do miss the mountains. But the weather here is pretty nice and we have a little bit of skiing, and we have a lot of good mild weather for running and biking and hiking and doing other things. And I've learned to enjoy the Great Lakes. Kind of like an ocean without the salt.

**How did you get into the structural steel business?**

It was kind of a long process. I knew I wanted to be an engineer, and so I graduated from Purdue with a robotics degree and started working for Motorola, setting up automated lines to build cell phones and walkie-talkies down in Fort Lauderdale. And then I end up marrying my college sweetheart, who had a tie to the structural steel business. So that was the pull to get me to go from the micro of robotics to the macro of structural steel. Geiger and Peters was my wife's family business. Her great-grandfather started the company in 1905, and this got the fourth generation of family involved in the business.

**Have you built any robots lately?**

Ha! No, but we have one here in the shop. And I know enough to be dangerous when I talk to the vendors who set it up or my operators that are running it.



### How long have you been with Geiger and Peters?

I've been here 24 years, and I had the luxury of having predecessors with good vision. So when I first came, I worked at a sister company, a smaller fabricator, for three years to learn the business there before I switched over to the main fabrication plant. And then I started here and for the first nine months, I shadowed every worker in the shop. It gave me good experience on what everybody did and what we needed to do in order to get orders out the door. And then I worked my way through the office, through sales and estimating and project management, and then I was an operational manager before I took over as president in 2010.

### So can you tell me about a project that you're particularly proud of or one where you thought, "That was rewarding, but let's never do one of those again!"

Well, here we are talking on the eve of Memorial Day weekend, and one that sticks out was from a few years ago, when we worked on the expansion of the stands at the Indianapolis Motor Speedway for the hundredth running of the Indy 500 [which traditionally takes place Memorial Day weekend]. The owner was coming up with different ideas and options, and like a lot of projects it takes a while to get it released and to get going—and all the while, the date for the race was coming up. So once we finally got going on it, we had a very compressed schedule, and it was unbelievable how our workers here in the shop and in the field took so much pride in working on the Indy 500, especially for the hundredth running.

When it came to crunch time, our shop was running seven days a week, 24 hours a day, and the field was also running seven days a week. It was an unbelievable push that people were willing to make for this event. What was most rewarding is that the president of the Speedway came out and toured the site, and he ended up giving free tickets to all my shop workers and my vendors—500 tickets in all to come to the 500!

### What's been a big "Aha!" moment in your career in the steel industry?

I guess my biggest one was when I was taking over as president in 2010, which was still smack in the middle of our last recession. It was hard to get business and it was hard to keep our head above water. And so I really had to look at the company and think about what was important to us to keep us going, and I was so pleased to find out that when it came to my employees and partner vendors

that I'd worked with for the past 14 years, those relationships really paid off. It's hard to pick back up in a time like that, but people were still coming through for us. And a year later, when business was coming back, we were able to able to repay the favors.

### In that vein, how has the pandemic affected your business?

We've been very fortunate because our staff has stayed pretty healthy. We're probably down 10% to 15% in terms of shop and office staff, due to the fear of catching something or staying home for a period of time or other issues like that. But for the most part, it's business as usual. It has changed business for sure, as my project managers are now finding they have more time because they're able to do their job meetings via Zoom instead of driving three hours to a job site and driving three hours back. It's going to be interesting to see how this changes our gatherings for projects moving forward.

### Tell me some of your thoughts on being our board vice chair (and eventually board chair).

I really have a passion for our industry, and I've enjoyed being involved with different organizations that talk about structural steel, where we can get the word out about what we can do and at the same time educate our whole industry, and also become better understood by general contractors, owners, and architects about how important structural steel is and what we can do to give them these spectacular structures.

### You mentioned skiing earlier. Did you grow up skiing? Would you consider yourself pretty avid?

Oh, I'm absolutely obsessed by it. When we moved to Vermont, there were great programs for local kids so they could ski the mountains on the weekends for a very good price, and were encouraged to enjoy the sport. So I'd try to go every single weekend in the winter, and winters were usually pretty long in Vermont. Moving to Fort Lauderdale was a little tough, but then once I moved back to the Midwest, I started skiing out west, in the Rockies, and I'm always trying to find an excuse to go.

### As a lifelong skier, what are your thoughts on snowboarding?

I have lots of friends that have made the transition from skiing to snowboarding. I've tried it, but I still love skiing more. I guess I see my days of skiing as precious, so I don't want to give them up to beat myself up on a snowboard! ■

# business issues OPPORTUNITY KNOCKS

BY BILL ISSLER



**Bill Issler** ([bill.issler@industrylift.org](mailto:bill.issler@industrylift.org)) is the founder of Industry Lift ([www.industrylift.org](http://www.industrylift.org)) as well as the founder and former president of FabSuite (now Tekla PowerFab).

Want to attract a new generation of shop labor? Try technology.

## WE'VE GOT A PROBLEM and an opportunity.

Of the 3.5 million manufacturing jobs that the National Association of Manufacturing and Deloitte predict need to be occupied by 2025, perhaps two million could go unfilled because of the lack of skilled workers. This could result in serious economic consequences when products and projects are delayed or made with lower quality work by lesser qualified laborers. Yet by successfully addressing this challenge, everyone benefits. Qualified workers gain employment, companies complete projects with consistent quality, and we shrink the skilled trades employment gap.

What's involved? A helpful four-part framework presents the big picture, as identified by the recently formed Skilled Trades Coalition (STC), a cooperative venture of 17-plus trade organizations, including AISC: "Awareness, Recruitment, Training, and Retention of skilled trades workers." Regarding training, over the past decade some great training programs have been launched by various associations and companies, even at the high school level. For example, SME (Society of Manufacturing Engineers), in partnership with local businesses in 22 states, helps equip schools with the necessary machines for hands-on skilled trades training.

So what about awareness and recruitment? Since the next generation of workers is clearly very tech-savvy, why not use technology to entice them into "awareness" of the opportunity? And with the popularity of virtual reality (VR) coming into the market, it seems reasonable to create this awareness using VR. For example, since 2011, the American Welding Society's (AWS) high-tech Careers in Welding Trailer—a 53-ft-long expandable tractor-trailer mobile welding exhibit—offers hands-on virtual reality welding experiences from Lincoln Electric at state fairs throughout the country to increase awareness of this trade (take a look at this YouTube video to see what I'm talking about: [tinyurl.com/awsexpward](https://tinyurl.com/awsexpward)).

It's a great idea, right? Why not expand it to other skilled trades with a huge library of immersive VR experiences? It was not that long ago that I had my own first immersive VR experience, at the 2019 CES (Consumer Electronics Show) in Las Vegas. Being introduced to the VR game "Richie's Plank," I visualized a similar VR experience, only this time I would be an ironworker, high up on a multi-story steel structure, walking out on girders and looking down to the streets below. That is when I started the plan to develop five- to ten-minute VR job experience games that could be available on VR app stores for anyone to download and use 24/7. Then, young people could "try out" skilled trades jobs before investing in the effort, time, and expense to become qualified.

With the deadline of a speaking opportunity at the second STC meeting last September, I was motivated to have a few VR experiences to share—and I got my chance! I walked these trade association leaders through a newly developed VR trade experience of an ironworker maneuvering a beam, being lowered into position from a crane, then aligning the holes and bolting it. Charlie Carter, AISC's president, was kind to put on the VR headset for the immersive demonstration while the rest of us watched his theatrical movements, not being able to see what



VR is changing the job-learning experience in a variety of industries, including construction.

---

he was experiencing inside the VR headset. Comical to the rest of us, if I may say, but a “Gee-whiz!” moment for Charlie!

Since then, Industry Lift has produced a few more VR trade experiences: forklift operator, crane operator, welder, and fabrication shop fitter. We are in the process of making these games available on the VR app stores later this year, for use on the Oculus Quest VR headset—for free.

But do such VR experiences really work? A month ago, a friend in the restaurant business contacted me. She was trying to help a young chef, who had decided that the culinary arts was no longer the path he wanted to follow. He’s 20 years old, good with his hands, and not afraid of hard work. I invited him to my Tech Center where I explained what Industry Lift was about, then invited him to put on the VR headset to try out several of the job experiences.



## Over the Top Pallet Wrap

The industry's toughest, most weather  
resistant pallet wrapping!

Call or email us your inquiry!  
St. Louis Screw & Bolt

sales@stlouisscrewbolt.com

800-237-7059

Protects labels & custom tagging!

## QUICKFRAMES

# IS OPEN FOR BUSINESS

# 10% OFF

## FOR ALL HOSPITAL & MEDICAL FACILITY PROJECTS

### No Welding Bolt-in RTU Structural Frames

▶ Get a Quick Quote at [www.QuickFrames.com](http://www.QuickFrames.com)

## business issues

His first experience was the “iron-worker,” which he completed at record-breaking speed and with great proficiency. The second was the “forklift operator,” also achieved at a high level. His third and final experience was the “welder,” where he again performed magnificently. He then announced, “I want to be a welder! How do I get started?” I gave him the contact information of a local welding instructor. The entire visit lasted less than 30 minutes. As he was leaving, I asked him about the process that I had taken him through, to which he replied, “A great introduction. Pass it along to others.”

These “games” don’t require any prerequisite knowledge or competency. They generally take between five to 15 minutes to complete, but that should be sufficient time to reach one of three conclusions.

1. **No.** I don’t think this is for me but now I know something about this job.
2. **Maybe.** It’s very interesting and I would like to know more about this job.
3. **Yes.** This is the job that I’ve been looking for. How do I get started?

Industry Lift is taking the approach of making VR job experience games available to the public for free, to entice young people to explore skilled trades. When these Industry Lift VR trade experiences become available later this year, consider trying them out yourself—like Charlie did. (See the news item at [tinyurl.com/aiscgap](http://tinyurl.com/aiscgap) to read more about AISC’s support of STC’s mission.)

So, pass the word on to your network of family, friends, and colleagues. And while you’re doing that, brainstorm what particular skilled trades you think could be made available as beneficial VR experiences? Industry Lift wants to be a catalyst and plans to partner with trade associations to develop additional relevant VR trade experiences for young people to try out in order to fill these much-needed skilled trade jobs—for their own benefit and the benefit of society as a whole. ■



## AISC AND THE NATIONAL STEEL BRIDGE ALLIANCE (NSBA)

are proud to announce the winners of the 2020 Prize Bridge Awards.

The winners span everything from a rugged section of Lake Tahoe’s shoreline to a tight Idaho Canyon to a wide stretch of railroad tracks along Chicago’s lakefront to a high-profile expressway in Philadelphia’s Center City to the Hudson River’s massive Tappan Zee. All have made an enormous impact on the lives of the people they serve—some in particularly dramatic ways. For example, the Pfeiffer Canyon Bridge reconnected a California community after a landslide damaged a concrete bridge beyond repair (so much so that groceries and fuel had to be brought in by helicopter!).

“These projects are tributes to the creativity of the designers and the skills of the constructors who collaborated to make them reality,” said AISC’s president, Charlie Carter. “Steel shines and soars on their talents, and we celebrate the accomplishments these projects represent.”

Since Pittsburgh’s Sixth Street Bridge won the first competition in 1928, more than 600 bridges of all sizes from all across the United States have received a Prize Bridge Award. Some, such as the Wabash Railroad Bridge in Wayne County, Mich., which won a prize in 1941 and still carries railroad traffic more than 70 years later, have actually outlasted the companies that built them.

Read on to learn about all of the winners. They’re also featured in a video at [aisc.org/nsba/prize-bridge-awards](https://aisc.org/nsba/prize-bridge-awards).

## Judges

AISC and NSBA would like to thank the 2020 Prize Bridge Award judges for their time and enthusiasm:

- Richard Marchione, deputy chief engineer (ret.), New York Department of Transportation
- Shane W.R. Kuhlman, state bridge engineer, New Mexico Department of Transportation Bridge Bureau
- Frank Russo, vice president and technical director, bridge engineering, Michael Baker International
- Rob Richardson, west region bridge leader, associate vice president, HDR
- Dennis Golabek, GEC-FDOT Structures Design office, WSP

These dedicated judges considered every entry’s merits in terms of innovation, economics, aesthetics, design, and engineering solutions.

**NATIONAL AWARD** Short Span

# Vine Street Expressway (I-676) Reconstruction Project—18th to 22nd Streets, Philadelphia

**THE VINE STREET EXPRESSWAY** is well-known to Philadelphia commuters.

The nearly two-mile stretch of Interstate 676 in the City of Brotherly Love’s downtown (aka Center City) is critical to the area’s transportation network. But in recent years, six bridges carrying local roads over the expressway were aging and suffering from significant deterioration, and the Pennsylvania Department of Transportation (PennDOT) decided to replace these two-span prestressed concrete non-composite adjacent box-beam bridges with single-span welded-plate-girder steel bridges. Vertical clearance issues, reuse of existing bridge abutments, relocation of several utilities supported by the bridges, and high aesthetic standards were key project considerations. In addition, the new structures were also topped with extensive landscaped areas and streetscape finishes.

Each bridge had its own challenges and unique aspects. For example, the deck for the new Family Court pedestrian bridge, located between the 18th and 19th Street bridges, is now a park for the community. This new configuration required the bridge to carry a heavier load to support trees, additional sidewalks and seating areas, and a lawn. This new pedestrian bridge required thicker flanges to support the weight of the park, yet still be able to flex on the bearing pads on the existing abutment and expand

and contract smoothly with temperature changes. Steel was pivotal for supporting the new loads that came with these features as well as maintaining the clearance needed below the bridge, providing the necessary strength in a shallow profile.

The 19th Street Bridge presented a different challenge. With four bays of utilities supported by the bridge, the team prepared a steel design and construction schedule that would allow the utilities to remain in service throughout construction. The utilities were moved to temporary supports while the bridge was removed around them, then the newly fabricated beams were set in place and the utilities were relocated to the new beams while the remainder of the new bridge was built. This reduced the need for outages to move critical utilities and kept them in working order throughout the construction.

Challenging geometry drove the design of the new bridge that would combine the existing 20th Street, Ben Franklin Parkway, and Free Library Bridges into one structure, the 20th/BFP/FL Bridge. Given the sharply skewed geometry (35°) of the Parkway across the bridge, the team investigated whether the design vehicular live loads could produce larger girder moments and shears running along the sharp skew as opposed to the typical live load configuration of vehicles traveling parallel to the girders. A 3D finite ele-

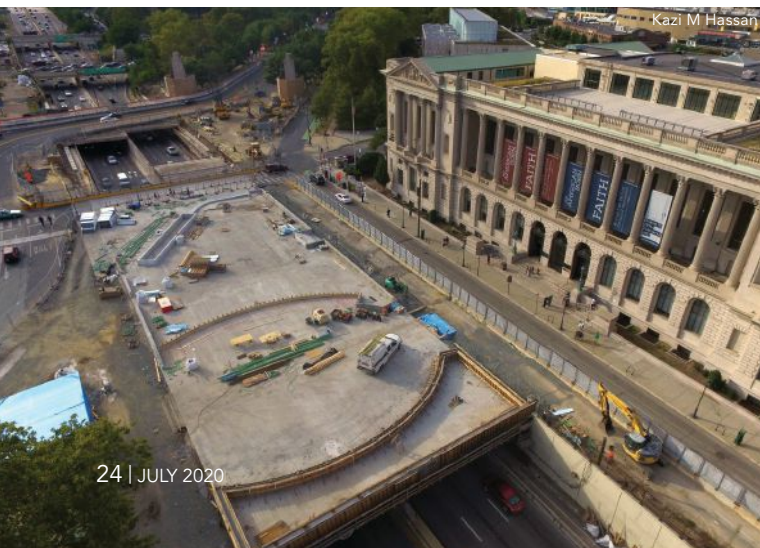
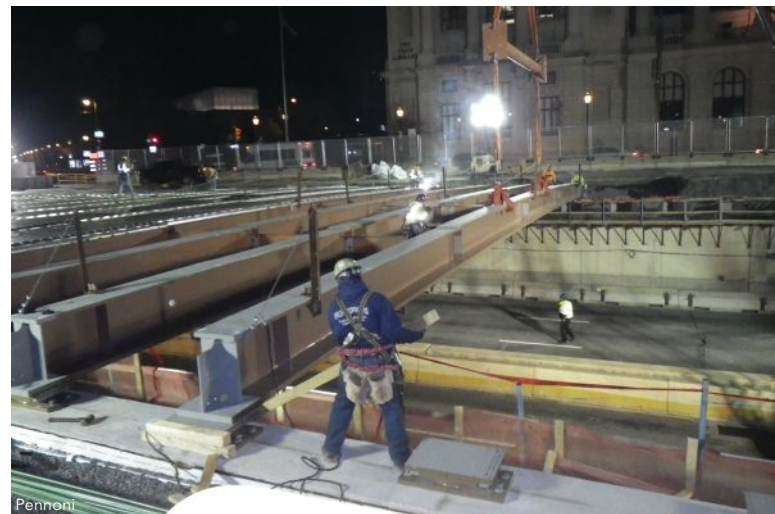





John Baer Building Images Photography

ment model was developed and used to confirm that the skewed live loading condition did not produce effects greater than the standard design vehicular loads running parallel to the girders. The resulting design yielded girders with 24-in.-deep webs and maximum 24-in.-wide by 3.5-in.-thick bottom flanges.

When it came to the 22nd Street Bridge, the clearance below the bridge was too low, there was a pump station behind one of the existing abutments that could not be removed, and there were numerous existing and proposed utilities to be set on the bridge. By implementing shallow steel beams, the center pier was eliminated and the profile was raised to the minimum 14 ft, 6 in. without exceeding the capacity of the existing abutments.

The existing, concrete 18th Street Bridge carried a heavy 22-in. steam pipe below the deck. The design team worked with the local utility to employ a lighter pipe using less insulation so that the new steel span would be able to not only carry it but also fit it between the bridge beams.

Finally, the 21st Street Bridge had the longest span of all the bridge replacements due to the presence of on/off ramps below the structure, meaning that the abutments had opposing skews of up to 10° from the girder span. As such, each steel girder on this span was unique, resulting in more extensive detailing.

#### Owner

Pennsylvania Department of Transportation, Harrisburg, Pa.

#### General Contractor

Buckley and Company, Inc., Philadelphia

#### Structural Engineer

Pennoni, Philadelphia

#### Steel Fabricator and Detailer

High Steel Structures LLC, Lancaster, Pa. 

#### Bridge Stats

**Opened to traffic:** November 1, 2018

**Span lengths:** 18th Street: 95 ft, 2 in.  
 Family Court: 95 ft, 5 in.  
 19th Street: 95 ft, 2 in.  
 20th Street/Benjamin Franklin Parkway/  
 Free Library: 95 ft, 8 in.  
 21st Street: 119 ft, 5½ to 133 ft, 10 in.  
 22nd Street: 106 ft, 5 in.

**Total lengths:** 18th Street: 97 ft, 10 in.  
 Family Court: 98 ft.  
 19th Street: 97 ft, 10 in.  
 20th Street/Benjamin Franklin Parkway/  
 Free Library: 98 ft, 6 in.  
 21st Street: 120 ft, 3½ in. to 135 ft, 6⅞ in.  
 22nd Street: 108 ft, 11 in.

**Average widths:** 18th Street: 69 ft, 10½ in.  
 Family Court: 120 ft  
 19th Street: 64 ft, 11 in.  
 20th Street/Benjamin Franklin Parkway/  
 Free Library: 643 ft  
 21st Street: 67 ft  
 22nd Street: 83 ft, 6 in.

**Total structural steel:** 2,846 tons

**Cost:** \$65.4 million for entire project

**Coating/protection:** Three-coat system consisting of an inorganic zinc primer, urethane intermediate coat, and aliphatic urethane finish coat

## MERIT AWARD Short Span Anchor Bay Drive, St. Clair County, Mich.

**ANCHOR BAY DRIVE** is a scenic road along Lake St. Clair in Clay, Mich., that carries fishing boats and yachts to the lake access and marina at the end of the road. It provides access to the hundreds of homes that take advantage of the spectacular views of the lake and lagoon via three bridges along the route.

A recent inspection by county engineers determined that these crossings—prestressed concrete box-beam superstructures with only a 30-year service life—had become either structurally deficient or functionally obsolete. They were replaced with galvanized steel press-brake-formed tub girder (PBFTG) bridges with a life expectancy two-and-a-half times as long. Combined with reinforced precast concrete deck panels, this steel solution provides a cost-effective replacement option at an accelerated construction schedule with a service life expectancy exceeding 75 years.

The St. Clair County Road Commission was able to bundle these three bridges into a collective, successful superstructure replacement project. During replacement, the bridges needed to remain passable as they provided the only point of access to the far reaches of Anchor Bay Drive, so a complete tear-down and rebuild was not possible. In addition, space around the bridges is extremely tight, with houses packed in close to the roadway and very little dry land to maneuver on.

Luckily, the chosen PBFTG option, TEG Engineering's Con-Struct Bridge System, addressed these issues. The original bridge abutments were in good shape and would not require replacement, and the Con-Struct system can be installed on top of existing substructures. In addition, the system can be delivered two ways: with the precast concrete deck pre-attached to the tub girders or separate. For this project, the team did not want the girders and deck to be attached, due to the space limitations at the installation site.

The county demolished and installed the bridge one side at a time to



TEG Engineering



TEG Engineering



### Bridge Stats

**Opened to traffic:** July 2, 2019

**Span/total length:** 57 ft

**Average width:** 30 ft

**Total structural steel:** 58 tons

**Cost:** \$220,000 per bridge superstructure

**Coating/protection:** Galvanizing

Valmont



TEG Engineering



TEG Engineering



ensure that traffic flow could continue unhindered. The installation was much quicker than other available options due to the system's modular design, and both the galvanized steel tub girders and the decking take about half a day to set in place. The county's own crew and equipment easily managed installation without additional equipment rentals or labor, saving the county even more time and money.

**Owner and General Contractor**

St. Clair County Road Commission,  
St. Clair, Mich.

**Structural Engineer**

TEG Engineering, Wyoming, Mich.

# No Shop or Field Welding!

## All-Bolted SidePlate Connections

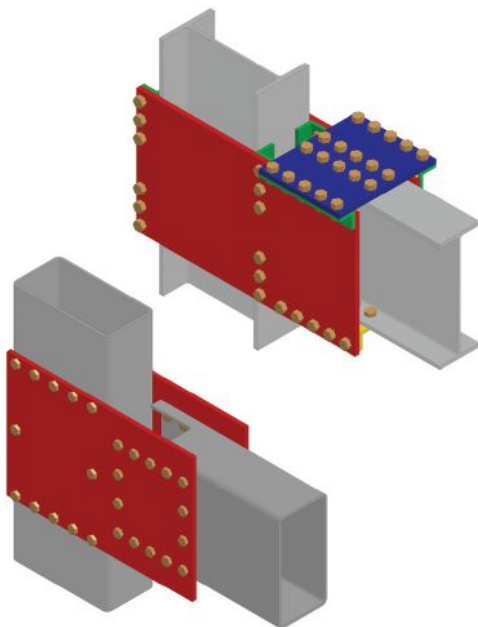

"This new all-bolted connection is something we are really excited about, SidePlate continues to innovate and our partnering relationship allows us to be on the cutting edge of connection technology."

*-Marsh Spencer, President SteelFab Inc.*

"The new all-bolted HSS solution enables our industry to reduce lead times for steel framed buildings. We look forward to seeing this innovation support a movement in the industry and are excited to be working with SidePlate to make this happen."

*-Tom Muth, President of Atlas Tube*

949-238-8900  
www.sideplate.com





RS&H



RS&H

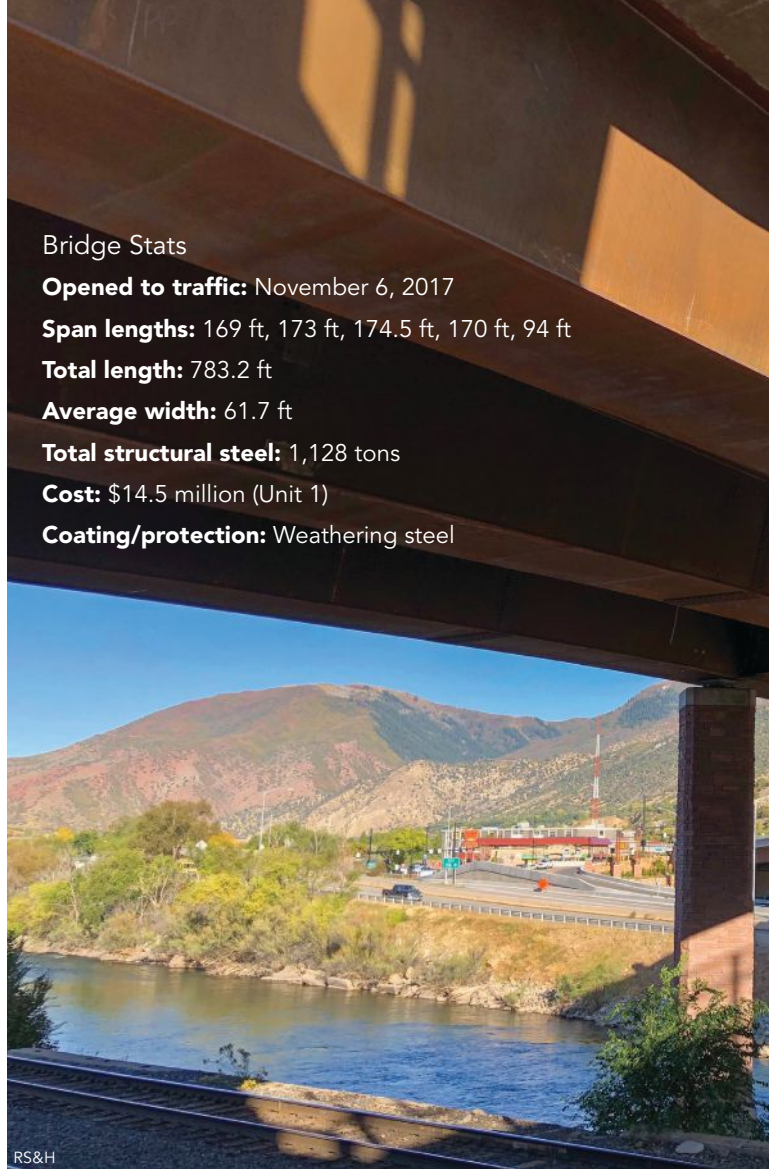

RS&H

### Bridge Stats

**Opened to traffic:** November 6, 2017

**Span lengths:** 169 ft, 173 ft, 174.5 ft, 170 ft, 94 ft

**Total length:** 783.2 ft

**Average width:** 61.7 ft

**Total structural steel:** 1,128 tons

**Cost:** \$14.5 million (Unit 1)

**Coating/protection:** Weathering steel

## NATIONAL AWARD Medium Span Grand Avenue Bridge, Glenwood Springs, Colo.

**GRAND AVENUE IN GLENWOOD SPRINGS, COLO.:** has a grand new thoroughfare.

It was driven by the need to replace an aging and functionally obsolete bridge, a nine-span, 676-ft-long steel plate girder bridge constructed in 1953. The bridge carries SH82 over Interstate 70, the Colorado River, and Union Pacific Railroad (UPRR) lines before descending into the historic downtown business district of Glenwood Springs. It is one of only two crossings serving Glenwood Springs as well as other communities along the Roaring Fork River valley, including Aspen to the south.

The existing bridge had four roughly 9-ft-wide lanes that had effectively become a bottleneck to traffic flow. Widening the existing bridge was considered, but the structural capacity didn't meet current codes and there was limited service life remaining, thus making replacement the prudent choice. In addition, the Colorado Department of Transportation (CDOT) was unsuccessful in a previous attempt to replace the bridge due to opposition groups that were ultimately successful in shutting the project down. This time, CDOT made a concerted effort to improve the process by involving the designer, contractor, and public early in the design.

The project included changing the SH82 alignment over the bridge from straight to curved with a 625-ft radius. The new alignment and proposed intersections at the north end improved traffic flow at the SH82/I-70 interchange but made the new bridge geometrically challenging. The horizontal curvature resulted in the bridge crossing I-70, the river, and the railroad at varying degrees of skew. The north end of the bridge was tangent and required a flaring deck width to accommodate the changing lane requirements near the SH82/I-70 interchange. The profile also required a sharp vertical curve to get up and over the UPRR and then immediately begin the descent into downtown.

The new bridge had two distinct regions with significant variation in the required structure depths. A deeper structure of approximately 7 ft was required for the longer spans over the highway, river, and railroad. A shallower structure of approximately 3 ft was required for the shorter downtown spans to allow adequate headroom for a planned pedestrian plaza under the bridge.

For the deeper, steel portion of the bridge (Unit 1), which included the main spans over the Glenwood Hot Springs Pool parking lot, a Frontage Road, I-70, the Colorado River, and UPRR, a

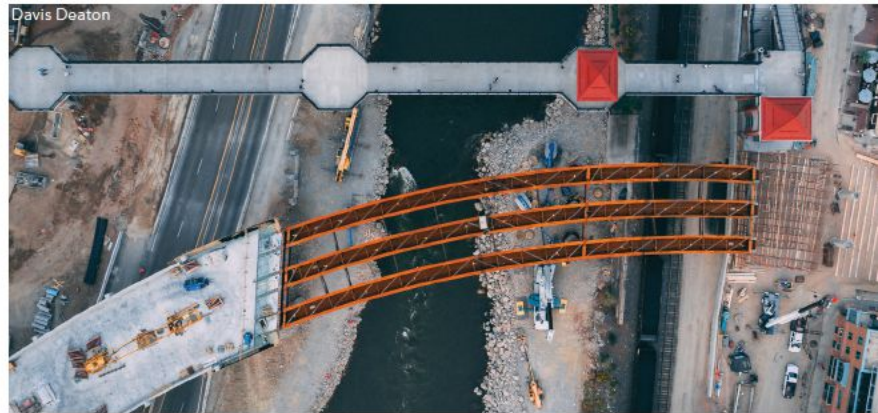

five-span trapezoidal steel tub girder bridge using 6-ft deep girders was selected. A tub shape with sloped sides was the preferred aesthetic for its clean look, while also paying homage to the many steel and concrete tub/box girder structures supporting I-70 in nearby Glenwood Canyon. Tub girders also provided excellent torsional properties to efficiently handle the sharp curvature of the bridge. The tub girder section was optimized by using a narrower bottom flange (5 ft, 7 in. web to web) than had typically been used in Colorado. This, combined with recent enhancements in AASHTO regarding local flange buckling, helped achieve practical bottom flange thicknesses of 2 in. or less without requiring longitudinal bottom flange stiffeners. The increased web-to-web spacing between adjacent tub girders did affect the deck design, but this proved to be relatively inconsequential as compared to an even web spacing.

The number of tub girder lines was reduced from the four girders originally conceived down to three, resulting in fewer members to fabricate and erect and a maximum web-to-web spacing of 18.6 ft at the flared north end of the bridge. In addition, a refined deck analysis resulted in a reasonable deck thickness and reinforcement in this region. The contractor attached a temporary floor beam/stringer system from the tub girders to form the widest deck spans in the flared region. This proved more cost-effective than adding another girder line, which would have been required to accommodate standard deck forming systems in the flared region.

The reduction in girder lines also resulted in increased top flange lateral bracing demands, especially in the flared region. A study comparing Warren and Pratt truss layouts led to the selection of the Pratt truss as most optimal for this bridge. The Warren Truss design would have resulted in larger diagonal member forces in compression, which would have required larger diagonal members and the use of gusset plates at the flange connections. By comparison, the Pratt truss allowed strategic changes in diagonal member orientation to balance the member forces in either compression or tension while mitigating the magnitude of the diagonal member connection forces. The result was reasonable diagonal member sizes and direct connections to the top flange, and no gusset plates were needed.

**Owner**

Colorado Department of Transportation – Region 3, Grand Junction, Colo.

**General Contractor**

Granite/RLW Joint Venture, Glenwood Springs, Colo.

**Structural Engineer**

RS&H, Inc., Greenwood Village, Colo.

**Steel Team**

**Fabricator**

W&W/AFCO Steel, San Angelo, Texas



**Detailer**

ABS Structural, Melbourne, Fla.



**MERIT AWARD** Medium Span  
**Williams Creek (Shoup) Bridge, Salmon, Idaho**

**THE TWO-LANE WILLIAMS CREEK (SHOUP) BRIDGE** proves that two is sometimes better than one, as it replaced an existing single-lane river crossing in Salmon, Idaho, with an attractive two-lane bridge.

The original span was a flat compression-loaded bridge that sat on two concrete piers with sheet metal guard rails, and its replacement was architecturally finessed with arched beams for the main frame and tension-loaded with cross cables. The design team performed a fair amount of graphical design work to render the different bridge alternatives it was considering in order to facilitate engaged open houses and public meetings, and the team solicited local residents and business owners for their feedback on the various bridge types and looks. Modeling the different stages of steel erection, deck placement, deck curing, temporary support removals, and cable tensioning was a very involved and detail-oriented process, which allowed the team to accurately capture the cable tension and elastic lengthening and account for all of that elastic deformation

in the design of the steel members—so that when everything was completed and all of the loads were on the bridge, the arch resulted in a nice, rounded shape and the roadway profile was at the proper elevation.

The team essentially had to start its analysis with the final product and work its way backwards to determine what shape the arch ribs and tie girders needed to be before they were erected and loaded. “The member lengths and shape of the arch in the final configuration are not the same as the lengths and shapes that get fabricated,” noted one project engineer. “For me, that was the most complex part: the level of detail involved in the finite element model we built to determine all of the different loads and deflections anticipated for various support conditions throughout the entire fabrication to erection process.”

During the construction phase, increased spring runoff flooded the Salmon River, and general contractor RSCI implemented progressively adaptive construction methods by shifting schedules for



in-water work to meet the changing and unexpected water levels and fish spawning seasons. The allowable in-water work windows were tight and because of the historically high-water flows and ice dams, RSCI came up with alternate ways and times to set coffer dams, diversion barriers, and other elements, avoiding excusable schedule delays.

The team employed an Acrow temporary bridge structure for traffic during demolition and construction of the new bridge. The old bridge superstructure was demolished and the new single-span bridge was built using the existing bridge piers as temporary support structures; the piers were later demolished after traffic patterns were redirected onto the newly constructed bridge. This option was provided as a no-cost change order that eliminated the need to completely shut down traffic over the bridge for a period of 48 hours, providing continued use of the bridge during the contracted bridge slide. This method also minimized environmental impact to the river by eliminating the need to install and remove temporary piers required to support construction of the new bridge.

In similar fashion, RSCI implemented an alternate approach for structural steel erection that provided environmental and schedule benefits to the project. This involved designing, installing, and

working from a platform that was built directly onto the permanent bridge girders and diaphragms. The work platform was constructed in modular units in the construction lay-down yard and erected along with the girders, allowing immediate use of the structurally supported working area once the substructure steel was installed. This working structure allowed for the use of aerial lifts, materials staging, and manpower to access parts of the bridge that would have otherwise required an additional work platform to be constructed adjacent to the bridge using a pile system, and thus disrupting more of the highly protected Salmon River.

**Owners**

U.S. Department of Transportation Federal Highway Administration, Vancouver, Wash.  
Lemhi County, Salmon, Idaho

**General Contractor**

RSCI Group, Boise, Idaho

**Structural Engineer**

WSP|Parsons Brinckerhoff, Portland, Ore.

**Steel Fabricator**

Thompson Metal Fab, Inc., Vancouver, Wash.

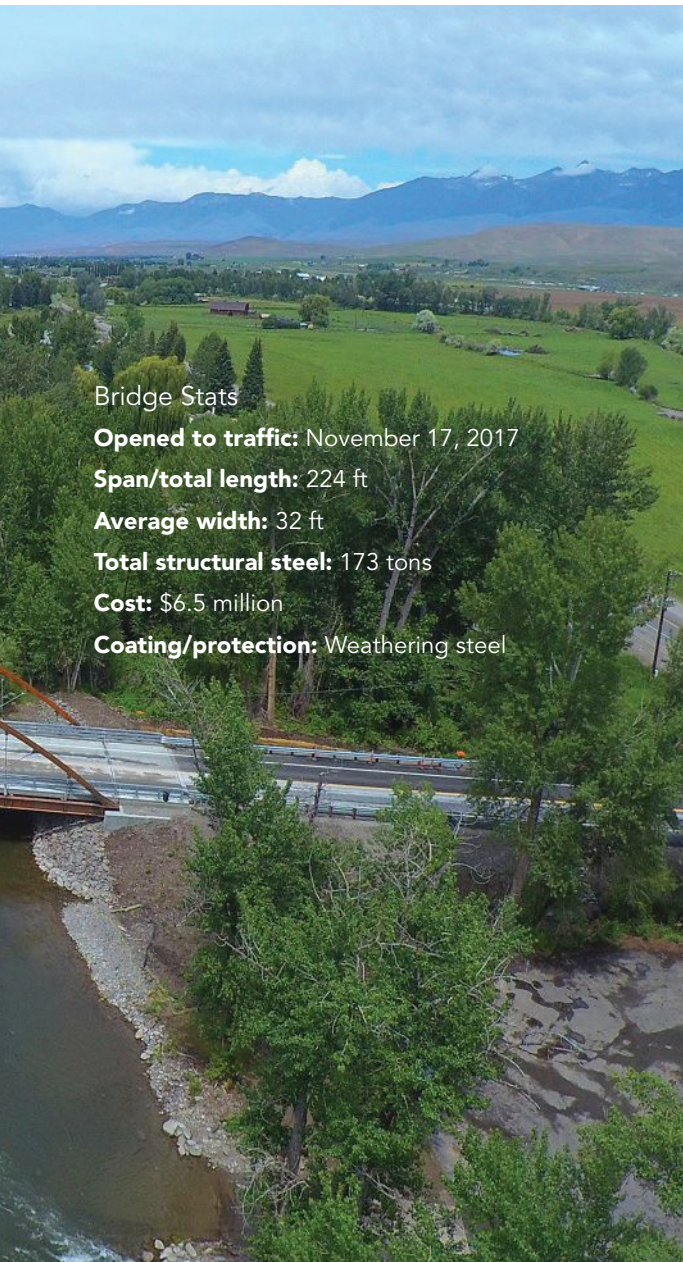

**Bridge Stats**

**Opened to traffic:** November 17, 2017

**Span/total length:** 224 ft

**Average width:** 32 ft

**Total structural steel:** 173 tons

**Cost:** \$6.5 million

**Coating/protection:** Weathering steel



U.S. DOT Federal Highway Administration



Linda Ulery



Don Perkins

## NATIONAL AWARD Long Span Manning Crevice Bridge, Riggins, Idaho

**THE MANNING CREVICE BRIDGE** carries Salmon River Road across the Salmon River in a picturesque, V-shaped canyon 14 miles upstream from Riggins, Idaho.

Salmon River Road provides access to residences, resorts, commercial rafting ventures and is a main artery for recreational users of the river and forest lands. The existing bridge, built in 1938, had reached the end of its service life and required replacement. The location is remarkable not only due to its beauty but also its limited access and very limited space available to stage construction equipment and materials. The choice of steel for temporary and permanent works was key to developing a feasible erection scheme on this difficult site.

A single-tower, asymmetric suspension bridge was chosen after evaluating six different structure configurations. Competent bedrock at the site provided ample capacity for anchoring large horizontal forces, thus favoring arch and suspension bridge types over cable-stayed options. Given the limited access for construction equipment, a suspension option was judged to be more constructable than an arch because of the light weight and flexibility of steel cables. The bridge span length is 300 ft, and with a cable sag of 18.5 ft at mid-span, the resulting sag ratio (span/sag) of 16.2 is much flatter than the classical suspension bridge sag ratio of 10.

The site features a narrow shelf road with steep drop-offs in hard rock terrain. Standard construction techniques for such steep sites typically involve temporary benching, but the hard rock site and pristine canyon location made benching both cost-prohibitive and inappropriate. During design, a temporary crane platform was located on the north side of the river for erection of the tower and cable anchorages. Additional temporary platforms were also used for construction at the north anchorage and behind the tower base. The existing south-side roadway bench was wide enough to accommodate a crane for erection and still allow vehicles to pass. All construction materials were staged and delivered from Riggins to the north end of the bridge.

Project requirements for the bridge replacement included:

- A bridge deck clear width of 16 ft for a single lane
- A minimum vertical clearance of 18 ft
- A minimum load capacity of AASHTO HL-93 and a 45-ton logging vehicle
- Roadway curvature at the bridge ends must allow a logging truck to approach the bridge
- No permanent construction within the 100-year flood plain
- Traffic must be maintained on the existing bridge during construction
- The river must remain open to rafters during construction
- Construction equipment is not allowed in the river
- Reduce the visual contrast of the bridge within the context of the river canyon

Structural steel was integral to the success of the project, especially with regard to treading lightly on the site. The robustness of the erection equipment and temporary crane platform at the north abutment are directly proportional to the piece weights to be erected at mid-span over the river. The light weight of the structural steel sections, combined with the ease of connecting them using high-strength bolted splices, allowed for an erection scheme using only two fixed crane positions with reaches up to 160 ft.







FHWA-WFLHD



FHWA-WFLHD



### Bridge Stats

**Opened to traffic:** January 22, 2018

**Span/total length:** 300 ft

**Average width:** 20.1 ft

**Total structural steel:** 188 tons

**Cost:** \$7,912,900

**Coating/protection:** Weathering steel

Project representatives from the National Park Service were instrumental in identifying key aesthetic concerns, and the bridge deck overlay was designed as an ultra-thin bonded wearing course, with aggregate color that blends with the canyon setting. The bridge deck was cast-in-place concrete using integrally colored, internally cured concrete to enhance long-term durability and reduce visual contrast by providing a color that mimics dark appearance of the weathered granite rock outcrops adjacent to the bridge. The abutments and wind walls were given a surface stain to accomplish the same objective.

The completed structure should last more than 100 years, thanks to its protection scheme. Class C galvanizing was specified for the steel cables, and Grade 50 weathering steel was used for the towers and superstructure, both for corrosion resistance and the aesthetic considerations mentioned above.

The project has been overwhelmingly received by the community, both in terms of local residents and river user groups. The bridge officially opened June 5th, 2018 with a ribbon-cutting ceremony, and many attendees at the ceremony commented on how well the weathering steel finish complements the natural beauty of the canyon. The new single-tower bridge adds a touch of uniqueness to the canyon, with a force layout that reflects the constraints of the site.

*For more on the Manning Crevice Bridge, see "Narrow Margin" in the October 2018 issue, available at [www.modernsteel.com](http://www.modernsteel.com).*

### Owners

U.S. Department of Transportation Federal Highway Administration, Vancouver, Wash.  
Idaho Transportation Department, Boise, Idaho  
Idaho County, Grangeville, Idaho

### General Contractors

RSCI Group, Boise, Idaho (also construction manager)  
Inland Foundation Specialties, Boise, Idaho (ground anchors and micropiles)

### Engineers

Atkins, Denver (structural design and project management)  
Horrocks Engineers, Meridian, Idaho (CM/GC advisor and roadway design)  
Shannon and Wilson, Denver (geotechnical design)

### Steel Team

#### Fabricator

Rule Steel, Caldwell, Idaho 

#### Detailer

ABS Structural, Melbourne, Fla. 



FHWA-WFLHD



## MERIT AWARD Long Span Pfeiffer Canyon Bridge, Big Sur, Calif.

**RECORD RAINFALL IN THE WINTER** of 2016/2017 in Monterey County, Calif., caused several landslides on the scenic coastal State Route 1, which closed the highway.

One of these landslides undermined a support for the Pfeiffer Canyon Bridge and caused severe damage that was beyond repair. The bridge was closed to traffic on February 15, 2017, and its loss devastated a portion of the Big Sur, which effectively became an island between the closed bridge on the north and a large landslide to the south. Groceries and fuel had to be helicoptered into the area. Children were no longer able to attend school located on the other side of the deep canyon. The community, whose main source of income was based on the tourist industry, now had lost its revenue source with State Route 1 closed on either side.

Caltrans immediately contracted with Golden State Bridge to demolish and construct a new bridge, designed by Caltrans, under an emergency force account (EFA). It was quickly determined that a temporary bridge was not feasible at this narrow mountainous site, since there was no room for both it and the permanent bridge as well as the required equipment and staging areas, making the design and construction of the new bridge even more urgent.

A single 310-ft-long composite welded-steel-plate-girder bridge was quickly determined to be the best solution for the replacement of the existing three-span concrete box-girder bridge. Plans for the steel plate girders were provided to the Golden State Bridge in just under two weeks after the damaged bridge was closed to traffic. The plans included two options for the girders: 1) hybrid girders consisting of Grade 50 steel for the top flanges and webs, and Grade 70 steel for the bottom flanges and 2) all Grade 50 steel girders. The latter option was chosen as it involved the quickest delivery when it came to all evaluated bid packages.

The girders were designed to have unstiffened webs to simplify and speed up their fabrication, and the webs were 1¼-in. thick to meet this criterion. The thicker unstiffened webs were also a benefit for launching since the shear resistance of the webs would be constant and not dependent on locations of the transverse stiffeners.

The new bridge width is 40 ft, incorporating three girder lines, and the total structure depth is 14 ft (the steel girders alone are just under 13 ft deep). Each girder line was fabricated in five segments for transport to the site and required four bolted field splices. The largest transported segment was 63 ft long and weighed 56.6 tons, and the girders were shipped to the site laying on their sides and required special Highway Patrol escort due to the width of the load on the narrow two-lane highway leading to the site.

Early on, Golden State Bridge decided it wanted to launch the girders across the canyon, since the girders could not be delivered to the south side of the canyon and erecting all girders from the north side would require a temporary trestle halfway across the deep canyon with an active landslide. Also, some of the temporary erection towers at the girder field splices would have to be located on the landslide.

The girder plans incorporated several details to accommodate the launching. To keep the bottom surface of the bottom flange level and flush for the rollers, the web plate height was varied depending on the flange plate thickness (instead of constant web plate height). Also, the lower field splice plates were redesigned to be three separate plates instead of a single plate so that the middle plate could be left off during launching to allow the rollers to pass through the splice. The existing bridge was on a horizontal curve, and the highway alignment for the new bridge was straightened to simplify the girder details to save design and fabrication time and allow for the girder launching.

To facilitate the launch, temporary pipe supports were constructed on each abutment extending from the seat to just above the back walls, and a central temporary tower was also constructed in the canyon at mid-span. This temporary tower consisted of multiple WACO shoring towers founded on a temporary concrete footing supported by cast-in-drilled hole piles. The approximately 75-ft-tall towers were also guyed at the top. A jacking frame was constructed on the south bank to pull the girders across the canyon using prestressing strands and two 235-kip hydraulic jacks.

All the girders were assembled on the north side of the canyon with a launching nose, and timber soffit formwork for the concrete deck and overhangs was added to the girders while they were being assembled on the launching bed; the catwalks were also installed while the girders were on the launching bed.

The launching plan involved a 14-stage process that included vertical alignment changes to raise the nose up and over the central tower and south abutment supports. The launch took three days following the very controlled and methodical launch plans. As each hydraulic strand jack piston cycled, the girder assembly was pulled in 12-in. to 18-in. increments. After each pull, measurements were taken to check for deflection and alignment to ensure the process was proceeding correctly. This process was repeated again and again until the assembled girders reached the south abutment—and marked the state's first bridge launch.

After the launch was completed, the top portion of the central temporary tower was removed along with the supporting rollers and guides. The girders were then lowered approximately 14 ft onto the abutment seats. The concrete deck was poured and then the see-through bridge railing was constructed. The new bridge opened to traffic on October 13, 2017, just eight months after the existing bridge was closed, reestablishing this vital link to Big Sur and the surrounding communities.

### Owner

Caltrans District 5, San Luis Obispo, Calif.

### General Contractor and Steel Erector

Golden State Bridge, Benicia, Calif. 

### Structural Engineer

Caltrans Structure Design, Sacramento, Calif.

# Stimulate Your Infrastructure With Steel Curved by Chicago Metal Rolled Products

## ◀ 17-92 Pedestrian Bridge (Longwood, FL)

It doesn't matter how complex the curve is. For this project Chicago Metal Rolled Products curved 66 tons of 14" square tubing up to 70' long with both sweep and camber.

## Highland Bridge (Denver, CO) ▶

This award-winning bridge is both dramatic and economical. Chicago Metal Rolled Products' Kansas City facility was able to curve 153 tons of 18" outside diameter tubing up to 100' long, which reduced splicing costs.

## ◀ Tempe Town Bridge (Tempe, AZ)

Winner of multiple prestigious awards, each of the four 228' long arching sections consists of 16" diameter HSS pipe curved up to 46' in good arc....a pedestrian bridge providing both function and aesthetics.

Our nation needs infrastructure improvements. Let Chicago Metal Rolled Products help you build bridges, tanks, tunnel supports, cofferdams, culverts, man ways, guard rails, viaducts, reinforcing columns and other structures.

**Call us at 866-940-5739**

**When you need high-quality, high-value curving of steel.**



**CHICAGO METAL  
ROLLED PRODUCTS COMPANY**

CHICAGO • KANSAS CITY  
[cmrp.com](http://cmrp.com)



We bend ALL sizes up to:

We bend ALL sizes up to:

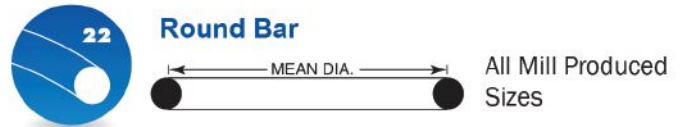
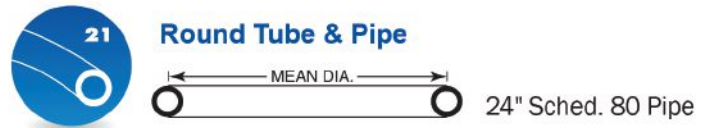
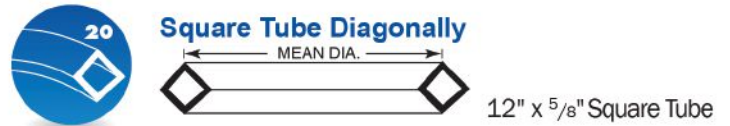
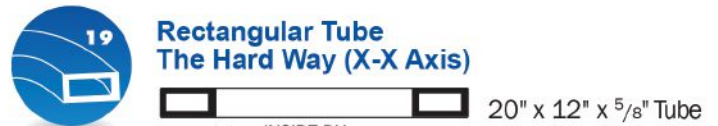
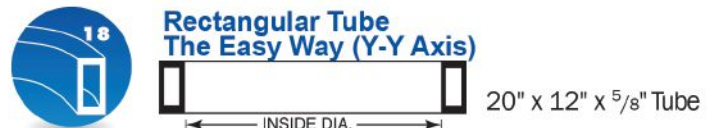
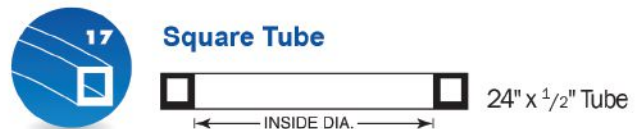
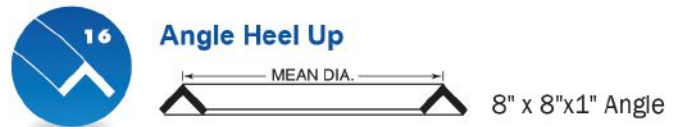
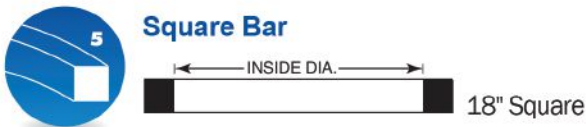
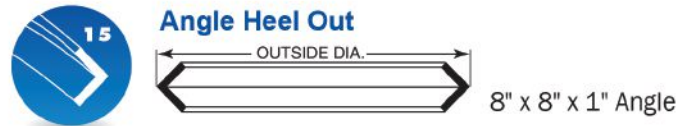
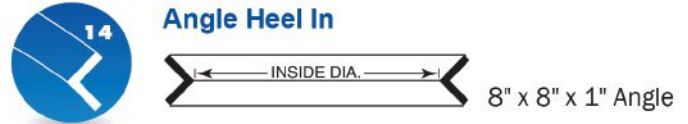
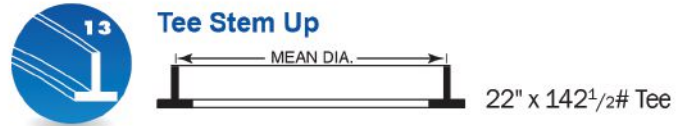
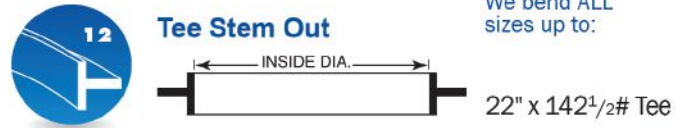

We also roll stair stringers, helical hand rails, off-axis bends, formed shapes and extrusions.

Visit [cmrp.com](http://cmrp.com) for more information.



**CHICAGO METAL**  
**ROLLED PRODUCTS COMPANY**

CHICAGO • KANSAS CITY



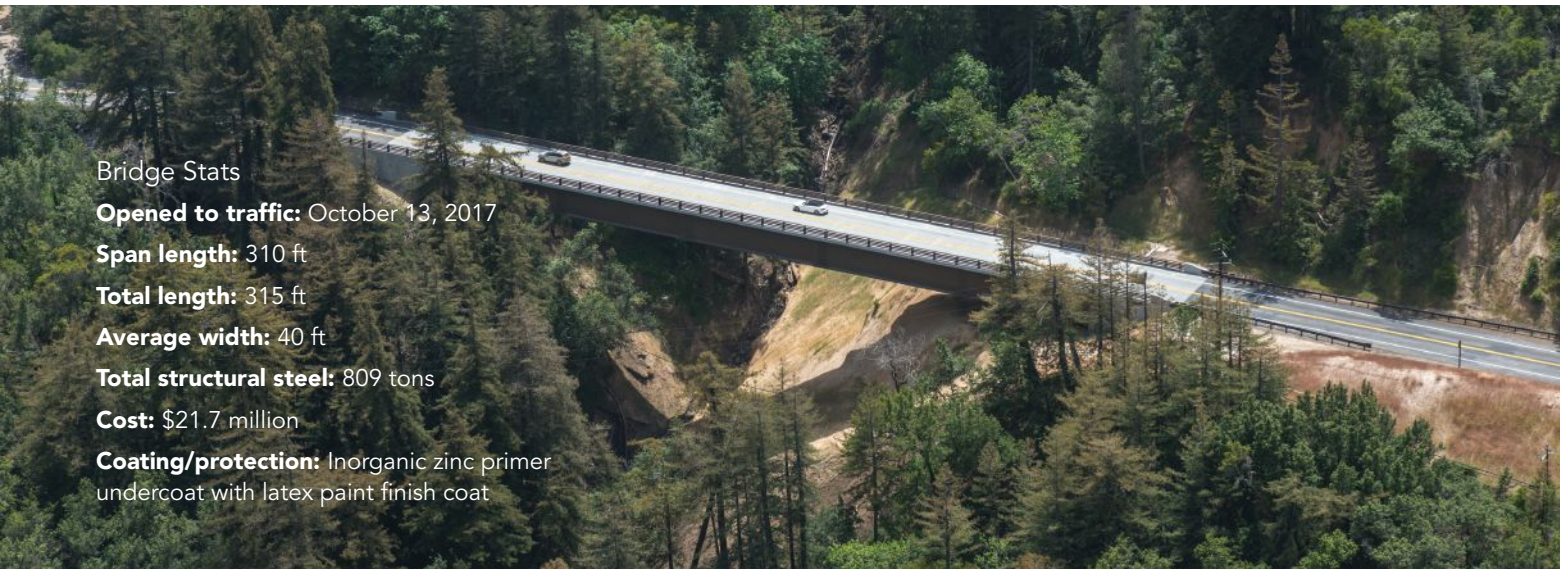

**Bridge Stats**

**Opened to traffic:** October 13, 2017

**Span length:** 310 ft

**Total length:** 315 ft

**Average width:** 40 ft

**Total structural steel:** 809 tons

**Cost:** \$21.7 million

**Coating/protection:** Inorganic zinc primer undercoat with latex paint finish coat



## NATIONAL AWARD Major Span Governor Mario M. Cuomo Bridge, Westchester/Rockland Counties, N.Y.

**THE NEW NY BRIDGE PROJECT** produced a crossing of rather epic proportions.

The \$3.98 billion undertaking replaced the old Tappan Zee Bridge with the new 3.1-mile-long twin-span Governor Mario M. Cuomo Bridge over the Hudson River, located approximately 20 miles north of New York City. One of the largest-ever transportation design-build contracts in the United States, it is designed for a 100-year service life and carries a new enhanced regional bus service in addition to typical road traffic, and the foundations are designed to carry future commuter/light rail tracks on structures erected between the two spans. The largest bridge project in New York history provides greater traffic capacity while improving operations and safety for motorists crossing one of the widest parts of the Hudson River.

The new bridge features parallel 3.1-mile-long structures, each with a 2,230-ft cable-stayed main span and ten 1,750-ft five-span continuous approach units comprised of 350-ft steel girder spans. It provides eight general traffic lanes, plus dedicated bus lanes and shoulders for emergency access. The design team selected structure types with proven service life and efficiency in order to maximize span lengths and minimize foundation demands while engaging local trade expertise. The approach structure design maximized span lengths using a long-span steel girder sub-stringer system with an average span length of 350 ft, resulting in fewer foundations needed. In the deep clay area, the highest-capacity friction piles (2,100 tons) ever used in these types of soils were implemented and have proven to be successful.

As the lead designer, HDR analyzed, designed, and detailed the approach structure steel girder sub-stringer system, which included composite steel girder design, sub-stringer design, and cross-frame design in accordance with AASHTO *LRFD Bridge Design Specifications*. 3D finite element models were created to analyze the steel system as a whole and to develop demands for design. Half of the units were located on a curved alignment, which required the design of continuous curved steel girders in which the effects of torsion were considered in both the temporary and permanent state.

Design of the approach spans was based primarily on five-span continuous units. The steel framing supporting each roadway deck included five main girders and four substringers to minimize foundation loads. Overall, 110,000 tons of fabricated structural steel went into the project.

Steel allowed much of the superstructure construction to be modularized. Large picks were made possible by the relatively light superstructure, saving time, minimizing the number of construction activities that needed to occur at elevation, and providing a safer construction process. The light steel superstructure also allowed the team to optimize the pier and foundation designs. Besides minimizing the gravity loads, the seismic demands were minimized by the reduced mass and increased flexibility of the superstructure when compared with other considered structure types. Most of the approach structures are founded on either 3-ft- or 4-ft-diameter steel pipe piles, and the towers, anchor piers, and approach piers adjacent to the anchor piers are founded on 6-ft-diameter steel pipe piles.

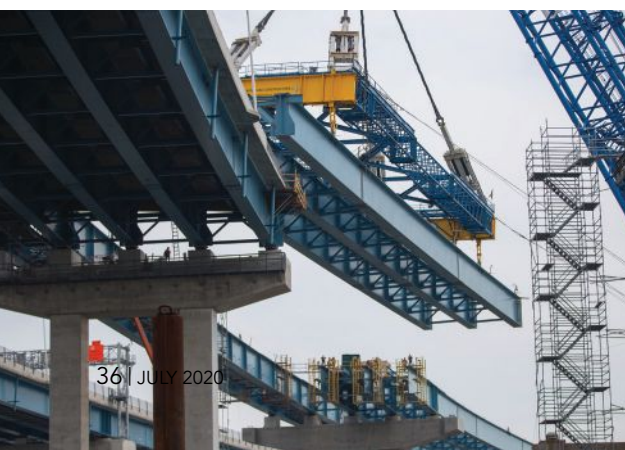



The flexibility of a steel superstructure was also highlighted in a portion of the site over Metro-North Railroad tracks where crane access was limited. HDR worked with the contractor to develop a steel girder system that could be launched from the Westchester abutment in multiple phases overnight during track outages. The designer worked hand-in-hand with the erection engineer up front to ensure that the design could accommodate variations in loading during launching activities, which minimized changes during the fabrication process.

**Owner**

New York State Thruway Authority, Albany, N.Y.

**Design/Builder**





Tappan Zee Constructors, LLC, a joint venture of:  
 Fluor, American Bridge Company ,  
 Granite Construction Northeast, and Traylor Bros., Inc. 

**Structural Engineer**

HDR, New York

**Steel Team**

**Fabricators**

- High Steel Structures LLC, Lancaster, Pa.   
 (approach unit superstructure, also detailer)
- W&W/AFCO Steel, Greensboro, N.C.   
 (approach unit superstructure, also detailer)
- Canam-Bridges, Point of Rocks, Md.   
 (main span superstructure)
- L&M Fabrication and Machine, Inc., Bath, Pa.   
 (main span superstructure)

**Detailer**

Tenca Steel Detailing, Inc., Quebec 

**Bridge Stats**

**Opened to traffic:** September 1, 2018

- Span lengths:** Two parallel three-mile structures, each with:
- Unit 11 WB/EB: 2,230-ft cable-stayed unit comprised of a 1,200-ft main span and two 515-ft anchor spans
  - Unit 1 WB/EB: 388-ft two-span simply supported approach unit comprised of 116-ft and 272-ft spans, respectively
  - Unit 2 WB/EB: 1,000-ft three-span continuous approach unit comprised of spans varying between 309 ft and 350 ft
  - Unit 3 WB/EB through Unit 8 WB/EB: Six 1,750-ft five-span continuous approach units comprised of 350-ft steel girder spans
  - Unit 9 WB: 1,075-ft three-span continuous approach unit with spans varying between 345 ft and 365 ft
  - Unit 9 EB: 1,666-ft five-span continuous approach unit with spans varying from 301 ft to 354 ft with a simple 224-ft jump span at the end
  - Unit 10 WB: 745-ft three-span continuous approach unit with spans varying from 235 ft to 262 ft

**Total length:** 3.1 miles (16,368 ft) per bound

**Average width:** Westbound: 96 ft; Eastbound: 87 ft

**Total structural steel:** 110,000 tons (including steel pipe piles)

**Cost:** \$3.98 billion

**Coating:** Painted weathering steel for the superstructure, galvanized rebar and specific coatings and overlay for the concrete deck



photos in this spread courtesy of New York State Thruway Authority

## MERIT AWARD Major Span Broadway Bridge Over the Arkansas River, Little Rock/North Little Rock, Ark.

**THE ORIGINAL BROADWAY BRIDGE** served the communities of Little Rock and North Little Rock, Ark., for over 90 years as both a vital crossing and a signature tribute to World War I veterans.

Built in 1922, it carried vehicular traffic into the downtown area with nearly 24,500 vehicles per day. However, with the continuing trend of residential redevelopment in the two cities' downtown areas, the increasing need for safe and efficient crossings of the river became more apparent. In 2010, the Arkansas Department of Transportation (ARDOT) made the decision to replace this functionally obsolete bridge due to it being structurally unsound as well as the lack of mobility it provided for the growing population in the area. The team of HNTB Corporation and Garver, LLC, was chosen to design the replacement bridge in 2011.

Garver developed a new layout to address the current traffic needs while increasing safety for the traveling public, and was responsible for improving sight distances, as well as separating motorists and pedestrians, through the addition of a 16-ft-wide shared-use path, two new pedestrian-only ramps connecting the trails directly to this path, and MSE walls to reduce right-of-way impacts and overall bridge length.

Pulaski County leaders wanted the bridge to serve as a unique and pleasing experience for pedestrians and cyclists by enhancing the aesthetics of the bridge, and contributed \$20 million of the \$98 million total project cost to be spent toward two signature spans over the river. These funds allowed the design to possess an enhanced aesthetic form constructed in an accelerated fashion and using a limited budget to satisfy the current and future needs of the community.

The HNTB-designed main spans of the Broadway Bridge are composed of two 448-ft network tied-arch spans with steel plate girder approaches. The lengths of the five approach spans vary from 126 ft to 227 ft. The final design consists of inclined basket-handle arches with a framed-in floor system, resulting in a cost savings for the bridge. The tied arches allowed a signature structure to be constructed on the existing alignment ahead of the anticipated 180-day closure by using an accelerated bridge construction (ABC) technique to float the arches into place.

Throughout design and construction, great care was taken to observe the U.S. Federal Highway Administration's strict guidelines for fracture-critical members. The bridge was made with ASTM A709 Grade 50 steel, which includes the Charpy V-notch Zone 3 requirements for increased toughness. This was important for the tie girder, floor beams, and hanger plates as they are all considered fracture-critical members. For the tie girder, the cross section con-

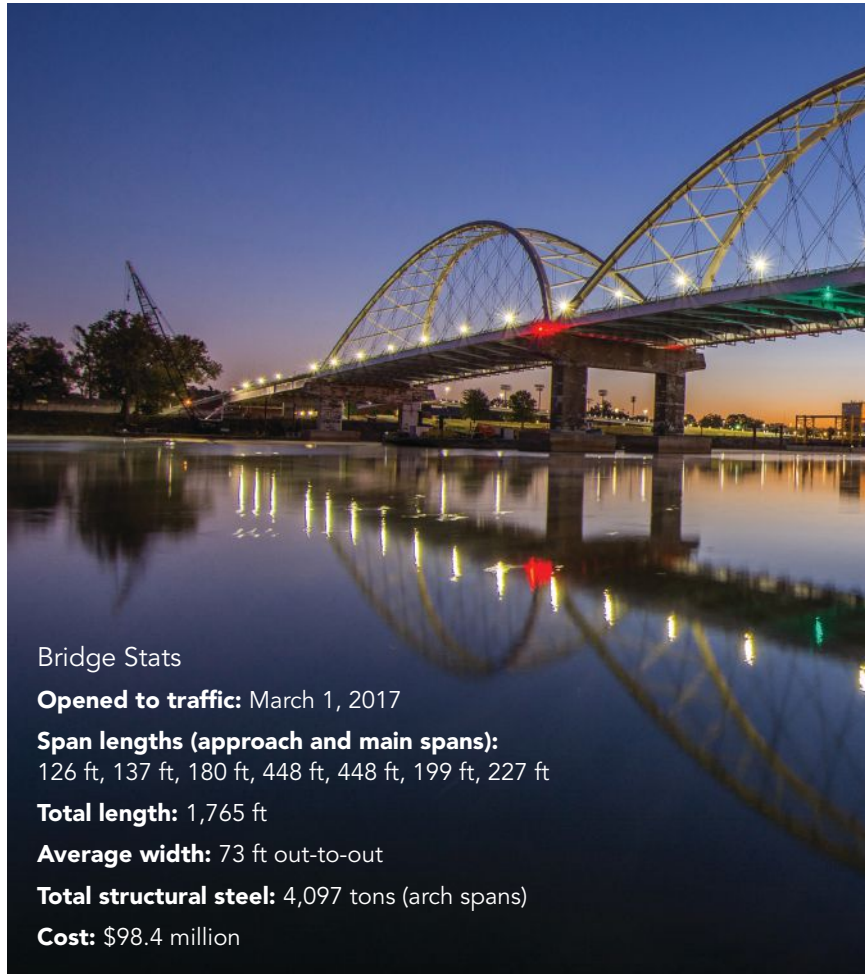

### Bridge Stats

**Opened to traffic:** March 1, 2017

**Span lengths (approach and main spans):**  
126 ft, 137 ft, 180 ft, 448 ft, 448 ft, 199 ft, 227 ft

**Total length:** 1,765 ft

**Average width:** 73 ft out-to-out

**Total structural steel:** 4,097 tons (arch spans)

**Cost:** \$98.4 million







HNTB



HNTB

Greg Davis, courtesy of Massman



Greg Davis, courtesy of Massman



sists of a closed parallelogram box girder made up of two inclined webs and two horizontal flanges. The web plates are welded to tab plates with a double-fillet weld and are then bolted to the flanges. This bolted connection isolates a potential fracture of one plate without allowing the fracture to propagate throughout the cross section. The resulting three-sided tie girder section was designed to carry the structural demands at an extreme event limit state, and this internal redundancy eliminates the potential of a catastrophic structural failure.

The construction of the arches took place on falsework floating in the river moored to the north bank of the Arkansas River. This technique provided extra space for the contractor to work since the construction footprint was limited for such a large urban project. To minimize the closure period during construction, the bridge's new foundations were strategically placed to provide clearance from the existing foundations. This allowed the contractor to use specialized equipment to construct the new drilled shafts and waterline footings beneath the existing bridge while the bridge remained open to traffic. The new tied-arch structure was floated into place once the primary structural steel framing was erected. This ABC process required only two 24-hour river closures.

Using these techniques, the team was able to open the \$98 million structure to vehicular traffic on March 1, 2017, removing 28 days from the anticipated 180-day closure period and following 2.5 years of construction.

*For more on the Broadway Bridge, see "Making a Signature Connection" in the July 2017 issue, available at [www.modernsteel.com](http://www.modernsteel.com).*

#### Owner

Arkansas Department of Transportation,  
Little Rock, Ark.

#### Prime Contractor



Massman Construction Co., Overland Park, Kan.

#### Structural Engineers

HNTB, Kansas City, Mo.  
Garver, North Little Rock, Ark.

#### Steel Team

##### Fabricators

Veritas Steel, Palatka, Fla.   
W&W/AFCO Steel, Little Rock, Ark.   
Delong's, Inc., Jefferson City, Mo.   
(also detailer, south approach)

##### Detailers

Tensor Engineering, Indian Harbour Beach, Fla. (arch spans)   
ABS Structural, Melbourne, Fla. (north approach) 



#### Bridge Stats

**Opened to traffic:** December 11, 2017

**Span length:** 483 ft

**Total length:** 963 ft

**Average width:** 22 ft

**Total structural steel:** 4,300 tons

**Cost:** \$68 million

**Coating/protection:** Paint

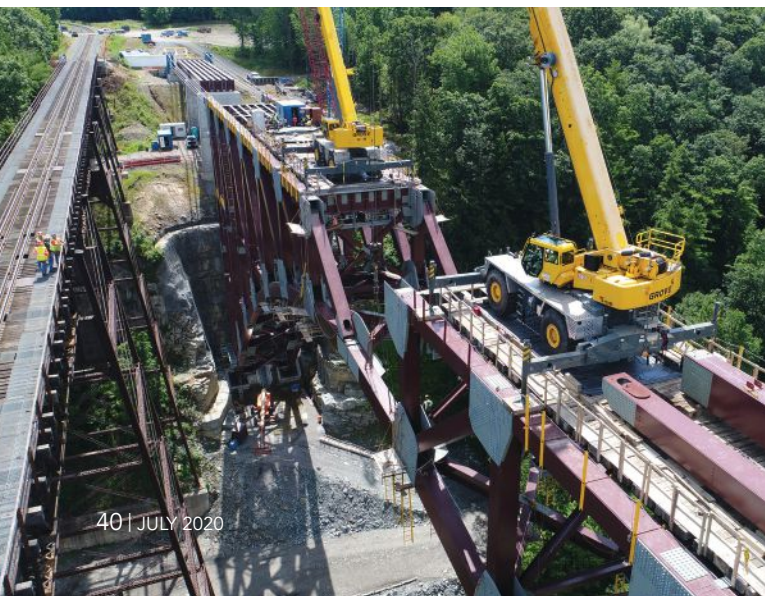
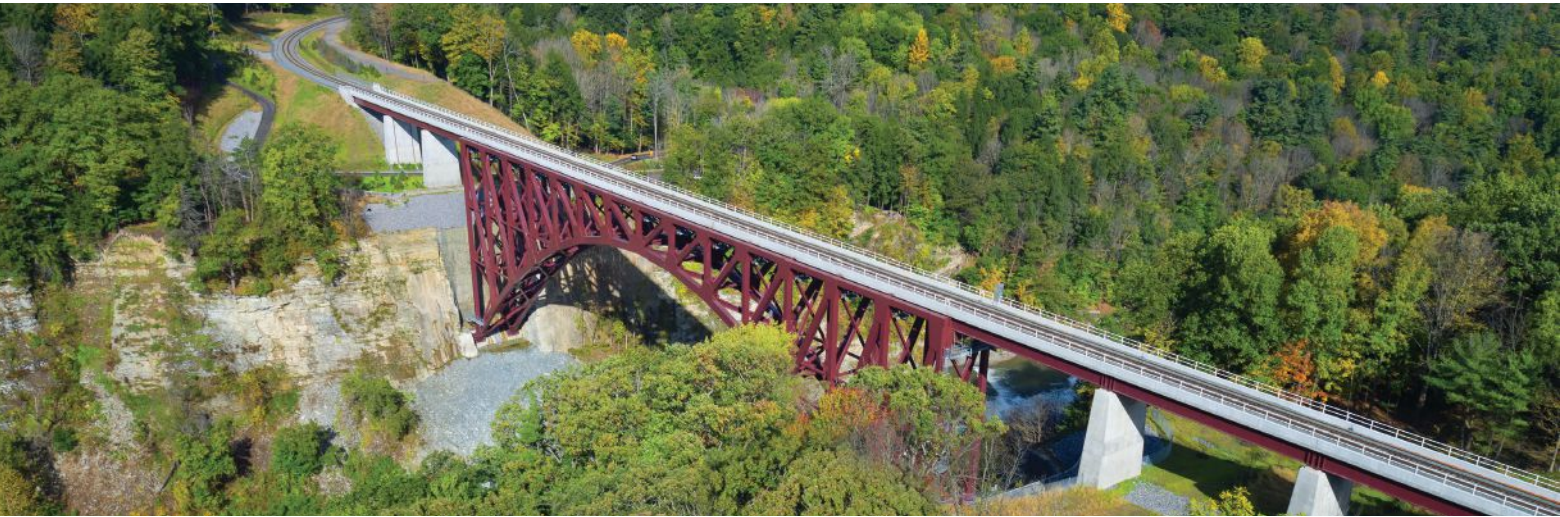

all photos and graphics in this spread courtesy of Modjeski and Masters



## MERIT AWARD Major Span Portageville Bridge Replacement, Portageville, N.Y.

**THE NEW PORTAGEVILLE BRIDGE** had big shoes to fill, so to speak.

The original bridge crossed the scenic Genesee River Gorge, known as the “Grand Canyon of the East,” in Letchworth State Park in Portageville, N.Y., which hosts more than a million visitors a year thanks to its stunning scenery, including three large waterfalls along the Genesee River (the new bridge, adjacent to where its predecessor once stood, is located directly above the Upper Falls).

The old viaduct bridge, built in 1875, was considered iconic within the Park and it was expected that a new bridge would need to be as well. After nearly a decade of public meetings, stakeholder input, environmental study, and engineering analysis it was determined that the new bridge would be a spandrel-braced arch. Through the State Environmental Quality Review Act, nine different alternatives were evaluated, based on the project objectives and the site’s unique characteristics. Ultimately, the best alternative was to build a new bridge on a parallel alignment and remove the existing bridge.

Modjeski and Masters (M&M) led the structural design of the new 483-ft-long arch. The arch is flanked on both sides by three 80-ft-long welded girder spans, and the track is supported across the bridge with a 20-ft-wide concrete ballast deck. The welded girder spans are supported on reinforced concrete piers and abutments that are founded on micropiles. The selected design was the first true arch bridge built for the rail industry since the late 1940s.

The bridge required project-specific design criteria as its span was beyond the guidance provided by the *American Railroad Engineering and Maintenance of Way Association (AREMA) Manual*, which is primarily used on simple-span bridges less than 400 ft in length. The arch was erected in two halves, from the east and west skewback foundations, using the cantilever method. An east and west “arch tieback system” was designed to support each arch half during cantilever erection up until arch closure. Each tieback system tied into the gusset plate at the end of top chord of the arch, and then anchored into a guy tower and backstay system with 12 cables. The guy towers transferred cable demands to a series of back stay members and directed the vertical components into the permanent approach span abutment. The backstays were connected to a grillage system that was anchored by 140-ft -ong pretensioned rock anchors.

Each individual cable was connected to a tensioning device equipped with a jacking rod and center-hole jack, which was used to adjust the cable lengths and thus the arch geometry during erection and arch closure. The deflection of the arch and the tension in the tieback system cables were monitored throughout cantilever erection stages. Field-recorded values were compared to theoretical values obtained from a staged construction analytical model to

ensure the arch closure geometry was eventually achieved. At the arch closure stage, the geometry for each half was fine-tuned using the tieback system until the bolt holes in the lower center panel point were aligned.

The gorge walls had an irregular shape and were not easily accessible. The difficult terrain would have made conventional surveying methods difficult, so lidar scanning was used to make a preconstruction survey of the gorge walls. The preconstruction survey was used for placement of cranes and the determination of lifting radius, and an additional lidar scan was made after the gorge pockets were completed to verify excavated quantities.

The AREMA guideline for spacing trusses at 1/15 of span length was not followed, due to the unnecessary width that would be added due to the long span. The structure was proportioned such that no load combination produced uplift, except for a few combinations during construction staging. Plate thicknesses of box members were sized to preclude the need for longitudinal stiffeners. The main members were designed including in-plane and out-of-plane bending moments. As many of the applied loads can be multi-directional and thus cause moments to change direction, a conservative assumption was made to combine them in an additive manner and match the polarity of the axial loading under investigation.

A memorandum of agreement between the Federal Highway Administration; Norfolk Southern; New York State Department of Transportation; the New York State Office of Parks, Recreation, and Historical Preservation; the National Park Service; and various Indian Nations was created to produce a mutually agreed plan to avoid, minimize, or mitigate the impacts on various historic and cultural resources. The agreement stipulated that portions of the existing bridge would be salvaged and displayed to mitigate the removal of the bridge. Impacts on other historical resources were avoided through a construction protection plan. In addition, plans were developed to protect endangered species, including northern long-eared bats, timber rattlesnakes, and bald eagles during construction.

### Owner

Norfolk Southern Corporation, Atlanta

### General Contractor and Steel Erector

American Bridge Company, Coraopolis, Pa.



### Structural Engineer

Modjeski and Masters, Mechanicsburg, Pa.

### Steel Fabricators

Canam-Bridges, Point of Rocks, Md. (arch bridge)

Veritas Steel, LLC (approach deck girder steel spans)

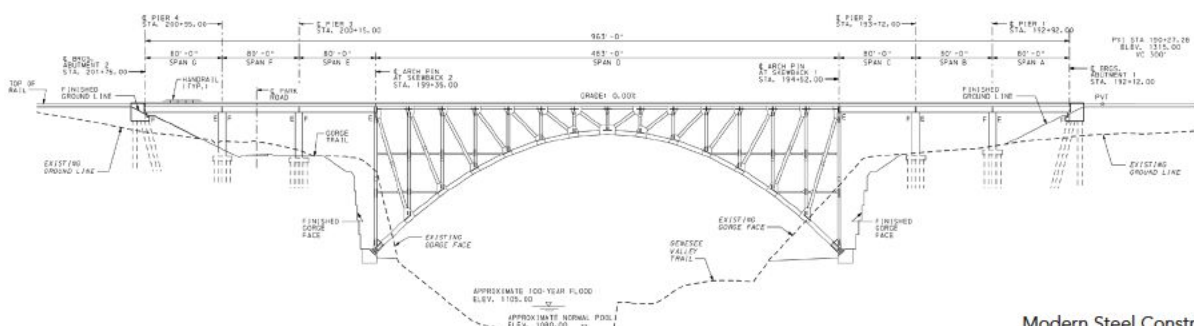

## NATIONAL AWARD Moveable Span Sarah Mildred Long Bridge, Kittery, Maine/Portsmouth, N.H.

**THE NEW SARAH MILDRED LONG BRIDGE** across the Piscataqua River between Portsmouth, N.H., and Kittery, Maine, replaces an existing span built in 1940.

Where the original bridge involved a bi-level lift span and approach bridge format, the new incarnation is a single-level lift span with bi-level approach spans. Both new and existing structures were designed to carry vehicular traffic (on the upper level) and rail traffic (on the lower level), with the new single-level lift span lowering for rail traffic and raising for maritime vessels.

The project included a complete bridge replacement including foundations, an operator's room, new traffic warning systems, a new 300-ft-long steel box girder lift span, and precast post-tensioned towers and vehicular and railroad approach segments. Key challenges included minimizing construction costs and construction time, a swift tidal channel with a current of approximately 5 knots and a tidal change of 8 ft, and a design vessel collision force of 6,000 tons.

On the lift span itself, where originally positioned on separate levels, the rail and roadway are on the same level, with the tracks are embedded in the median, and dual seating positions (vehicular and rail) allow the single-level lift span to match the bi-level approaches. Since the new bridge has a 56-ft vertical clearance when in its "resting" position (an increase in vertical clearance from the original configuration) there will be 68% fewer bridge openings than with the old bridge, significantly reducing the number of traffic delays. The lift span is simply lowered down to match up with the railroad bridge approaches on the relatively rare occasion when trains are traveling across the river.

A traditional twin steel tub girder design with a continuous top plate was employed for the lift span superstructure to facilitate shipping to the site by truck from inland fabricators. This allowed the final configuration of the lift span to be fabricated at local inland facilities then assembled on-site, reducing the construction schedule and planned existing bridge closures.

The lift span girder is a multi-box steel structure with a composite concrete deck. Based on the length-to-width ratio of the structure, the entire cross section is effective in resisting global forces. The primary longitudinal load carrying members include two main boxes with separate bottom flanges, two fascia box beams, and a composite concrete deck. In addition to contributing to the overall cross section, the composite deck is designed to transmit local loads transversely to the main longitudinal elements. Longitudinal elements are braced at discrete points along the length of the span at 12-ft increments. Transverse elements include cantilever brackets between fascia boxes and main boxes, internal box bracing, and intermediate diaphragms along the centerline of the span between main boxes, and the lift span girder is supported at each end by transverse lifting girders.



all photos in this spread courtesy of Maine DOT

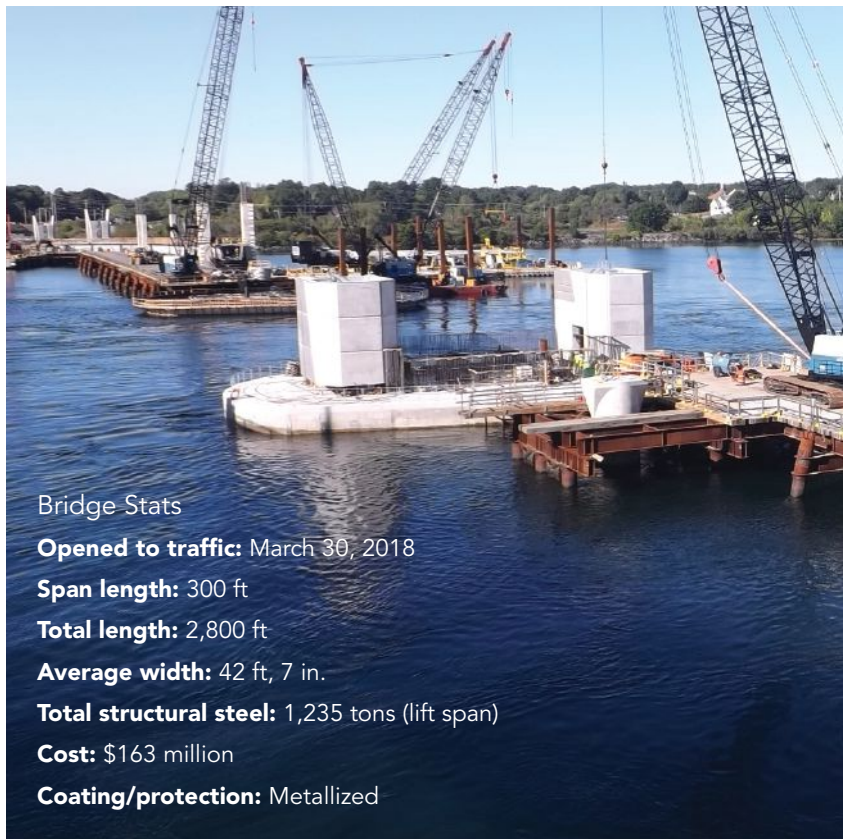

### Bridge Stats

**Opened to traffic:** March 30, 2018

**Span length:** 300 ft

**Total length:** 2,800 ft

**Average width:** 42 ft, 7 in.

**Total structural steel:** 1,235 tons (lift span)

**Cost:** \$163 million

**Coating/protection:** Metallized

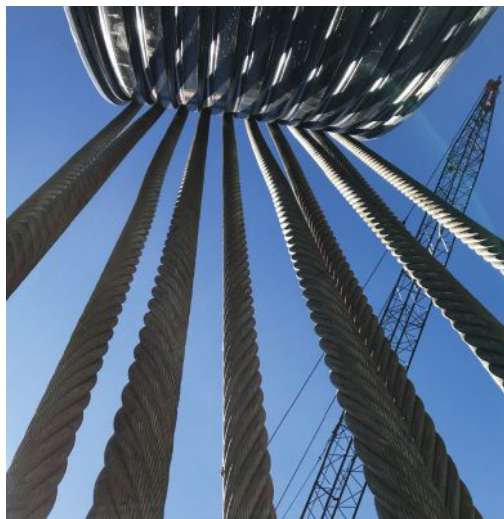

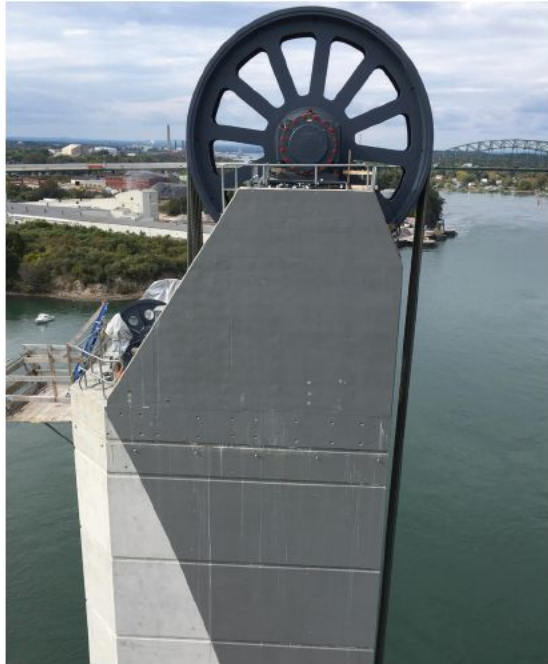

The main boxes are aligned such that the interior webs are located directly below each rail track. The track is embedded within the concrete deck, with minimal cover to the top of the steel, and the design team implemented a direct load path into the box section. In addition to providing a predictable load path, this alignment eliminated the need for supplemental track support structures and ultimately reduced the span weight.

An innovative retractable support system was developed to support the lift span at the mid-level roadway position and move out of the way to allow the lift span to lower to the rail position. Tapered steel columns founded on spherical bearings at the rail level and cylindrical bearings at the electrical room under the roadway level rotate to allow for the dual seating of the lift span.

The fatigue critical areas of the structure are primarily located along the top flange plate when subjected to transverse loading. Fatigue analysis of the deck plate required an increased plate size along the centerline of the span, below the track and extending beyond the interior web plates. Deck plate details in the longitudinal direction are not a fatigue concern, as the flange always remains in compression.

Placing the operating machinery at the base of the tower is an innovation that is relatively recent to the movable bridge industry—and one that was implemented on the new Sarah Mildred Long Bridge. By locating the lifting machinery, mechanical systems, and electrical systems lower in the tower, all this equipment was installed before completing tower erection and lift span float-in. This provided for quicker construction, reducing initial costs and providing easier access for future maintenance.

The lift span box girders and other lift span steel components were fabricated at Casco Bay Steel Structures in South Portland, Maine, sent by rail to a waterfront facility, and then barged to the bridge site. Float-in was a complex operation that required a fixed guide barge, an adjacent push barge with two tugs, and a lift span overhanging barge. Several important steps followed the float-in, including deck placement, joint installation, finger joints, mitre rail, span guides, access, and rope connection.

The bridge was designed with long open spans, using 11 fewer piers than the old bridge. This span layout not only enhanced vistas for residents and motorists, but it also enabled the new bridge to cross Market Street without a pier in the median and serve as a gateway entrance into historic downtown Portsmouth.

**Owners**

Maine Department of Transportation, Augusta, Maine  
New Hampshire Department of Transportation, Concord, N.H.

**General Contractor and Steel Erector**

Cianbro, Pittsfield, Maine 

**Structural Engineer**

Hardesty & Hanover, LLC, New York

**Steel Team**

**Fabricator**

Casco Bay Steel Structures, Inc.,  South Portland, Maine

**Detailer**

Tensor Engineering, Indian Harbour Beach, Fla. 



all photos in this spread courtesy of HDR

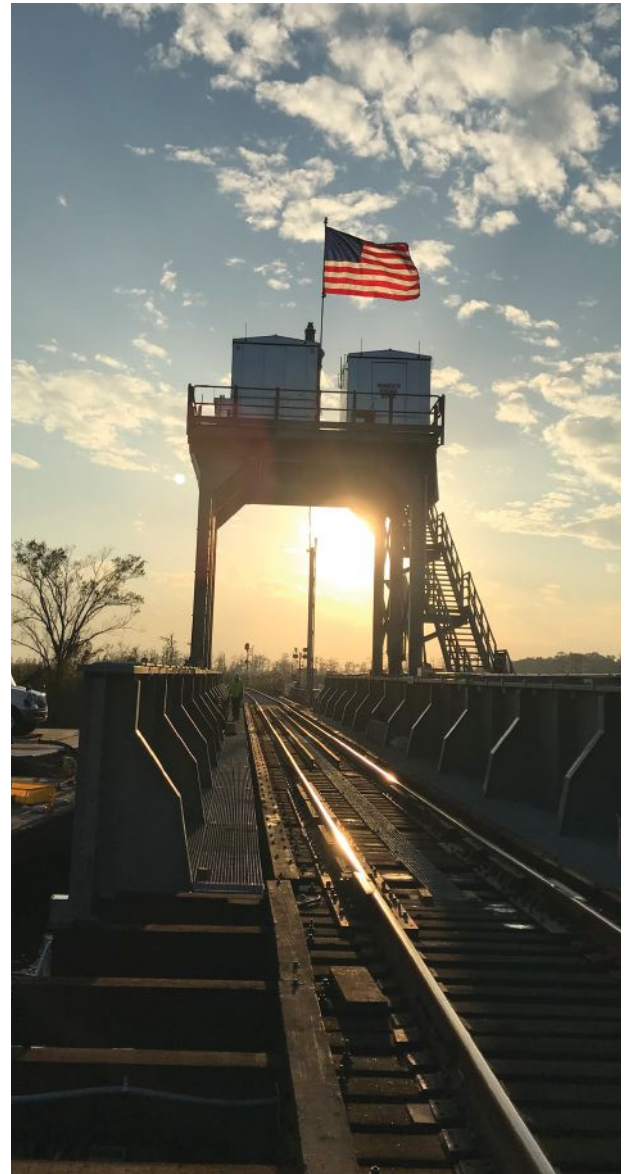
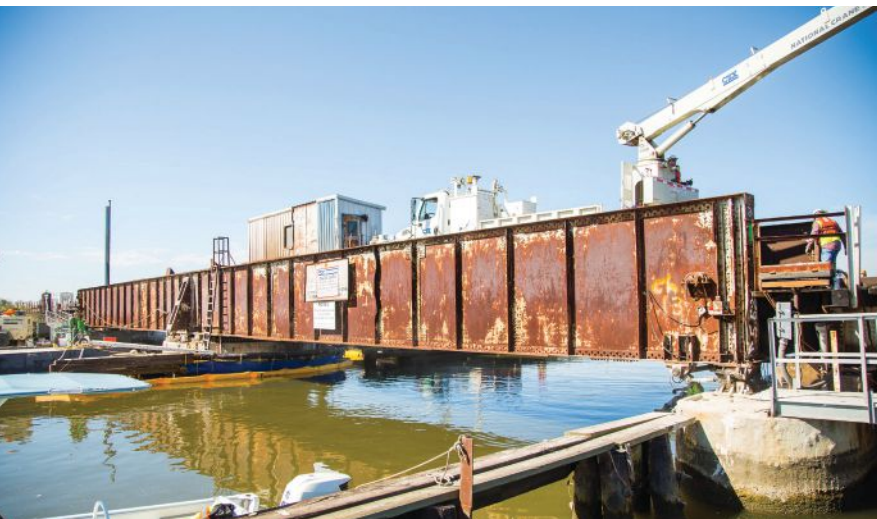

## MERIT AWARD Moveable Span Bayou Sara Swing Bridge, Mobile County, Ala.

**CSX'S SINGLE-TRACK, 163-FT-LONG** Bayou Sara Swing Bridge is one of the rail transportation company's 47 movable bridges.

While the approach spans had been recently replaced, the swing span was over 90 years old and was scheduled to be replaced as part of a program to upgrade all of CSX's movable bridges. To replace this critical link on the company's Mobile Bay line, they turned to HDR to design a durable replacement to include remote operation, minimized maintenance, and limited rail service interruption during construction. By opting for an in-kind replacement, the team reused the substructure, simplified construction, sped up the schedule, and reduced permitting requirements and track outages.

The mass of a swing span must be balanced for proper operation. Many swing spans, including the old Bayou Sara Bridge, have the control house mounted to a platform along the span edge, near the pivot. This requires a counterweight on the opposite girder to transversely balance the span. In the replacement bridge, the new electrical components, hydraulic equipment, and control systems are positioned on a platform above the track. This platform

required ample height to allow trains to pass beneath, elevating the bridge's equipment. This brought several advantages, including security, environmental resiliency, and balance as the counterweight steel was reduced by 20 tons. An outboard access walkway and stairway provide access to the platform, away from the track.

Using a steel "grillage" to be embedded in the pier cap concrete, the bridge machinery and bearings were aligned and locked in their final position on this assembly suspended from beneath the span prior to float-in. The grillage took the place of the top portion of the pivot pier, which was removed during construction. It provided support for all dead and live loads applied to the pivot pier, permitting rail traffic to pass almost immediately after the span float-in. The outage for marine navigation was longer than for the track, and this allowed for casting the surrounding concrete in place after the float-in phase and prior to operating the swing span.

During hurricanes or lunar high tide, it was common for the water to rise above the bottom flange of the girders, inundating the bridge machinery with brackish coastal water. Since the bridge



### Bridge Stats

**Opened to traffic:**

November 24, 2017

**Span lengths:** 164 ft (swing span),  
234 ft (approach spans, not replaced)

**Total length:** 398 ft

**Average width:** 20 ft

**Total steel tonnage:** 250 tons

**Cost:** \$18 million

**Coating/protection:** Metallized  
up to track rail elevation,  
paint system above



approaches could only be raised minimally, the replacement bridge incorporated features that mitigated the effects of high water inundating the lower part of the bridge. The team placed the operational machinery on a gantry 28 ft above the track to remain above the water even during the worst of storms.

Given the challenges, collaboration was critical to project success. The decision to proceed with the grillage concept was ultimately made in September 2017, approximately two months prior to the target float-in date. This limited the schedule for detailed design, procurement, fabrication, and assembly. When the grillage concept was first discussed, general contractor Brasfield and Gorrie immediately contacted the steel fabricator, Steward Machine, to discuss constructability and material availability, and Steward provided feedback on available structural shapes, which were approved. This collaborative effort expedited shop drawing development and engineering review, which was crucial to procuring the grillage in time for installation prior to the float-in.

From the beginning of the project, the rail outage allowed by CSX's freight rail operations team was to be 48 hours, which is a challenging window for removing a movable bridge span and installing a new one. During the construction phase, a plan was

developed to swap out the spans within this time frame, using a precast concrete pier cap to simplify construction and replace the deteriorated concrete cap.

However, as the planned outage drew near, CSX asked if the outage could be reduced so as to avoid delaying trains, several options were considered, including temporary piles, which would have added significant costs to the project. In the end, the collaborative efforts between the owner, contractor, and engineering teams concluded that the most cost-effective solution was a structural steel support frame (grillage) suspended from the new swing span with pre-mounted rack, wedges, and pivot bearings. This additional pre-work allowed for an accelerated swap-out of the swing spans, reducing the required track outage to only 14 hours.

**Owner**

CSX Corporation, Jacksonville, Fla.

**General Contractor**

Brasfield and Gorrie, Birmingham, Ala.

**Structural Engineer**

HDR, Newark, N.J.

**Steel Fabricator and Detailer**

Steward Machine Co., Inc., Birmingham, Ala.



**NATIONAL AWARD** Special Purpose  
Frances Appleton Pedestrian Bridge, Boston

---

**THE FRANCES APPLETON PEDESTRIAN BRIDGE** project achieves visual transparency and lightness through a carefully selected structural steel system as it connects Boston’s Beacon Hill neighborhood to the Charles River Esplanade.

The slenderness of the bridge was balanced against creating a structure that would potentially have issues with pedestrian-induced vibrations. During the design process, multiple iterations of the structural system were performed to achieve the “maximum” comfort range for pedestrians while eliminating the need for future supplemental measures, such as installing tuned mass dampers. The final design includes the creative use of a lightweight concrete deck with foam-filled stay-in-place forms and appropriate foundation details.

The 750-ft-long multiuse walkway, adjacent to the historic landmark Longfellow Bridge, consists of a contemporary tubular steel arch with a span of approximately 226 ft over a parkway. The steel superstructure, approximately 550 ft in length, is continuous without any joints and its shape in plan follows a curvilinear alignment in two directions. The arch and approach spans follow a distinct architectural theme of slender steel piers and struts for visual consistency and aesthetic appeal.

The new crossing replaced an existing bridge that was too narrow and had inadequate access stairs, and conflicts between pedestrians and bicyclists were common. The placement and overall geometry of the new bridge were carefully selected to comply with the ADA maximum slope requirements and avoid impacting large trees in the parkland as much as possible—and its width of 14 ft doubles that of the original bridge. Integrated into the bridge are several entry points and connections to the existing network of walkways along the Esplanade.

The elegant steel superstructure consists of steel girders branching into two curved staircases and a scenic overlook plaza near the river. The bridge’s steel fit-up required careful planning during the final design phase as construction over a busy arterial road necessitated a detailed erection plan and sequencing, and stresses were evaluated in all structural members during both fabrication and erection. The major challenge of this unique bridge was the fabrication of the steel structure and its overall constructability, and its design included complex curves and welded connections.

The main steel arch has a unique shape, being wider at the crown and narrower at the abutments, which helped minimize the

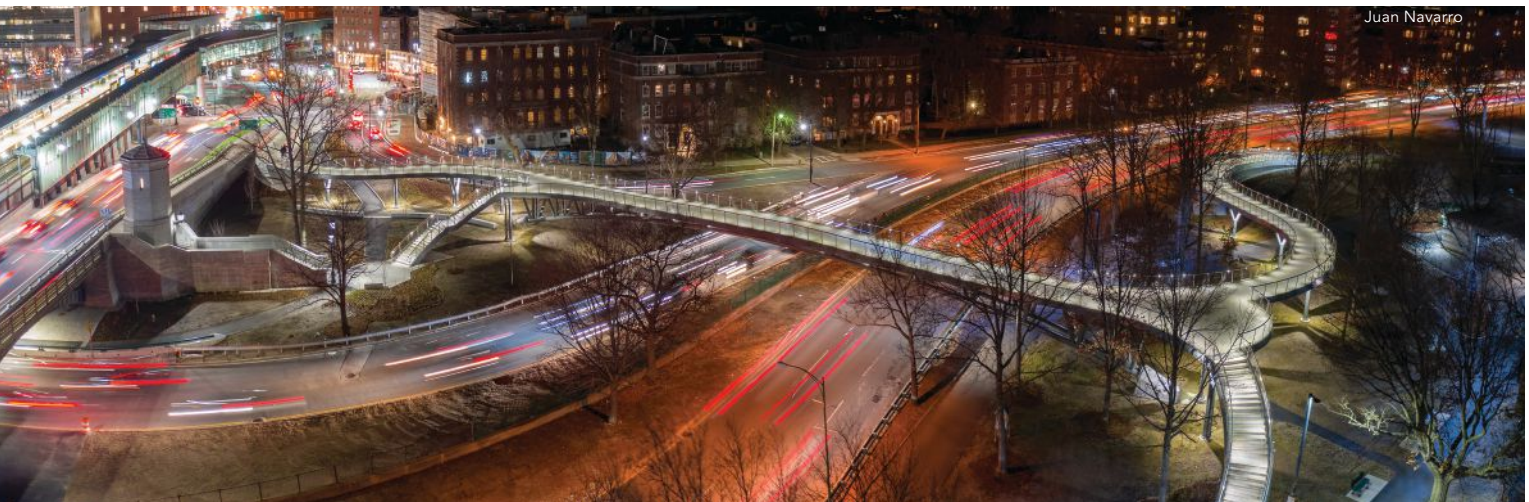





David Desroches



Carlos Arazaga

**Bridge Stats**

**Opened to traffic:** August 31, 2018

**Span lengths:** 43 ft, 36 ft, 49 ft, 49 ft, 23 ft, 226 ft, 16 ft, 21 ft, 25 ft, 30 ft, 30 ft

**Total length:** 548 ft

**Average width:** 14 ft

**Total structural steel:** 308 tons

**Cost:** \$12.5 million

**Coating/protection:** Metallized



David Desroches

size of the anchoring abutments at the park level. The arch also includes a series of inclined struts, creating a unique aesthetic truss effect, and is the longest bridge span over Storrow Drive connecting the city to the riverfront. The crossing is also higher than any other existing bridge along the highway corridor, opening views and incorporating appropriate vertical clearances.

The arch was brought to the site in pieces and assembled during overnight hours to reduced traffic impacts, and it was welded in place in order to avoid using visible bolted connections. The bridge approaches include Y-shaped piers, which visually match the main architectural theme creating a visually unified structural system. Aesthetic lighting is also included to increase the sense of safety and appeal at night, and the sinuous crossing is perfectly integrated into the landscape thanks to its transparency and lightness.

The new signature pedestrian bridge has quickly become a source of pride for the community due to its technical ingenuity, elegant detailing, and context-sensitive design, which perfectly integrates into Boston's landscape and historic riverfront.

*For more on the Frances Appleton Pedestrian Bridge, see "Take Me to the River" in the April 2019 issue, available at [www.modernsteel.com](http://www.modernsteel.com).*

**Owner**

Massachusetts Department of Conservation and Recreation, Boston

**General Contractor**

White/Skanska/Consigli, JV, Framingham, Mass.

**Designer**

Rosales + Partners, Boston

**Structural Engineer**

STV, Boston

**Steel Team**

**Fabricator and Detailer**

Newport Industrial Fabrication, Newport, Maine



**Erector**

Saugus Construction Corp., Georgetown, Mass.



**Bender-Roller**

Kottler Metal Products, Willoughby, Ohio



**Castings**

Cast Connex Corporation, Toronto





## MERIT AWARD Special Purpose 41st Street Pedestrian Bridge, Chicago

**CHICAGO'S 41ST STREET PEDESTRIAN BRIDGE** design was an award winner right from the get-go.

The design team's curving, arch-supported steel concept won an international design competition to create the bridge, and the resulting span connects the city's Bronzeville neighborhood with the trail system that runs along Lake Michigan. The bridge provides pedestrians with safe passage over Lakeshore Drive as well as the Metra Electric/CN Railroads, both of which had to stay in operation during construction. The railway sees approximately 263 trains per day while Lakeshore Drive carries approximately 100,000 vehicles per day.

The main span of this pedestrian bridge is made up of two main component round sections (36-in. and 48-in. OD induction bent pipe) tied together with built-up box girders. The pipe and bridge have both sweep and camber, so the pipe had to be carefully bent in order to induce both elements simultaneously. The process of induction bending the pipe was particularly challenging given that the actual diameter, ovality, and pipe shrinkage had to be taken into consideration prior to fabrication to ensure all of the subcomponents that tie into the pipe fit correctly. The bridge was progressively preassembled in the shop in order to ensure proper geometry and fit-up, which was especially challenging due to the large sweeping and curving geometry that required much preplanning and lots of shop floor space.

Another challenge that was met head-on was the logistics of shipping the large sections of the bridge from two fabrication shops to the project site. The bridge components were shop-welded to their fullest extent, resulting in extremely long, wide, and heavy permit loads that required significant preplanning and coordination. The largest structural piece was 62 ft long, 24 ft, 4 in. wide, and 38.3 tons, with the heaviest structural piece being just over tons. The bridge was shipped to the job site in 14 built-up sections, including six approach single-pipe spine assemblies and eight main span double-pipe assemblies; the main span assemblies were over 24 ft wide. The arches use bolted splices as well as field welds for aesthetic purposes, and the design team chose to use the end-plate bolted connection option to save time and cost during erection. Prior to delivery to the site, the structural steel was blasted and painted with a three-coat paint system in the shop. The project came in under budget and opened six months ahead of the original contract completion date.

### Owner

Chicago Department of Transportation, Chicago

### General Contractor

F.H. Paschen, S.N. Nielsen and Associates LLC, Chicago

### Construction Manager



TranSystems, Chicago

### Designer/Structural Engineer

AECOM, Chicago

### Steel Team

#### Fabricators

Hillsdale Fabricators, St. Louis   
Metal Pros, LLC, Wichita, Kan. (handrails) 

#### Erector

S&J Construction Co., Inc., Oak Forest, Ill. 

#### Detailer

Esskay Structures, Inc., Vienna, Va. 

#### Bender-Roller

BendTec Inc., Duluth, Minn. (also additional fabrication) 

**Bridge Stats**  
**Opened to traffic:**  
 December 20, 2018  
**Span length:** 750 ft  
**Total length:** 1,500 ft  
**Average width:** 24 ft  
**Total structural steel:**  
 676 tons

**Cost:** \$29 million  
**Coating/protection:**  
 PPG 68HS primer,  
 Amercoat 399  
 intermediate coat,  
 Amercoat 450H final  
 coat (Blue Oasis)

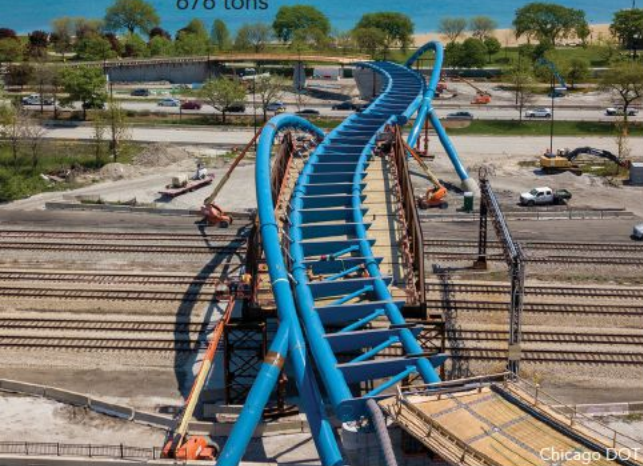

Kenny Flowers



Illinois DOT



Chicago DOT

**MERIT AWARD** Special Purpose  
**East Shore Bridge,**  
 Lake Tahoe, Nev.

**THE THREE-MILE STRETCH BETWEEN** Incline Village and Sand Harbor State Park on the east shore of Lake Tahoe in Nevada is, in a word, stunning. And a series of new steel-framed bridges is now part of this scenic multiuse path.

The owner, the Nevada Department of Transportation (NDOT), used the construction-manager-at-risk (CMAR) delivery method for this \$40 million trail project, which was defined by an accelerated delivery schedule, challenging subsurface conditions and terrain, high seismicity, limited construction access, and an environmentally sensitive project location.

The three miles of new multiuse path was installed on a steep side slope between the existing State Route 28 and Lake Tahoe. A total of five steel bridges, totaling 809 ft, are included along the path. To create a structural system that could be installed with minimal disruption to traffic on the heavily used SR-28 adjacent to the trail alignment, prefabricated bridge spans were designed that were comprised of weathering steel girders that supported lightweight fiber-reinforced polymer (FRP) deck units. The 50-ft-long prefabricated deck units were manufactured by Composite Advantage with steel supplied by fabricator Cox Brothers Machining. The deck units were shipped to the site and placed by contractor Granite Construction during short-term road closures.

Aesthetics was of primary concern due to various regulatory agencies that have jurisdiction over the project area. The project is highly visible from the lake and minimizing visual impacts to the terrain was very important. Weathering steel was used for the steel girders and hand railings to minimize long-term maintenance costs associated with painted steel and to provide a surface finish that blends in with the natural terrain. The steel pipe sections used for the columns at the piers were galvanized and then coated with Natina to provide a finish that matches the weathering steel stringers.

**Owner**

Nevada Department of Transportation,  
 Carson City, Nev.

**General Contractor**

Granite Construction Inc., Sparks, Nev.

**Structural Engineer**

Jacobs, Sacramento, Calif.

**Steel Fabricators**

Stinger Bridge and Iron, Coolidge, Ariz.   
 (substructure elements)

Cox Brothers Machining, Inc., Jackson, Mich.   
 (steel stringers and diaphragms)



Mike Okimoto



Mike Okimoto

**Bridge Stats**

**Opened to traffic:**

June 21, 2019

**Span length:** 50 ft

**Total length:** 809 ft

**Average width:** 11 ft

**Total structural steel:** 76.6 tons

**Cost:** \$1.9 Million

**Coating/protection:**

Weathering steel (girders and railings), galvanizing and Natina (pipe columns)

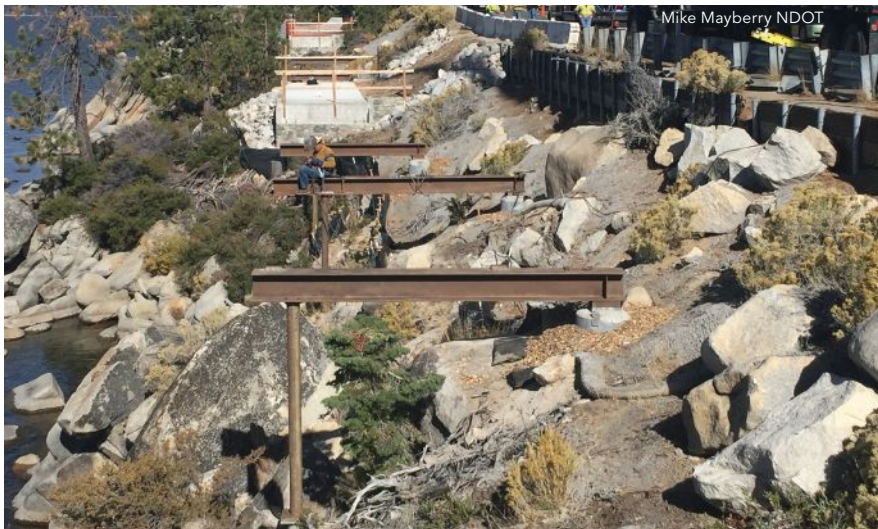

Mike Mayberry NDOT

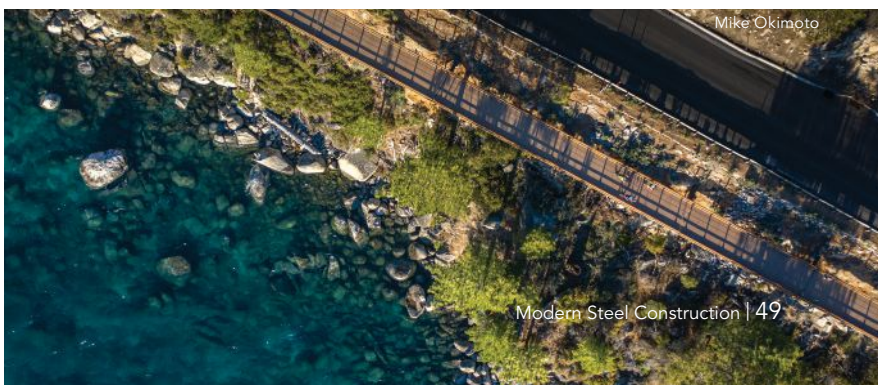

Mike Okimoto

## Bridge Stats

**Opened to traffic:** November 17, 2017

**Span lengths:** 72.80 ft, 221.36 ft, 442.08 ft,  
221.36 ft, 41.95 ft, 61.45 ft

**Total length:** 1,061 ft

**Average width:** 66 ft out-to-out

**Cost:** \$25,425,000

**Coating/protection:** Three-coat organic  
zinc-epoxy-urethane (Aztec Gold)



## NATIONAL AWARD Rehab Andy Warhol (Seventh Street) Bridge, Pittsburgh

**THE ANDY WARHOL (SEVENTH STREET) BRIDGE**, an eye-bar-chain, self-anchored suspension bridge, carries Seventh Street over the Allegheny River, the Tenth Street Bypass, and the Three Rivers Heritage Trail in downtown Pittsburgh.

Named for the famed artist who hailed from Steel City, it is one of the “Three Sisters” bridges constructed from 1924 to 1928 that comprise the only trio of identical, side-by-side bridges in the world, and is the first self-anchored suspension span constructed in the United States.

Due to accelerating age-related deterioration, the bridge required rehabilitation. The project involved replacing the bridge deck, totally repainting the superstructure, performing structural steel substructure repairs, and applying scour protection. Michael Baker International was chosen by the Allegheny County Department of Public Works to perform analysis and design of the rehabilitation, and the design team combined recognition of histori-

cal significance with modern engineering practices to complete a structurally superior, sustainable rehabilitation that was also aesthetically relevant and pleasing.

The bridge was analyzed for the first time using a fully 3D finite element model to examine the effects of unbalanced loading and modern vehicles on the structure. Numerous materials not normally used in new bridge construction were required to complete the rehabilitation. These included post-tensioned tie-down anchorages, forged steel bridge pins and nuts, permanently lubricated bronze bushings and washers, and bronze dedication plaques cast to replace missing plaques. Additionally, thousands of rivets were replaced with ASTM F3125 Grade F1852 high-strength bolts with button heads to mimic the look of rivets, thus improving structural capacity while being sensitive to appearance. These bolts were installed using electric shear wrenches capable of both providing uniform tension values and expediting bolt installation.

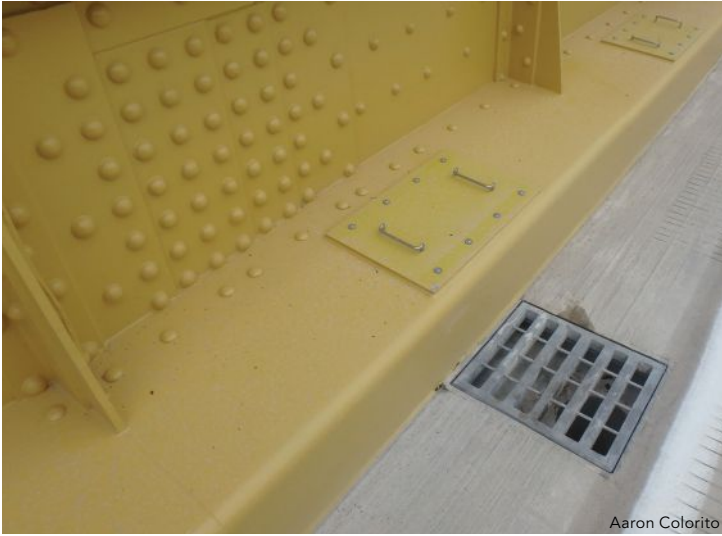

Aaron Colorito



Aaron Colorito



Aaron Colorito

New bridge lighting was provided on sidewalks and pylon rooms in a style replicating the original lighting fixtures. Additionally, new roadway curb boxes replaced the original flat curbs to prevent salt and debris from sitting on and corroding the stiffening girders. The curbs were designed to be as unobtrusive as possible while providing the benefit of draining water.

The complex rehabilitation was performed as a conventional design-bid-build construction project and concurrent with road work on I-279/HOV lanes/North Shore Expressway. This necessitated well-organized traffic control for nearby PNC Park and Heinz Field (homes to the Pittsburgh Pirates and Steelers, respectively) events, maintenance of pedestrian crossings at the adjacent streets, and sustained access to riverside trails and adjacent businesses.

The bridge also had to act as its own lay-down yard, resulting in tight site conditions. Temporary underdeck shielding was used to allow safe river access, which required coordination with the U.S. Coast Guard and local river users for minimum vertical clearances. Notice was broadcast daily to mariners, and a monitored phone number and radio channels were established for large vessels. Additionally, temporary Duquesne Light (electrical) conduit was

provided to enable work on sidewalk brackets and replacement of electric conduits and supports. Temporary conduit in plastic corrugated pipe was placed on the sidewalk to maintain safe working conditions around energized lines, as well as to maintain a major power supply for downtown Pittsburgh.

A variety of other construction innovations were implemented, including vibro-screed (air screed) and pump trucks to place the concrete deck, over-pouring the deck by ¼ in., subsequent grinding to provide correct cross slopes and longitudinal smoothness, and employing a temporary hold-down system using permanent post-tensioning rods. The new reinforced concrete deck is fully structural, using channel-type shear connectors to make the deck composite. The existing buckle plates, once the structural part of the deck, now remain as stay-in-place forms.

**Owner**

Allegheny County Department of Public Works, Pittsburgh

**General Contractor**

Brayman Construction, Saxonburg, Pa.

**Structural Engineer**

Michael Baker International, Moon Township, Pa.

## MERIT AWARD Rehab Winona Bridge, Winona, Minn.

**THE FRACTURE-CRITICAL WINONA BRIDGE** spanning the Mississippi River stands as a beloved landmark and vital thoroughfare for motorists traveling between Wisconsin and Minnesota. Built in 1942, it is the only pre-1946 cantilever through-truss bridge in the latter state and played a central role in sustaining the economy of Winona and facilitating the flow of defense materials during World War II.

That history was threatened in 2007 with the collapse of Minneapolis's I-35W bridge. Following the collapse, the Minnesota legislature provided funding and required MnDOT to develop an ambitious 10-year bridge replacement program, with a focus on fracture-critical bridges. MnDOT's inspection team discovered corrosion and section loss on multiple truss members, resulting in a load-posting that restricted heavier commercial vehicles and closed the bridge for more than a week. Immediate repairs provided a short-term solution, but they highlighted the structure's continued importance: Wisconsinites who depended on Winona's first-call ambulance services found their link to the town severed and local businesses took a hit during the shutdown. Nearly 12,000 motorists were forced to make detours of 60 miles roundtrip every day to other crossings over the Mississippi.

In 2014, MnDOT engaged Michael Baker as prime consultant and Ames Construction as prime contractor—the department's first use of the construction manager/general contractor (CM/GC) approach—to work together to ensure the long-term reliability of the structure. Tearing down the bridge had already been ruled out; it was eligible for listing on the National Register of Historic Places and had become an iconic asset for the region, even appearing on a postage stamp celebrating the state's sesquicentennial. So the team aimed for an ambitious goal: completely rehabilitating the bridge to resist modern permit loads, reconstructing the approach spans, rebuilding the deck, and adding internal redundancy to comply with the intent of the state statutes, all while avoiding any adverse effects determined by the State Historic Preservation Office. By modernizing the structure, the team would establish the first through-truss bridge in the Midwest to have internal redundancy added to all its fracture-critical elements.

Accomplishing all this required creative problem-solving and complex coordination. Completing a historic bridge rehabilitation is an intricate undertaking wherever the work occurs, but doing it on budget in Minnesota's harsh climate is a whole other matter. Long winters and road salting had fueled deterioration, making it possible the contractor would uncover even more corrosion in the field. Lead paint had to be removed, section-loss measurements taken, and the entire structure repainted. High-strength bolts and new steel plates had to be installed over tens of thousands of rivets, which had not always been installed according to the original plans. The team also had to replace the aging bridge deck and patch spalled piers to blend with the bridge's concrete color. After analyzing

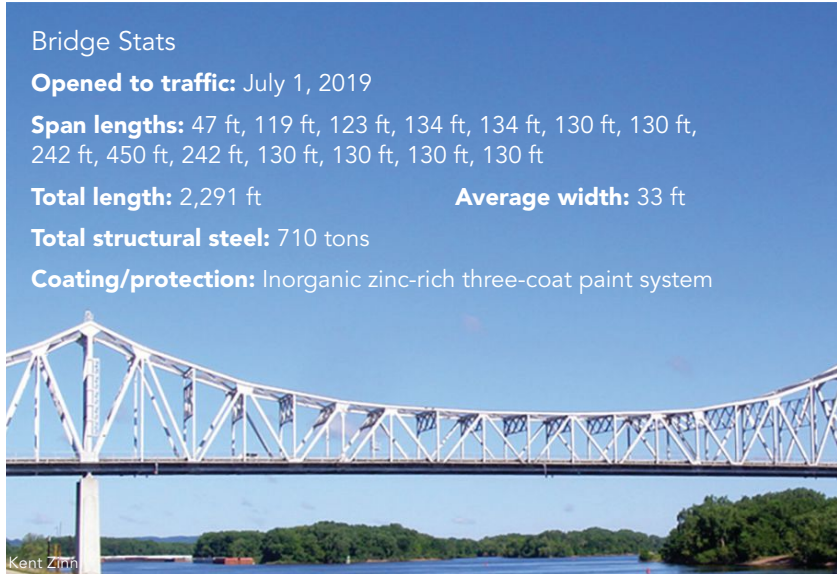

### Bridge Stats

**Opened to traffic:** July 1, 2019

**Span lengths:** 47 ft, 119 ft, 123 ft, 134 ft, 134 ft, 130 ft, 130 ft, 242 ft, 450 ft, 242 ft, 130 ft, 130 ft, 130 ft, 130 ft

**Total length:** 2,291 ft

**Average width:** 33 ft

**Total structural steel:** 710 tons

**Coating/protection:** Inorganic zinc-rich three-coat paint system



Keith Molnau



Nicholas Sovell



Kent Zinn

the structure's timber piles, it encountered another dilemma: The piles would not stand up to the impact of a modern barge collision and would have to be strengthened as well.

Every step of the way, Michael Baker's team worked with the project historian and MnDOT's Bridge Office and Cultural Resources Unit (CRU) to evaluate each engineering improvement for compliance with the National Historic Preservation Act of 1966 and Minnesota's State Historic Preservation Office. This called for extensive, detail-oriented work and intense coordination.

The CM/GC team began work on the Winona Bridge in 2014. It first generated complex 3D finite element models to analyze the fracture-critical components of the structure and formulate plans for strength and internal redundancy retrofits. These designs relied on steel plates and post-tensioning bars that strengthened the bridge and extended its service life by 50 years.

Owing to the age of the structure and the parameters for historic designation, the team faced numerous obstacles during the rehabilitation. It solved the issues posed by the bridge's timber piles by implementing a scour-protection system, which consisted of geobags and rip rap. Additionally, an innovative, underwater strut system was designed, essentially linking the original structure to the new parallel bridge. In doing this, the team ensured that both structures would share the impact of any barge collision, distributing the force and bolstering the older bridge's timber-pile foundations.

To rebuild the approach spans, the team installed six new, steel deck truss spans and constructed 15 prestressed concrete girder spans. For the main through-truss spans, 148 truss members were reinforced with steel plates and 76 with high-strength rods. From the original design, the team replaced nine concrete piers by using longer, prestressed girder approach spans, which were less expensive to fabricate and construct.

Ultimately, the CM/GC approach proved to be a massive success, providing expert oversight, comprehensive coordination, and state-of-the-art solutions. What's more, it delivered these innovative designs with great cost certainty prior to construction and no construction cost growth, opening the bridge to traffic six months ahead of schedule.

#### Owner

Minnesota Department of Transportation, Rochester, Minn.

#### General Contractor

Ames Construction, Burnsville, Minn.

#### Structural Engineer

Michael Baker International, Chicago

#### Steel Team

##### Fabricator and Detailer

LeJeune Steel Company, Minneapolis 

##### Erector

Danny's Construction Company, Shakopee, Minn. 



**NATIONAL AWARD** Reconstruction  
**BNSF Wind River Bridge, Skamania County, Wash.**

**WITH AN EXPECTED LIFESPAN OF A CENTURY**, the new, reconstructed BNSF Wind River Bridge serves as a critical connector on BNSF’s Fallbridge Subdivision, enabling the safe and reliable crossing of both freight and passenger traffic over the mouth of the Wind River in the Columbia River Gorge in Washington State.

HNTB provided design, permitting, and construction management services for the steel bridge’s reconstruction. The new bridge consists of a 260-ft-long single-track truss span with pre-cast double cell box beam approaches supported on concrete pier caps with drilled shaft and driven pile foundations. The project site is in a national scenic area between State Highway 14 and the Columbia River, which resulted in limited available site access for the contractor and the need for strict environmental compliance during construction.

Because the bridge carries a large amount of freight and passenger traffic, minimizing track closures remained a priority throughout the project. An accelerated bridge construction (ABC) technique, float-in/out, provided two distinct advantages to the project. First, it reduced the need for temporary work bridge piles, which were required to be installed and removed within a dedicated in-water work window. Secondly, it minimized impacts to railroad operations by limiting the time required to remove the existing span and install the new truss span on the existing bridge alignment.

Addressing the challenges associated with the float-in/out operation was one of the greatest challenges faced during the project, due to the number of associated variables. Because the truss span was erected in Portland, Ore., roughly 60 miles west of the project site, it was critical that the contractor’s plan to float the erected truss span down the Columbia River be fully vetted. To this end, BNSF and HNTB worked with the contractor to review their proposed maritime procedure and engineering and developed a plan

to coordinate water levels with the Bonneville Dam to control the pool elevations during the bridge change-out.

Because the bridge is located in the Columbia River Gorge National Scenic Area, it was critical that the aesthetics of the new structure not disturb the existing view for the public. To address this concern, BNSF and HNTB worked with the applicable regulatory agencies to review proposed span types and bridge colors. The new main span used a Warren-type truss with weathered steel to closely match the feel of the existing Pratt-style truss and its weathered patina. Concrete pier caps and approach spans were also stained with a charcoal color to better blend in with the existing landscape. Materials were carefully selected to fulfill the project’s specific aesthetic requirements while also ensuring the integrity of the new bridge’s 100-year lifespan.

In addition to meeting a variety of requirements, the bridge design also needed to be adaptable. The bridge can accommodate the heavy live loads of current freight and passenger trains, and it is also robust enough to meet demands imposed by enhanced future railroad loading.

**Owner**

BNSF Railway, Kansas City, Kan.

**General Contractor**

Hamilton Construction Company, Portland, Ore.

**Structural Engineer**

HNTB, St. Louis

**Steel Team**

**Fabricator**

Fought and Company, Inc., Tigard, Ore. 

**Detailer**

Graphics for Steel Structures, Hicksville, N.Y. 





Kyle Izatt

Jeff Jobe

### Bridge Stats

**Opened to traffic:** August 6, 2019

**Span length:** 260 ft (main span truss)

**Total length:** 363 ft, 4 in.

**Average width:** 23 ft

**Total structural steel:** 850 tons

**Coating/protection:** Weathering steel



Jeff Jobe

Charlie Woods

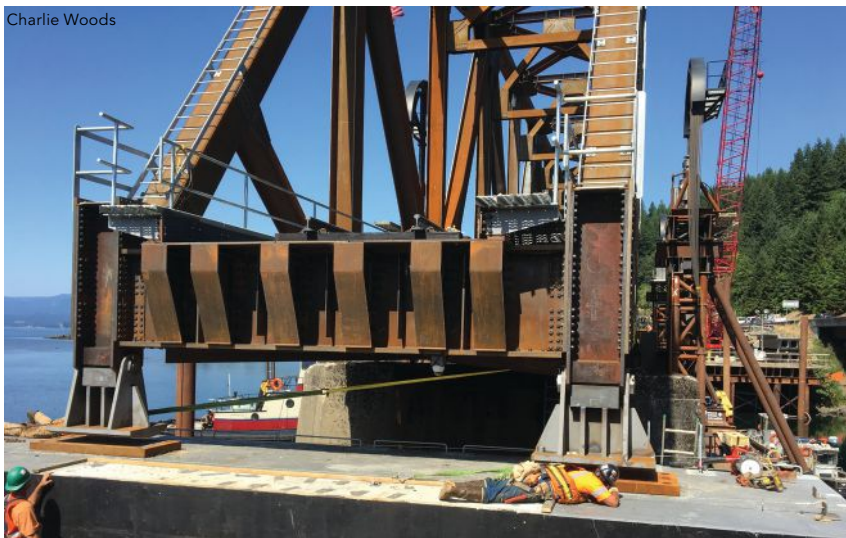

Kyle Izatt

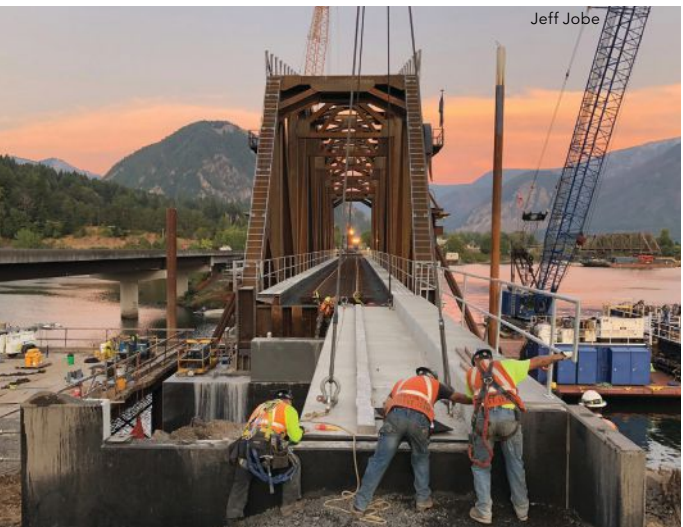

Jeff Jobe



## MERIT AWARD Reconstruction I-240 MemFix4, Memphis, Tenn.

**WHEN THE TENNESSEE DEPARTMENT OF TRANSPORTATION (TDOT)** was faced with the urgent need to replace or repair four deficient structures over I-240 in Memphis, subjecting roadway users to another long-term construction project simply wasn't an option. With traffic levels of approximately 180,000 vehicles per day, TDOT wanted this critical project completed quickly, with minimal impact to travelers.

The four bridges in the project, dubbed MemFix4, are two new Poplar Interchange bridges; a new Norfolk Southern Railroad (NSR) bridge; and rehabilitation of the concrete Park Avenue bridge. This \$54 million project was delivered under the CM/GC delivery method—the second-ever CM/GC transportation project in the state of Tennessee. Throughout the process, TDOT, Benesch (designer), and Kiewit (general contractor) worked together in the design phase to develop innovative ideas that addressed the numerous site challenges and all project needs while maintaining the ability to meet the project's aggressive schedule.

The WB and EB Poplar Avenue bridge replacements required use of multiple innovative prefabricated bridge elements. The constructed Poplar Ave. bridges consist of a 263-ft, two-span bridge for WB Poplar and a 222-ft, two-span bridge for EB Poplar. For the replacement of these structures, extensive modeling and structural analysis was required to address high seismic conditions. Several custom elements were developed to facilitate efficient installation and serve as a sustainable solution for years to come. These

included custom steel bearings and framing, over 13,000 linear ft of micropiles, new substructures constructed under traffic, and modular bridge superstructures—which addressed site challenges while completing the project in just 18 months.

The project team called upon accelerated bridge construction (ABC) methods to address site constraints and the necessity for minimal impacts to traffic. This led to the Poplar Avenue bridges being built off-site at a “bridge farm,” rolled to the site using self-propelled modular transporters (SMPTs), and then lifted into place using large crawler cranes. Once the bridges were constructed, Kiewit was able to complete the planned widening of I-240 to alleviate the lane drop that was required due to entrance ramps.

For the Norfolk Southern (NS) Rail Bridge, since the existing piers were founded on spread footings, it was not cost-efficient to upgrade the existing bridge's substructures to meet current seismic design standards. TDOT realized that the next project needed to replace the structures while minimizing impacts to the thousands of vehicular travelers through this interchange and the nearly 20 trains per day on the NS/I-240 overpass.

To replace this bridge, a temporary shoofly structure was constructed adjacent, just inches away from the existing bridge. It was comprised of temporary concrete piers supported by a foundation of over 6,000 linear ft of micropiles. Leaving train traffic largely uninterrupted during construction, the permanent steel superstruc-



Alfred Benesch & Company



Kiewit Infrastructure South Co.

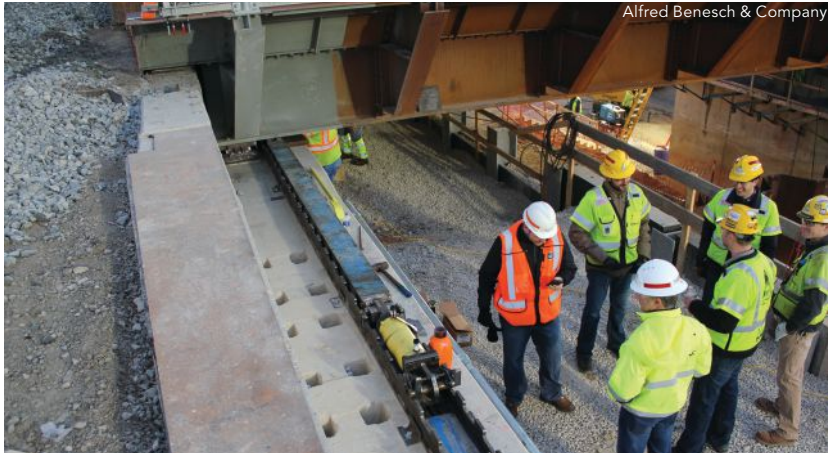

Alfred Benesch & Company

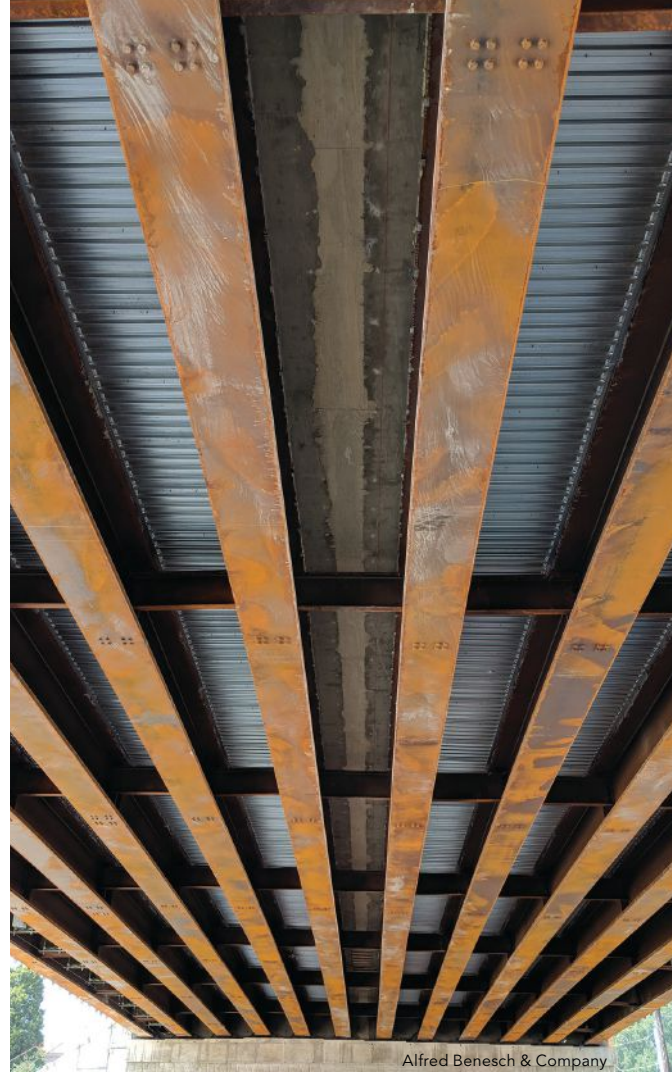

Alfred Benesch & Company

ture supporting a ballasted track was erected on the shoofly alignment and trains were switched onto this alignment. With trains traveling on the shoofly structure, the old bridge was demolished and the new substructures were built. The two new 1,100-ton superstructure sections were then laterally slid 35 ft into place, one track at a time, during two weekend Interstate closures.

The Memphis area resides in the influence zone of the New Madrid Fault, which in 1811 and 1812 produced four of the most powerful earthquakes east of the Rocky Mountains in recorded history. Significant effort was spent during the design phase to ensure that solutions could be constructable while still meeting the seismic demands. Designers focused on the impacts of time during the construction phase, especially when it came to key elements that would be built during weekend closures. Benesch used finite element modeling to precisely design elements such as the bearing anchors to minimize the materials and labor required while still meeting the design requirements.

*For more on the I-240 MemFix4 project, see "A Bridge Replacement in Four Parts" in the October 2019 issue, available at [www.modernsteel.com](http://www.modernsteel.com).*

**Owner**

Tennessee Department of Transportation, Nashville, Tenn.

**General Contractor**

Kiewit Infrastructure Co., Brentwood, Tenn.

**Structural Engineer**

Benesch, Nashville, Tenn.

**Steel Fabricator and Detailer**

W&W/AFCO Steel, Little Rock, Ark. 

**Bridge Stats**

**Opened to traffic:** June 30, 2019

**Span lengths:** WB Poplar Ave.: 150.5 ft, 113.08 ft  
 EB Poplar Ave.: 88.17 ft, 134.17 ft  
 Norfolk Southern Railroad Bridge: 50.83 ft, 73.5 ft, 73.5 ft, 87.5 ft, 50.83 ft

**Total lengths:** WB Poplar Ave.: 222 ft  
 EB Poplar Ave.: 263 ft  
 Norfolk Southern Railroad Bridge: 338 ft

**Average width:** WB Poplar Ave.: 65 ft  
 EB Poplar Ave.: 72 ft  
 Norfolk Southern Railroad Bridge: 36 ft

**Total structural steel:** WB Poplar Ave.: 614 tons  
 EB Poplar Ave.: 287 tons  
 Norfolk Southern Railroad Bridge: 948 tons  
 All bridges: 1,849 tons

**Cost:** \$28.4 million (combined structures cost)

**Coating/protection:** Weathering steel (WB and EB Poplar Ave.), weathering and painted steel (Norfolk Southern Railroad Bridge)

## SPECIAL AWARD FOR RESILIENCE Liberty Bridge, Pittsburgh

**THE LIBERTY BRIDGE** has been a landmark structure and Pittsburgh icon since it opened in 1928.

It created the modern suburbs, quadrupled property values south of Pittsburgh, and opened with a parade five miles long. However, by 2014 the bridge, which carried 55,000 vehicles per day, was in poor condition. It could no longer carry trucks and had become a poster-child for America's infrastructure crisis. *60 Minutes*, profiling America's neglected infrastructure, highlighted the bridge. Referring to Liberty Bridge and others like it, Ray LaHood, United States Secretary of Transportation, stated plainly: "Our infrastructure is on life support right now."

PennDOT and HDR responded with a rehabilitation project that preserved the structure while meeting current engineering and accessibility standards. The main goals for PennDOT in this rehabilitation were to remove the load posting on the bridge, ensure the bridge was accessible and safe per current codes, and secure 40 more years of use from this historic truss.

By using the first steel Exodermic grid deck in Pennsylvania, impacts to the bridge's thousands of daily users were reduced while a deck the size of three football fields was replaced. Sections of this deck were prefabricated in panels that could be installed over weekend closures and connected together with high-strength concrete. A custom rapid-set concrete mix was created for this project, which allowed traffic to use new deck sections just a few hours after the concrete was placed. The new deck combines the strength of steel T-beams with reinforced concrete on top, making it strong, light, and easy to overlay in the future.

Innovations for the deck were planned, but the greatest innovations are often unplanned. When an accidental construction fire warped and buckled a main truss compression chord, forcing an immediate bridge closure, the team raced to develop a solution to fix the bridge and reopen this critical urban link. The bridge was in a perilous state; it was not known how badly the structure might be overstressed or if collapse was imminent. To assess and fix the bridge, teams of engineers worked many days and nights until the bridge reopened.



Nicholas Burdette, PE

### Bridge Stats

**Opened to traffic:** August 15, 2018

**Span lengths:** 41.5 ft, 65.75 ft, 45.5 ft, 247.25 ft, 278.75 ft, 168.5 ft, 152 ft, 470.5 ft, 152 ft, 166.25 ft, 152 ft, 274.25 ft, 242 ft, 148.5 ft, 43.25 ft, 14.5 ft

**Total length:** 2,663 ft

**Average width:** 67 ft

**Total structural steel:** 2,750 tons

**Cost:** \$81.95 million

**Coating/protection:** Three-coat organic zinc-rich paint

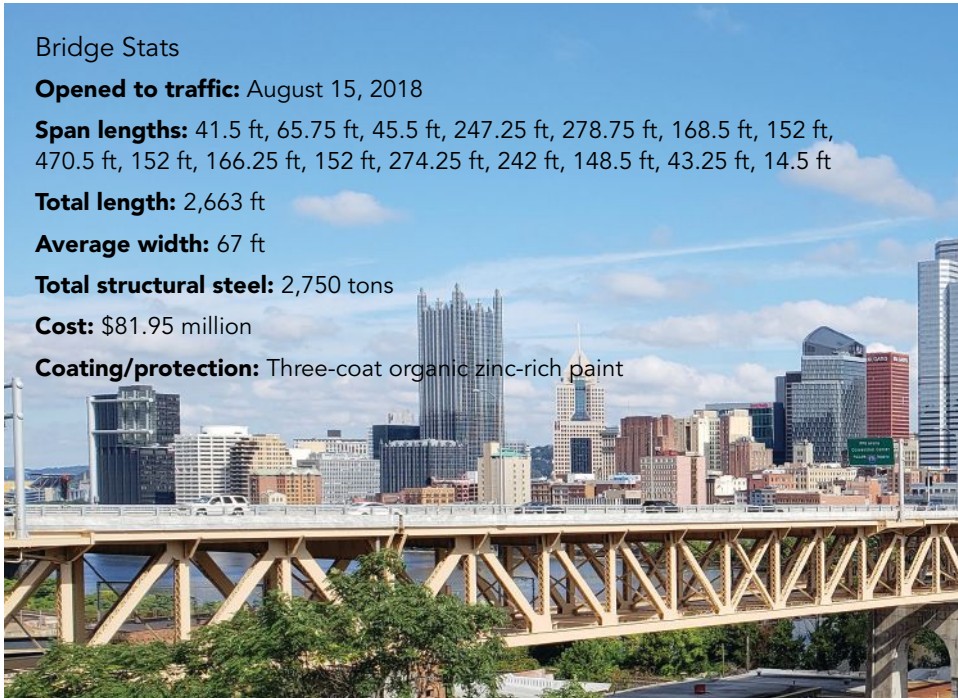

Nicholas Burdette, PE

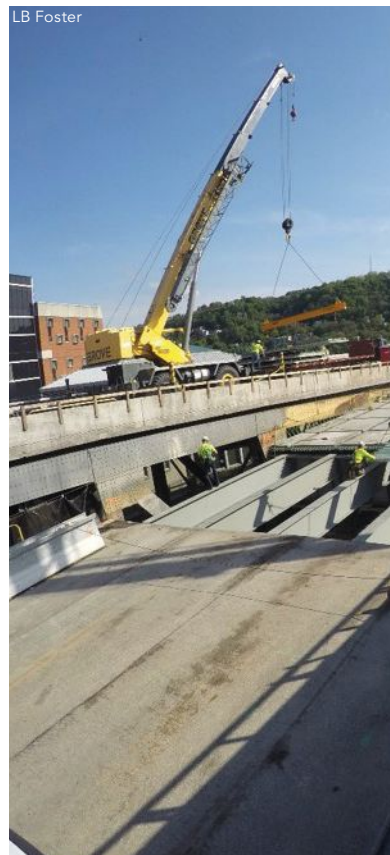

LB Foster



Christine Shiring



Christine Shiring



Christine Shiring

A 3D analysis model was built to assess the crippled structure, including both trusses, every bracing member, and the partially removed deck. Using hand-drafted documents from the 1920s, hundreds of unique truss and bracing members were modeled. The day following the closure, the new model showed that most of the 1,000 tons carried by the damaged chord shed into the undamaged sister truss through wind bracing. The 3D steel truss and bracing system proved redundant. No member was overstressed from the bridge dead load. This finding gave authorities confidence in opening the river below the structure to commercial traffic, preventing further economic impact to river commerce.

Without a historical precedent to go by, engineers also developed a steel jacking frame concept that same day to fix the buckled member. This frame would attach to the member and 2,000 tons of force could be applied with huge jacks to straighten the buckled steel. This concept was adopted by the contractor and further developed by their design team. Twenty-four days later, the member was repaired through a combination of jacking and heat straightening, and traffic was restored on the bridge—a momentous day for Pittsburgh commuters.

By performing hundreds of unique steel repairs on beams, truss members, and connection plates, and by replacing the bridge deck and supporting stringers, trucks can now use the structure. Replacing the bridge deck was crucial in order to preserve the bridge and allow it to function safely for another 40 years. The new deck, with modern bridge joints and drainage, provides a robust and waterproof “roof” to keep the steel below dry and corrosion-free. In addition, replacing the old stringers along with the deck eliminated many poor details that are prone to cracking over time. Holes, cuts, and welds in these beams did not meet current fatigue requirements. As years of exposure to traffic mounted, these details were a long-term liability requiring detailed documentation for each inspection. By replacing all stringers with new, properly fabricated beams, this liability was eliminated. ■

**Owner**

PennDOT, Engineering District 11, Bridgeville, Pa.

**General Contractor**

Fay, an i+iconUSA Company, Pittsburgh

**Structural Engineer**

HDR, Pittsburgh

**Steel Fabricators**

Hall Industries, Inc., Ellwood City, Pa.

L.B. Foster Company, Pittsburgh



# Essential and Available

BY GEOFF WEISENBERGER

While the COVID-19 pandemic has taken a massive toll in terms of lives, jobs, and industries, the domestic structural steel industry remains vibrant.



**Geoff Weisenberger**  
([weisenberger@aisc.org](mailto:weisenberger@aisc.org)) is senior editor of *Modern Steel Construction*.

**WHILE THE ECONOMY** began the year strong, activity in many parts of the country has all but ground to a halt. And while much of the construction industry has been designated as an essential business, there's a lot of uncertainty about the supply chain.

Much of this uncertainty is due to the generic nature of the word "steel." When people hear that mills supplying the automotive industry are shutting down, they assume that also applies to structural steel mills. But that's not the case, and America's structural steel industry remains a success story.

"We are unaware of any current shortages in steel supply, and all of Nucor's steel mills have continued to operate during the COVID-19 pandemic," said Katherine Miller, director of public affairs and corporate communications with AISC member producer Nucor Corporation. "Since the beginning of the crisis, our steelmaking facilities were determined to be 'essential' businesses in every state where we operate that has been subject to stay-at-home orders. As such, we have continued to produce steel for critical projects and to meet our customers' needs for our products without interruption."

Because steel mills were designated as essential businesses, production continued unabated. This also extends to hollow structural steel (HSS) production.

"From the beginning of the pandemic, Atlas was deemed an essential business since the steel industry was deemed critical infrastructure," explained Brad Fletcher, a senior sales engineer with Atlas Tube, an AISC member HSS producer. "As such, all of our mills have been up and running as normal to meet our customers' needs. While orders have fallen here and there, by how much varies by region and is due to mandated construction shutdowns in certain areas. We've cut back hours here and there based on demand, but we've had no layoffs—and we aren't planning any."

With operations remaining normal, so have lead times remained short, continued Fletcher. "While there has been some movement with lead times, this is seasonal and normal," he said. "Lead times have not fluctuated due to the pandemic, and we've had no supply interruptions. We have a strong relationship with our coil producers, and there have been zero issues with our coil supply."

Another bright spot, noted Fletcher, is that not only are current projects staying on target, but design work for upcoming projects appears to be continuing as well. "In talking with designers, they have stayed pretty busy through this, with very few reporting projects being canceled or put on hold," he explained. "January and February were very busy months and I don't think we will get back to those levels right away, but we expect things to be back to some positive level in the next six to 12 months."

Because around 70% of structural steel is purchased from service centers rather than directly from steel mills and HSS producers, they can be a particularly good barometer when it comes to availability. Gary Stein, CEO of Triple-S Steel, an AISC member service center company with a network of approximately 30 locations, was quick to squelch any rumors of decreased material availability. "There are no steel shortages—absolutely, positively not," he stressed. "I've seen headlines talking about steel mill shutdowns, but that's not structural steel. Structural mills are

all running just fine. The only shutdowns I've heard of are due to scheduled maintenance. Most structural steel flows through distribution centers like ours, and I and my competitors all have plenty of inventory."

If there's any variation in demand, Stein noted, it's mostly due to localized construction climates. "In terms of demand, most of our customers haven't really shut down—maybe a bit at first but only briefly," he said. "It really depends on the region, with New York and New Jersey being the most dramatically affected. But that's based on job-site closures, not availability."

And even in areas where construction is on hold, Stein noted that fabrication has continued to stay generally steady as well. A unique problem in places like New York is that some fabricators haven't been able to ship finished product to job sites—which creates an issue for those with limited storage area. "So we've let them ship finished steel back to us in those areas, and we've been able to hold their product on trailers until their job sites open back up," he said.

Structural mills shut regularly for scheduled maintenance, and any pandemic-related shutdowns have been brief.

"In April, we conducted a maintenance outage at the Midlothian mill that had been planned since late 2019," said Adam Parr, director of communications and public affairs with Gerda Long Steel North America. "In late March, most operations at our Cartersville mill were temporarily suspended due to an increased number of COVID-19 cases in the area surrounding the mill. Normal operations resumed on March 31. We have not announced any lay-offs at our structural steel mills, lead times have remained consistent, and we have not seen an extension of expected lead times at any of our structural mills."

The pandemic did affect the maintenance schedule of one producer—though not in a bad way. "SSAB Americas' steel mill in Montpelier, Iowa, which produces steel plate primarily for bridge projects, was scheduled for a planned biannual maintenance outage in October," said Ivonne Furneaux, director of communications and community relations with AISC member producer SSAB. "Due to the current situation of the COVID-19 pandemic, we are adjusting the outage schedule to an earlier start date. The outage is now scheduled to begin on June 22 and is expected to last approximately four weeks."

However, outages like this are not expected to impact steel plate's overall availability or pricing, the latter of which has declined for all of this year.

Of course, staying operational also means staying safe, noted Miller. "The health and safety of our teammates is our number one cultural value at Nucor, and we have implemented a number of safety measures as we operate during this pandemic," she said. "These include social distancing, face coverings, staggered schedules, enhanced cleaning procedures for work areas, and using remote work wherever possible."

"Our primary concerns at this time remain the health and safety of our employees as well as maintaining our quality prod-

uct and service commitments to our customers," echoed Furneaux. "At this time, production continues, our supply chain is intact, and we do not anticipate disruption to our service levels. However, we will continue to monitor the situation and will take appropriate measures as warranted."

"Our plants are running routinely, though with precautionary measures, and sales and office staff have been working remotely," said Stein. "But we're still getting our work done. There's plenty of steel in the supply chain every day, pandemic or not." ■



## Behind schedule? JGM gets you back on track.

**Partner with JGM – We're there when you need help the most.**

When a large DOT bridge project needed extra horsepower, they chose JGM to hit their aggressive schedule milestones. JGM quickly completed 30 overlength girders including complete joint penetration web to flange welds each weighing 32,000 pounds. Order restored and timelines met with JGM.

### Why JGM?

- D1.5 fabrication able to meet the demands of any state DOT
- AISC Advanced Bridge and Fracture Critical endorsements
- Heavy lifting and hauling capabilities to ensure your logistics stay on track
- Close proximity to the Northeast Corridor
- Submerged arc welding equipment for efficiency gains
- In-house CWI's with non-destructive testing certifications

**When you need it yesterday, JGM is ALL IN.**



610-873-0081 | [solutions@jgmusa.com](mailto:solutions@jgmusa.com)



[JGMUSA.COM](http://JGMUSA.COM)

# news & events

## COMMITTEES

### AISC Creates New Committee Application Page

Interested in joining an AISC Technical Committee? AISC has created new Committee Application page ([aisc.org/aisc-membership/application](https://aisc.org/aisc-membership/application)) where you can fill out an application to join any of them:

- Committee on Specifications
- COS Task Committees
- Committee on Certification Standards
- Committee on the Code of Standard of Practice
- Committee on Manuals
- Committee on Research and Innovation
- Committee on Structural Stainless Steel
- Connection Prequalification Review Panel
- Partners in Education

- Safety Committee
- Student Steel Bridge Competition Rules Committee
- Task Group on Industrial Buildings/ Nonbuilding Structures
- National Steel Bridge Alliance Technical Committee
- AASHTO/NSBA Steel Bridge Collaboration Main Committee and Task Groups

Interested parties can visit this page, where they will be instructed to submit the completed application along with their resume to Rachel Jordan ([jordan@aisc.org](mailto:jordan@aisc.org)), who will forward the application to the appropriate staff member and committee leadership for consideration.

## GALVANIZING

### AGA Announces 2020 Excellence in Hot-Dip Galvanizing Awards

The American Galvanizers Association (AGA) has announced the winners of its 2020 Excellence in Hot-Dip Galvanizing Awards. More than 115 projects were submitted, representing a variety of applications of hot-dip galvanizing. All of the projects were judged online by a panel of architects and engineers.

One of the winners is the Living Bridge project (pictured), an interdisciplinary infrastructure research project that converted the Memorial Bridge into a demonstration “smart bridge.” The bridge, which links Portsmouth, N.H., to Kittery, Maine, over the Piscataqua River, has been outfitted with data sensors that have transformed it into a self-diagnosing, self-reporting smart bridge that captures a range of information from the health of the span to the environ-

ment around it. (It’s also right downriver from one of this year’s AISC Prize Bridge Award winners; turn to page 23 to see all of the winners and figure out the neighboring bridge.) And to see all of the Excellence in Hot-Dip Galvanizing Awards winners, visit [tinyurl.com/galvit2020](https://tinyurl.com/galvit2020).



## PUBLICATIONS

### Stainless Steel Code Available for Public Review

The new AISC *Code of Standard Practice for Structural Stainless Steel Buildings* will be available for public review from July 8 until August 14. This new standard will be available for download on the AISC website at [aisc.org/publicreview](https://aisc.org/publicreview) along with the review form during this time.

Copies are also available (for a \$35 nominal charge) by calling 312.670.5411. Please submit comments using the form provided online to Cynthia J. Duncan, AISC’s director of engineering ([duncan@aisc.org](mailto:duncan@aisc.org)), by August 14, 2020, for consideration.

## People and Companies

- The **Steel Erectors Association of America (SEAA)** recently announced the recipients of its 2020 **Safety Excellence Award** and **Craft Training Recognition Award**. For both awards, World Class was issued to the highest achieving companies and Premier was the second level of recognition, followed by Gold. AISC member companies **Derr & Gruenewald Construction, LPR Construction Company, Peterson Beckner Industries, Inc., Empire Steel, Inc., Flawless Steel Welding, LLC, Lexicon, Inc., United Steel, Inc., Black Cat, LLC, High Plains Steel Services, LLC, and L.R. Willson & Sons, Inc.**, were all Safety Excellence Award Winners. AISC member companies **Empire Steel, Inc., High Plains Steel Services, LLC, S&R Enterprises, LLC, Flawless Steel Welding, LLC, and Deem Structural Services, LLC**, were all Craft Training Recognition Award winners. For a complete list of winners and more information on both award programs, visit [www.seaa.net](https://www.seaa.net).
- Full-service engineering firm **DeSimone Consulting Engineers** has announced an alignment with **Henderson Rogers Structural Engineers**, a Texas-based structural engineering firm specializing in aviation, education, commercial, sports, and healthcare facilities.
- AISC member fabricator **Tampa Tank, Inc.–Florida Structural Steel (TTI–FSS)** has appointed **Corey Yraguen** as its new company president, reporting to TTI–FSS CEO **David Hale**. Yraguen joins the company after a long career in executive leadership, most recently as executive vice president of **Vigor Industrial** (also an AISC member fabricator) in Portland, Ore.



Welcome to Safety Matters, which highlights various safety-related items. This month's topics include portable fire extinguishers, powered industrial trucks, and heat stress.

## Portable Fire Extinguishers

OSHA 1010.157 provides inspection frequencies for portable fire extinguishers. NFPA (National Fire Protection Association) advises the following:

- Only use a portable fire extinguisher when the fire is confined to a small area, such as a wastebasket, and is not growing; everyone has exited the building; the fire department has been called or is being called; and the room is not filled with smoke.
- Install fire extinguishers close to an exit and keep your back to a clear exit when you use the device so you can make an easy escape if the fire cannot be controlled. If the room fills with smoke, leave immediately.
- Know when to go. Fire extinguishers are one element of a fire response plan, but the primary element is safe escape. Every household should have a home fire escape plan and working smoke alarms.

Small, fully contained fires are usually safe to fight with a portable fire extinguisher. Large, uncontained fires are not safe to fight. Any fire involving highly flammable or hazardous materials isn't safe to fight. Escape immediately if the fire is spreading or putting off a lot of heat and smoke.

## Powered Industrial Trucks

Commonly called forklifts or lift trucks, powered industrial trucks are used in many industries to move materials. OSHA has an informative page on powered industrial trucks at [osha.gov/sltc/powerindustrialtrucks](https://www.osha.gov/sltc/powerindustrialtrucks) that includes rules, hazards, solutions, and training requirements. If your facility or site uses powered industrial trucks, now is a great time to review safety program elements related to operating this type of machinery.

## Heat Stress

Exposure to extreme heat can result in occupational illnesses and injuries including heat stroke, heat exhaustion, heat cramps, or heat rashes. The National Institute for Occupational Safety and Health (NIOSH) offers several documents to educate and protect against heat stress at [cdc.gov/niosh/topics/heatstress](https://www.cdc.gov/niosh/topics/heatstress).

Staying properly hydrated can go a long way in combatting heat stress. Here are some tips on worker hydration:

- Water should be potable, < 59 °F and made accessible near the work area.
- Estimate how much water will be needed and decide who will obtain and check on water supplies.
- Individual, not communal, drinking cups should be provided.
- Workers should drink an appropriate amount to stay hydrated and be encouraged to hydrate themselves.
- If in the heat less than two hours and involved in moderate work activities, drink one cup (8 oz.) of water every 15 to 20 minutes.
- During prolonged sweating lasting several hours, drink sports drinks containing balanced electrolytes.

- Avoid alcohol and drinks with high amounts of caffeine or sugar.
- Generally, fluid intake should not exceed six cups per hour.

Additional heat stress information and tips can be found at [cdc.gov/disasters/extremeheat](https://www.cdc.gov/disasters/extremeheat) and [osha.gov/sltc/heatillness/heat\\_index](https://www.osha.gov/sltc/heatillness/heat_index).

## Dates to Note

- National Fireworks Safety Month. Month of July, [www.nsc.org](https://www.nsc.org)
- UV Safety Month. Month of July, [www.va.gov](https://www.va.gov)
- National Heat Stroke Awareness Day. July 3, [www.nhtsa.gov](https://www.nhtsa.gov)

We are always on the lookout for ideas for safety-related articles and webinars that are of interest to AISC member companies. If you have safety-related questions or suggestions, we would love to hear them. Contact us at [schlaflly@aisc.org](mailto:schlaflly@aisc.org). And visit AISC's Safety page at [aisc.org/safety](https://www.aisc.org/safety) for various safety resources. In addition, AISC has established its own resource page with information on employment, contract, and safety issues regarding COVID-19. It's at [aisc.org/covid19](https://www.aisc.org/covid19).



## ENGINEERING JOURNAL

### Third Quarter 2020 EJ Now Available

The third quarter 2020 issue of AISC's *Engineering Journal* is now available. (You can access this issue as well as past issues at [aisc.org/ej](http://aisc.org/ej).) Below is a summary of this issue, which includes articles on designing connections subjected to fire, how eccentricity influences shear lag effects in welded connections, multi-tiered special concentrically braced frames, and connector strength in built-up compression members.

#### Design of Simple Steel Connections under Fire Temperatures

*Elie G. Hantouche, Karim K. Al Khatib, and Hagop V. Jabotian*

A methodology is developed for designing simple steel connections (single-plate shear connection and double angle) subjected to fire. The proposed methodology is based on quantifying the strength and stiffness of steel framed simple connections at elevated temperatures. To achieve this, first, a stiffness-based model that characterizes the rotational stiffness of simple steel connections when subjected to fire temperatures is developed. The model is capable of predicting the behavior of two widely used simple steel connections (single-plate shear connection and double angle) when subjected to fire temperatures. It incorporates the connection rotation of key component elements and the nonlinear behavior of both bolts and base materials at elevated temperatures. The model is validated against experimental results available in the literature under steady-state temperature analysis. The model covers all possible limit states and governing failure modes under different loading and temperature conditions. It can be considered a practical tool for designing simple steel connections for professional structural fire engineers in the United States.

#### An Experimental Study of the Influence of Eccentricity on Shear Lag Effects in Welded Connections

*Kenneth L. Orloff, James A. Swanson, Gian Andrea Rassati, and Thomas M. Burns*

In the 2010 AISC *Specification*, the shear lag factor for longitudinally welded

tension members was applicable only to plate-type members having equal length welds on each side with a minimum length equal to the distance between the welds (AISC, 2010). Fortney and Thornton (2012) used experimental data from three previous research programs consisting of 175 various tension members to develop a generalized shear lag model that addresses the aforementioned limitations. The members comprising this dataset consisted of 158 flat plates with equal weld lengths, 4 single angles with unequal but balanced weld lengths, and 13 other members having equal weld lengths. The shear lag factor presented in the 2016 AISC *Specification* Table D3.1, Case 4 (AISC, 2016) is a product of Fortney and Thornton's work and applies to longitudinally welded plates, angles, channels, tees, and W-shapes having equal or unequal lengths and no length-to-width limitation. This paper presents an experimental study on the shear lag effects in longitudinally welded tension members under both in-plane and out-of-plane eccentricity through the testing of eight  $3 \times \frac{1}{2}$  plate sections and twelve  $3 \times 3 \times \frac{1}{2}$  single-angle sections having both equal and unequal longitudinal weld lengths. Experimental shear lag factors were determined for each of the 20 tested specimens and compared to three theoretical values: (1) the shear lag factor in the 2010 AISC *Specification* (AISC, 2010), (2) the shear lag factor based on a bi-planar model (Fortney and Thornton, 2012), and (3) the shear lag factor from Case 4 in the 2016 AISC *Specification*. The findings of this experimental study confirm that shear lag factor given by Case 4 in the 2016 AISC *Specification* provides the best prediction of shear lag factors in welded connections subject to both in-plane and out-of-plane eccentricity.

#### Evaluation of AISC Seismic Design Methods for Steel Multi-Tiered Special Concentrically Braced Frames

*Pablo A. Cano and Ali Imanpour*

Steel multi-tiered concentrically braced frames (MT-CBFs) are commonly used in North America as a lateral load resisting system of tall single-story build-

ings. Past studies show that MT-CBF columns designed in accordance with the 2010 AISC *Seismic Provisions* are prone to buckling due to a high axial compression force combined with in-plane bending moments caused by the nonuniform distribution of inelastic brace deformations along the frame height. Special design provisions have been introduced in the 2016 AISC *Seismic Provisions* to address flexural demands imposed on MT-CBF columns and prevent column instability. In this paper, the seismic design methods for multi-tiered special concentrically braced frames are evaluated using the nonlinear finite element analysis method. A two-tiered special concentrically braced frame was then created, and nonlinear static and dynamic analyses were performed to evaluate the seismic performance of both frames. Analysis results confirmed that the inelastic deformations in the frame designed using the 2010 requirements are not uniformly distributed but rather concentrated in one of the tiers and cause column instability under large story drifts, whereas, the 2016 design method significantly improves the distribution of inelastic deformation along the height of the frame and prevents column instability.

#### Technical Note: Notes on Determining Required Connector Strength in Built-up Compression Members

*Louis F. Geschwindner*

Connections between individual components of a built-up compression member carry no force when the member is perfectly straight in the unbuckled configuration under load. Yet AISC *Specification* Section E6.1 (AISC, 2016) requires that the end connection of these built-up members be welded or connected by means of pretensioned bolts with Class A or B faying surfaces. Nothing is provided in the AISC *Specification* or *Commentary* to help the designer determine the required strength of these connectors. This paper suggests one way of determining these required strengths and provides two LRFD examples. Other assumptions may be used to derive different, but equally acceptable, required strengths.

# marketplace & employment



## SMITH-EMERY

Inspection • Testing • Metallurgy

Assuring Structure & Life Safety Since 1904

### Non-Destructive Testing

- PAUT
- Visual (CWI, CWB, CSWIP)
- MT
- UT

### Owner QA

- Fabrication Oversight
- Specification Review
- Field Inspections
- WPS Reviews

### Metallurgical Laboratory

- Environmental Laboratory
- Firestop Inspection

### Supplier Audits

- IAS
- IAPMO
- City of Los Angeles
- Clark County, NV

### Contractor QC

- Fabrication Shop NDT, CWI
- Vendor Audits
- QMS Development
- WPS and PQR Testing

### Curtain Wall Performance Testing

- Concrete Testing
- Chemical Laboratory

1.833.405.0536  
 steel@smithemery.com  
 www.smithemery.com



## Structural Engineers

Are you looking for a new and exciting opportunity?

We are a niche recruiter that specializes in matching great structural engineers with unique opportunities that will help you utilize your talents and achieve your goals.

- We are structural engineers by background and enjoy helping other structural engineers find their "Dream Jobs."
- We have over 30 years of experience working with structural engineers.
- We will save you time in your job search and provide additional information and help during the process of finding a new job.
- For Current Openings, please visit our website and select Hot Jobs.
- Please call or email Brian Quinn, PE:  
 616.546.9420 | [Brian.Quinn@FindYourEngineer.com](mailto:Brian.Quinn@FindYourEngineer.com)  
 so we can learn more about your goals and interests.  
*All inquiries are kept confidential.*

SE Impact by SE Solutions, LLC | [www.FindYourEngineer.com](http://www.FindYourEngineer.com)



## Contract Auditor

Quality Management Company, LLC (QMC) is seeking qualified independent contract auditors to conduct site audits for the American Institute of Steel Construction (AISC) Certified Fabricators and Certified Erector Programs.

This contract requires travel throughout North America and limited International travel. This is not a regionally based contract and a minimum travel of 75% should be expected.

Contract auditors must have knowledge of quality management systems, audit principles and techniques. Knowledge of the structural steel construction industry quality management systems is preferred but not required as is certifications for CWI, COA or NDT. Prior or current auditing experience or auditing certifications are preferred but not required. Interested contractors should submit a statement of interest and resume to [contractor@qmconline.org](mailto:contractor@qmconline.org).

## LATE MODEL STRUCTURAL STEEL FABRICATING EQUIPMENT

**Peddinghaus AFCPS 823-B CNC Anglemaster Angle Punch & Shear, 8" x 8" x 3/4", 400 T Shear, 130 T Punch, PC Based, 2017 Upgrade, #30583**

**Peddinghaus AFCPS 833A Revolution CNC Anglemaster Angle Line, 8" x 8" x 1", Fagor 8055 CNC, Loader, Conveyor, 2011, #29959**

**Ficep 1001-DFB-R CNC Non-Contact Measuring CNC Drill & Saw Line, 44" x 17.75, 6-ATC, In & Out Conveyor 2010, #30692**

**Ficep Excalibur 12 CNC Single Spindle Traveling Column Drill, 6-ATC, 47" x 47" Max Beam, 25 HP, 80' Conveyor, PC Based CNC, 2013, #30726**

**Peddinghaus FPB-1800/3 Punch/Plasma Plate Fabricator, 70 T Punch, 72" Max. Plate Width, HPR260XD, Siemens CNC, 2013, #30727**

**Peddinghaus AFPS 623M 6" x 6" x 1/2" CNC Anglemaster Punch & Shear Line, PC Touch Screen CNC, 250 Ton Shear, 2002, #30723**



Visit our website or call to inquire about our Featured Machines  
[claire@prestigeequipment.com](mailto:claire@prestigeequipment.com)

[www.PrestigeEquipment.com](http://www.PrestigeEquipment.com) | (631) 249-5566

Search employment ads online at [www.modernsteel.com](http://www.modernsteel.com). To advertise, contact M.J. Mrvica Associates, Inc.: 856.768.9360 | [mjmrvica@mrvica.com](mailto:mjmrvica@mrvica.com)

## advertiser index

AISC	8   13   15   67	Peddinghaus Corporation	2
Bull Moose Industries	back cover	QuickFrames USA	22
Cast Connex Corporation	12	SDS/2	7
Chicago Metal Rolled Products	insert	SidePlate	27
High Steel Structures	3	Smith-Emery San Francisco	11
JGM	61	St. Louis Screw & Bolt	22
MDX Software	14	Trimble	5

# structurally sound



## FORGING AHEAD

**THE JUDGES HAVE SPOKEN**, and AISC's Forge Prize has a 2020 champion!

An innovative cantilevered pedestrian bridge and elevated park concept by Rosannah Harding and Matthew Ostrow of HardingOstrow took top honors at a judging event streamed live on YouTube (you can view it at [youtube.com/user/AISCSteelTV](https://www.youtube.com/user/AISCSteelTV)). Established in 2018, AISC's Forge Prize recognizes visionary emerging architects for designs that embrace steel as a primary structural component and capitalize on steel's ability to increase a project's speed. The three finalists each win \$10,000, and the winner takes home an additional \$10,000 (visit [www.theforgeprize.com](http://www.theforgeprize.com) for more information on the award program).

Called Footbridge, this year's winning design is intended for a site in Manhattan that connects to the existing High Line, marrying the raw look of weathering steel with the shine of hammered stainless steel planters that hold trees and other vegetation. Stormwater runoff would drip into bespoke weathering steel bollards on the plaza below, creating an immersive visual and auditory effect in inclement weather.

Harding and Ostrow worked with AISC member fabricator STS Steel, Inc., to refine their concept, which resulted in a cantilevered design that minimizes the structure's footprint.

For more on Footbridge and the rest of this year's finalists, be sure to check out the August issue. ■

Steel reduces waste and features a material recovery rate greater than 98%! Structural steel features an incredibly sustainable manufacturing process. Consider these facts:



The structural steel making process boasts a 95% water recycling rate with no external discharges, resulting in a **net consumption of only 70 gallons per ton.**



**Steel is the most recycled material in the world.** Domestic mills recycle more than 70 million tons of scrap each year and structural steel has a 93% recycled content!



**Steel production** productivity levels are up by a factor of 24 and labor hours have been reduced from 12 to just 0.5 per ton.



**Steel's carbon footprint** is down 37%, energy use has decreased 32%, and greenhouse gas emissions have dropped by 45%.

Steel is the most resilient material, designed to last, whether it's exposed to fire, blast, or the ravages of time. And when a steel building reaches the end of its life, the steel is recycled and retains all of its fantastic physical characteristics. Today's beams and columns are nearly 40% stronger and offer greater constructability benefits!

The American Institute of Steel Construction provides environmental product declarations (EPDs) for fabricated hot-rolled structural sections, fabricated steel plate and fabricated hollow structural sections. These EPDs cover the product life cycle from cradle to fabricator gate and are available at [aisc.org/epd](http://aisc.org/epd).

# Are you Earth-friendly?

[aisc.org/earthfriendly](http://aisc.org/earthfriendly)



**Smarter. Stronger. Steel.**

American Institute of Steel Construction  
312.670.2400 | [www.aisc.org](http://www.aisc.org)

# HOLLOW STRUCTURAL STEEL TUBE FROM BULL MOOSE

**BUILD A  
LANDMARK.**



For projects that will stand the test of time, start with Bull Moose HSS tube.

Our direct-form manufacturing process enables us to use the highest grade HSLA steel...and form it directly into a tube.

With sizes ranging from 1.5" square to 18"x6", and wall thicknesses from 1/8" through 5/8", Bull Moose features one of the largest size ranges of HSS products in the industry.

*For strength, versatility and reliability, build with Bull Moose.*

## BULL MOOSE ADVANTAGES

- Strength ranges of 46 KSI to 110 KSI
- Tighter tolerances, sharper edges, and straighter tubes
- Widest variety of custom sizes/lengths, including metric
- In-line NDT weld testing available on all tube
- Readily available weathering grade steel
- Fast delivery with 8 domestic sites



**BULL MOOSE**  
For exceptional strength.

1819 Clarkson Rd.  
Chesterfield, MO 63017

**800.325.4467** | **BULLMOOSETUBE.COM**