

Modern Steel Construction

August 2021



PERFORMANCE SOLUTIONS LLC

FAST TRACK FABRICATION

MIKE COOKE
Shop Foreman

RICHARD DARNELL
President

BRYAN FRAMBACH
Project Manager

"The process I like the best is milling. It's been phenomenal on jobs where we've had to mill the columns for through plates. We drill and saw a lot more now than we ever have, but the milling is what sets the Peddi XDM-630 apart from other beam drill lines in the industry."

-RICHARD DARNELL



THE
PEDDI XDM-630

Peddinghaus

STRONGER THAN
STEEL®

www.peddinghaus.com | info@peddinghaus.com | (815) 937-3800

Steel Fabricator's Competitive Advantage

Steel Fabrication Management Software That Can Help You Win More Business

Steel fabricators that use Tekla PowerFab avoid the need to add a margin of error to their competitive bids because they have a high degree of confidence in their cost estimates. PowerFab users are able to submit bids that are as competitive as possible while accurately meeting their desired profit margin.

Don't get left behind, visit teklapowerfab.com to learn all the ways Tekla PowerFab can help you increase your competitive advantage including improving bid accuracy.

Modern Steel Construction

August 2021

in every issue

departments

- 6 EDITOR'S NOTE
- 9 STEEL INTERCHANGE
- 12 STEEL QUIZ
- 60 NEWS & EVENTS
- 66 STRUCTURALLY SOUND

resources

- 65 ADVERTISER INDEX
- 65 MARKETPLACE & EMPLOYMENT



charlottemeetings.com, courtesy of tvsdesign

40

features

24 Station to Station

BY BRIAN A. FALCONER, SE, PE,
AND ICK KIM, PE

A steel-framed redevelopment of New York City's landmarked James A. Farley Building results in a 21st-century transportation hub that includes the spacious Moynihan Train Hall and a massive public space topped by a signature atrium.

32 Coat of Arms

BY WILLIAM D. CORBETT

KTA-Tator's new home is an homage to the company's coatings know-how and steel history.

40 Connecting Conventioneers

BY JONATHAN HURFF, SE, PE, PhD,
BEN CHEPLAK, SE, PE,
BRETT REICHARD, SE, PE, AND
JACOB FRYE, PE

The Charlotte Convention Center leverages steel to add several new meeting rooms and an iconic pedestrian bridge.

48 Century Club: McGregor Industries

BY GEOFF WEISENBERGER

AISC is 100! And we're featuring our longest continuously running member fabricators throughout 2021.

51 Transforming Education

BY NATHANIEL GONNER, SE

AISC Continuing Education is continuing to adapt to the new normal by offering new ways to learn.

54 2021 Hot Products

Hot offerings from NASCC: The Virtual Steel Conference.

columns

steelwise

16 Intuitive Details

BY MARK TURMAN AND JONATHAN TAVAREZ

While constructability ultimately becomes the erector's concern, addressing it early via more intuitive detailing can create a scenario where it's not a concern at all.

data driven

19 The Ups and Downs of Project Costs

BY JOE DARDIS

Data Driven highlights market trends, economic forecasts, or other relevant numbers that affect steel design and construction. This month's data focuses on fluctuations in construction project costs.

field notes

20 Building Out

INTERVIEW BY GEOFF WEISENBERGER

Nick Colina has turned his once-struggling family business into a success story and is also working to turn the California construction industry into a more inclusive landscape.

business issues

22 The Essentials of Teamwork

BY DAN COUGHLIN

Goals, roles, and trust: three keys to achieving true and effective teamwork.

ON THE COVER: Moynihan Train Hall is bringing New York's Penn Station into the future, p. 24. (Photo: Severud)

MODERN STEEL CONSTRUCTION (Volume 61, Number 8) ISSN (print) 0026-8445; ISSN (online) 1945-0737. Published monthly by the American Institute of Steel Construction (AISC), 130 E Randolph Street, Suite 2000, Chicago, IL 60601. Subscriptions: Within the U.S.—single issues \$6.00; 1 year, \$44. Outside the U.S. (Canada and Mexico)—single issues \$9.00; 1 year \$88. Periodicals postage paid at Chicago, IL and at additional mailing offices. Postmaster: Please send address changes to MODERN STEEL CONSTRUCTION, 130 E Randolph Street, Suite 2000, Chicago, IL 60601.

DISCLAIMER: AISC does not approve, disapprove, or guarantee the validity or accuracy of any data, claim, or opinion appearing under a byline or obtained or quoted from an acknowledged source. Opinions are those of the writers and AISC is not responsible for any statement made or opinions expressed in MODERN STEEL CONSTRUCTION. All rights reserved. Materials may not be reproduced without written permission, except for noncommercial educational purposes where fewer than 25 photocopies are being reproduced. The AISC and Modern Steel logos are registered trademarks of AISC.



Printed on paper made from a minimum of 10% recycled content.

Design Your Next Project in VisualAnalysis



www.iesweb.com

Efficient and affordable structural software. Get your free trial in minutes.

editor's note



With vaccines readily available and the pandemic beginning to recede, my family embarked on a vacation to New Orleans.

While the sights and food remain the main attractions, on this visit I found something else that piqued my interest: our amazing hotel room. The room was clean, spacious, bright, with high ceilings and—most interestingly to me—had exposed steel beams.

It turns out The Marquee wasn't always a hotel. When it was built in the early 1970s, it was a medical office building. In 2014, it was converted to luxury condos and a couple of years later became a hotel.

One of steel's strengths is its utility in adaptive reuse projects. As AISC has often pointed out, steel framing systems can be readily adapted to cope with the changing requirements of occupants, avoiding functional obsolescence, the high cost and disruption of redevelopment or demolition, and the negative environmental impacts of new construction.

- New floor openings can easily accommodate stair openings, changes in HVAC systems, and other needs without disruption to the surrounding structure.
- Steel members can be easily reinforced, without adding new members, for different loadings due to reconfigured workspaces, different occupancy loads, or changing technology.
- Because steel is strong and lightweight, vertical expansion is often possible using the existing foundation and lateral systems.

If you attended NASCC: The Virtual Steel Conference in April, you may have caught Danya Mohr's and Travis Corigliano's (both from Magnusson Klemencic Associates) presentation on "Rebuilding the Big Box," which discussed repurposing former retail space for other uses while reducing embodied carbon by as much as 70%. Examples included "new" theaters and new office space. (You can view this session and more than 1,000 other presentations at aisc.org/educationarchives.)

Interestingly, in my neighborhood, we have two great examples of big box conversions, one to a medical office building and one to a technology center for the local community college. Outside of former big box stores, we've also seen the adaptive reuse of office buildings, theaters, residential buildings, and university structures. And, of course, there are numerous examples of successful and amazing vertical and horizontal expansions.

The versatility of steel makes it the premier framing material for today's architects, engineers, contractors, and owners. Its high strength-to-weight ratio allows long spans and slender members that give designers the freedom to economically achieve their most ambitious visions. It means you can feel confident choosing steel today—and also know that your building will endure tomorrow even if its function needs to change.

Scott Melnick
Editor

Modern Steel Construction

Editorial Offices

130 E Randolph St, Ste 2000
Chicago, IL 60601
312.670.2400

Editorial Contacts

EDITOR AND PUBLISHER

Scott Melnick
312.670.8314
melnick@aisc.org

SENIOR EDITOR

Geoff Weisenberger
312.670.8316
weisenberger@aisc.org

DIRECTOR OF PUBLICATIONS

Keith A. Grubb, SE, PE
312.670.8318
grubb@aisc.org

PRODUCTION SPECIALIST

Erika Salisbury
312.670.5427
salisbury@aisc.org

GRAPHIC DESIGN MANAGER

Kristin Hall
312.670.8313
hall@aisc.org

AISC Officers

CHAIR

Jack Klump, Cianbro Fabrication
& Coating Corporation

VICE CHAIR

Stephen Knitter
Geiger & Peters, Inc.

SECRETARY/LEGAL COUNSEL

Edward Seglias, Cohen Seglias
Pallas Greenhall & Furman, PC

PRESIDENT

Charles J. Carter, SE, PE, PhD

SENIOR VICE PRESIDENT

Scott Melnick

VICE PRESIDENT

Carly Hurd

VICE PRESIDENT

Lawrence F. Kruth, PE

VICE PRESIDENT

Brian Raff

VICE PRESIDENT

Mark W. Trimble, PE

Editorial Advisory Panel

Caroline R. Bennett, PE, PhD
University of Kansas

Amanda Dean, PE

Walter P Moore

Bryan Frazier,

Zalk Josephs Fabricators, LLC

Keith R. Griesing, PE

Hardesty and Hanover

Stephen Knitter

Geiger & Peters, Inc.

Advertising Sales

M.J. Mrvica Associates, Inc.

2 W Taunton Avenue

Berlin, NJ 08009

856.768.9360

mjmrsvica@mrsvica.com

Address Changes and Subscription Concerns

312.670.2401
subscriptions@aisc.org

Reprints

Erika Salisbury

312.670.5427

salisbury@aisc.org

Say hello to the new SDS2.



SDS2
DETAILING



SDS2
ESTIMODELING



SDS2
LOAD PLANNING



SDS2
SITE PLANNING



SDS2
MODEL REVIEW



SDS2 is revolutionizing the way steel construction is done. Our solutions leverage proprietary, AI-powered design to optimize your projects for fabrication and construction efficiency, accelerating project workflows from concept to completion and powering up your productivity.



SDS2[®]
A NEMETSCHEK COMPANY

To schedule a demo visit sds2.com/demo



**GET
CONNECTED—
TO \$5,000!**



NEED
FOR
SPEED

AISC is looking for the next great idea in connections. The key words are FAST and EASY—to design, fabricate, and erect safely.

And there's \$5,000 on the line for the best concept!

All you need is a spark of inspiration; we'll take it from there. Your outside-the-box idea could become an open-source, non-proprietary system that will revolutionize the entire industry!

herox.com/speedconnectionsteel

Deadline for entry is October 8, 2021.



CELEBRATING
100 YEARS
1921–2021

If you've ever asked yourself "Why?" about something related to structural steel design or construction,

Modern Steel's monthly Steel Interchange is for you!

Send your questions or comments to solutions@aisc.org.

steel interchange

All mentioned AISC codes and standards, unless noted otherwise, refer to the current version and are available at aisc.org/specifications, AISC Design Guides are available at aisc.org/dg, and AISC webinars are available at aisc.org/education-archives.

Reinforcement Design and Residual Stresses

I'm retrofitting an existing arched truss hangar structure. Most of the retrofits will require strengthening members that are already under load. The existing shapes are a combination of angles, channels, I-shapes, and various built-up shapes. Many of the angles are double or starred. Most of the members to be retrofitted are deficient in terms of compression buckling, and many in the elastic buckling range or involve slender angles or plates. I have found some guidance for wide-flange shapes, but not as much for angles and other shapes. Do you have any recommendations?

As you mentioned, several research projects are available for wide-flange members reinforced under load (pre-load). The references available up to 2013 are listed at the end of the course notes for the AISC webinar "Design of Reinforcement for Steel Members, Part 1."

I am not aware of any research on the effect of pre-load on the buckling strength of the cross-sectional shapes that you described. However, there are some useful papers by Martin Vild with Brno University of Technology exploring the effects of pre-load on the buckling strength of singly symmetric cross sections. (You can access Vild's papers at researchgate.net/profile/Martin-Vild.)

The aforementioned webinar presents the concept of stabilizing and non-stabilizing reinforcement to determine the effect of any pre-load. However, stabilizing reinforcement applies only to doubly-symmetric, non-slender members. This is because the stabilizing reinforcement concept was developed for the limit state of flexural buckling. For members with slender elements, the compression strength can be controlled by local buckling. Therefore, the reinforced member should be designed with non-stabilizing reinforcement. Also, the cross-sectional shapes you described may have a global buckling mode of torsional or flexural-torsional buckling. Therefore, only non-stabilizing reinforcement applies to these members. An allowable stress approach can be used in these cases, as discussed on slides 45 and 46 of the webinar. This

allowable stress design method, based on the simple addition of the stresses before and after reinforcement, has been used extensively in practice.

Bo Dowswell, PE, PhD

Welding Reinforcement Plates

We are adding reinforcing plates to existing columns mainly to increase their rigidity. Do the end connections need to be designed to develop the yield strength of the reinforcing plate, as shown in Example 6.2.2 of AISC Design Guide 15: *Rehabilitation and Retrofit*, or is it acceptable to use the minimum bolt requirement prescribed in Section E6.1 of the AISC *Specification for Structural Steel Buildings* (ANSI/AISC 360)?

The AISC Design Guides were developed to provide practical guidance for common problems encountered in steel design. Their requirements are not mandatory, and you should use your own judgment to determine where and when to apply them.

The example you mentioned in Design Guide 15 uses a conservative approach to avoid calculating the actual force transferred from the plate to the 10WF66. Alternatively, the welds can be designed for the actual force in the plate at the theoretical cutoff point. This topic is addressed in the AISC webinar, "Design of Reinforcement for Steel Members, Part 2."

Bo Dowswell, PE, PhD

Fabricating Bolt Holes

Where in the AISC *Specification* can I find acceptable methods for making bolt holes?

As indicated in AISC FAQ 2.4.1 (aisc.org/faq), the acceptable methods for making bolt holes are:

1. Punching
2. Sub-punching and reaming
3. Drilling
4. Hole sawing
5. Flame piercing and reaming
6. Thermal cutting, subject to surface quality requirements
7. Water jet cutting

The Commentary to Section M2.5 of the AISC *Specification* states: "The *Specification* previously limited the methods used

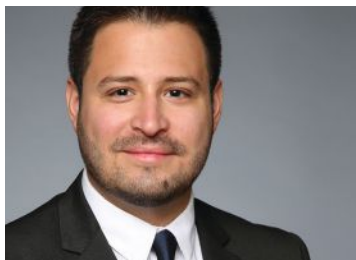

Jonathan Tavaréz (tavaréz@aisc.org)

is a staff engineer with AISC's Steel Solutions Center. **Bo Dowsnell**, principal with ARC International, LLC, and **Larry Muir** are both consultants to AISC.



STEEL SOLUTIONS CENTER

Steel Interchange is a forum to exchange useful and practical professional ideas and information on all phases of steel building and bridge construction. Contact Steel Interchange with questions or responses via AISC's Steel Solutions Center: 866.ASK.AISC | solutions@aisc.org

The opinions expressed in Steel Interchange do not necessarily represent an official position of the American Institute of Steel Construction and have not been reviewed. It is recognized that the design of structures is within the scope and expertise of a competent licensed structural engineer, architect or other licensed professional for the application of principles to a particular structure.

The complete collection of Steel Interchange questions and answers is available online at www.modernsteel.com.

to form holes, based on common practice and equipment capabilities. Fabrication methods have changed and will continue to do so. To reflect these changes, this *Specification* has been revised to define acceptable quality instead of specifying the method used to form the holes, and specifically to permit thermally cut holes. AWS C4.1, Sample 3, is useful as an indication of the thermally cut profile that is acceptable (AWS, 2015). The use of numerically controlled or mechanically guided equipment is anticipated for the forming of thermally cut holes. To the extent that the previous limits may have related to safe operation in the fabrication shop, fabricators are referred to equipment manufacturers for equipment and tool operating limits.”

Section M2.5 of the AISC *Specification* states: “Bolt holes shall comply with the provisions of the *RCSC Specification for Structural Joints Using High-Strength Bolts* Section 3.3, hereafter referred to as the *RCSC Specification*, except that thermally cut holes are permitted with a surface roughness profile not exceeding 1,000 μin . (25 μm), as defined in ASME B46.1. Gouges shall not exceed a depth of $\frac{1}{16}$ in. (2 mm). Water jet cut holes are also permitted.” As indicated in a user note provided, the “AWS Surface Roughness Guide for Oxygen Cutting” sample 3 can be used as a guide for checking the surface roughness of thermally cut bolt holes.

Section 3.3 of the *RCSC Specification* adds that for “cyclically loaded slip-critical joints, mechanically guided thermally cut holes shall be permitted. For other cyclically loaded joints, thermally cut holes shall be permitted upon approval by the engineer of record.”

Jonathan Tavaréz, PE

Angle Brace Work Point

I have a single-angle brace welded to a gusset plate. How do I make sure the line of force through the angle lines up with the work point of the column and beam? Should the work point be measured through the centroid of the angle or measured through the centroid of the connection?

Section J1.7 of the *Specification* states: “Groups of welds or bolts at the ends of any member that transmit axial force into that member shall be sized so that the center of gravity of the group coincides with the center of gravity of the member unless provision is made for the eccentricity. The foregoing provision is not applicable to end connections of single-angle, double-angle, and similar members.”

As a general rule, the choice of a work point is left to the discretion and judgment of the engineer. Generally, in my experience, concentric work points are provided. However, as indicated in Section J1.7, eccentric work points can be used if “provision is made for the eccentricity.”

The Commentary to Section J1.7 states: “Slight eccentricities between the gravity axis of single- and double-angle members and the center of gravity of connecting bolts or rivets have long been ignored as having a negligible effect on the static strength of such members. Tests have shown that similar practice is warranted in the case of welded members in statically loaded structures (Gibson and Wake, 1942).”

In my experience, the engineer of record (EOR) indicates the preferred (required by contract) work points in the typical details. Also in my experience, it is not uncommon for the EOR to entertain and approve changes in the work point location to accommodate fabricator preferences.

Larry Muir, PE

NUCOR[®]

TUBULAR PRODUCTS

DOING BUSINESS JUST GOT EASIER

NEW APP FEATURES NOW AVAILABLE

Authenticated NTP Portal users
can now login using their credentials
to access:

- Pricing information (CWT) for sizes, and submit a request to your sales rep to process an order from the App
- Select from images of shapes mirroring the NTP Portal experience
- Complete schedule of rolling dates
- Available product grades for the particular size & length that you've selected.



WWW.NUCORTUBULAR.COM

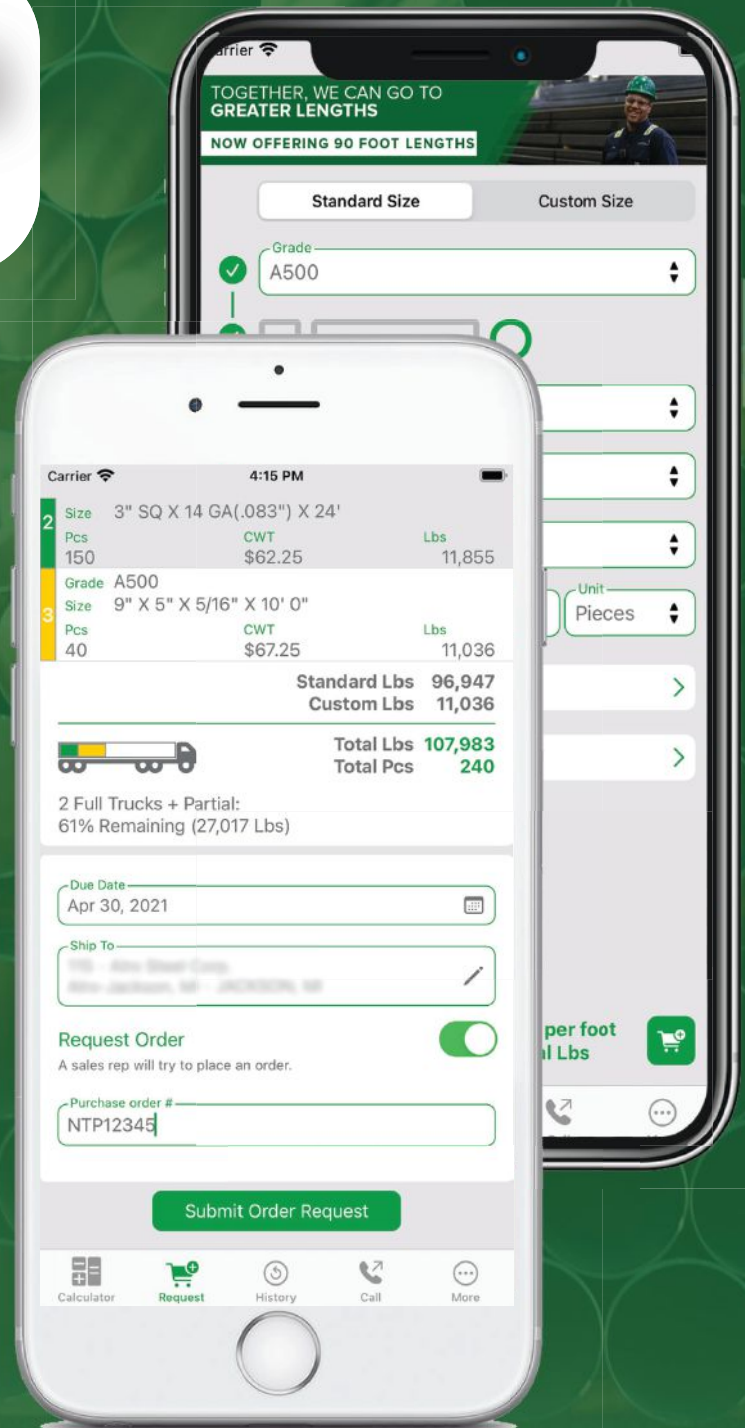

steel quiz

This month's quiz takes you to AISC's Education Archives, found on our Continuing Education page at aisc.org/education/continuingeducation.

This compilation of past webinars, seminars, and NASCC: The Steel Conference sessions provides helpful resources for brushing up on specific topics. You will find the answers to this quiz in Bo Dowsell's "Beam Stability Bracing" and Rafael Sabelli's "Lessons Learned: Seismic Design of Steel Buildings" presentations, both of which were featured in the 2020 Flash Steel Conference. And for more on AISC Continuing Education's offerings, see "Transforming Education" on page 51.

- 1 **True or False:** Two beams braced perpendicularly by two infill beams need an external restraint to ensure proper torsional point bracing.
- 2 **True or False:** Grating is always considered to provide poor panel bracing due to low in-plane shear resistance.
- 3 Which of the following is *not* considered a way to provide torsional rotation restraint?
 - a. Lateral bracing
 - b. Torsional bracing
 - c. Web distortion bracing
 - d. Combined lateral and torsional bracing

- 4 A beam is loaded a quarter of the beam depth below the top flange. Which of the following locations is recommended to brace this beam adequately? (You can choose more than one option.)
 - a. Top flange
 - b. Within the top 15% of the beam depth
 - c. At the load level or higher
 - d. At the shear center or higher
- 5 Separation of thermal and seismic joints can be estimated as what percentage of the structural height?
 - a. 2%
 - b. 3%
 - c. 4%
 - d. 5%
- 6 **True or False:** The square root of the sum of the squares (SRSS) is sufficient to calculate the bracket movement towards the supporting structure (pounding condition). Still, it is not sufficient for movement away from the supporting structure.
- 7 **True or False:** SRSS is a useful way to calculate forces on non-orthogonal beams, columns, and piles.

TURN TO PAGE 14 FOR THE ANSWERS

BEND-TECH PLASMA CUTTING NEVER
LOOKED SO GOOD

DRAGON A400
CNC PLASMA TUBE & PIPE CUTTER

BEND-TECH 651.257.8715 • www.bend-tech.com • sales@bend-tech.com **NOMMA** **AISC**
ASSOCIATE



The next best thing to being there.

Traditional classroom learning isn't always convenient or sometimes even possible. That's why Vulcraft has developed remote learning options where our team members or industry experts provide joist, deck, grating, Ecospan® or RediCor® training through online webinars, discussion boards, video conferencing, or virtual assessments.

With Vulcraft's Remote Learning, you can:

- Customize your professional education.
- Meet on your time and where it's convenient.
- Earn PDHs/CEUs for you and your team.

Simply choose a building topic you're interested in and ask us about our remote learning opportunities. Vulcraft wants to be your go-to source for continuing education.



Powerful Partnerships. Powerful Results.

www.vulcraft.com/Learning

steel quiz ANSWERS

Everyone is welcome to submit questions and answers for the Steel Quiz. If you are interested in submitting one question or an entire quiz, contact AISC's Steel Solutions Center at 866.ASK.AISC or solutions@aisc.org.

- 1 **False.** The moment in the infill beam that is resisting the torsional rotation is counteracted at the other end of the infill beam by buckling of the second braced beam. This is discussed further on slide 11 of the beam stability presentation.
- 2 **False.** While there are many considerations such as the removability of the grating, corrosion, thermal stresses, fatigue, lack of control of the installation process, etc., grating with direct-welded connections has been assumed to provide bracing in some cases. Saddle clips and other connections may not provide the lateral restraint needed. Ultimately, engineering judgment is required. This is discussed further on slides 27-31 of the beam stability presentation.
- 3 **c.** While local web stiffening may be needed in some instances, this is not listed as one of the ways to resist torsional rotation on slide 5 of the beam stability presentation.
- 4 **a, b, and c.** All three options satisfy the recommendation that the brace is located at the load level or higher. This is discussed on slide 19 of the beam stability presentation.
- 5 **a.** 2% is a reasonable estimate for structural joint separation when using double columns, as shown at about five minutes into the seismic presentation.
- 6 **True.** The maximum considered earthquake movement of each structure independently is taken conservatively. The SRSS is not calculated, but rather these distances are added together, as shown at about seven minutes into the seismic presentation.
- 7 **False.** Piles tend to have equal stiffness in all directions, so the SRSS ends up being a vector sum. Additional load would be incorrectly applied, as explained at about 15 minutes into the seismic presentation.



STEEL SOLUTIONS CENTER

VOORTMAN V807 ROBOTIC THERMAL PROFILE PROCESSOR

voortman
VOORTMAN USA

26200 S. Whiting Way +1 708 885 4900
Monee, IL 60449 info@voortmancorp.com
United States of America www.voortmancorp.com

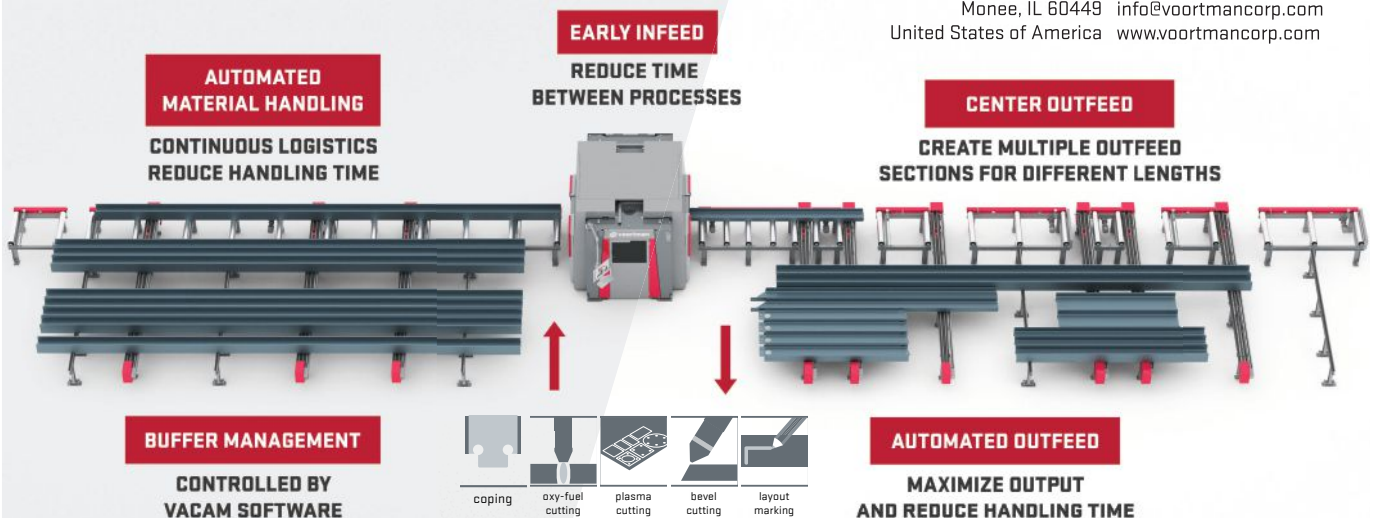

"With multiple output sections, we already sort our profiles according to the output by length or project. This saves us a lot of handling time and we see a faster turnaround in the entire workflow."
David McWhirter of McWhirter Steel

"The early infeed in particular has made a bit of a difference in production speed. In addition, production is fully automated with our operator focusing more on loading and unloading profiles."
Steven Scrape of SCW





Are You Redi...

GET REDI FOR A SIMPLIFIED, FASTER ALTERNATIVE TO CONVENTIONAL CONCRETE CORE CONSTRUCTION.

Conventional methods of core construction can be a challenge. Unpredictable weather, unacceptable tolerances, and concrete curing delays can sometimes bring production schedules to a halt. And that can be costly.

Now there's a better way.

RediCor is a factory-built, ready-to-set modular steel form system that simplifies and accelerates concrete core construction. The structurally true modules stack like building blocks and are ready for structural framing once they're set – saving time and money. So, are you Redi?



Preinstalled stairs, embeds and connections improve safety and accelerate the schedule.

NUCOR®
VULCRAFT
Powerful Partnerships.
Powerful Results.

VISIT US AT REDICOR.COM FOR THE REDICOR STORY.

REDICOR®
Modular Steel Form System
BY VULCRAFT

steelwise INTUITIVE DETAILS

BY MARK TURMAN AND
JONATHAN TAVAREZ



Mark Turman (m.turman@snjs.org) is the detailing manager with Southern New Jersey Steel Company, Inc., an AISC member fabricator.

Jonathan Tavarez (tavarez@aisc.org) is a staff engineer with AISC's Steel Solutions Center.



**NEED
FOR
SPEED**

AISC's Need for Speed initiative recognizes technologies and practices that make steel projects come together faster. Check out aisc.org/needforspeed for more.

While constructability ultimately becomes the erector's concern, addressing it early via more intuitive detailing can create a scenario where it's not a concern at all.

HOW OFTEN DO FABRICATORS review documents with detailers to ensure that fabrication and erection go smoothly from start to finish, only to get a phone call from the erector with constructability issues?

The short answer: far too often.

"How am I supposed to get these bolts in?" "I need to remove a column stiffener to get the beam into the column." "There's no access to make the welds shown on the erection documents." And so on. (See Figure 1 for an example.)

And then the internal question becomes, "How did we not anticipate this?"

The truth is that oftentimes, engineers and detailers simply don't have enough information to foresee situations that can hinder constructability. Luckily, there are steps that can be taken to minimize these issues, and many of them are readily available in the AISC *Code of Standard Practice for Steel Buildings and Bridges* (ANSI/AISC 303, aisc.org/specifications).

Site visits. Let's start with the beginning of a project, even before detailing occurs. A simple yet effective step is to have the fabricator's project manager and the steel erector visit the site together and record site conditions that can potentially cause issues that can be addressed during detailing and fabrication. These might include actually getting material into an existing building (if performing a renovation), not having access to connections due to existing obstructions, and modifying the erection sequence due to site conditions. The *Code* contains provisions related to existing structures in **Section 1.8**, with **Section 1.8.2** stating: "Protection of an existing structure and its contents and equipment, so as to prevent damage from normal erection processes, is not within the scope of work that is provided by either the fabricator or the erector. Such protection shall be performed in a timely manner so as not to interfere with or delay the work of the fabricator or the erector." **Section 1.8.3** states: "... surveying or field dimensioning, which is necessary for the completion of the approval

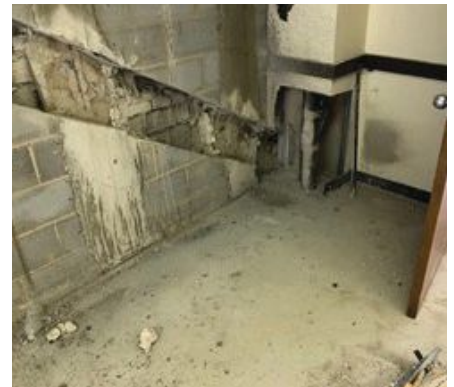
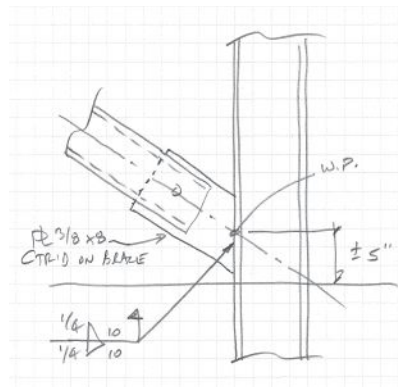

Unclear details can result in field scenarios that make an ironworker's or erector's job much more difficult than it should be.



above and right: The fabricator's project manager and the steel erector should consider visiting a project site early to look for conditions that might need to be addressed during detailing and fabrication.

documents and fabrication, shall be performed and furnished to the fabricator in a timely manner as not to interfere with or delay the work of the fabricator or erector.” These are sample issues that can be handled in detailing once the information is gathered and passed along to the detailer.

Pre-detailing meeting. It is also important for the erector and fabricator's project manager to meet with the detailer prior to beginning the detailing process to review the design documents for possible issues. This meeting will allow everyone to discuss areas of concern that can be addressed early rather than when the steel is already in the field. The **Commentary to Section 4.1** discusses this and recommends that a “pre-detailing conference” be held, after the structural steel fabrication contract is awarded, between the owner's designated representatives (ODRs) for design and construction, fabricator, detailer, and the erector. (See this section for a list of recommended discussion topics for this preliminary meeting.) It is also good practice to review every different type of connection to be implemented on the project since connections are where most constructability issues occur. This will help the detailer understand the erector's expectations and lead to better direction on how to provide details, and it will

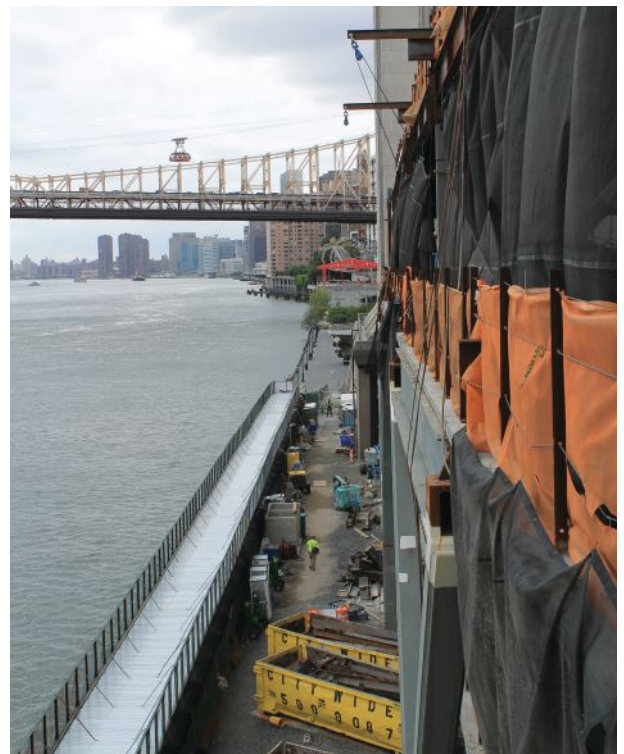



The fabricator should communicate regularly with the ODR for construction regarding field issues that need to be addressed in order for the steel erector to work safely.

also give the fabricator enough time to anticipate and issue RFIs, if required, so as not to impact the schedule.

Keeping the contractor in the loop. In addition, the fabricator's project manager should stay in frequent communication with the ODR for construction to make them aware of any issues seen in the field or on the design documents that the ODR for construction needs to address to allow the erector to work safely. This open communication can also help address potential issues discussed in the meeting with the erector and the steps being taken to prevent these issues.

All RFIs and questions should go through the ODR for construction to assure their knowledge of any change, especially in cases involving potential changes to cost or schedule. The **Commentary to Section 4.6** of the *Code* states: "The RFI process is most commonly used during the detailing process but can also be used to forward inquiries by the erector or to inform the ODR for design in the event of a fabricator or erector error and to develop corrective measures to resolve such errors. The RFI process is intended to provide a written record of inquiries and associated responses but not to replace all verbal communication between the parties on the project."

It goes on to say that RFIs should be prepared and responded to in a timely fashion so as not to delay the work of the steel detailer, fabricator, and erector and that discussion of the RFI issues and possible solutions between the fabricator, erector, and ODRs for design and construction can often facilitate timely and practical resolutions. (Review the rest of this section for additional guidance on how to develop and submit RFIs.)

Educating the detailer. The fabricator needs to ensure that the detailer understands the erector's means, methods, and expectations. This includes field connection tolerances, TC gun

sizes (to ensure specific bolts can be installed), necessary access for welds, direction of installation, and other items that can prevent problems for the erector. Bolt entering and tightening clearances are listed in Tables 7-15 and 7-16 of the AISC *Steel Construction Manual* (aisc.org/manual). It is important to note that tolerances absent in the design documents shall not be considered as zero, as stated in **Section 1.10** of the *Code*, and the detailer should also know where and how to add the necessary adjustments in the steel details required for erection.

Be cognizant of timeliness. The erector needs to allow time for its field superintendent to review erection documents prior to going on-site, preferably early in the project before documents are released for fabrication. **Section 4.7** of the *Code* notes that the erection documents shall be provided to the erector in a timely manner to allow for proper planning and performance of the work, but also allow for the release of preliminary documents if requested. In addition, a review of the approval documents by the erector should catch any issues the detailer may have overlooked. This is another step that provides the fabricator time to submit RFIs, if needed, and update documents so as not to delay the release of fabrication documents to the shop. If any discrepancies are caught and any revisions to the design documents and project specification are needed, **Sections 3.3 and 3.5** of the *Code* provide applicable provisions.

We all dream of that perfect world where there are never any problems with erecting steel. But we all know there is no way to foresee every single possible issue on every single project. That said, a project where fabricators, erectors, and detailers communicate and anticipate issues early can help eliminate the vast majority of constructability issues. Remember: The fabricator-detailer-erector relationship is a *partnership*, and like all partnerships, open and honest communication is a requirement for success. ■

data driven

THE UPS AND DOWNS OF PROJECT COSTS

BY JOE DARDIS

Data Driven highlights market trends, economic forecasts, or other relevant numbers that affect steel design and construction. This month's data focuses on fluctuations in construction project costs.

Cost per Square Foot and Inflation

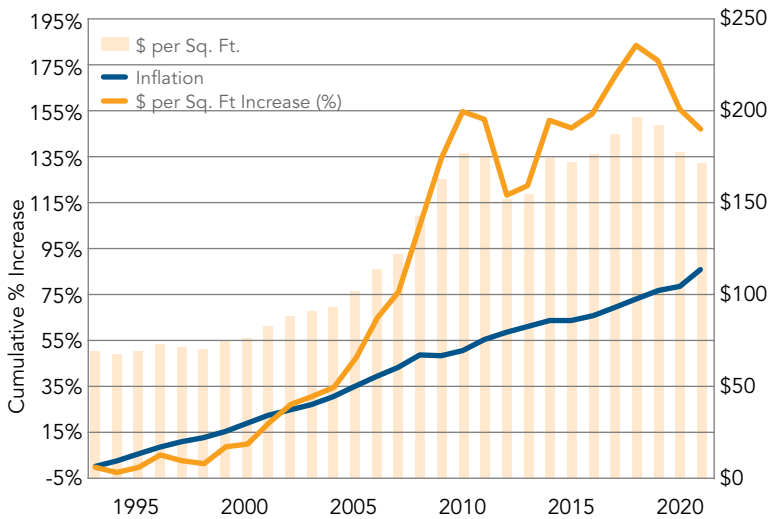

Fig. 1. Overall construction project cost per square foot and inflation.

Dollars per Square Foot (Project Type)

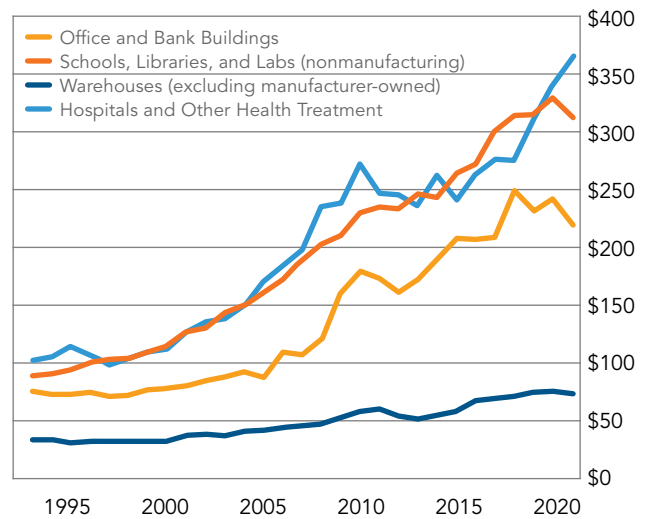

Fig. 2. Cost per square foot for different building types.

RIISING CONSTRUCTION PROJECT COSTS have been a hot topic lately—but just how far have they risen and how do the increases compare to the past?

Like everything, we expect construction project costs to increase over time due to inflation. The question is whether current project cost increases are at that same pace. Cumulative inflation in the U.S. since 1993 totals roughly 86%, or an average of 2.25% per year. Figure 1 shows the total value of all nonresidential and residential projects greater than four stories in dollars per square foot and inflation. Since 1993, the cost per square foot of construction has risen 147%, greatly outpacing inflation.

With the recent and well-publicized increases in material and construction costs, why have overall dollar-per-square-foot costs actually gone down recently? The answer might lie in the types of projects being built. Figure 2 highlights different dollar-per-square-foot values for different project types. While the average cost of hospitals, schools, and offices has risen dramatically, the cost of warehouses (which currently account for 43% of the nonresidential construction market and 35% of the whole construction market) has only increased 106% since 1993.

What does this tell us? It implies two things. One, since warehouses tend to be simpler structures without all the bells and whistles of a new hospital or school, the costs of non-structural elements and finishes have increased at a faster pace than the skin and bones. Two, schools and hospitals have an increasingly higher standard and are willing to adopt new technology first (and build to accommodate it). And as most other project types (such as offices) fall in between these two extremes, it's likely a little bit of both. Regardless of the reason(s), it's important to understand how a changing construction market dynamic affects what we perceive. Yes, project costs are rising, but the unprecedented shift in the kinds of projects provides some perspective on why. This scenario is one of many examples of why it's good to have a full picture of the market rather than focusing on just one statistic. ■



Joe Dardis (dardis@aisc.org) is AISC's senior structural steel specialist for the Chicago market.

field notes

BUILDING OUT

INTERVIEW BY
GEOFF WEISENBERGER

Nick Colina has turned his once-struggling family business into a success story and is also working to turn the California construction industry into a more inclusive landscape.



Field Notes is *Modern Steel Construction's* **podcast series**, where we interview people from all

corners of the structural steel industry with interesting stories to tell. Listen in at modernsteel.com/podcasts.



Geoff Weisenberger
(weisenberger@aisc.org) is senior editor of *Modern Steel Construction*.

NICK COLINA is a San Franciscan through and through.

Born at San Francisco General, he has spent most of his life in the City by the Bay and is a passionate advocate for his hometown (and a big Golden State Warriors fan). And as the administrator of operations for Anco Iron and Construction, Inc., an AISC member fabricator that his grandfather started in 1969, he's also vested in the city's continued success. The company has worked on several prominent projects in the San Francisco and has seen significant growth since Nick joined its leadership team. In addition, he's a co-founder of BuildOut California, the world's first LGBT industry association dedicated to the sustainable growth of LGBTQ-owned and certified businesses in the fields of architecture, engineering, construction services, real estate development, and related industries.

Are you a Bay Area native? Have you lived there your whole life?

Yes, I was born and raised in San Francisco. I went to high school at Saint Ignatius here in the city, and then I went to college at UC Davis up in Woodland, California. I lived in Portland for a year as well, but I've mainly been in the Bay Area, my home ground.

What did you study at UC Davis?

I got a managerial economics degree. I was particularly interested in studying how businesses can do well during a recession. It was personal to me and my own family business because we weren't doing well during the recession, so that was my focus, trying to figure out what to do to be sustainable. I still talk to my economics professors, and they ask me how I applied what I learned because they see how well the business is doing, and they want to be able to teach some of what I learned in school and how I was able to apply it.

Tell me about the family business.

Anco Iron and Construction is a minority-certified family-owned steel contractor-supplier based out of the Bayview-Hunters Point area of San Francisco. My grandfather came here from Mexico in 1969 to start the company, and we're now a third-generation business. My dad runs it, and my sisters and I are managing partners. So yes, I grew up in steel, and I always like to say that steel is in my blood, and so is entrepreneurship. When my sister and I take over the business, we will be the only Latino-owned LGBTQ-certified steel contractors in the United States.

Did you always know you'd work for the family business, or did you have any other career thoughts at any point?

I did leave Anco for a little bit and worked in restaurants and such throughout my college career, but I always had the drive to be an entrepreneur and orchestrate some of the ideas that I couldn't make possible in other businesses because they weren't my own. They weren't my family's business. And so when I came back to Anco about seven years ago, I was able to orchestrate some of those ideas and goals and really change the path of our business.

As a matter of fact, I saw that Anco was named a Fastest-Growing Private Company in 2019 and 2020 by *San Francisco Business Times*. Can you talk a little bit about that accomplishment and how you achieved it?

A few years back, we weren't doing so well. We had low sales and, really, I was kind of a last-ditch effort to save the company. My mom asked me to come back and help my dad get involved with the business again and try to help bring it back. And so I gave it a shot. At the time, I worked at a restaurant and at Anco and went to school all at the same time, and we put all of our efforts into building things back. And we went from \$250,000 a year in sales to averaging \$4.5 million a year for the last few years—and in 2019, we hit \$7.5 million. We've been extremely blessed, and we're really looking to keep taking our business to the next level.

Can you talk about some of your most memorable projects?

We worked on the Chase Center for the Golden State Warriors. We're Warriors fans, so that was really exciting! And we just finished a job at the Biosolids Digester Facilities Project for the San Francisco Public Utilities Commission, which is a replacement of an old facility. At that facility, we also performed work putting up temporary structures for a pipeline which, while not exciting in the same way a stadium is, was essential since projects like that didn't stop during COVID, and they served as lifelines to get us through the pandemic. We're also on two showcase projects right now. One is Fire Station 35, which is the first floating fire station in San Francisco. The other is a 50-ft metal tree that we are installing in Mary Court Park.

Tell me about BuildOut California.

I sit on the board of the Northern California Chapter of the National Association of Minority Contractors and also on the board of the new Latino and Black Builders Association, which represents minorities in contracting. But what we didn't have for the longest time was a nonprofit organization that represents



LGBTQ contractors. And so Paul Pendergast, who is the president of BuildOut California and is also a founder—as am I—has really taken the initiative and is doing amazing things for our LGBTQ workforce and contractors. We're a community that has been involved in construction since the beginning of time, whether we are visibly out or not. We've been building and creating value for the construction industry for a long time. So it's really nice to have a support system of other like-minded people in our community that we can go to and talk about business, discuss opportunities, be the spokespersons for our community with owners and developers, and get us a foot in the door.

Do you think that the construction industry has been more inclusive in recent years?

Somebody once told me that most contractors don't care about my sexuality; they really just care if I can get the job done. And I've always lived by that. When I'm at work, it's not about my being gay, it's about whether I can provide a quality product and whether I'm going to bring you value. I've found that there are a lot of LGBTQ people in construction already. And when I meet others that are excited about construction, I tell them to come join us. We're already here building.

Getting back to your San Francisco roots, what's your favorite thing about the city?

San Francisco has always been a boom or bust city and an entrepreneurial city. My grandfather came here from Mexico because he didn't have opportunities there like we do here. It inspires people to create what they want to create. And I have confidence in our local politicians to keep providing opportunities for our local minority businesses. I think San Francisco takes care of San Franciscans. ■

This article is excerpted from my conversation with Nick. To hear more, check out the August Field Notes podcast at modernsteel.com/podcasts.

business issues

THE ESSENTIALS OF TEAMWORK

BY DAN COUGHLIN



Since 1998, **Dan Coughlin** has provided individual and group coaching to improve leadership and management performance. His topics are personal effectiveness, interpersonal effectiveness, leadership, teamwork, and management. Visit his free Business Performance Idea Center at www.thecoughlincompany.com.

Dan has also presented several presentations over the past few years at NASCC:

The Steel Conference.

To hear recordings of them, visit aisc.org/education-archives and search for “Coughlin.”

Goals, roles, and trust:
three keys to achieving true and
effective teamwork.

A TEAM IS A GROUP OF INDIVIDUALS who support one another toward achieving important goals and fulfilling a meaningful purpose.

For a team to be effective and “gel,” a few very important things need to happen. First, the group must work toward a shared goal. Second, everyone on the team needs to trust each other. And third, everyone needs to understand and execute their respective roles and associated responsibilities.

Goals

Let’s explore these simple yet crucial concepts one at a time. The most basic element of a team is that its members share a meaningful goal. They must know the goal and how their efforts contribute toward achieving the goal.

That might sound overwhelmingly obvious, and yet many business groups inside of the same organization are not a team. They are a collection of individuals. They might be called a committee or a task force or simply a staff, but they are not a team. What’s missing? They don’t have a shared, meaningful goal.

Test this out for yourself. Ask 15 people in your organization what goals they are working toward achieving this year. Write down all of the answers you receive. While everyone in your organization has their own role (and we’ll get to roles in a bit) and more specific goals, you should at least see one clear overall goal emerge.

In team sports, this is simple. We want to win the championship. We want to win the conference. Or, starting a bit smaller (and perhaps more realistically), we want to finish above .500. Whatever it is, if properly communicated by the coaches, all the team members know the goal.

In business, because there is no finish line—no clear end of the season—people can come to work every day, work very hard, go home, and never feel they were part of a team. That’s a problem.

A true team can achieve significant results, and people will feel that they fulfilled a meaningful purpose that goes beyond just themselves—and it can be exponentially better than they could have done on an individual basis. But again, that sense of teamwork begins with a shared, meaningful goal that every person, regardless of their role or department, can feel a connection to. It’s not always easy to clarify such a goal, but as a leader, it’s the necessary first step if you want to build true teamwork in your organization.

I encourage you to have a conversation with the members of your group, or at least the heads of the various departments, and ask them a question like, “What is the shared, meaningful goal that all of us are working to achieve?” Or, if you already have the goal in mind, tell them what it is. (Remember, what might be apparent to you might not be apparent to everyone.)

The goal might have two or three or more parts to it, but however many components it encompasses, you need to make sure everyone knows the overall goal, understands it, and focuses on it. Then all the other pieces of teamwork can be put into motion. Without a clear, shared, meaningful goal, you will lose out on the potential value of building a great team.

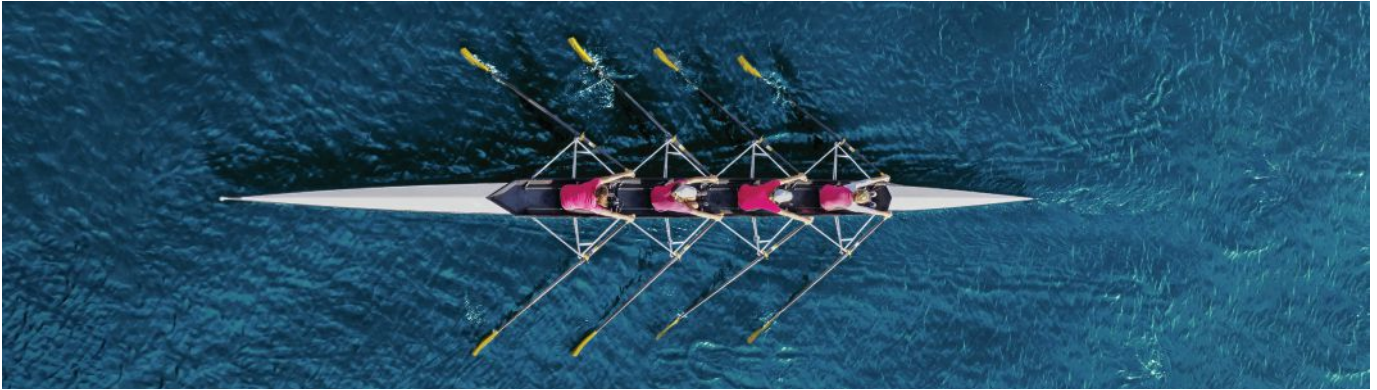

Trust

For teamwork to truly happen, there also has to be trust between the team members. Trust that you will do what you say you will do and that others will do what they say they will do. Trust that the other team members won't attack you behind your back and that you won't attack them behind their backs. Trust that what you say will be considered thoughtfully and responded to thoughtfully. Trust doesn't mean you will always like each other or agree with each other, but it does mean that people know they can count on you to be honest.

How do you build trust? Here are three easy steps:

1. Consider very carefully what you are committing to doing.
2. Let people know what you committed to doing.
3. Actually do what you committed to doing.

Remember: You can't do everything for everybody, so be careful what you actually commit yourself to. Be careful not to casually say yes when someone asks you to do ten things or asks you to sign a document that is so all-encompassing that there is no way you can do everything that is listed.

You build trust in little and big ways over and over and over. Trust can be lost, but it can also be regained. Trust means people can count on you. What you say and what you do actually have to connect to one another. Even if they disagree with you, they know what they can count on from you because you've told them, and you've done it.

The greatest challenge when it comes to trust is not building trust but rather *rebuilding* trust. But it can be done. Here are four steps for you to move toward rebuilding trust:

1. Search within yourself to understand the roots of what caused you to lose the trust other people had in you.
2. Consciously decide to change those roots in order to produce trustworthy actions in the future.
3. Communicate that you accept responsibility for what lost the trust of your teammates, and communicate what you will do differently.
4. Act in the new way over and over and over.

It takes tremendous reflection and effort to understand what you need to change within yourself. This self-honesty is very painful but necessary. Once you've decided on your new path, you have to make yourself vulnerable enough to communicate this new way of being. And then you absolutely need to make sure that your talk matches your walk.

It's a lot of work, but if you are willing to do it, you clear the path for people to start trusting you again. And they might not.

You have to earn their forgiveness, and they have to forgive you. It's a two-way street, and there is no guarantee that it's going to happen. But if you are very patient and you persevere, you can re-earn the trust that people had in you.

Roles

Another key to an effective team is for everyone to know their roles, understand the responsibilities associated with those roles, and execute them as well as they can.

Again, on a sports team—or in a musical group—this can be more obvious than with a company. But the same principle holds in all these situations.

For example, being in customer service and talking with customers during moments of heightened frustration is a different role than establishing a three-year strategy for the entire organization. Both roles are enormously important, but each comes with specific and different responsibilities. In order for the team to succeed, each individual has to know their role, understand the responsibilities associated with that role, and continually improve in the execution of those responsibilities.

True teamwork becomes more difficult when roles are blurred and responsibilities are not clear. And it's sometimes not easy to achieve this clarity. Figuring out your role, your responsibilities, and the best way to execute those responsibilities within your team can sometimes be an art, not a science. I encourage you to ask yourself these three questions frequently:

1. What is my role in this work situation?
2. What is my responsibility?
3. How can I execute that responsibility as well as I can?

And then I encourage you to review your performance by answering these questions:

1. What did I do that was effective, and why was it effective? And what did I do that was not effective, and why was it not effective?
2. What lessons did I learn or relearn from this situation?
3. What will I do the same, and what will I do differently in order to improve the execution of my responsibilities?

All of the core concepts of teamwork mentioned here require one thing: communication. When a team's goals, sense of trust, and individual roles and responsibilities are communicated, true teamwork becomes that much easier.

Stay tuned for more teamwork concepts in next month's Business Issues column. ■

Station to Station

BY BRIAN A. FALCONER, SE, PE, AND ICK KIM, PE

E PLURIBUS UNUM OUT OF MANY ONE

A steel-framed redevelopment of New York City's landmarked James A. Farley Building resulted in a 21st-century transportation hub that includes the spacious Moynihan Train Hall and a massive public space topped by a signature atrium.



all photos, unless otherwise noted: Severud Associates

MANHATTAN'S PENN STATION has seen a lot of passengers in its more than a century of existence.

Located between Seventh and Eighth Avenues and 31st and 33rd Streets in Manhattan, the famed station was designed by McKim, Mead and White and considered a Beaux-Arts masterpiece. When it opened in 1910, it could accommodate 200,000 passengers per day.

The station was nearly totally demolished in 1963, with only the train platforms and below-grade concourses and mezzanines remaining, and in 1968 Madison Square Garden and Pennsylvania Plaza both opened above what remained of the original station. Despite its reduced size, by 1992 the number of commuters and travelers passing through the station had already reached a burdensome 300,000 daily, with additional increases in train ridership projected. Looking to relocate the station to a larger facility, administrators turned their attention to the James A. Farley Post Office just across Eighth Avenue. The Farley building, also designed by McKim, Mead and White as a Beaux-Arts sister to Penn Station, opened in 1912, and an annex was constructed in 1933 that expanded the building all the way west to Ninth Avenue. For many years, it served as Manhattan's general post office, but as the 20th century drew to a close, the United States Postal Service planned to move operations elsewhere and much of the space would become empty and unused, making it an increasingly viable site for a new Penn Station.

The idea was taken up by then-U.S. Senator Daniel Patrick Moynihan of New York, who missed the old Penn Station that he had worked in as a boy. Using his influence and negotiating skills, Moynihan brought together then-president Bill Clinton, fellow legislators, the governor of New York, the mayor of New York City, Amtrak, the Long Island Railroad, New Jersey Transit, and prominent real estate businesses—and anyone else he thought might be able to contribute—to study the concept and develop a plan. Many schemes were proposed by different design teams, reviewed by the project stakeholders, and ultimately rejected for a variety of reasons.

Time passed, administrations changed, and a new century began. Senator Moynihan persisted, however, even after he left the senate in 2001, and the project continued. Others took up the cause after his death in 2003, most notably New York Governor Andrew M. Cuomo. Under his stewardship, the plans firmed up and evolved. Farley would become



Brian A. Falconer (bfalconer@severud.com) is a principal and **Ick Kim** (ikim@severud.com) is a senior associate, both with Severud Associates. **Kyle Roshberg**, a former associate, and **Andrew Mueller-Lust**, a former principal, also contributed to the article.



N.Y. POST OFFICE - UNASORTED MAIL Photo: Library of Congress



above: The original mail sorting room of the James A. Farley Building.
 right: Constructing a bolted transfer girder splice.
 below: A historic view of the Farley building from the southeast.



Photo: Library of Congress

the home of the new Moynihan Train Hall—not a replacement for Penn Station but rather an extension of its west end.

A New Era

Now a part of the Empire Station Complex, a proposed plan encompassing additional improvements to Penn Station and the transit-oriented, mixed-use redevelopment of several surrounding blocks, the project's central feature is the main boarding concourse. Located in Farley's former mail sorting room, the concourse is a spacious 30,000 sq. ft and is fully covered by steel-framed arched skylights, the peaks of which rise to a lofty 92 ft above the train hall floor. The space takes inspiration from the original Penn Station's grand 150-ft-tall waiting room and serves an ever-increasing number of commuters, including those from the growing nearby Hudson Yards and Manhattan West neighborhoods (Moynihan Train Hall and Penn Station's combined passenger count is expected to exceed 650,000 per day).

The complex also includes an intermodal hall located in Farley's old loading dock area and the West End Concourse expansion, which runs under the east end of Farley. Together, the improvements add station entrances, track access points, and interconnectivity between rail, subway, and street-level modes of transportation. Design and

construction were led by New York State's Empire State Development via a public-private partnership that succeeded in completing the complex project ahead of time and on budget. The design-build project team consists of Vornado Realty Trust, The Related Companies, Skanska, and Skidmore, Owings & Merrill (SOM).

In several ways, locating the Train Hall in the Farley building seems to have been preordained. Penn Station's train shed and most of its platforms (seven of a total of eleven) extended west of Eighth Avenue since the beginning, even before Farley was constructed. The east half of the Beaux-Arts-style building—Farley proper—is laid out as a box with a central court, allowing interior offices to have windows and also creating the wide-open space that was originally used as a mail sorting room. The roof of the skylit workroom was framed with trusses to keep it free of columns that might restrict operations. The room had lain dormant for decades, and its skylights had been covered up since World War II, but its size and location made it a natural candidate for repurposing as the new boarding concourse. Further, its aesthetic potential was well established—so much so, in fact, that Michael Evans, president of Moynihan Station Development Corporation (MSDC), had leased the sorting room to the fashion industry as a photogenic venue for runway shows.



Demolition of the existing loading dock (above), sorting room skylights (left), and sorting room floor (below).

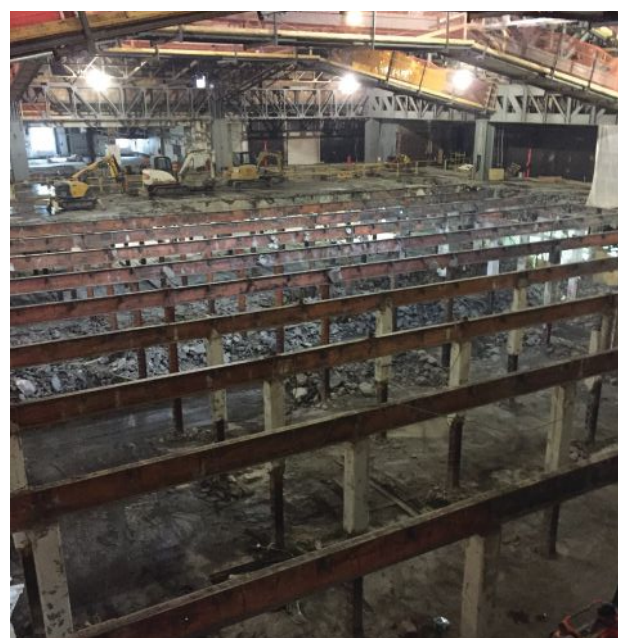

Old and New Trusses

Though many designs for a new roof were explored by the design team, led by architect SOM with structural engineer Severud Associates, the scheme that was ultimately selected reused three existing 150-ft-long steel trusses that were originally fabricated by Carnegie Brothers of Pittsburgh. The trusses, whose latticed members are reminiscent of the original Penn Station, had sufficient capacity to carry a new roof; the loading would be essentially unchanged. However, the chosen design placed four arched skylights on top of them.

Designed by SOM in collaboration with schlaich bergemann partner, the skylights each measure 50 ft by 150 ft and have a catenary profile. The structures are lightweight grids of steel tees, spaced at 3 to 4 ft on center, that vary in depth. The skylights are internally braced with in-plane diagonal cables and transverse “spiderwebs” of cables at the existing truss third points. However, in order to maximize their function and appearance, all of the framing between the trusses had to be removed. This left the gabled top chords unbraced along their full span. Fortunately, the trusses’ configuration facilitated their lateral reinforcement with steel box beams.

In addition to supporting the roof, the trusses had also served as overhead corridors with viewports through which postal inspectors could observe the workers below. Accordingly, each truss is composed of two identical and parallel bents spaced about 3 ft apart. The bents are tied together with diaphragm plates and latticed straps that terminate about 6 ft above the bottom chords to allow inspectors to pass. The truss cross section is, therefore, wider than might have resulted without the corridors. In fact, analysis showed that a 36-in.-wide by 24-in.-deep box of 3.5-inch-thick steel plates located along the top of each truss would provide sufficient lateral support without extending beyond the width of the existing chord members. As a bonus, the top of the box beams would provide an unobstructed bearing surface for the skylights.

The erector installed the steel boxes in multiple steps. The existing top chords consist of built-up I-shaped sections so first, fill plates supplied by fabricator L&M Fabrication and Machine were fillet welded on top of each to clear the rivet heads (often called cheese plates because of the holes punched in them). Next, the bottom of the box was lifted into place—by tower cranes on the north and south or mobile cranes on Eighth Avenue—in sections and fillet welded to the fill plates, and adjacent sections

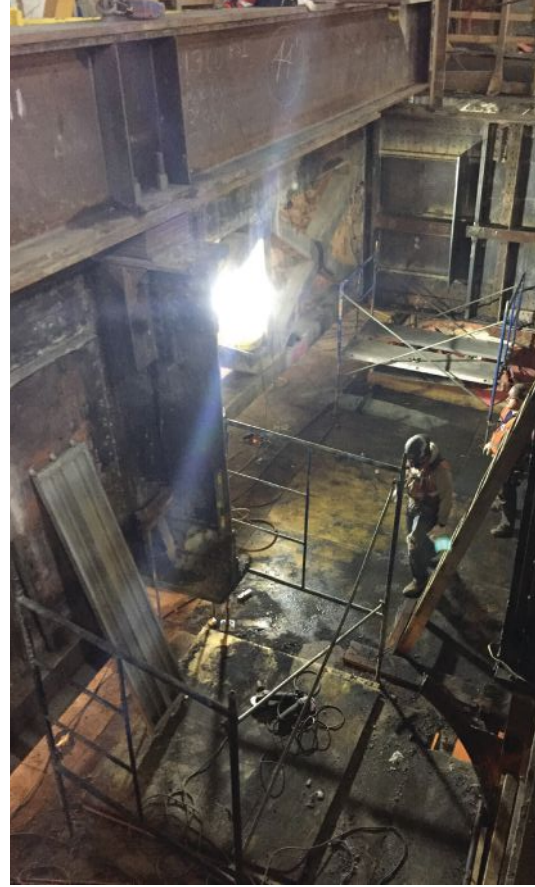

left: The selected design scheme reused three existing 150-ft-long steel trusses.

above and right: Constructing and reinforcing existing floor girders.

below: Installing the skylights.





above: A view of the escalator rigging through a finished opening.

right: Box beam truss reinforcement.

below: Box beam welds.



of the bottom plate were spliced with complete-joint-penetration (CJP) welds for continuity. The top and sides of the boxes were prefabricated in L&M's shop with intermittent partial-joint-penetration (PJP) welds and shipped to the site in sections. These were lifted into place and field welded to the bottom plate, again with intermittent PJP welds, with field welding of the upper box splices for continuity as the final step of the operation. In all, L&M fabricated 1,170 tons. All steel framing exposed to view was painted with a high-performance coating system.

Making More Room

Although the former sorting room is located directly over the railroad tracks, its floor was two levels higher, a condition less than ideal for platform access. The remedy was to remove the intervening level, which was framed with concrete slabs and steel filler beams and girders and posted up from the floor below. Demolition of the framing added 20 ft to the space's height, doubling the distance from the concourse floor to the spring point of the trusses and dramatically increasing the feeling of openness in the hall. And because the concourse framing transferred the weight of the demolished floor over the tracks, its capacity increased proportionally. This greatly simplified the design of the reframing that was needed to create openings for escalators.

The existing concourse level framing, fabricated by U.S. Steel, consists of 9-ft-deep steel plate girders spaced at 20-ft intervals and spanning up to 70 ft in the north-south direction, perpendicular to the platforms. The escalator openings are rectangular, with the long direction parallel to the platforms, so one existing girder typically had to be transferred and one notched to provide the required clearances at each opening. After the concrete slab was removed, temporary transfer girders were installed from above, bearing over the existing girders at each end. The girders to be removed were hung from the temporary transfer beams, and then the section that passed through the opening was cut out.

In some locations, the top of an existing girder had to be notched to allow the escalator and pit to pass above. In other locations, the bottom of an existing girder had to be notched to provide necessary clearance over the escalator below. In both conditions, reinforcing plates were welded to each side of the girder web around the notch before the



above, left, and below: The peaks of the steel-framed arched skylights in the main concourse rise to a lofty 92 ft above the floor.



web and flange were cut out. Next, permanent transfer girders were lifted into place in sections, spliced together with bolted moment connections, and bolted to field-welded shear plates to the web of the existing girder at each end. The temporary transfer girders were then removed, and sub-framing, such as escalator bearing beams, was added. Finally, the slab edges were replaced to complete the installation.

Where girders were notched for escalators near their midspan, reinforcement alone was not sufficient to restore necessary load capacity. In these cases, a column was added on one side of the notch, which extended from the underside of the girder bottom flange down to a new footing constructed underneath the platform below. Where girders were notched near their ends, a column was added if the notch interfered with the girder's bearing over the existing column that supported it. In some cases, the girder web was sandwiched between field-welded steel plates to increase shear capacity, and in many locations welds were added to the riveted connection to transfer the additional load.

Eleven escalator openings were created, ten of them within the boarding concourse and one to the south. The new escalators extend from the concourse floor down to the west end of Platforms 3 (one) and 4 through 8 (two each), thus providing access to Tracks 5 through 16—i.e., 12 of a total of 21 tracks. For these escalators, 21 existing girders were transferred, and 21 wide-flange steel columns—W14s or W10s with side plates—were added. A twelfth opening, north of the boarding concourse, was created for an escalator that connects to the West End Concourse. Steel for the concourse floor and escalator framing was fabricated by Crystal Steel Fabricators (which fabricated 4,150 tons in all) and was delivered by railcar or by truck and lowered through openings in the sidewalk vaults. From track level, pieces were moved into place using rigging from the existing framing.

A similar approach was followed for the intermodal Midblock Hall, located on the west side of the Train Hall, between Eighth and Ninth Avenues. The Midblock Hall connects the boarding concourse and other public spaces to canopied entrances at both

31st and 33rd Streets (it was constructed where the Farley loading dock canopy had once been located). After the 1933 annex was constructed, with steel fabricated by Bethlehem Steel, the building was extended west to Ninth Avenue, which left the dock isolated within the slot that was formed at the middle of the building. The canopy was removed and replaced with a skylight similar in width to those in the boarding concourse but longer, at 190 ft. There were no existing trusses in this location, so instead, W27 to W33 cantilever beams, spanning up to about 12 ft, were installed within the existing roof framing on the west side to transfer the skylight loads to existing columns. Along the east side, a row of new W14 steel columns was added.

Portions of the existing First Floor were also removed and reframed to form a grand stairway and escalators that extend up from the Concourse Level. (Crystal fabricated and installed this stairway and another entrance stairway, as well as five egress stairways and miscellaneous steel throughout the building.) While it is expected that Moynihan will receive most of its commuter traffic from the east, the less-traveled Midblock Hall allows travelers to enter the station from the west and at a more leisurely pace.

Moynihan Train Hall opened to the public on January 1, 2021—despite the potential for delays due to the pandemic—thanks in large part to the commitment of Governor Cuomo to realize and expand upon Senator Moynihan’s vision. It is hoped that as the number of commuters and travelers returns to normal, the station experience will be much more pleasant, even during rush hours. The first two phases of the overall redevelopment of the Farley Building are now complete, and work on the third and final phase—renovation of office and retail space in the original 1912 building and the 1933 annex—is wrapping up. Much of the space has been turned over to tenants, and fit-outs are in progress, with occupancy expected to be completed by the end of the year.

Penn Station ushered in a new era of rail transit in Manhattan in the early 20th century. Thanks to its elegant design, improved access and interconnectivity, state-of-the-art wayfinding, and other amenities, Moynihan Train Hall is repeating that feat for the 21st century. More than three times the number of passengers can now be comfortably accommodated than when Penn first opened, a pivotal first step in the Empire Station Complex megaproject. ■

Owner

Empire State Development (ESD)/
Moynihan Station Development
Corporation (MSDC)

Stakeholders

Amtrak and MTA Long Island Rail Road

Developer-Builder Team

A joint venture of Vornado Realty Trust,
The Related Companies, Skanska,
and architect Skidmore, Owings &
Merrill (SOM)

Structural Engineer



Severud Associates

Skylight Engineer



schlaich bergemann partner

Steel Team

Fabricators

Crystal Steel Fabricators/Crystal Metalworks
 Delmar, Del. (Primary)
 L & M Fabrication and Machine
 Bath, Pa. (Plate Reinforcement)

Detailers

Anatomic Iron Steel Detailing ,
 North Vancouver, B.C., Canada
 International Design Services, Inc. ,
 St. Louis



MiTek

SidePlate Connection Designs

now from MiTek

We united our offerings under the MiTek® brand, allowing us to serve you better. The same great SidePlate™ Connection Designs, and engineering services – now part of the MiTek® portfolio of solutions.

Get the SidePlate Connection Designs you trust and even more next-gen solutions at mii.com/sideplate.

MII.COM

Coat of Arms

BY WILLIAM D. CORBETT

KTA-Tator's new home is an homage to the company's coatings know-how and steel history.



William D. Corbett
(bcorbett@kta.com) is the
COO of KTA-Tator, Inc.

BUILDING A NEW HEADQUARTERS is always exciting for a company—and in the case of Pittsburgh-based coatings and consulting engineering firm KTA-Tator, Inc., it also provided the opportunity to show off a bit.

Specifically, the brand-new two-story, 48,000-sq.-ft facility provided an opportunity to put KTA's coating and steel expertise on display, hence the significant amount of exposed structural steel that was incorporated throughout the building.

A New Home

The company has called multiple Pittsburgh-area buildings home since it was founded in 1949 by Kenneth Tator. The first was Tator's basement in Coraopolis, Pa., and the most recent was an office/laboratory facility in nearby Findlay Township, which KTA leased for nearly 40 years. The company became employee-owned in 2010, and its leadership made the decision to move from leasing to owning. This led to KTA purchasing approximately 18 acres of land just to the west of Pittsburgh, developing approximately 50% of it, and building a new facility from the ground up. The construction team opted for the design-build delivery method, where the general contractor brought the architect and all



All images: KTA-Tator



above and left: The steel-framed roof screen is wrapped in the same metal panel system as the rest of the building.

below: Exposed steel, such as the bracing below, was a primary design focus for the design team.



subcontractors under a single contract. Despite a six-week mandated shut-down of all construction projects in the state in the spring of 2020 (due to the pandemic), the approach produced a project that came in on scope, on time, and below budget. This combination was accomplished by incorporating an open-book approach on all contract buyouts, a dedicated project team, and a well-managed project from inception to occupancy.

Given that steel was a significant piece of KTA's history and existence, as well as the company's Pittsburgh origins, it was a no-brainer to frame the new building

Why Exposed Steel?

A brief look into KTA's 70-plus-year history will help explain why the company valued exposed structural steel elements in the design of its new headquarters.

Kenneth Tator started the business in 1949 with his wife, Louise, in the basement of their home in Coraopolis, Pa. During those early years, Tator invented the KTA composite steel test panel, which was specifically designed to demonstrate the ability (or inability) of various coating materials to protect steel from corrosion when exposed to a variety of chemical and industrial environments. The composite steel panel contained 12 grading areas, including a welded channel, and served as a more realistic simulation (versus standard flat steel panels) of the complex industrial structures that coatings were expected to protect in the long term. The test panels, once coated, were mounted on galvanized steel racks at various chemical plants and industrial locations along the east coast and routinely evaluated for relative performance. Tator understood the value of steel as an important construction material for centuries to come, yet also knew that if it was left unprotected in certain environments, corrosion would destroy it. Without steel, the company would not exist as it does today.

Nearly 200 tons of structural steel, most of it exposed, was used to frame the building.

.....

with steel—again, much of it exposed. Despite the significant amount of exposed steel in the building, none of it was designed to architecturally exposed structural steel (AESS) requirements, thus avoiding the associated costs. In addition, no fire-protection coatings were necessary for the exposed steel since sprinklers provide sufficient protection per local code requirements.

For the general framing system, the columns are mostly HSS6×6×⁵/₁₆ and HSS8×8×⁵/₁₆ shapes. W18×40 and W16×26 beams frame the lab roof structure, W18×40s frame the second-floor office, W18×35s and W21×44s were used to frame the roof of the great hall, and W21×50s were incorporated for the office roof. Bay sizes ranged from 24 ft by 54 ft in the lab area to 24 ft by 34 ft in the office area.

The building incorporates a roof screen wall system using both welded and bolted connections. This screen wall was fabricated from hollow structural sections (HSS) using C-channel caps and was designed not only to provide an element to screen the rooftop HVAC equipment from view but to also appear to be a continuation of the building as it was wrapped in the same shaped Kynar-coated galvanized steel panel system as the rest of the building. Premium colors of weathered zinc and silver were selected to provide a distinct look to the building that changes as the sunlight moves across the exterior. In all, the building incorporates 184 tons of structural steel.

The facility houses nine laboratories totaling 7,000 sq. ft, a 3,000-sq.-ft instrument sales and service department, a climate-controlled calibration and repair laboratory, training rooms, and a combination of closed offices and open workstations, all with a view of the outdoors. The building's marquee space, the two-story Great Hall, facilitates the company's culture of collaboration in common spaces. This space, like many others throughout the building, features exposed structural steel elements (steel beams, trusses, columns, and diagonal supports). The design team also elected to leave all galvanized HVAC ducts unpainted to incorporate an industrial feel to the space. An exposed ceiling approach throughout the building further facilitates an open, industrial feel, except in climate-controlled laboratories, offices, conference/training rooms, and huddle rooms.

.....

The two-story Great Hall was a critical component of the building since the company promotes a highly participative culture and collaboration in common spaces.



Things are Heating Up at CMRP

Chicago Metal Rolled Products now offers Heat Induction Bending of carbon, stainless and alloy steel pipes – round, square or rectangular.

Consistent and high quality bends with:

- Limited wall thinning
- Limited Rippling
- Limited Ovality
- 24-hour lead time



Call us at
866-940-5739

When little to no wall thinning
and minimal ovality is mandatory.



**CHICAGO METAL
ROLLED PRODUCTS COMPANY**

CHICAGO • KANSAS CITY

cmrp.com



We bend ALL sizes up to:

We bend ALL sizes up to:

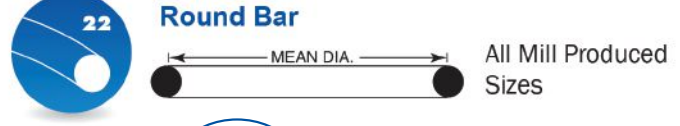
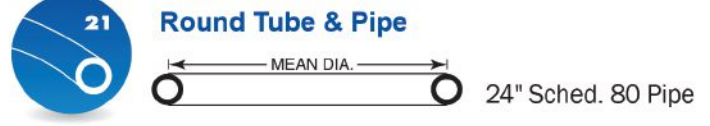
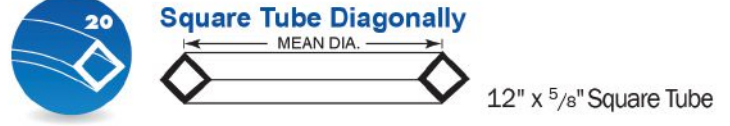
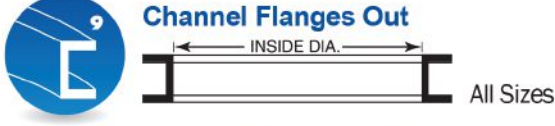
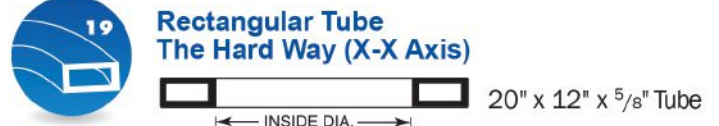
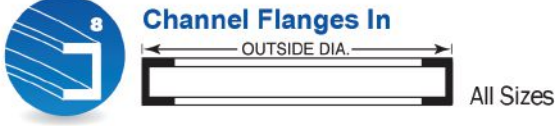
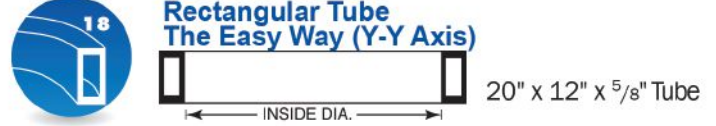
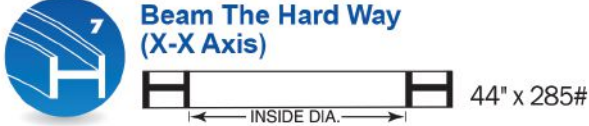
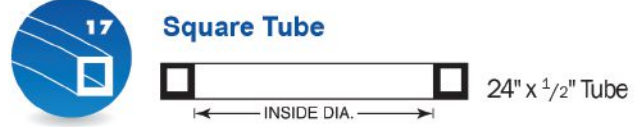
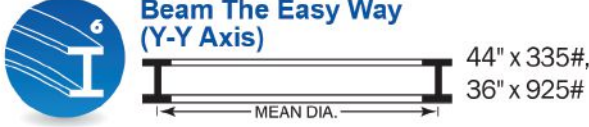
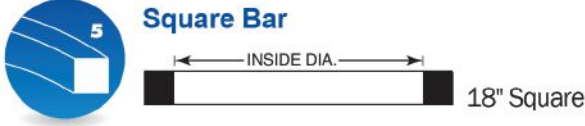
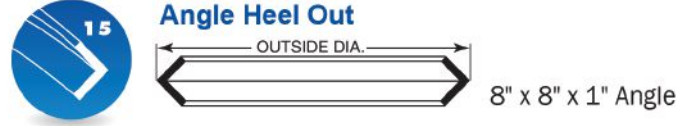
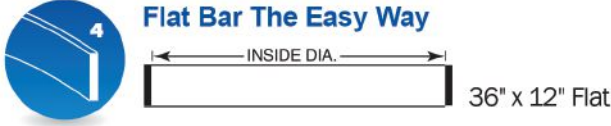
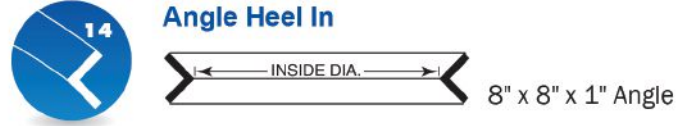
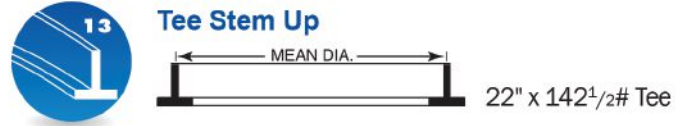
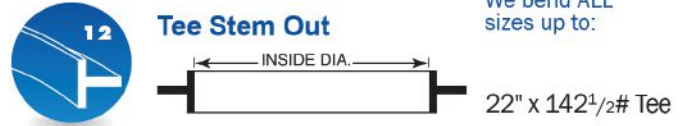

We also roll stair stringers, helical hand rails, off-axis bends, formed shapes and extrusions.

Visit cmrp.com for more information.



CHICAGO METAL ROLLED PRODUCTS COMPANY

CHICAGO • KANSAS CITY





Along with the exposed steel columns, beams, and joists, unpainted, galvanized HVAC ducts also provide an industrial feel.



Maximize storage spaces

SOLVE YOUR TOP 5 WAREHOUSE AND DATA CENTER PROJECT CHALLENGES

Go big with your next warehouse or data center project. Design spaces that optimize storage capacity. Steel joists and long-span floor and deck systems enable you to create expansive interiors that maximize usable space while meeting five challenges in warehouse and data center design and construction.

TOP 5 GUIDE SERIES | GET THE TOP 5 GUIDE
newmill.com/warehouse



NEW MILLENNIUM
 BUILDING SYSTEMS
 Building a better steel experience.

In addition, access to natural daylight for all employees was a key factor in the design of the building and the layout of the office space and laboratories. The architect was able to accomplish this by both shaping and placing glass where it would have the greatest visual impact, a strategy that creates the feeling that the glazing takes up much more of the building's façade than the actual 30%. Steel helped facilitate this as it allowed for larger bay spacing and placement of support columns that created longer clear spans within the lab spaces. The steel framing scheme also enhanced the daylighting desires of the design team by allowing more flexibility in the height and width of the windows and by not limiting where the windows could be located.

Simple Solutions

Like most design-build projects, there were challenges along the way, but all were easily overcome by having a strong project team focused on getting it right. The steel stairs and railings in the Great Hall were the most challenging items to fabricate, as the railing system was composed of many simple shapes that were joined together to create a very visually complex system. The structural components at the edge of the floor slab were pre-punched for railing connection bolts, so fabrication tolerances had to be maintained for the exposed fasteners to align without any manipulation in the field. The fact that the railing system was powder-coated prior to installation also added to the fabrication difficulty as field modifications could not be made during the installation of the railing system. But thanks to precise detailing, everything fit perfectly.



The building was designed so that the glazing area seemed much greater than its actual 30%, by placing glass where it would have the greatest visual impact.

Sequencing steel erection was also a challenge, and steel was delivered to the site in six sequences as needed—and laydown area wasn't an issue, given the ample space surrounding the building. That being said, since the footprint of the building itself was relatively widespread, the crane used to erect the steel—a 50-ton hydraulic crane with 150 ft of boom—had to be staged multiple times, with several of the staging locations being within the building's footprint as opposed to in adjacent areas. Close coordination between the general contractor, steel fabricator, and steel erector—not to mention the air traffic control tower at nearby Pittsburgh International Airport—ensured that steel erection progressed as scheduled.

Another issue that arose early on involved shop-painting the steel trusses. After fabrication, the trusses were dipped in a shop primer (a standard alkyd primer) and suspended to air dry in the same orientation as they were intended to be erected, which seemed like an intuitive approach. However, this caused substantial drips to collect on the undersides of the bottom angles. While these drips would typically have little to no impact on a project, there were two issues in this case. First, many of the trusses would be exposed to occupants and visitors. Second, KTA is a coatings consulting firm, and defects like excessive paint drips/build-up would be counter to the company's image. As such, the bottom angles of all exposed trusses were prepared using scrapers and power tools to remove any large paint drips and were spot-primed prior to applying the finish coat (a dry fall product) post-erection. The issue was easily solved and a lesson was

InfoSight
 Corporation
"We BARCODE Difficult Stuff™"
 100% Employee Owned
www.infosight.com
 +1-740-642-3600
sales@infosight.com

FABTECH
 Chicago, IL
 September 13-16
BOOTH A5144

Identification and Traceability Solutions for Galvanizers and Fabricators



KettleTag®PLUS



PaintTag™



ShotTag™



For More Information About Our Products



On-Demand Printing

InfoSight Means Innovation – For Identification And More.
 Our proven record of developing new products for customer's unique requirements means we can help you, too.

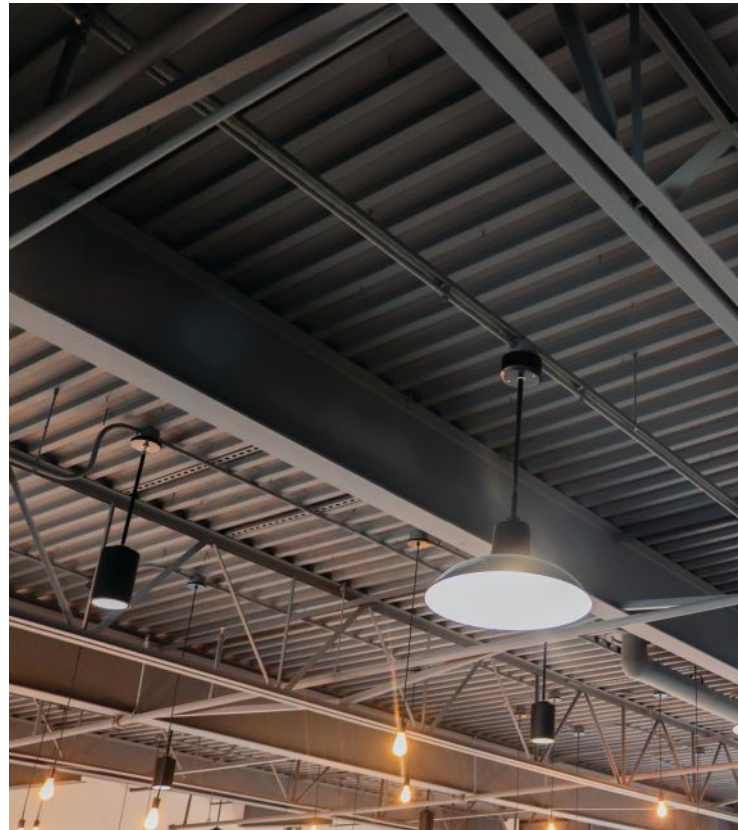
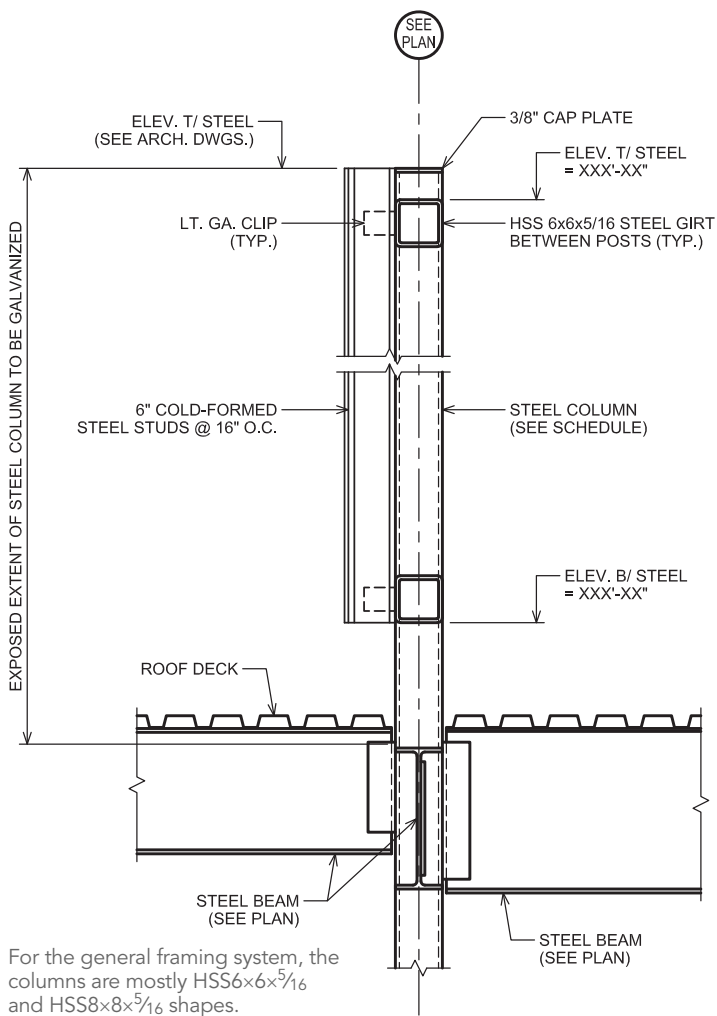

above: Ceilings, supported by open-web steel joists, were left exposed in much of the building.

- reiterated for future projects:
- Involve the fabricator early
- to make them aware of the
- intended end use—in this case,

The main entrance canopy plays homage to the welded steel channel on the company's signature metal panel.

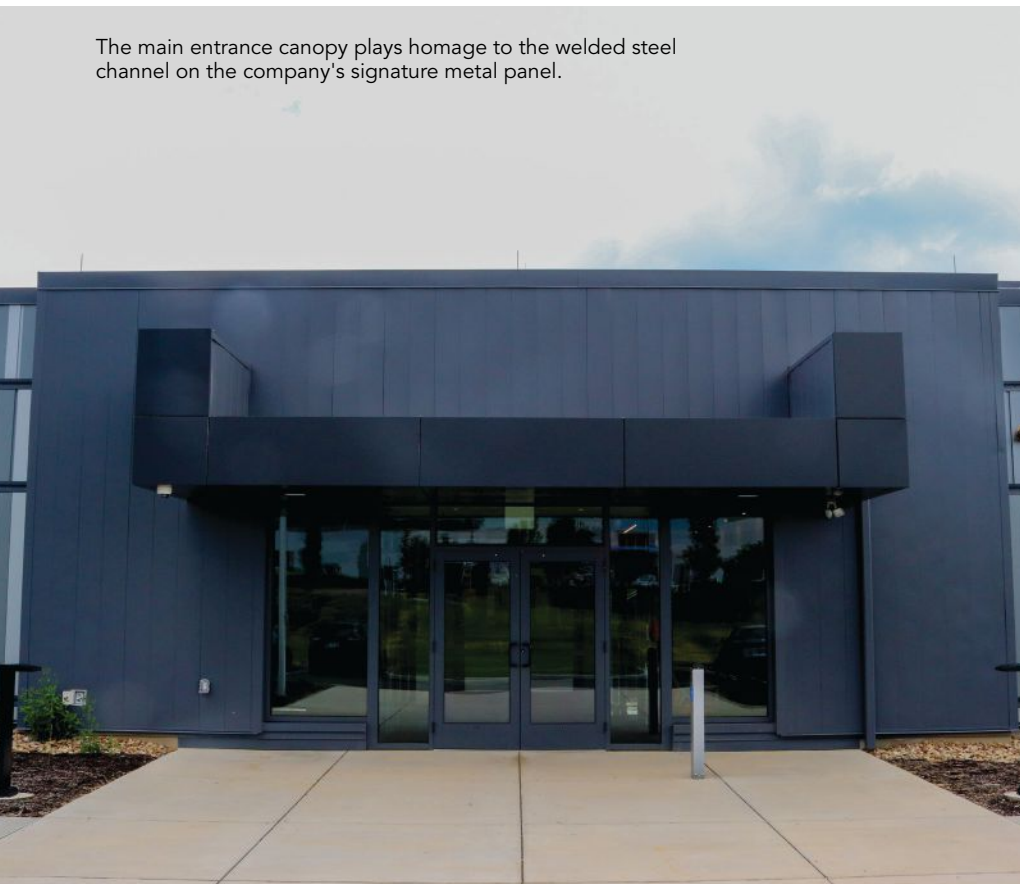



suspend the trusses upside-down during drying so that any paint drips would collect on what would be the topside, which would not be visible post-construction.

Now open, KTA's new headquarters puts the company's coating expertise on full display. And not only does the building pay tribute to KTA's steel history, but it also takes advantage of steel's benefits. ■

Owner

KTA-Tator, Inc., Pittsburgh

Acquisition and Project Management

Jones Lang LaSalle (JLL), Pittsburgh

General Contractors

Bear IC, LLC, Canonsburg, Pa.

Property Architect

Cannon Design, Pittsburgh

Structural Engineer

Taylor Structural Engineers, Pittsburgh

Steel Fabricator

Buckeye Steel Inc.  ,
Barnesville, Ohio



AISC's Need for Speed initiative recognizes technologies and practices that make steel projects come together faster. Check out aisc.org/needforspeed for more.

Connecting Conventioneers

BY JONATHAN HURFF, SE, PE, PhD, BEN CHEPLAK, SE, PE,
BRETT REICHARD, SE, PE, AND JACOB FRYE, PE



CHARLOTTE, N.C., has experienced significant growth in the past decade, bringing an increase in tourism and subsequent demand for more convention space.

The existing Charlotte Convention Center is the prime location for meetings, conferences, and exhibitions in the region due to its proximity to the Charlotte Douglas International Airport as well as being within walking distance to several sports venues and many amenities in the city's Uptown central business district. While the facility already included an impressive 280,000-sq.-ft exhibit hall, analysis showed that additional meeting rooms and pre-function spaces would increase its value and also accommodate more and larger events.

Given the center's location in a dense, urban environment, allowing little to no room for horizontal expansion of the facility, the City of Charlotte and the Charlotte Regional Visitor's Authority (CRVA) teamed up with architect tvsdesign to develop a vertical expansion concept to increase the meeting room and pre-function

space by 50,000 sq. ft. Not only does the design concept increase the leasable space, but it also transforms a previously utilitarian exterior along the Stonewall Street side of the facility into a prominent and inviting aesthetic. To further enhance the building's connection to the city, the renovation also introduces an iconic pedestrian bridge linking the center to the adjacent light rail station and development on the other side of Stonewall Street. The new convention center is scheduled to open by the end of the year and incorporated more than 1,400 tons of new structural steel in the expanded portion.

Steel Truss External Post-Tensioning

The structural engineering and construction challenges were numerous for such a unique convention center expansion. However, the most technically challenging aspect was also an enabling component: updating the existing 90-ft steel roof trusses for an enhanced role.

The Charlotte Convention Center leverages steel to add several new meeting rooms and an iconic pedestrian bridge.

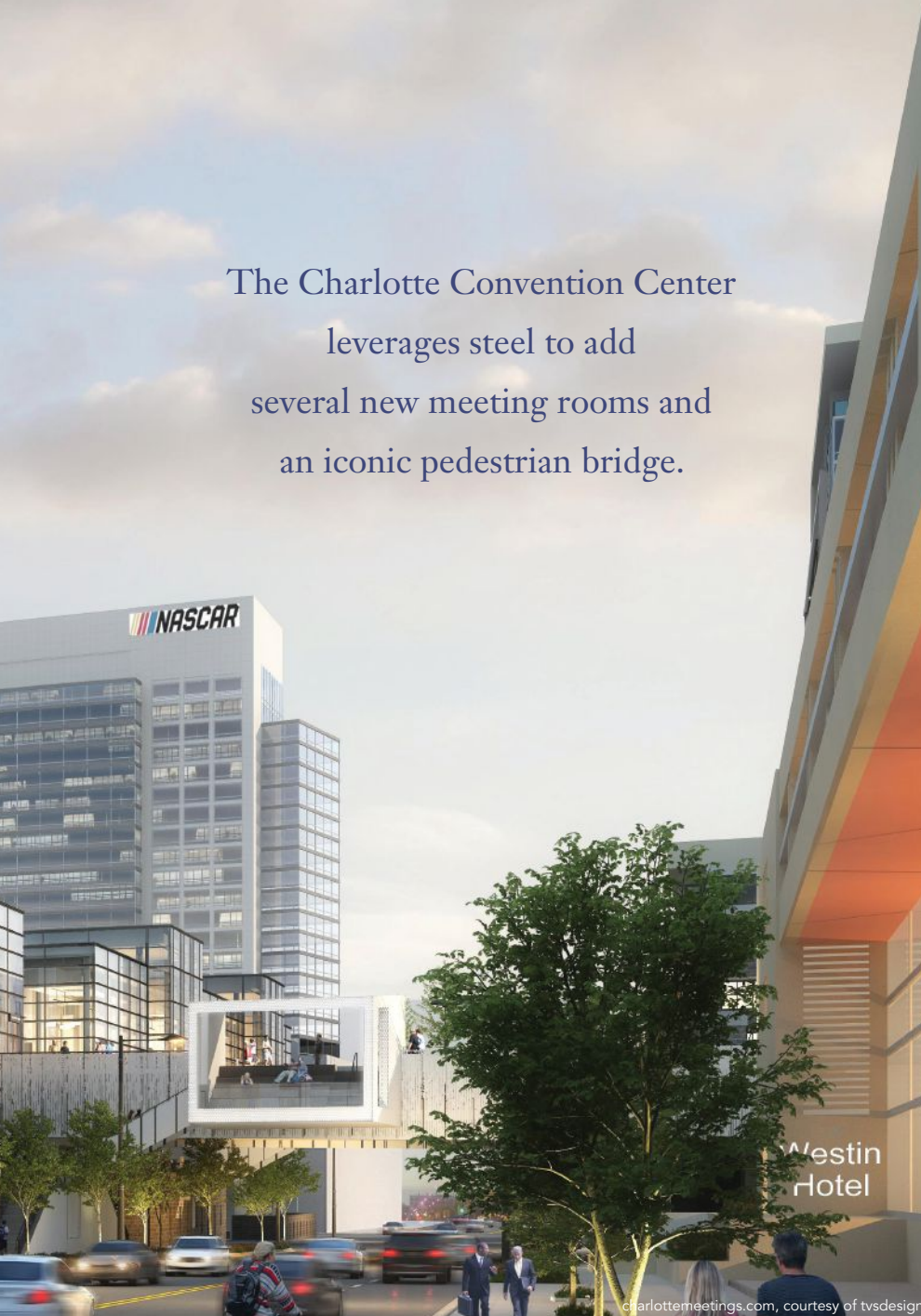

A rendering of the completed Charlotte Convention Center expansion.



Jonathan Hurff is a principal and project manager, **Ben Cheplak**, is a principal and office design manager, and **Brett Reichard**, is an associate and engineer, all with Walter P Moore's Atlanta office. **Jacob Frye** is a senior associate and project manager with Walter P Moore's Charlotte office.

These trusses span over the exhibit hall space below but, as part of the expansion, would now be required to support an additional concrete topping slab, additional superimposed dead load, and a new 100-psf occupancy live load. Several strengthening schemes were studied, including hanger systems—which would have required disrupting the new meeting room space to be structurally effective—and a brute force approach of adding a significant amount of steel plate with seemingly endless field welding. Several external post-tensioning concepts were also evaluated, with the initial solutions sharing the common theme of performing the tensioning from the top of one end of the truss. However, this approach would have required access in the form of demolishing the roof slab and corresponding cost increases, but more importantly, it also involved severing the building envelope undesirably early in the construction process.

The design team came up with a solution using a steel tension rod queen post truss system that straddled the existing truss. Tensioning of the rods was achieved simply by simultaneously jacking at the queen post locations from the bottom chord of the existing truss. The resulting solution solved the problem of accessibility when performing the tensioning operation, as well as used jacking forces much lower than the resulting tension force in the steel rods compared to traditional post-tensioning of the tendon. Furthermore,

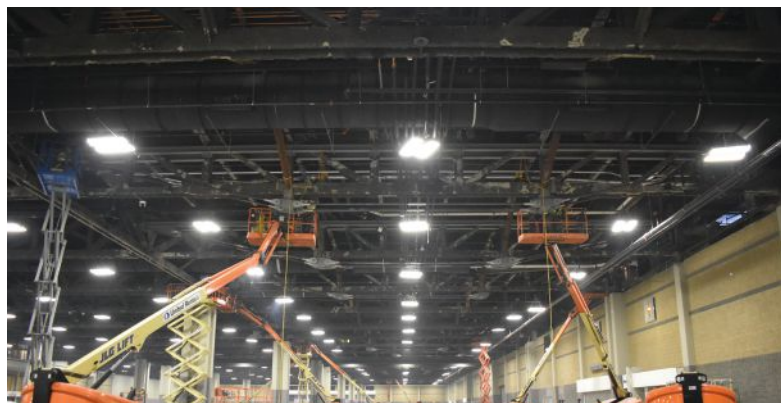
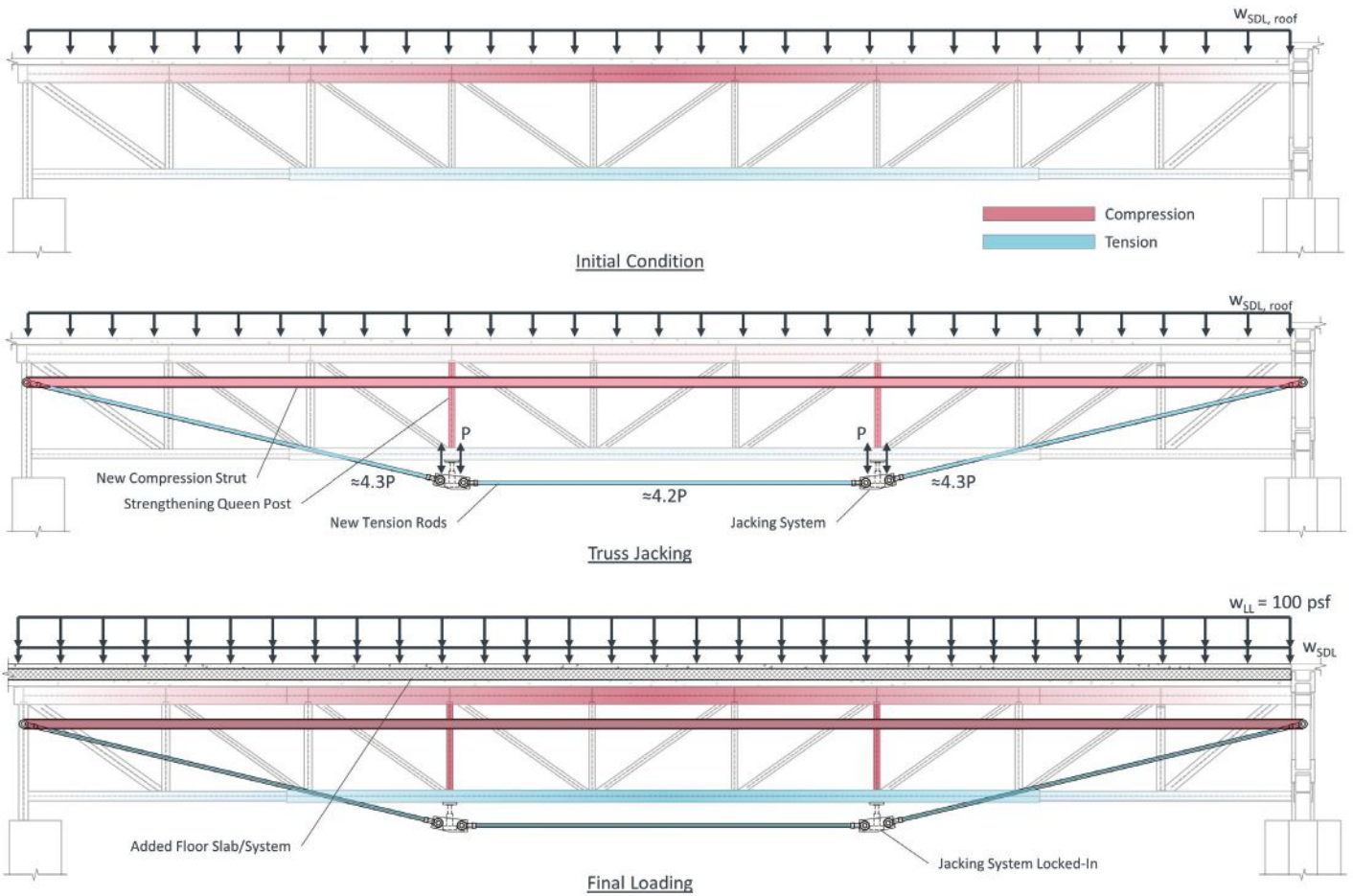

An initial group of externally post-tensioned trusses during construction.

above: The existing truss external post-tensioning load sequencing.

left: The beginning of vertical expansion construction after enabling strengthening work.

.....

this jacking process allowed for a direct understanding of the load relieved from the existing truss.

The steel rod post-tensioning system works by effectively relieving load from the existing truss by using hydraulic jacks to raise the existing truss while pushing down on the rods. Significant rod tension is induced from a relatively small jacking force. Although the system was jacked to a specific force, displacement predictions were used as a reference point to ensure the behavior was consistent with the analysis. After locking in the jacking points, the jacks are removed. Future loading, both dead loads, such as the concrete topping slab, and occupancy live load will load both the existing truss and the added queen post system as a function of stiffness through compatibility. Ultimately, the system resulted in efficient use of steel consisting primarily of 3-in.- to 3¾-in.-diameter Macalloy S460 rods with clevis systems, steel plate strengthening of the existing truss verticals at the two queen post locations, and a top chord compression strut on both sides of the existing truss. The compression struts were reasonably sized as W8×48s by detailing a connection at each truss vertical that braced the strut but also allowed longitudinal movement.



above: A hydraulic jack was used at external post-tensioned bottom chord queen post locations.

right: Truss girder strengthening using plating.

.....

The 90-ft filler trusses are supported by existing continuous truss girders also spanning 90 ft to create the typical exhibit hall column grid. Due to the strengthening needed and the continuity of the truss girders, a brute force steel plating-strengthening approach was taken. The steel plating approach required careful consideration due to the number of weld passes, which included both partial-joint penetration (PJP) and complete-joint penetration (CJP) welds. The welding was performed under a limited number of passes to limit the heat-affected zone of the existing W14 truss members. By strategically considering weld passes and locations, including coordination and review by the welding inspector, the team was able to avoid shoring during the welding process.



Not surprisingly, several bolted splices on the existing truss girders also required additional capacity. Because the existing splices were bolted splices, the splice strengthening was devised to emulate a bolted splice so that bolts and welds were not mixed at the same interface. The splice strengthening involved adding plates field welded to the existing W14 flange tips and non-contact lapped with the member strengthening performed on the flanges. A bolted splice plate was used to bridge the gap to the welded plates. To avoid the challenge of accessing the bolts when in place, the design drawings noted to bolt the splice plates together on the ground and hoist the entire bolted assembly in place prior to performing the field welds.



.....

Bolted splices were attached to truss girders prior to lifting them into place.

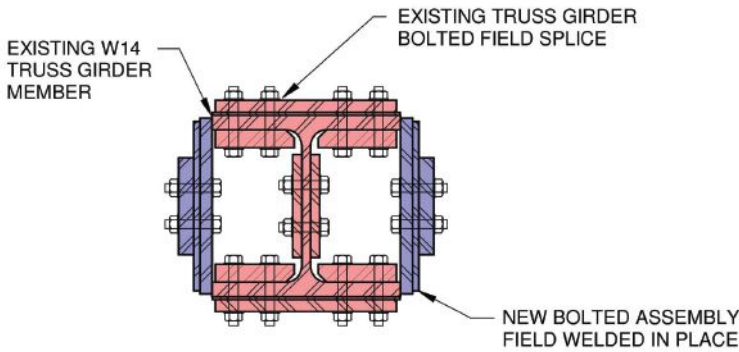

A bolted splice strengthener field welded to a truss.

Custom AESS Girts

Of course, the structural work for the vertical expansion included a significant amount of engineering and construction work beyond the truss strengthening. While many of the structural renovations will never be seen by visitors, exposed steel was strategically incorporated in several areas of the new construction to enhance the final aesthetic. One example is the custom architecturally exposed structural steel (AESS) wind girts that support the approximately 38-ft- and 30-ft-tall curtain wall systems.

The architectural team designed this exposed girt system to be low-profile and angular in nature. The resulting built-up section is comprised of hollow structural sections (HSS) and top and bottom plates, and the plate edges combined with the continuous AESS flare bevel welds concealed any semblance of a rounded corner. To address the low weak-axis stiffness of such a thin girt profile (3¼-in.-thick HSS10×2 plus two 5⁄8-in. cover plates), the Halfen DETAN Rod System was used for both the sag rods and the connection struts between the curtain wall mullions and the girts.

AESS 1: Basic Elements was specified for the girts; see "Maximum Exposure" in the November 2017 issue, available in the Archives section at www.modernsteel.com, for details on the various AESS levels.

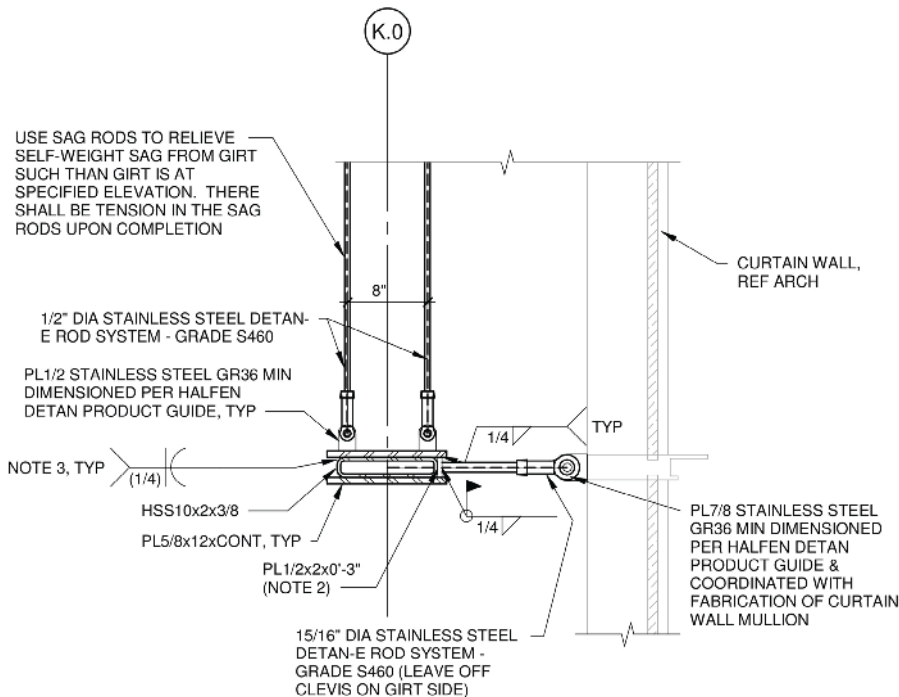

NOTES:

1. REFERENCE PLAN VIEW AND ARCHITECTURAL DRAWINGS FOR LOCATIONS OF SAG AND HORIZONTAL RODS.
2. CONNECTION PLATE LOCATED AT ALL ATTACHMENT LOCATIONS WITH THE HORIZONTAL ROD.
3. WELD TO BE CONTINUOUS FOR VISUALLY SENSITIVE GIRTS.
4. CUSTOM GIRTS AND SAG RODS TO BE AESS 1. CONNECTIONS TO COLUMNS WITHIN COLUMN WRAPS ARE NOT REQUIRED TO MEET AESS 1.
5. SIM CONDITION GLASS BOX: DETAIL THE SAME EXCEPT THE DISTANCE FROM GLASS AND LOCATION RELATIVE TO COLUMN LINE K IS DIFFERENT; REFERENCE PLAN.

1 CUSTOM GIRT AND SAG ROD DETAILS

1" = 1'-0"



Pedestrian Bridge Connector

The new pedestrian bridge connecting the convention center to the light rail station was designed to be an iconic addition to Charlotte's central business core. The primary structure consists of two

115-ft-long steel trusses with composite steel beam infill framing, with all elements selected to address the skewed footprint, non-parallel and irregular edge geometries, and the interfaces with the convention center, existing light rail station, and active light rail

- Custom AESS girts
- and a Halfen DETAN
- Rod System at the
- curtain wall mullions.



603-402-3055 • Automated Layout Technology™
Visit AUTOMATEDLAYOUT.COM for a Quote

The first automated marking machine created specifically for the **layout of commercial handrails, stair stringers** and so much more utilizing your steel detailer's dxf files.

- Cut Fabrication Time by More Than 50%
- Ensure the Highest Level of Accuracy
- Boost Your Profit Margins!
- Lay out complex geometry in seconds
- Designed to replace your existing fabrication table



"The guys love it. They jumped right in on it and have been working to make the most use of it. Great purchase."
Nat Killpatrick • Basden Steel Corporation

"I think it's fair to say that this machine continues to exceed our expectations. We are very happy with it."
Chief Operating Officer • Koenig Iron Works

"The machine is fantastic and could not be happier. Keep selling this machine, it's a winner."
Misc. Shop Foreman • Koenig Iron Works

Visit us at...



September 13-16, 2021
McCormick Place, Chicago, Illinois



charlottemeetings.com, courtesy of tvsdesign

above: A rendering of the completed pedestrian bridge.

below: Steel framing supporting the bridge and jewel box structure.



bridge. The most challenging portion of the bridge was also its most eye-catching element, a “jewel box” structure cantilevering 20 ft from the west edge. Three structural steel “pike” trusses were used to cantilever from the primary trusses by using the west truss as a prop and the east truss as the back span support. This level of “structural gymnastics” made structural steel the best material for the pedestrian bridge.

Given the nature of the bridge as a highly traveled pedestrian corridor, the cantilevered nature of the jewel box structure (which includes seating units), the long stair structure back to convention center terrace level, and the natural frequency of the structure, the design team performed several time-history analyses in SAP2000 using criteria and forcing functions established in AISC Design Guide 11: *Vibrations of Steel-Framed Structural Systems Due to Human Activity* (aisc.org/dg). (Revit and ETABS were also used for the structural design.)

Ultimately, steel was the perfect choice to bring together the existing structure with the new one-of-a-kind meeting room space it supports, as well as to connect the expanded facility to the city’s rail network. Its opening will be especially appreciated following the long period of social distancing and will provide an improved, expanded, attractive venue for the return of conventions. ■

Owner

City of Charlotte

Operator

Charlotte Regional Visitors Authority (CRVA)

General Contractor

Holder – Edison Foard – Leeper Joint Venture

Architects

tvsdesign, Atlanta
Neighboring Concepts, Charlotte
LS3P, Charlotte

Structural and Erection Engineer

Walter P Moore, Atlanta and Charlotte

Steel Team

Fabricator

C. M. Steel, Inc.  York, S.C.

Erector

Superior Rigging and Erecting Co., Inc.  Atlanta (truss tensioning)

Detailer

Greenbrook Engineering Services  Middlesex, N.J.



NVIDIA Corporate Headquarters, Santa Clara, CA
372 BRBs utilizing a combination of Bolted, Pinned, and Welded connections



American Welding Society®



INVEST IN YOUR FUTURE BECOME A CERTIFIED WELDING INSPECTOR

The AWS Certified Welding Inspector (CWI) credential opens doors to influence, advancement, and higher income potential. Preparing for the three-part exam is a must, and is now easier than ever, using a convenient AWS study option that meets your learning preference.

- ◆ 1-week, 40-hour in-person instructor-led
- ◆ 2-week, 80-hour in-person instructor-led
- ◆ 2-week, 80-hour online instructor-led
- ◆ 8-week, 80-hour online instructor-led
- ◆ Online self-paced

Learn more at aws.org/cwiedu.



AISC is 100! And we're featuring our longest continuously running member fabricators throughout 2021.

Century Club: McGregor Industries

BY GEOFF WEISENBERGER



Geoff Weisenberger
(weisenberger@aisc.org) is senior editor of *Modern Steel Construction*.

IN CELEBRATION OF AISC turning 100, throughout the year we're highlighting member fabricators that are even older than we are.

This month's century clubber is **McGregor Industries, Inc.**, in Dumore, Pa., which opened just after World War I and has been in the same family for four generations.

Answers provided by Grace McGregor Kramer, McGregor's vice president of strategy and operations:

How and when did McGregor Industries start?

McGregor Industries was founded in 1919 by my great-grandfather Robert S. McGregor to service Northeastern Pennsylvania's thriving coal industry as a miscellaneous steel supplier. Throughout our company's history, as the economy of the Scranton area changed, McGregor changed with it and began to focus on different geographic and product markets, eventually becoming experts in high-rise stair tower manufacturing and installation.

Your company has been able to weather challenges for a century. How has this helped you weather the current pandemic?

Like any challenge McGregor has faced over the past 100 years, the key to our success has been our team. Our employees immediately worked together to figure out ways to address the unique challenges of working during a pandemic while also getting creative about opportunities that might arise in the post-COVID construction world. For example, researching new market segments, helping businesses do quick HVAC upgrades (by supplying roof frames, dunnage, etc.), and doubling down on our core stair business.

CELEBRATING
100
YEARS
1921-2021





above: Grace McGregor and her father, Robert.

opposite page: McGregor's first facility.

below: Another recent McGregor project, a stair for MIT's Kendall Square Initiative.

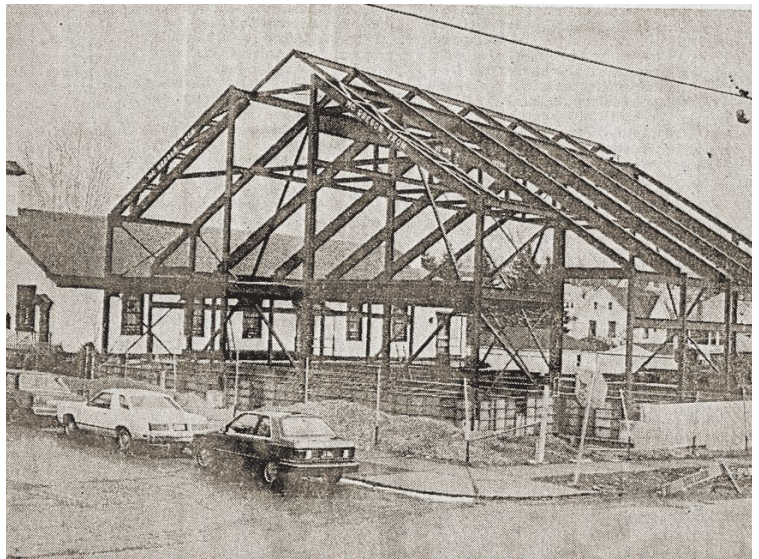

above: Immaculate Conception Church in Scranton, an early McGregor project.

below: McGregor's current plant when it was under construction, with a young Robert McGregor for scale.



What's the best business advice you've received from, or an anecdote involving, past leadership at the company?

To quote my dad (Robert McGregor, the company's president), "It really is about tolerating the bad times and innovating during the good times." I have been lucky enough to work alongside my dad for the last eight years, and in his words, experience has been the best teacher. A lot of my work at McGregor has been baptism by fire, and some of the best ways to learn and grow are through making mistakes and figuring out how to solve for the unexpected while thinking on my feet.

AISC is 100 this year. How long has your company been involved with AISC/taken advantage of its resources?

McGregor has been an AISC certified fabricator and erector since 2009 but has been using AISC's standards and manuals for much of our company's history. ■

For more content related to AISC turning 100 this year, visit aisc.org/legacy.



September 24, 2021

SteelDay USA

We're bringing SteelDay back better than ever in 2021! SteelDay, the nationwide celebration of America's structural steel industry, raises the profile of the fabricated structural steel industry as facilities across the country open their doors to design and construction professionals, elected officials, and the general public.

Join us for exciting virtual and in-person tours, presentations, and webinars across the country. To find an event or learn how to host visit

aisc.org/steelday



Join us at *The*
Flash
Steel
Conference

October 26–28

The three-day virtual program is back featuring multi-hour tracks containing 30-minute lightning sessions! Participants will enjoy:

- 20 short-format sessions taught by many of the industry's top speakers (Earn up to 10 PDHs!)
- A wide array of topics—connection, member, and system design, with important practical lessons from speakers who've seen it all
- Opportunities to interact, including panel discussions and message board forums

aisc.org/flash

CELEBRATING
100 YEARS
1921–2021

Transforming Education

BY NATHANIEL GONNER, SE

AISC Continuing Education is continuing to adapt to the new normal by offering new ways to learn.

AS THOSE OF US who have been working remotely since last spring begin returning to the office, whether every day or part-time, we're confronted with the question of which aspects of our remote work we should bring back with us and which workflows we should strive to retain from the pre-COVID era—with the hope that this new normal will meld the best of both and perhaps bring some new ideas.

Over the past year, AISC Continuing Education has been focused on approaching its mission of educating the structural steel construction and design industry with a similar spirit of reevaluation and creativity. Under the leadership of Christina Harber, director of education, and Brent Leu, manager of continuing education, that focus has yielded exciting results: a new technical conference with a flashy twist, courses with unique teaching strategies, and a soon-to-be-launched brand-new learning portal!

Essential Knowledge for the Busy Engineer

It was November 2019 when, in finalizing plans for the coming year, we committed to launching a new fall conference. The idea was to offer an attractive program, distinct from other AISC offerings, for those in the steel industry to share and acquire knowledge. It would be a relatively large event, anchoring the fall calendar and providing a counterweight to the similar technical exchanges that occur at the main event held every spring, NASCC: The Steel Conference. Another founding concept, thought to be novel at the time, was that this conference would be 100% *virtual*. Little did we know how commonplace virtual technical conferences would become by fall 2020!

But the new event's defining characteristic wasn't its virtual nature. Rather it was its short-session format, hinted at in the new conference's moniker: The Flash Steel Conference.

The inaugural edition of The Flash Steel Conference, held October 20–22, 2020, featured tracks, or subjects, consisting of three to five individual sessions of 30-minute duration. The goal was to increase flexibility for busy professionals to attend the conference in and around their typical workweeks of client demands and project meetings. A conference participant could choose to attend a track without needing to be committed to each individual session. Yet the information would be presented such that each of those 30 minutes contained a lesson unto itself.

Another notion behind the concept of shorter sessions was to explore the effect that lesson duration can have on our learning. Are there teaching benefits to reducing our lessons to shorter, more curated lengths? Is there an optimal session length for those learning amid a workday in the office? Are there efficiencies to be gained by refining the learning modules of a week-long conference? While the answers to these questions are likely very subjective, our hope is that increasing programming variety will help the overall community by reaching learners of all types and giving each of us access to varying learning opportunities.



Nathaniel Gonner (gonner@aisc.org) is a senior engineer with AISC Continuing Education.



above: A session from last year's Flash Steel Conference.

right: A slide from a 2020 Night School course in which students were able to open and use structural analysis software during the session.

You'll be able to check out this year's Flash Conference, which runs October 26-28. In addition to the 30-minute sessions, there will be panel discussions, online forums, and keynote addresses, and at least ten PDHs will be available to all participants. Visit aisc.org/flash for more information and to register.

Teaching Outside the Box

Of course, AISC's flagship education programs aren't going anywhere, and we will continue to offer three Night School courses each year and daytime webinars every month. And though these popular programs have been running for years (Night School is in its ninth year), you'll find no shortage of creativity from our instructors.

Take, for instance, "Modern Methods for Learning the Basics of Structural Stability: From Behavior to Practice," the fall 2020 Night School course taught by Ronald Ziemian, PE, PhD, professor at Bucknell University, and Craig Quadrato, PE, PhD, associate principal at Wiss, Janney, Elstner Associates, Inc., in San Antonio. This course featured what Ziemian calls "active learning." Course participants were granted access to the latest version of MASTAN2, the educational nonlinear analysis software developed by Ziemian and the late William McGuire, professor emeritus at Cornell University. For each topic presented, the participants were encouraged to execute (nonmandatory) learning modules using the software. Quadrato also worked through the learning modules and presented his solutions in the following session. Participants were able to open structural analysis software during the lessons, comparing their results to those of the

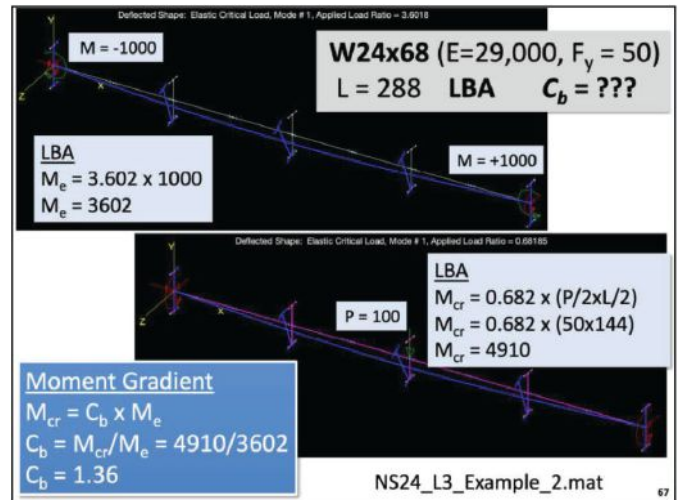

professors and making updates to their models in relation to the material as it was presented.

Ziemian and Quadrato also broke ground with their presentation style. In each session, both instructors had speaking roles, with one or the other taking the lead. The instructor in the second chair would chime in to ask questions and offer additional insights. It was not unusual for one of them to crack the other up with an engineering joke. The idea was to present something closer to famed NPR program *Car Talk* and further from the style of Ben Stein's character in *Ferris Bueller's Day Off*. With Ziemian and Quadrato's distinctive flair, the result was an engaging course offering participants a new method of learning.

Another example is on display in this summer's Night School course, "Developing an Eye for Connection Design—featuring an audience-driven curriculum," being presented by Larry S. Muir, PE,

president of The Steel Connection, LLC, and a consultant to the AISC's Steel Solutions Center. As the subtitle implies, the audience dictates the subject matter of a significant portion of this course. As a matter of fact, a full 25% of the material is being determined after the course began and based entirely on the questions that participants said they want to be answered. This concept is not conducive to advance planning, necessitating that the lesson plans and course materials be assembled quite close to the presentation date, but the payoff is instruction that is responsive to the participants' curiosities, with fewer instances of "That was great, but what I *really* wanted to know was..."

These are just two examples of AISC's programs taking an outside-the-box approach, each one tailored to the instructors' strengths and unique teaching ideas. Though we can be proud of these tried-and-true programs and have no intention of discarding what has made them successful, we're always excited to find opportunities to branch out to reach new minds and challenge old thinking.

A Portal to the Future

In another attempt to update how we educate our members, we are about to launch a new learning portal that will act as a personalized online dashboard, providing quick access to the programs for which you've registered. The courses will be displayed with intuitive navigation and streamlined access to the certificates you've earned, and a powerful search tool will span all the offerings, including conference proceedings, publications, and past webinars and courses. In short, this will be the new hub of steel education, and we will be launching it this fall.

Though not immediately evident in the new interface, the portal will unlock new program possibilities. New types of self-guided courses and webpages customizable to an office's specific needs are a couple of ideas being considered. These and other concepts not yet even imagined will be possible in the new environment, clearing the way for exciting future learning opportunities.

Over the past year, we've all had to adapt how we learn, work, and live. And with The Flash Steel Conference, new approaches to teaching, and our soon-to-be-live online education portal, AISC has taken steps to adapt and improve how we educate the structural steel community—and we hope you find these new resources and approaches beneficial. Visit aisc.org/education to learn more about any of them as well as peruse all of our educational offerings and options. ■

QUICKFRAMES

BOLT-IN & ADJUSTABLE RTU / HVAC
STEEL SUPPORT FRAMES



"GAME CHANGER!"

"EASY INSTALL!"

"QUALITY PRODUCT!"

"GREAT COMPANY!"

**"SAVES TIME &
MONEY!"**

GET PRICING & FAST QUOTES
QuickFrames.com

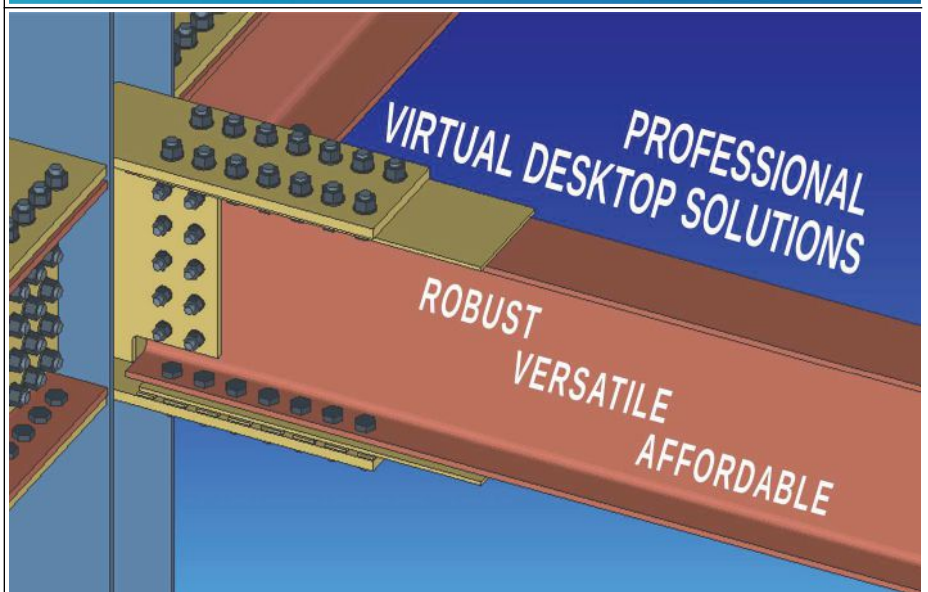

THE CLOUD SOLUTION FOR YOUR ENTIRE BUSINESS

EASILY COLLABORATE WITH YOUR TEAM OF
DETAILERS, MANAGERS, SHOP AND FIELD CREW

www.irysglobal.com
1 (877) 771-IRYS (4797)



2021 **HOT** PRODUCTS

Hot Products are here! While would-be 2021 NASCC: The Steel Conference attendees weren't able to see the latest structural steel industry innovations in person this year, for the second year in a row they were able to peruse them in a virtual exhibit hall as part of The Virtual Steel Conference.

.....

Here, we present this year's Hot Products, which represent the wide range of machinery, technology, and other products and services that bolster the structural steel industry.

HOT HSS CUTTER

Bend-Tech—Dragon A400

The Dragon A400 is a CNC HSS and pipe plasma cutter that processes round, square, rectangle, angle, and channel profile materials with a tolerance of +/- 0.010 in. The machine is ideal for automating the production of handrails and angle iron brackets quicker and with fewer errors and can produce thousands of feet of handrail efficiently and accurately.

For more information, visit www.bend-tech.com.

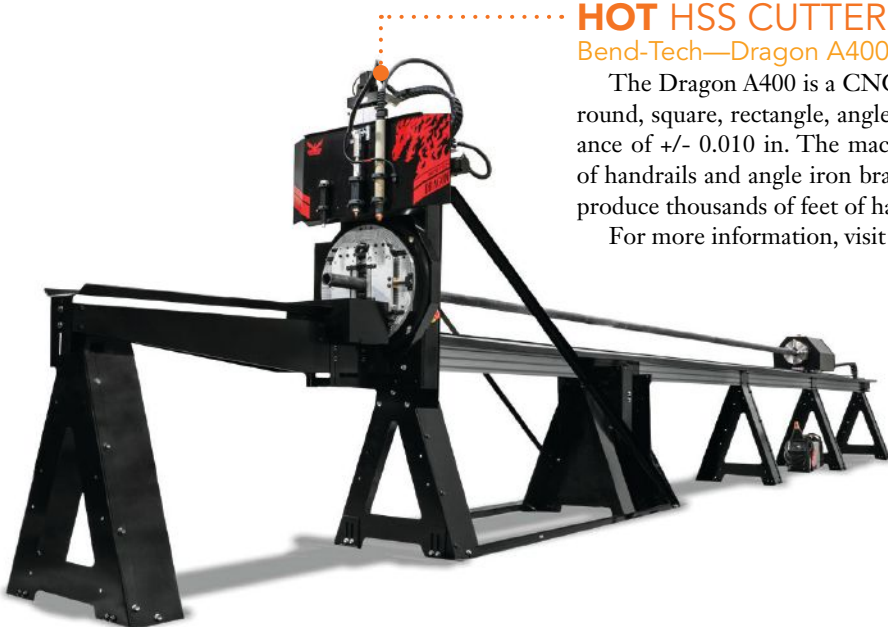

HOT STOCK CABINET

Voortman USA—
RED Tooling System

Voortman's RED Tooling System is a stock cabinet for storing the tooling and consumables you need for your operations. The system is equipped with smart software to give you insight and maintain your stock levels via a dashboard. The entire ordering process is fully automatic. When any portion of your stock needs to be replenished, Voortman will receive a notification and will send you the appropriate products.

For more information, visit www.voortman.net.



HOT WELD BACKING

Cerbaco, Ltd.—Flexback
Conformable Weld Backing

Flexback is a new pliable weld backing for CJP open root welding. The technology provides full support for a weld puddle and produces a symmetrical back bead while conforming to any geometry. Suitable for use with MIG, TIG, flux core, and stick electrode welding processes, this backing is designed for general-purpose use as well as unique applications where rigid ceramic backings cannot be used.

For more information, visit www.cerbaco.com.

All product, software, and service information was submitted
by the manufacturers/developers/providers.

This list does not constitute an endorsement by *Modern Steel Construction* or AISC.

HOT SUPPORT FRAMES

QuickFrames USA—Drop-in Frames

Drop-in Frames are a new, fully assembled version of QuickFrames' classic Adjustable structural support frames. Designed for fabricators and erectors who are accustomed to dropping in frames before the roof deck is down, the new frames deliver the convenience of fully assembled frames while still allowing for adjustability in the field, thus preventing some of the most frustrating hassles and expenses on new construction projects: changes in mechanical locations, measurements, and equip-

ment sizes. When traditional angle iron frames are welded in and changes occur, they must be cut out or abandoned. With Drop-in Frames, you can simply detach the rail system, attach new bolt-in connectors and install the frame elsewhere. Built to work with steel joists or beams with metal decking, the frames can save fabricators valuable shop time for more profitable projects rather than fabricating frames themselves.

For more information, visit www.quickframes.com.



xTEmbed

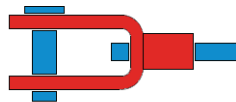

xTHangerRod

HOT PLUGINS

Steel Tek Unlimited, LLC—Tekla Plugins

SteelTek Unlimited offers three Tekla plugins. xTStair is designed to increase modeling efficiency for stair detailing, allowing multiple stringers, several types of end conditions, and several types of treads to be easily configured. xTEmbed provides the capability to model all of embeds, ledge angles, pour stops, door jambs, corner guards, trench frames, and more using plate, angle, channel, wide-flange, bent plate, and studs in almost any configuration. xTHangerRod is designed for easy modeling hanger rods with several types of clevises, turn-buckles, and couplers.

For more information, visit <https://steelteku.com/>.



HOT BOLT HOLDER

Atlas Tube—Shuriken

Enabling one-sided connections with standard ASTM F3125 Grade A325 or A490 bolts, the Shuriken Structural Nut Keeper is poised to accelerate steel construction by allowing field-bolted connections that were once impossible. Whether it's an HSS splice, box member connection, or even SpeedCore, Shuriken lets you bolt what you once had to weld. The disposable wrench holds a standard nut in places hands can't reach and is installed along with the nut in the shop, waiting to accept a Grade A325 or A490 bolt in the field. It's flexible enough to preserve erection tolerance but rugged enough to resist the torque required for slip-critical connections. Standard holes and standard tools mean that Shuriken fits seamlessly into your workflow, whether you're an engineer, fabricator, or erector.

For more information, visit www.atlastube.com.

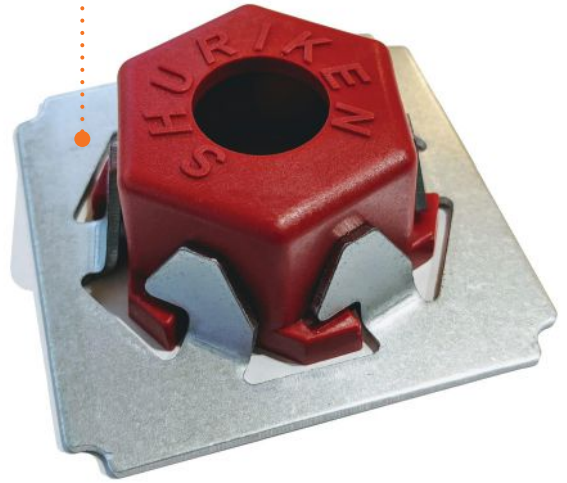

HOT CUTTING AND DRILLING EQUIPMENT

Ficep Corporation—1204 VL-RAZ

Ficep first pioneered the concept of integrating drilling and cartesian thermal cutting over 20 years ago. In 2021, the company has taken this concept a step further to introduce another industry first by integrating a Fanuc robot with a high-performance drilling line using sub-axis positioning. One integrated CNC control system is used to coordinate both the robotic plasma cutting operations and CNC drilling line capabilities. This powerful combination enables the selection of the most productive processes to be performed, and the system's patented independent sub-axis spindle positioning enables different operations to occur simultaneously even if the operations are offset. The system also integrates Ficep's "Intelligent Steel Fabrication," where complementary material-handling operations are totally automated and are not controlled by an operator. The material handler just loads the stock length material and scans the bar-coded cut list, and the system automatically conveys the material to the system, loads the required program, and conducts the required thermal cutting operations, drilling, scribing, and milling. While these processes are conducted, the material-handling system executes all the required functions without operator involvement.

For more information, visit www.ficepcorp.com.



HOT ROBOTIC ASSEMBLER

Abka Automation—Agen Duo Robotic Structural Steel Assembler

Agen Duo is a fully automatic structural steel assembler that uses two industrial robots. The handling robot carries a magnetic gripper and laser scanner and can carry plates or add parts up to 400 lb. Optionally, it can carry a stud welding unit. The welding robot uses high-accuracy sensors to measure a profile's geometric properties and also welds with high quality. It also has multi-pass weld support.

For more information, visit www.abkaotomasyon.com.

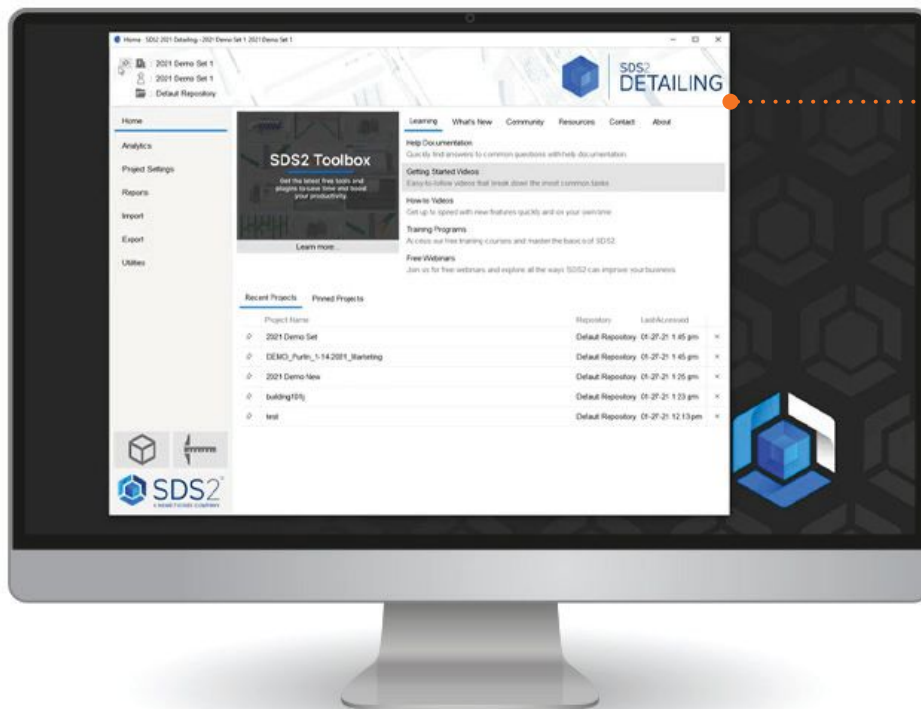
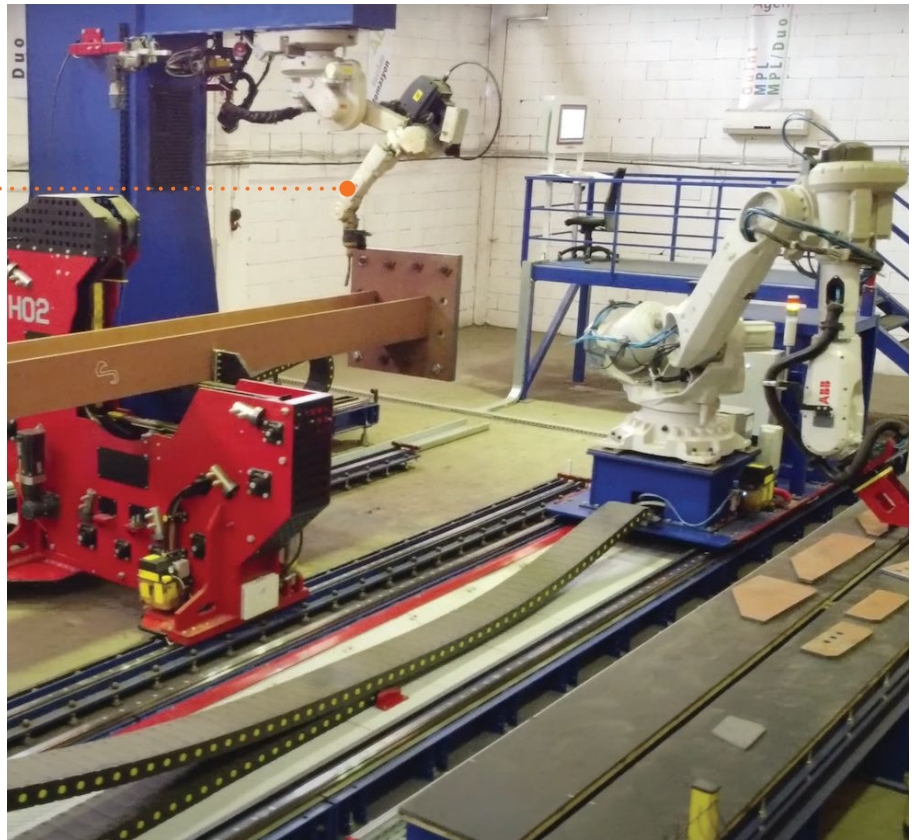

HOT INTERFACE

SDS2—SDS2 Detailing

SDS2 2021 brings the company's user interface and experience up to speed with its modeling capabilities. Featuring a fresh, modern look, the new interface marks a major step forward in accessibility, intuitive interaction, and ease of use for SDS2. The simplified home screen, searchable project settings and tools, role-based and contextual ribbons, fine-grained control over modeling window colors, and quick access sidebar for pinned and recently used tools allow users to streamline their workflows and maximize fabrication and erection efficiencies. All updates were designed to give users control of their SDS2 experience with the right tools at their fingertips.

For more information, visit <https://sds2.com/sds2-2021>.



HOT LIGHT TOOLS

Hy-Tech Machine, Inc.—ATP Magnum Steel Force Air Impact Tools (7527 Series)

ATP Magnum Steel Force Air Impact Tools weigh just 13.5 lb (or roughly 40% less than the most popular impacts used in structural steel assembly applications today) and provide significant ergonomic benefits to operators.

For more information, visit www.hy-techinc.com.

HOT LAYERS

AGT—LayoutMaster

With no measuring or marking required, one operator using the LayoutMaster can be as effective as two to four fitters. With full-color projection and highly customizable layers, you can train any operator to become your best fitter in a matter of hours. The machine features more than 30 different features—including part 3D contours, holes, hole centers, welding information, and part numbers—that can be laser-projected onto a beam or other accessories.

For more information, visit www.agtrobotics.com/layoutmaster.

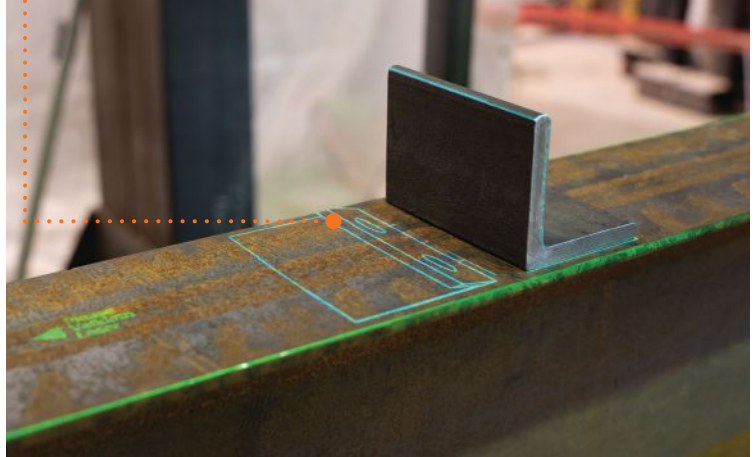

HOT TAG

InfoSight—PermaFlex

The PermaFlex metal tag is malleable, allowing it to conform to curved shapes as small as a 1 in. in radius and can survive high temperatures, abrasion, ultraviolet exposure, and chemical exposure. The tag works with adhesive to maintain the curve of the product, remaining attached under harsh conditions. The message data will remain readable by people or electronic scanners, as the laser marking includes high-contrast alphanumeric characters, logos, and 1D or 2D barcodes that won't wear off or fade. All of InfoSight's tags, including PermaFlex, are printable on one of the company's LabeLase Laser Metal Tag Printers.

For more information, visit www.infosight.com. ■



news & events

CONNECTIONS

AISC Offering \$5,000 Prize for Next Great Idea in Connections

The Steel SpeedConnection Challenge is looking for the next great idea in connections, and there is \$5,000 on the line for the best concept!

Standard shear connections have long been used for the majority of steel beam and column connections, as they are viewed as easy and economical. But what if we can do it better?

The keywords are FAST and EASY—to design, fabricate, and erect safely. We welcome all participants with a spark of inspiration. Your outside-the-box idea could revolutionize the entire industry!

To register for the challenge, visit herox.com/speedconnectionsteel and click the “ACCEPT CHALLENGE” button.

The SpeedConnection project—part of AISC’s “Need for Speed” initiative aimed at increasing the speed of steel construction by 50% by 2025—aims to provide speed improvements for how buildings can be erected related to connections. This transformative effort’s overarching goal is to develop a solution that ‘changes the world’ for steel connections.

FORGE PRIZE

Emerging Architects: Get the Industry Recognition You Deserve—and Win \$15,000!

Are you an up-and-coming architect? Then we want to hear about your creative vision of the future. The fourth annual Forge Prize competition is now accepting entries!

The competition, established by AISC in 2018, recognizes visionary emerging architects for designs that embrace steel as a primary structural component and capitalize on steel’s ability to increase a project’s speed.

U.S.-based architects who are either currently seeking licensure or have been licensed for fewer than ten years may enter online at www.forgeprize.com.

Three finalists will each win \$5,000. They’ll work with a steel fabricator to refine their concept before stepping into

the industry spotlight to present their concepts live to the judges—and the world—on YouTube.

The winner will take home an additional \$10,000 and be invited to present their design to the industry at the Architecture in Steel conference, which is incorporated in NASCC: The Steel Conference, in Denver next March.

Entries are due by October 31, 2021.

Hunter Ruthrauff of T.Y. Lin International Group in San Diego took top honors in the 2021 competition with a stunning 3D-printed steel pedestrian bridge. Visit forgeprize.com/2021-winner to learn more about Ruthrauff’s design.

People & Companies

Nucor Corporation president and CEO **Leon Topalian** is taking on a prestigious new role—chair of the **American Iron and Steel Institute (AISI)**. This past May, the AISI Board of Directors elected Topalian to serve for a two-year term, replacing outgoing chair **John Brett**, CEO of **ArcelorMittal North America**. In addition to electing Topalian as chair, AISI elected outgoing chair Brett and **Chuck Schmitt**, president of **SSAB Americas**, as vice-chairs.

The **American Society of Civil Engineers (ASCE)** has elected **Maria Lehman, PE**, president for the 2022–2023 term. Currently serving as the Society’s national treasurer, Lehman has been actively involved in ASCE leadership roles for nearly 40 years, since she co-founded the **Northeast Region Younger Members Council** in 1983. She will replace 2022 president **Dennis D. Truax, PE, PhD**. The current president of ASCE is **Jean-Louis Briaud, PE, PhD**, who will serve until Truax takes office this October.

John D. Hooper, SE, PE, senior principal and director of earthquake engineering at **Magnusson Klemencic Associates (MKA)**, has been elected to the **National Academy of Construction (NAC)**. This honor recognizes Hooper’s contributions to advancing building design in seismically active areas. Throughout his career spanning more than 35 years, Hooper has made innumerable contributions to the field of seismic design, especially in the development of performance-based seismic design methodologies and the advancement of code-prescriptive seismic design approaches. Hooper is involved in several **AISC** committees: Task Committee 3 (Loads, Analysis, and Stability), Task Committee 5 (Composite Design), and the Committee on Specifications; he is also the chair of the ad hoc Task Group on Seismic Analysis and was recently honored with an AISC Lifetime Achievement Award.



IN MEMORIAM

Gordon Finch, Founder of Kansas City Regional Steel Fabricators Association, Dies at 94

Gordon Finch, known for his role as president of AISC member fabricator Builders Steel and for connecting Kansas City-area steel fabricators, died May 3 at the age of 94.

Finch's contributions to the Kansas City Regional Steel Fabricators Association and to the wider steel industry led the AISC Board of Directors to present him with a Lifetime Achievement Award in 2009.

After observing many Kansas City general contractors touting concrete frames over steel frames in the mid-1970s, Finch reached out to five other local fabricators and convinced them to join together under the common goal of resurrecting the local steel industry. In 1976, this partnership, which is now known as the Kansas City Regional Steel Fabricators Association, solidified, with Finch serving as its first chair.

Under the main purpose of promoting the use of structural steel, the Association provided ample educational opportunities to the area's structural engineering community. Finch organized two breakfast meetings per year and brought in many guest speakers and local engineers and fabricators, many of whom went on to develop strong networking relationships with each other. In addition to the breakfast meetings, the Association also hosted programs on topics like certifica-

tion, arranged tours of fabrication shops, assisted students at area universities who competed in the Student Steel Bridge Competition, and funded educators' trips to NASCC: The Steel Conference.

The Kansas City Regional Steel Fabricators Association experienced such success that it inspired the founding and programming of many other local fabricator organizations.

Finch's engineering career spans back to when he was drafted into the military in 1945 and started training in engineering and design. After serving, he became an architectural engineer at Builders Steel and eventually rose to president—and even after he retired in 1991, Finch remained occupied with consulting work for many other companies.



Gordon Finch (left) with Thomas Murray (center) and Fred Havens, president of Havens Steel Company (right), at a breakfast meeting sponsored by the Kansas City Regional Steel Fabricators Association.

MILEK FELLOWSHIP

AISC Now Accepting Applicants for 2022 Milek Fellowship

University faculty are invited to apply for the AISC's 2022 AISC Fellowship starting August 1, 2021. The Milek Fellowship is a four-year fellowship given to a promising university faculty member to conduct structural steel research. The awarded faculty member will receive \$50,000 per year (for a total of \$200,000) as well as free registration to NASCC: The Steel Conference for the four years following their selection as an AISC Milek Fellow.

The Milek Fellowship program is

designed to contribute to the research careers of young faculty who teach and conduct research investigations related to structural steel while producing research results beneficial to steel designers, fabricators, and erectors. The program is also intended to support students with high potential to be valuable contributors to the U.S. structural steel industry, and the selected faculty member is required to fund a doctoral candidate with at least half of the fellowship money.

Recent recipients include William Collins from the University of Kansas for his work on innovative steel bridge deck systems, Matt Yarnold from Texas A&M University for his work on rolled asymmetric steel beams, and John Judd from BYU for his work on inelastic design methods for steel buildings subjected to wind loads.

Proposals will be accepted until September 15, 2021. For application information, visit aisc.org/milek.

news & events

SSBC AISC Announces 2021 Student Steel Bridge Competition Winners

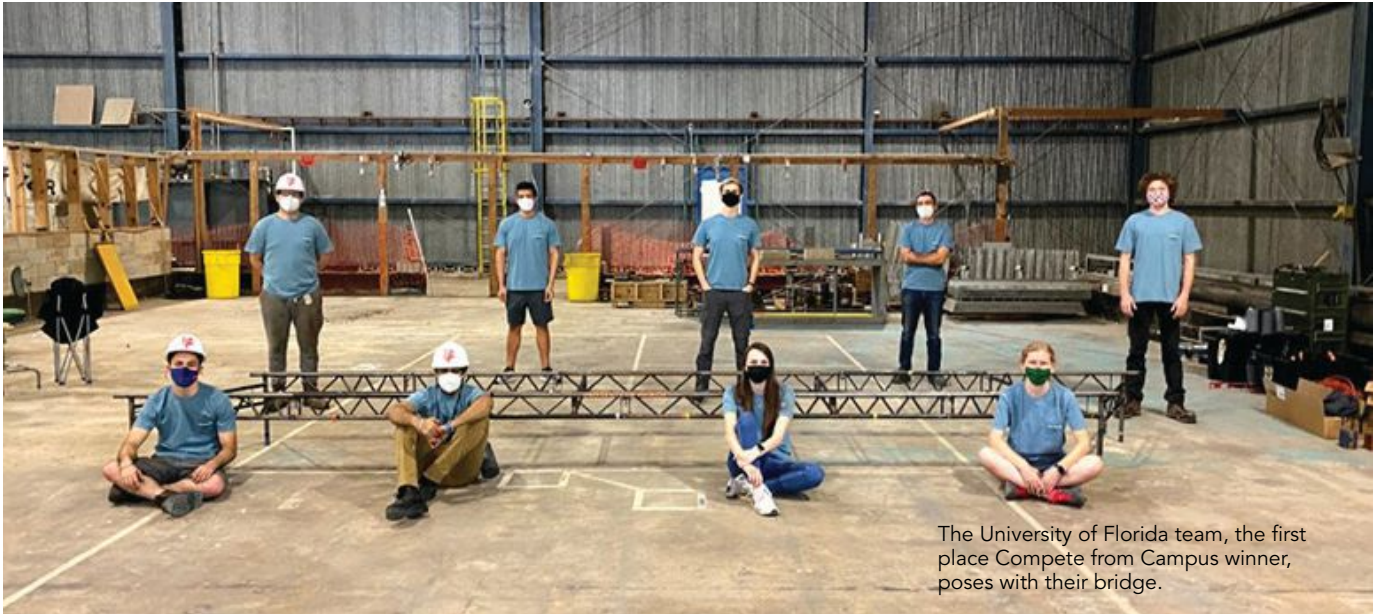

The University of Florida team, the first place Compete from Campus winner, poses with their bridge.

More than a thousand student engineers at 102 colleges and universities around the country pulled off a remarkable feat this year: They safely participated in AISC's Student Steel Bridge Competition (SSBC), either competing from their own campuses with a fabricated and constructed physical bridge, entering a design-only Supplemental competition, or both.

AISC recently announced the results of the national finals, which included 31 of those schools. The Oregon Institute of Technology took first prize overall in the Supplemental competition, and the University of Florida came out on top in the

Compete from Campus finals.

"I'm so incredibly impressed with you," AISC's director of education, Christina Harber, told students in a webcast. "You overcame many obstacles to participate in the competition this year. You probably had a full plate this year with your usual classes and activities, plus many atypical challenging situations. And you chose to participate anyway—not just participate. You excelled."

Instead of meeting at regional or national events, Compete from Campus teams individually assembled their bridges under the same competition regulations that would

have applied at an in-person competition. Industry experts volunteered their time to actually visit campuses and judge the bridge builds; other aspects of the Compete from Campus competition were judged remotely. The Supplemental competition entries consisted of engineering reports and videos, all of which could be judged remotely.

This year marked the national finals debut of both the University of Massachusetts Amherst and the University of Texas at Tyler. The University of Wisconsin-Madison has the longest streak of nationals participation, qualifying for more than 20 years. Here are the 2021 winners:

Supplemental Competition

Design

- 1st place: Oregon Institute of Technology
- 2nd place: University of California, Berkeley
- 3rd place: The George Washington University

Analysis

- 1st place: Oregon Institute of Technology
- 2nd place: University of California, Berkeley
- 3rd place: Michigan Technological University

Construction sequencing

- 1st place: Oregon Institute of Technology
- 2nd place: University of California, Berkeley
- 3rd place: California Polytechnic State University, San Luis Obispo

Video

- 1st place: University of California, Berkeley
- 2nd place: Oregon Institute of Technology
- 3rd place: California Polytechnic State University, San Luis Obispo

Public vote

- 1st place: University of California, Berkeley
- 2nd place: Oregon Institute of Technology
- 3rd place: University of Massachusetts Amherst

Overall

- 1st place: Oregon Institute of Technology
- 2nd place: University of California, Berkeley
- 3rd place: Michigan Technological University

Compete from Campus

Aesthetics

- 1st place: University of Puerto Rico–Mayagüez
- 2nd place: Oregon Institute of Technology
- 3rd place: University of Alaska Fairbanks

Construction speed

- 1st place: University of Florida
- 2nd place: Lafayette College
- 3rd place: Youngstown State University

Lightness

- 1st place: University at Buffalo
- 2nd place: California State Polytechnic University, Pomona
- 3rd place: University of Wisconsin–Platteville

Construction economy

- 1st place: University of Florida
- 2nd place: Lafayette College
- 3rd place: Youngstown State University

Structural efficiency

- 1st place: University of Wisconsin–Madison
- 2nd place: University of Wisconsin–Platteville
- 3rd place: University at Buffalo

Overall

- 1st place: University of Florida. *This prize includes \$5,000 in scholarship funds.*
- 2nd place: Lafayette College. *This prize includes \$3,000 in scholarship funds.*
- 3rd place: Youngstown State University. *This prize includes \$2,000 in scholarship funds.*

Robert E. Shaw, Jr. Spirit of the Competition Award

This prize recognizes a team that demonstrates outstanding camaraderie, professionalism, positive work ethic, and respect for their peers. It includes \$1,000 in scholarship funds.

University of California, Berkeley, for their deep enthusiasm for the competition and the support displayed for their teammates.

Frank J. Hatfield Ingenuity Award

This prize recognizes the team that shows the most engineering ingenuity in the design and/or construction of their bridge, based on the requirements of the competition rules. It includes \$1,000 in scholarship funds.

University of Alaska Fairbanks, for their unique truss with splayed ends, featuring offset top chord and web members and connection to the bridge piers as well as an innovative twist-lock connection.

BRIDGE GIRDER DRILL

Vertical & Horizontal Models

Portable | Laser - Guided | Custom Sizes

Controlled Automation
www.controlledautomation.com | 501.557.5109

MADE IN USA

BRIDGE NEWS

I-40 Bridge Phase 1 Repair Completed only Two Weeks after Fracture Discovered

On May 11, 2021, a partial fracture of the steel tie-girder box section was discovered during a routine visual inspection of the Hernando DeSoto Bridge, which carries I-40 over the Mississippi River between West Memphis, Ark., and Memphis, Tenn. After inspectors from Michael Baker International found the fracture, Arkansas and Tennessee Department of Transportation (ADOT and TDOT) officials closed the bridge to vehicular traffic, and river vessel traffic below the bridge was restricted by the U.S. Coast Guard. The bridge, which opened in 1973, carries approximately 60,000 vehicles a day.

The main portion of the bridge over the Mississippi River consists of a continuous two-span steel tied-arch truss; each span is 900 ft long. The tie-girder box beam is comprised of four Grade 100 steel plates with 32-in. by 1³/₈-in. web plates and 25-in. by 1/2-in. top and bottom flange plates, and the fracture impacted 100% of the outboard web plate, 100% of the top flange plate, and approximately 20% of the bottom flange. The steel type used in the tie-girder box beam, commonly referred to as “T-1” steel, is no longer used in modern-day bridge applications. It should be further noted that the Hernando DeSoto Bridge was designed and constructed well before the material and fabrication requirements of the AASHTO/AWS Fracture Control Plan were adopted by the industry in 1978.

Tennessee DOT is leading ongoing repair efforts, with Michael Baker International developing the repair design plans. On May 14, 2021, the Coast Guard was able to lift the waterway restriction based on information provided by

the Tennessee DOT. A two-phased approach has been established where Phase 1 repairs will stabilize the bridge and allow for the use of equipment needed to install the permanent Phase 2 repair.

While uncovering a critical finding like the one on the I-40 bridge is never a good day, the steel industry responded with deliberate speed, efficiency, and safety by developing and fabricating repairs that can be quickly implemented on this steel structure, allowing the bridge to open back up safely.

- On May 17, Kiewit Infrastructure Group was awarded the emergency bridge repair contract and began mobilizing their equipment to the project site on May 19.
- Phase 1 steel repair fabrication began shortly thereafter at AISC member fabricator Stupp Bridge Company’s shop in Bowling Green, Ky., which included nearly 16.5 tons of steel.
- On May 22, TDOT crews picked up the repair material and delivered it to the bridge site. Kiewit Infrastructure Group worked 24-hour shifts installing fabricated steel plates on each side of the fractured member to secure the bridge and completed the Phase 1 repair on May 25, 14 days after discovering the fracture.

The development of Phase 2 repairs followed, with steel expected to be delivered by the end of June. As noted in the June 4 TDOT update, the Phase 2 repairs include nearly 53 tons of steel plate and 3,000 bolts. Permanent repairs were expected to begin immediately upon arrival of the repair plate at the bridge site and anticipated to continue through July.

Welcome to Safety Matters, which highlights various safety-related issues. This month’s edition focuses on driver-related safety.

Staying Safe on the Road

As most business operations—especially construction—include some form of logistics, it is important to ensure you have a safety program that focuses on driver safety. To put the importance of this topic into perspective, nearly 85% of drivers say running a red light is wrong, but almost 31% of those drivers admitted to doing it in the past 30 days.

Substance abuse can also create clearly unsafe driving conditions during work hours and after hours as well. Whether your business runs a large logistics department or periodically sends employees out of town on business, it is important to make sure your policies clearly state company expectations while on the clock. Impaired driving is estimated to result in one death every 52 minutes in the U.S.—a pretty staggering statistic!

A particularly great source for curbing driving-related injury and death is your insurance provider. Most insurance providers and workers-compensation programs offer resources to their clients and may even provide training on reasonable suspicion for your workforce. The best time to ensure that your business and people are safeguarded is right now.

Framing complicated subjects like substance abuse and driving can be tricky. But remembering that the ultimate goal is to send everyone home safe is a great place to build from. Honest and straightforward policies on driving and substance abuse put your business in place to take care of its people and avoid any unfortunate incidents. Take the time to verify that you have such a policy in place to keep your people knowledgeable and safe.

Dates/Events to Note

- National Coalition for Safer Roads, Stop on Red Week, August 1–7, ncsrsafety.org/stop-on-red
- National Highway Traffic Safety Administration, Drive Sober or Get Pulled Over, ongoing, one.nhtsa.gov/drivesober

We are always on the lookout for ideas for safety-related articles and webinars that are of interest to AISC member companies. If you have safety-related questions or suggestions, we would love to hear them. Contact us at schlafly@aisc.org. You can also visit AISC’s safety page at aisc.org/safety for various safety resources.



SMITH - EMERY

Inspection • Testing • Metallurgy

Assuring Structure & Life Safety Since 1904

Non-Destructive Testing

- PAUT
- Visual (CWI, CWB, CSWIP)
- MT
- UT

Owner QA

- Fabrication Oversight
- Specification Review
- Field Inspections
- WPS Reviews

Metallurgical Laboratory

Environmental Laboratory

Firestop Inspection

Supplier Audits

- IAS
- IAPMO
- City of Los Angeles
- Clark County, NV

Contractor QC

- Fabrication Shop NDT, CWI
- Vendor Audits
- QMS Development
- WPS and PQR Testing

Curtain Wall Performance Testing

Concrete Testing

Chemical Laboratory

1.833.405.0536
 steel@smithemery.com
 www.smithemery.com



Structural Engineers

Are you looking for a new and exciting opportunity?

We are a niche recruiter that specializes in matching great structural engineers with unique opportunities that will help you utilize your talents and achieve your goals.

- We are structural engineers by background and enjoy helping other structural engineers find their "Dream Jobs."
- We have over 30 years of experience working with structural engineers.
- We will save you time in your job search and provide additional information and help during the process of finding a new job.
- For Current Openings, please visit our website and select Hot Jobs.
- Please call or email Brian Quinn, PE: 616.546.9420
Brian.Quinn@FindYourEngineer.com
 so we can learn more about your goals and interests.
All inquiries are kept confidential.

SE Impact by SE Solutions, LLC | www.FindYourEngineer.com



Contract Auditor

Quality Management Company, LLC (QMC) is seeking qualified independent contract auditors to conduct site audits for the American Institute of Steel Construction (AISC) Certified Fabricators and Certified Erector Programs.

This contract requires travel throughout North America and limited International travel. This is not a regionally based contract and a minimum travel of 75% should be expected.

Contract auditors must have knowledge of quality management systems, audit principles and techniques. Knowledge of the structural steel construction industry quality management systems is preferred but not required as is certifications for CWI, CQA or NDT. Prior or current auditing experience or auditing certifications are preferred but not required. Interested contractors should submit a statement of interest and resume to contractor@qmconline.org.

LATE MODEL STRUCTURAL STEEL MACHINES AVAILABLE IMMEDIATELY

Peddinghaus PCD1100 Beam Drill & Meba 1140/510 Saw Line With Conveyor & Transfers, 2007 #31409

Peddinghaus AFCPS 823-B Anglemaster Angle Punch & Shear Line, 1998, New Control & Drives, 2017 #31429

Ficpep Excalibur 12 CNC Single Spindle Traveling Column Drill With Automatic Tool Changer, 2014 #31466

Roundo R-13S 8" x 8" x 1.25" Section Bender, 31.5" Dia Rolls, 105 HP, 1998 #29237

Hyd-Mech S-35P, Horizontal Mitering Bandsaw, 32" x 42" Capacity, 2" Blade Width, 65 - 350 SFPM, 1997 #31421

Peddinghaus FPB-1500/3D, 177 Ton, 60" Max Width Plate, 200 Amp Plasma, Fagor 8025 CNC 1998 #31514



WE ARE ACTIVELY LOOKING FOR USED STRUCTURAL STEEL EQUIPMENT

CONTACT: Claire@PrestigeEquipment.com

www.PrestigeEquipment.com | (631) 249-5566

To advertise, contact M.J. Mrvica Associates, Inc.: 856.768.9360 | mjmrvica@mrvica.com. Search employment ads online at www.modernsteel.com.

advertiser index

AISC	8 50	Integrated Engineering Software	5
Applied Bolting	39	IRyS Global	53
Automated Layout Technology	45	New Millennium Building Systems	36
AWS	47	Nucor Tubular	11 back cover
Bend-Tech	12	Nucor Vulcraft	13 15
Birmingham Fastener	39	Peddinghaus Corporation	2
Burlington Automation	67	QuickFrames USA	53
Chicago Metal Rolled Products	insert	SDS2	7
Controlled Automation	63	Sideplate / MiTek	31
CoreBrace, LLC	47	Trimble	3
InfoSight Corporation	37	Voortman Corporation	14

structurally sound

Jeff Jobe



The reconstructed BNSF Wind River Bridge in Skamania County, Wash., was a 2020 Prize Bridge Award winner. To read about all of the 2020 winners, see the July 2020 issue, available in the Archives section at www.modernsteel.com.

BEST BRIDGES

WE'RE LOOKING FOR OUTSTANDING BRIDGES that showcase the innovative use of structural steel.

Have you or your company worked on one recently? If so, you should consider entering it into AISC's and NSBA's 2022 Prize Bridge Awards competition! The entry deadline is September 8, and there is no fee to enter.

"America has a proud history of steel bridges connecting communities for decades or even centuries, and new landmarks open around the country all the time," said NSBA's director of market development, Brandon Chavel, PE, PhD. "NSBA is committed to showcasing the best bridge engineering and construction our industry has to offer, and I'm excited to see which bridges win this year's Prize Bridge Awards!"

Our panel of judges will consider entries in several categories defined by bridge size and function, weighing each project's innovation, economics, aesthetics, design, and engineering solutions—and this year, we're introducing an exciting new award!

The Bridge of the Year Award will recognize the single most significant bridge built in America recently. The judges

will select three finalists from all bridges entered in the competition. The teams behind those three projects will have the opportunity to present their projects to the industry during the first session of the 2022 World Steel Bridge Symposium, held in conjunction with NASCC: The Steel Conference, March 23–25 in Denver. The judges will then confer, and we'll announce the winner of the inaugural Bridge of the Year Award at the end of the conference!

Eligible bridges must be:

- built of structural steel produced and fabricated in the United States
- located in the U.S., defined as the 50 states, the District of Columbia, and all U.S. territories
- completed and opened to traffic between January 1, 2019, and September 8, 2021.

Any team member from an eligible bridge project may submit it for award consideration. Want to learn more? And submit your amazing bridge? Visit aisc.org/nsba/prize-bridge-awards. ■

WE UNDERSTAND STRUCTURAL STEEL



At Lincoln Electric®, we understand large structural projects. PythonX® along with Zeman SBA systems, enables you to take on larger projects by allowing operators to automate cutting, fitting, and welding.

Learn more at lincolnelectric.com | pythonx.com | zebau.com or contact our experts at 1-833-PYTHONX



A close-up portrait of Carol Drucker, a woman with dark, curly hair, looking directly at the camera with a neutral expression. She is wearing a dark green blazer over a dark shirt. The background is dark and out of focus.

CONSTRUCTION SOLUTIONS

MINDS OF STEEL

Carol Drucker, Principal
Drucker Zajdel Structural Engineers

The most innovative engineers use steel to transform creative ideas into realities. Let your projects soar higher and finish faster with steel.

Discover more at [Nucor.com/collaborate](https://www.nucor.com/collaborate)

NUCOR®