

# Modern Steel Construction

June 2022

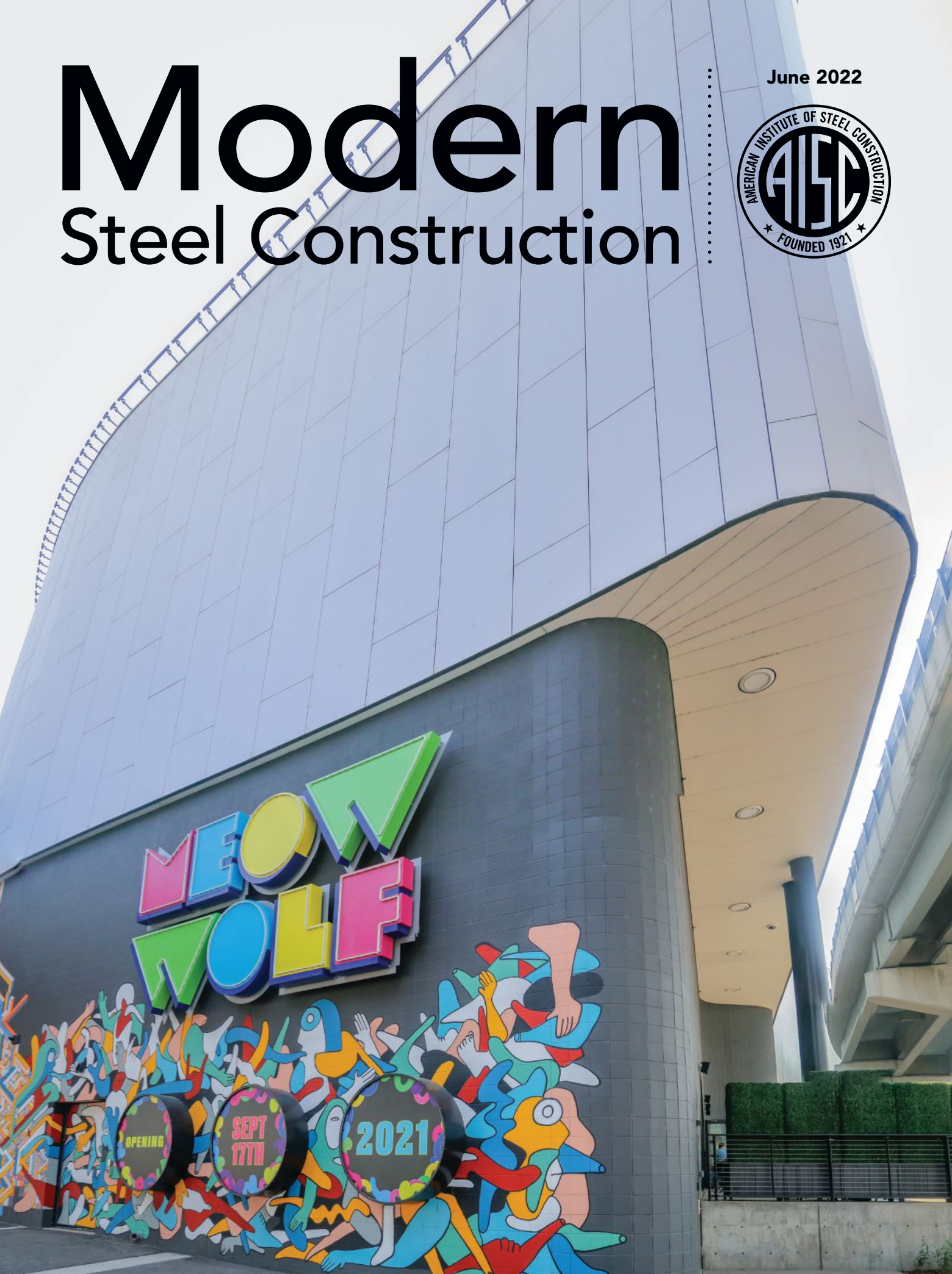



# THE FASTEST DRILL

LINE IN THE STEEL INDUSTRY

- Simultaneously mill copes, flange thins, rat holes and more with each drilling axis
- Simultaneously arcwrite piece marks, weld symbols and more on all 4 sides of material
- Each high speed 25 HP drill spindle has an operating window of 19-11/16"

[www.peddinghaus.com/steel/subx](http://www.peddinghaus.com/steel/subx)



THE  
PEDDISUBX-1120

**Peddinghaus**

**STRONGER** THAN  
**STEEL**®

[www.peddinghaus.com](http://www.peddinghaus.com) | [info@peddinghaus.com](mailto:info@peddinghaus.com) | (815) 937-3800



# NO MORE STRUGGLES WITH STEEL CONNECTION DESIGN

- ANY GEOMETRY
- ANY LOADING
- IN MINUTES

## Overall check

According to AISC or other national design codes

## Stress strain analysis

Auto-generated FE model of steel joints

## Stiffness analysis

Rotational or transversal stiffness analysis of any connection

## Seismic design

Capacity design check of connections

## Buckling analysis

Local buckling effects and critical load factors

## Ultimate joint resistance

Determine joint capacity for new or existing connections

## Integrated workflow

BIM links with the most widespread FEA/CAD software

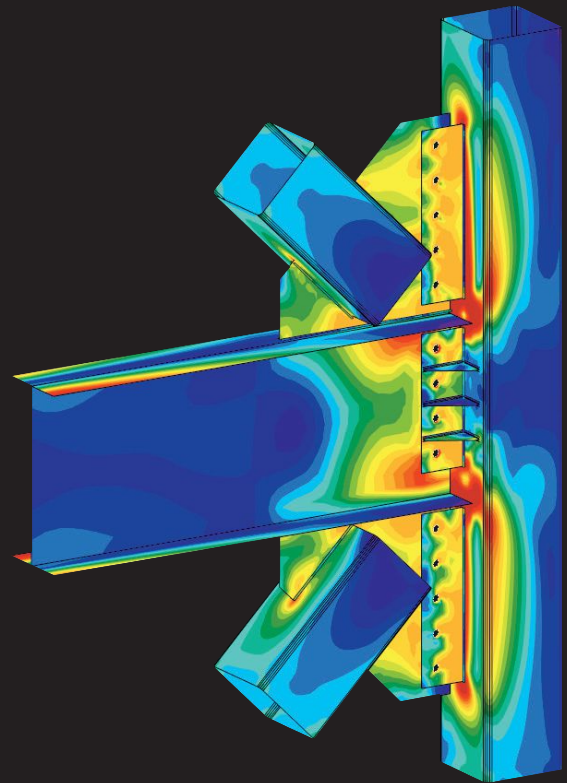

## Worldwide reference projects



Jakarta Velodrome (Indonesia)



Museum of the Future –  
Dubai (UAE)



Curragh Racecourse (Ireland)



Waterloo Station  
Redevelopment – London (UK)

Request a live DEMO today on  
[www.ideastatica.com](http://www.ideastatica.com)

# Modern Steel Construction

June 2022



## in every issue

### departments

- 6 EDITOR'S NOTE
- 9 STEEL INTERCHANGE
- 12 STEEL QUIZ
- 62 NEW PRODUCTS
- 63 NEWS & EVENTS
- 66 STRUCTURALLY SOUND

### resources

- 65 ADVERTISER INDEX
- 65 MARKETPLACE & EMPLOYMENT

## features

- 30 Immersive Installation**  
BY JOHN JUCHA, SE,  
SHAUN FRANKLIN, PE, AND  
MICHAEL OLSEN, PE  
Steel helps arts and entertainment company Meow Wolf achieve its immersive vision with a quirky new venue on a tight site in Denver.
- 36 Treading Lightly**  
BY BRETT SAUTER, SE, PE  
A Chicago bridge project powers through COVID-19 impacts while minimizing its own impacts on the train and highway traffic it traverses.
- 40 Faster and Faster**  
BY BRETT MANNING, SE, DAVE P. WRIGHT, KEITH D. PALMER, SE, PHD, AND RYAN COOKE, PE, PHD  
An already speedy steel plate core system becomes even faster thanks to an innovative “split” planning mindset.
- 48 Hillside Steel**  
BY RALPH PARRISH AND ROBERT HORTON, PE, PENG  
A new steel fabricator headquarters building is both carved out of and blended into the foothills of the Appalachians.
- 54 Navigating Sustainability**  
BY LAURA MICHELI, PHD, BRUCE BROTHERSEN, SE, PE, PENG, AND SCOTT RUSSELL, SE, PE, PENG  
Notes on navigating the evolving sustainability landscape.
- 60 And We're Back**  
BY GEOFF WEISENBERGER  
NASCC: The Steel Conference returns to an in-person format for the first time since 2019.

## columns

### steelwise

- 16 Are You Properly Specifying Materials?**  
BY JONATHAN TAVAREZ, PE  
Learn what's new in the world of structural steel materials.

### data driven

- 24 Rough Waters**  
BY JOE DARDIS  
As we navigate the turbulent seas of construction pricing, remember that we're all in the same boat.

### field notes

- 26 Intercontinental Connection**  
INTERVIEW BY GEOFF WEISENBERGER  
Gian Rassati, a 2022 AISC Special Achievement Award winner, began life in a small Italian mountain town and has gone on to do big things in bolting research.

### business issues

- 28 A Letter to Entry-Level Engineers**  
BY RYAN CURTIS, PE  
Advice for today's young engineers on their way to becoming tomorrow's engineering leaders.

**ON THE COVER:** It's a tight squeeze for a new Denver museum located on a sliver of land between highways, p. 30. (Photo: KL&A Engineers and Builders)

MODERN STEEL CONSTRUCTION (Volume 62, Number 6) ISSN (print) 0026-8445; ISSN (online) 1945-0737. Published monthly by the American Institute of Steel Construction (AISC), 130 E Randolph Street, Suite 2000, Chicago, IL 60601. Subscriptions: Within the U.S.—single issues \$6.00; 1 year, \$44. Outside the U.S. (Canada and Mexico)—single issues \$9.00; 1 year \$88. Periodicals postage paid at Chicago, IL and at additional mailing offices. Postmaster: Please send address changes to MODERN STEEL CONSTRUCTION, 130 E Randolph Street, Suite 2000, Chicago, IL 60601.

**DISCLAIMER:** AISC does not approve, disapprove, or guarantee the validity or accuracy of any data, claim, or opinion appearing under a byline or obtained or quoted from an acknowledged source. Opinions are those of the writers and AISC is not responsible for any statement made or opinions expressed in MODERN STEEL CONSTRUCTION. All rights reserved. Materials may not be reproduced without written permission, except for noncommercial educational purposes where fewer than 25 photocopies are being reproduced. The AISC and Modern Steel logos are registered trademarks of AISC.



Printed on paper made from a minimum of 10% recycled content.



# Building EFFICIENCY

AESTHETICS | ACOUSTICS | FLEXIBILITY | CONSTRUCTABILITY | SUSTAINABILITY

## Faster, more cost-effective multi-story construction

Minimize floor depth and maximize project performance. Deep-Dek® Composite enables open spans up to 36 feet, and low-profile slabs as thin as 7.635 inches. With Panelized Delivery Method™ floor panels are assembled on the ground, increasing worker safety, and decreasing assembly time.



LEARN  
MORE



[Newmill.com/smartkey](https://Newmill.com/smartkey)



**NEW MILLENNIUM**  
BUILDING SYSTEMS

BUILDING SUCCESS TOGETHER



## editor's note



What you probably aren't aware of is that more recently, millions of people like my youngest son have watched hours and hours of online videos talking about these shows. These videos include recaps longer than the actual episodes, as well as incredibly dense philosophical discussions of the shows' impact on the greater metaverse. And to be clear, I have no idea what all of that means.

But if you can imagine the level of complexity devoted to analyzing innocuous TV programming, you can probably begin to grasp the complexity of looking at a topic like sustainability.

On its most basic level, we can equate sustainability in design with net-zero carbon construction. The wood industry folks are gods at oversimplifying this equation. They conveniently ignore the details and make overly broad generalizations—e.g., what happens with the 40% to 60% of material left behind when trees are harvested, the environmental differences between not just two different species of tree but also two different trees within the same species, what percentage of wood products is actually obtained from sustainably managed forests, and what happens to wood after a building reaches the end of its life. (Seriously, does anyone really believe that 30-year-old CLT panels are going to be carefully demounted from existing buildings and somehow incorporated into new construction?).

Likewise, you can achieve today a net-zero carbon project using structural steel. The nation's largest steel producer, Nucor, is happy to sell you its Econiq-branded product. Using a combination of carbon offsets and purchasing agreements for renewable energy, the company can designate its product as net-zero carbon—all for a very modest premium. And if the demand exists, other mills can offer a similar product.

And as a first step, products like Econiq are great. Fortunately, the steel industry isn't content with this approach alone. Companies like Nucor are committed to continuous reductions in their carbon footprint and are investing millions of dollars every year to develop and implement improved solutions.

For decades, American steel (and remember, the U.S. structural mill capacity in 2022 already exceeds the demand for structural steel for American building and bridge projects, and new mills are under construction) has worked to truly reduce its carbon footprint. Currently, the major U.S. mills

If you were a teen (or like me, had teenage or pre-teen kids) a decade ago, you were probably all too aware of a handful of mildly entertaining, mostly harmless Nickelodeon shows such as *iCarly* and *Victorious*.

have carbon footprints around half the industry world average (by comparison, Chinese steel has roughly three times the greenhouse gas emissions of American steel).

And improvements are steadily advancing. Some of the reductions are organic. Remember that a large portion of steel's carbon footprint is purely based on its energy intensity—and as the U.S. grid moves to more renewable energy, we can expect a continuing decrease in carbon footprint (by some estimates, the pivot to more renewable energy alone will lead to around a 41% reduction in carbon emissions from domestic structural steel production).

But we're also seeing a lot of other technological improvements that will further reduce steel's environmental impact. We're seeing steel producers begin to build their own sustainable power sources next to their mills. We're seeing the incorporation of carbon-scrubbing equipment. We're seeing mills retaining most of their cooling water in closed-loop systems, as well as looking at alternatives to water as a cooling source. We're seeing mills move away from natural gas to power their preheat furnaces. And much more.

In fact, all the domestic structural steel mills have made substantial commitments to reduce their carbon footprint. For example, you can read about Nucor's commitment to reducing its carbon footprint by 35% by 2030—and how they'll accomplish it—at [nucor.com/greenhouse-gas-reduction-target-strategy](https://www.nucor.com/greenhouse-gas-reduction-target-strategy). You can read about Gerdau's efforts at [www2.gerdau.com/climatechange](https://www2.gerdau.com/climatechange) and SDI's at [stld.steeldynamics.com/valuing-our-environment](https://stld.steeldynamics.com/valuing-our-environment). (You can also read more about sustainability and steel on page 54.)

Today, American structural steel, thanks to its 93% recycled content, is already an earth-friendly construction material. But that's not good enough—and thankfully, the industry is investing both time and money to truly reach the goal of being a carbon-neutral material. And since video speaks louder than words, check out [aisc.org/vr](https://aisc.org/vr) to see the modern steelmaking process, as well as videos of other steps in the structural steel supply chain.

A handwritten signature in black ink that reads "Scott Melnick".

Scott Melnick  
Editorial Director

# Modern Steel Construction

## Editorial Offices

130 E Randolph St, Ste 2000  
Chicago, IL 60601  
312.670.2400

## Editorial Contacts

CHIEF EDITOR  
Geoff Weisenberger  
312.493.7694  
[weisenberger@aisc.org](mailto:weisenberger@aisc.org)

PUBLISHER  
Keith A. Grubb, SE, PE  
312.804.0813  
[grubb@aisc.org](mailto:grubb@aisc.org)

GRAPHIC DESIGN MANAGER  
Kristin Hall  
773.636.8543  
[hall@aisc.org](mailto:hall@aisc.org)

EDITORIAL DIRECTOR  
Scott Melnick  
312.804.1535  
[melnick@aisc.org](mailto:melnick@aisc.org)

## AISC Officers

CHAIR  
Stephen H. Knitter  
Geiger & Peters, Inc.  
VICE CHAIR  
Hugh J. McCaffrey  
Southern New Jersey Steel Co.

SECRETARY/LEGAL COUNSEL  
Edward Seglias, Cohen Seglias  
Pallas Greenhall & Furman, PC

PRESIDENT  
Charles J. Carter, SE, PE, PhD

SENIOR VICE PRESIDENT  
Scott Melnick

SENIOR VICE PRESIDENT  
Mark W. Trimble, PE

VICE PRESIDENT  
Todd Alwood

VICE PRESIDENT  
Carly Hurd

VICE PRESIDENT  
Lawrence F. Kruth, PE

VICE PRESIDENT  
Mike Mospan

VICE PRESIDENT  
Brian Raff

## Editorial Advisory Panel

Brandon Chavel, PE, PhD  
Michael Baker International  
Nat Killpatrick  
Basden Steel

Christina McCoy, SE  
Oklahoma State University  
School of Architecture

Allison Shenberger, PE  
ruby+associates

Justin Smith, PE  
Walter P Moore

## Advertising Sales

M.J. Mrvica Associates, Inc.  
2 W Taunton Avenue  
Berlin, NJ 08009  
856.768.9360  
[mjmrvica@mrvica.com](mailto:mjmrvica@mrvica.com)

## Address Changes and Subscription Concerns

312.670.2401  
[subscriptions@aisc.org](mailto:subscriptions@aisc.org)

## Reprints

Kristin Hall  
[hall@aisc.org](mailto:hall@aisc.org)





## Better fabrication starts with SDS2.

The right detailing software can drive efficiency and profitability in your fabrication shop. With SDS2, you can quickly build and adapt the detailing model to suit your needs, integrate seamlessly with any MRP, MIS and tracking system, and maximize returns on your automated equipment.

Efficiency, accuracy, results—it all starts with SDS2. Get started today at [sds2.com/start](https://sds2.com/start).



now part of

**ALLPLAN**  
A NEMETSCHEK COMPANY

**SDS2 2022 NOW AVAILABLE**





Quality Management Company, LLC (QMC) is seeking qualified

## **INDEPENDENT CONTRACT AUDITORS**

to conduct site audits for the American Institute of Steel Construction (AISC) Certified Fabricators and Certified Erector Programs.

This contract requires travel throughout North America and limited International travel. This is not a regionally based contract and a minimum of 75% travel should be expected.

Contract auditors must have knowledge of quality management systems, audit principles and techniques. Knowledge of the structural steel construction industry quality management systems is preferred but not required as is certifications for CWI, CQA, or NDT. Prior or current auditing experience or auditing certifications are preferred but not required.

Interested contractors should submit a statement of interest and resume to [contractor@qmcauditing.com](mailto:contractor@qmcauditing.com).

## steel interchange

---

If you've ever asked yourself "Why?" about something related to structural steel design or construction, *Modern Steel's* monthly Steel Interchange is for you!

Send your questions or comments to [solutions@aisc.org](mailto:solutions@aisc.org).

### Significant Load Reversal: Part 1

The Commentary on page 16.2-34 of the 2020 *RCSC Specification for Structural Joints Using High-Strength Bolts* states: "Joints that are required to be slip-critical joints include: (2) Those cases where a slip of any magnitude must be prevented, such as in joints subject to significant load reversal and joints between elements of built-up compression members in which any slip could cause a reduction of the flexural stiffness, which is required for the stability of the built-up member."

Some engineers in our office have taken that to mean slip-critical bolts are required for all lateral force-resisting system connections that will see tension and compression. Is this correct?

No, it is up to the engineer of record to determine whether the load reversal produces a significant or negligible

effect and, therefore, whether slip can be permitted or must be prevented.

High-strength bolting began to be used around the 1950s. In my experience (both firsthand dating to the early-to-mid-1990s and secondhand looking at calculations and interacting with older engineers), it is rare to see bracing connections designed as slip-critical connections when standard holes are used. Note that Section 4.3.1 states that slip-critical joints are required for "joints that are subject to fatigue load with reversal of the loading direction." The *AISC Specification for Structural Steel Buildings* (AISC 360-16), in Section B3.11, states: "Fatigue need not be considered for seismic effects or for the effects of wind loading on typical building lateral force-resisting systems and building enclosure components." At this point, there must be thousands of structures in which the connections subject to "significant load reversal" due to wind or seismic loading

were pretensioned as required in Section 4.2 of the *RCSC Specification* but still designed as bearing connections, as is done in *AISC Design Guide 29: Vertical Bracing Connections—Analysis and Design*, the Design Examples associated with the *AISC Steel Construction Manual*, and, I believe, in all of the handbooks I have ever encountered that address such conditions. Given the ubiquity of the practice, one might expect problems to have occurred in service if the practice was likely to result in problems. The lack of issues might then be taken as evidence that there will not be future problems.

It is possible that one could have lateral force-resisting system connections that will see tension and compression for which "slip of any magnitude must be prevented" because "slip at the faying surfaces would be detrimental to the performance of the structure." But based on my experience, this would be unusual.

Larry S. Muir, PE

### Significant Load Reversal: Part 2

Section 4.2 of the *RCSC Specification* states: "Pretensioned joints are required in the following applications: (2) Joints that are subject to significant load reversal." However, the Commentary on page 16.2-34 states: "Joints that are required to be slip-critical include: (2) Those cases where slip of any magnitude must be prevented, such as in joints subject to significant load reversal and joints between elements of built-up compression members in which any slip could cause a reduction of the flexural stiffness, which is required for the stability of the built-up member."

These seem to be referring to the same thing. Is this an error in the *RCSC Specification*?

No, it is not an error. Section 4.2 and the Commentary you refer to do not address the same thing, and I believe they are using the term "significant load reversal" in a consistent manner.

Significant load reversal means that the load reverses direction in a manner that causes more than a negligible effect. When this occurs, the *RCSC Specification* Section 4.2 requires the joint to be pretensioned. The *RCSC Specification* does not require the joint to be designed as slip-critical.

The critical statement in the Commentary is: "Those cases where slip of any magnitude must be prevented..." For joints subjected to significant load reversal, the joint must be pretensioned. If, for that same joint, there is also enough concern about slip such that slip of any magnitude must be prevented, then the joint should be designed as slip-critical. Note that this is consistent with the requirement in Section 4.3 in the *RCSC Specification*, which states: "Slip-critical joints are required in the following applications involving shear or combined shear and tension: (4) Joints in which slip at the faying surfaces would be detrimental to the performance of the structure."

Larry S. Muir, PE

---

All mentioned AISC standards, unless noted otherwise, refer to the current version and are available at [aisc.org/specifications](http://aisc.org/specifications), AISC Design Guides are available at [aisc.org/dg](http://aisc.org/dg), and *Engineering Journal* articles can be found at [aisc.org/ej](http://aisc.org/ej).



## Galvanized High-Strength Bolts

### Is it permissible to galvanize high-strength bolts?

Yes, this is addressed in the 2020 *RCSC Specification* in Section 2.8.1:

“Group 120 and Group 144 bolting components are permitted to be hot-dip or mechanically galvanized, except that direct-tension indicators are only permitted to be mechanically galvanized in compliance with ASTM F959.”

“Hot-dip galvanized bolting components shall meet the requirements of ASTM F2329. Mechanically galvanized bolting components shall meet the Class 55 requirements of ASTM B695. All threaded components of the bolting assembly shall be galvanized by the same process.”

“Mechanical galvanizing of spline-end twist-off and fixed matched bolting assemblies shall be performed only under the direction of the Manufacturer and as permitted by their respective standards. Hot-dip galvanizing of spline-end matched bolting assemblies is not permitted.”

“Hot-dip or mechanical galvanizing of Group 150 heavy hex bolts or Group 150 spline-end matched bolting assemblies is not permitted.”

The “groups” referred to here are defined in Table 2.1, which lists the applicable bolt ASTM standards. The Commentary in this section also provides helpful guidance that you should review.

Group	Tensile Strength	Bolts	Matched Bolting Assemblies
Group 120	120 ksi	ASTM F3125 Grade A325	ASTM F3125 Grade F1852
Group 144	144 ksi	—	ASTM F3148 Grade 144
Group 150	150 ksi	ASTM F3125 Grade A490	ASTM F3125 Grade F2280

*Jonathan Tavarez, PE*

## Various Interaction Equations

**When designing a single-plate shear connection for combined axial, shear, and flexural loads, the 15th Edition AISC Steel Construction Manual recommends using Equation 9-1. However, in AISC Design Example II.A-17B, which looks at a connection subjected to axial and shear loading, an equation that is derived from Chapter H in the AISC Specification for Structural Steel Buildings (ANSI/AISC 360), in conjunction with AISC Manual Equation 10-5, is used. Can you help me understand why different interaction equations are used for similar load combinations?**

$$\frac{M_r}{M_c} + \left(\frac{P_r}{P_c}\right)^2 + \left(\frac{V_r}{V_c}\right)^4 \leq 1.0 \text{ (9-1)}$$

$$\left(\frac{V_r}{V_c}\right)^2 + \left(\frac{M_r}{M_c}\right)^2 \leq 1.0 \text{ (10-5)}$$

$$\frac{P_r}{2P_c} + \left(\frac{M_{rx}}{M_{cx}} + \frac{M_{ry}}{M_{cy}}\right) \leq 1.0 \text{ (H1-1b)}$$

Each of the interaction equations you mentioned is valid for its intended purposes. Different equations are used in various situations in AISC publications. In many cases, more than one interaction equation is valid, and the equation is selected based on the author’s judgment. I have used all of these equations and several more in my connection design practice. The selection of an appropriate interaction equation is dependent on several considerations, including the cross-sectional shape (I-shaped, T-shaped, rectangular, etc.), the stress distribution on the cross section (elastic, inelastic, plastic), the loading types (shear, axial, flexure, torsion), and the slenderness for members that are subjected to compression stresses. Ultimately, you must use your judgment

to determine what is appropriate for your situation.

AISC *Manual* Equation 9-1 is applicable to the plastic strength of members and connection elements with rectangular cross sections. The development of this partially empirical equation is discussed in the first quarter 2015 *Engineering Journal* article “Plastic Strength of Connection Elements.” This equation is limited to elements with low slenderness (where buckling is prevented). As discussed in the fourth quarter 2016 *Engineering Journal* article “Stability of Rectangular Connection Elements,” when stability is a design consideration, the interaction equations in the 2016 AISC *Specification*, Section H1.1 are more appropriate.

*Bo Dowswell, PE, PhD*

**Jonathan Tavarez** ([tavarez@aisc.org](mailto:tavarez@aisc.org)) is AISC’s structural steel specialist in the New York City Market. **Larry Muir** and **Bo Dowswell**, principal with ARC International, LLC, are consultants to AISC.



**STEEL SOLUTIONS CENTER**

Steel Interchange is a forum to exchange useful and practical professional ideas and information on all phases of steel building and bridge construction. Contact Steel Interchange with questions or responses via AISC’s Steel Solutions Center: 866.ASK.AISC | [solutions@aisc.org](mailto:solutions@aisc.org)

The opinions expressed in Steel Interchange do not necessarily represent an official position of the American Institute of Steel Construction and have not been reviewed. It is recognized that the design of structures is within the scope and expertise of a competent licensed structural engineer, architect or other licensed professional for the application of principles to a particular structure.

The complete collection of Steel Interchange questions and answers is available online at [www.modernsteel.com](http://www.modernsteel.com).

# Take a New Look at Tekla Structures

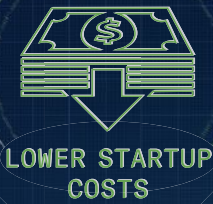

2022 UPDATES



CONSTANT INNOVATION



There has never been a better time to take a new look at the industry's leading steel detailing BIM software, Tekla Structures. Our new subscription offering has dramatically lowered startup costs while providing the flexibility of multiple configurations ensuring there is a license type that best fits your needs. Also, this year's version release was packed with new, market driven functionality and with our history of constant innovation, you can bet that future version releases will be every bit as impactful.

If you are ready to take a new look at Tekla Structures, visit [tek.la/newlook](https://tek.la/newlook) to learn more and request a custom quote.



# steel quiz

This month's questions and answers were developed by Michael Desch, an AISC intern and current graduate student at the Illinois Institute of Technology. Thanks, Michael!

This month's Steel Quiz explores the design considerations that impact the structural design of hybrid steel-framed structures with mass-timber floors.

For guidance, you can consult the newly released AISC Design Guide 37: *Hybrid Steel Frames with Wood Floors* (available at [aisc.org/dg](http://aisc.org/dg)).

- Which of the following is a benefit of hybrid steel-timber building systems?  
a. Larger columns sizes      c. Less prefabrication  
b. Increased construction speed      d. All of the above
- True or False:** For hybrid construction where both the steel structure and mass timber are exposed, intumescent paint may be used when fire protection is required for the steel.
- True or False:** A 6-in.-thick five-ply CLT floor panel alone can sufficiently isolate acoustic transmission for most office and residential applications.
- True or False:** Two key advantages of the steel framing in a hybrid system are that (1) the flexibility of the steel lateral force-resisting system (LFRS) can minimize the impact of the lateral system on the building architecture and (2) using a steel LFRS provides a proven path to code compliance.
- What is the maximum joint tolerance for panel gaps suggested by the design guide?  
a.  $\frac{1}{8}$  in.      b.  $\frac{3}{16}$  in.      c.  $\frac{1}{4}$  in.      d.  $\frac{3}{8}$  in.
- Which of the following is an actual difference between glue-laminated-timber (GLT) and cross-laminated-timber (CLT) products?  
a. Layer-to-layer bonding differs. Adhesives are used to bond the layers of GLT, while CLT uses mechanical fasteners (screws, nails, or dowels).  
b. The layer type differs. The plies of GLT are made of many thin layers of wood veneer, while CLT is made from plies of dimensional lumber.  
c. The orientation of each layer differs. GLT layers may be oriented in parallel, while in CLT, every layer is oriented perpendicular to adjacent layers.  
d. The fabrication location differs. GLT products are generally fabricated on-site, while CLT products are usually prefabricated in factories

TURN TO PAGE 14 FOR THE ANSWERS

# HANDRAILS MADE EASY DRAGON A400

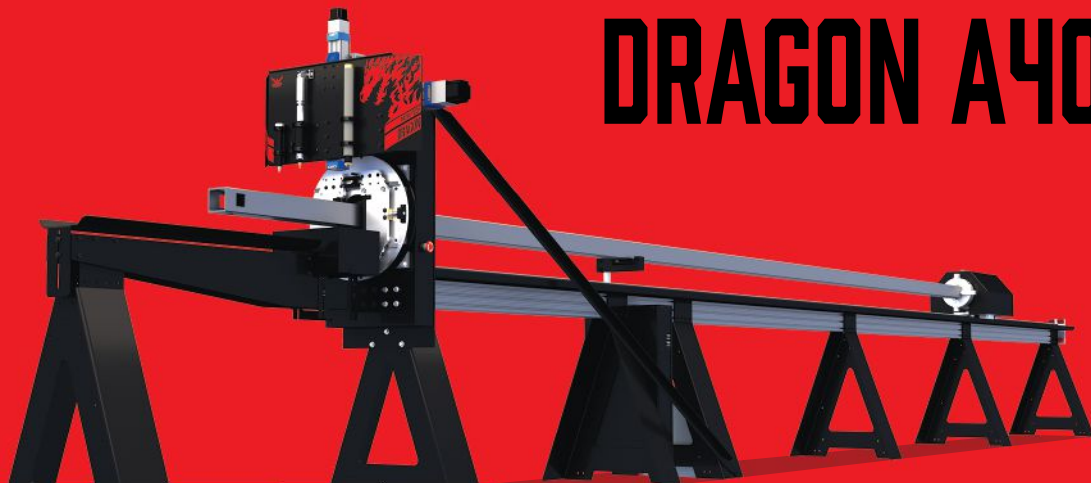

**CNC Plasma Tube & Pipe Processing Machine**  
Easily handles round, square, rectangle, angle, and channel up to 24 feet.



Easily auto imports from Tekla and SDS2

**BEND-TECH**

651-257-8715 • [www.bend-tech.com](http://www.bend-tech.com)





# THE MOST SUSTAINABLE HSS AVAILABLE

Sustainability drives decision-making more than ever before. Nucor Tubular Products is your partner for achieving your sustainability goals and bringing your projects to life. And because all of our steel is made with electric arc furnace (EAF) technology, our HSS is the greenest produced in North America.

**Whether you need HSS for a long span truss or a handrail,  
take your project to the next level with Nucor Tubular Products.**

**NUCOR<sup>®</sup>**  
**TUBULAR PRODUCTS**

[nucortubular.com](http://nucortubular.com)



1 **b.** Increased construction speed. There are many advantages of using a hybrid steel-timber building system. Both materials can play to their respective strengths to provide benefits over typical steel or timber structures. These advantages include aesthetics, sustainability, long-span capabilities,

reduced column sizes, lightweight construction, prefabrication, increased speed of construction, and more. You can find more information on the benefits of hybrid steel-timber systems in Section 2.1 of Design Guide 37.

2 **True.** Intumescent paint protects the underlying steel by charring and expanding to insulate the member when

exposed to fire. More information on designing fire protection for hybrid systems can be found in Chapter 3 of Design Guide 37.

3 **False.** As discussed in Section 4.2 of the Design Guide, a 6-in.-thick five-ply CLT panel will typically provide a sound transmission class (STC) rating of about 40 and an impact insulation class (IIC) rating in the mid-20s. These ratings are insufficient for most applications, with the *International Building Code (IBC)* recommending a minimum rating of 50 for both measures. Additional topping materials can be used to improve the acoustic performance of the floor assembly.

4 **True.** Braced frames and moment frames are the most commonly used LFRS. However, any steel LFRS allowed by the authority having jurisdiction can be used in a hybrid project. In high-seismic areas, more ductile LFRS are used in accordance with the *AISC Seismic Provisions for Structural Steel Buildings (ANSI/AISC 341, [aisc.org/specifications](http://aisc.org/specifications))*. CLT panels can help reduce the mass of the building, which in turn reduces the seismic forces. More information on designing lateral systems for hybrid steel and mass timber floor projects can be found in Section 6.2 of the Design Guide.

5 **b.**  $\frac{3}{16}$  in. As discussed in Section 7.3 of the Design Guide, no standard code of practice exists for erection tolerances of mass timber construction. Therefore, the authors proposed several erection tolerances to serve as reasonable starting points when discussing specific tolerance requirements with the contracting team.

6 **c.** The orientation of each layer differs. GLT, due to the parallel orientation of each ply and the anisotropic nature of wood, offers the most strength along a single axis, so it is useful for beams, columns, and slabs in one-way bending. CLT, due to the alternating orientations of each layer, provides strength in multiple directions. It is useful for walls, floors, and roofs and has two-way span capabilities. More information on GLT, CLT, and other mass timber products can be found in Section 1.2 of Design Guide 37.

**ABL-100HS**  
Angle Line

The only angle & flat bar line holding the title for both toughest build quality and fastest speeds.

**Controlled Automation**

501.557.5109 | [www.controlledautomation.com](http://www.controlledautomation.com)

# Software with flexibility built-in.

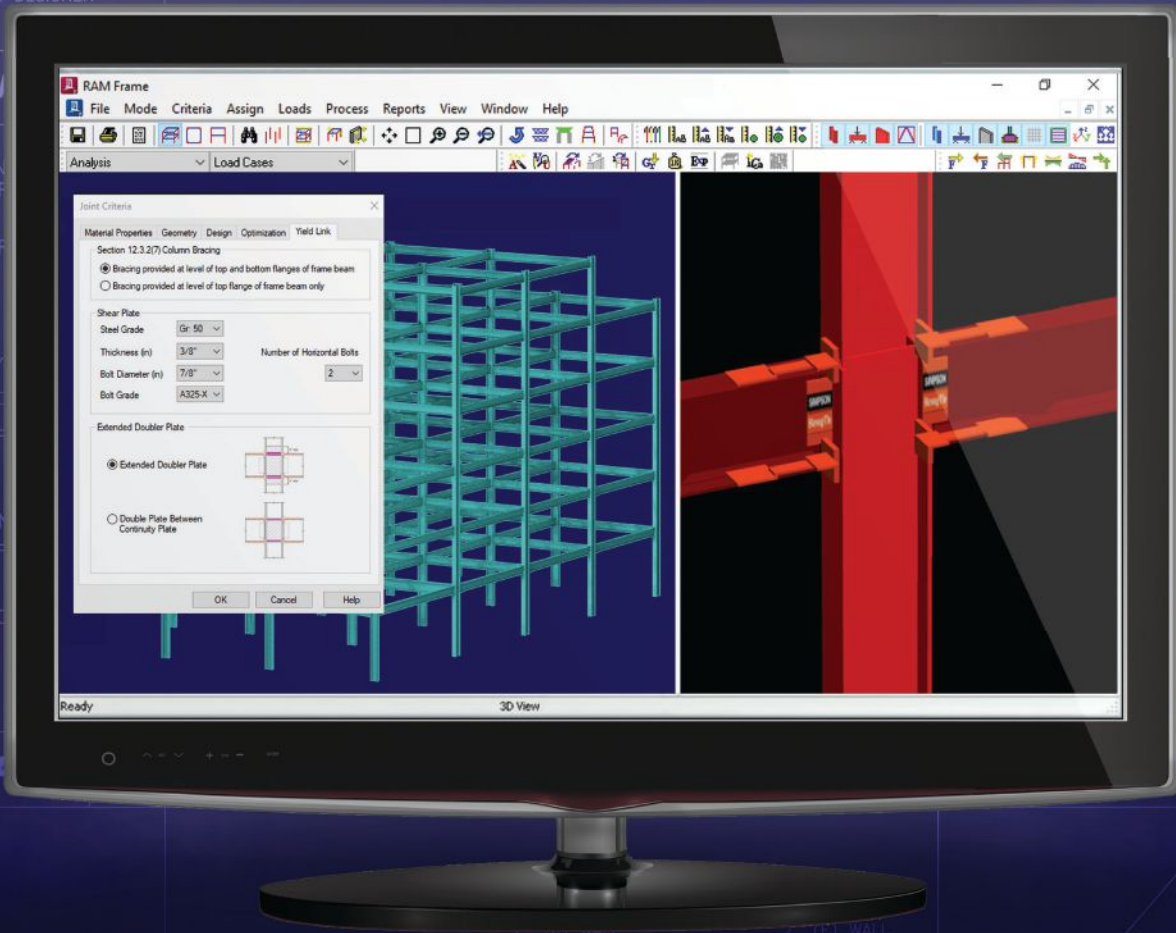

Yield-Link® software from Simpson Strong-Tie makes it easier to quickly design, model and document structural-steel buildings. From Revit, SAP2000 and ETABS plugins to integration with RISA and RAM software, our broad range of solutions help you design and construct smarter, faster and easier than ever.

To learn more about our Yield-Link connection software, visit [go.strongtie.com/yieldlinksoftware](http://go.strongtie.com/yieldlinksoftware) or call (800) 999-5099.



AUTODESK® REVIT®

SAP2000®  
ETABS®

RISA®  
A NEMETSCHEK COMPANY



RAM Structural System  
CONNECT Edition



# Are You Properly Specifying Materials?

BY JONATHAN TAVAREZ, PE

Learn what's new in the world of structural steel materials.

**WITH THE UPCOMING** publication of the 16th edition AISC *Steel Construction Manual* comes an opportunity to verify that you are correctly specifying materials.

As we know, ASTM specifications undergo periodic revisions, and new ones come into existence. The design and construction process is significantly simplified through the reference of appropriate ASTM specifications because they allow you to define all the relevant characteristics of a specified product.

However, with dozens of ASTM specifications applicable to steel construction alone, keeping the standard designations used in contracts current can be challenging. Here, we'll provide an updated summary of the most common ASTM specifications used in steel building design and construction, including standards for structural shapes, plate products, fastening products, and more. This information is based on similar information in the new version of the *Manual*. Another useful AISC publication is *Selected ASTM Standards for Steel Construction including Structural Stainless Steel*, which provides a compilation of 98 structural and stainless steel-related ASTM standards. *Selected ASTM Standards* is presently available at [aisc.org/publications](http://aisc.org/publications). The AISC 16th Edition *Steel Construction Manual* will be available in mid-2023.

All ASTM standard specifications have a typical format. Of course, the chemical and mechanical property requirements are essential, but an often-overlooked section is "Ordering Requirements." This section lists the items necessary to list when purchasing materials to ensure that you obtain the product required. Some standards also depend heavily on other ASTM standards, with an example being the reliance on ASTM A6 for common delivery requirements. Some standards also contain helpful information in notes and Annexes that should be reviewed as well.

Note that this article, along with the *Manual*, should not be taken as require-

ments but rather guidance (see the article "Says Who?" in the August 2013 issue, available in the Archives section at [www.modernsteel.com](http://www.modernsteel.com)). AISC routinely surveys structural steel fabricators and producers to determine the most common and preferred material specifications for various shapes. You may still be able to specify something that does not align with these recommendations, but this should only be done based on engineering judgment and after discussing with the fabricator.

## Structural Shapes

Let's start with structural shapes, summarized in Table 2-4.

**W-shapes.** The preferred material specification for W-shapes is ASTM A992 ( $F_y = 50$  ksi,  $F_u = 65$  ksi). The availability and cost-effectiveness of W-shapes in grades other than ASTM A992 should be confirmed before specifying. W-shapes of limited sizes with higher yield and tensile strength can be obtained by specifying ASTM A529 Grade 55, ASTM A572 Grades 55, 60, and 65, ASTM A913 Grades 60, 65, 70, and 80, or A709 Grades QST 50S, QST 65, and QST 70. W-shapes with atmospheric corrosion resistance (weathering characteristics) can be obtained by specifying ASTM A588 for building construction or ASTM A709 Grade 50W and QST grades for bridge construction. These and other material specifications applicable to W-shapes are shown in Table 2-4.

**S-shapes and M-shapes.** The preferred material specification for these shapes is now ASTM A572 Grade 50 ( $F_y = 50$  ksi,  $F_u = 65$  ksi). The availability and cost-effectiveness of S-shapes and M-shapes in grades other than those listed should be confirmed prior to their specification. S-shapes and M-shapes with a higher yield and tensile strength can be obtained by specifying ASTM A529 Grade 55, ASTM A572 Grades 55, 60, and 65, ASTM A913 Grades 60, 65, 70, and 80, or, for bridges, A709 Grades QST 50S, QST

65, or QST 70. Atmospheric corrosion resistance (weathering characteristics) can be obtained by specifying ASTM A588 for building construction or ASTM A709 Grade 50W and QST grades for bridge construction. These and other material specifications applicable to S-shapes and M-shapes are shown in Table 2-4.

**Channels.** Both Standard Channels and Miscellaneous Channels (MC) are most commonly available as ASTM A992. Some smaller channels less than 8 in. may still only be available as A36 material. Please confirm with a local fabricator before specifying ASTM A992 material for channels smaller than 8 in. Atmospheric corrosion resistance (weathering characteristics) can be obtained by specifying ASTM A588 for building construction. Also, refer to Table 2-4 for the preferred material for channels.

**HP-shapes.** The preferred material specification for HP shapes is ASTM A572 Grade 50 ( $F_y = 50$  ksi,  $F_u = 65$  ksi); other grades' availability and cost-effectiveness should be confirmed prior to specification. HP-shapes with atmospheric corrosion resistance (weathering characteristics) can be obtained by specifying ASTM A588 Grade 50. These and other material specifications applicable to HP-shapes are shown in Table 2-4.

**Angles.** The preferred material specification for angles is ASTM A572 Grade 50. Angles may be available in other strength, but the preferred material is shown in Table 2-4.

**Structural tees.** Structural tees are split from W-, M- and S-shapes to make WT-, MT- and ST-shapes, respectively. For the preferred material specifications and other suitable material specifications for structural tees, refer to the preceding sections on W-, M- or S-shapes, as appropriate.

**Rectangular (and square) HSS.** The preferred material specification for rectangular hollow structural sections (HSS) is ASTM A500 Grade C ( $F_y = 50$  ksi,  $F_u = 62$  ksi). Two notable options for HSS are A1065 and A1085. A1085 ( $F_y = 50$  ksi,  $F_u = 65$  ksi) provides actual wall thickness and tighter

corner radii tolerances for design. Additional benefits include a maximum yield stress of 70 ksi for A1085 and a defined standard for Charpy V-notch material toughness. The availability and cost-effectiveness of rectangular HSS in grades other than ASTM A500 Grade C should be confirmed prior to their specification. Since A500 Grade C requirements also meet the requirements of A500 Grade B, it is likely that you will receive A500 Grade C material regardless of what you specify. It is, therefore, best to specify Grade C to take advantage of the increased design strength. Rectangular HSS with atmospheric resistance (weathering characteristics) can be obtained by specifying ASTM A847 or A1065 Grade 50W. These and other material specifications applicable to rectangular HSS are shown in Table 2-4.

**Round HSS.** The preferred material specification for round HSS is ASTM A500 Grade C ( $F_y = 50$  ksi,  $F_u = 62$  ksi). This is a significant change from the 46-ksi yield stress that was previously the standard for round HSS specified as A500 Grade C. This change occurred in the revision to ASTM A500 Grade C in 2021. Note that A1085 ( $F_y = 50$  ksi,  $F_u = 65$  ksi) may also be specified for round HSS members for actual wall thickness. The availability and cost-effectiveness of round HSS in grades other than ASTM A500 Grade C should be confirmed prior to specification. Generally speaking, only round HSS with the same cross-sectional dimensions as steel pipe are stocked and readily available (see the “12 Tidbits” sidebar for further information). Round HSS with atmospheric corrosion resistance (weathering characteristics) can be obtained by specifying ASTM A847. These and other material specifications applicable to round HSS are shown in Table 2-4.

**Steel pipe.** The *Manual* lists ASTM A53 Grade B ( $F_y = 35$  ksi,  $F_u = 60$  ksi) as the preferred material specification for steel pipe used in structural frames—however, the following considerations should be addressed first. Round ASTM A500 Grade C can be specified using pipe dimensions instead of A53 to take advantage of the increased strength. A53 pipes need to be pressure tested, which results in an unnecessarily increased overall cost for less strength than what could have been obtained if round A500 Grade C was specified. Additionally, regional availability may play a factor, so be sure to contact your fabricator. See the sidebar “12 Tidbits” for further information.

Table 2-4  
Applicable ASTM Specifications for Various Structural Shapes

Steel Type	ASTM Designation	$F_y$ Yield Stress <sup>a</sup> (ksi)	$F_u$ Tensile Stress <sup>a</sup> (ksi)	Applicable Shape Series														
				W	M	S	HP	C	MC	L	HSS							
											Rect.	Round	Pipe					
Carbon	A36	36	58–80 <sup>b</sup>															
	A53 Gr. B	35	60															
	A500	Gr. B	46	58														
		Gr. C	50	62														
		Gr. D	36	58														
	A501 <sup>h</sup>	Gr. B	46	65														
	A529 <sup>c</sup>	Gr. 50	50	65–100														
		Gr. 55	55	70–100														
	A709	Gr. 36	36	58–80 <sup>b</sup>														
	A1043 <sup>d,g</sup>	Gr. 36	36–52	58														
Gr. 50		50–65	65															
A1085	Gr. A	50–70	65															
High-Strength Low-Alloy	A572 <sup>i</sup>	Gr. 42	42	60														
		Gr. 50	50	65														
		Gr. 55	55	70														
		Gr. 60 <sup>e</sup>	60	75														
	A618 <sup>h</sup>	Gr. Ia <sup>g</sup> , Ib & II	50 <sup>f</sup>	70 <sup>f</sup>														
		Gr. III	50	65														
	A709	Gr. 50	50	65														
		Gr. 50S	50–65	65														
		Gr. 50W	50	70														
	A913	Gr. 50	50	65														
		Gr. 60	60	75														
		Gr. 65	65	80														
		Gr. 70	70	90														
	A992	Gr. 50	50	65														
Gr. 60		60	75															
A1065 <sup>g</sup>	Gr. 50	50	60															
Corrosion-Resistant Quenched and Tempered Low-Alloy	A709	Gr. QST 50	50	65														
		Gr. QST 50S	50–60	65														
		Gr. QST 65	65	80														
		Gr. QST 70	70	90														
Corrosion-Resistant High-Strength Low-Alloy	A588	50	70															
	A847	50	70															
	A1065 <sup>g</sup>	Gr. 50W	50	70														

- = Preferred material specification.
- = Other applicable material specification, the availability of which should be confirmed prior to specification.
- = Material specification does not apply.

- Note: Referenced standards in Table 2-4 are intended to be the versions specified in AISC Specification Section A2.
- <sup>a</sup> Minimum, unless a range is shown.
- <sup>b</sup> For wide-flange shapes with flange thicknesses over 3 in., only the minimum of 58 ksi applies.
- <sup>c</sup> For shapes with a flange or leg thickness less than or equal to 1½ in. only.
- <sup>d</sup> For shape profiles with a flange width of 6 in. or greater.
- <sup>e</sup> For shapes with a flange or leg thickness less than or equal to 2 in. only.
- <sup>f</sup> Minimum applies for walls nominally ¾-in.-thick and under. For wall thickness over ¾ in. and up to 1½ in.,  $F_y = 46$  ksi and  $F_u = 67$  ksi.
- <sup>g</sup> This specification is not a prequalified base metal per AWS D1.1/D1.1M:2020.
- <sup>h</sup> ERW or seamless HSS only.
- <sup>i</sup> Type 1, 2, or 3 only.



Table 2-5  
Applicable ASTM Specifications for Plates and Bars

Steel Type	ASTM Designation		F <sub>y</sub> Yield Stress <sup>a</sup> (ksi)	F <sub>u</sub> Tensile Stress <sup>a</sup> (ksi)	Plates and Bars, thickness, t, in.													
					to 0.75	over 0.75 to 1.25	over 1.25 to 1.5	over 1.5 to 2	over 2 to 2.5	over 2.5 to 4	over 4 to 5	over 5 to 6	over 6 to 8	over 8				
Carbon	A36		32	58–80														
			36	Connecting elements	58–80													
				All other applications	58–80													
	A238 <sup>e</sup>	Gr. C	30	55–75						d								
		Gr. D	33	60–80						d								
	A529	Gr. 50	50	65–100		b	b	b	b	b								
Gr. 55		55	70–100		c	c	c	c	c									
A709	Gr. 36	36	58–80															
High-Strength Low-Alloy	A572 <sup>h</sup>	Gr. 42	42	60														
		Gr. 50 <sup>i</sup>	50	65														
		Gr. 55	55	70														
		Gr. 60 <sup>j</sup>	60	75														
		Gr. 65	65	80														
	A709	Gr. 50	50	65														
	A1043 <sup>e</sup>	Gr. 36	36–52	58														
		Gr. 50	50–65	65														
	A1066	Gr. 50	50	65														
		Gr. 60	60	75														
Gr. 65		65	80						f									
Gr. 70		70	85															
	Gr. 80	80	90		g													
Corrosion-Resistant High-Strength	A588		42 <sup>e</sup>	63														
			46 <sup>e</sup>	67														
			50	70														
Quenched and Tempered Alloy	A514 <sup>e</sup>		90	100–130														
			100	110–130														
Corrosion-Resistant Quenched and Tempered Low-Alloy	A709	Gr. 50W	50	70														
		Gr. HPS 50W	50	70														
		Gr. HPS 70W	70	85–110														
		Gr. HPS 100W <sup>e</sup>	90	100–130														
100	110–130																	

- = Preferred material specification.
- = Other applicable material specification, the availability of which should be confirmed prior to specification.
- = Material specification does not apply.

- Note: Referenced standards in Table 2-5 are intended to be the versions specified in AISC Specification Section A2.
- a Minimum, unless a range is shown.
  - b Applicable for plates to 1 in. thickness and bars to 3½ in. thickness.
  - c Applicable for plates to 1 in. thickness and bars to 3 in. thickness.
  - d Thickness is not limited to 2 in. in ASTM A283 and thicker plates may be obtained but availability should be confirmed.
  - e This specification is not a prequalified base metal per AWS D1.1/D1.1M:2020.
  - f Applicable for plates to 3 in. thickness.
  - g Applicable for plates to 1 in. thickness.
  - h Type 1, 2, or 3 only as given in Specification Table A3.1
  - i Round bars up to and including 11 in. diameter are permitted.
  - j Round bars up to and including 3½ in. diameter are permitted.

### Plate Products

Next, let's look at steel plate, which is summarized in Table 2-5.

**Structural plates.** ASTM A36 and A572 Grade 50 should be readily available for main member or weldment design. It is more common for plate material to ASTM A572 Grade 50 ( $F_y = 50$  ksi,  $F_u = 65$  ksi). If plate material is specified as A36 ( $F_y = 36$  ksi,  $F_u = 58$  ksi), it is very likely that you will be receiving an A572 Grade 50 plate since the mechanical properties of A572 Grade 50 meets the same requirements of A36. One caution when specifying plates over 4 in. thick. A572 Grade 50 material is not commonly available for plates over 4 in. thick. When ASTM A36 is specified for plates over 4 in. thick, the yield strength drops to 32 ksi rather than 36 ksi. One major change in the new Manual is the preference of material for connecting elements is now ASTM A572 Grade 50. This does not prohibit the use of A36, but it recognizes the prevalence of 50 ksi material in the supply chain. ASTM A36 is included as the preferred material for connecting elements with thicknesses of 4 in. through 8 in. The availability and cost-effectiveness of structural plates in grades other than these should be confirmed prior to their specification. Note that thickness ranges are also different for other grades, as shown in Table 2-5. Structural plates with higher yield and tensile strength can be obtained by specifying ASTM A572 Grade 55, 60, or 65; ASTM A529 Grade 55; ASTM A1066 Grade 60, 65, 70, or 80; or ASTM A514 Grade 90 or 100. Structural plates with atmospheric corrosion resistance (weathering characteristics) can be obtained by specifying ASTM A588 Grade 42, 46, or 50. These and other material specifications applicable to structural plates are shown in Table 2-5. For significant orders, ASTM A709 HPS 50 or 70 can be considered.

**Structural bars.** The preceding comments for structural plates apply equally to structural bars, though note that ASTM A514 is not applicable. While frequently falling in the same size ranges as plates, bars are a separate classification and are generally available in widths up to 8 in. The terminology section in the ASTM A6 Standard (see

*Selected ASTM Standards for Steel Construction including Structural Stainless Steel* provides thickness, width, and length definitions to differentiate between steel plates and bars.

**Raised-Pattern Floor Plates.** ASTM A786 is the standard specification for rolled steel floor plates. As strength considerations seldom control the floor-plate design, ASTM A786 “commercial grade” is commonly specified. In those cases, per ASTM A786-15, Section 5.1.3, “The product will be supplied with 0.33%

maximum carbon by heat analysis, and without specified mechanical properties.” Alternatively, if a defined strength level is desired, ASTM A786 raised-pattern floor plate can be ordered to a specific plate material specification, such as ASTM A36, A572, or A588; see ASTM A786 Sections 5.1.3, 7.1, and 8.1.

**Sheet and Strip.** Sheet and strip products, which are generally thinner than structural plate and bar products, are produced to such ASTM specifications as A606, A1008, or A1011. This is an “umbrella”

standard with many types and grades; the structural steel type is designated “SS” and the standards provide for grades from 25 or 30 to 80. High-strength low-alloy and high-strength low-alloy with improved formability are designated as HSLAS and HSLAS-F, respectively, and may also be specified if needed. When using shims and similar products, note that  $\frac{3}{16}$  in. is the minimum thickness to specify and receive a mill test report conforming to an ASTM standard material. Availability should be checked before specifying the grade.

## 12 Important Tidbits

Here are a dozen points to consider when specifying materials for your next project.

**1. When in doubt, check it out.** Have questions about availability? Call a fabricator or contact the AISC Steel Solutions Center ([solutions@aisc.org](mailto:solutions@aisc.org); 866.ASK.AISC). Either one can keep you swimming in available steel. Also, visit [aisc.org/aisc-membership](http://aisc.org/aisc-membership) to search for member providers.

**2. Times change.** When ASTM A992 was initially introduced, only W-shapes were covered. A later revision to this ASTM standard expanded its scope to include other hot-rolled structural cross sections (channels, angles, S-shapes, etc.), allowing them to be made to ASTM A992. Nevertheless, A992 still is not common in shapes other than W-shapes and channels.

**3. Round HSS  $\neq$  steel pipe.** Know the difference between ASTM A500 and ASTM A53. While ASTM A53 ( $F_y = 35$  ksi) is the listed preferred material for pipes, ASTM A500 ( $F_y = 50$  ksi for Grade C) can be specified instead of using pipe dimensions. See Tidbit 4 to learn how to specify pipe dimensions for round HSS.

**4. Generally speaking, only round HSS with the same cross-sectional dimensions as steel pipe are stocked and available.** Avoid specifying a round HSS with a cross section that does not match up to one of the steel pipe cross sections. This is much easier than it sounds; use round HSS with non-zero numbers after the decimal point. For example, HSS6.625 $\times$ 0.28 has the same cross section as a Pipe 6 Std. And it will generally be available, while

HSS6.000 $\times$ 0.250 is an HSS-only product and may require a mill-order quantity.

**5. Properly designate your HSS.** A round HSS is designated by outside diameter and wall thickness, each expressed to three decimal places—e.g., HSS6.625 $\times$ 0.28. A square or rectangular HSS is designated by nominal outside dimensions and wall thickness, each in rational numbers—e.g., HSS4 $\times$ 4 $\times$  $\frac{3}{8}$ . Rectangular HSS with even dimensions for sides—e.g., HSS6 $\times$ 4 $\times$  $\frac{5}{16}$ —is more readily available than odd-numbered dimensions—e.g., HSS5 $\times$ 3 $\times$  $\frac{3}{8}$ .

**6. Properly designate your steel pipes.** Use nominal pipe size (NPS) designation through NPS 12—e.g., Pipe 5 Std., Pipe 5 x-strong, or Pipe 5 xx-strong. Note that this notation has commonly been abbreviated for the examples given: P5, PX5, and PXX5, respectively. Above NPS 12, use the format “Pipe” followed by nominal diameter  $\times$  nominal wall thickness, each expressed to three decimal places—e.g., NPS 14 Standard is designated Pipe 14.000 $\times$ 0.375. The latter format also applies to any steel pipe size smaller than NPS 12 that does not have an NPS size.

**7. Don’t confuse anchor rods with structural bolts.** Do not specify your anchor rods as ASTM F3125 Grade A325 or A490. The ASTM F3125 standard covers headed bolts, with limited thread length, generally available only up to 8 in. in length and governed by provisions for steel-to-steel structural joints only. You say you’ve always specified your anchorage devices this way and it’s never been a problem? Well, the reality is that your fabricator has been nice not

to embarrass you by pointing out that you’ve specified a product that does not come in the length you likely specified—or as a hooked or longer-threaded rod. Use ASTM F1554, which covers hooked, headed, and threaded/nutted rods in three strength grades and even has only slightly greater tensile strength than A325 when specified as Grade 105. ASTM F3125 Grade A325 has a tensile strength of 120 ksi, while ASTM F1554 Grade 105 has a tensile strength of 125–150 ksi.

**8. Have all the information at your fingertips.** More extensive information can be found in the 16th Edition *Manual* (available in 2023) and the *Selected ASTM Standards for Steel Construction including Structural Stainless Steel* (available at [aisc.org/publications](http://aisc.org/publications)).

**9. Remember to specify** the alternate core location CVN requirement when you have heavy shapes or plates with CJP groove welds and subject to tension; see AISC *Specification* Sections A3.1c and A3.1d for further information.

**10. When specifying weathering steel plates or bars, think ASTM A588 first.** ASTM A242 is no longer commonly used and has been removed from Table 2-5 in the *Manual*.

**11. Use the MC12 $\times$ 14.3 for stair stringers.** Due to its flange width, the handrail pipe sizes will fit, as will the fillet welds used to connect them to this new channel with a wider flange.

**12. When in doubt, check it out and ask your fabricator.** Oh wait, this is number 1; well, it’s important enough that it warrants being the first and last consideration.



Fastening Products

Next, let's explore fasteners, summarized in Table 2-6.

**High-strength bolts.** The umbrella bolt standard ASTM F3125 includes grades that were previously manufactured under the standards ASTM A325, A490, F1852, and F2280 for high-strength bolts in steel-to-steel connections. Under the umbrella standard F3125, the previous ASTM standard designations become grades—i.e., Grade A325 and A490 and Grade F1852 and F2280. A325 and A490 are hex-headed bolts, while F1852 and F2280 are twist-off tension-controlled bolts. Additionally, the bolts were previously grouped by strength groups: Groups A (120 ksi), B (150 ksi), and C (200 ksi). Group C bolts were ASTM F3043 or F3111 bolts. An additional bolt was added to the AISC *Specification* in 2022. The new bolt standard ASTM F3148, with a tensile strength of 144 ksi, is introduced as an applicable material for spline drive bolts where the spline is used to pretension the bolt, but it does not twist off.

To more clearly designate these bolts, the previous Group letters were replaced by the material strength designations—i.e., Groups 120, 144, 150, and 200. Type 1 is the most commonly specified (medium-carbon steel). When atmospheric corrosion resistance is desired, Type 3 can be specified. While it is still formally permitted by the AISC

*Specification for Structural Steel Buildings* (ANSI/AISC 360, [aisc.org/specifications](http://aisc.org/specifications)) to use other material specifications in steel-to-steel bolting applications, the use of materials besides those identified in this article is relatively rare.

**Nuts.** The preferred material specification for heavy-hex nuts is ASTM A563. The appropriate grade and finish for steel-to-steel structural bolting applications are summarized in Section 2.3 of the 2020 *RCSC Specification for Structural Joints Using High-Strength Bolts* ([aisc.org/specifications](http://aisc.org/specifications)). If its availability can be confirmed prior to specification, ASTM A194 Grade 2H nuts are permitted as an alternative, as indicated in Section 2.3.2 of the *RCSC Specification*. While RCSC (Research Council on Structural Connections) is the authority on the use of nuts, Table 2 in the ASTM F3125 specification may have more up-to-date information and should be checked.

**Washers for structural bolts.** The preferred material specification for hardened steel washers is ASTM F436. This specification provides for both flat and beveled washers. An “extra thick” option is available for the cases in *RCSC Specification* Table 6.1 that require a special  $\frac{5}{16}$ -in. thickness (when oversized or slotted holes are used in the outer ply of a steel-to-steel structural joint).

**Washers for anchor rods.** In base plate applications, anchor rods' hole sizes

for anchor rods are usually larger than those for steel-to-steel structural bolting applications. AISC *Manual* Table 14-2 provides recommended hole sizes that correlate with anchor rod placement tolerances from ACI 117. Accordingly, washers used in such applications generally must be larger and require design consideration for proper force transfer, particularly when the anchorage is subject to tension. Table 14-2 is revised to reflect different material thicknesses for Grade 36, 55, and 105 anchor rods. Such anchor rod washers are generally made from rectangular plate or bar material.

**Compressible-washer-type direct-tension indicators.** When bolted joints are specified as pretensioned or slip-critical and the direct-tension-indicator pretensioning method is used, ASTM F959 compressible-washer-type direct-tension indicators can be specified. Type 325 is used with ASTM F3125 Grade A325 or F1852 assemblies, and Type 490 is used with ASTM F3125 Grade A490 or F2280 assemblies. ASTM F3148 bolts are pretensioned to the same tension as Group 150 bolts (Grade A490), so the A490 DTIs should be used for this application if DTIs are required. The use of these devices must conform to the requirements in the *RCSC Specification*, which provides detailed requirements for preinstallation verification (Section 7), installation (Section 8), and inspection (Section 9).

New Things

Here's a list of recent developments to help guide your material specifications.

- Several new W, WT, and HSS shapes are introduced in the 16th edition *Manual* and are listed below:
  - New W Shapes: W44x408, W44x368, W36x387, W36x350, W36x318, W36x286
  - New WT Shapes: WT22x204, WT22x184, WT18x193.5, WT18x175, WT18x159, WT18x143
  - For brevity, the entire list is not included here but note that there are 16 new square HSS shapes, 130 new rectangular HSS shapes, and 64 new round HSS shapes.
- It should be noted that the AWS A5.36 standard was previously introduced with the intention of combining A5.20 and A5.29 into a single specification covering both carbon steel and

low alloy steel flux cored arc welding electrodes. This standard is currently present in D1.1:2020, but it has since been withdrawn, with the two previous standards remaining as the applicable specifications.

- A new bolt standard, ASTM F3148, is introduced and is meant to provide a strength between that of F3125 Grade A325 and A490, hoping to supersede them both in the future. ASTM F3148 bolts are also able to be mechanically galvanized.
- Larger HSS. Until recently, ASTM A500 HSS was limited to  $\frac{7}{8}$ -in. thickness and 88-in. perimeter. It now permits HSS to 1-in. thickness and 88-in. perimeter. While the standards permit these larger sizes, they are not currently made in the U.S.; availability should be checked. HSS with sizes that exceed ASTM A500's 88-in. periphery limit can

also be obtained and are discussed in the article “Larger Hollow Structural Sections” in the November 2011 issue ([www.modernsteel.com](http://www.modernsteel.com)). This includes a discussion of ASTM A1065 shapes produced by forming two channels and welding them together.

- A channel especially for stair stringers. The MC12x14.3 that was recently added to ASTM A6 was conceived as a stair stringer. It has a  $2\frac{1}{8}$ -in. flange width, wide enough to accept the standard handrail pipe size and fillet weld around it. No more crimping the pipe or goobering the weld!
- Bigger HP-shapes. While not recently added to ASTM A6, the HP18 and HP16 series shapes provide for even higher pile strengths. Like all HP shapes, they have thicker webs ( $t_w = t_f$ ) and may help eliminate the need for stiffeners and doublers when used as columns.

**Anchor rods.** The preferred material specification for anchor rods is ASTM F1554, which covers hooked, headed, threaded, and nutted anchor rods in two strength grades: 36, 55, and 105. ASTM F1554 Grade 55 is most commonly specified, although grades 36 and 105 are generally available. Note that per Section 6.4 in ASTM F1554, when Grade 36 is ordered, the supplier may substitute weldable Grade 55 at their discretion. ASTM F1554 Grade 36 may be welded as is, and Grade 55 may be welded if ordered with Supplement S1; this is the more common approach when welding is required. Grade 105 may not be welded, as the heat will detrimentally affect performance. Several other ASTM specifications may also be used. ASTM A36, A193, A307, A354, A449, A572, A588, and A687 can be specified for applications involving rods that are not headed. All except A572 and A588 can be specified for applications involving headed rods.

**Threaded rods.** The preferred material specification for threaded rods, whether provided with plain or upset ends, is ASTM A36. Other material specifications that can be specified include ASTM A193, A307, A354, A449, A572, A588, and F1554. Note that ASTM A354 Grade BC and A449 are permitted to be used for bolts when the size required is outside the range of ASTM F3125 Grade A325. ASTM A354 Grade BD is permitted when the size required is outside the range of ASTM F3125 Grade A490. These standards are material standards, not bolt standards, so the desired dimensions must be specified as per ANSI ASME B18.2.6 heavy hex class 2A.

**Shear stud connectors.** Shear studs are specified as given in AWS D1.1 Clause 9, with material as required in Clause 9.2.6. Type B is usual, and the corresponding mechanical requirements are stated in AWS D1.1 Table 9.1 ( $F_y = 51$  ksi,  $F_u = 65$  ksi). When ordering, remember to add the required length by the amount of the “melt-off,” which depends on the number of deck plies the stud is shot through.

**Filler metal.** AWS provides specifications for filler metals in the A5 series of specifications. Typically, there are two filler metal specifications for each process: carbon steel for strengths up to E70 and low alloy for higher strengths or other properties such as weathering. These specifications provide chemical composition requirements for the filler metals and tensile property and CVN

Table 2-6  
Applicable ASTM Specifications for Various Types of Structural Fasteners

ASTM Designation	$F_y$ Min. Yield Stress (ksi)	$F_u$ Tensile Stress <sup>a</sup> (ksi)	Diameter Range (in.)	Bolts					Washers				Anchor Rods					
				High-Strength					Nuts	Hardened	Plain	Direct-Tension Indicator	Threaded Rods	Hooked	Headed	Threaded & Nutted		
				Conventional	Twist-off-type Tension Control	Fixed-end Tension Control	Common Bolts											
ASTM F3125	Gr. A325 <sup>d</sup>	–	120	0.5 to 1.5	■													
	Gr. F1852 <sup>d</sup>	–	120	0.5 to 1.5		■												
	Gr. A490 <sup>d</sup>	–	150	0.5 to 1.5	■													
	Gr. F2280 <sup>d</sup>	–	150	0.5 to 1.5		■												
F3111	–	200–215	1 to 1.25															
F3043	–	200–215	1 to 1.25															
F3148 <sup>d</sup>	–	144	0.5 to 1.25															
A194 Gr. 2H	–	–	0.25 to 4															
A563	–	–	0.25 to 4															
F436	–	–	0.25 to 4 <sup>b</sup>															
F844	–	–	any															
F959	–	–	0.5 to 1.5 <sup>b</sup>															
A36	36	58–80	to 15															
A193 Gr. B7	105	125	to 2.5															
	95	115	over 2.5 to 4															
	75	100	over 4 to 7															
A307 Gr. A	–	60	0.25 to 4															
A354	Gr. BC	109	125	0.25 to 2.5	e									e				
		99	115	over 2.5 to 4	e									e				
	Gr. BD	130	150–173	0.25 to 4	e									e				
A449 <sup>d</sup>		92	120	0.25 to 1	e									e				
		81	105	over 1 to 1.5	e									e				
		58	90	1.75 to 3	e									e				
A572		Gr. 42	42	60	to 6													
		Gr. 50	50	65	to 4 <sup>c</sup>													
		Gr. 55	55	70	to 2.5													
		Gr. 60	60	75	to 3.5													
		Gr. 65	65	80	to 2													
A588		50	70	to 4														
		46	67	over 4 to 5														
		42	63	over 5 to 8														
F1554		Gr. 36	36	58–80	0.25 to 4													
		Gr. 55	55	75–95	0.25 to 4													
		Gr. 105	105	125–150	0.25 to 3													

- = Preferred material specification.
- = Other applicable material specification, the availability of which should be confirmed prior to specification.
- = Material specification does not apply.

- Note: Referenced standards in Table 2-6 are intended to be the versions specified in AISC Specification Section A2.
- Indicates that a value is not specified in the material specification.
- a Minimum unless a range is shown or maximum (max.) is indicated.
- b For use with fasteners with diameter range given.
- c ASTM A572 permits rod diameters up to 11 in., but practicality of threading should be confirmed before specification.
- d When atmospheric corrosion resistance is desired, Type 3 can be specified.
- e See AISC Specification Section J3.2 for limitations on use of ASTM A449, A354 Gr. BC and A354 Gr. BD.





toughness requirements for weld metal produced to specific classification test requirements. It should be noted that the AWS A5.36 standard was previously introduced with the intention of combining A5.20 and A5.29 into a single specification covering both carbon steel and low alloy steel flux cored arc welding electrodes. This standard is currently present in D1.1:2020, but it has since been withdrawn, with the two previous standards remaining as the applicable specifications.

### Other Products

In addition to typical structural products, there are other related steel products to consider.

**Steel castings and forgings.** Steel castings can be produced in a wide variety of chemical compositions and mechanical properties; most are heat-treated. Two standards useful in steel structures are ASTM A27 Grade 65-35 and ASTM A216 Grade 80-35. Steel forgings are specified as ASTM A668.

**Crane rails.** Crane rails are furnished to ASTM A759, ASTM A1, and/or the manufacturer’s specifications and tolerances. Rail is designated by unit weight in units of pounds per yard. Dimensions of common rail are shown in the AISC *Manual* Table 1-21; other rail profiles also exist and may be available. Most manufacturers chamfer the top and sides of the crane railhead at the ends unless specified otherwise to reduce chipping of the running

surfaces. Often, crane rails are ordered as end-hardened, which improves the crane rail ends’ resistance to impact from contact with the moving wheel during crane operation. Alternatively, the entire rail can be ordered as heat-treated. When maximum wheel loading or controlled cooling is needed, refer to manufacturer catalogs. Purchase orders for crane rails should be noted as “for crane service.” Light 40-lb rails are available in 30-ft lengths, standard rails in 33-ft or 39-ft lengths, and crane rails up to 80 ft. Consult manufacturer for availability of other lengths. Rails should be arranged so that joints on opposite sides of the crane runway will be staggered with respect to each other and with due consideration to the wheelbase of the crane. Rail joints should not occur at crane girder splices. Odd lengths that must be included to complete a run or obtain the necessary stagger should be no less than 10 ft long. Rails are furnished with standard drilling for splice bars in both standard and odd lengths unless stipulated otherwise on the order.

### A Note on Bridges

Another possibility for structural shapes and plates is ASTM A709, which is an “umbrella” standard that assembles ASTM A36, A572, A992, A588, A1010, three high-performance steel (HPS) grades, and four quenched and self-tempered (QST) grades into a convenient single standard for bridge designers and fabricators. The HPS grades

are available in plate form only. Grade 50S is available in shapes. The other grades are available in plate form and shapes, though availability should be confirmed prior to specification. ASTM A709 provides toughness levels for three exposures and two uses. Much of the material supplied to A709 meets one of those toughness levels. Material furnished to ASTM A709 grades is acceptable for use where the corresponding parent standard is specified.

### Staying Up to Speed

While the fundamentals of steel design and construction stay constant, shapes, strengths, and steel products continue to evolve—and so do the publications that provide guidance on them. Staying up to date with the right specifications for your various steel shapes is one of the key methods for getting the most out of your steel framing system. ■

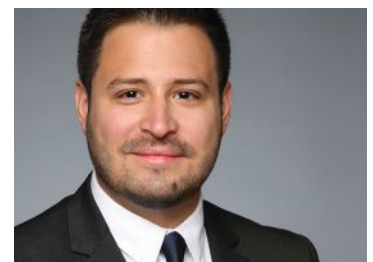

**Jonathan Tavarez** ([tavarez@aisc.org](mailto:tavarez@aisc.org)) is AISC’s structural steel specialist for the New York City market.



## FAST. ECONOMICAL. SUSTAINABLE.



Hybrid systems featuring steel frames and timber floors are the ideal choice for residential buildings.

AISC's new Design Guide 37: *Hybrid Steel Frames with Wood Floors* provides you with the latest information to make these innovative structures a reality. And you can for a limited time you can download a FREE COPY of this valuable resource at no charge by visiting

[aisc.org/hybrid411](https://aisc.org/hybrid411)

A new dorm for the Rhode Island School of Design: Six stories, hybrid steel frame with wood floors, just 2.5 weeks to erect.



**Smarter.  
Stronger.  
Steel.**



# Rough Waters

BY JOE DARDIS

As we navigate the turbulent seas of construction pricing, remember that we're all in the same boat.

Fig. 1. Scrap, Shapes, and Fabricated Steel Cost Index

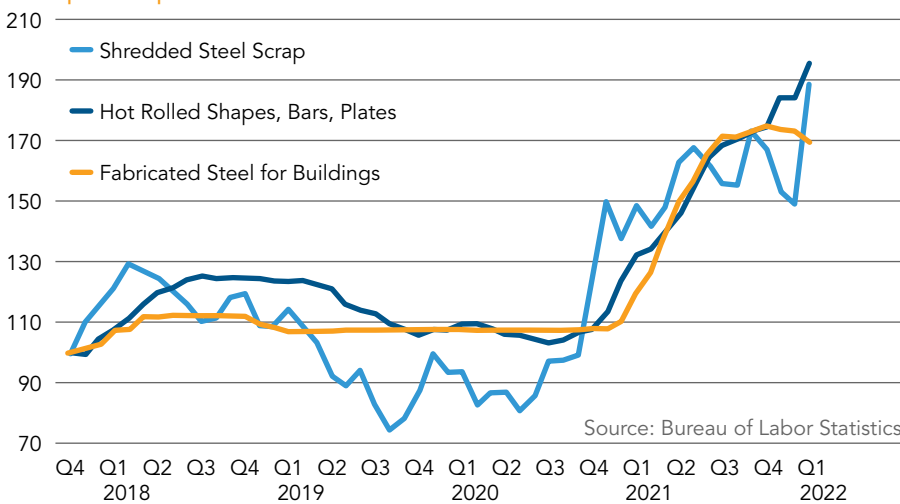

**TO SAY THE LAST FEW YEARS** have led to uncertainty in the construction industry would be an understatement.

This is particularly true when it comes to material prices, including steel. It's important to remember that there are many different types of steel products, and prices for these products can vary greatly. Headlines such as "Steel prices have tripled" can be alarming at first, but they don't typically refer to all steel products. While hot-rolled sections, steel coil, or rebar will periodically experience price jumps, they typically don't all jump at once. Also, keep in mind that while all of these products are used in building construction, some of them are used much more heavily in other industries. Coil, for instance, is used to make steel deck and hollow structural sections (HSS), but it is used in even greater quantities in the automotive sector. This can cause increased volatility in prices as these other industries scramble to secure enough material when supply is disrupted. And as wide-flange pricing has steadily climbed over the past few years to roughly two times the amount from 2020, coil pricing has looked much more like a roller coaster, increasing 450% in 2021 before coming back down in early 2022, followed by another sudden upswing shortly after the start of the Russia-Ukraine conflict.

The other important component to consider when it comes to steel price fluctuations is input costs. In the case of hot-rolled shapes, this means scrap pricing. Figure 1 shows the price index of shredded steel scrap and how it relates to hot-rolled shapes and ultimately fabricated structural steel prices. Scrap and

Fig. 2. Material Price Index

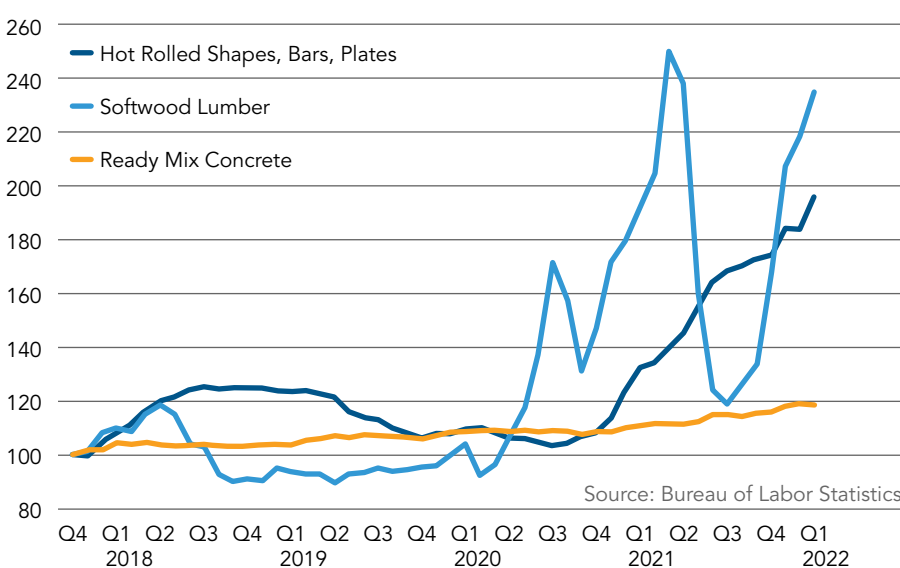

hot-rolled shape prices, for the most part, fall and rise together and have both roughly doubled in the past few years, inferring that the fluctuations in hot-rolled prices have more to do with input prices than supply disruptions.

What does all this mean for the structural steel industry? Will price volatility make steel less competitive in the construction market? The short answer (and good news) is: No. Figure 2, which shows the price index for steel, lumber, and concrete, tells us that all framing materials have been experiencing price increases lately. At first glance, it may seem like concrete is gaining a competitive advantage. However, keep in mind that all the rebar used in concrete construction has been subjected to the same supply disruptions and input cost increases that steel shapes have endured. At the end of the day, project costs have increased regardless of which material is selected. This can be further seen in Figure 3, which shows the cost index for different project types over the last several years regardless of framing material.

Bottom line, steel is no less competitive today than it was two years ago. Yes, steel prices have increased dramatically, but all material prices have increased dramatically. While this does present some challenges for fabricators and the design community, particularly when trying to address project budgets and bid prices, it is one that every other trade is also going through. And for those of you who influence framing material choices, this is an important point to make to your customers. ■



**Joe Dardis** ([dardis@aisc.org](mailto:dardis@aisc.org)) is AISC's senior structural steel specialist for the Chicago market.

Fig. 3.  
Project Cost Index

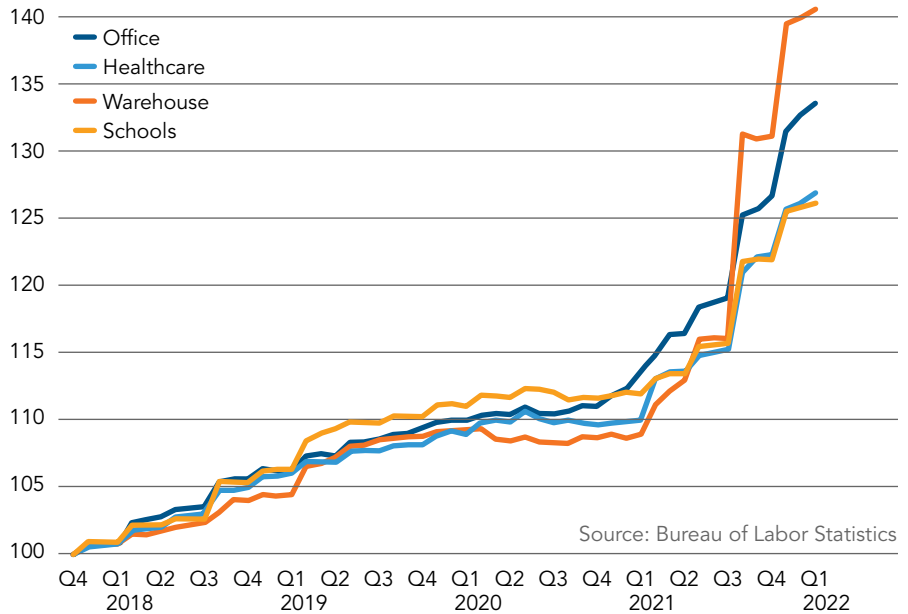



**METAL DECK...**

ANY SIZE.  
ANY PLACE.  
ANY TIME.

**YOUR ONE-STOP  
METAL DECK SHOP!**

CONTACT US TODAY FOR THE BEST  
SERVICE AND LEAD TIME



LARGEST INVENTORY IN  
STOCK FOR IMMEDIATE USE



15 LOCATIONS TO  
SERVE YOU



PICK UP OR DELIVERY



KNOWLEDGEABLE STAFF

800.894.7741 | [SALES@METALDECKSUPPLY.COM](mailto:SALES@METALDECKSUPPLY.COM)

**METALDECKSUPPLY.COM**



# Intercontinental Connection

INTERVIEW BY GEOFF WEISENBERGER

Gian Rassati, a 2022 AISC Special Achievement Award winner, began life in a small Italian mountain town and has gone on to do big things in bolting research.



Rassati (center) being presented his AISC Special Achievement Award by AISC president Charlie Carter and AISC board chair Steve Knitter at the 2022 NASCC: The Steel Conference in Denver.

**IF YOU ATTENDED** the Wednesday keynote session at NASCC: The Steel Conference in Denver in March, chances are that you saw Gian Andrea (aka G.A.) Rassati.

He was one of this year's award winners, having earned an AISC Special Achievement Award, along with his colleague James Swanson (both are associate professors at the University of Cincinnati), for his research on the behavior and design of bolted steel connections as well as major contributions to the latest national design specifications for high-strength steel bolts, including the *RCSC Specification*.

I was able to sit down with Rassati (as well as several other 2022 award winners) at NASCC, where we chatted about bolts, teaching, sports, Cincinnati, and other topics.

## First of all, congratulations on the Special Achievement Award!

Thank you very much. That was an unexpected reward, and that made it that much better.

## So can you tell me a bit about your professional journey?

My hometown is a little ski village in the Alps in the northeastern corner of Italy, not very far from the borders with Austria and Slovenia. When I was working on my master's thesis, which involved the simulation of bolted partially restrained composite connections, I had an opportunity to contact Roberto Leon, who had done a lot of testing at the University of Minnesota, and I stayed in touch with him. I enjoyed doing research, so I stayed on for my PhD at the University of Trieste, and then I saw Roberto at one of the European committee meetings. He mentioned there were some tests being done at Georgia Tech where he was and asked me if I was interested in



Field Notes is *Modern Steel Construction's* **podcast series**, where we interview people from all corners of the structural steel industry with interesting stories to tell. Listen in at [modernsteel.com/podcasts](https://modernsteel.com/podcasts).

coming and helping out. And so I came to the United States and worked with him and with whom I was very pleased to be sharing the stage this morning [Leon was this year's AISC Geerhard Haaijer Award for Excellence in Education winner]. And he basically became my second family.

It's a trite expression that we stand on the shoulders of giants, but Jerry Hajjar, who just got inducted into the National Academy of Engineering, was the next person I worked with because after Georgia Tech, I got a call from Jerry asking me if I was interested in a post-doc at the University of Minnesota. I said yes, so that's how I stayed in the U.S. After that, I applied for a teaching position and landed in Cincinnati. And I've been there for 20 years.

**So what's new with bolts?**

There's always something brewing in the industry, which is awesome and part of the pleasure of doing research in collaboration with the steel industry. There's always something new, something different, to be investigated. In the last probably five to seven years, two major types of bolts came to the surface, and I had the opportunity to do most of the research work associated with them. Folks are always coming up with new ideas, like blind bolts or connections that can be done without having to hold one side of the connection, better ways of tightening bolts, better materials, and better coatings.

**What courses are you currently teaching?**

I teach a slew of different courses. I occasionally teach steel design, but that's mostly Jim Swanson's purview. I teach structural dynamics, earthquake engineering, finite element analysis, and a lot of undergraduate analysis classes. I always say that 50% of my time is spent teaching, 50% is doing research, and 50% is doing service.

**You've been at the University of Cincinnati for 20 years, which is basically a generation. Do you think college students have changed over that time? Has teaching changed?**

Yes, I think college students have changed. But I need to preface my answer by saying that I also think I've changed.

I'm 20 years older now, so I may be getting more cranky and curmudgeonly. The relationship I had with students when they were only seven or eight years younger than me, when I started, is different now. They're still the same age, but I'm older now. So it's tough to separate the observation of how students have changed versus my own evolution. But my impression is that students nowadays seem to be more focused on overall career goals than their education itself. And so we need to find new ways to provide them with the tools they need to actually become successful in the profession and not so focused on simply what boxes to check to get a degree. The continuous challenge is to find ways to motivate students to actually want to learn more, to be more involved. And I applaud what AISC has done for students, making it affordable for them to come to this conference and meet all these people. It's good to get the classroom experience and then also come to a show like this and actually see people who have been in the profession for a while.

**Do you have advice for students that are considering a career in the steel industry, whether it's as an engineer or some other area?**

I must say that it's been a blast working with everyone in the steel industry. It's always interesting, and it appeals to any kind of taste. There's hands-on work that can be done, and there are the super-cool problems to be solved. There is the ultimate satisfaction of being able to point out that something that has been done based on your work and that many people use. And I always think that's what brought me to engineering in the first place. Working within the steel industry has been a pleasure for the last 20 years, and I look forward to 20 more years.

**Have you grown to love anything in particular about Cincinnati?**

It's a nice place to live. The cost of living is not crazy. What I typically tell visitors or candidates interviewing for positions here is that it is a small big city. You can find basically anything you find in a big city, including traffic, but it's smaller and more manageable. And, you know, I'm Italian, so I appreciate good food and there are a lot

of nice restaurants in Cincinnati. I'm also a carnivore, and there are some really top-notch steak houses around, so I'm a pretty happy camper.

**Speaking of Cincinnati, the Bengals made it to the Super Bowl. Do you think Joe Burrow will eventually lead the team to a championship?**

He was very close this time, and there's certainly promise for the future. There was an excitement in town this season—and really, even over the past several years when the team wasn't as good, the excitement never quite died down. But the town was crazy over the last season. As an Italian that really loves soccer, I also enjoy American football and loved seeing the high level of play this year and that level of excitement in town. It's been a good year for Cincinnati sports since the Bearcats football team also made it to the playoffs. For being what's predominantly known as a basketball university, we did pretty well in football.

**OK, so as an Italian soccer fan, who's your favorite team back in Italy?**

That's an easy answer: Juventus F.C. in Torino. It was my dad's team, so it easily became my team. ■

*This column was excerpted from my conversation with G.A. To hear more from him, including his thoughts on Cincinnati chili, check out the June Field Notes podcast at [modernsteel.com/podcasts](http://modernsteel.com/podcasts). G.A. was one of several AISC award winners that I interviewed at this year's Steel Conference in Denver. We will post videos of all the interviews later this year on AISC's YouTube channel at [youtube.com/AISCSteelTV](http://youtube.com/AISCSteelTV).*



**Geoff Weisenberger** ([weisenberger@aisc.org](mailto:weisenberger@aisc.org)) is chief editor of *Modern Steel Construction*.



# A Letter to Entry-Level Engineers

BY RYAN CURTIS, PE

Advice for today's young engineers on their way to becoming tomorrow's engineering leaders.

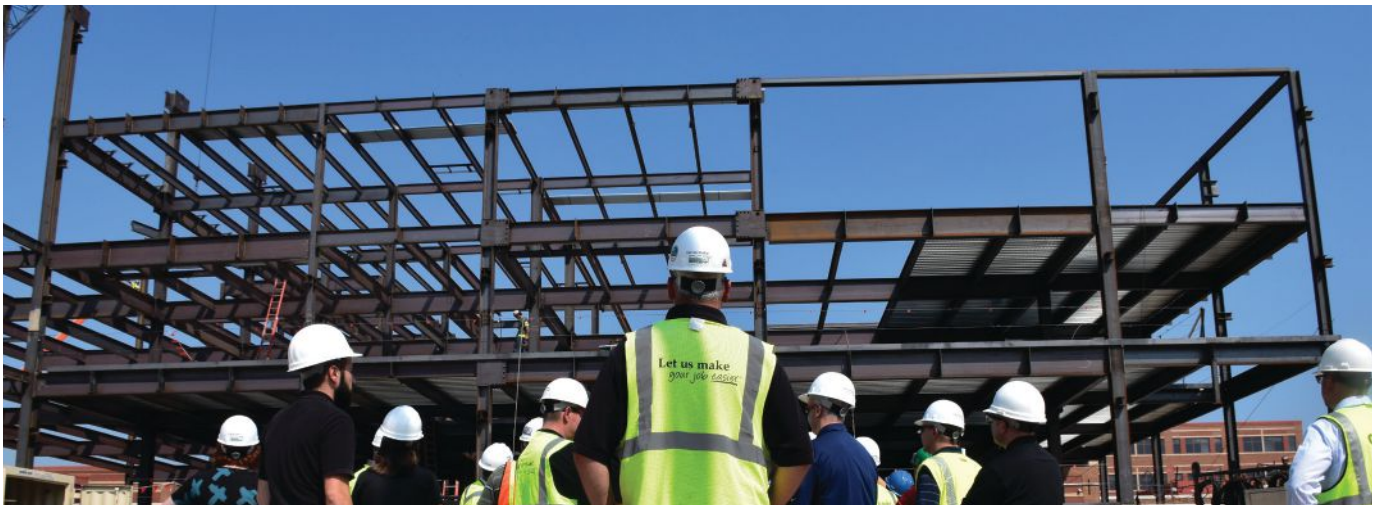

**THEY DON'T TEACH** you everything you need to know in school.

While colleges and universities do an excellent job of preparing engineering students how to be, well, engineers, the right types of experiences are often the best education for becoming engineering leaders.

Here are some tips for young engineers in training and those that are newly licensed—and really, they're also good reminders for those of us that have been in the profession for a little while—that can help you navigate the nuances of the profession and help you grow into leadership roles.

Hone your technical skills. With licensure requirements changing in the engineering profession, some new graduates are entering the workforce with only experience requirements left to gain licensure. Regardless of the timing of your PE or SE exam, those initial years of working are the best time to focus on your craft and gain the necessary knowledge of structural analysis and design. Being a balanced professional in other areas of the job, such as community engagement and young professional networks, is always beneficial, but be sure to maintain focus

on your technical skills, as they will serve as the foundation for your growth and eventual leadership opportunities in the engineering industry. Dedicate time to understanding and reviewing gravity and lateral load paths, strength of materials, and building behavior serviceability requirements. There are many excellent AISC Design Guides available ([aisc.org/dg](http://aisc.org/dg)) to help you dive into various technical aspects of the structural steel design and building. Also, when given the opportunity to go on a job-site tour, don't hesitate. General contractors, steel erectors, and special inspectors are incredible resources for an emerging engineer—plus, they can offer advice (often in the form of constructive criticism) on how you, as an engineer, can make *their* jobs go more smoothly.

**Work smarter, not harder (but working hard is always welcomed).** When starting design tasks, build rhythms to kicking off projects and undertaking basic assignments. These rhythms should always start with defining loading assumptions and material strengths before the design work begins. This routine will help with organization when projects and tasks become larger and more challenging. Don't

be too quick to jump to the computer and start modeling before you understand and define your baselines and desired outcomes. A quick hand calc is often faster and more effective than developing a rushed 3D analytical model! Remember, your employer needs your speed, and PE and SE exams don't allow computer software usage at your leisure. Don't forget the art of pencil and paper. The need to be able to draw up a connection concept when on a job site or in a project team meeting when you are only carrying paper and pencil (or pen and napkin) is critical—and unfortunately, it's become a bit of a lost art. But you can help revive it as standard practice. (Plus, it's fun.)

Mistakes will be more common early in your career. Learn from them, write them down, and ensure you remember them. Mistakes early in your design career are usually of a much smaller magnitude than a design error when you are a senior engineer.

**Engage your nonstructural colleagues.** Whether you work for a structural consulting firm or a full-service architecture and engineering firm, you are surrounded by experts in their respective fields. Take advantage of this opportunity to learn the roles of other disciplines and

their relation to you as a structural designer. As you become more familiar with chillers, air handlers, generators, envelope detailing, and slab depressions for tile flooring, you will become a more well-rounded engineer and a more valuable player on your project team. Ideally, when you become busy, it will not be due primarily to workload but rather because all of the project managers will want you on their team!

**Start small so as not to feel overwhelmed.** “Learning to walk before you run” is applicable in just about any professional development scenario. If you are assigned a one- or two-day task from your supervisor, communicate deadlines and the deliverables clearly. If you are assigned to a mega-task (weeks or months of analysis or design time), start with the fundamentals of engineering statics and material strengths to keep you on the right path. Check in with your supervisor at agreed-upon times when direction is needed or when you have deliverables to present.

**CEUs are not just for the “licensed.”** Many organizations, such as AISC, offer free learning opportunities throughout the year. These may be in-person or web-based training sessions. Even if you are not a licensed engineer seeking continuing education credits, these training opportunities can spur your development in specific learning areas. Learning opportunities with local engineering organization chapters in your city or state are also a great opportunity to network with other younger professionals and industry leaders.

**Don’t limit your project and material exposure.** Many structural firms work in specific client markets such as commercial, healthcare, or residential, whereas others touch many markets and different building types and shapes. If you feel you are limited in your project type exposure, ask your supervisor for different project types. This will set you up for your engineering PE/SE exam success and make you a more valuable engineer for your current and potential future employers. If the diversity of building shapes (high-rise, mid-rise, low-rise) or specific materials are not available, take time outside of your work hours to study other design methods or material types. You will inherently benefit from the knowledge gained—and when that big job finally shows up on your desk, you will be more than ready to take the task.

**Embrace community involvement.** If you are intrigued or eager to serve, look outside of your company to find a non-profit/community/church/arts group that appeals to you. Engineers bring unique perspectives and solutions to other organizations in our communities. Engineers are the problem-solvers of the world, and our skills don’t always have to be used for solving second-order forces on a steel building frame. They can be used for sharpening processes or communication gaps in other organizations. The most well-rounded engineers are often noted for their mentoring connections and the services they bring to their community. The relationships you develop in the earlier years of your career in and outside of the architecture/engineering/construction industry will play a significant role in the middle and later years of your life, both personally and professionally. Use your problem-solving skills for the greater good.

**Understand the “business.”** Don’t feel obligated to jump the gun on an MBA until you at least first understand the business practice of your firm. Find a mentor in your organization that leads a specific team of interest to you. This could be a C-suite leader (technology, finance, marketing), a project manager, or even a business development representative. Ask them questions to become better informed on ways you can assist and improve your firm. What makes engineers valuable? How do we market our services? How do we build fees for projects? What are our operating costs? What are the risks we take on when we start a new project? Learning the business from the outside in will give you a better perspective of your role within your organization and will help inform you on the nuances that make companies sustain excellence.

**Don’t ignore COVID impacts.** COVID has disrupted the office environment for well over two years, and it has drastically altered work on what would appear to be a permanent basis. Working from home and physical separation from teammates and mentors, while beneficial in many ways, has hampered career growth for a large portion of the workforce in and outside of the AEC community. When working from home, take time to regularly check in with your mentors and supervisors to see how they feel you’ve

been performing. Unfortunately, for many organizations, employee reviews and performance feedback have been delayed or even nonexistent over the duration of the pandemic. This is not acceptable. Check in and seek out positive critiques as much as possible. Steel sharpens steel, so embrace advice and performance feedback as much as you can tolerate.

**Implement communication technology appropriately.** Communication across project teams has become very dependent on emails, online video chats, and other web-based methods. At the very least, learn these communication devices well so you can share images, videos, notes, and ideas without letting the technology slow you down. The good news is that if you are a younger engineer, you have likely already embraced these technologies faster than some of your more experienced coworkers. That said, you should understand and respect your colleagues’ preferences when it comes to the best ways to communicate and coordinate with the various platforms available.

As a younger professional, be sure to dedicate some time to long-range career planning and set milestones and goals. These goals and the above tips can help put you in a position to make a positive difference in your organization and community while also making you a stronger, more connected, empathetic, and impactful leader. The engineering and construction industry is stronger than ever, and it will need the best and brightest (you!) to carry it to new heights—as well as to prepare the next generation when you are the seasoned professional and no longer a young engineer yourself. ■



**Ryan Curtis** ([rbcurtis@leoadaly.com](mailto:rbcurtis@leoadaly.com)) is a senior structural engineer and project manager with LEO A DALY in Omaha.



# Immersive Installation

BY JOHN JUCHA, SE, SHAUN FRANKLIN, PE,  
AND MICHAEL OLSEN, PE



Steel helps arts and entertainment company  
Meow Wolf achieve its  
immersive vision with a quirky new venue on a tight site in Denver.

**MEOW WOLF'S GOAL** is to create an immersive art experience that transports visitors into new dimensions, urging them to explore their own imaginations and reconsider what's possible—and its new Denver outpost needed a space that could appropriately accommodate its artistic ambitions.

The build-to-suit 90,000-sq.-ft structure not only needed to meet the needs of a one-of-a-kind art installation but also the constraints of a small, angular building site between a series of elevated roadways. On top of that, it also needed to be designed for potential adaptation to a future storage facility. This dual functionality created some interesting design challenges, including a large building grid in a tight footprint, heavy storage floor loads, and large floor openings that would need to be infilled for the conversion to occur.

In addition, Meow Wolf, whose flagship installation is located in Santa Fe, N.M., expressed the need for anchor exhibits that would stand multiple stories high, creating the need for long-span floor beams and design loads to accommodate structures within the structure. These tall exhibit spaces were also adjacent to the

building perimeter, creating varying boundary conditions and load cases for the perimeter columns between the storage case and museum case. For the majority of the structure, a 250-psf heavy storage live load controlled the floor design; however, the areas supporting multi-story exhibits and large-scale rockwork theming controlled the local design of several beams. This unique dual design criteria required the engineering team to carry out multiple parallel building analyses during the design phase and then determine the controlling design case for each structural element before incorporation into the construction documents.

The building also includes multiple catwalks, exhibit-focused structural elements, ramps, unique stair geometries, tilted tunnels, and very specific artist-driven standalone structures. In order to create a versatile structure that could support multiple occupancies, unorthodox geometries, and future retrofit possibilities, as well as Meow Wolf's requirement for minimal columns, the design team turned to structural steel for the framing system (incorporating 865 tons of structural steel in all).



All images: KL&A Engineers and Builders unless otherwise noted

Meow Wolf, whose first location is in Santa Fe, N.M., chose Denver as its second location for displaying its whimsical, surreal art displays. Some of the taller exhibits necessitated long-span steel floor beams and design loads that could accommodate structures within the structure.



## Contractual and Site Challenges

One of the largest challenges to the project came from the structural building contract and the tenant improvement contract bumping into each other. Many of the exhibit structures were large pieces of steel that needed to find their way into the building. Rather than finding solutions to fitting the pieces through the doors, the team proposed to condense the entire design schedule, fast-tracking both the steel package and the tenant improvement process to ensure all the major steel components were in the building prior to the roof placement.

Another major challenge was the site itself, whose location between three elevated highways dictated the “lazy pizza” shape and aesthetic of the building, which includes very few 90° angles and plenty of heavily skewed connections. The material laydown area was outside of the triangular site, so the steel had to be hauled underneath the overpass before it could be hoisted by crane. And in an effort to eliminate the use

of cranes over the surrounding roadways, the team elected to place a crane within one of the building’s elevator cores.

The gravity systems for the primary structure and the secondary exhibit structures were all highly unique from each other and from the way they are traditionally laid out in standard buildings. Because there were fewer connections and many of the connections involved skew between the supporting and supported members, what would normally be conventional connections became heavily loaded connections that required a lot of attention and innovative customization. For example, some of the most interesting connections are on the *Cosmobedron* art exhibit structure. The framing is made up of W4 and W8 members in a circular shape and employs tension ring connections and moment connections on very small members. Because both structural design and steel detailing took place in parallel due to the fast-track nature, the design team took advantage of the connection design capability of SDS2 to back-check hand calculations.





Meow Wolf explored multiple locations in Denver for its new facility, ultimately choosing an unorthodox option: a tight, triangular parcel of land between three highways that informed the building's shape.

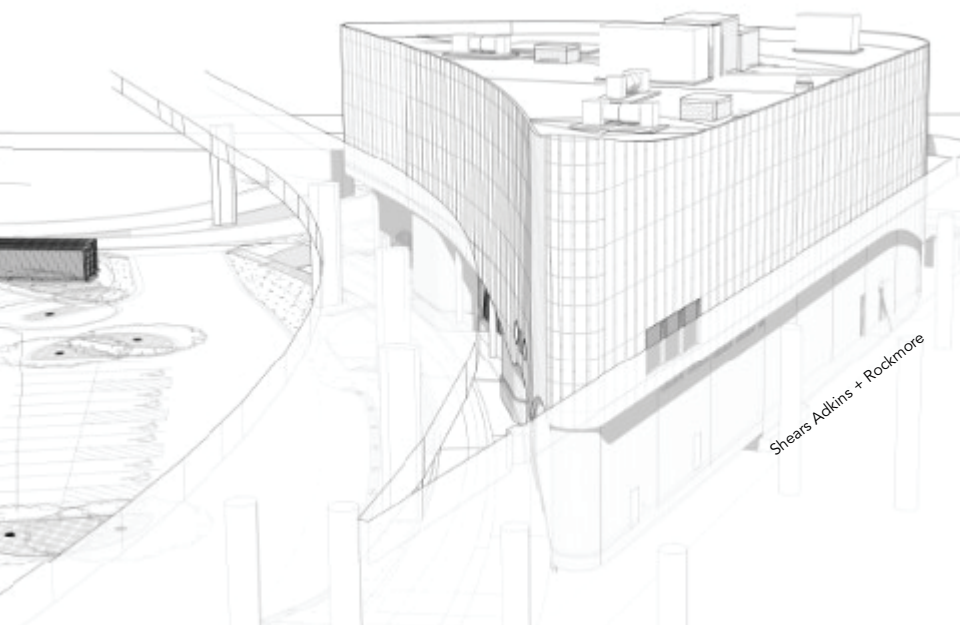

Another structural design consideration that necessitated a high degree of team collaboration was the deflection and vibration performance of the serpentine catwalks. The catwalks and viewing platforms, which are part of the tenant improvement design, slope and weave throughout the three-story open volumes. The structural design team considered the effects of differential and compound deflections along these catwalks, with some catwalks being attached to the building columns and others hung from the roof above or posted down to a transfer beam below.

The geometry and number of column transfers also complicated the vibration analysis. To address this issue, the team created RISA 3D design models of the catwalks to run modal analyses and check their natural frequencies in both the vertical and horizontal directions against the recommended design criteria AISC Design Guide 11: *Vibrations of Steel-Framed Structural Systems Due to Human Activity* ([aisc.org/dg](http://aisc.org/dg)). As a result, beam sizes were adjusted to meet the vertical criteria, and the team also discovered that using the





above: The steel had to be hauled underneath an overpass from its laydown area before it could be hoisted by crane.

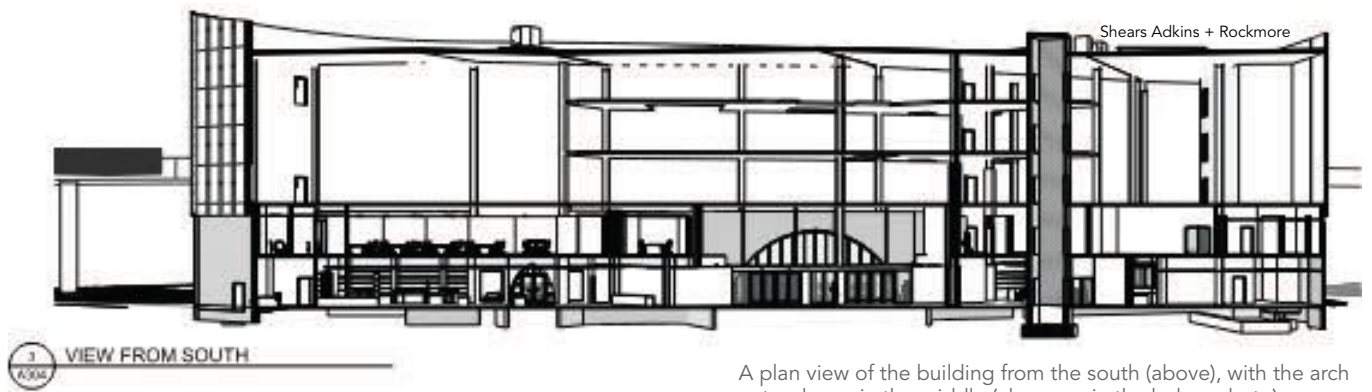

A plan view of the building from the south (above), with the arch entry shown in the middle (also seen in the below photo).

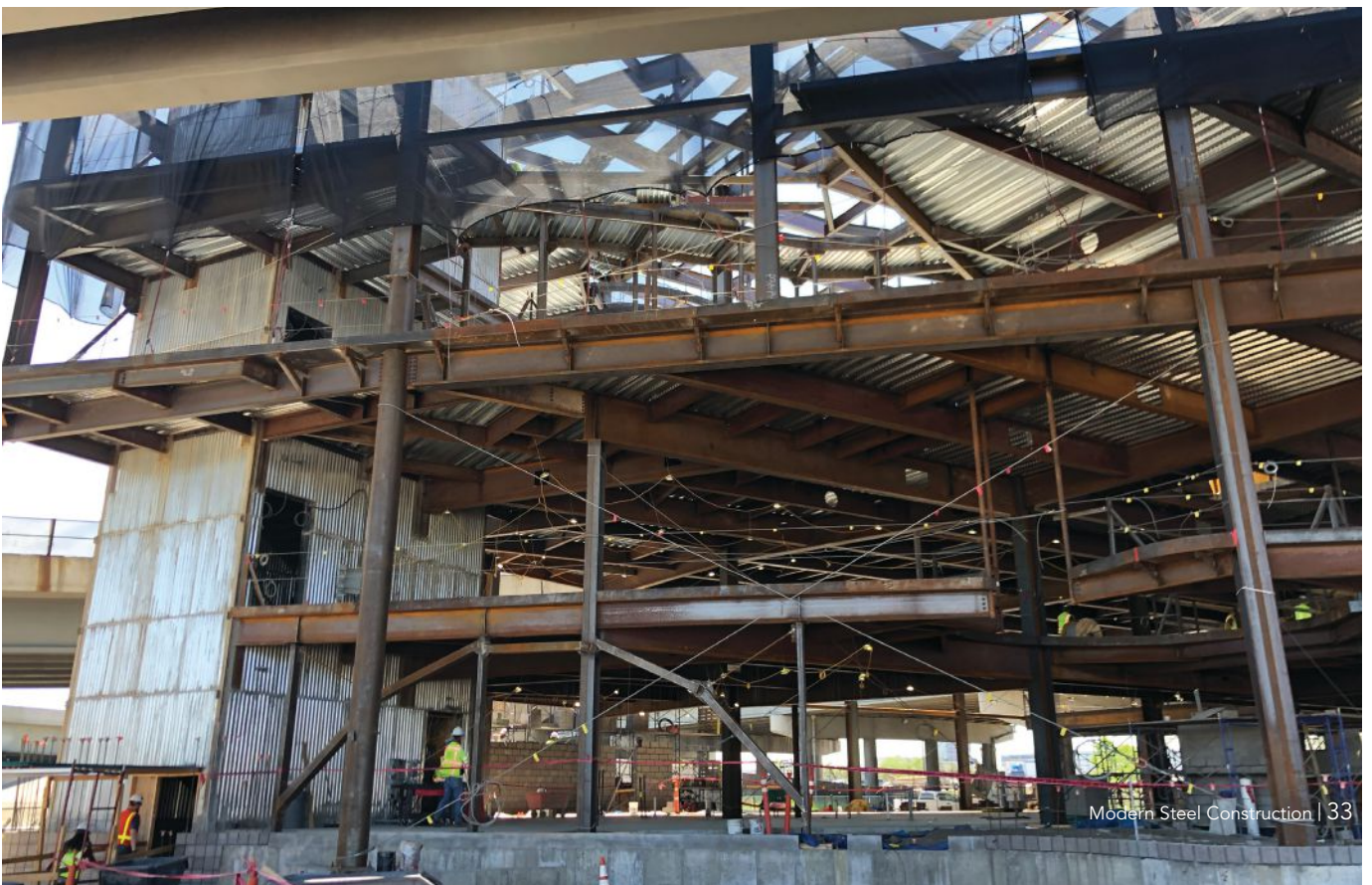



reinforced concrete slab on metal deck as a diaphragm was the most efficient method of meeting the desired horizontal vibration criteria. At some locations, the curvature of the catwalks was extreme enough to compromise the ability of the catwalks to behave as diaphragms. Consequently, rectangular hollow structural section (HSS) moment frames (HSS8x4x3/8) were added to provide intermediate lateral stiffness.

One of the most iconic architectural experiences for visitors approaching the building is the elliptical arched entryways carved from the exterior CMU wall. The main lobby entrance is a 50-ft-wide by 19-ft-tall CMU arch with a glass storefront infill. The length of the surrounding structure on each side of the arch was insufficient to resist the thrust associated with masonry arching action, so the design solution needed to bear the weight of the CMU while also bracing the wall and storefront from out of plane loads. The solution came in the form of HSS wind girts that were faceted around the arch and tied into HSS wind columns that aligned with the storefront mullions for concealment. Segmented angles of varying lengths were then attached to the HSS girts to reach and support the bottom of CMU, then the facets of the steel support system were coordinated with the storefront manufacturer to ensure a tight fit. The finishing touch was a plasma-cut steel fascia covering the head of the storefront to complete the curved aesthetic.

When it came to the MEP systems, rather than routing them below the heavily loaded and skewed steel framing, the team elected to raise them into the steel structure to allow for maximum headroom and full artistic expression. As the artistic design was constantly evolving, the dozens of beam penetrations had to be reviewed and coordinated many times to allow for the art to shine and remain unencumbered by the various building systems.

Though this project didn't officially incorporate an integrated project delivery (IPD) process, it had the feel of being an integrated project, and the team, from project leader Shears Adkins + Rockmore to Meow Wolf to the rest of the players, worked extremely well together. Structural engineer KL&A's multi-service approach contributed to the integrated mindset. When the company joined the project, it immediately started hand-sketching designs and collaborating with an in-house steel construction team that provided a realistic steel package estimate within single-digit percentage points of the final construction cost (steel fabricator HME and erector LPR were engaged in early design development

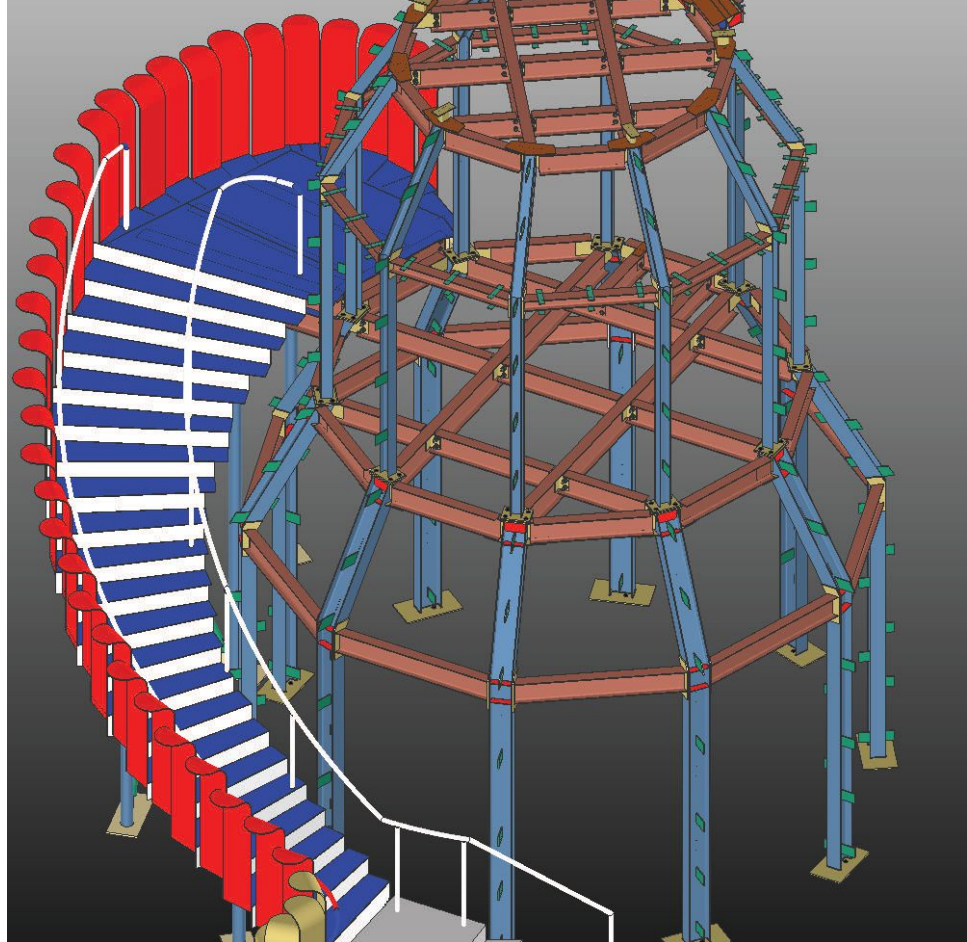

The framing for the *Cosmohedron* art exhibit structure is made up of W4 and W8 members in a circular shape and employs tension ring connections and moment connections on the smaller members.





# “Elevating” Train Stations with Elliptically Curved Pipe

Cermak-McCormick Place  
Elevated Train Station, Chicago IL

Chicago Metal Rolled Products curved 68 pieces of round 8” HSS .375” wall A500 grade B pipe to an ellipse curvature featuring multi-radius bends for the structural ribs that hold up stainless steel panels and polycarbonate skylights of the Cermak-McCormick Place “L” Station in Chicago, IL. The tube structure was designed so the covered platform was both light-filled and weather-protected while still providing direct views of the city.



**Call us at 866-940-5739**

For savings on quality roll-curving  
of structural steel, sheet and plate  
delivered to meet your schedule.



**CHICAGO METAL  
ROLLED PRODUCTS COMPANY**

CHICAGO • KANSAS CITY  
[cmrp.com](http://cmrp.com)







**1 Angle Leg Out** We bend ALL sizes up to:  
 10" x 10" x 1" Angle

**2 Angle Leg In**  
 10" x 10" x 1" Angle

**3 Flat Bar The Hard Way**  
 24" x 12" Flat

**4 Flat Bar The Easy Way**  
 36" x 12" Flat

**5 Square Bar**  
 18" Square

**6 Beam The Easy Way (Y-Y Axis)**  
 44" x 335#,  
36" x 925#

**7 Beam The Hard Way (X-X Axis)**  
 44" x 285#

**8 Channel Flanges In**  
 All Sizes

**9 Channel Flanges Out**  
 All Sizes

**10 Channel The Hard Way (X-X Axis)**  
 All Sizes

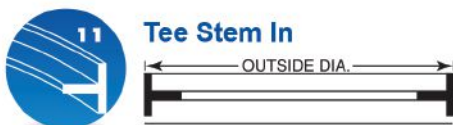
**11 Tee Stem In**  
 22" x 142<sup>1</sup>/<sub>2</sub># Tee

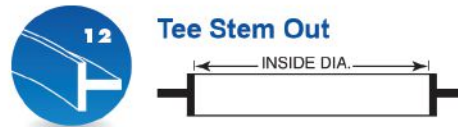
**12 Tee Stem Out** We bend ALL sizes up to:  
 22" x 142<sup>1</sup>/<sub>2</sub># Tee

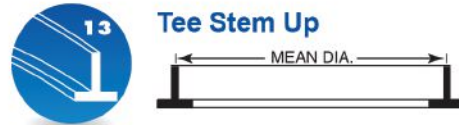
**13 Tee Stem Up**  
 22" x 142<sup>1</sup>/<sub>2</sub># Tee

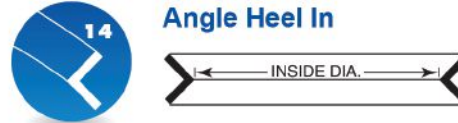
**14 Angle Heel In**  
 8" x 8" x 1" Angle

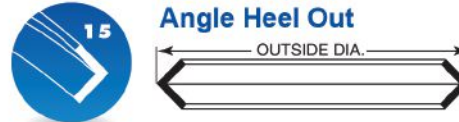
**15 Angle Heel Out**  
 8" x 8" x 1" Angle

**16 Angle Heel Up**  
 8" x 8"x1" Angle

**17 Square Tube**  
 24" x 1<sup>1</sup>/<sub>2</sub>" Tube

**18 Rectangular Tube The Easy Way (Y-Y Axis)**  
 20" x 12" x 5<sup>5</sup>/<sub>8</sub>" Tube

**19 Rectangular Tube The Hard Way (X-X Axis)**  
 20" x 12" x 5<sup>5</sup>/<sub>8</sub>" Tube

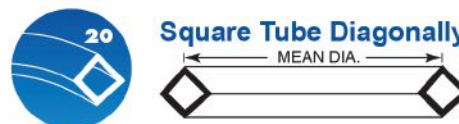
**20 Square Tube Diagonally**  
 12" x 5<sup>5</sup>/<sub>8</sub>" Square Tube

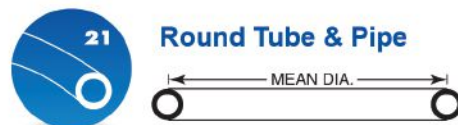
**21 Round Tube & Pipe**  
 24" Sched. 80 Pipe

**22 Round Bar**  
 All Mill Produced Sizes

We also roll stair stringers, helical hand rails, off-axis bends, formed shapes and extrusions.

Visit [cmrp.com](http://cmrp.com) for more information.



**CHICAGO METAL**  
**ROLLED PRODUCTS COMPANY**

CHICAGO • KANSAS CITY





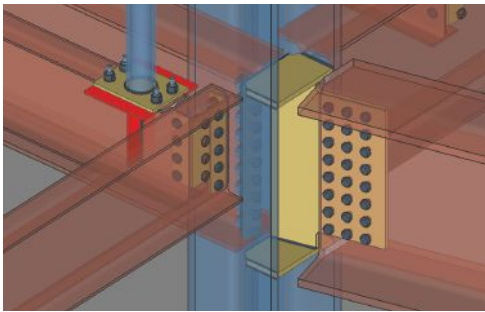

The framing of the building includes very few 90° angles (as seen above) and plenty of heavily skewed connections (sample at left).

below: In order to create a versatile structure that could support unorthodox geometries, as well as Meow Wolf's requirement for minimal columns, the design team turned to structural steel for the framing system (which incorporates 865 tons of steel in all).



to provide logistics and budgeting input through the remainder of design). In addition, the artists at Meow Wolf were also involved in the process, using VR and SketchUp to shape many of the organic shotcrete elements, providing a more accurate idea of what the museum's landscape would entail. ■

**Owner**

Meow Wolf, Santa Fe, N.M.

**General Contractor**

Turner Construction, Denver

**Architect**

Shears Adkins + Rockmore, Denver

**Structural Engineer and Steel Detailer**

KL&A, Golden, Colo.

**Steel Team**

**Fabricator**

HME, Inc.  , Topeka, Kan.

**Erector**

LPR Construction  , Loveland, Colo.

**Bender-Roller**

Shaped Steel, Inc.  , Liberty, Mo.



**John Jucha** ([jjucha@klaa.com](mailto:jjucha@klaa.com)), **Shaun Franklin** ([sfranklin@klaa.com](mailto:sfranklin@klaa.com)), and **Michael Olsen** ([molsen@klaa.com](mailto:molsen@klaa.com)) are all with KL&A.





View of the completed bridge deck, with entrances to the CTA train platform on either side of Montrose Ave.

# Treading Lightly

BY BRETT SAUTER, SE, PE

All images: Courtesy of IDOT District 1

A Chicago bridge project powers through COVID-19 impacts while minimizing its own impacts on the train and highway traffic it traverses.

**FOR COMMUTERS TRAVELING** along the Kennedy Expressway (aka Interstate 90/94) corridor between downtown Chicago and O'Hare Airport, the Montrose Avenue Bridge was easily distinguishable from other bridges traversing the highway.

Built in 1957 when the expressway itself was being constructed, the three-span bridge carried four lanes of traffic (18,000 vehicles a day) and crossed over 12 lanes of inbound and outbound vehicular traffic on I-90/94 (which carried 133,000 vehicles per day on this corridor), and two train tracks for the Chicago Transit Authority's (CTA) Blue Line and also provided two access points to the Montrose Avenue Blue Line station. What made the bridge stand out was that it was an 86-in.-deep cast-in-place post-tensioned (PT) tee-beam superstructure, giving it a monolith-like appearance, and it was much deeper than other bridge superstructures along the corridor. The three spans crossed the expressway at a 49°35' angle, which is why a deep concrete structure was required.

But in recent years, the superstructure had shown signs of deterioration, with several exposed PT strands. It was also hit several times because of its low vertical clearance (14 ft, 6 in.). Given the age and type of the superstructure, the Illinois Department of Transportation (IDOT) had determined that the superstructure

should be replaced. Prior to starting the design for a replacement structure, IDOT performed a detailed inspection to determine the condition of the substructure and whether there were any emergency repair needs, given the superstructure damage. The inspection revealed that the substructure was in good condition, with only superficial damage, and could be salvaged, and the superstructure could stay in place until its replacement—provided the replacement plans stayed on schedule.

## Maximum Clearance, Minimum Impact

One of the \$16.2 million project's main goals was to increase the vertical clearance over the expressway to reduce the probability of vehicle collisions—and this needed to be accomplished without changing the roadway profile of Montrose Avenue, given that the CTA stations connected to the bridge were not to be modified as a part of this project.

Another high priority was to minimize the impact on traffic as much as possible, including keeping the Montrose Avenue entrance and exit ramps open to traffic. Lastly, train traffic along the CTA tracks could not be impacted as Blue Line trains run 24 hours a day.



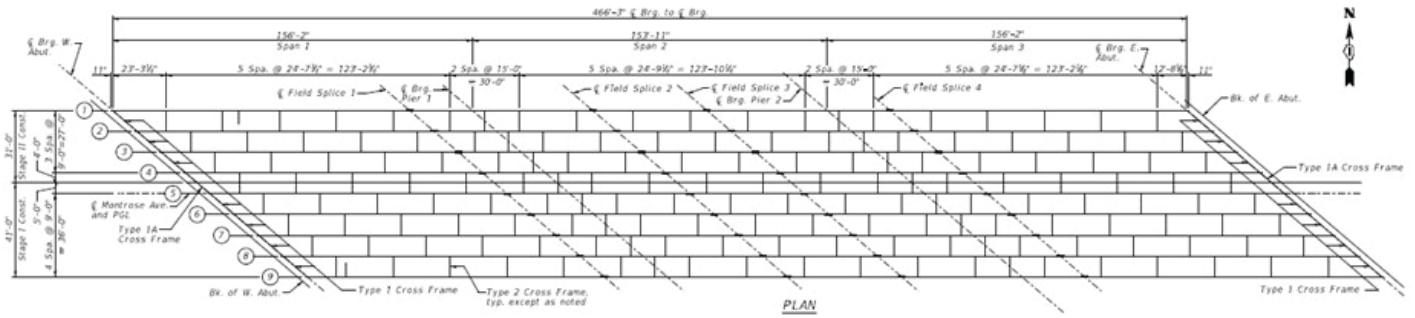

above: The framing plan for the new steel crossing.

A detail of a Type 2 cross frame (left) and a detail of an end cross frame (below). The design team specified a metalized finish on the girders and hot-dip galvanizing for the cross frames.

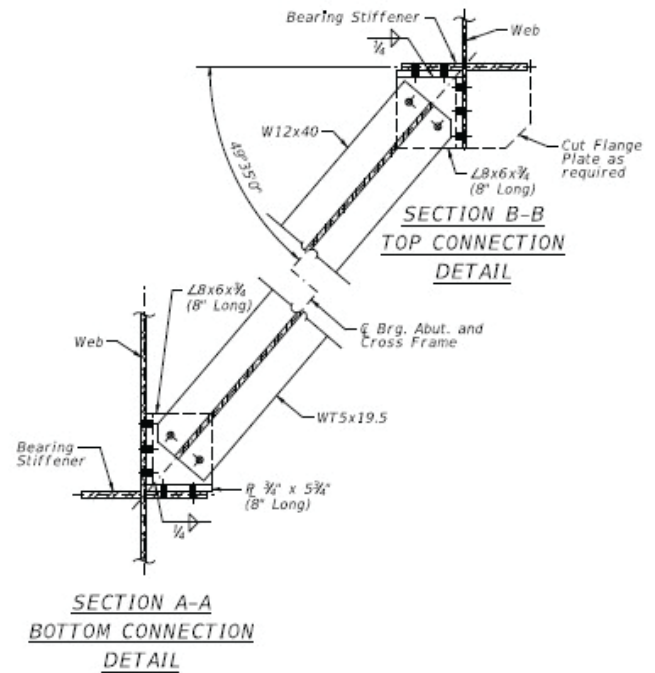
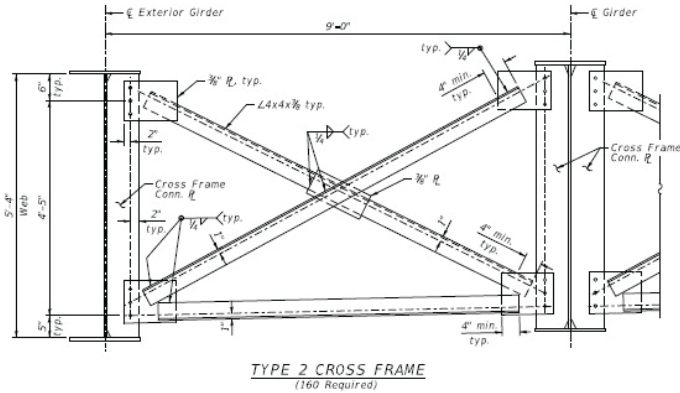

With the substructure staying in place and no opportunity to adjust span lengths, configuration, or skews, the team chose a steel plate girder superstructure design, which was deemed the most flexible option to meet all the project's goals and requirements. Plate girder sections could be designed to accommodate the less-than-ideal span configuration, high skew, and the challenges of erecting a bridge over an active highway and train tracks.

The final design uses nine plate girders with 64-in.-deep webs spaced at 9 ft, totaling approximately 1,000 tons of Grade 50 structural steel throughout the superstructure. The team specified a metalized finish on the girders and hot-dip galvanizing for the cross frames to avoid the need to repaint the bridge in the future. Segment lengths of 129 ft, 10 in. and shorter were optimized both for transportation and erection purposes as well as to minimize the overall structure depth. The shallower structure provides for a 15-ft, 5½-in. minimum vertical clearance over the vehicular lanes, a gain of almost 1 ft over the original bridge.

Given the 20% weight reduction from the existing concrete superstructure, there was no need to strengthen the substructure since the new plate girders were much lighter. The abutment backwalls were replaced to alleviate years of deterioration from water, which found its way past expansion joints, and bearing seats were modified to accommodate the shallower structure. The original piers were composed of single columns, so pier caps were constructed using the existing columns, which allowed for flexibility during the design phase to place the new girders in locations offset from the existing columns. The team chose high-load multi-rotational (HLMR) bearings, given the superstructure loads, high skew, and rotations that new steel girders would experience. With an overall bridge width of 81 ft,

.....  
CTA train clearance was fairly tight next to the Pier 2 cap formwork.

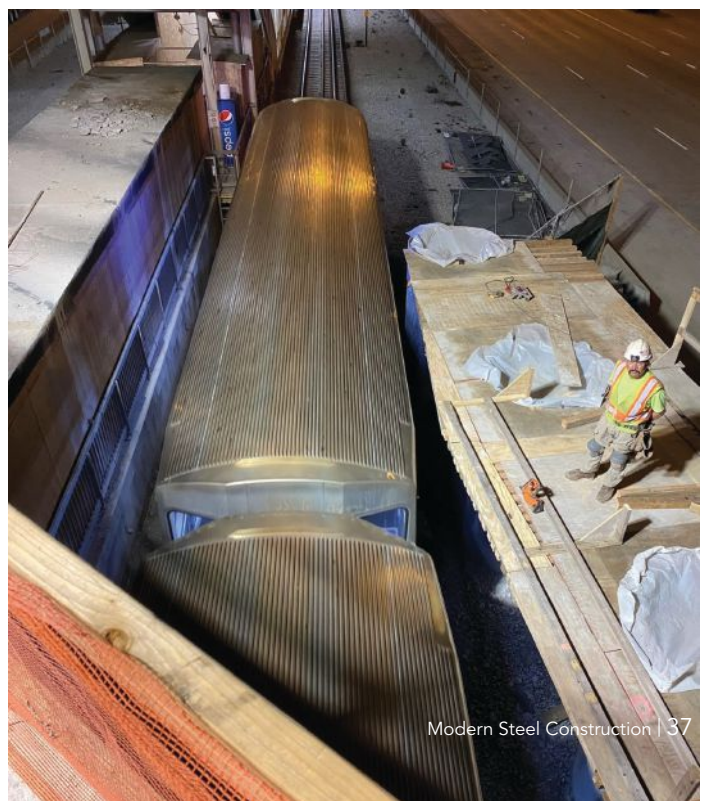





Erecting the Span 3 girder over I-90/94.

non-guided bearings were specified at the fascia girders to allow for transverse temperature expansion.

Due to the bridge's high skew, the team used a LARSA 4D model during the design phase to analyze the final condition of the bridge as well as its stability during erection and the deck pour. The analysis prompted the team to install X-cross frames composed of 4x4 angles spaced at a maximum of 24 ft, 9 in. to accommodate the construction stages. End cross frames at the abutment, which measured almost 14 ft long, required a W12x40 rolled beam to support the end of the deck and modular expansion joints.

### Tight Squeeze

With the highly urban environment of the bridge location, space for staging construction activities was at a premium. Directly adjacent to the bridge on the east, commercial businesses along Montrose Avenue remained open and needed to be accessible, and 100 ft to the west of the bridge, a Union Pacific Railroad bridge, which also could not be impacted during construction, crosses over Montrose Avenue. In addition, the Montrose Blue Line CTA station is accessed from entrances on either side of the bridge, with the passenger platform running underneath the bridge, requiring an approach that would balance providing space to construct the bridge with allowing pedestrian traffic to the station entrances.

After evaluating several options, general contractor Granite Construction determined that building one half of the bridge at a time while closing Montrose Avenue to vehicular traffic facilitated staging construction equipment while maintaining accessibility to the CTA station from one side at all times. A specialized protective shield was specified over the existing CTA platform to protect pedestrians crossing underneath the bridge during demolition and erection activities. At no time could there be a track shut down, and all construction activities had to maintain train clearances, which were within inches of the formwork necessary for pier cap construction.

Construction plans were bid in November 2019, and construction was scheduled to begin in the spring of 2020 and last for one season. And then the world stopped. March 2020 saw a "stay at home order" implemented for two weeks due to the COVID-19 pandemic, followed by several months of many commuters working remotely.

The bright spot? This scenario drastically reduced vehicular traffic along the Kennedy Expressway, providing some wiggle room for removing the PT T-beams, which weighed up to 94 tons each. During this downtime, Granite proposed closing the inbound lanes of I-90/94 and directing traffic into reversible express lanes located in the center span. Using a full weekend closure of the inbound lanes to downtown Chicago starting on a Friday evening, Granite placed sand and gravel on the travel lanes and then dropped the concrete girders onto the expressway below, where they would be processed and hauled off. This took place over the course of Saturday and Sunday, with all lanes cleaned and opened for Monday morning traffic. The same procedure was performed for the outbound lanes.

The center span proved to be more difficult to remove. With the CTA tracks and platform directly under the center span, the removal couldn't mimic the end spans, and the weight of the girders required two cranes with a very small pick radius just to pick the girders up. Granite used an innovative rail system placed along the portion of the bridge to remain in each stage. The existing girders were lifted onto the rail system, and Hillman rollers carried the 94-ton girders off the bridge to be processed and hauled off, all with no impact on CTA operations.

While the reduced vehicular traffic benefited the construction schedule, the pandemic slowed down construction in other ways. Steel fabrication and delivery were delayed due to COVID issues affecting the supply chain and fabrication personnel. When steel was ready to be erected, Granite was delayed because of social unrest that occurred throughout the summer of 2020. Police escorts were required for the 15-minute nighttime closures of I-90/94 during erection, yet these resources were required elsewhere, further impacting the construction schedule.

Granite looked to expedite the steel erection in any way possible. Fascia girders were erected with cross frames on the inside, balanced by overhang formwork brackets on the outside. Shorter girder segments were erected in pairs, reducing erection time. Longer segments were set within the rail system used for demolition and spliced with shorter segments on the ground, resulting in quicker fit-up.



Once the steel was erected, utilities crossing the bridge could be installed while the deck was being formed. These utilities included a ComEd 12 duct package and an ATT 6 duct package, both of which were vital crossings for the utilities. Chicago DOT ducts carrying emergency communications and IDOT ITS/Traffic Surveillance ducts were also located within the girder bays and had to be transferred over without impacting service. These crossovers delayed deck forming and pouring. Even with all of the schedule impacts, Stage 1 was completed in 2020, with demolition for Stage 2 happening in early 2021. And the bridge was completed and reopened to traffic on the morning of August 24, 2021.

While there were several impacts during construction due to the pandemic, this important arterial on the north side of Chicago minimized impacts to vehicular and rail traffic while it was being rebuilt. And the new steel superstructure has provided new and elongated life—with minimal maintenance requirements—to this important crossing. ■

*If you'd like to see more images of the Montrose Avenue Bridge's construction sequence, visit the Project Extras section at [www.modernsteel.com](http://www.modernsteel.com).*



A temporary shield was put in place to protect CTA riders crossing under the bridge during construction.



Despite pandemic-related supply issues, the structural steel was fabricated and delivered to the site for \$1.67 per lb, with the metalizing costing approximately \$0.27 per lb. The fabricator performed the metalizing in-house, which reduced rehandling costs. In all, the furnished and erected steel price was \$3.08 per lb.



**Owner**

Illinois Department of Transportation  
District 1

**General Contractor**

Granite Construction

**Engineer of Record**

Ciorba Group

**Steel Team**

**Fabricator**

Industrial Steel Construction   
Gary, Ind.

**Detailer**

Tenca Steel Detailing, Inc.   
Quebec, Canada



**Brett Sauter** ([bsauter@ciorba.com](mailto:bsauter@ciorba.com)) is vice president of structures with Ciorba Group and was the engineer of record for the project.

# THE PROVEN STEEL BRIDGE DESIGN SOLUTION



**FREE  
15-DAY  
TRIAL\***

\*see website for details



The leading software package for designing and rating curved and straight steel girder bridges.

**Used by Many State DOTs and Top Design Firms**

(573) 446-3221 ■ [www.mdxsoftware.com](http://www.mdxsoftware.com) ■ [info@mdxsoftware.com](mailto:info@mdxsoftware.com)



An already speedy steel plate core system becomes even faster thanks to an innovative “split” planning mindset.



# Faster and Faster

BY BRETT MANNING, SE, DAVE P. WRIGHT, KEITH D. PALMER, SE, PHD, AND RYAN COOKE, PE, PHD

All images: Courtesy of Schuff Steel and SGH

**WITH INNOVATIVE NEW DESIGN CONCEPTS** come innovative new ways of executing them in the field.

Take the composite plate shear wall/concrete-filled system, more commonly known as SpeedCore, for example. Developed by structural engineer Magnusson Klemencic Associates (MKA)—with research assistance from Purdue University, the University at Buffalo, AISC, Charles Pankow Foundation, and MKA Foundation—the system involves a concrete-filled steel-plate core wall that can reduce a project schedule by several months. (See [aisc.org/speedcore](https://aisc.org/speedcore) for more on SpeedCore.)

The most recent SpeedCore project—and only the second overall thus far—is 200 Park Avenue in downtown San Jose, Calif., a 19-story mixed-use project with a framing system containing more than 10,000 tons of structural steel. (The first SpeedCore project, Rainier Square in Seattle, was built 43% faster than it would have taken using a concrete core system and cut 10 months off the project schedule; see the IDEAS<sup>2</sup> coverage in the May 2022 issue, at [www.modernsteel.com](https://www.modernsteel.com), for more on that project.) Designed by

MKA and architect Gensler, the building is configured with two separate cores and includes an approximately 21-ft-tall Level 1 for the lobby, as well as three 16-ft-tall floors for the above-ground parking levels. These taller floors required the SpeedCore components to be sectioned differently than the more typical 14-ft floor-to-floor levels located above Level 5.

## Developing a “Split” Plan

Projects that implement a new system like SpeedCore for the central core require a new way of thinking when it comes to steel detailing and construction. Here, we’ll take a look at the methodology that fabricator Schuff Steel developed for 200 Park Avenue, which can be applicable to future SpeedCore projects.

The first step is to evaluate the geometry and general configuration of the building to determine the best approach to “splitting up” the core for detailing and construction. The “split” plan should consider floor-to-floor heights, boundary element column locations and configurations, and other core geometry such as door openings into the elevator lobby, coupling beams, and penetrations required for MEP systems. During this early phase, the steel team should also evaluate crane capacities intended to be used for the project and how they relate to the locations of the largest and heaviest fabricated steel assemblies to be erected. Potential restrictions on shipping oversized elements to the job site must also be evaluated to ensure that the core modules do not have a negative impact on the erection schedule.



**NEED  
FOR  
SPEED**

AISC’s Need for Speed initiative recognizes technologies and practices that make steel projects come together faster. Check out [aisc.org/needforspeed](https://aisc.org/needforspeed) for more.



After the split plan for the core is established, the team can finalize the total quantities and sizes of the fabricated core modules that will need to be supplied. This also helps determine the general locations of all field splices, which in turn will help guide the next steps of construction engineering. After the number of core “modules” is finalized, the fabricator and erector can develop field schedules for erection and welding.

above: The structure will stand 19 stories above grade when completed.

below: A 3D model showing a portion of the steel framing (gray) and the full height of the cores (blue).

### Matching Construction and Design Requirements

Engineering requirements for the SpeedCore system, along with fabrication and erection details, require close collaboration early in the process by all related parties, even prior to bidding. Having detailed fabrication and erection plans are essential for success. Ensuring wall panel tolerances are not exceeded due to fabrication and are stable during erection requires internal support between the panel plates, which are considered means and methods that are not included as part of the structural design.

For the 200 Park Avenue project, the fabrication method entailed laying the “bottom” panel horizontally and supporting the top panel above at the required distance while installing and welding the rods on the top side of the panel, which enabled the fabricator to install and weld the rods from above. To ensure the relatively long plates did not deflect and exceed tolerances, the plates required support at discrete points. Additionally, lifting, transportation, and erection loading requirements for the core modules also needed to be satisfied. While the initial loads for the panels (e.g., two plates separated by rods at 12 in. or 18 in. on center) were an issue due to the chosen shipping sizes for the core modules, the team developed internal stiffening trusses that eased fabrication and added the required strength and stiffness for all stages of construction, including transit to the site. Finite element analyses (FEAs) were performed to determine the optimum truss spacing to satisfy these requirements.

Tripping, lifting, and erecting the panels required lugs capable of supporting panel weights of up to 17.5 tons without overstressing the panel plates and rods. The team accomplished this by welding lugs spanning between the plates close enough to the trusses to provide an adequate load path, thus minimizing plate stresses and transferring the loads to the internal trusses.

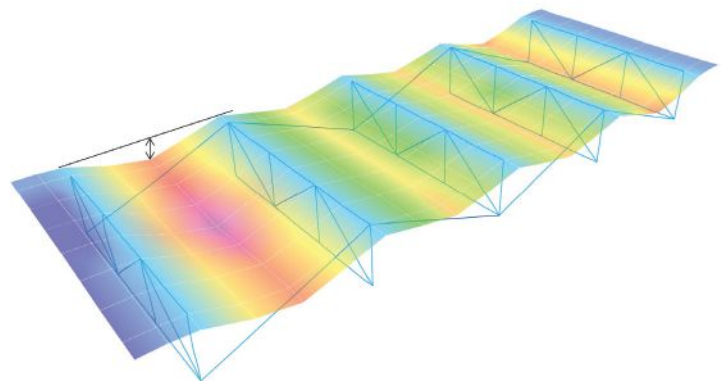
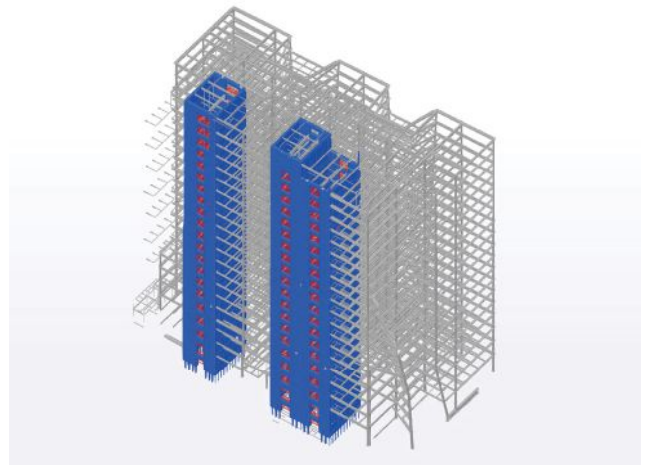

A finite element model of a core panel during fabrication.



Tripping, lifting, and erecting the panels required lugs capable of supporting panel weights of up to 17.5 tons each without overstressing the panel plates and rods.

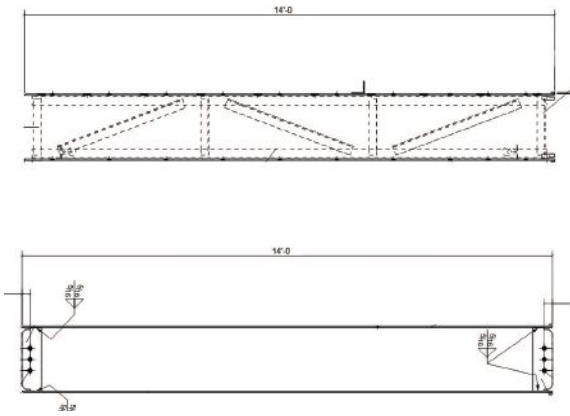

A typical internal stiffening truss (top detail) and typical panel lugs located at one-third points of the panels, on the top and bottom, to allow for efficient maneuverability in the shop and field (bottom detail).



## Erection Engineering

Safe erection requires that any steel framing elements, including SpeedCore, all maintain strength and stability throughout erection, at which time the lateral and gravity systems are incomplete. Therefore, a complete and viable load path must be ensured at all stages, and the demands on the system during construction are determined using ASCE 37: *Design Loads on Structures During Construction*. These include applicable construction loads, wind loads, and seismic loads if the building is in a high-seismic region, which is the case with 200 Park Avenue. Additionally, to maintain the schedule, demands from tower cranes on the north and south side needed to be resisted by the incomplete structure, including the un-grouted SpeedCore walls.

Lateral stability for the steel framing was accomplished using typical wire rope diagonal bracing, metal deck diaphragms, and the completed or semi-completed SpeedCore walls. Typically, the working floor could be erected in any order, as long the required wire rope bracing was installed as erection progressed and the core wall erection aids were installed. These erection aids were typically designed to resist two levels of steel while the panel and boundary column welding was completed. Boundary columns were welded first and could support construction loads for several levels of steel prior to completion of infill panel welding. The SpeedCore wall panels and box columns were staged on the floors prior to diaphragm completion, which required analyses of unbraced beams and specific loading requirements to prevent lateral-torsional buckling of the floor beams.

Providing flexibility for the erector and general contractor was a primary objective in order to ensure that the schedule was maintained and the “speed” in SpeedCore could be fully achieved. To facilitate this, the team performed high-fidelity FEAs on the core at various stages of completion and with various levels of internal stiffening, using ABAQUS software to evaluate several wall types, both coupled and uncoupled. The analysis results were

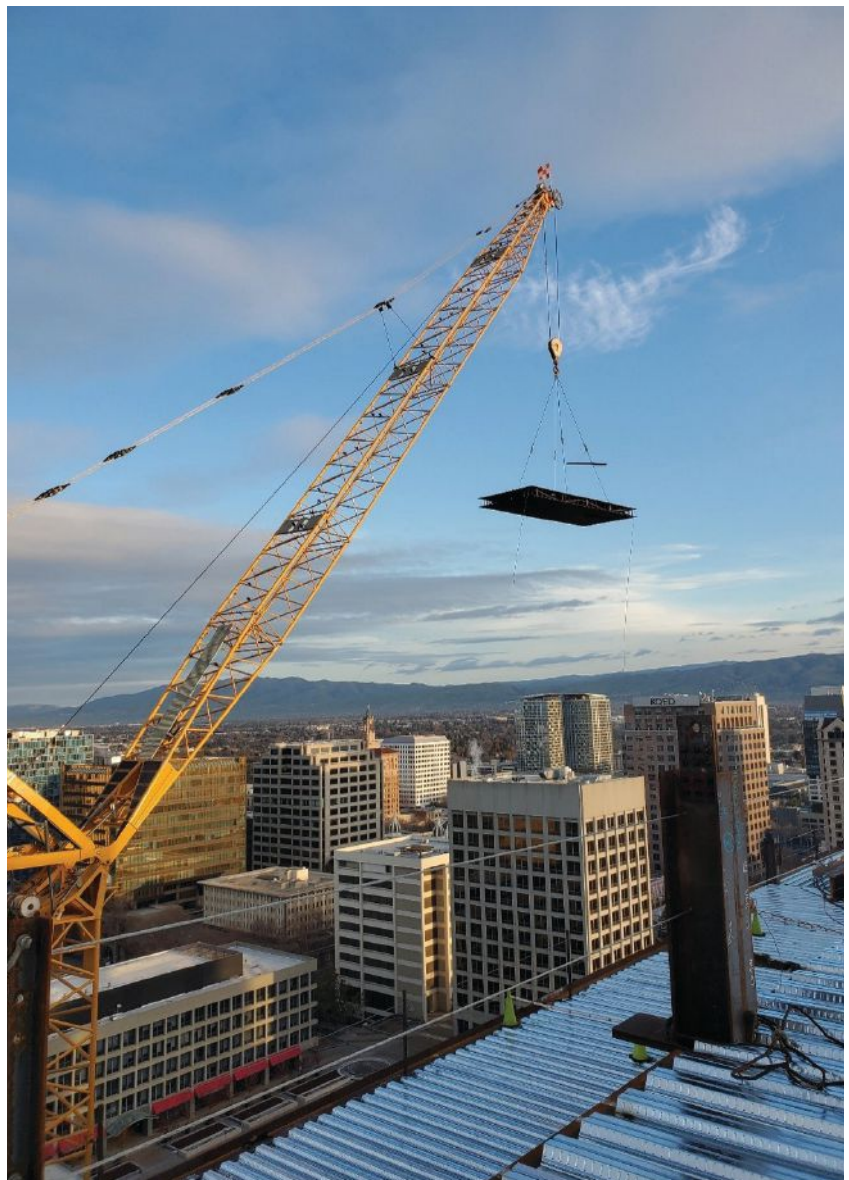

The largest wall panels reach up to 530 sq. ft in size and contain more than 500 cross ties each.



Hoisting a SpeedCore panel onto a truck.



Transporting a panel to the job site.



Providing flexibility for the erector and general contractor was a primary objective to ensure that the schedule was maintained and the “speed” in SpeedCore could be fully achieved.





above: The building sits on a prominent location in downtown San Jose, a few blocks from the San Jose State University campus.

below: Schuff used ½-in. ASTM A572-Gr 55 plate for the vast majority of the core wall elements and required the 1-in.-diameter cross ties to be spaced at 12 in. center-to-center in the lower regions of the building before transitioning to 18 in. center-to-center for the upper floors.

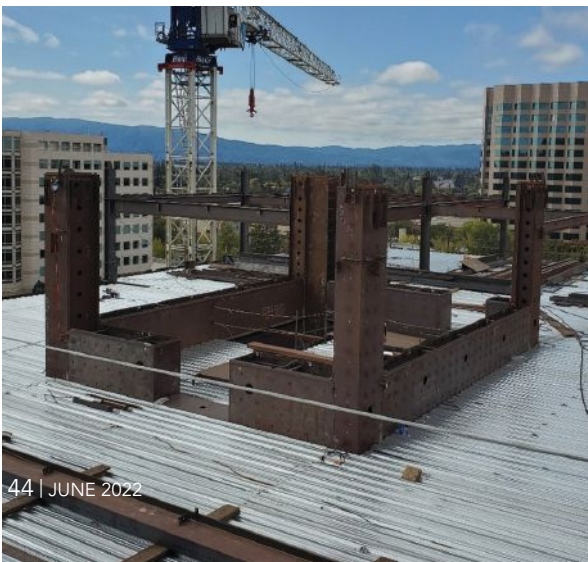



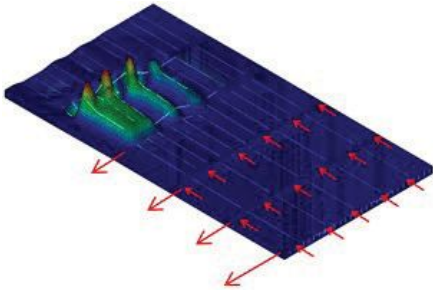

An ABAQUS model of an uncoupled wall panel with internal stiffening trusses.

used to determine the most efficient internal stiffening scheme, installation and welding sequences, required erection aids, and maximum number of steel levels that could be supported prior to placing the wall grout, all helping to ensure that the general contractor's schedule was maintained.

### Shop Fabrication

To successfully and efficiently produce SpeedCore elements, the steel fabricator needs to possess a strong resume in plate work. This includes a fabrication facility with sufficient space to devote to assembly fixtures and jigs needed for preassembly and welding operations. It is also important to use modern CNC plate processing equipment wherever possible to provide the core's main outer surface components in the most accurate and productive manner possible. With more traditional steel projects, fabrication shops typically use beam and column "lines" to produce the "sticks" of the steel framing—but a different approach is required when planning out the workflow for SpeedCore elements. These issues must be considered from the very start to allow the most efficient build plan and execution.

Prior to full production detailing for 200 Park Avenue, MKA required full-scale mockups to validate the split plan, module construction engineering of additional steel required for fabrication and erection, field installation of modules, welding, grouting, and quality control—which provided a wealth of valuable information for all parties. In addition, because of the speed at which a composite core system can be constructed at the job site, it is necessary to ensure there is an adequate stockpile of fully completed SpeedCore components ready for shipment prior to starting erection. Depending on the project schedule and available fabrication windows ahead of steel erection, this can often mean that more than one fabrication facility will be

## The NEW ELEMENT 400 Productivity Redefined



Scan to learn more

The **Element 400** cutting machine can be customized with multiple options including plasma beveling, oxyfuel cutting, and markers. The new plasma Bevel-S rotator can be added with cutting up to +/- 45 degrees, it has a high-acceleration drive with a C-axis  $\pm 540^\circ$  rotation, for maximum production and efficiency for cutting steel plate.

**Messer Cutting Systems, Inc. | Menomonee Falls, WI, USA | Phone: 262-255-5520**  
[www.messer-cutting.com](http://www.messer-cutting.com) | [sales.us@messer-cutting.com](mailto:sales.us@messer-cutting.com)

## Know the bolts are tight! DuraSquirt® DTIs

The Best Way to Bolt!



1 800 552 1999

[appliedbolting.com](http://appliedbolting.com)

Designed, Engineered & Made In USA Since 1994





above: Looking through one of the elevator cores.



above: Bracing in an elevator core.

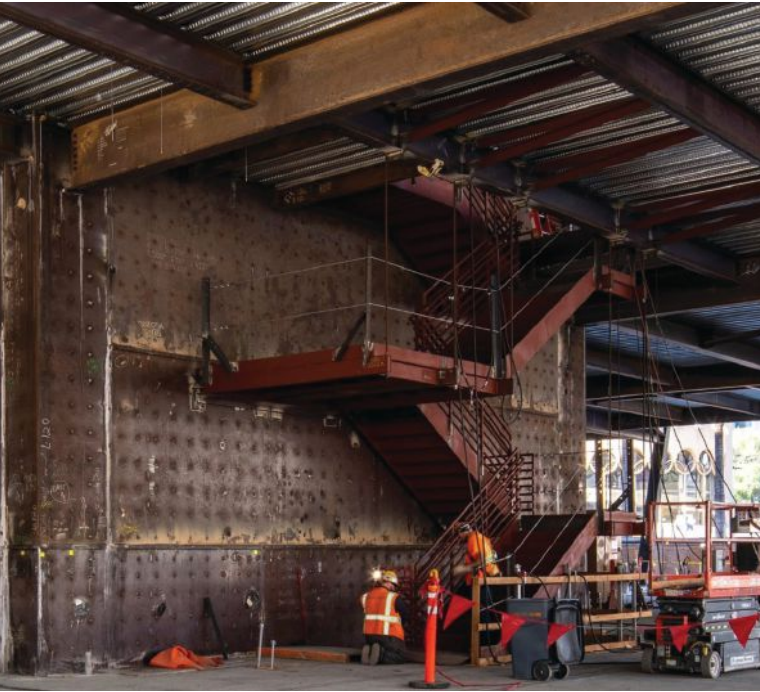

left: In addition to removing many of the challenges typical of concrete core projects, SpeedCore can improve safety and provide benefits for embed coordination at stairs, elevators, and other trades.

below: Openings in the panels for routing MEP systems.



needed to support the project's schedule demands without causing potential lulls for field crews.

And of course, the quality of the steel fabrication needs to be of the highest level to ensure that completed components can support the degree of accuracy that this method of core construction requires. As the completed components can be very large (nearly 40 ft long, 14 ft tall, and 4 ft thick), great care must be taken during every step of the shop planning and execution to ensure that dimensional control is carefully maintained throughout the entire process of assembly, welding, handling/loading, and shipment to the job site.

For 200 Park Avenue, Schuff Steel developed a plan that assigned the custom plate work required for the project's dual cores to be distributed between two of its fabrication shops. This allowed Schuff to use three of its other locations to support the more typical fabrication of columns, girders, beams, and other rolled shapes for the rest of the building's framing. For the core wall elements, Schuff used ½-in. ASTM A572-Gr 55 plate for the vast majority of the plate and required the 1-in.-diameter cross ties to be spaced at 12 in. center-to-center in the lower regions of the building before transitioning to 18 in. center-to-center for the upper floors. This design resulted in the largest wall panels reaching 530 sq. ft in size, containing more than 500 cross ties each and weighing upwards of 17 tons.

Also, thanks to recent AISC-sponsored fire testing research (performed at Purdue University) on the concrete-filled core walls, no fireproofing was necessary for the building's SpeedCore

elements (fireproofing was specified for the cores of the first SpeedCore project, Rainier Square, as it was designed and built before this fire research was finalized). To read about the testing, go to [aisc.org/speedcore](http://aisc.org/speedcore) and click the "Structural Fire Engineering and Design of Filled Composite Plate Shear Walls (SpeedCore)" link.

## Field Erection

The most rewarding element of SpeedCore—and again, the reason for its name—is seeing how all of the preplanning pays off in the field as a faster method for erecting structural steel in mid- to high-rise structures. In addition to removing many of the challenges typical of concrete core projects, SpeedCore can improve safety and provide benefits for embed coordination at stairs, elevators, and other trades. A single trade erects the entire structural frame.

Erection commences with the setting of "starter" elements, which, as the name suggests, are the lead-off elements that interface with and integrate the SpeedCore system with the building's concrete foundation. The starter elements are followed by the typical core shipping assemblies—i.e., two-tier box columns (boundary elements) and single-level wall panel modules (coupled or uncoupled)—which require a particular erection sequence. Specifically, the box columns are erected, aligned, and plumbed. To avoid weld access issues, the interior welds of the box columns to the tier below are made prior to setting the wall panel assemblies, which span between the boundary elements. As suggested, once





above: Final on-site welding.

below: Including the core modules, the framing system comprises 10,000 tons of steel in all.

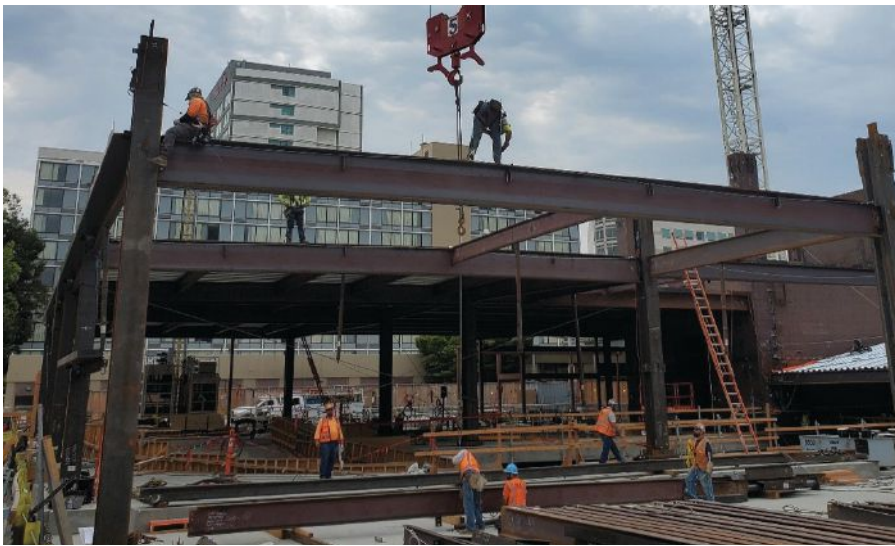

interior welds of the box columns are made, the panel modules are installed and connected to the boundary elements for temporary stability and fit-up prior to installation of the next level of panels. Also preceding the next level of panels is the erection of the floor framing. One level of floor framing adjacent to the core is erected, which allows for additional stability of the SpeedCore elements, maintaining plumb and alignment, and a working floor to facilitate staging for the next level of panels, noting that the latter is critical in high-rise buildings or projects with little to no lay-down or staging area at the project site. The welding crew(s) follow close behind, completing the panel-column and panel-panel welds, and this process is repeated up the height of the building, generating a very prescribed and repetitious flow that supports the “speed” in “SpeedCore.”

200 Park Avenue was erected roughly three months faster than what would have occurred with a traditional reinforced concrete core system. Two tower cranes and raising gang crews were employed due to the large floor plates and the fact that the building contains two SpeedCores. The framing came together quickly, not just due to the inherent speed benefits of the system itself but also thanks to the “Split Plan” developed during preconstruction—which effectively made a fast-moving steel system move even faster! ■

**Owner**

Jay Paul Company

**General Contractor**

Level 10 Construction

**Architect**

Gensler

**Structural Engineer**

Magnusson Klemencic Associates

**Erection Engineer**

Simpson, Gumpertz and Heger

**Steel Team**

**Fabricator and Erector**

Schuff Steel 

**Detailer**

DBM Vircon Services, USA, Inc.

**Brett Manning** is the Western Region vice president of engineering, **David Wright** is the Western Region director of preconstruction, and Ryan Cooke is a project manager, all with Schuff Steel. **Keith D. Palmer** is a senior project manager with Simpson, Gumpertz and Heger.



A new steel fabricator headquarters building  
is both carved out of and blended into the foothills of the Appalachians.



# Hillside Steel

BY RALPH  
PARRISH  
AND ROBERT  
HORTON, PE, PEng

**EMERGING FROM THE SLOPE** of a rocky wooded hillside, SteelRidge Center simultaneously achieves a harmonious blend of architecture and nature while also striking a powerful steel pose.

Serving as the new corporate office for North Alabama Fabricating Company, Inc. (NAFCO), the 35,345-sq.-ft building is planted between a creek at the base of a hill and old-growth trees that crest the ridge above—not only preserving the site’s natural beauty but also enlisting it to enhance the overall aesthetic of the entire project, which showcases the company’s primary product: fabricated structural steel. Approximately 50 people currently work in the building, and that number will eventually grow to around 80.

The edifice employs a floor-to-floor truss system that eliminates interior columns and allows for abundant light to flood in through the prominent glass that joins with metal panels to wrap the building in both metal and light. Numerous balconies, artfully wrapped and sheltered with steel designed to match the prominent staircase inside, also highlight the harmony between interior and exterior. The project team worked diligently and judiciously to appropriately account for neighboring properties, and the cantilevered structure reduces site impact by allowing vehicle access to pass underneath the building.

To further emphasize the beauty of structural steel, the building prominently features architecturally exposed structural steel (AESS) columns and braces. In addition, conference tables and coffee tables use steel bases as supports to highlight the design motif throughout the space, and a commissioned piece of art in the entrance lobby of the building showcases the skyline of NAFCO’s founding city, Birmingham, Ala. This artful expression reflects the backbone of an industry built by hardworking craftspeople.

## An Easy Material Choice

While steel was basically a given for the framing system due to the company’s focus, it also provided the best material for accomplishing the goal of integrating the building with the difficult but beautiful terrain and allowed for early fabrication of building components while the extensive site work progressed. Once steel erection/installation commenced, the entire frame and all decking were completed in only five weeks. The 14-ft-high floor-to-floor primary trusses were designed to be stick-built, a necessity due to very limited laydown space. The team designed bolted end connections for beams, girders, and braces, as well as designed



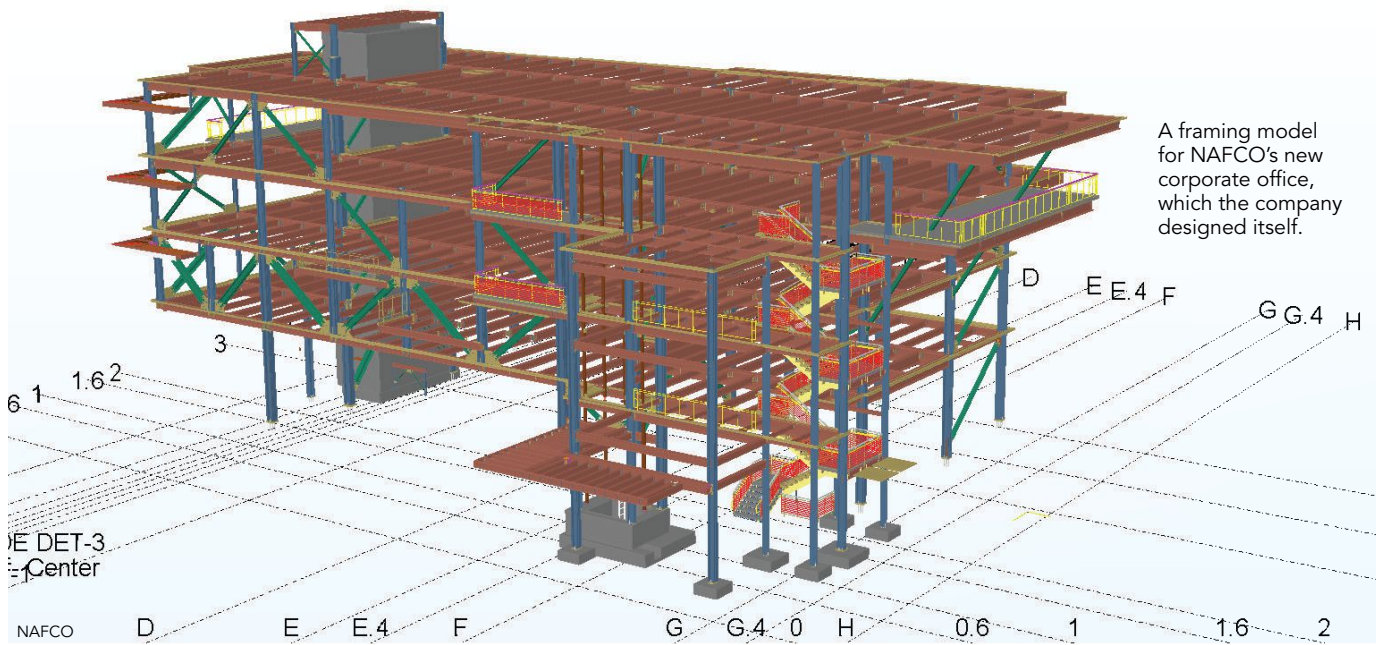

A framing model for NAFCO's new corporate office, which the company designed itself.



The 35,000-sq.-ft facility was built between a creek at the base of a hill and old-growth trees that crest the ridge above.



The building employs a floor-to-floor truss system that eliminates interior columns and allows for abundant light to flood in through the prominent glass that joins with metal panels to wrap the building in both metal and light.



moment connections as shop-welded end plates, to facilitate speedy erection. The design incorporated shear tabs at many simple beam end connections to eliminate the need for flange coping such that the beams could easily drop into place while on the hook. In addition, shop-welded tread and stringer stair elements were installed early in the process and provided safe construction access to the elevated floors. In all, the structure incorporates 500 tons of structural and miscellaneous steel, all fabricated by NAFCO.

One of the building's defining structural attributes is its primary 30-ft cantilever, which helped maximize site space by extending the building over the slope leading to the protected stream at the lowest elevation of the property without disrupting the stream in any way. The main building space was left open at all levels, uninterrupted by columns to provide parking and access beneath the building as well as flexibility and open office concepts at each level. The deflection management required by these long spans was best addressed by the flexibility of steel in a combination of simple connections, moment connections, and composite design. The initial concept involved concrete retaining walls at the edge of the building on the cut side of the site and at the last column line on the fill side. As the project building program progressed, these walls were moved away from the building, allowing for a more open and steel-prominent foyer featuring columns extending from the ground floor to the third floor.

### Addressing the Slope

The conventional wisdom for situating a building on a sloped lot is to orient the longest direction of the footprint with the topography lines to minimize the impact of the slope. Given the project goals, however, the project team realized early that they would have to defy convention—a challenge that created both difficulties and unique opportunities for building configuration and expression. A desire to maximize uphill green space led to the decision to orient the building with the longest dimension running down the slope.

When this counterintuitive idea and its potential solution were presented to the architect, the response was, "Now this project is getting exciting." In the final design, the major truss extends over the parking access area and cantilevers over the hillside to capture all available building space at the lower end of the lot. The design also showcases the structural steel, with the architect



NAFCO



Fisher Studios

The project team worked diligently and judiciously to appropriately account for neighboring properties, and the cantilevered structure reduces site impact by allowing vehicle access to pass underneath the building.

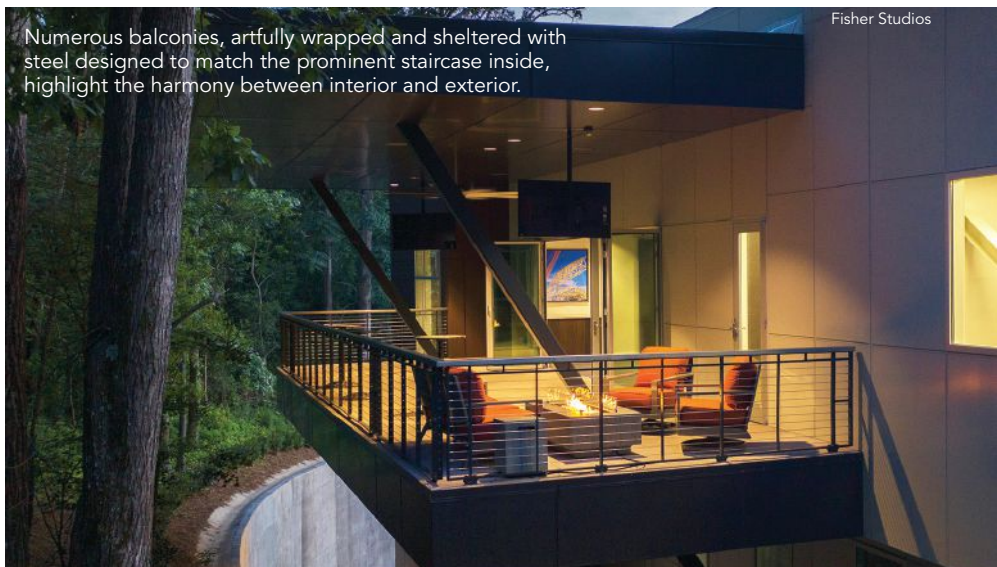

Fisher Studios

Numerous balconies, artfully wrapped and sheltered with steel designed to match the prominent staircase inside, highlight the harmony between interior and exterior.





In all, the structure incorporates 500 tons of structural and miscellaneous steel, all fabricated and detailed by NAFCO.

embracing a “show what you do” mentality and developing a space for NAFCO that allowed steel to be recognized for its artistry and beauty.

### Supporting Role

In addition to supporting the building, steel also facilitated myriad other smaller elements. For example, the lobby’s monumental stair is supported on two inboard plate stringers that allow daylight around the treads, which are composed of HSS10x2 with a wood finish. The guardrail is made up of steel plate frames supporting stainless steel wire rope and grab rails, and this guardrail theme is used throughout all interior and exterior spaces. The lobby itself is a three-story glass window box providing views into nature. At night, it’s transformed into a glowing lantern by its artfully placed illuminated pendants. Visible through the glass exterior, the interior of the lobby features weathered metal panels that deftly break the grid of the exterior’s lighter-toned metal panels.



Fisher Studios

The building has a recurring theme of straight lines. The canopy at the glass foyer is no exception, creating the challenge of a linear canopy with no knee brace or hanger. The exposed structure supports both the canopy and the three-story window wall, and both the canopy and glass are supported by HSS members offset from the column line by moment connection-supported outriggers. Since the canopy stops short of the column line, the HSS is designed to take the torsion of the extended canopy.

A unique double-knee brace system supports the fourth-floor boardroom balcony and the canopy above it. The two HSS knee braces run through the balcony on the way up to support the canopy. The cantilevered elements over these braces and the cantilever of the outside face serve as the primary support for the floor and roof areas.

The team specified AESS Level 1 for the exposed steel, combining function and form. This is the minimum treatment of exposed steel beyond standard fabrication. For details on all of the AESS levels, see “Maximum Exposure” in the November 2017 issue, available at [www.modernsteel.com](http://www.modernsteel.com).

In many projects, sunshades are made of lightweight aluminum. However, for Steel-Ridge Center, six over-the-window steel sunshades wrap the west-oriented corners and are supported by outriggers at columns and girders. The spacing of the steel plate fins varies to optimize their effectiveness in deflecting the sun’s rays and minimizing the solar gain and glare. For this project, the desired placement and function of the sunshades became more economical with steel. Finally, even the backdrop of the building’s entry sign is a steel-framed structure with a weathering steel skin that doubles as a very discrete trash-management area.



Fisher Studios



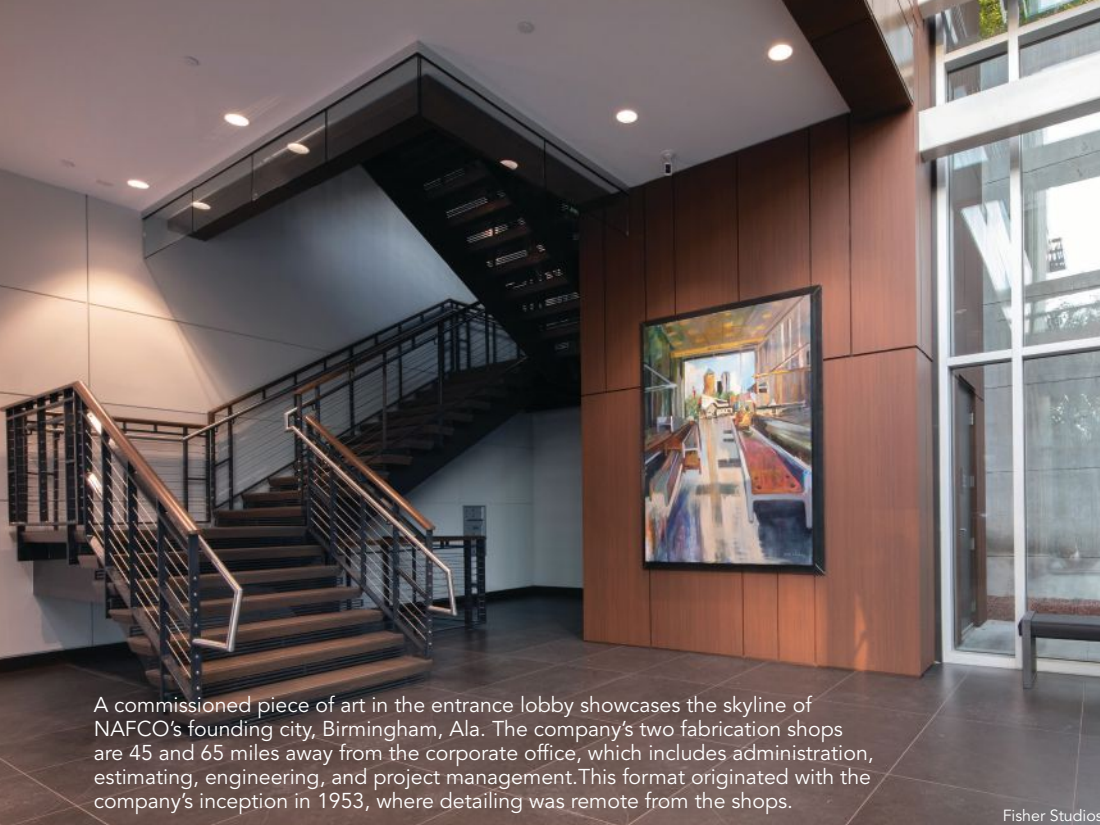

A commissioned piece of art in the entrance lobby showcases the skyline of NAFCO's founding city, Birmingham, Ala. The company's two fabrication shops are 45 and 65 miles away from the corporate office, which includes administration, estimating, engineering, and project management. This format originated with the company's inception in 1953, where detailing was remote from the shops.

Fisher Studios



The main lobby is a three-story glass window box providing views into nature. At night, it's transformed into a glowing lantern by its artfully placed illuminated pendants.

## Maximizing Limited Space

The two primary superstructure features are the aforementioned cantilever and the long span to accommodate the parking lot and parking access. The long span translates up through each floor of the structure, and the initial concept involved the second level floor-to-ceiling truss at the North and South elevations supporting all interior elements. Although the stresses in members were acceptable, the control of overall deflections and excessive differential deflections between adjacent members became one of the driving forces for design.

The basic deflection of the primary building cantilever was controlled by using tension bracing up over the effective mast of the column line supporting the cantilever and back down to the column line at the opposite side of the parking and parking access. (NAFCO uses a similar approach of a tall mast and wire rope in tension for the design of both fixed and luffing radial stacking conveyors in bulk material handling applications.) The floor-to-floor dimension of 14-ft limited the depth of girders and beams.

The floor-to-floor height of 14 ft and the use of 10-ft ceilings limited space for girders, utilities, and the ceiling support grid. Deflection had to be managed by other means than simply steel profile depth. To address the two-way deflection of the roughly 70-ft by 70-ft long-span area, moment end connections and composite design were used on column lines running parallel with the north and south elevation trusses. This allowed for simple extended shear tabs to support the beams running transverse to the trusses and moment-connected girders. In addition, the bent line supporting the cantilever and the beginning of the long span and the bent line at the opposite end of the long span created hard spots relative to vertical deflection. As such, the team implemented more rigid transverse beams adjacent to these non-deflection hard spots to help smooth out the deflection differential.

A combination of vertical bracing and moment frames provides lateral load-carrying capacity. In the longitudinal east-west

direction, the team created a rigid frame by using vertical bracing at the upper floors at the outside elevation column lines and moment connections at the inner column lines, which allowed for clear walking and driving space at grade. In addition, achieving the architectural goal of leaving the lower columns near the parking area exposed required an intumescent coating, so NAFCO applied Sherwin-Williams Firetex to the steel in this area prior to delivery and installation at the project site.

## Intimate Involvement

NAFCO was intimately involved from the beginning of the project with the architect and contractor in an effort to model how a project can be very successful when all parties collaborate throughout the process. Further, the steel erector determined the crane size and placement locations for efficient steel erection on the very challenging site. The chosen design concepts, combined with the exact loading and staging of fabricated pieces, allowed for the efficient flow of structural steel through the shop to support just-in-time field delivery for steel erection.

With minimal laydown area, interior floor beams for all three floors were staged incrementally at the site while the columns, girders (carrying beams), and perimeter beams were delivered and set from the trailers. The efficient design, fabrication, and erection helped overcome delays due to COVID-19 and inclement weather during the site preparation stage of the project and brought the schedule back to the original plan. Weekly drone shots were taken to evaluate progress, determine construction action items, and provide information for any additional design elements related to constructability that needed to be addressed. This weekly drone review also assisted with rock removal and site cut-fill balance.

All in all, by using simple lines and shapes, the larger concepts of the building's design are skillfully woven throughout the intricate details, announced into a triumphant, expressive project that honors the surrounding environment while also celebrating NAFCO's industry. ■





Fisher Studios

**Owner**

Parrish Realty, LLC, Birmingham, Ala.

**General Contractor**

Rives Construction Co., Birmingham

**Architect**

Butler and Company Architects, LLC, Birmingham

**Structural Engineer, Steel Fabricator, and Steel Detailer**

North Alabama Fabricating Company, Inc.  , Birmingham



**Ralph Parrish** ([rparrish@nafcofab.com](mailto:rparrish@nafcofab.com)) is the president and CEO and **Robert Horton** ([rhorton@nafcofab.com](mailto:rhorton@nafcofab.com)) is the chief engineer, both with North Alabama Fabricating Company.



**SSM Joists & Decks**  
 Fabrication & Supply of:

- Steel Joists & Joist Girders
- Metal Decks
- In compliance with SJI & SDI Standard Specifications

**Structural Steel Manufacturing, Inc.**  
 PO Box 602828  
 Bayamon, PR 00960-2828  
 Tel: (787) 787-5405  
 Email: [sales@ssmjoist.com](mailto:sales@ssmjoist.com)  
 Website: [sswincpr.org](http://sswincpr.org)





**AISC**  
 CERTIFIED  
 FABRICATOR  
 & ERECTOR

**Are supply chain delays wrecking havoc on your construction schedule?**



**GET BACK ON TRACK WITH QUICKFRAMES**  
 Engineered Structural Roof Frames  
 QuickFrames.com | +1(480) 656-1575





Notes on navigating the evolving sustainability landscape.

# Navigating Sustainability

BY LAURA MICHELI, PHD,  
BRUCE BROTHENSEN, SE, PE, PEng,  
AND SCOTT RUSSELL, SE, PE, PEng

**IN THE LAST DECADE OR SO**, sustainability and environmental impacts have gained significant relevance in the structural design and construction fields.

As a result, terms such as life-cycle assessment (LCA) and environmental product declaration (EPD) have become part of the common AEC vocabulary. When it comes to designing and building steel buildings, it's important to recognize the meaning of these terms—and other related terminology—and how they can help provide a better understanding of the environmental impacts of steel and how it compares to other structural options. And for those of you who are already familiar with these terms, a refresher never hurts.

## Life-Cycle Assessments

Let's start with LCA, which is a standardized method to evaluate the environmental impact of consumer products throughout their lifetimes, as defined by the International Organization for Standardization (ISO). While still gaining traction in the AEC industry, LCAs are widely used in the consumer product manufacturing world to quantify the carbon emissions associated with different stages of a product's life, ranging from raw material extraction to end-of-life. The environmental impact is typically estimated based on the energy inputs and greenhouse gas (GHG) emissions at each stage of the product's production, construction, use, and end-of-life.

Typical life-cycle stages are depicted in Figure 1, including production (A1-A3), construction (A4-A5), use (B1-B5), and end-of-life (C1-C4) stages. An LCA can include all or only some of the life-cycle stages, depending on the scope and intended use of the assessment. When the LCA comprises only the production stage, the term “cradle-to-gate” is usually employed to designate the boundaries of the LCA, from resource extraction (cradle) to leaving the manufacturing facility (gate). The gate is typically the steel fabricator in the case of buildings and structures. If all four life-cycle stages are included, the LCA is referred to as “cradle-to-grave.” (Note that steel can be thought of as a “cradle-to-cradle” material, given that it is infinitely recyclable.)

The results of the LCA are presented in a tabular format, which includes six impact categories, namely global warming potential (GWP), ozone depletion potential, acidification potential (AP), eutrophication potential (think oxygen-hungry algae blooms in bodies of water), smog formation potential, and abiotic depletion potential (the usage of nonrenewable resources for energy production). The most well-known impact category indicator is the GWP, which is measured in kilograms of carbon dioxide equivalent (kg CO<sub>2</sub> eq.) and represents the amount of energy/heat the emissions of one ton of a given gas will absorb over a given period of time, relative to the emissions of one ton of carbon dioxide. The larger the GWP value, the more a given gas warms the earth compared to carbon dioxide over a period of time, usually taken as 100 years.

# Whole Building Life-Cycle Analysis

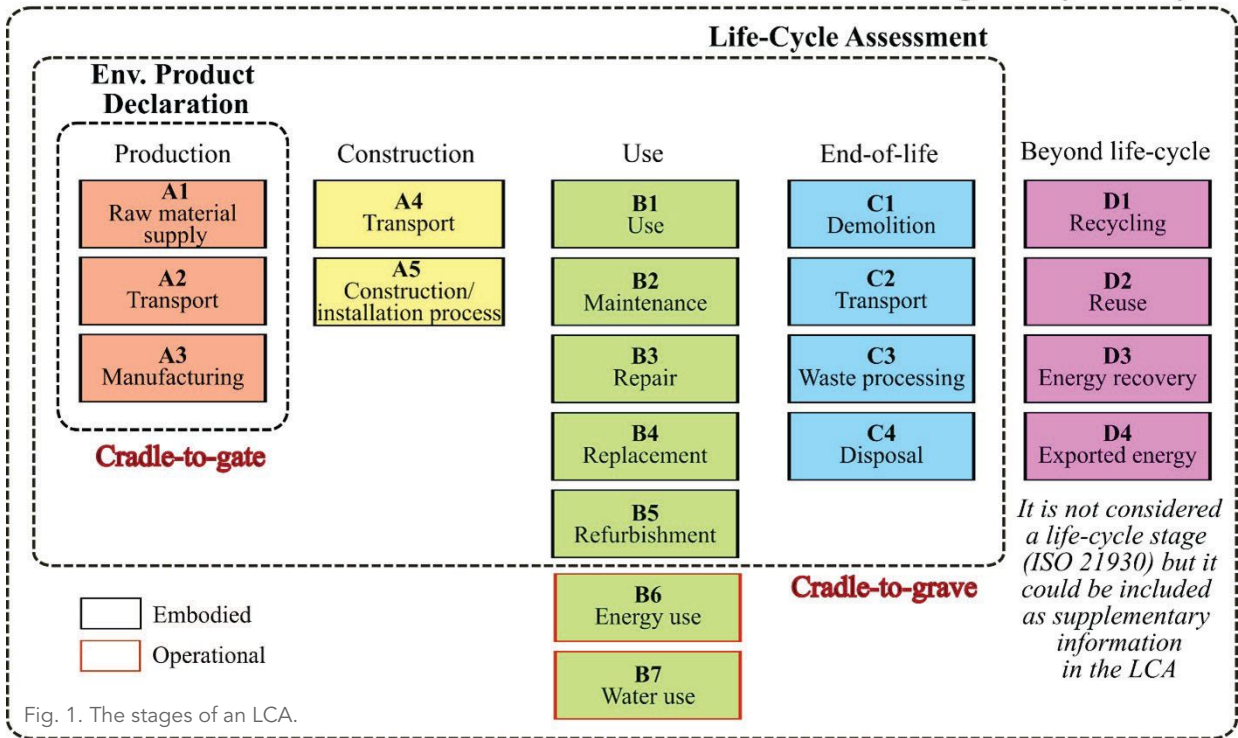

Fig. 1. The stages of an LCA.

## Environmental Product Declarations

Another important sustainability term is an EPD, which is a report that summarizes the LCA results of a given product, communicating its carbon footprint in a transparent and comprehensive way. For construction materials, EPDs are regulated by ISO 14025, ISO 21930, and EN 15804; in addition, the EPD must follow the guidelines and requirements of the appropriate product category rule (PCR); the PCR governing EPDs for structural steel is the “Product Category Rule (PCR) Guidance for Building-Related Products and Services.” While all the stages reported in Figure 1 could be included in the background LCA, EPDs typically include life stages A1 through A3 (cradle-to-gate). Note that the beyond end-of-life stage (D1-D4) is not considered a life-cycle stage by ISO 21930, but it could be included in the LCA as additional information.

An EPD must contain a description of the product and the life-cycle stages considered in the analysis, referred to as system boundaries. The LCA results are expressed in terms of environmental impact indicators, calculated based on a declared unit, such as one ton of product, as is the case of steel products EPDs. To ensure a transparent process, the EPD study commissioner must rely on a third-party company (the LCA practitioner) to perform the LCA study, which feeds data into an EPD, as well as an

additional third-party company (the program operator) to review and verify the EPD. On the other hand, industry-average EPDs report the weighted industry average production for a number of companies manufacturing the same product. As an example, Table 1 summarizes the industry average EPD of fabricated hot-rolled structural sections. Industry average EPDs of steel products can be found on the following websites:

- Fabricated hot-rolled structural sections, fabricated steel plate, and fabricated hollow structural sections: [aisc.org/epds](http://aisc.org/epds)
- Open-web steel joists: [steeljoist.org/about-us/environmental-product-declarations](http://steeljoist.org/about-us/environmental-product-declarations)
- Primary structural steel frame components (columns, rafters), secondary structural steel frame components (cold-formed steel purlins), roll-formed wall panels, and roof panels: [mbma.com/environmental\\_product\\_declarations.html](http://mbma.com/environmental_product_declarations.html)
- Steel roof and floor decks: [sdi.org/publications-2/epd](http://sdi.org/publications-2/epd)

It should be noted that EPDs of different construction materials (e.g., timber, steel, and concrete) are based on different PCRs and declared units. Therefore, a direct comparison between the data reported in their EPDs may lead to inaccurate results. Furthermore, choosing the material with the lowest GWP in the EPD doesn't necessarily imply selecting the product that will

Table 1

Industry Average EPD of Fabricated Hot-rolled Structural Sections (LCA results per one metric ton of product)			
Parameter	Symbol	Unit	Total (A1+A2+A3)
Global warming potential	GWP 100	kg CO <sub>2</sub> eq.	1.22E+03
Ozone depletion potential	ODP	kg CFC 11 eq.	1.63E-09
Acidification potential	AP	kg SO <sub>2</sub> eq.	2.98E+00
Eutrophication potential	EP	kg N eq.	1.56E-01
Smog formation potential	SFP	kg O <sub>3</sub> eq.	4.58E+01
Abiotic depletion potential	ADP <sub>fossil</sub>	MJ surplus	1.43E+03





AISC



603-402-3055 • Automated Layout Technology™  
 Visit [AUTOMATEDLAYOUT.COM](http://AUTOMATEDLAYOUT.COM) for a Quote

The first automated marking machine created specifically for the **layout of commercial handrails, stair stringers** and so much more utilizing your steel detailer's dxf files.

- Cut Fabrication Time by More Than 50%
- Ensure the Highest Level of Accuracy
- Boost Your Profit Margins!
- Lay out complex geometry in seconds
- Designed to replace your existing fabrication table



*"It easily doubles our output – no mistakes"*  
 Plant Manager • Papp Iron Works

*One current customer's team can layout 26 stair stringers in 58 minutes and ended up purchasing another machine for their second location.*

*"The guys love it. They jumped right in on it and have been working to make the most use of it. Great purchase."*  
 Nat Killpatrick • Basden Steel Corporation

*"I think it's fair to say that this machine continues to exceed our expectations. We are very happy with it."*  
 Chief Operating Officer • Koenig Iron Works

*"The machine is fantastic and could not be happier. Keep selling this machine, it's a winner."*  
 Misc. Shop Foreman • Koenig Iron Works



yield the lowest overall carbon emissions since the entire life cycle of a building needs to be considered in the analysis. An accurate comparison of different construction materials can be achieved by accounting for the difference in declared units and considering all the life stages of the structure, from raw material supply to end-of-life. Using manufacturer-specific EPDs in lieu of industry-average values can also lead to more accurate estimates of embodied carbon. An example of this in the steel industry is the EPD difference between an electric arc furnace (EAF) recycling steel from scrap and a blast furnace making steel from ore. Another distinction is the country in which the steel is manufactured. In most cases, domestic steel production has less of a carbon footprint than imported steel.

### Whole Building Life-Cycle Analysis

Taking the concept of a product LCA to a different level, the whole building life-cycle analysis (WBLCA) has emerged as a tool to estimate carbon emissions and energy consumption for an entire building. WBLCA's employ the same principles outlined above for LCAs and enable engineers and other stakeholders to compare the environmental impact of different design solutions by providing information on embodied carbon and operational energy. In addition to stages A, B, and C, WBLCA's can also include stage D, which considers the carbon emissions related to recycling or reusing construction materials at the building's end of life. Lastly, stages B6 and B7 (Figure 1) can be added to a WBLCA to account for operational energy, such as energy and water consumption.

WBLCA is usually performed by inputting the bill of materials for a given design into specialized software. The software output will be a summary of the six above-mentioned environmental impact indicators. Commonly used software packages are Athena, Tally (Revit), and One-Click LCA. In addition, the SEI Sustainability Committee has developed ECOM, a web-based platform that allows users to approximate the embodied carbon for construction materials and structural frames. The carbon footprint of various design scenarios can be compared by performing the WBLCA of different design solutions.

It is essential to understand that uncertainties inherent in the WBLCA results exist, as each software has its own database, inputs, bias, and assumptions. It is advisable to use multiple software programs and compare the results. Analyzing the same building configuration with different software could lead to a different carbon footprint, and failure to include relevant life-cycle stages or processes could yield incomplete results. For instance, when biogenic carbon is included in the LCA of timber structures, it is appropriate to extend the analysis to stage D to avoid considering full carbon sequestration without accounting for the possible CO<sub>2</sub> release in the beyond life-cycle stage. As EPDs, LCA processes, and related software evolve over time, the GWP values they produce may change for a particular building or structure.

### Buy-Clean Laws

As the sustainability landscape continues to evolve, so do federal and local regulations aimed at reducing the carbon emissions of new and existing buildings. The Buy Clean California Act

## VOORTMAN V807

### ROBOTIC THERMAL PROFILE PROCESSOR



VOORTMAN USA

26200 S. Whiting Way +1 708 885 4900  
Monee, IL 60449 info@voortmancorp.com  
United States of America www.voortmancorp.com

AUTOMATED MATERIAL HANDLING

CONTINUOUS LOGISTICS  
REDUCE HANDLING TIME

EARLY INFEEED

REDUCE TIME  
BETWEEN PROCESSES

CENTER OUTFEED

CREATE MULTIPLE OUTFEED  
SECTIONS FOR DIFFERENT LENGTHS

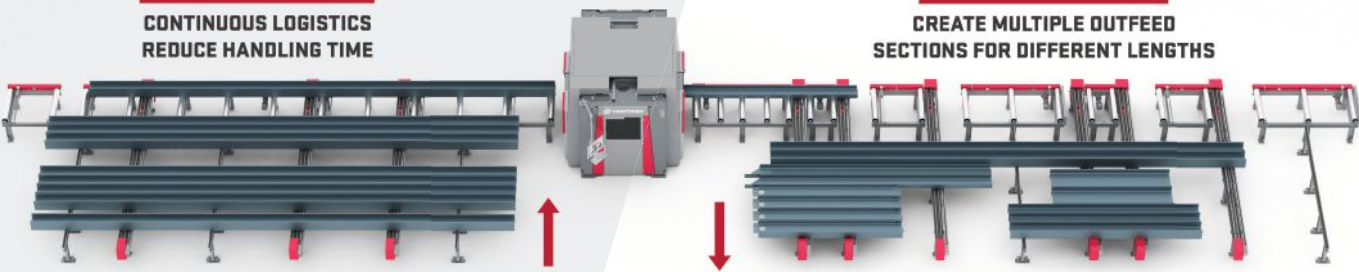

BUFFER MANAGEMENT

CONTROLLED BY  
VACAM SOFTWARE

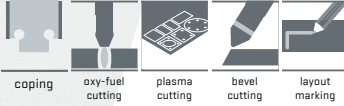

coping oxy-fuel cutting plasma cutting bevel cutting layout marking

AUTOMATED OUTFEED

MAXIMIZE OUTPUT  
AND REDUCE HANDLING TIME



*"With multiple output sections, we already sort our profiles according to the output by length or project. This saves us a lot of handling time and we see a faster turnaround in the entire workflow."*

David McWhirter of McWhirter Steel

*"The early infeed in particular has made a bitchin difference in production speed. In addition, production is fully automated with our operator focusing more on loading and unloading profiles."*

Steven Scrape of SCW





(BCCA) pioneered regulations on embodied carbon reduction, introducing GWP thresholds for four construction materials: structural steel, concrete reinforcing steel, flat glass, and mineral wool board insulation (note that BCCA only applies to federally funded projects). The maximum acceptable GWP values for these materials are reported in Table 2. With public works projects contracted by the State of California, the awarding authorities are responsible for verifying that the four eligible materials have a GWP that does not exceed the BCCA thresholds. Note that the limits reported in Table 2 are valid for “unfabricated products,” while the values reported in Table 1 refer to “fabricated products.” Thus, a direct comparison between the GWP in Tables 1 and 2 would not yield consistent results.

Table 2

Buy Clean California Act GWP Thresholds for Unfabricated Products	
Material	GWP limit
Hot-rolled structural steel sections	1010 kg CO <sub>2</sub> eq./1 metric ton
Hollow structural sections	1710 kg CO <sub>2</sub> eq./1 metric ton
Steel plate	1490 kg CO <sub>2</sub> eq./1 metric ton
Concrete reinforcing steel	890 kg CO <sub>2</sub> eq./1 metric ton
Flat glass	1430 kg CO <sub>2</sub> eq./1 metric ton
Light-density mineral wool board insulation	3330 kg CO <sub>2</sub> eq./1 m <sup>2</sup>
High-density mineral wool board insulation	8160 kg CO <sub>2</sub> eq./1 m <sup>2</sup>

Following California, Colorado passed the HB21-1303: Global Warming Potential for Public Project Materials in 2021. According to this act, the Office of the State Architect and the Department of Transportation will be required to establish GWP thresholds for eligible materials by 2024 and 2025, respectively.

Also, in December 2021, the Biden Administration signed a new federal sustainability executive order. Although specific GWP thresholds have not been set yet, the sustainability order explicitly promotes the use of construction materials with lower embodied carbon in federally funded projects. Additionally, the sustainability executive order supports a transition to a circular economy, aiming to drastically reduce the construction and demolition waste lying in landfills by 2030. Materials that are highly recyclable, like steel, have advantages in the beyond life-cycle stages (D1-D4). The executive order also emphasizes the importance of energy efficiency for new and existing buildings, pursuing net-zero emissions buildings through electrification strategies, deep-energy retrofits, and water conservation measures.

.....

In EAFs, steel is produced from scrap, with the addition of a small percentage of direct reduced iron. At the end of its useful life, steel products can be recycled, remelted, and used to produce new steel products. This circular process makes steel a cradle-to-cradle material, ideal for supporting a circular economy and zero-waste policies. Many steel components, such as open-web steel joists and wide-flange beams, can also be reused after a building is decommissioned.

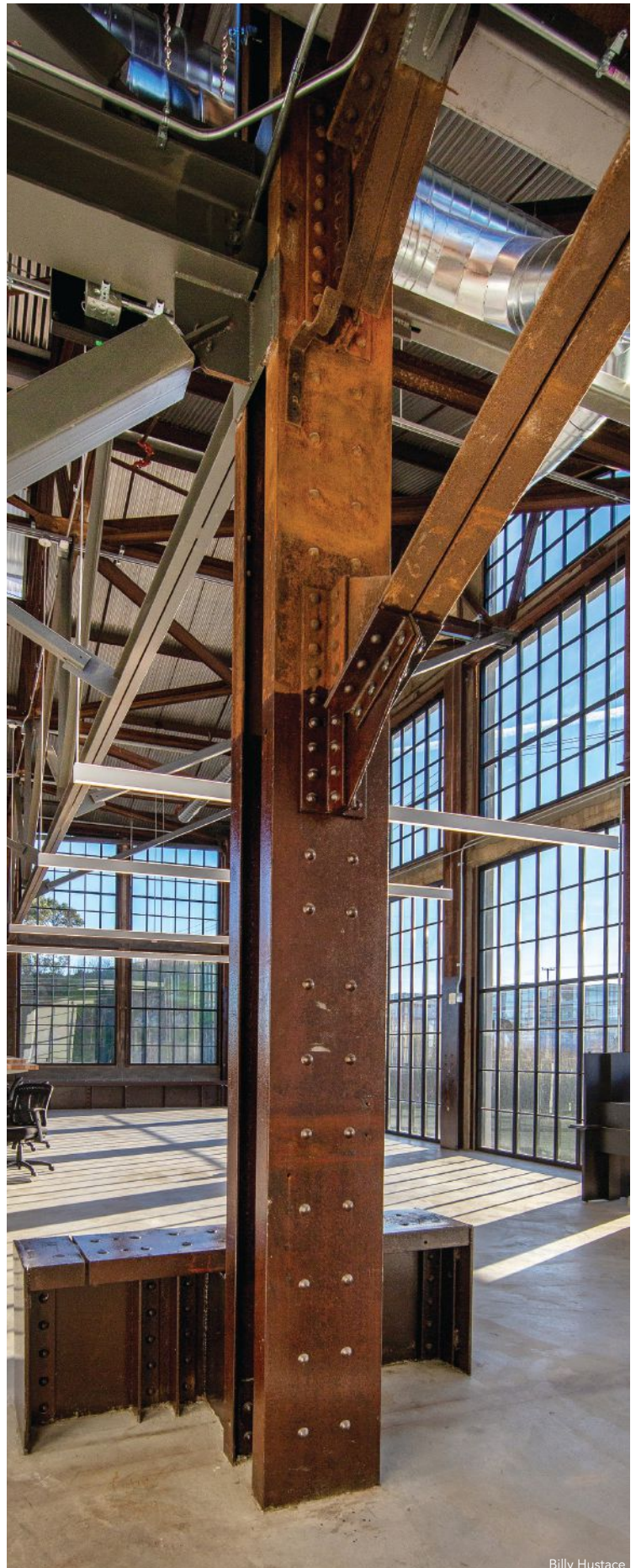

Billy Hustace



It is expected that the new state and federal regulations will fuel a sustainability renaissance in the construction industry, promoting the transition to clean, zero-emission technologies. In the near future, in addition to cost, schedule, constructability, aesthetics, and space usage, decision-makers will likely be required to consider sustainability as well—and in many cases have already been doing so. The demand for LCAs, EPDs, and WBLCA will continue to grow, along with new legislation regulating embodied carbon limits. It is also important to understand the uncertainties inherent in the direct comparison of different construction materials due to the different PCR assumptions, units of measure, and database variability. Steel has a great sustainability potential, especially regarding how it fits into a circular economy. Sustainability is here to stay, and we should all be familiar with its vocabulary. ■

For more on structural steel and sustainability, visit [aisc.org/sustainability](http://aisc.org/sustainability).



**Laura Micheli** ([laura.micheli@nucor.com](mailto:laura.micheli@nucor.com)) is a research engineer, **Bruce Brothersen** ([bbrothersen@vulcraft-ut.com](mailto:bbrothersen@vulcraft-ut.com)) is a senior innovator, and **Scott Russell** ([scott.russell@nucor.com](mailto:scott.russell@nucor.com)) is the manager of innovation services, all with Vulcraft-Verco Group of Nucor Corporation.



# ST. LOUIS

## SCREW AND BOLT

*Connecting amazing structures Nationwide!*



Call or email us your inquiry!  
**St. Louis Screw & Bolt**  
[sales@stlouisscrewbolt.com](mailto:sales@stlouisscrewbolt.com)  
**800-237-7059**

PROUDLY MADE IN THE USA



## Now Prequalified in AISC 358-22!



### Resiliency

The bottom fuse plate prevents damage to the beams and columns in an earthquake and is the only part needing replacement after a major event.

## DURA FUSE

### FRAMES

THE RESILIENT SEISMIC SOLUTION  
[durafuseframes.com](http://durafuseframes.com)  
[contact@durafuseframes.com](mailto:contact@durafuseframes.com)  
 801.727.4060



### DuraFuse Frames Benefits

- Easily repairable, prequalified special moment frame connection (AISC 358-22)
- Reduces frame weight, seismic lateral bracing, and residual drift
- Complimentary design assist to maximize frame performance and economy
- Completely field-bolted, erector-friendly moment frame connection





# And We're Back!

BY GEOFF WEISENBERGER

## NASCC: The Steel Conference

returns to an in-person format for the first time since 2019.

### TABITHA STINE MAY HAVE SAID IT BEST.

“This is like a family reunion.”

The general manager of construction solutions services at Nucor Corporation (and former AISC vice president) made this statement while introducing the Wednesday keynote session at the 2022 NASCC: The Steel Conference in March.

And she was right. After all, the conference, which took place in Denver, was the first in-person edition since 2019. We made the most of the last two years with virtual versions—and they were certainly successful in terms of reaching and educating thousands of online attendees—but it wasn't quite the same.

“The main thing that stood out to me was the positive energy I felt from every attendee, exhibitor, and staff member I interacted with,” said Maysa Kantner, AISC's Atlanta structural steel specialist. “Everyone was just so excited to be back and reconnect.”

And approximately 4,800 attendees apparently agreed, making this one of the biggest Steel Conferences ever (more than 2,000 streaming attendees tuned in as well, nearly double the number from the 2019 show).

### Picking Up the Pace

Many of these attendees were on hand for the Wednesday keynote, whose speaker, Gerry O'Brion, is a strategy and branding visionary who has provided his expertise to companies like Procter and Gamble, Coors Brewing Company, Quiznos, and Red Robin. One of the ideas he presented was giving customers a rational reason for an emotional response, citing the 2007 horror film *Paranormal Activity* as an example. The film's trailer, instead of merely showing footage, enticed potential views by showing actual audience reactions to some of the more harrowing moments, a rational (and ultimately successful) “show me, don't tell me” approach—and one that effectively “changed the rules.”

While that tactic hasn't become common with movie trailers, it illustrated a new way of thinking. To demonstrate a more gradual and lasting change, he turned to one of the world's most famous sporting events, the Indy 500. At the race's 1950 running, a pit crew numbered more than 20 and took more than a minute to perform a full pit stop. Today, a pit crew of four can perform the same work in mere seconds.

This change didn't happen overnight and wasn't due to one factor. And this type of change is at the core of AISC's Need for Speed initiative, which was promoted at the conference. The goal is to increase the speed at which a steel project (either a building or a bridge) can be designed, fabricated, and erected by 50% by the end of 2025.

And the writing was certainly on the wall in Denver. Sessions such as “Never Let the Structural Software Think for You, Only Let It Think Faster,” “SpeedCore Design Guide: It's Finally Here,” “AISC and the Steel Industry: 100 Years of Innovation,” “The Myriad Ways that Connected Models Drive Efficiency,” “Accelerated Welding,” “Scheduling Shop Resources to Create Productive Flow,” “Erection Engineering in Support of a SpeedCore Tower Project in California,” “Streamlining Steel Girder Design,” “Achieving Speed in Steel Bridge Fabrication,” “ABC... As Easy as 1,2,3,” and others touched upon the many different ways that steel design and construction can become faster. If you didn't make it to the show or were there and simply unable to be in two places at once, you can view recordings of these sessions at [aisc.org/education-archives](https://aisc.org/education-archives).

An accelerated attitude was also apparent in the exhibit hall, where university bridge teams demonstrated the build portion of AISC's Student Steel Bridge Competition. While the competition judges student bridges in various categories, including efficiency, aesthetics, and deflection, the build portion is all about how fast a bridge can come together while minimizing errors. (On a related note, the 2022 SSBC National Finals just wrapped up over Memorial Day weekend. You can find out more about the competition and see this year's results at [aisc.org/ssbc](https://aisc.org/ssbc). In addition, the August issue will feature coverage and great photos of the National Finals.)

Speed was also a focus of several exhibitors. For example, Prodevco premiered its new PCR41 compact high-definition robotic plasma cutting system, which the company says can make productivity up to ten times faster and whose small footprint and flexible placement allow fabricators to locate the system anywhere in their shop. Another product on display, a remote-controlled hook from OTH Rigging, offers speed advantages at the job site, allowing work teams to release riggings from a safe distance (read more about it in the New Products section on page 62). In addition, Simpson Strong-Tie showcased a soon-to-be-released all-field-bolted connection for braced frames that will help speed up installation while providing superior performance and resiliency. There was also the new Lincoln Electric Cobot, a collaborative robotic welding solution designed to help steel fabricators and erectors safely and economically increase productivity in the shop or at the job site. The company provided a hands-on demo showing how users can program a weld with no robotic experience in under five minutes. Keep an eye out for the December issue, which will highlight plenty of other speed-related products, services, and software from NASCC exhibitors and AISC member companies. And check out [aisc.org/needforspeed](https://aisc.org/needforspeed) for more about our Need for Speed initiative.



The Wednesday night Elevate Reception.



The Student Steel Bridge Competition demonstration in the exhibit hall.



2022 AISC Award winners Todd Helwig, Charlie Carter (AISC president), Larry Kloiber, Susan Burmeister, Grady Harvell, Robert Tremblay, Gian Rassati, Allen Adams, James Swanson, Roberto Leon, Ryan Sherman, Kara Peterman, Dave Ruby, Carol Drucker, and Steve Knitter (AISC board chair). For details about these winners, see the related news item in the May 2022 issue at [www.modernsteel.com](http://www.modernsteel.com).

## Advocating for Equity and Education

Of course, it wasn't all just about speed. Equity has recently become a more visible concept in business, including the construction industry, and AISC has worked to bring together and promote the importance of a wealth of different experiences and backgrounds in the steel industry. This year's Steel Conference featured the first Elevate Reception, which gathered advocates for and allies of underrepresented groups in the architecture, engineering, and construction industries and showcased the work being done by AEC industry nonprofits focusing on equity, diversity, and inclusion.

"The Elevate Reception was an incredible opportunity to celebrate the work of underrepresented groups in AEC professions with food, drinks, and amazing views of downtown Denver," said Jonathan Tavarez, AISC's New York structural steel specialist. "It's exciting to think how this event can be even bigger and better in the coming years."

To learn more about AISC's equity efforts—and hear podcasts featuring diverse voices from the industry—visit [aisc.org/equity](http://aisc.org/equity).

The conference also offered in-person opportunities for college and university students in the form of Students Connecting with Industry Sessions (SCIS). One of these, the Direct Connect session, let students connect and interact with leading industry experts from design and construction companies from across North America.

"This was the best session of all the years we've attended," said Bora Erbilien, president of BBM Structural, a Direct Connect participant. "We're definitely interested in attending again next year."

This was also the first year of the Student Travel Grant program, which provided two university engineering students with an all-expenses-paid trip to the conference.

"I am very thankful that the grant created opportunities to meet with so many people and learn from their experiences," said one of the winners, Katie Davis, an engineering student at the University of Kansas. "I also thoroughly enjoyed the SCIS speakers. It was a great networking event for students looking for jobs or learning about different companies."

The return to the in-person format also allowed for presenters' passion to shine through more clearly. For example, the session "Structural Art in Steel Bridges: Past, Present, and Future" was presented by Maria Garlock as part of the bridge segment of the Steel Conference, the World Steel Bridge Symposium.

"Maria's passion for the subject was contagious, and her presentation was an uplifting call to arms that we deserve beauty in our structures and should take time to consider it," said Chris Garrell, NSBA's chief bridge engineer, of the session. "As designers adopt technologies like parametric modeling and additive manufacturing, this opens a world of possibilities for creativity that can be economical."

For some, the Denver show wasn't just the first live Steel Conference in what seemed like forever but was, in fact, the first one they'd ever attended.

"The first thought that comes to my mind is how impressed I was with the number of exhibits," said J.D. Lanz, a first-time attendee and structural engineer working for the Denver Fire Department. "Quite honestly, as a first-timer at NASCC, I was overwhelmed trying to digest all the exhibits. There is a constant movement for improving the steel industry, and I can understand why such a large number of people attended the conference."

Next year, the Steel Conference heads back east and is set to take place at the Charlotte Convention Center in Charlotte, N.C., April 12–14. We hope to see you there! ■



**Geoff Weisenberger**  
([weisenberger@aisc.org](mailto:weisenberger@aisc.org)), seen here with the Colorado Convention Center's famed big blue bear, is chief editor of *Modern Steel Construction*.



## new products

This month's New Products offerings are geared toward the job site and include sleeves to prevent arm lacerations, remote-controlled hooks for releasing riggings from a safe distance, and hangers that ease load placement on open-web steel joists.

### Milwaukee Tool Protective Sleeves

Milwaukee Tool has expanded its personal protective equipment offerings into arm protection with the debut of Cut Level 5 and Cut Level 3 Protective Sleeves, which help prevent arm lacerations. The sleeves feature a secure tapered fit and a silicone printed bicep band to prevent sliding, reduce sagging, and limit material bunching, as well as an elastic thumb loop to keep the sleeve in place when putting on gloves. To help users stay cool and protected while working in hot conditions, the sleeves are made of a moisture-wicking fabric that dries fast and are UPF 50+ rated. The protective arm sleeves are constructed of a comfortable four-way stretch material that does not restrict movement and allows a greater range of motion. The Cut Level 5 model is constructed of a 13-gauge knit, while the Cut Level 3 sleeves feature a 15-gauge knit that is lightweight and breathable. For more information, visit [www.milwaukeetool.com](http://www.milwaukeetool.com).



### OTH Pioneer Rigging Remote-Controlled Hooks

OTH's brand-new lifting auto-hooks come with a color-coded remote control (with a 200-ft range) to trigger the opening mechanism and cut the load loose while keeping the rigging with the hook, making it available for the next lift. With unlimited hooks synchronized on the same remote, users can design their own setup to lift up to 80,000 lb. Both versions (4,400-lb and 11,600-lb WLL LudwigHook) work with vertical, basket, or choker setups and any kind of attachment (wire rope, nylon rope, chains, eye bolts, etc.). The system can work for a full week with only one needed recharge regardless of the number of lifts. The OSHA-compliant system's safety features include a mechanical fall-protection design, an opening mechanism switched off from +55 lb loaded, a two-button sequence release on the remote to open the hook, and a locked state if the battery is fully discharged. For more information, visit [www.othrigging.com](http://www.othrigging.com).

### MCL Hangers

MCL Hangers were designed to place the hanger and threaded rod in the gap between the joist chord angles, thus hanging loads concentrically from either the top or bottom chord. By design, as the hanger is tightened to the joist, it will not rotate. The hangers feature a low profile that allows installation within 6 in. of panel points and easy installation with standard decking profiles. Designed to work on all open-web steel joists with 0.85-in. to 1.25-in. chord gaps, they can be used with threaded rods, carriage bolts, or standard hex head bolts and can be preassembled for quick installation on the joist. M1 models are designed for use on top and bottom chords where there is a 1-in. gap between angle irons, M2s can be used on top and bottom chords where there is either a 1-in. or 1½-in. gap between angle irons, and M3s are intended for all threaded rods, standard bolts, or carriage bolts. For more information, visit [www.mclhangers.com](http://www.mclhangers.com).

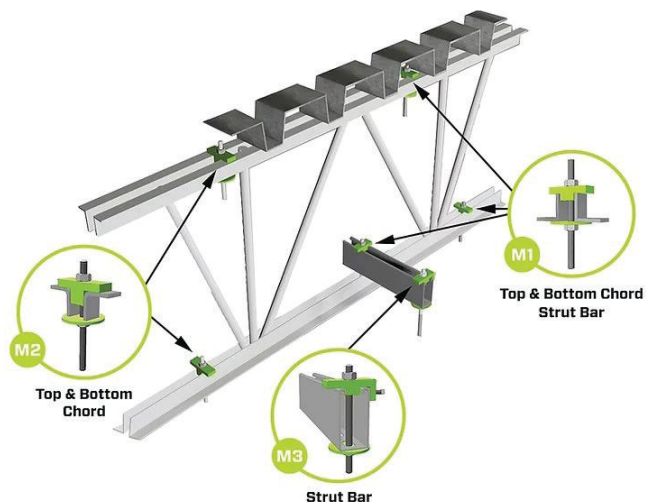

**HIGGINS AWARD**

**Nominations Sought for AISC's 2023 Higgins Lectureship Award**

Nominations are being accepted through July 1, 2022, for the prestigious T.R. Higgins Lectureship Award, which includes a \$15,000 cash prize. Presented annually by AISC, the award recognizes a lecturer-author whose technical paper(s) are considered an outstanding contribution to engineering literature on fabricated structural steel. The winner will be recognized at the 2023 NASCC: The Steel Conference, April 12-14, 2023 in Charlotte, N.C., and will also present their lecture, upon request, at various professional association events throughout the year.

Nominations should be emailed to AISC's Martin Downs at [downs@aisc.org](mailto:downs@aisc.org). Nominations must include the following information:

- Name and affiliation of the individual nominated (past winners are not eligible to be nominated again)
- Title of the paper(s) for which the individual is nominated, including publication citation
- If the paper has multiple authors, identify the principal author
- Reasons for nomination
- A copy of the paper(s), as well as any published discussion

The author must be a permanent resident of the U.S. and available to fulfill the commitments of the award. The paper(s) must have been published in a professional journal between January 1, 2017, and January 1, 2022. In addition, the winner is required to attend and present at the 2023 Steel Conference and also give a minimum of six presentations of their lecture on selected occasions during the year.

The award will be given to a nominated individual based on their reputation as a lecturer and the jury's evaluation of the paper(s) named in the nomination. Papers will be judged for originality, clarity of presentation, contribution to engineering knowledge, future significance, and value to the fabricated structural steel industry.

The current T.R. Higgins Lecturer is Amit Kanvinde, PhD, who received the award for his paper "Column Base Connections: Research, Design, and a Look to the Future" as well as for his outstanding reputation as an engineer and lecturer. If your organization is interested in hosting a T.R. Higgins lecture, please contact Christina Harber, AISC's director of education, at [harber@aisc.org](mailto:harber@aisc.org). And for more information about the award, visit [aisc.org/higgins](http://aisc.org/higgins).



2022 T.R. Higgins Lecturer Amit Kanvinde.

**ENGINEERING JOURNAL**

**Engineering Journal Seeks Technical Articles**

AISC is always looking for *Engineering Journal* articles on interesting topics or products relevant to steel design, research, construction, and fabrication methods. We are especially interested in technical articles with practical applications in the steel industry. If you have a new idea or an

improvement to an old idea, please submit your abstract or paper to Margaret Matthew ([matthew@aisc.org](mailto:matthew@aisc.org)) for potential publication in *Engineering Journal*. You can find detailed information on our review process and requirements for submittals at [aisc.org/ej](http://aisc.org/ej).

**MEMBERS**

**AISC Board Announces New Members**

The AISC Board of Directors has approved the following companies for membership.



**Full**

- C.A. Hull, Walled Lake, Mich.
- C & F Steel Design, Inc., Elmsford, N.Y.
- NYSFAB, Inc., Brooklyn, N.Y.
- Professional Piping Systems, LLC, Phoenix



**Associate**

- Brainstorm Infotech, Bangalore, India, *Detailer*
- Columbia Safety and Supply, Columbia, Mo., *Equipment Manufacturer*
- Core Cogent Detailing Services, Inc., Hyderabad, India, *Detailer*
- Electro-Mechanical Integrators, Inc., Green Lane, Pa., *Equipment Manufacturer*
- Industria Metalica Integrada, SA, DE, CV, Santa Cruz Chignahuapan, Mexico, *Erector*
- Kumars Safe Structures, LLP Karumandapam, India, *Software Vendor*
- L. Wiley Steel Solutions, La Mesa, Calif., *Detailer*
- Ling, LLC, The Woodlands, Texas, *Detailer*
- NC Steel Detailing, Kernersville, N.C., *Detailer*
- Outpace Steel Detailing, Kakinada, India, *Detailer*
- Sirius Steel Services, Inc., Columbus, Ohio, *Detailer*
- StraeCon, Tempe, Ariz., *Detailer*
- Visai Energy, Inc., Calgary, Canada, *Detailer*





### IN MEMORIAM

## William Nottingham, Prolific Alaskan Steel Bridge Engineer, Dies at 84

William Dennis Nottingham, PE, a co-founder of PND Engineers, Inc. (PND), died on March 6. He was 84 years old.

Born in 1937 in Fort Benton, Mont., Nottingham was one of the most influential engineers in Alaska history, designing more than 300 bridges over the course of his career. After receiving bachelor's and master's degrees in civil engineering from Montana State College, he moved to Juneau, Alaska, in 1962, where he eventually met Roy Peratrovich, Jr., with whom he founded PND in 1979. Nottingham served as the company's president for 30 years until his retirement in 2009.

Nottingham won the prestigious NOVA Award from the Construction Innovation Forum, Inc., in 1998 for PND's Open Cell Sheet Pile (OCSP)

bulkhead technology. In addition, three of his steel bridges in Alaska were honored as NSBA Prize Bridge Award winners: Kuparuk River Submersible Bridge, North Slope, Most Beautiful Bridge Award (Special Purpose) in 2000; Tudor Road Trail Crossing, Anchorage, Most Beautiful Bridge Award (Special Purpose) in 1996; and Endicott Causeway Bridge, North Slope, Most Beautiful Bridge Award (Special Purpose Merit) in 1996.



### FORGE PRIZE

## Harlem Housing Concept Wins 2022 Forge Prize



A vision of a reinvigorated public housing community in Harlem has won the AISC's 2022 Forge Prize.

The three finalists presented their projects live on YouTube in a stream that drew an international audience from as far away as South Africa. After tough deliberation, the 2022 Forge Prize jury rendered its verdict. Vincent Yee Foo Lai of Adjaye Associates and Douglas Lee of the University of California, Berkeley took home the \$10,000 grand prize for an inspiring concept to transform public housing in New York City's Harlem.

The Forge Prize is unique in that it matches emerging architects with steel fabricators to brainstorm innovations

that could make the three finalist design concepts easier and more economical to construct in the real world.

Lai and Lee worked with fabricator Rob Williams of Steel LLC to refine their concept in the second phase of the competition. One of the things that emerged from that partnership was a steel column with a tectonic train-track rail. That component of the steel structure would facilitate transporting materials up to the job site. The rail would also contain mechanical systems.

For more information on the Forge Prize, see [www.forgeprize.com](http://www.forgeprize.com). And check out the August issue for details and images of all three finalists.

## People & Companies

The **American Galvanizers Association (AGA)** board of directors recently announced the appointment of **Alana Fossa** as technical director for the organization. **Tom Langill**, AGA's previous technical director, will be cutting back to three days a week as technical director emeritus. Fossa has been with the AGA since 2015, serving as the corrosion engineer and senior corrosion engineer. During her tenure, she has become an invaluable source of hot-dip galvanizing (HDG) knowledge for members and specifiers and a trusted expert on HDG with key influential organizations such as **AISC's National Steel Bridge Alliance (NSBA)**, the **Association for Materials Protection and Performance (AMPP)**, **ASTM International**, and the **American Iron and Steel Institute (AISI)**.

Two AISC member companies have joined the **Steel Erectors Association of America's (SEAA's)** network of **SEAA/NCCER** Ironworker Training Units and Assessment Sites: **GMF Steel Group** and **SL Chase Steel Fabricators and Erectors**. The program grants SEAA member companies access to nationally recognized credentials for ironworkers, riggers, crane operators, and signal persons. Because of SEAA's affiliation with NCCER, members also have access to the craft training materials, assessments, and certifications for all of NCCER's craft training curricula.

Engineering, architectural, planning, and program and construction management services company **STV** recently announced it has brought aboard **George Gorrill, SE, PE**, to serve as vice president and Midwest business unit leader. Based in the Chicago office, Gorrill will lead all STV efforts in the Midwest, including recruiting and managing talent throughout the region, as well as developing plans to better serve STV clients and the market. The company has also hired **Kim Vierheilg, AIA**, as its new president of buildings and facilities. Vierheilg will lead the architecture and engineering practice nationally and serve on STV's executive leadership team.



**SMITH-EMERY**

Inspection • Testing • Metallurgy

Assuring Structure & Life Safety Since 1904

**Non-Destructive Testing**

- PAUT
- Visual (CWI, CWB, CSWIP)
- MT
- UT

**Owner QA**

- Fabrication Oversight
- Specification Review
- Field Inspections
- WPS Reviews

**Metallurgical Laboratory**  
**Environmental Laboratory**  
**Firestop Inspection**

**Supplier Audits**

- IAS
- IAPMO
- City of Los Angeles
- Clark County, NV

**Contractor QC**

- Fabrication Shop NDT, CWI
- Vendor Audits
- QMS Development
- WPS and PQR Testing

**Curtain Wall Performance Testing**  
**Concrete Testing**  
**Chemical Laboratory**

1.833.405.0536

steel@smithemery.com

www.smithemery.com



**Structural Engineers**

Are you looking for a new and exciting opportunity?

We are a niche recruiter that specializes in matching great structural engineers with unique opportunities that will help you utilize your talents and achieve your goals.

- We are structural engineers by background and enjoy helping other structural engineers find their "Dream Jobs."
- We have over 30 years of experience working with structural engineers.
- We will save you time in your job search and provide additional information and help during the process of finding a new job.
- For Current Openings, please visit our website and select Hot Jobs.
- Please call or email Brian Quinn, PE: 616.546.9420 **Brian.Quinn@FindYourEngineer.com** so we can learn more about your goals and interests. *All inquiries are kept confidential.*

SE Impact by SE Solutions, LLC | [www.FindYourEngineer.com](http://www.FindYourEngineer.com)

Connect with AISC on **SOCIAL MEDIA**

[aisc.org/linkedin](http://aisc.org/linkedin)

@AISC

AISCdotORG

@AISC

[youtube.com/AISCSteelTV](http://youtube.com/AISCSteelTV)

**LATE MODEL STRUCTURAL STEEL MACHINES AVAILABLE IMMEDIATELY**

- Voortman V630/1000** CNC Drill Line, (3) Drill Units, ATC, VB1050 20" x 44" Saw, Conveyor & Transfers, 2006, #31801
- Peddinghaus PCD-1100** Drill & Saw Line, 44" x 18" Capacity, (3) Spindle, Meba 1140/510 Saw, Siemens CNC, In/Out Conveyor, 2006, #31842
- Peddinghaus AFCPS 823-B** Anglemaster, 8" x 8" x 3/4" Capacity, Infeed Conveyor, PC Based CNC, 2006, #31841
- Peddinghaus HSFDB 2500/B** Plate Processor, 3" Plate, 96" Maximum Plate Width, HPR400XD Plasma, Drill, Oxy, 2015, #31660
- Roundo R-13-S** Section Bender, 8" x 8" x 1.25" Leg In, 31.5" Diameter Rolls, 105 HP, Universal Rolls, 1998, #29237
- Ficpep K100** Structural CNC Band Saw, 40" W x 17.75" H Capacity, 1.61" Blade Width, Mitering, Ficpep CNC, 2013, #31910
- Peddinghaus ABCM-1250A** Beam Coping Line, 50" x 24" Maximum Profile, Fagor 8055 Retrofit, #31655



**WE ARE ACTIVELY LOOKING FOR USED STRUCTURAL STEEL EQUIPMENT**

**CONTACT: [Claire@PrestigeEquipment.com](mailto:Claire@PrestigeEquipment.com)**

[www.PrestigeEquipment.com](http://www.PrestigeEquipment.com) | (631) 249-5566

To advertise, contact M.J. Mrvica Associates, Inc.: 856.768.9360 | [mjmrvica@mrvica.com](mailto:mjmrvica@mrvica.com). Search employment ads online at [www.modernsteel.com](http://www.modernsteel.com).

advertiser index

AISC	8   23   67	Messer Cutting Systems	45
Applied Bolting	45	New Millenium Building Systems	5
ACT Metal Deck Supply	25	Nucor Tubular	13
Automated Layout Technology	56	Peddinghaus Corporation	2
Bend-Tech	12	QuickFrames USA	53
Chicago Metal Rolled Products	insert	SDS2	7
Controlled Automation	14	Simpson Strong Tie	15
DuraFuse	59	St. Louis Screw & Bolt	59
IDEA Statica	3	Structural Steel Manufacturing, Inc.	53
Locomotion	back cover	Trimble	11
MDX	39	Voortman	57





## Foremost Flyover

**AN INTERSTATE FLYOVER** in Connecticut is the first-ever NSBA Bridge of the Year.

National Steel Bridge Alliance staff and participants at the 2022 World Steel Bridge Symposium, which took place as part of NASCC: The Steel Conference in March in Denver, selected the I-91 Interchange 29 Exit Ramp Flyover Bridge in Hartford for the top honor in this year's NSBA Prize Bridge Awards program. This is the first year NSBA has presented the Bridge of the Year Award.

Designed by CHA Consulting and with steel fabricated by AISC member High

Steel Structures, the 880-ft-long bridge is the centerpiece of a recent project to reduce daily congestion. The interchange now features a two-lane, high-speed ramp that showcases a novel approach: a triple I-girder straddle bent that provides load path redundancy, eliminating fracture-critical designations and the associated long-term inspection costs.

An additional benefit became clear during fabrication: The triple I-girder configuration is surprisingly economical to fabricate, costing substantially less than a comparable box girder with reduced shipping costs. The team found

even more opportunities for savings by choosing uncoated weathering steel, in which a patina protects the structural steel from corrosion. The Connecticut Department of Transportation has used uncoated weathering steel since the early 1960s, and some of the oldest bridges are still in very good condition after more than a half-century of service.

The bridge was also honored with a Prize Bridge Award in the Medium Span Category. To read more about it and the rest of this year's winners—and see plenty of great images—check out next month's (July) issue. ■



# CALLING ALL INNOVATORS!

If you recently worked on an amazing project that featured structural steel, we want to hear from you.

Submit it for a 2023 IDEAS<sup>2</sup> award!



## 2023 IDEAS<sup>2</sup> AWARDS

Entries close on September 30, 2022  
Enter now at [aisc.org/ideas2](https://aisc.org/ideas2)

2022 NATIONAL AWARD  
\$75 Million to \$200 Million  
**Buddy Holly Hall  
of Performing Arts  
and Sciences**  
Lubbock, Texas



# Follow the leaders *to efficiency*

*The success of business often hinges on the strength of the partnerships forged along the way.*

That is why we're proud to announce the partnership of PGT Trucking + Locomotion to deliver the future of freight transportation.

When you bring together a leader in the flatbed transportation industry with the leader in human-guided automated trucking technology, well, you end up with a pretty strong bond. Together, PGT + Locomotion are leading the way to increased efficiency, more capacity, elevated safety, and a greener footprint. Better for drivers, better for the earth, and better for your bottom line.

Start your journey to efficiency.

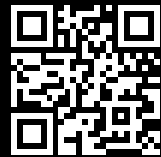

**Follow the leaders**



**LOCOMOTION**  
human-guided autonomy™

