

Modern Steel Construction

February 2023



TRUE ROBOTIC

STEEL BEAM ASSEMBLY + WELDING

NO MANUAL LAYOUTS

NO MANUAL TACKING

NO HUMAN ERROR

www.peddinghaus.com/steel/assembler

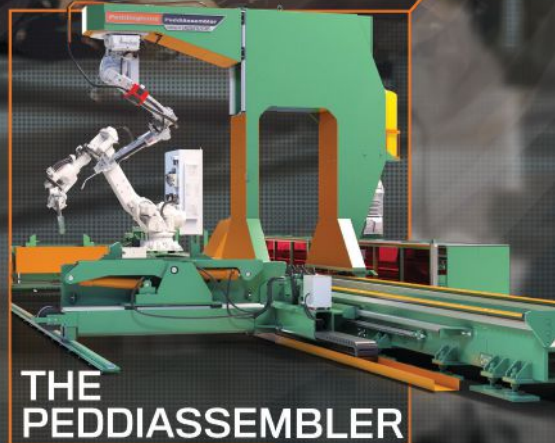

THE PEDDIASSEMBLER

Peddinghaus

STRONGER THAN STEEL®

www.peddinghaus.com | info@peddinghaus.com | (815) 937-3800

Modern Steel Construction

February 2023

in every issue

departments

- 6 EDITOR'S NOTE
- 9 STEEL INTERCHANGE
- 12 STEEL QUIZ
- 60 NEW PRODUCTS
- 61 NEWS & EVENTS
- 66 STRUCTURALLY SOUND

resources

- 65 ADVERTISER INDEX
- 65 MARKETPLACE & EMPLOYMENT



features

28 On the Right Track

BY ROB GRAPER, SE, PE
The team for a new world-class indoor sports facility in Spokane, Wash., updated its original framing system design to be a winning fit for the venue.

36 Elevating the Story

BY XIAOXIAO WU, PE, AND DAVID HIMELMAN
A new steel-framed museum in Charleston, S.C., floats above its waterfront location and tells the stories of the people it celebrates.

44 Mighty Bridge over the Mighty Mississippi

BY AHMAD ABU AFIFEH, PE
The new I-74 bridge over the Mississippi River between Iowa and Illinois, designed as a landmark structure, looked to grade 70 steel and stainless steel anchor rods to reduce maintenance for a planned 100-year service life.

columns

steelwise

16 Seismic Harmonization

BY LARRY KRUTH, PE, AND MIKE GASE

Updates to Chapter J of the AISC *Seismic Provisions* and harmonization with the AISC *Specification* will result in simpler seismic design for steel structures.

steelwise

18 Turning up the Heat

BY KRISTI SATTLER, SE, PE, PHD, AMIT H. VARMA, PHD, AND FARID ALFAWAKHIRI, PENG, PHD

An updated and expanded Appendix 4 in the new AISC *Specification* provides more consolidated and comprehensive guidance on fire design.

data driven

22 Get Smart (with Data)

BY BRIAN RAFF

AISC's construction industry database can help you leverage market intelligence to make smart business decisions.

field notes

24 Steel Saga

INTERVIEW BY GEOFF WEISENBERGER

Larry Kruth has dedicated the majority of his life to the structural steel industry as a practicing engineer, a fabricator, a safety expert, an instructor, a committee volunteer, and an AISC vice president. And even though he recently retired (for the second time), his work with the industry will continue.

business issues

26 Mindful Selling

BY DOUG JONES AND MICHAEL SENNEWAY

Successfully selling in today's construction world is about much more than the bottom line.

conference previews

52 Applicable Analysis

BY RAFAEL SCUDELARI DE MACEDO AND LUIZ FRANCISCO SCUDELARI DE MACEDO

Learn about the intersection of connection design and finite element analysis at NASCC: The Steel Conference.

54 Buying Green

BY MAX PUCHEL, SE, PE, AND JOHN CROSS, PE

As the prevalence of Buy Clean laws and the demand for environmental product declarations increase, it's important to stay up to date on these and other sustainability-related topics.

58 Upward Expansion

BY PAT HASSETT, SE, AND JAMES ACEVEDO

The host building for last year's NASCC: The Steel Conference, the Colorado Convention Center, provides an erection engineering lesson at this year's conference.

ON THE COVER: The steel-framed Podium in Spokane, Wash., elevates the city's profile as well as indoor track events, p. 28. (Photo: Lara Swimmer)

MODERN STEEL CONSTRUCTION (Volume 63, Number 2) ISSN (print) 0026-8445: ISSN (online) 1945-0737. Published monthly by the American Institute of Steel Construction (AISC), 130 E Randolph Street, Suite 2000, Chicago, IL 60601. Single issues \$8.00; 1 year, \$60. Periodicals postage paid at Chicago, IL and at additional mailing offices. Postmaster: Please send address changes to MODERN STEEL CONSTRUCTION, 130 E Randolph Street, Suite 2000, Chicago, IL 60601.

DISCLAIMER: AISC does not approve, disapprove, or guarantee the validity or accuracy of any data, claim, or opinion appearing under a byline or obtained or quoted from an acknowledged source. Opinions are those of the writers and AISC is not responsible for any statement made or opinions expressed in MODERN STEEL CONSTRUCTION. All rights reserved. Materials may not be reproduced without written permission, except for noncommercial educational purposes where fewer than 25 photocopies are being reproduced. The AISC and Modern Steel logos are registered trademarks of AISC.



Printed on paper made from a minimum of 10% recycled content.



Building CONNECTIONS

AESTHETICS | ACOUSTICS | FLEXIBILITY | CONSTRUCTABILITY | SUSTAINABILITY

Your success starts with the right steel joist and deck supplier

Make successful connections. Control costs, improve performance and achieve project success using our steel joists and steel deck. Get answers, advice and assistance from our supportive specialists. Find the ideal structural steel building solution for your next project. **Together, let's build it better.**



Connect with us at
NASCC
Booth 1610
newmill.com



NEW MILLENNIUM

A Steel Dynamics Company

BUILDING SUCCESS TOGETHER

editor's note



For my family, it's an annual reality. No, it doesn't involve my wife and me leaving our careers in the "big city" to move back to a small mountain town to rekindle relationships with love interests from our youth. And nobody ends up kissing outside as the snow starts to fall (and if they do, it's completely unscripted and they're just "extras" in the background).

We make the annual trek because my wife is originally from the Denver area, I used to live there as well, and all of my in-laws reside there. The 2022 trip was actually our first holiday visit there since 2019. COVID in general kept us from making the trip in 2020, COVID in my house thwarted our plans in 2021 (wasn't me), but this year, everything went smoothly.

Speaking of smoothly, we made a short trip to a small mountain town with my brother-in-law's family and spent some time sliding around on a frozen lake. At one point, some ranger types made everyone get off the ice, presumably because it was so warm and the ice was in danger of melting. We also went sledding. And while the quality of the sledding wasn't terrible, it was somewhat diminished due to lots of exposed ground and the snow being just a bit slushier than expected in late December, especially in the mountains.



"Christmas in Colorado" sounds like a Hallmark movie.

In fact, without checking Google, I'd wager there might already be one with that title.

Now everyone will talk about how the weather changes "at a moment's notice" wherever they live. If you've ever spent any time in Colorado, you know that this statement is truer there than in most places. Six inches of snow overnight can often become halfway melted by the following afternoon (this also happened during our trip). Scenarios like this can serve as a microcosm for recent global weather trends, particularly the phenomenon of weather in one area going from one extreme to another in a very short time period, thanks to climate change.

For a while now, many players in the buildings industry have been pushing how their products or methods are greener or more sustainable than the alternatives or past practices, and how they're best suited to tackle climate change. While some of these marketing efforts don't paint a full picture, structural steel has a factual, credible, and comprehensive case when it comes to being a sustainable, resilient framing material, and you can find out more at aisc.org/sustainability.

You can also attend the 2023 NASCC: The Steel Conference, taking place in Charlotte April 12–14, which will feature a handful of sessions focusing on sustainability and steel. In fact, you can read a preview of one of them in the article "Buying Green" on page 54, which focuses on Buy Clean Laws and environmental product declarations (EPDs), two prominent topics in the ever-evolving sustainability conversation.

Want to learn more about this and the rest of this year's conference sessions—and register? Visit at aisc.org/nascc. Meanwhile, I hope 2023 is off to a good start for you! And remember to steer clear of thin ice.

Geoff Weisenberger
Chief Editor

Modern Steel Construction

Editorial Offices

130 E Randolph St, Ste 2000
Chicago, IL 60601
312.670.2400

Editorial Contacts

CHIEF EDITOR
Geoff Weisenberger
312.493.7694
weisenberger@aisc.org

PUBLISHER

Keith A. Grubb, SE, PE
312.804.0813
grubb@aisc.org

GRAPHIC DESIGN MANAGER

Kristin Hall
773.636.8543
hall@aisc.org

EDITORIAL DIRECTOR

Scott Melnick
312.804.1535
melnick@aisc.org

AISC Officers

CHAIR

Stephen H. Knitter
Geiger & Peters, Inc.

VICE CHAIR

Hugh J. McCaffrey
Southern New Jersey Steel Co.

SECRETARY/LEGAL COUNSEL

Edward Seglias, Cohen Seglias
Pallas Greenhall & Furman, PC

PRESIDENT

Charles J. Carter, SE, PE, PhD

SENIOR VICE PRESIDENTS

Scott Melnick
Mark W. Trimble, PE

VICE PRESIDENTS

Todd Alwood
Carly Hurd
Mike Mospan
Christopher H. Raebel, SE, PE, PhD
Brian Raff

Editorial Advisory Panel

Brandon Chavel, PE, PhD
Michael Baker International

Nat Killpatrick
Basden Steel

Christina McCoy, SE
Oklahoma State University
School of Architecture

Allison Shenberger, PE
ruby+associates

Justin Smith, PE
Walter P Moore

Advertising Sales

M.J. Mrvica Associates, Inc.
2 W Taunton Avenue
Berlin, NJ 08009
856.768.9360
mjmrvica@mrvica.com

Address Changes and Subscription Concerns

312.670.2401
subscriptions@aisc.org

Reprints

Kristin Hall
hall@aisc.org

VISIT US AT NASCC
BOOTH 1416

BETTER FABRICATION STARTS WITH SDS2

Drive efficiency and profitability for your projects with SDS2 by ALLPLAN, the only steel detailing software with all-in-one intelligent connection design.

Deloitte

Deloitte Summit Tower, Vancouver
Detailed in SDS2 by Supermétal Structures
Photo courtesy of Westbank



REQUEST A DEMO



SDS2
BY ALLPLAN



Quality Management Company, LLC (QMC) is seeking qualified

INDEPENDENT CONTRACT AUDITORS

to conduct site audits for the American Institute of Steel Construction (AISC) Certified Fabricators and Certified Erector Programs.

This contract requires travel throughout North America and limited International travel. This is not a regionally based contract and a minimum of 75% travel should be expected.

Contract auditors must have knowledge of quality management systems, audit principles and techniques. Knowledge of the structural steel construction industry quality management systems is preferred but not required as is certifications for CWI, CQA, or NDT. Prior or current auditing experience or auditing certifications are preferred but not required.

Interested contractors should submit a statement of interest and resume to contractor@qmcauditing.com.

steel interchange

If you've ever asked yourself "Why?" about something related to structural steel design or construction, *Modern Steel's* monthly Steel Interchange is for you!

Send your questions or comments to solutions@aisc.org.

Column Reinforcement for Longer Unbraced Length

We are renovating an existing building, and the project will require removing steel members, bracing an existing steel column, and increasing the unbraced length of the column. The existing steel column will need to be reinforced to account for the change to the unbraced length. Do you have any thoughts you could share on this approach?

If an existing lateral brace is removed, the column can be analyzed using the new unbraced length without consideration of the former brace. If required, the column can be reinforced. The flexural buckling equations in Section E3 of *AISC Specification for Structural Steel Buildings* (ANSI/AISC

360) are valid for existing W-shape columns (assuming non-slender elements) if they meet the out-of-straightness tolerance in the 2022 *AISC Code of Standard Practice for Steel Buildings and Bridges*, Section 11.2.2.1. The 2013 AISC webinar "Design of Reinforcement for Steel Members—Part 1" provides information on the reinforcement of columns.

Unless the column can be completely unloaded during construction, the strength during construction must be considered. The 2014 AISC webinar "Design of Reinforcement for Steel Members—Part 2" discusses the effect of heat on column strength during welding. Part 1 discusses the effect of preload, which is

the axial compression force at the time of reinforcement, and also weld distortion (after the weld cools) and provides a design method to consider the effect of an out-of-straightness greater than $L/1,000$.

An alternative design and analysis method that is similar to the direct analysis method is outlined in a 2019 NASCC: The Steel Conference presentation, "Design of Column Reinforcement." (All mentioned webinars/presentations are available at (available at aisc.org/education/continuingeducation/education-archives).

Bo Dowsell, PE, PhD

Hot-Rolled Structural Sections

Can you please provide or point me to a definition of "hot-rolled structural sections?" I am interested to know if the following product description would be included in the category of hot-rolled structural sections: "Mill light structural shapes—carbon steel used within construction as structural support, including carbon and HSLA (high-strength low-alloy) angles, channels, Tees and Zees."

Hot-rolled means that the steel is worked (shaped by rolling) at a temperature high enough that the strain hardening associated with cold working will not occur. This would be at temperatures between 1,700 °F and 2,300 °F. The product description quoted in your question lists several examples of shapes that are typically hot-rolled. It is common to find hot-rolled angles and channels used in structural steel construction.

Zees can also be hot-rolled but are less commonly used in structural steel construction.

While tees can be hot-rolled, currently (for the last several decades), it has been much more common to cut tees from wide-flange sections, which are also hot-rolled.

Larry Muir, PE

All mentioned AISC publications, unless noted otherwise, refer to the current version and are available at aisc.org/publications. *Modern Steel* articles can be found at www.modernsteel.com.

Reinforcing a Wide-Flange Beam Due to Local Flange Bending

An attachment to the bottom flange of a wide-flange beam places a concentrated load on the bottom flanges (see Figure 1). The local flange bending strength is not sufficient, based on my current analysis. I can't add a web stiffener as it would interfere with the attachment to the bottom flange. This leaves me with either adding stiffeners on either side of the attachment along the axis of the beam (Option 1) or adding a cover plate to the bottom flange (Option 2). I am concerned that a cover plate might not help since the vertical load would still have to pass through the beam flange to get to the web. Does either of these options seem reasonable?

Typically, the flange bends in double curvature due to the restraining effect of the connecting element. When a restraining force is not present (e.g., with a hanger

rod connection), the flange will deform in single curvature. You have indicated that you are addressing single curvature bending. The 2013 AISC *Engineering Journal* article "Flange Bending in Single Curvature" reviews the available design methods for checking the flexural strength of the flange due to concentrated forces being applied to the flange. This article also provides accurate equations for both strength and serviceability (if required). You will need to use your judgment to determine which equations are appropriate for your condition.

The web stiffeners may be a reasonable option to strengthen the flanges. The equations referenced in the article can be used to calculate the strength. If the distance from the load to the stiffener, x_s , is less than x (see Figure 2), the stiffeners will increase the strength. If x_s is greater than x , the stiffeners will not affect the strength. x is

calculated with Equation 19. b is calculated with Equation 18 using x_s instead of x , and the nominal strength, P_n , is calculated with Equations 17 and 21. Because Equation 21 was derived for only one yield line, P_n is the strength of the flange on only one side of the web. An appropriate safety factor, W , or reduction factor, ϕ , should be used for ASD and LRFD design, respectively.

As you mentioned, the effectiveness of the cover plate would be difficult to predict. I'm not aware of a design method for this configuration.

$$\alpha = \pi/2 + \beta \quad (17)$$

$$\tan \beta = a/x \quad (18)$$

$$x = 3\sqrt{bc} \quad (19)$$

$$P_n = F_y t_f^2 \alpha \quad (20)$$

$$P_n = F_y t_f^2 [\pi/2 + \beta] \quad (21)$$

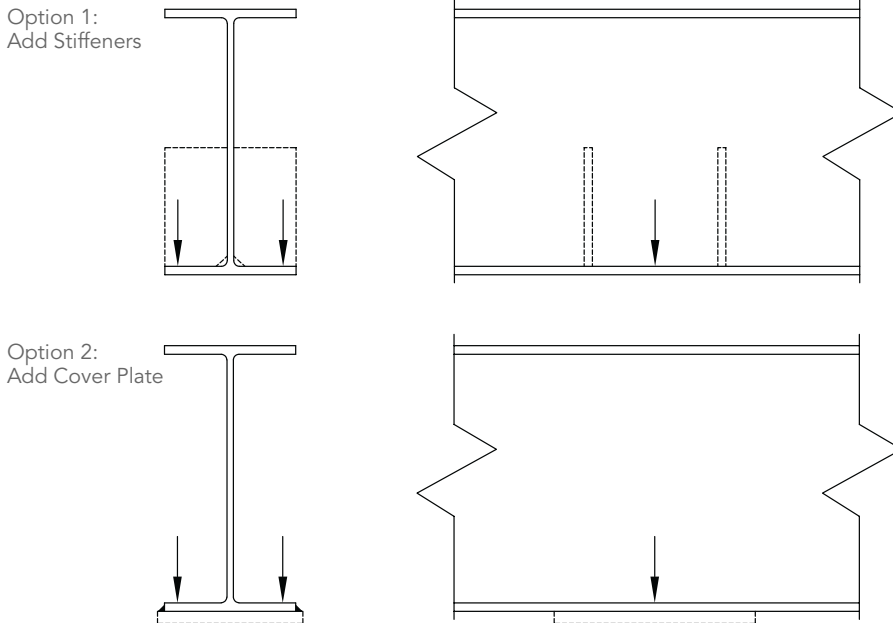

Fig. 1. Possible reinforcement options.

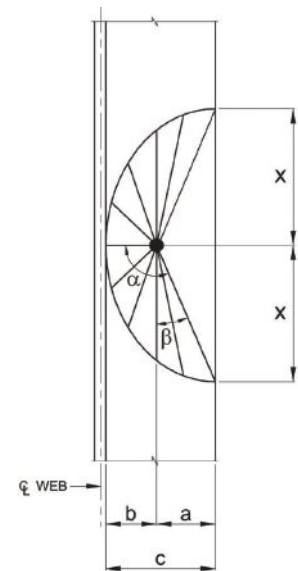

Fig. 2. Parabolic yield line pattern.

Bo Dowswell, PE, PhD

Bo Dowswell, principal with ARC International, LLC, and Larry Muir are consultants to AISC.



Steel Interchange is a forum to exchange useful and practical professional ideas and information on all phases of steel building and bridge construction. Contact Steel Interchange with questions or responses via AISC's Steel Solutions Center: 866.ASK.AISC | solutions@aisc.org

The opinions expressed in Steel Interchange do not necessarily represent an official position of the American Institute of Steel Construction and have not been reviewed. It is recognized that the design of structures is within the scope and expertise of a competent licensed structural engineer, architect or other licensed professional for the application of principles to a particular structure.

The complete collection of Steel Interchange questions and answers is available online at www.modernsteel.com.

It's a New Era in Detailing



Don't Get Left Behind

There is a new era in detailing software, an era that is marked by greater accuracy, more collaboration and a mitigated risk of errors which all leads to improved financial outcomes. If your detailing software is limiting your ability to transition to more efficient workflows then you are in luck—there has never been a better time to switch to Tekla Structures, the industry's leading 3D steel detailing software.

If you are ready to learn how using Tekla Structures can enable more efficient workflows leading to improved financial outcomes, visit tek.la/new-era and request a demo.

steel quiz

By now, we hope you've heard that there's a new edition of the AISC Code of Standard Practice for Steel Buildings and Bridges (ANSI/AISC 303-22)—or better yet, have already downloaded your free copy (if you haven't, visit aisc.org/2022code). The 2022 AISC Code supersedes the 2016 edition (ANSI/AISC 303-16), and this quiz is part one of a two-part effort to test your knowledge of the revisions and additions in the new version.

- 1 **True or False:** The 2022 edition of the AISC Code is a complete revision of the 2016 edition.
- 2 The following term(s) was added to the Glossary of the 2022 Code:
 - a. Construction documents
 - b. Issued for construction
 - c. Releasing of design documents and specifications
 - d. All of the above
- 3 Which of the following is new language that was added to Section 1.1 of the 2022 Code (hint: Section 1 covers scope):
 - a. In the absence of specific instructions to the contrary in the contract documents, the trade practices that are defined in this Code shall govern the fabrication and erection of structural steel.
 - b. Specific instructions to the contrary shall not violate any provisions of applicable building codes.
 - c. Both a and b
 - d. None of the above
- 4 **True or False:** Steel used as piling or piling accessories was added to Section 2.2 as "other steel, iron, or metal items" and is not considered structural steel.
- 5 **True or False:** Section 3.1 of the 2022 Code refers to the AISC Specification for Structural Steel Buildings (ANSI/AISC 360) for requirements of information to be included in design documents and specifications issued for construction.
- 6 To ensure the orderly flow of material procurement, detailing, fabrication, and erection activities on phased construction projects, it is essential that designs are not continuously revised after they have been _____.
 - a. issued for construction
 - b. issued for bidding
 - c. released for construction
 - d. released for bidding
- 7 **True or False:** A provision requiring the owner's designated representative for construction to provide a construction schedule in the bid documents is not new to the 2022 Code.
- 8 **True or False:** A new Section 3.2 requires that structural design documents and specifications issued as the basis for contract documents include all the information required for a complete design as defined in Section 3.1, regardless of the project delivery method.

TURN TO PAGE 14 FOR ANSWERS



VOORTMAN MSI FULLY AUTOMATED INTEGRATED PRODUCTION LINE



FULLY AUTOMATED PRODUCTION



BUFFER MANAGEMENT



SMART UNLOADING



DATA DRIVEN APPROACH



HIGH FLEXIBILITY



CONNECTED BY VACAM-SOFTWARE

With a Voortman beam processing line packed with high-quality hardware and intelligent software, a door opens to fully automated production and intra-logistic processes. We call it MSI: Multi System Integration. All machines are seamlessly connected via our VACAM-software, cross transports, roller conveyors, product buffers and material sensors. Thanks to our intelligent buffer management, the system is able to work autonomously for long periods of time with maximum throughput.

DESIGNING A PERFECT FIT!
To get to such an optimal lay-out with maximum efficiency, we use a data-driven approach combining your input and requirements with real data while keeping future expectations into account. Curious what your optimal lay-out with maximum processing efficiency looks like? Then challenge us!

AUTOMATIC WELDING AND ASSEMBLING

- Automatic fitting and welding of long and heavy beams;
- Capable of the most common connection types;
- Simultaneous loading and unloading of the machine with an automatic magnetic crane.
- The Fabricator can be integrated with other Voortman machines in a complete production line.





Voortman USA LLC / 26200 S. Whiting Way / Monee, IL 60449 - USA / +1 708 885 4900 / WWW.VOORTMANCORP.COM

VisualAnalysis

Model, Load, Analyze,
Design, Report, and

Succeed!



easy.iesweb.com

VisualAnalysis is an easy design tool, for 28 years. Find out why engineers love it.

steel quiz

ANSWERS

If you are not yet familiar with the revisions to the latest AISC Code, don't panic. We have several great resources to help you (including this quiz). As always, the preface of the Code includes a summary list of changes and updates. Last month's SteelWise article "Talking through the Code" (available in the Archives section at www.modernsteel.com) provides an excellent review of the updates through the lens of an engineer, a fabricator, and an erector. There was also a four-part series of sessions at 2022 NASCC: The Steel Conference devoted to the 2022 Code, which can be viewed at aisc.org/educationarchives.

- 1 **False.** As stated in the preface of the 2022 edition, "Like the 2005, 2010, and 2016 editions, the 2022 edition is not a complete revision but does add important changes and updates. It is the result of the deliberations of a fair and balanced Committee, the membership of which included structural engineers, architects, a code official, general contractors, fabricators, a steel detailer, erectors, and inspectors."
- 2 **d.** All of the above. New terms that are tied to new provisions or new concepts, or simply clarify existing concepts, were added to the Glossary. The terms construction documents, issued for construction, and releasing of design documents and specifications were all added to the Glossary. These terms were all added to distinguish between contract documents (a term that has been in the Code for many years), construction documents, and the issuance or release of such documents.
- 3 **b.** Specific instructions to the contrary shall not violate any provisions of applicable building codes. The text in answer a. was already in the 2016 edition. Section 1.1 provisions were revised in the 2022 edition to strengthen the Code and provide clear requirements when specific instructions to the contrary are included in contract documents. The commentary to this section has been greatly expanded to achieve a common understanding of the responsibilities and expectations of each

party. The commentary states: "No modifications should be made to any Code section that violates the life safety or serviceability provisions of the applicable building code or results in a commercial advantage for any party that violates the intention of the Code to serve as a fair, balanced consensus document."

- 4 **True.** Steel used as piling or other piling accessories was added to Section 2.2 as "other steel, iron, or metal items." The 2022 Code has been updated to clearly note that steel used as piling or piling accessories does not fall within the category of structural steel and is not the responsibility of the fabricator unless specifically addressed and agreed upon contractually.
- 5 **True.** A new Section 3.1 now refers to the AISC Specification for the requirements of what should be included in the design documents. The new 2022 Code addresses several areas of concern in the industry while also providing clearer harmonization with the Specification. A new Section 3.1 was added with provisions on structural design documents and specifications issued for construction. Since the Specification is fully incorporated into the International Building Code (IBC), there is now no question as to what is required to be shown for trades to accurately provide bids without assumptions.
- 6 **c.** released for construction. The term released for construction in the 2022 Code did not change from the 2016 edition. Released for construction is defined in the Glossary as "the term that describes the status of contract documents that are in such a condition that the fabricator and the erector can rely upon them for the performance of their work, including the ordering of material and the preparation of shop and erection drawings or fabrication and erection models." In essence, once a portion of a design is released for construction, the essential elements of that design should be "frozen" to ensure adherence to the contract price and construction schedule. Section 3 of the 2022 Code has

been significantly revised, introducing new terminology of "issuing" design documents by the owner's designated representative for design (ODRD) and "releasing" design documents by the owner's designated representative for construction (ODRC), along with the purposes of these actions. Again, see the January SteelWise article "Talking through the Code" for more information on the purpose of these different terms.

- 7 **False.** A new Section 1.7 was added with provisions on construction scheduling. The change requires the owner's designated representative for construction to provide a construction schedule in the bid documents. Further, the performance period by the steel fabricator and erector shall be mutually agreed upon before awarding the contract.
- 8 **False.** A new Section 3.2 introduces new provisions for design documents issued by the owner's designated representative for design as contract documents. These new provisions differentiate between issuing design documents under the traditional design-bid-build delivery method and issuing drawings as the basis for a contract under an alternate project delivery method. Section 3.2 states that when structural design documents are issued as contract documents and do not include all the information required for a complete design as defined in Section 3.1, allowances for items not defined in partially complete design documents are to be provided in the contract with the fabricator.



STEEL SOLUTIONS CENTER

Everyone is welcome to submit questions and answers for the Steel Quiz. If you are interested in submitting one question or an entire quiz, contact AISC's Steel Solutions Center at 866.ASK.AISC or solutions@aisc.org.

IDEA StatiCa[®]



NEED
FOR
SPEED

Calculate yesterday's estimates

NO MORE STRUGGLES WITH STEEL CONNECTION DESIGN

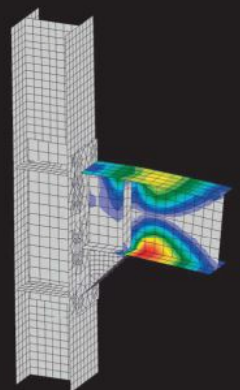
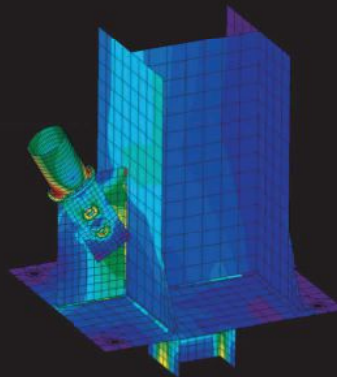
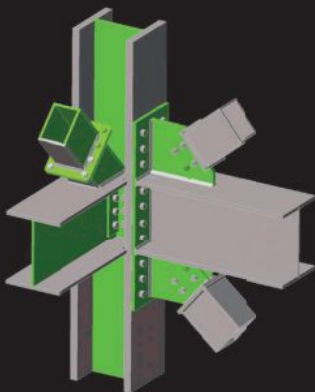
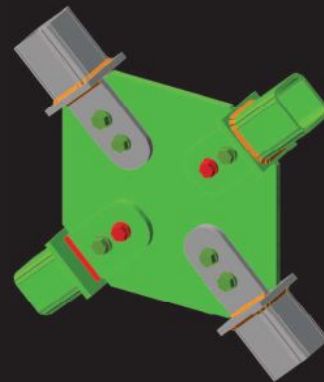
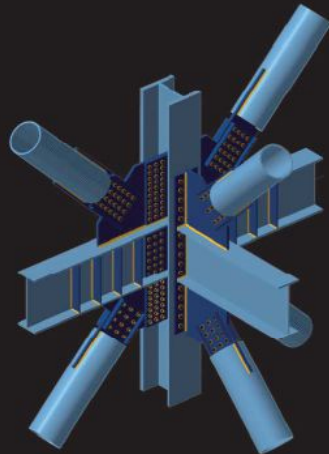

ANY GEOMETRY, ANY LOADING IN MINUTES

Request a TRIAL today on www.ideastatica.com

Seismic Harmonization

BY LARRY KRUTH, PE, AND MIKE GASE

Updates to Chapter J of the AISC *Seismic Provisions* and harmonization with the AISC *Specification* will result in simpler seismic design for steel structures.

THERE’S BEEN A SEISMIC SHIFT in one of AISC’s most widely used standards.

The soon-to-be-released 2022 edition of the AISC *Seismic Provisions for Structural Steel Buildings* (AISC 341) contains several revisions, including an important update to Chapter J: Quality Control and Quality Assurance that coordinates with the new 2022 AISC *Specification for Structural Steel Buildings* (ANSI/AISC 360). This revision is expected to make it easier for engineers to apply the *Seismic Provisions* in their projects, as the new Chapter J only includes any additional requirements to those in the *Specification*.

Quality assurance requirements were first introduced in the *Seismic Provisions* as Appendix Q in 2005 for seismic projects, if required by the applicable building code or the engineer of record (EOR), as a listing of items to assure quality. Beginning in 2010, Chapter J was added, which listed requirements for Quality Control and Quality Assurance for every seismic project. Simultaneously, Chapter N: Quality Control and Quality Assurance was added to the *Specification*, listing requirements for

structures not subject to seismic loading. Both Chapter J in the *Seismic Provisions* and Chapter N in the *Specification* were updated independently in 2016. When the 2022 update cycle of these two standards began, duplications and conflicts were discovered between these two chapters. Since the *Seismic Provisions* is to be applied as supplemental requirements to the *Specification* for seismic structures, Chapter J of the *Seismic Provisions* was updated to remove the duplication and provide only items explicitly required for seismic structures for quality control and quality assurance. While this article cannot cover all the changes, here are some significant ones:

1. Section J2: Fabricator and Erector Quality Program was added to refer back to Chapter N of the *Specification*.
2. Section J3: Fabricator and Erector Documents now only lists items required for seismic structures beyond those items listed in Chapter N of the *Specification*.
3. Section J6: Inspections Tasks no longer lists observe and perform since they are listed in the *Specification*, but

the term document was maintained for the items that need to be documented for seismic structures.

4. Section J7: Welding Inspection and Nondestructive Testing were intended to address the intermix of weld metals, unique inspection tasks, required documentation, and a new Table J6.1 for Visual Inspection Tasks After Welding. Tables that were duplicated from *Specification* Chapter N were deleted. Revisions related to ultrasonic testing (UT) effectiveness at the root(s) of partial-joint-penetration (PJP) groove welds are included, and a new provision permitting a combination of visual testing (VT) and magnetic particle testing (MT) as an alternative to UT is provided.

Section J7.2b: Partial Penetrant Groove (PJP) Weld (formerly J6.2b) was updated to reflect which PJP welds require NDT. Previously, this section stated that 100% of PJP column splice and column-to-base-plate welds require NDT. These two subjects were decoupled, and new

TABLE J7.1
Documentation of Visual Inspection After Welding

Documentation of Visual Inspection After Welding	QC		QA	
	Task	Doc.	Task	Doc.
Welds meet visual acceptance criteria <ul style="list-style-type: none"> • Crack prohibition • Weld/base-metal fusion • Crater cross section 				
<ul style="list-style-type: none"> • Weld profiles and size • Undercut • Porosity 	P	D	P	D
k-area ^a	P	D	P	D
Placement of reinforcing or contouring fillet welds (if required)	P	D	P	D
Backing removed, weld tabs removed and finished, and fillet welds added (if required)	P	D	P	D

^a When welding of doubler plates, continuity plates, or stiffeners has been performed in the k-area, visually inspect the web k-area for cracks within 3 in. (75 mm) of the weld. The visual inspection shall be performed no sooner than 48 hours following completion of the welding.

Note: Doc. = documentation

subsections were created. Section J7.2b now contains J7.2b (1) Column Splice Welds and J7.2b (2) Column to Base Plate Welds. Section J7.2b (1) now specifies which PJP welds require NDT with UT based on the design requirements of Sections D2.5b (NDT not required) and E3.6g (NDT is required). Section

J7.2b(2): Column to Base Plate Welds requires UT for all these connections.

A new Section J7.2b (3): Alternate Approach to UT was created to address the inconsistent evaluation of UT indications at the root(s) of these PJP groove welds. A testing program currently underway in which UT is performed on

PJP groove welds shows inconsistent evaluations of indications located at or near the root of these welds. The alternate approach involves visual inspection of the depth of the groove, magnetic particle testing (MT) of the root and second pass, and visual and MT of the final weld. The written procedure must be approved by the engineer.

- Section J8: Inspection of High Strength Bolting refers to *Specification* Chapter N Section N5.6. Specific requirements for Bolting Inspection Documentation were added for seismic structures.

This is just a brief summary of some of the significant changes in Chapter J of the new *Seismic Provisions*. The harmonization between the two publications should make Chapter J more usable for seismic design. ■

Other Inspection Tasks	QC		QA	
	Task	Doc.	Task	Doc.
RBS requirements, if applicable <ul style="list-style-type: none"> Contour and finish Dimensional tolerances 	P	D	P	D
Protected zone—no holes or unapproved attachments made by fabricator or erector, as applicable	P	D	P	D

Note: Doc. = documentation

Inspection of Composite Structures Prior to Concrete Placement	QC		QA	
	Task	Doc.	Task	Doc.
Material identification of reinforcing steel (Type/Grade)	O	—	O	—
If welded, determination of carbon equivalent for reinforcing steel other than ASTM A706/A706M	O	—	O	—
Proper reinforcing steel size, spacing, and orientation	O	—	O	—
Reinforcing steel has not been rebent in the field	O	—	O	—
Reinforcing steel has been tied and supported as required	O	—	O	—
Required reinforcing steel clearances have been provided	O	—	O	—
Composite member has required size	O	—	O	—

Note: Doc. = documentation
— = indicates no documentation is required

Inspection of Composite Structures during Concrete Placement	QC		QA	
	Task	Doc.	Task	Doc.
Concrete: Material identification (mix design, compressive strength, maximum large aggregate size, maximum slump)	O	D	O	D
Limits on water added at the truck or pump	O	D	O	D
Proper placement techniques to limit segregation	O	—	O	—

Note: Doc. = documentation
— = indicates no documentation is required



Larry Kruth
(larry@kruthengineering.com) recently retired as AISC's vice president of engineering. **Mike Gase** (mgase@midweststeel.com) is corporate quality director with Midwest Steel.

Turning up the Heat

BY KRISTI SATTLER, SE, PE, PHD, AMIT H. VARMA, PHD, AND FARID ALFAWAKHIRI, PENG, PHD

An updated and expanded Appendix 4 in the new *AISC Specification* provides more consolidated and comprehensive guidance on fire design.

ARE YOU READY FOR A BIGGER, better Appendix 4?

Making its first appearance in the 2005 version of the *AISC Specification for Structural Steel Buildings* (ANSI/AISC 360), Appendix 4: Structural Design for Fire Conditions provides criteria for designing and evaluating steel-framed buildings for fire conditions—and the new 2022 version is more than triple the length of the 2016 version as it consolidates everything that is needed for steel and fire into one location for designers.

The new version also includes updated language to provide additional guidance and clarification for existing design methods and new provisions based on recent research (including SpeedCore).

Roadmap of Appendix 4

Appendix 4 provides guidance for determining the heat input, thermal expansion, and degradation in mechanical properties at elevated temperatures that eventually lead to the progressive decrease in strength and stiffness of structural components. When it comes to designing structures for fire, compliance with performance objectives can be demonstrated either by component qualification testing (also known as the prescriptive method) or by structural analysis.

When using qualification testing, the fire-resistance ratings of building elements are determined from directories or reports published by agencies that test individual components or systems subjected to standard testing procedures outlined in ASTM E119 or UL 263. Alternatively, calculation procedures based on standard test results may be used to determine the fire-resistance rating. Previously, designers had to look elsewhere to find the prescriptive design equations and related information for structural steel. These equations could be found in ASCE 29-05: *Standard Calculation*

Methods for Structural Fire Protection or in Chapter 7 of the *International Building Code (IBC)*. The 2022 version of the *Specification* Appendix 4 consolidates all of that information into one location. The prescriptive approach is widely used in the U.S. building industry due to its simplicity and successful performance history. However, it can sometimes be overly conservative because the standard fire performance of fire-tested assemblies does not necessarily translate into real building behavior. The rigidity of the prescriptive approach can also limit the design options and innovations available to the engineer and architect.

Analysis methods, on the other hand, document the anticipated performance of the steel framing when subjected to design-basis fire scenarios. Those scenarios describe the heating and cooling conditions for the structure, and they account for the fuel load, ventilation conditions, and geometry of the actual space. Appendix 4 outlines an advanced method of analysis for the design of all steel building structures for fire conditions. This method provides a thermal and structural performance-based approach that empowers the engineer and architect to consider various design options, innovations, and optimization, while focusing on understanding building behavior, including the occurrence of various limit states and the extent of damage for various fire hazards. However, the advanced method can be quite complex to implement and requires analysis tools and resources that are beyond the typical means and methods available to the design team. It may also require a comprehensive independent review by a team of peers with specific expertise.

A simpler method (appropriately named “design by simple methods of analysis”) is permitted for the evaluation of structural components and frames. This approach makes some simplifying assumptions and

requires some engineering judgment to determine the applicability of the approach. Appendix 4 provides equations for determining the design strength at elevated temperatures for steel and composite members.

Material Strengths at Elevated Temperatures

During a fire, elevated temperatures cause a reduction in the strength and stiffness of structural components. Structural behavior under severe fire conditions is highly nonlinear, primarily due to the material behavior and the large deformations that may develop.

Appendix 4 does not restrict which material models can be used in an analysis. It permits the use of any rational method based on test data that establishes material properties at elevated temperatures. The material properties should account for thermal expansion, nonlinearities in stress versus strain response, and time-dependent creep effects, and these effects are highly variable. To make things even more challenging, there are no universally accepted test methods to consistently establish all the required properties.

In lieu of test data, Appendix 4 allows the use of the properties for steel and concrete adopted from *Eurocode 3* and *Eurocode 4* (the European counterpart to the *Specification* on steel design and composite design, respectively). These equations reflect the consensus of the international fire engineering and research community.

Previous versions of Appendix 4 already provided retention factors for calculating the mechanical properties as a function of temperature, such as yield strength, $F_y(T)$, and modulus of elasticity, $E(T)$. Retention factors represent the ratio of a material property at a given temperature to its value at room temperature (or ambient conditions). For example, at 1,000 °F, the yield strength of steel is about 66% of its value at

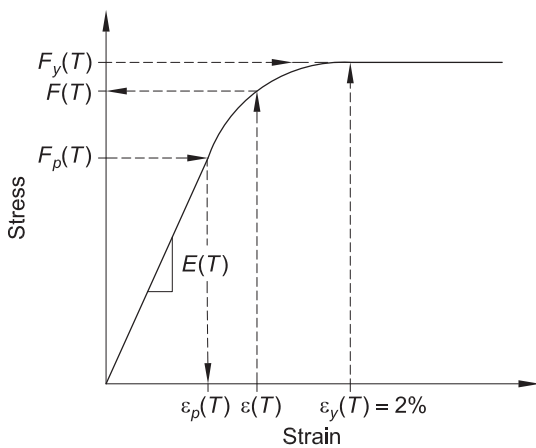

Fig. 1. Parameters of idealized stress-strain curve at elevated temperatures. (This is Figure C-A-4.1 in the *Specification Commentary*.)

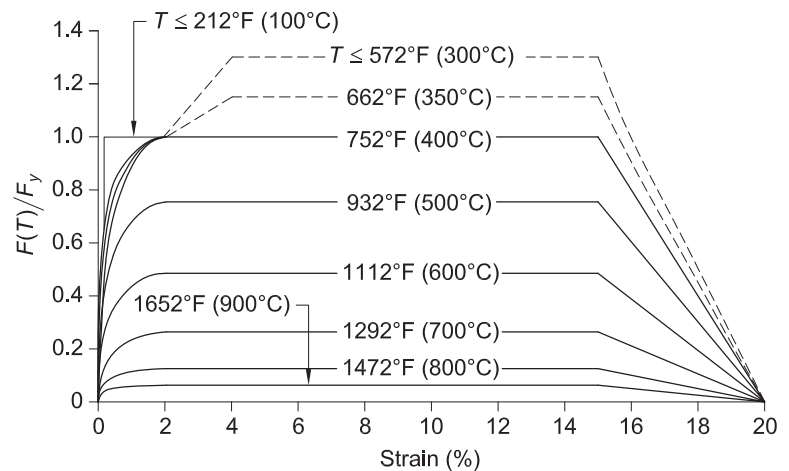

Fig. 2. Stress-strain relationships of structural steel at elevated temperatures, with strain hardening included for temperatures below 750 °F (dashed lines). (This is Figure C-A-4.2 in the *Specification Commentary*.)

room temperature, resulting in a retention factor, k_y , of 0.66.

What was previously missing from Appendix 4 was the stress-strain relationships at elevated temperatures. Prior to the 2022 *Specification*, designers were left to obtain those relationships on their own from some other sources (like *Eurocode*). Recognizing that some designers may not be familiar with or have access to the material property models in *Eurocode*, Appendix 4 adopts those models and provides them in Section 4.2.3.

At elevated temperatures, the stress-strain response is more nonlinear than at room temperature and experiences less strain hardening. The deviation from linear behavior is represented by the proportional limit, $F_p(T)$, and the yield strength, $F_y(T)$, is defined at a 2% strain, as shown in Figure 1. Note that at ambient temperature, the yield strength, F_y , is defined at 0.2% offset strain, while at elevated temperature, the yield strength, $F_y(T)$, is defined at the much larger strain of 2%, and it is also equal to the ultimate strength, $F_u(T)$, for temperatures greater than 750 °F.

The equations adopted from *Eurocode* are not intended to limit or restrict the user from using another acceptable material model but rather are merely provided as a straightforward option. Also, for cases where it is appropriate to include strain hardening for steel, additional equations are provided in the *Commentary* for

temperatures below 750 °F. Figure 2 illustrates the stress-strain-temperature relationship.

Simple Methods of Analysis

Section 4.2.4d outlines the simple method of analysis, which is a member-based approach that allows for a comparison of design strength and resistance of individual members using the load and resistance factor design (LRFD) method. It allows the designer to employ reasonable and conservative simplifying assumptions in order to assess member adequacy without the detailed modeling necessary for the advanced method, thus making it less computationally and labor-intensive. The simple method approach captures common limit states but does not currently include all potential limit states. It also does not consider the member's behavior over time or evaluate the performance of the structure overall.

The first quarter 2022 AISC *Engineering Journal* article, “Comparison of Simple and Advanced Methods of Analysis in the AISC Specification for Fire-Resistant Structural Design,” discusses the case study of a ten-story building for a design fire using the simple and advanced methods of analysis. The prescriptive method was first used to design the case study building, and then the adequacy of the design was evaluated and compared with the results of the simple and advanced methods. The paper

provides practical recommendations for the implementation of the simple method of analysis using typical means and methods available to the design team and contrasts the results of each analysis method.

For the simplified analysis method, the article's authors considered two different approaches. The first approach evaluates individual members in isolation, which assumes that the load effects (required strengths) are the same as ambient conditions. This simplifying assumption can typically be applied to regular gravity frames, and it should be used with caution and only with proper engineering judgment. The second approach evaluates frame behavior while accounting for stiffness reductions, thermal deformations, and appropriate boundary conditions. The frame-level approach may be appropriate for irregular frames with discontinuities. The 2022 *Specification* includes several revisions in Section 4.2.4d based on this work to clarify the use and applicability of these simple methods of analysis.

Critical Temperature Methods

Section 4.2.4e introduces a new design method called the critical temperature method, which is an alternative to design by simple methods of analysis. It allows for the analysis of a structural steel member in the temperature domain directly without explicitly determining the capacity of a heated member. The background study is

$$T_{cr} = 816 - 306 \ln\left(\frac{R_u}{R_n}\right) \text{ in } ^\circ\text{F}$$

(A-4-21) for tension

$$T_{cr} = 1580 - 0.814\left(\frac{L_c}{r}\right) - 1300\left(\frac{P_u}{P_n}\right) \text{ in } ^\circ\text{F}$$

(A-4-22) for compression

$$T_{cr} = 816 - 306 \ln\left(\frac{M_u}{M_n}\right) \text{ in } ^\circ\text{F}$$

(A-4-23) for beams

.....

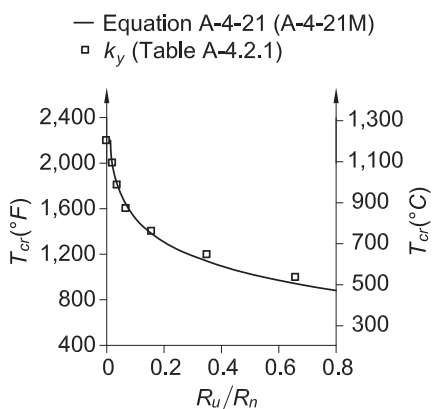

(a)

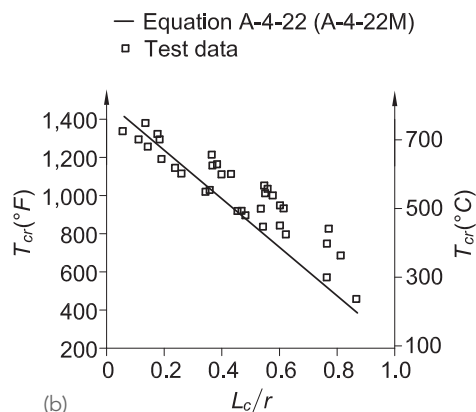

(b)

Fig. 3. Critical temperatures for steel members in (a) yielding and (b) flexural buckling. (These are Figures C-A-4.8 (a) and (b) in the Specification Commentary.)

provided in the first quarter 2021 *Engineering Journal* article “Critical Temperature of Axially Loaded Steel Members with Wide-Flange Shapes Exposed to Fire.”

The critical temperature of a structural member is “the temperature at which the demand on the member exceeds its capacity under fire conditions.” In other words, the temperature of a loaded structural steel member exposed to the design-basis fire should not exceed this critical temperature. Section 4.2.4e provides equations to calculate critical temperatures for (i) tension members, (ii) continuously braced beams not supporting concrete slabs, or (iii) compression members that are assumed to be simply supported. The method only considers uniform heating of individual wide-flange rolled shapes that have non-slender elements, and local buckling effects at elevated temperatures are thus precluded. The equations appear to the left.

For yielding of tension members or continuously braced beams, the critical temperature is calculated using an equation that is a function of the load utilization ratio (either R_u/R_n or M_u/M_n). The equation closely approximates the retention factors for yield stress (k_y), as shown in Figure 3(a).

For flexural buckling of compression members, the critical temperature is calculated using an equation that is a function of member slenderness, L_c/r , and load ratio, P_u/P_n . For load ratios, P_u/P_n , less than 0.6, the equation correlates closely with critical temperatures back-calculated using the design for compression equation in the simple methods of analysis. As shown in Figure 3(b), the critical temperature equation provides a conservative lower bound (16% lower on average) relative to the column test data at load ratios greater than 0.3.

Qualification Testing

Section 4.3: Design by Qualification Testing has been substantially expanded to incorporate descriptions and formulas for structural steel assemblies. It consolidates content from ASCE 29-05: *Standard Calculation Methods for Structural Fire Protection*

and the 2018 *IBC* such that a designer can find all of the prescriptive information for fire and structural steel in one place.

A table of generic steel assemblies and respective fire-resistance ratings was adopted from the 2018 *IBC* and includes steel columns, primary trusses, girders, and beams protected with gypsum board, plaster, concrete, or masonry (constructed as specified) to achieve ratings of up to four hours. The Commentary includes a list of the original sources for these ratings.

Section 4.3 also includes several subsections that specify calculation methods to determine the fire-resistance ratings of steel assemblies. Such calculation methods depend on the type and thickness of protection, and they often involve the thermal inertia properties of the steel sections involved, expressed through the conventional W/D ratios for wide-flange shapes and A/P ratios for hollow structural sections (HSS), where W is the weight, A is the area of the steel section, and D or P is the inner perimeter of protection. These subsections include calculation methods for computing the fire resistance of things like composite steel-concrete columns, composite columns encased in concrete, concrete-encased steel beams and girders, and steel trusses.

Another subsection includes a very useful calculation method for determining the fire-resistance rating of composite and non-composite steel I-shaped beams and girders that differ in size from that specified in approved fire-resistance-rated assemblies. This equation has been widely used since the 1980s, and it was adopted from *IBC*. The Commentary includes the background research for several of these equations.

Section 4.3 also includes a new calculation method for computing the fire resistance of composite concrete slabs on trapezoidal steel deck. The method is based on the study carried out by a team of researchers at the National Institute for Standards and Technology (NIST), summarized in the 2019 *Fire Safety Journal* article “Improved Calculation Method for Insulation-Based Fire Resistance of Composite Slabs.”

SpeedCore and Other Composite Members

The 2022 version of Appendix 4 includes new provisions for concrete-filled composite plate shear walls, also referred to as SpeedCore (aisc.org/speedcore). These composite walls consist of steel modules that are prefabricated in the shop, shipped to and assembled in the field, and then filled with plain concrete. The steel modules consist of two exterior steel faceplates that are connected to each other using tie bars and/or stud anchors that become embedded in the concrete after casting.

The steel faceplates are directly exposed to elevated temperatures during fire loading, which raises concerns regarding their fire resistance. A 2020 Charles Pankow Foundation Report, *Structural Fire Engineering and Design of Filled Composite Plate Shear Walls (SpeedCore)*, conducted a comprehensive research project to evaluate the fire resistance and structural performance of SpeedCore walls subjected to standard fire loading. This research included compiling experimental results from the literature, conducting additional experimental investigations, developing and benchmarking numerical models for estimating the thermal and structural performance of composite walls, and conducting parametric studies to expand the overall database.

The considered parameters included the wall thickness, story height-to-length (slenderness) ratio, axial load ratio, steel plate slenderness ratio, steel and concrete material properties, and fire exposure condition. The results from the parametric studies were used to develop equations for calculating the axial strength of SpeedCore walls subjected to elevated temperatures from fire loading (Appendix 4, Equation A-4-12).

$$P_n(T) = \left\{ 0.32 \left[\frac{P_{no}(T)}{P_c(T)} \right]^{0.3} \right\} P_{no}(T) \quad (\text{A-4-12})$$

Similar equations (see below) for calculating the axial strength of concrete-filled

composite columns subjected to elevated temperatures from fire loading are also included in Appendix 4 (Equation A-4-11). Details are available in the conference proceedings for the Structural Stability Research Council's 2020 Annual Stability Conference presentation "Stability of SpeedCore Walls under Fire Loading: Summary of Numerical Analyses."

$$P_n(T) = \left\{ 0.54 \left[\frac{P_{no}(T)}{P_c(T)} \right]^{0.3} \right\} P_{no}(T) \quad (\text{A-4-11})$$

Additionally, the results from the parametric studies were used to estimate the fire-resistance rating, R , in hours for unprotected composite plate shear walls. Appendix 4 provides this equation (Equation A-4-34) that includes the effects of applied axial loading, wall thickness, and the wall story height-to-length (slenderness) ratio, which were identified as critical parameters. The Commentary includes a precaution that composite walls with a story height-to-length ratio greater than or equal to 20 and subjected to fire exposure on only one face may need additional fire protection on the fire-exposed surface. Typical wall story height-to-length ratios are less than 10; therefore, this is not usually a concern.

It's also worth noting that concrete-filled composite members will experience pressure build-up due to steam emanating from the concrete at elevated temperatures. This steam gets trapped and builds up pressure on the steel modules or shells from the inside. This pressure can be released by adequately sized and regularly spaced vent holes. Any rational method can be used to design the size and spacing of vent holes, and the above-mentioned 2020 Charles Pankow Foundation Report includes an example. In most SpeedCore walls, vent holes that are 1 in. in diameter and spaced at 12 ft in both directions will be adequate. Appendix 4 also includes recommendations for vent holes in concrete-filled composite columns.

Looking Forward

The upcoming 2022 *Specification* will serve as a one-stop shop for those who are designing structural steel components, systems, and frames for fire conditions. Appendix 4 contains the full spectrum of what is needed for the design—whether that's using the prescriptive method for determining the fire-resistance rating of a member, the simple method of analysis for the evaluation of frame behavior, or the advanced method of analysis for a unique and complex structure. ■

All mentioned Engineering Journal articles can be found at aisc.org/ej, and you can access the Specification at aisc.org/specifications.



Kristi Sattler (sattler@aisc.org) is AISC's manager of university education, **Amit H. Varma** is the Karl H. Kettelhut Professor of Civil Engineering at Purdue University, and **Farid Alfawakhiri** (retired) is formerly with the American Iron and Steel Institute.

Get Smart (with Data)

BY BRIAN RAFF

AISC's construction industry database can help you leverage market intelligence to make smart business decisions.

WHAT ARE THE HOT MARKET SEGMENTS? Are construction costs going up or down? What about construction volume?

Whether you're an AISC full member or a part of the larger AEC community, AISC's market development department has a plethora of information available to help you analyze the marketplace (see the below

graphs for examples). While AISC fabricators can access the information directly, AISC's structural steel specialists also can provide free, customized data briefings for AEC companies on an individual firm basis. Simply contact your local specialist (they're listed at aisc.org/steelspecialists) for a free one-on-one data briefing, including an in-depth analysis of the construction economy

in your specific region or market, building trends in the specific project sectors you work in, and a curated forecast of what lies ahead. AISC has conducted dozens of these briefings to architects and engineers in 2022, and we're looking forward to delivering even more in 2023!

If you want to get a taste of what AISC offers, start with aisc.org/economics.

Construction Cost Indexes

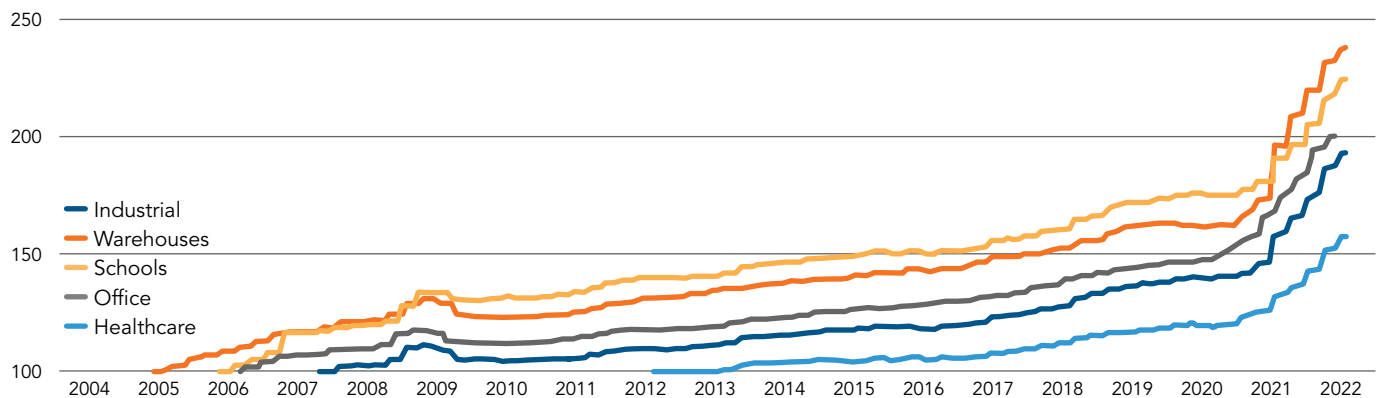

Nonresidential Building Spending (Adjusted for Inflation) and GDP

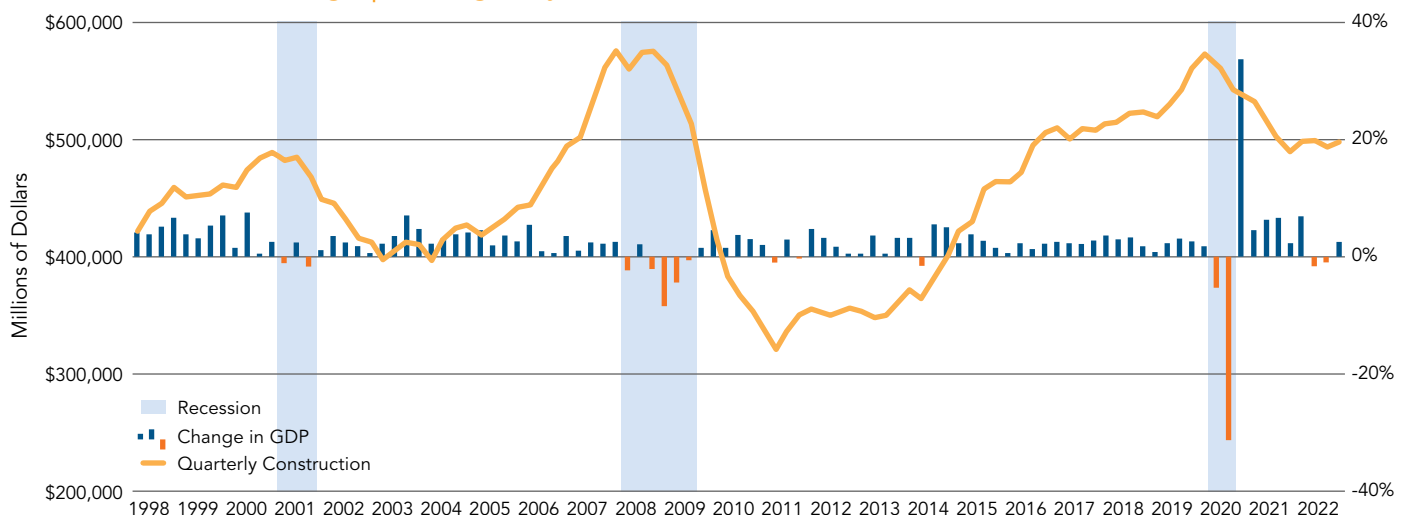

data driven

You'll get free access to industry data, including U.S. wide-flange consumption, typical mill pricing, construction material price comparisons, and more.

Full members can access even more data at aisc.org/industrystatistics (you need to be logged in), where you'll find interactive tools to dig into statewide or national market data. In addition to customizable charting tools, you'll find:

- **AISC One Page.** A quarterly look at leading economic indicators, including the Architectural Billings Index, impacts of GDP on construction spending, and industrial and nonresidential building forecasts.
- **AISC Business Barometer.** A quarterly national business conditions survey issued to AISC member fabricators that looks at regional conditions, business conditions by construction type, on-hold projects, bidding activity, backlogs, capacity, and more.
- **National and State Market Statistics.** Market statistics for different construction materials by year, project type distribution, and story/height distribution, as well as nonresidential construction square footage put in place.

Another tool is our annual economic forecast, presented at NASCC: The Steel Conference. This year's conference is scheduled for April 12–14 in Charlotte. Registration is now open. For more information, visit aisc.org/nascc. ■



Brian Raff (raff@aisc.org) is AISC's vice president of market development, marketing communications, and government relations.

See that the bolts are tight!™
DuraSquirt® DTIs

The Best Way to Bolt!™



1 800 552 1999

appliedbolting.com

Designed, Engineered & Made In USA Since 1994

DID YOU KNOW...?

WE CAN SHIP YOUR ROOF FRAMES THE NEXT DAY?



QUICKFRAMES®

Roof Frame Manufacturing,
Detailing, Engineering & Delivery

GET PRICING & FAST QUOTES
+1(480) 656-1575
www.quickframes.com



Steel Saga

INTERVIEW BY GEOFF WEISENBERGER

Larry Kruth has dedicated the majority of his life to the structural steel industry as a practicing engineer, a fabricator, a safety expert, an instructor, a committee volunteer, and an AISC vice president. And even though he recently retired (for the second time), his work with the industry will continue.



IN ONE EXAMPLE in a never-ending list of examples of how curiosity usually pays off, Larry Kruth's path to becoming the partial owner of a prominent Midwestern steel fabrication company—and eventually AISC's vice president of engineering—started with a simple question to and answer from his father.

Larry retired from the former role in 2015 and the latter one at the end of last year. He also just became an Honorary Member of AISC, only the 13th in the Institute's century of existence. In a recent conversation, we discussed his appreciation for Pittsburgh, his 30-plus years working for Douglas Steel Fabricating, one of the most interesting projects he ever worked on, how he became a go-to resource for safety issues, and much more.

Where are you from originally?

I generally tell people that I grew up in Pittsburgh, but in reality, I grew up in a borough that was actually right next to Pittsburgh called Sharpsburg. And one thing that's significant about Sharpsburg is that it's the birthplace of the H.J. Heinz Company.

That's a good bit of history. We can circle back to Pittsburgh in a bit, but let's dive into your career first. What got you into the world of buildings in the first place? Were there any buildings in particular that inspired you when you were younger?

When I was in the fourth grade, they were building a new elementary school in town. My father and I were sitting in a parking lot across the street from where they were building it. And I remember turning to my father and asking him, "How do they know what size beams to use in that building?" And he said, "That's what engineers know how to do." And I thought, "Wow, I want to know how to do that."

Also, growing up in Pittsburgh, there were obviously a lot of great steel buildings, and I remember vividly in the late 1960s when the U.S. Steel Tower was built. I remember watching that one go up and thinking what an amazing building that was at that time.



Field Notes is *Modern Steel Construction's* **podcast series**, where we interview people from all corners of the structural steel industry with interesting stories to tell. Listen in at modernsteel.com/podcasts.

And being in Pittsburgh, you had all of those amazing bridges to look at as well.

Yes, and actually, Pittsburgh has more bridges than any other city in the world, which is amazing as well.

That is amazing. My first time in Pittsburgh was when we held NASCC: The Steel Conference there a few years ago, and I recall you mentioning the drive downtown from the airport and what a spectacular approach it is.

Yes, as you're coming into town from the airport, you go through the Fort Pitt Tunnel, and as you come out of that tunnel, the city just opens up in front of you. It's almost like an entrance to the city. And at night, it's a phenomenal view.

Yes, I arrived during the day, and I wished I had come in at night. I'll have to do that at some point. Anyway, back to the buildings world, you were with Douglas Steel Fabricating in Lansing, Mich., for quite a while. Can you tell me about your path to getting there?

Sure, after I graduated from the University of Pittsburgh at Johnstown, I went to work in Pennsylvania for a very small consulting engineering firm. There were only ten people in the firm and only one other engineer other than me. And I sort of got a baptism by fire because after I was there for about six months, the other engineer had a heart attack. So immediately, everybody in the company turned to me and told me I could take over his workload. I basically took over his work, learned a lot, and stayed there until I got my engineering license, then went to work for another consulting engineering firm in Pittsburgh. I was there for a couple of years, and then they moved me to a nuclear power plant in Cincinnati for a couple of years. I was there for nine months, and the company got thrown off the job, so I had no job. Luckily, I ended up finding an ad in the Pittsburgh newspaper for a structural steel fabricator in Michigan that was looking for a structural engineer, and I went to work for them. It did not work out. I was there for nine months, then got a job at Douglas Steel. I started as a project manager, rose through the ranks, and ended up retiring in 2015 as a part owner of the company after 31 years there.

That's quite the journey. So you started in the consulting world before getting



Larry (in gold) and fellow Starship Enterprise crew, er, AISC staff members at an AISC Halloween gathering.

into the fabrication side of things. Did you learn anything early on in the fabrication shop that surprised you?

I don't know about being surprised, but I definitely got a good education there. I got to learn how things actually went together and how things worked and got a good understanding of the effort that goes into fabricating steel, the problems that you may encounter on a project, and making sure the design documents end up as something that's buildable. I learned that no matter how tough the job is, you want the end result to be the owner walking away smiling. You can beat your head up against the wall and have all kinds of problems all the way through the job, but if the owner's happy in the end, you've done good work.

That's a great way of thinking about it. I've always known you as a safety expert, and over the years, you've kept Modern Steel out of trouble by reviewing construction and fabrication photos for safety violations. How did you develop that focus on construction and fabrication safety?

At one point, when I was in charge of the engineering department at Douglas Steel, the engineer in charge of safety and field measurements retired. And I was asked if I could take over those duties. And I figured I had to learn it, so my first job was to sit down and read all of the Michigan OSHA standards to make sure I understood what they were saying. And after that, I took some time to look at what we were doing in the shop and the field, finding potential problems, working with people to solve them, putting together safety manuals for both shop and field, and spending time educating our employees. And as that happened, I also became active on a lot of industry advisory committees for Michigan OSHA, helping them to develop their regulations and refine them so that they reflected what really needed to be done in the industry. And I became the person that could walk into a fabrication shop, walk into pretty much any

industrial facility, and be able to zero in on safety violations right away. And we made it a point to be an extremely safe company.

That's great. On that note, you retired from Douglas in 2015 and came to AISC as our vice president of engineering the following year. And now you're retiring from AISC. Do you have any big plans? Any hobbies you're planning to take up or get back to?

When I retired for the first time in 2015, I established a consulting firm, and I was also teaching at Michigan State University while doing a little bit of consulting. And I think what I'm probably going to do is reactivate that firm and see if I can do any consulting work to help any people out. Hopefully, I'm more prepared for retirement this time than I was the first time! I've also reactivated my membership with all the AISC committees I volunteered for before working here, plus a few other ones. Other than that, I have plans to take another trip to Hawaii in February so I can take some time to just relax. ■

This column was excerpted from my conversation with Larry. To hear more from him, including his first attempt at retirement, one of his favorite projects from his fabrication engineering days, why he loves the original Star Trek series, more thoughts on Pittsburgh, and why 13 is his lucky number, check out the December Field Notes podcast at modernsteel.com/podcasts.



Geoff Weisenberger (weisenberger@aisc.org) is chief editor of Modern Steel Construction.

Mindful Selling

BY DOUG JONES AND MICHAEL SENNEWAY

Successfully selling in today’s construction world is about much more than the bottom line.

SELLING FABRICATION AND ERECTION SERVICES has always been challenging, and it’s become even more so in today’s construction world.

The good news is there are better ways to succeed beyond the “old school” reliance on specification, availability, and price. After all, only one company can be the absolute lowest-cost producer, and a basic challenge fabricators and erectors face is how not to be viewed as a commodity.

The Institute for Supply Management recently released a course entitled “Supplier Relationship Management: Achieving Top and Bottom Line Results,” which emphasizes that purchasing should become more strategic so as to integrate the improvement of overall efficiency, performance, accountability, compliance, and value as essential competencies for a company to be successful.

Following that organization’s lead, fabricators and erectors would be better served to adopt a new paradigm based on value and relationships to succeed in today’s dynamic and challenging world. Value is “worth minus cost,” and relationships are the result of “meaningful conversations.” Without value and relationship differentiators, buyers often have no choice but to default to price.

Compelling bids require exercising due diligence to discover probable customer value and then conveying that value proposition to the customer through the following three elements:

- identifying a customer issue,
- presenting a proposed corresponding action
- highlighting the resulting beneficial customer impact

Engaging with buying committees to clarify your value proposition is also a very meaningful next step in the conversation.

And then there’s risk. Risks, such as the major industry disruptors listed below, are

real and should be embraced as challenges to overcome rather than problems to be feared and avoided:

- safety
- cost overruns
- supply chain uncertainties
- labor shortages
- inaccurate estimates
- equipment failure
- shifting partnerships and alliances

Honest discussion about risk mitigation (prevention, resolution, and simplification) builds trust and credibility. The type of opportunities you should look for are ones where the customer welcomes open dialogue and joint problem-solving. Stronger relationships enable a deeper conversation about other mutual interests.

Commensurately, reliance on a solo “sales star” is becoming less common. With today’s increasing market complexities, successful selling is now founded on a company-wide commitment to a shared “sales culture.”

Help your sales team evolve and thrive with a “go to market” initiative that includes the following:

Embrace the situation. Successful organizations are characterized by the below “cause-and-effect” model:

$$\begin{aligned}
 &\text{Quality Leaders +} \\
 &\text{Competent Staff +} \\
 &\text{Performance Culture} \\
 &= \\
 &\text{Improved Results +} \\
 &\text{Successful Customers +} \\
 &\text{Engaged Employees}
 \end{aligned}$$

Today’s construction market exemplifies the “fog of war” characterized by volatility, uncertainty, complexity, and ambiguity (VUCA). VUCA is why the cause-and-effect model is so difficult to attain and sustain. Therefore, the sales

manager needs to lead with strategy-driven activities to anticipate and minimize VUCA disruptions to realize success for his customer and your company.

Realize your power to succeed. How? Consider these steps:

1. Identify and share the “sales wisdom” of your best sales producers to enable the entire team to improve.

2. Document the process. Revenue is primarily generated by marketing, sales, and service functions. Document the workflow of these three areas throughout the flow of a “typical” sales interaction. After documenting your current workflow, answer these basic questions to reveal key insights:

- What are the constraints?
- What should we automate, delegate, eliminate, or outsource?
- Who’s the expert in each area, and what can be learned from them to help everyone “get it?”
- What skills do we need to develop?
- How else can we improve performance, productivity, and profitability by coordinating our marketing, sales, and service efforts?

Put your best facilitator in charge of this exchange for the best results. Be patient, strive for progress, document details, prioritize, make the business case for change, and implement the plan.

3. Consider the customer’s buying experience. Map the customer’s buying journey. While each buying journey shares similarities, there can be significant differences. When these occur, create a new diagram to recognize the differences between different customer types.

4. Compare your “go to market” workflow with customer buying journey maps. The opportunities to alter and adjust your workflows should become obvious. By changing your thinking, you can change your behavior to change the results.



Take action. In each aspect of your sales methodology, answer these four questions:

1. Where are you now?
2. Where do you need to be?
3. How will you get there?
4. How will you sustain progress?

If the above discussion reflects what you're already doing, congratulations! If you've found new insights, even better!

And to learn more, come to NASCC: The Steel Conference, where our session will transform these "what to dos" into "how to dos," with emphasis on three key areas:

- identifying and soliciting higher return project opportunities
- winning the customer and then the project
- establishing enduring, trusting, and collaborative relationships

And remember: The company that reliably and consistently provides the greatest value for the customer wins! ■

This article serves as a preview of the 2023 NASCC: The Steel Conference session "How

to Successfully Sell in Today's Construction World." To learn more about this session and others, as well as to register for the conference, visit aisc.org/nascc. The conference takes place April 12–14 in Charlotte, N.C.



Mike Senneway (mikes.mjsmanagement@gmail.com) is the president and owner of MJS Management Associates, LLC, and **Doug Jones** (doug@powerbd.com) is the founding partner of Power Business Development.

The team for a new world-class indoor sports facility in Spokane, Wash., updated its original framing system design to be a winning fit for the venue.

On the Right Track

BY ROB GRAPER, SE, PE



THE SMALL CITY of Spokane, Wash., also known as Lilac City, had big goals of bringing a marquee indoor stadium to its downtown core that would attract regional, national, and international sporting events.

And much like the athletes that compete within its walls, the design made necessary adjustments—in the form of rethinking the original framing design—to optimize the project for success.

The new facility, known as The Podium, is a 135,000-sq.-ft



The 135,000-sq.-ft steel-framed Podium in Spokane features a 200-m hydraulic banked track—the first in the U.S. west of the Mississippi River—that easily converts to a multi-sport floor.

.....

the Lilac Grand Prix track event on February 11, 2022, in which a world record was set in the distance medley relay, the USATF Indoor Track and Field Championships (Elite) two weeks later, and more recently the USA Karate Championships.

When not used for championship events, The Podium provides needed space for local sports programming—particularly youth sports—as well as a wide range of non-sports-related community events, concerts, and gatherings. The venue is located directly adjacent to the city’s Riverfront Park along the Spokane River and within walking distance of downtown hotels, restaurants, and shopping.

The facility features a field house, which houses the 75,000-sq.-ft competition floor and spectator seating, and an attached three-level structure, referred to as the “Spine,” with each level serving distinct event functions. The lower level is directly adjacent to the field house floor and primarily serves the athletes with a warm-up track, a meet management and hospitality room, a medical training room, and other event support spaces. The main level, the primary entrance level that serves the general public, includes a long open concourse, which provides access to the bleachers, concessions, restrooms, and a multipurpose room. This level also includes a large covered outdoor deck offering fantastic views of downtown Spokane and Riverfront Park. The upper level includes a press box, a timing suite, a multi-purpose/VIP viewing area, and a large mechanical room.

The Podium’s owner, Spokane Public Facilities District, chose to employ a progressive design-build delivery method. In a progressive design-build project, there are no change orders. The contractor provides a guaranteed maximum price (GMP) for an agreed-upon scope of work. If economies are realized during design and/or construction, savings are offered back to the owner, who can pocket the savings or add scope to the project. Spokane Public Facilities



Lara Swimmer

steel-framed sports facility that features a 200-m hydraulic banked track—the first in the U.S. west of the Mississippi River—that easily converts to a multi-sport floor, surrounded by seating for more than 4,200 spectators. The venue opened in late 2021 and hosted

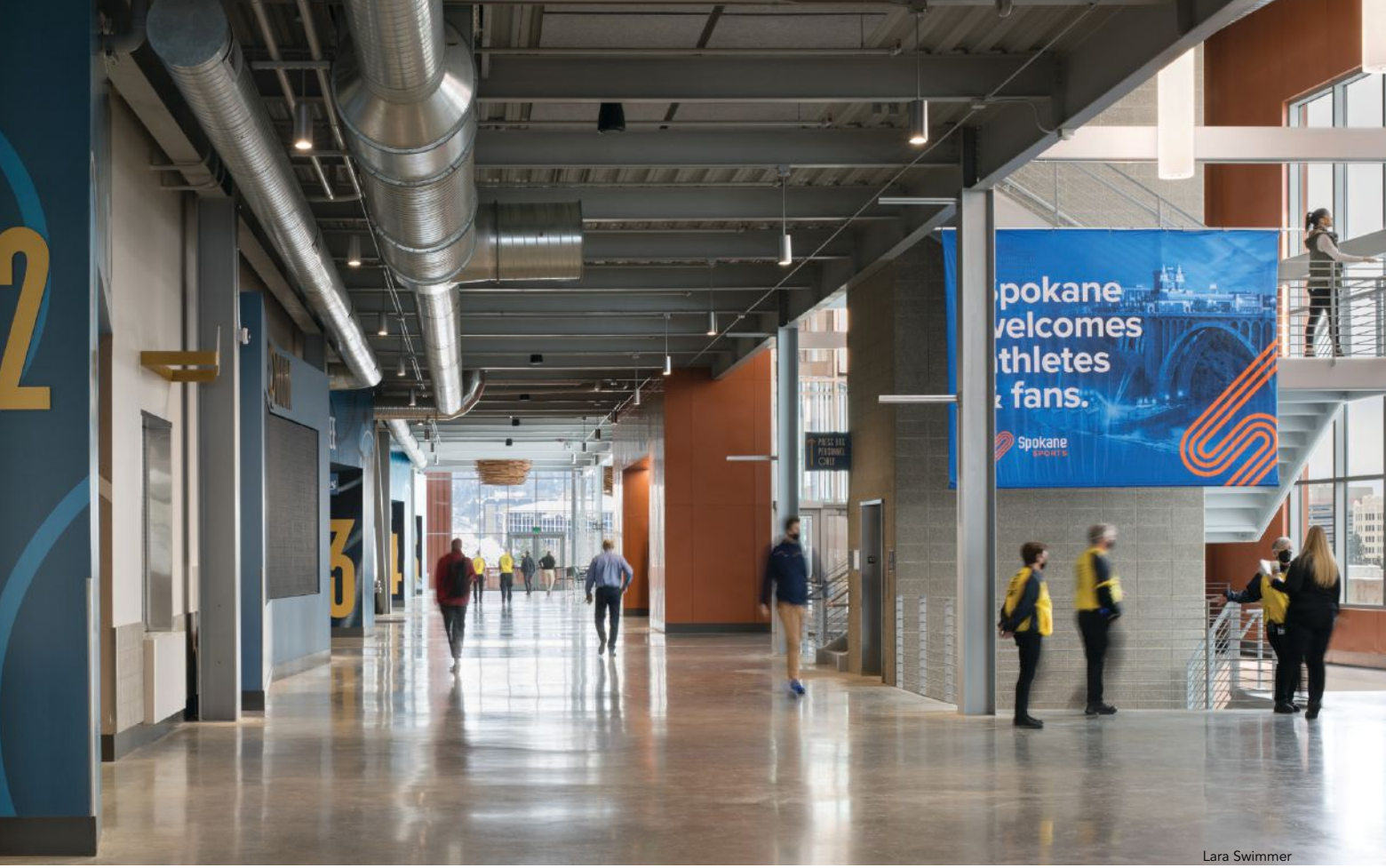

Lara Swimmer



Lara Swimmer

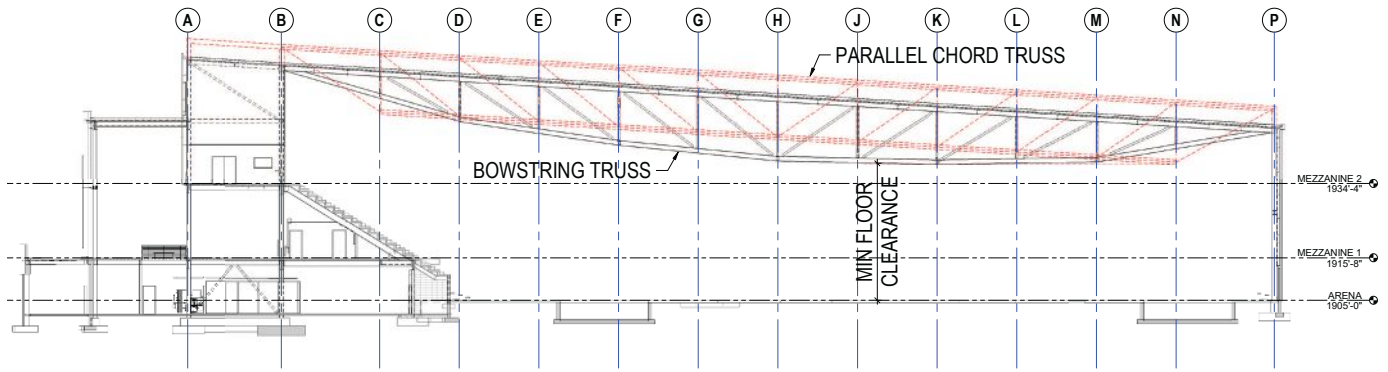

left: The main level, the primary entrance level that serves the general public, includes a long open concourse, which provides access to the bleachers, concessions, restrooms, and a multipurpose room.

above: A view of the Podium's main competition space and its trusses. The nine steel bowstring roof trusses span nearly 250 ft, with each weighing approximately 50 tons. In lieu of a true radiused bottom chord, the bottom chord was segmented to approximate a curve.

District selected the design-build team of architect and structural engineer Integrus Architecture and general contractor Lydig Construction to help take the project from vision to reality. Design-build team members visited similar facilities in Alabama, New York, and Michigan to learn how they are organized and operate during events for fans, athletes, and event organizers at The Podium.

Initial Design

Given the nearly 250-ft clear spans necessary for the field house, steel was the preferred building material. Initially, it was believed that a pre-engineered metal building (PEMB) with rigid frames in the east-west direction and rod bracing in the north-south direction might provide a cost-effective solution for the field house portion of the project since it was essentially a large rectangular box. The design of the adjacent three-level space was less rectilinear and less repetitive, and the team felt a conventional steel-framed structure with braced frames would provide

more design flexibility. Due to the different expected behavior of the two lateral systems, a building joint separating the two structures was anticipated. The team worked with a PEMB manufacturer to get a preliminary layout and sizing for the structural members. The roof frames needed to clear-span the width of the field house, and the manufacturer suggested a frame spacing of 24 ft on center, with light-gauge purlins and girts spanning between these frames. The architectural programming began in earnest using this 24-ft frame spacing.

However, the long-span rigid frames produced tremendous thrust forces at the column baseplates (roughly 100 kips), requiring large footings to resist sliding and overturning forces. Providing below slab tie-rods between the column bases was problematic as the below-floor track and field equipment pits were in the way. Furthermore, the deep tapered columns created sightline challenges for the timing/media suites and some upper bleacher seating. Also, the necessary building joint separating the structures added architectural finish complications and costs.

left: Exposed steel and views of downtown Spokane define a gathering area at one corner of the venue.

below: The field house portion, the main competition area with a 200-m inclined track, required clear spans of nearly 250 ft.

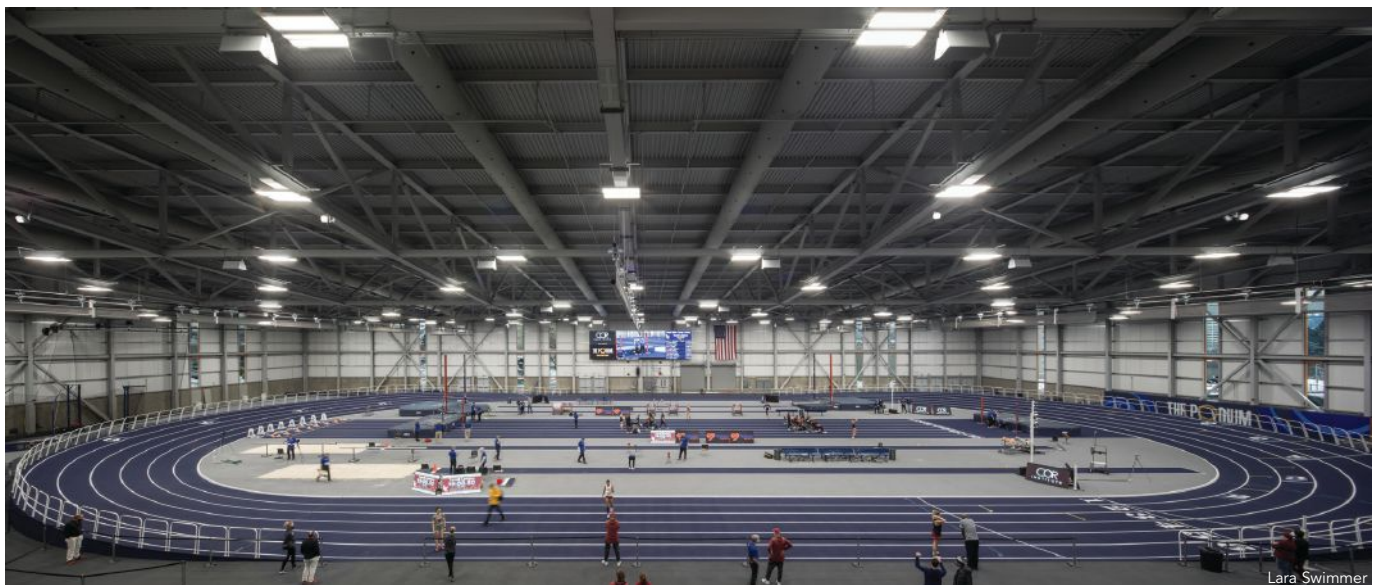



above: Steel stringer bracing for the bleachers.

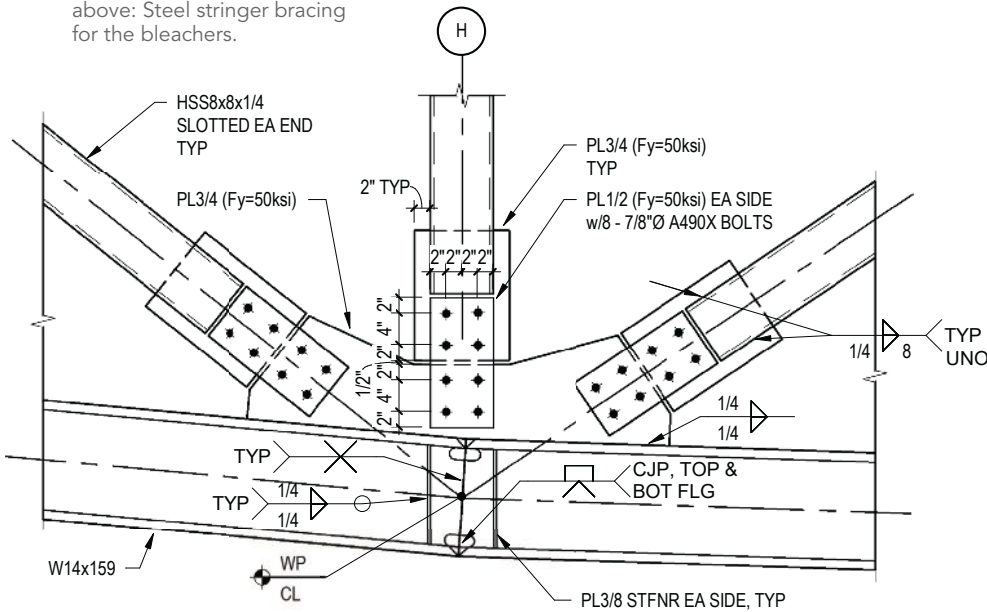

A Better Solution

As part of the design-build process, at roughly the design development level, Lydig prepared a guaranteed maximum price (GMP) to validate that the project can be realized within the client's budget. In preparation for the GMP, Lydig received preliminary pricing for a PEMB package and, due in part to market conditions at the time, found the cost of this system to be \$1 million higher than anticipated. Given the higher-than-expected cost of the PEMB system, as well as the challenges that the system brought to the architectural design, the team began studying conventional steel framing for the field house.

They considered multiple options, including a long-span bar joist system, a parallel chord structural steel truss system, and a bowstring structural steel truss system for the building's roof. The designers determined that one of the two steel truss options would allow more creative price negotiations than the bar joist system, plus lead times for bar joists on the west coast were reaching unprecedented lengths at the time. Up until this point, the architectural layout was based on the initial 24-ft spacing between columns. But in order to reduce the number of trusses required, the team updated the design to incorporate 36-ft column spacing, which

left and below: The top and bottom chords are composed of wide-flange sections, with the web members being HSS. The trusses were cambered 10 in. at midspan, and wide-flange roof purlins span between the truss top chords and align with truss panel points.



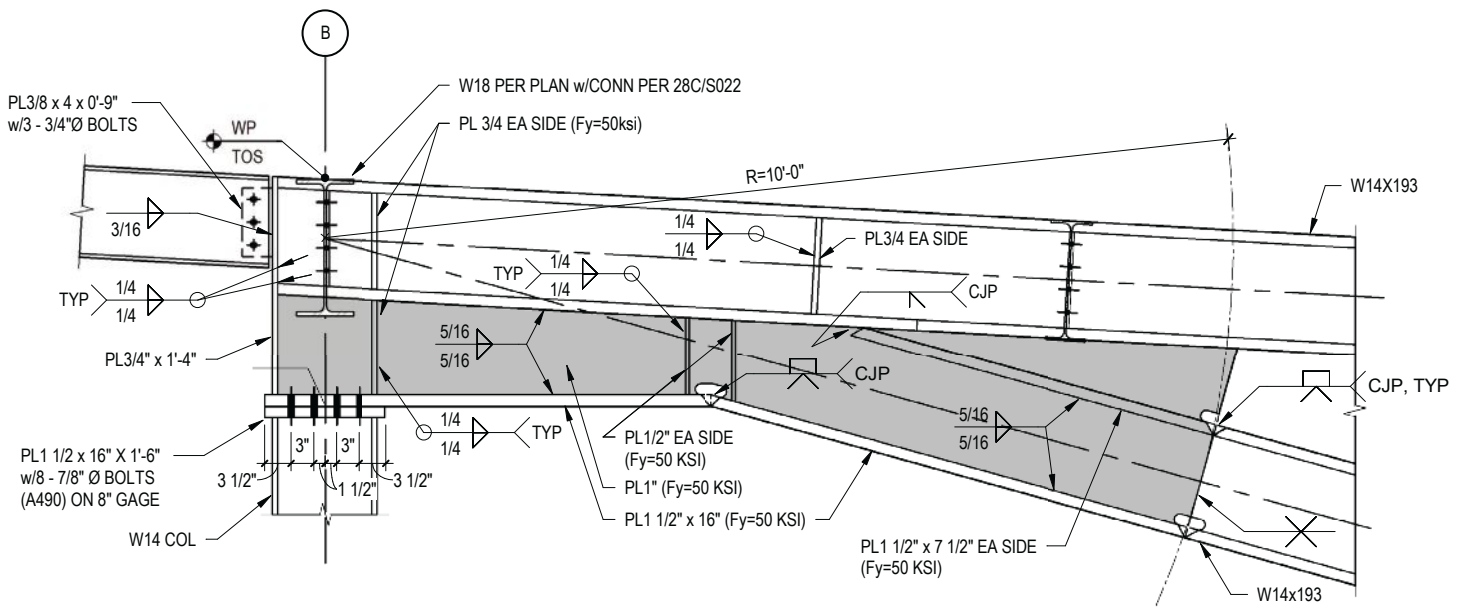

above: A truss connection detail. The team decided on a bowstring truss option for the field house in lieu of a pre-engineered metal building approach.

.....

worked well with the building's overall length of 360 ft and did not significantly affect the architectural plan.

The parallel chord truss option resulted in the lightest-weight truss, though the depth of the trusses required the roof to be positioned higher to provide the minimum required 30-ft clearance from the Field House floor to the roof structure. When it came to the bowstring truss option, the shape of the trusses allowed the roof to be lowered slightly without impacting sight-lines and provided a cleaner, less-imposing feel to the space. The slight increase in the cost of the bowstring truss was offset by the lowered roof and the reduced quantity of exterior wall material, and another benefit to this design direction was that steel braced frames could be used for both the field house and the adjacent three-level structure, eliminating the need for a building joint. Additionally, the exposed steel didn't require spray-on fire protection as the building uses a sprinkler system.

Going with Bowstrings

The nine steel bowstring roof trusses span nearly 250 ft, with each weighing approximately 50 tons. In lieu of a true radiused bottom chord, the bottom chord was segmented to approximate a curve. The top and bottom chords are composed of wide-flange sections, with the web members being hollow structural sections (HSS). The trusses were cambered 10 in. at midspan, and wide-flange roof purlins span between the truss top chords and



above and below: Erecting the trusses. To speed up erection, full-penetration welds were all performed in the shop, and truss chord splice connections and truss web end connections were bolted in the field.



Taking advantage of the progressive design-build delivery method, the owner was able to use savings achieved in some areas, including the steel package, to add acoustical treatments to the field house, add exterior accent lighting, and upgrade some of the track and field netting (for hammer and discus throws).



Lara Swimmer

align with truss panel points. In addition, transverse bracing girders were provided at approximately 40 ft on center.

The elevated floors at the spine are composed of 3½-in. normal-weight concrete over 2-in. composite floor deck. While the long, slender spine had multiple opportunities for locations of longitudinal north-south braces, the narrow, open concourse between levels 2 and 3 was not conducive to traditional braced frames in the east-west direction. As such, the team chose to design the bleacher stringers to serve double duty. These members provide gravity support for the aluminum bleacher system, and they deliver east-west lateral forces from the level 3 floor to the rigid diaphragm at level 2.

The project's success was bolstered by the fact that the steel fabricator, Allied Steel, detailer, Exact Detailing, and erector, American Ironworks and Erectors, were all able to work together early in the process. Weekly virtual coordination meetings were key for strategic detailing, fabrication, and delivery of nearly 1,400 tons of steel for the facility in discrete packages to meet Lydig's construction sequencing schedule. To speed up erection, full-penetration welds were all performed in the shop, and truss chord splice connections and truss web end connections were bolted in the field. The 45-ft-long heel portions of each truss were shop assembled and shipped to the site, and the remainder of the truss

RIBBONS AND CURVES

go Together

CMRP rolled 2x20" plate helically to create a ribbon-like stair stringer for the award-winning Stair & Ribbon Sculpture by Big D Metalworks. No two sections were rolled the same with the tightest radius being 4ft 11in.

Without **Chicago Metal Rolled Products** collaboration, we would not have been able to meet, what was for us, an unachievable production schedule. CMRP took the most challenging part of the staircase project – rolled plate stringers – and delivered accurately rolled material to the site on time and on spec. All other sections of the project were installed perfectly thanks to the skillfulness of the rolled plate stringers. Over 10 years working together and they never disappoint.

- Tony M, Big D Metalworks



CHICAGO METAL
ROLLED PRODUCTS COMPANY

866-940-5739
cmrp.com

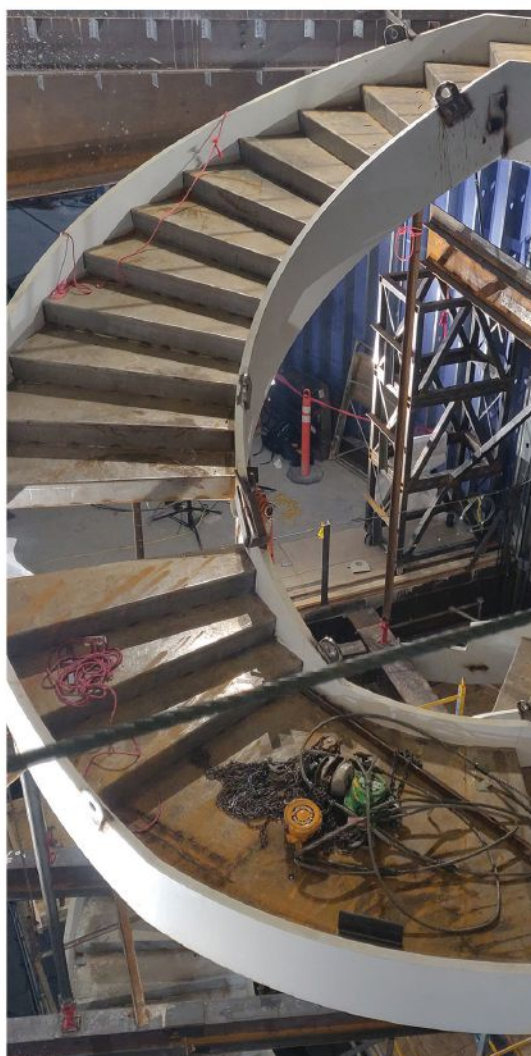

1 Angle Leg Out We bend ALL sizes up to:
 10" x 10" x 1" Angle

2 Angle Leg In
 10" x 10" x 1" Angle

3 Flat Bar The Hard Way
 24" x 12" Flat

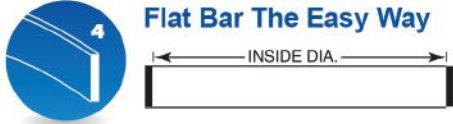
4 Flat Bar The Easy Way
 36" x 12" Flat

5 Square Bar
 18" Square

6 Beam The Easy Way (Y-Y Axis)
 44" x 335#,
36" x 925#

7 Beam The Hard Way (X-X Axis)
 44" x 285#

8 Channel Flanges In
 All Sizes

9 Channel Flanges Out
 All Sizes

10 Channel The Hard Way (X-X Axis)
 All Sizes

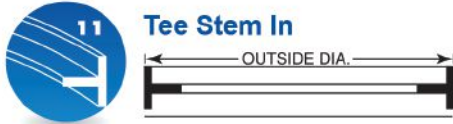
11 Tee Stem In
 22" x 142¹/₂# Tee

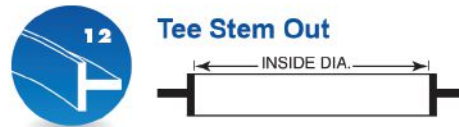
12 Tee Stem Out We bend ALL sizes up to:
 22" x 142¹/₂# Tee

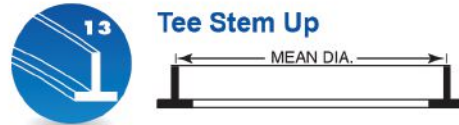
13 Tee Stem Up
 22" x 142¹/₂# Tee

14 Angle Heel In
 8" x 8" x 1" Angle

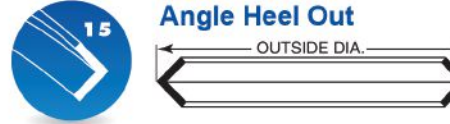
15 Angle Heel Out
 8" x 8" x 1" Angle

16 Angle Heel Up
 8" x 8"x1" Angle

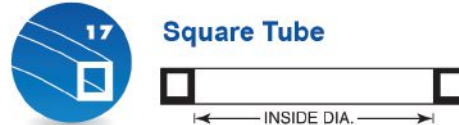
17 Square Tube
 24" x 1¹/₂" Tube

18 Rectangular Tube The Easy Way (Y-Y Axis)
 20" x 12" x 5⁵/₈" Tube

19 Rectangular Tube The Hard Way (X-X Axis)
 20" x 12" x 5⁵/₈" Tube

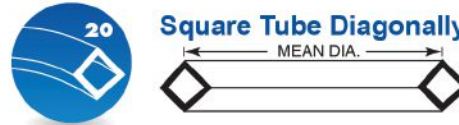
20 Square Tube Diagonally
 12" x 5⁵/₈" Square Tube

21 Round Tube & Pipe
 24" Sched. 80 Pipe

22 Round Bar
 All Mill Produced Sizes

We also roll stair stringers, helical hand rails, off-axis bends, formed shapes and extrusions.

Visit cmrp.com for more information.



CHICAGO METAL
ROLLED PRODUCTS COMPANY

CHICAGO • KANSAS CITY



was site assembled. American Ironworks used a Link-Belt 218HSL 110-ton crawler crane to lift the approximately 105-ft-long end sections for each truss onto a building column at one end, and a shoring tower was implemented at the other end. (This crane allowed the team more space on site due to its compact design and provided better mobility while hoisting the truss sections.) Each truss section was tied into the previously built roof structure before releasing the crane, and the remaining center portion of each truss was assembled in the air. As the shoring towers were lowered, the truss deflections were measured and found to be within 4% of the predicted structural analysis deflections.

The Podium enhances Spokane's draw for regional, national, and international sporting events, and its proximity to Riverfront Park and downtown builds on the vibrancy of the city's core. Like the athletes who will compete in this world-class facility, each member of the design-build team brought their best effort in providing the Spokane Public Facilities District and the Spokane community with a gold-medal project. ■

Owner

Spokane Public Facilities District

General Contractor

Lydig Construction, Spokane

Architect and Structural Engineer

Integrus Architecture, Spokane

Steel Team

Fabricator

Allied Steel  Lewistown, Mt.

Erector

American Ironworks and Erectors

 Spokane

Detailer

Exact Detailing, Ltd. 
Victoria, B.C., Canada



Robert Graper
(rgraper@integrusarch.com) is an associate principal and structural engineer with Integrus Architecture.



SSM Joists & Decks

Fabrication & Supply of:

- Steel Joists & Joist Girders
- Metal Decks
- In compliance with industry standards

Structural Steel Manufacturing, Inc.

PO Box 602828

Bayamon, PR 00960-2828

Tel: (787) 787-5405

Email: sales@ssmjoist.com

Website: sswincpr.org



AISC
CERTIFIED
FABRICATOR
& ERECTOR



ST. LOUIS

SCREW AND BOLT

Connecting amazing structures Nationwide!



Call or email us your inquiry!

St. Louis Screw & Bolt

sales@stlouisscrewbolt.com

800-237-7059

PROUDLY MADE IN THE USA



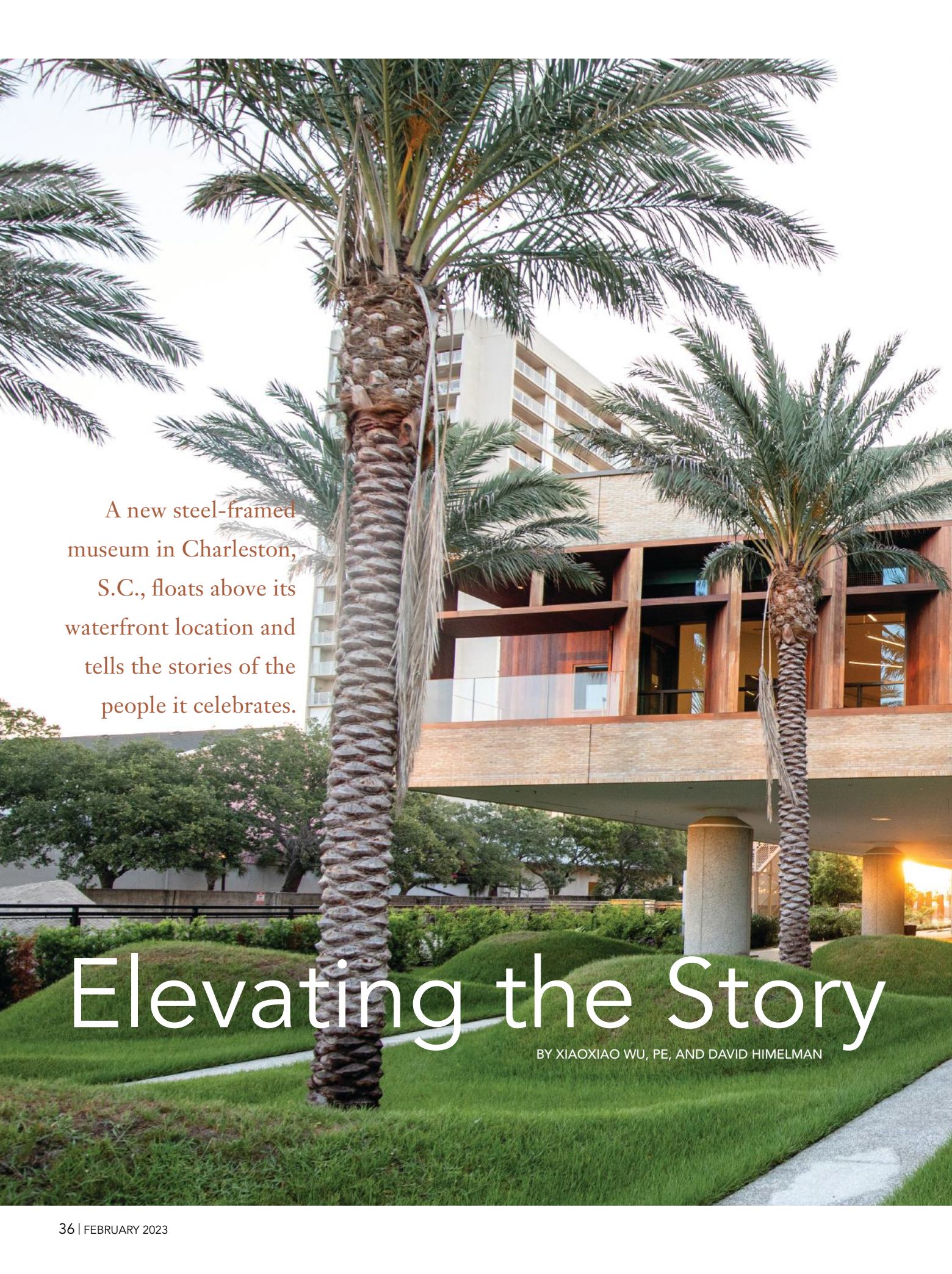

A new steel-framed museum in Charleston, S.C., floats above its waterfront location and tells the stories of the people it celebrates.

Elevating the Story

BY XIAOXIAO WU, PE, AND DAVID HIMELMAN



Photo: Mike Habat

THE INTERNATIONAL AFRICAN AMERICAN MUSEUM (IAAM) is

devoted to telling the stories of African peoples captured and brought across the Atlantic, the cultures they developed, and their continuing impact on our world—and the building’s steel frame helps manage the impact of the elements in its high-wind, high-seismic location.

The new museum’s steel-framed home is situated on the former site of Gadsden’s Wharf in Charleston, S.C., where some historians estimate 40% of enslaved Africans entered the United States. As articulated by Henry N. Cobb, Pei Cobb Freed and Partners’ lead designer for the project, “The special design challenge of the museum was to build on this site without occupying it.”

The building is conceived as a one-story volume measuring 84 ft wide (north-south), 426 ft long (east-west), and 24 ft high, and is raised 13 ft above the ground on a double row of 18 monumental columns, which are set in approximately 18 ft from the volume’s perimeter and arranged in 48-ft by 48-ft square bays.

Elevating the building preserves the hallowed ground it sits on, shelters the African Ancestors Memorial Garden below, and lifts the occupiable interior spaces out of the floodplain. The principal museum building volume is clad in warm, beige Petersen Tegl Brick on its long sides, while the short sides feature approximately 20-ft-deep balconies shaded by angled, vertical louvers. Two off-center cast-in-place concrete cores and a monumental stair situated between them provide access from the Memorial Garden and the gallery level above. The monumental stair is open to the air and configured as a skylight-covered atrium, and above the museum volume is a 48-ft by 192-ft penthouse—set back from the museum parapet to limit its visibility from grade—that houses administrative spaces.

.....

The new International African American Museum measures 84 ft wide (north-south), 426 ft long (east-west), and 24 ft high, and is raised 13 ft above the ground on a double row of 18 monumental columns.

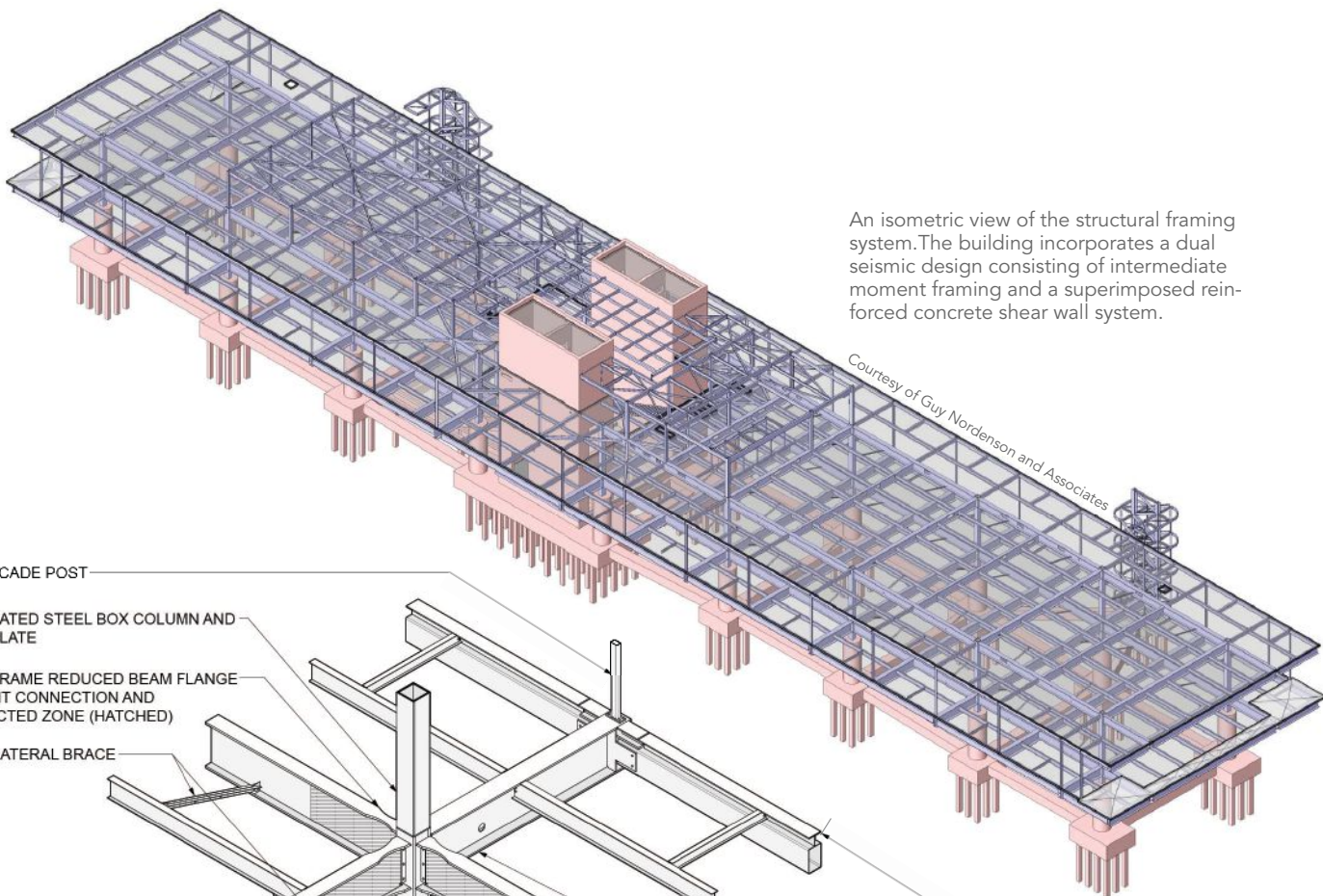

An isometric view of the structural framing system. The building incorporates a dual seismic design consisting of intermediate moment framing and a superimposed reinforced concrete shear wall system.

Courtesy of Guy Nordenson and Associates

HSS FACADE POST

FABRICATED STEEL BOX COLUMN AND BASE PLATE

RIGID FRAME REDUCED BEAM FLANGE MOMENT CONNECTION AND PROTECTED ZONE (HATCHED)

BEAM LATERAL BRACE

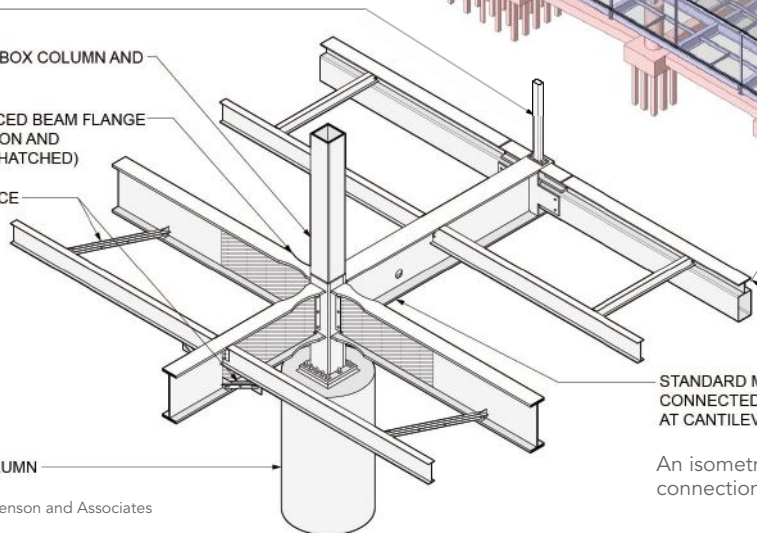

STANDARD MOMENT CONNECTED BEAM AT CANTILEVER

FABRICATED COMPOSITE HSS + WT EDGE BEAM

CIP CONCRETE COLUMN

An isometric detail of a Level 2 beam-to-column connection and cantilever.

Courtesy of Guy Nordenson and Associates

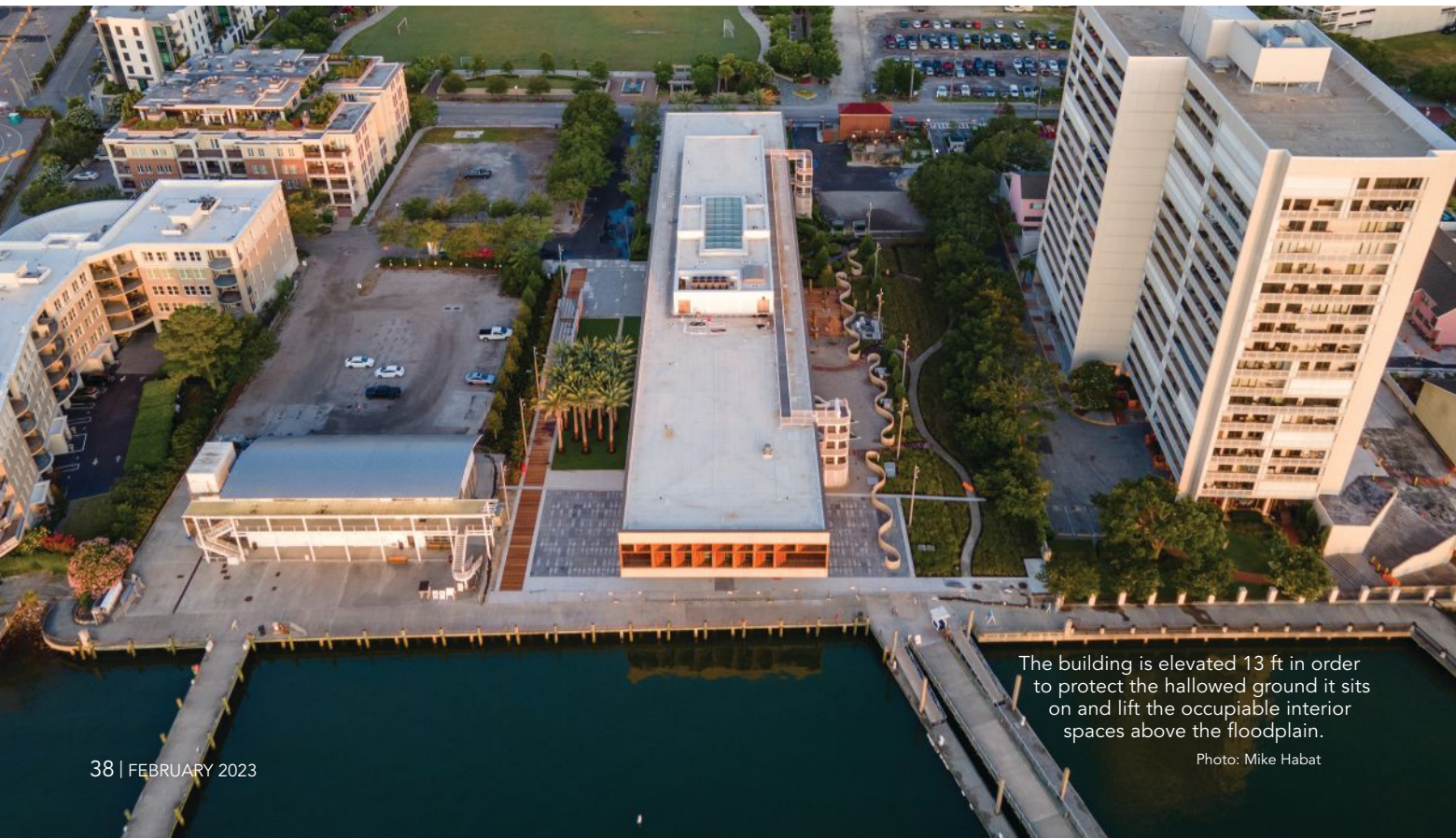

The building is elevated 13 ft in order to protect the hallowed ground it sits on and lift the occupiable interior spaces above the floodplain.

Photo: Mike Habat

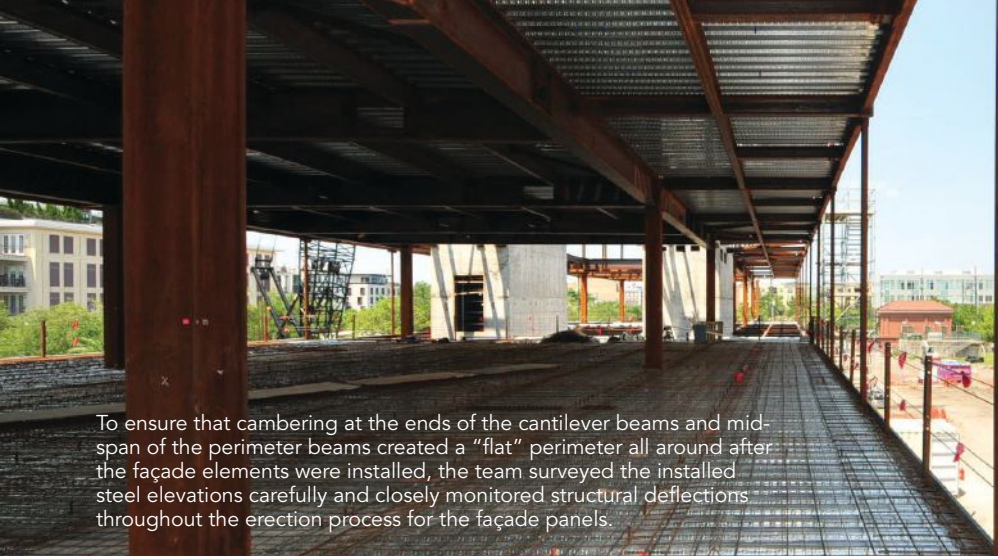

To ensure that cambering at the ends of the cantilever beams and mid-span of the perimeter beams created a “flat” perimeter all around after the façade elements were installed, the team surveyed the installed steel elevations carefully and closely monitored structural deflections throughout the erection process for the façade panels.

Courtesy of Turner-Brownstone

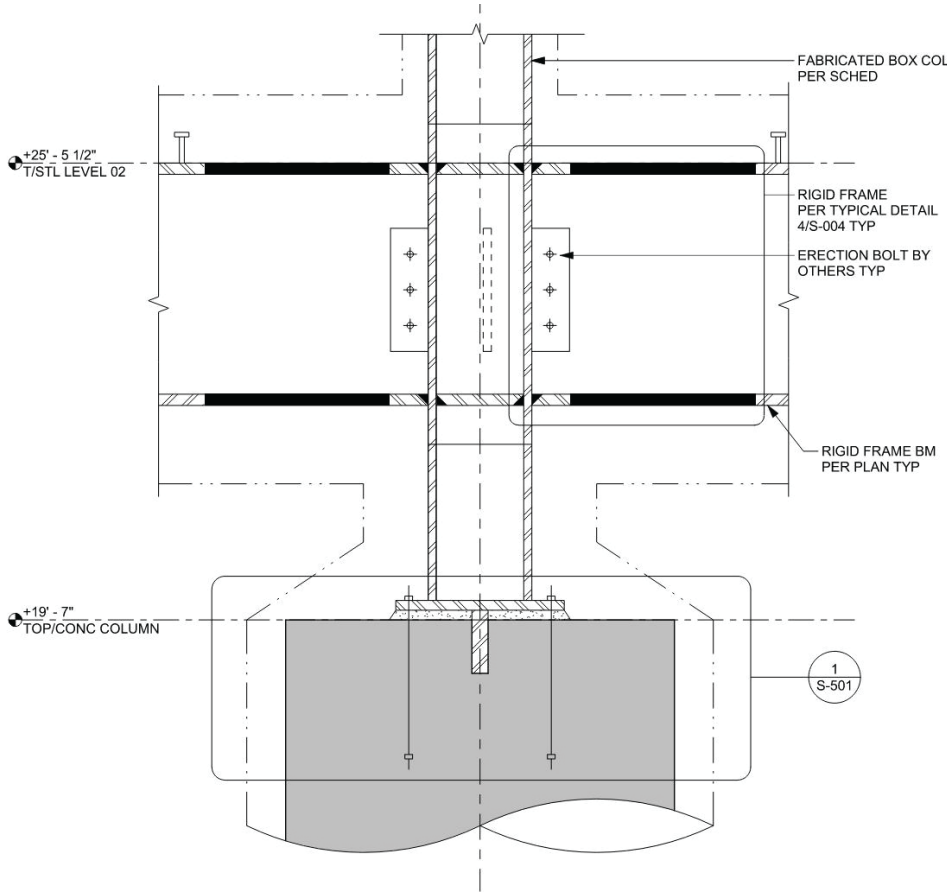

Courtesy of Guy Nordenson and Associates

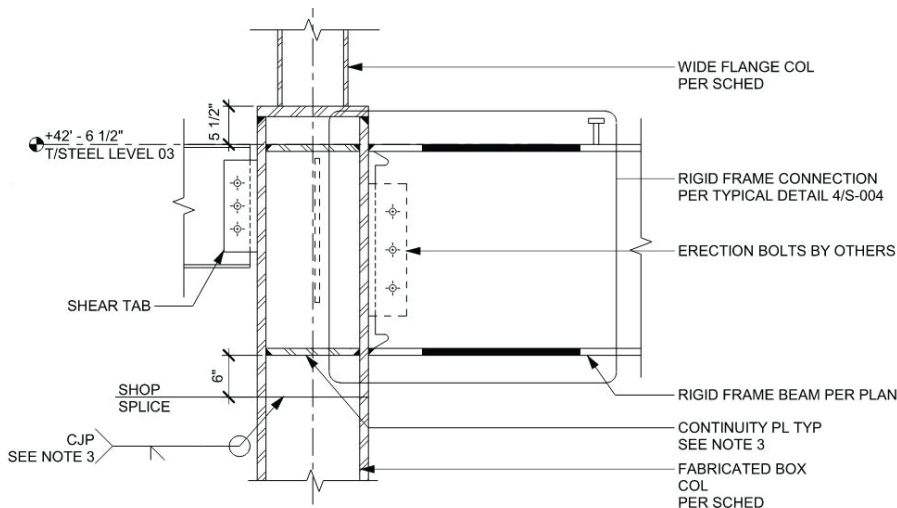

Courtesy of Guy Nordenson and Associates

Design Criteria

The IAAM’s proximity to the coast and location in a seismically active region places significant demands on the structure. In addition to high seismic loads, the structural design accounts for soils prone to liquefaction, hurricane winds of up to 157 miles per hour, the waterfront flood zone, and breaking wave loads. To address concerns regarding wind loading, the client engaged Rowan William Davies and Irwin (RWDI) to conduct a cladding wind load study that included wind tunnel testing.

To cope with the location’s poor soil, the building foundation system consists of pre-cast, prestressed concrete piles supporting cast-in-place (CIP) concrete pile caps connected by CIP concrete grade beams. The piles range in length from approximately 75 ft to 90 ft, depending on the top of finish grade, to extend down to a marl layer bearing stratum. The pile caps are typically 11 ft by 11 ft and situated beneath each of the 18 5-ft diameter CIP concrete columns. The columns, which are clad in 6-ft-diameter glass fiber-reinforced concrete (GFR) column covers, are sized to withstand hurricane/flood loads and support the elevated steel structure above. Larger pile caps support the shear walls forming the building’s two cores, which are asymmetrically placed along the building’s east-west axis.

The cores are a primary component of the building’s lateral force-resisting system and the only path for services, egress stairs, and elevators to enter the building from below. The shear wall design required particular attention to maintaining the

Rigid frame reduced beam flange moment connection details. The steel framing system was designed to manage the potentially severe impact of the elements in the building’s high-wind, high-seismic location.

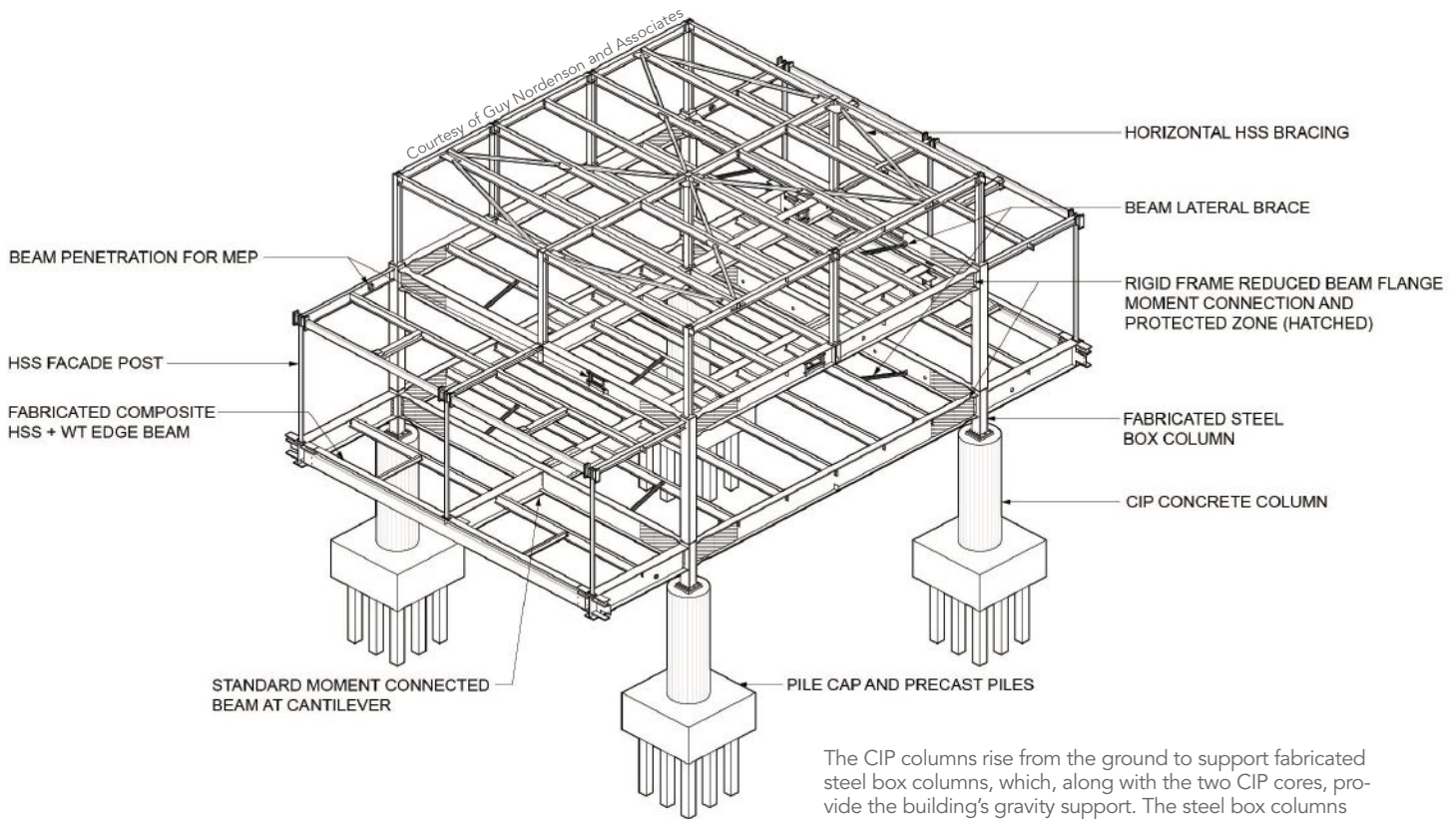

The CIP columns rise from the ground to support fabricated steel box columns, which, along with the two CIP cores, provide the building's gravity support. The steel box columns required a significant amount of welding to fill the seams for the entire length, as well as at the corners and splices.

cores' structural integrity while accommodating the large number of openings required for services. Wall beams and boundary elements are located at the wall's corners and intersections with the steel floor framing. The shear wall design also follows ACI 318 code requirements for special reinforced concrete shear walls to lower the seismic loads on the structural system.

Structural Steel Framing

Each CIP column rises approximately 14 ft to 16 ft to a consistent datum about 12 ft above the finish grade, above which the structural steel framing, approximately 900 tons in total, begins (the project includes an additional 200 tons of steel comprised of miscellaneous and deck elements). These concrete columns support fabricated steel box columns, which, along with the two CIP cores, provide the building's gravity support. The fabricated steel columns are 16 in. square and were fabricated by Lyndon Steel using plate thicknesses varying from 1.25 in. to 2 in. in order to maintain a slender profile that coordinated with the architectural finishes. Columns that extend above the museum roof (Level 3) to support the more lightly loaded penthouse roof transition to standard wide-flange sections.

The typical floor framing at each level consists of a two-way grillage of wide-flange steel beams spanning between columns to form a series of 48-ft square two-way moment frames that pair with the shear walls are the structure's lateral force-resisting system. Due to the region's relatively high seismic loads and the asymmetrical core locations, which induce torsion on the structure, the moment frames are designed as steel intermediate moment frames, per the AISC *Seismic Provisions for Structural Steel Buildings* (ANSI/AISC 341, aisc.org/specifications) with reduced beam-to-column (or “dog

bone”) connections. This detail also includes provisions for diagonal “beam lateral braces” made of double-angle members that connect the moment frame beams' bottom flanges to the secondary framing, which help resist torsion within the deep beams. A secondary wide-flange section at the 48-ft bays' center spans north-south to support infill wide-flange sections that, in turn, provide intermediate support for the slabs, which are composite concrete on metal deck.

At Level 02, the floor framing cantilevers from the column lines 16 ft on the long sides and 20 ft on the short sides to provide the deep eaves and balconies, respectively. Connections of the cantilevered beams are standard moment frame details; the typical column bay's deep beams provide a back span. On the north and south sides, where perimeter beams support the brick façade, custom sections are used for torsional resistance. The fabricated composite section consists of a WT welded to the top of the HSS tube and achieved the greater depth required to support the bottom of the brick façade, which extends about 3.5 ft below the top of the steel while also resisting the torsion caused by the heavy façade loads. These perimeter fabricated sections support slender hollow structural section (HSS) posts spaced 24 ft apart that span to the simply supported perimeter framing at the roof above and control deflections at the façade.

The penthouse roof framing consists of moment frames arranged in the east-west direction only. The frames consist of wide-flange columns and beams and support an unfilled metal deck. Due to the asymmetrical position of the penthouse, some of the wide-flange columns do not align with the 48-ft square grid and instead transfer their load to the deep beams below. In the absence of the slab diaphragm and a two-way moment frame system, the penthouse roof framing

The perimeter of the building on all four sides had cantilevered floor beams that spanned more than 15 ft. CAS Steel Erectors had to use shoring towers to hold the beams at an upset elevation while completing connection welds in all locations to allow the correct deflection once loaded.



Courtesy of Turner-Brownstone

uses in-plane, horizontal HSS diagonal bracing. The penthouse roof also includes a large central skylight slightly elevated above the roof that provides cover for the monumental stair atrium. This framing consists of a moment-connected 7-ft by 5-ft grid of HSS beams supported by the CIP concrete shear walls and HSS posts bearing on the primary penthouse roof steel framing below. The skylight structure is connected to the concrete shear walls at four distinct support points for gravity and lateral stability; each of the four connections is detailed to release movements in different directions (allowing maximum flexibility of the steel framing under temperature loading in order to minimize temperature-induced stresses in the steel). At the exterior four corners of the skylight, four posts extending down to the steel beams at the penthouse roof level provide additional vertical support. Teflon coatings are applied in the base connections of these posts to avoid lateral interaction between the skylight framing and the base building structure.

Façade Work

The building is entirely clad by a brick façade, and the sensitivity of the bricks to movement required close collaboration between the design of the primary structure and the façade structure. Structural engineer Guy Nordenson and Associates (GNA) worked closely with façade design consultant Thornton Tomasetti to confirm that the primary structural deflections were acceptable. Multiple load combinations were analyzed that considered the construction sequence of the brick façade panels and various live load patterns, and GNA provided detailed vertical and lateral deflections to Thornton Tomasetti at every façade panel connection point to the primary structural beams for these load combinations. Because of the design team's close attention to the detailing and installation planning of the brick system throughout the design phase of the project, the façade installation went smoothly during construction.

Coordination Successes

Throughout the construction documents phase, coordination between the architectural ceiling build-up, MEP systems designed by Arup, and steel floor framing received

Addressing Thermal Bridging

Egress from the museum's north side is provided by two steel staircases whose second and fourth landings are tied into the building's interior wide-flange steel beams, posing a potential thermal bridging problem. Without thermal breaks, heat energy would flow unabated through the otherwise insulated building envelope, wasting heat or air-conditioning efforts and allowing condensation and mold to form on adjacent interior structures during cold winter months.

To mitigate thermal bridging, the team specified Schöck Isokorb steel-to-steel structural thermal breaks to be installed in line with the building envelope at the point where the landing frames connect to interior beams. Each thermal break consists of stainless steel threaded rods and bolts penetrating an R-15 insulation block, providing requisite structural integrity while reducing heat energy transfer by up to 75%. Not only do the breaks satisfy gravity loads, but they also withstand lateral forces from earthquakes, floods, and hurricanes.

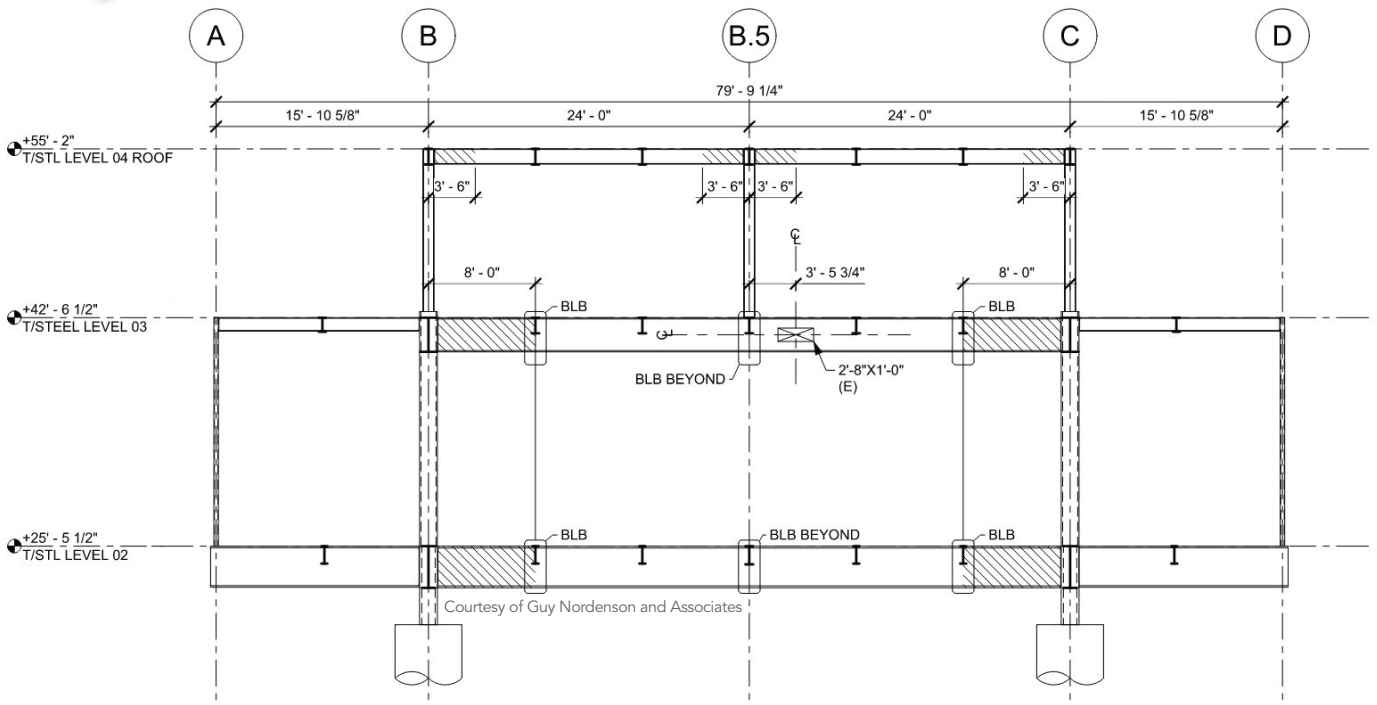

above: The north-south framing elevation, indicating beam penetrations for building services and protected zones in areas around reduced beam flanges.

right: A view of a rigid frame connection with a reduced beam flange section.

below: The principal museum building volume is clad in warm, beige Petersen Tegl Brick on its long sides, while the short sides feature approximately 20-ft-deep balconies shaded by angled, vertical louvers.



Courtesy of Turner-Brownstone

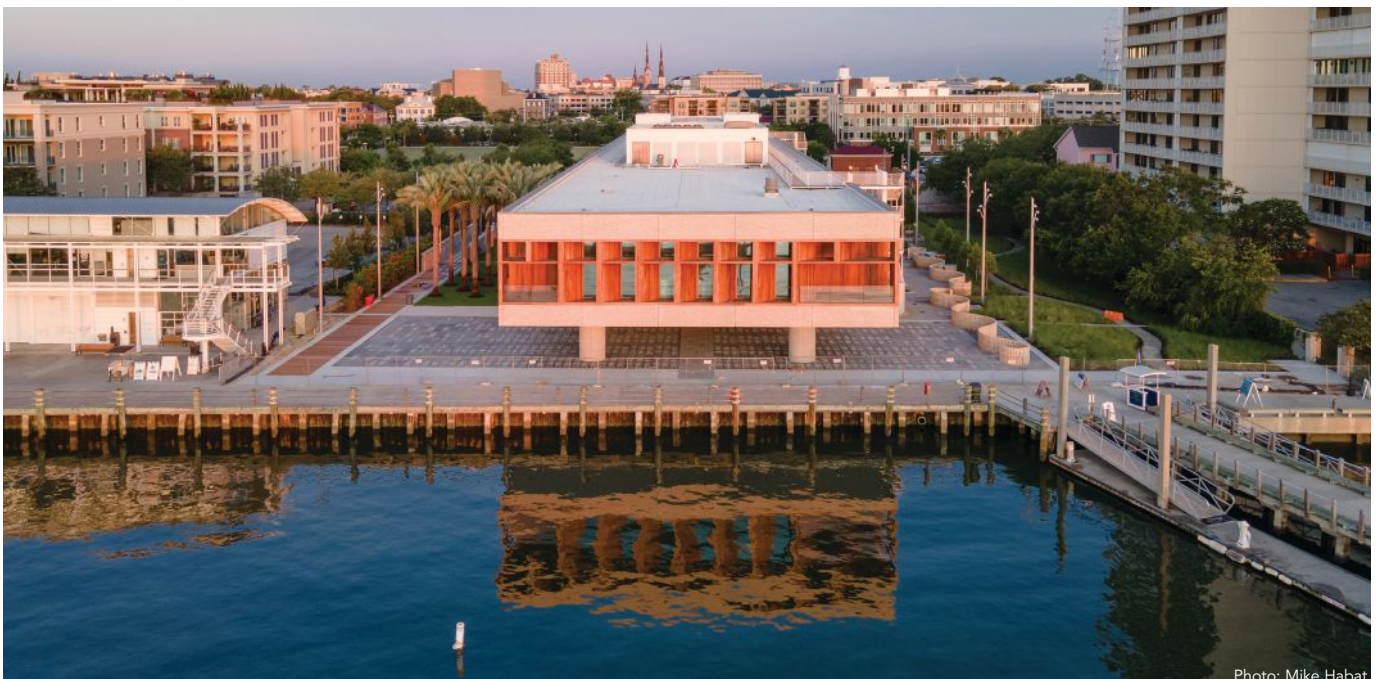

Photo: Mike Habat

significant design team attention, which was facilitated by using AutoDesk Revit and producing more traditional plan overlay drawings to track clashes. A typical architectural floor section of 50 in. and the building's elevation above the ground, which required all services to issue from the two central building cores, made coordination particularly important and challenging since penetrations through the steel beams would be required. The reduced beam flange moment frame connection imposed further constraints, as no architectural wall connection or other welded connections could be made to affected beams within 8 ft of connections to the columns. To ensure that design criteria were adhered to and that beam penetrations were well documented going into bidding and construction, GNA elevated each primary line of structural framing to document the "protected zone" per the AISC *Seismic Provisions* and the penetration locations.

The combination of demanding design constraints imposed by the site—from seismic and hurricane activity to proximity to the Atlantic Ocean—and the elegant directness of the building's architecture required the development of an equally simple, pragmatic, and robust structure. Delivering such a solution required close design and steel team coordination early on, and these collaborative efforts, which guided the development of the project's structural approaches, ensured the successful realization of the new home for IAAM's important work. ■

Owner

International African American Museum

General Contractor

Turner Construction/Brownstone Construction Group

Architect of Record

Moody Nolan

Design Architect

Pei Cobb Freed & Partners

Structural Engineer

Guy Nordenson and Associates

Façade Consultant

Thornton Tomasetti

Steel Team

Fabricator

Lyndon Steel Company ,
Winston-Salem, N.C.

Erector

CAS Steel Erectors, LLC ,
Hendersonville, N.C.

Detailer

Prodraft, Inc. , Chesapeake, Va.



Xiaoxiao Wu is an associate partner and **David Himelman** is a senior associate, both with Guy Nordenson and Associates.

For the fabricator looking to maximize their production time and profits, the Lightning Rail is a smart decision.

Eliminate the countless manual labor hours involved in laying out handrails, stair stringers, trusses, and more!

- ✓ Cut fabrication time by more than 50%
- ✓ Ensure the highest level of accuracy
- ✓ Boost your profit margins
- ✓ Lay out complex geometry in seconds
- ✓ Designed to replace your existing fabrication table

"The guys love it. They jumped right in on it and have been working to make the most use of it. Great purchase."

Nat Killpatrick
Basden Steel Corporation

"I think it's fair to say that this machine continues to exceed our expectations. We are very happy with it."

Chief Operating Officer
Koenig Iron Works



by Automated Layout Technology™

Patent No. US 10,576,588 B2
Patent No. US 11,426,826 B2

SPEED, ACCURACY, & HIGHER PROFIT MARGINS

603-402-3055
AutomatedLayout.com





Mighty Bridge over the Mighty Mississippi

BY AHMAD ABU AFIFEH, PE

IOWA AND ILLINOIS went big with a vital—and iconic—steel replacement bridge that connects the two states over the Mississippi River and turned to grade 70 steel to make it happen.

Interstate 74 is an important east-west link in the nation's transportation network, and the I-74 bridge crosses the Mississippi River between Bettendorf, Iowa, and Moline, Ill., on two separate structures. The westbound span was built in the 1930s and the eastbound span in the 1950s, and the twin spans have always been a key symbol of the Quad Cities.

But over the years, these crossings—built with substandard lane widths and no shoulders—were no longer capable of efficiently handling ever-increasing traffic loads. Creating an improved crossing between Bettendorf, Iowa, and Moline, Ill., became a regional priority.

In November 2020, a new westbound bridge opened, followed by the eastbound span in December 2021. One of the largest investments ever by the two states, the project delivered a safer, expanded, and more reliable new interstate bridge, as well as an iconic landmark that transforms and beautifies the riverfront in the Quad Cities.

The Iowa and Illinois DOTs worked with the Quad Cities communities, who made it clear they wanted an iconic gateway structure.

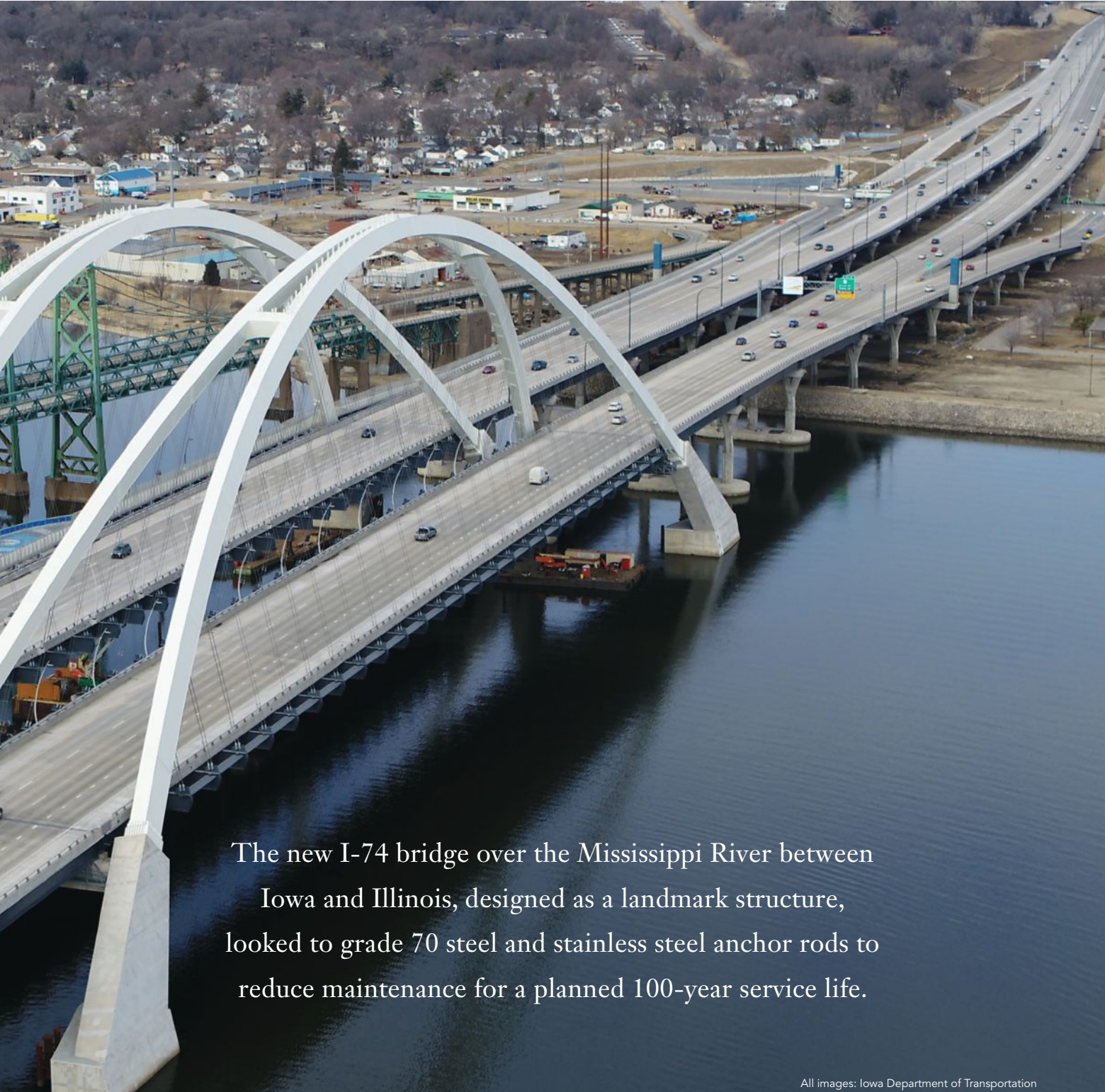

The new I-74 bridge over the Mississippi River between Iowa and Illinois, designed as a landmark structure, looked to grade 70 steel and stainless steel anchor rods to reduce maintenance for a planned 100-year service life.

All images: Iowa Department of Transportation

The \$1 billion project included mainline reconstruction and interchange reconfigurations and the replacement of the east and west crossings with a 70-ksi steel superstructure connected with high-strength bolts, with the new spans using stainless anchor and coupling nuts and stainless rebar in the deck. The new structures also include a 14-ft-wide multiuse pedestrian/bicycle trail that cantilevers downstream of the arch rib.

The Iowa Department of Transportation (DOT) was the lead agency for the project and worked in partnership with the Illinois

DOT and the Federal Highway Administration. The state agencies also worked closely with the Quad Cities communities on both sides of the river from the very beginning to coordinate construction and select a design for the new bridge. The communities made it clear they wanted an iconic gateway structure, and the design team of the Iowa Department and Illinois DOTs, Alfred Benesch and Company, and Modjeski and Masters developed a steel true arch “basket-handle” design with minimal bracing. From there, both states and local partners set out

to construct a landmark bridge that the community would be proud of and that would bring interstate travel in the area into the 21st century.

In the summer of 2017, general contractor Lunda Construction Co. began constructing the new river bridges. The project's location and design and the communities' desire to keep traffic flowing between both states required complex staging and unique construction methods. Serving as an extension of Iowa DOT, HNTB provided construction engineering and inspection, and Wood, PLC provided general engineering consultant services for the project.

Both the westbound and the eastbound bridges are 3,387 ft long, with 795-ft-long main spans and 72-ft-wide decks. The bridges include four traffic lanes in each direction—double the traffic capacity of the original bridges, which are currently undergoing demolition.

At 245 ft tall, the basket-handle arches serve as the bridges' most visible and defining characteristic. The true arch design carries all forces through the arch ribs and into the arch piers, ultimately dissipating the forces into the drilled shafts embedded in the river bedrock. To assemble the arches, fabricator Industrial Steel



right: A view of the drilled shaft and foundation work.

below: Erecting a steel arch segment on the Iowa side of the river.





above: A view of the westbound bridge arch with 20 of the 30 arch segments installed.

left: Installing a westbound arch segment via a crane on a barge.



.....

Construction fabricated 30 welded steel box sections for each of the two spans at its Gary, Ind., facility. The plate thicknesses varied between the sections, and the depths varied from 12 ft at the bases of the arches to 9 ft at the crown with an enlarged 15-ft by 9-ft steel base. The width of the box section ribs remains constant at 6 ft through the arches, and the sections contain an access walkway system inside. Arch rib segment weights and lengths varied from 50 tons and 38 ft to 109 tons and 66 ft. The arch sections were loaded onto barges and trucks and delivered to the Quad Cities, and the two spans incorporate more than 35,000 tons of structural steel in total.

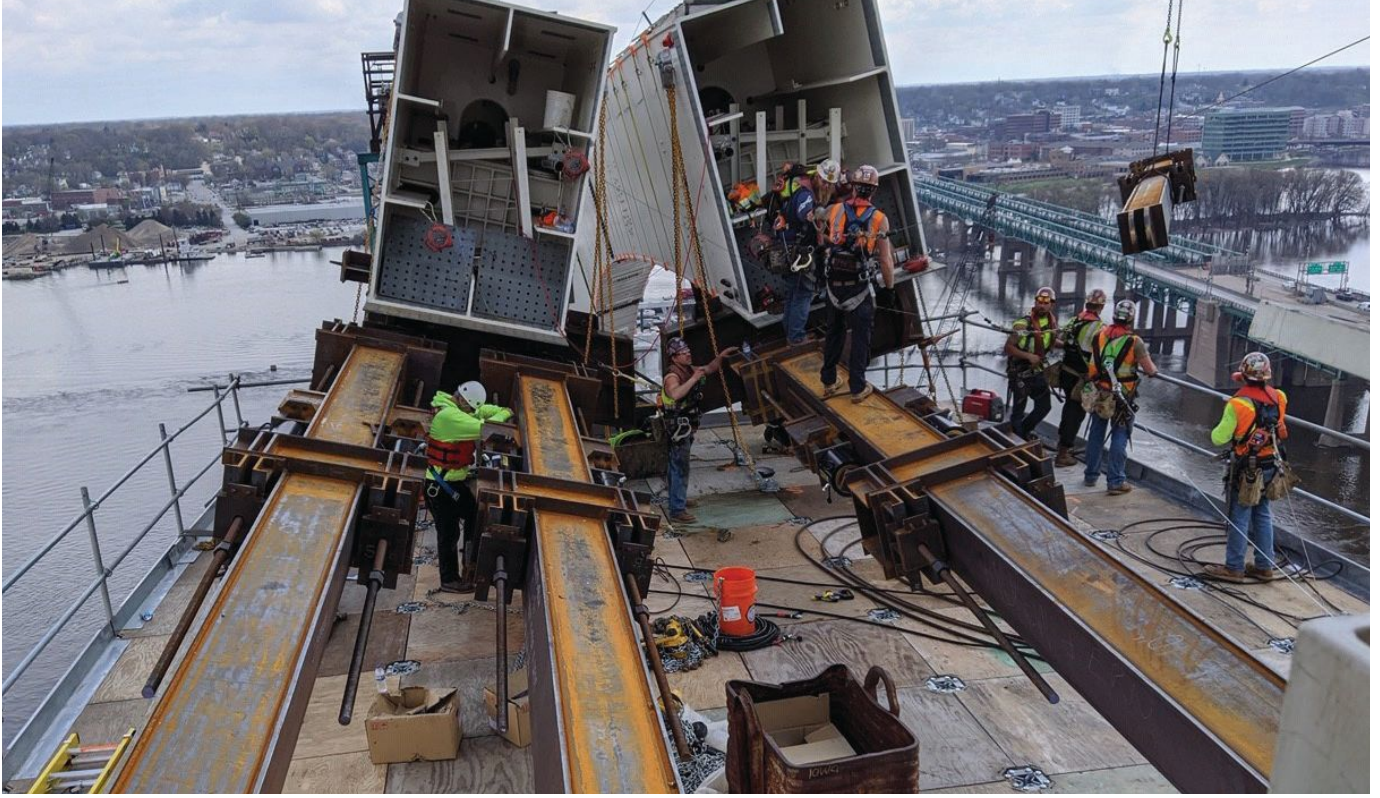

above: Installing struts to help with keystone installation for the westbound arch.

left: Installing the keystone for the westbound arch

below: In all, both the eastbound and westbound bridges incorporate more than 35,000 tons of structural steel.



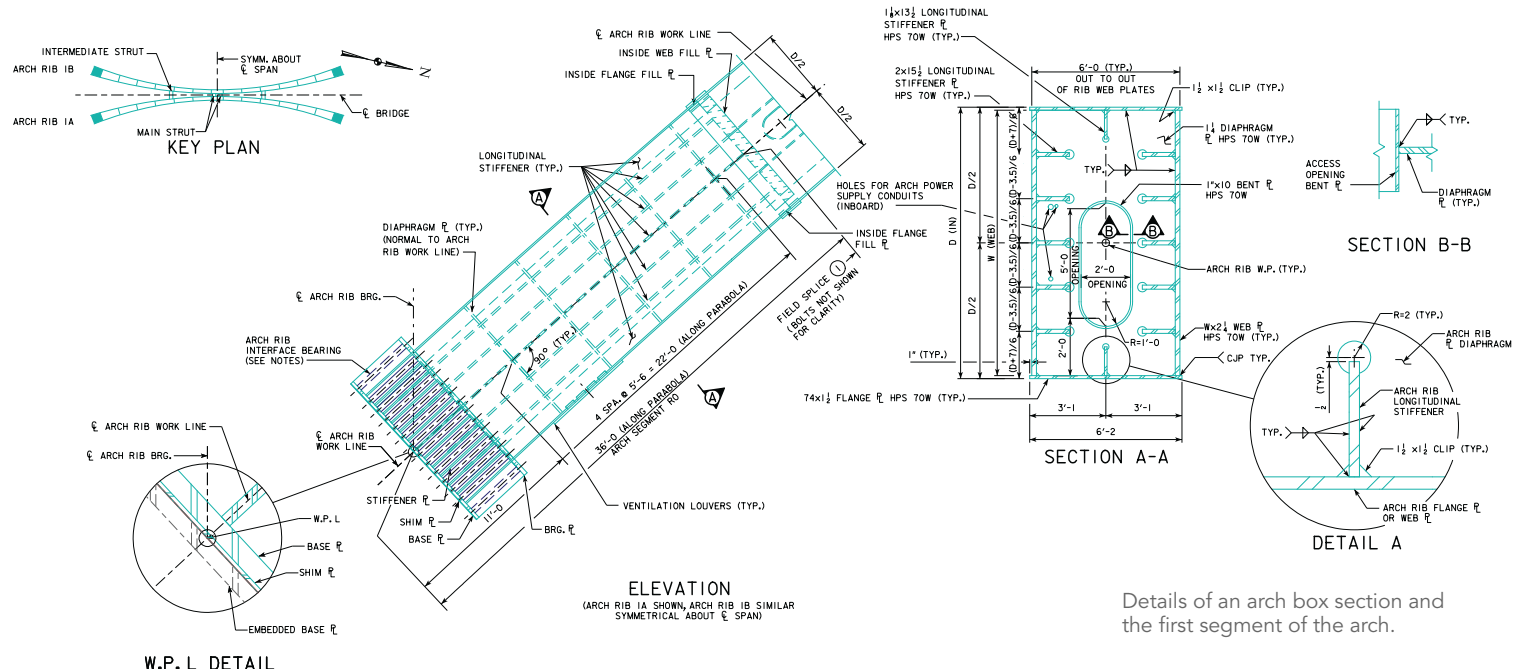

Details of an arch box section and the first segment of the arch.

The weather posed challenges throughout arch erection as the Quad Cities experienced extreme winters and record flooding during the construction phase. Night shift ice-breaking operations were implemented during different stages of the construction to maintain access for critical operations, and strong coordination and partnership among the project teams were essential during high winds and extremely cold winters. In addition, much of the

project took place during the height of the COVID pandemic, forcing teams to adjust how they completed their daily tasks in order to follow state and federal health recommendations.

Site constraints also created challenges. The eastbound bridge had to be constructed in a more constrained area due to having the westbound bridge on one side and the original bridge structures on the other. To facilitate construction while sandwiched between



Steel Strong in
ST. AUGUSTINE
 Connecting Leaders, Creating Community

Register Now!
2023 CONVENTION & TRADE SHOW
 March 28-31, St. Augustine, Florida

STEEL ERECTORS ASSOCIATION OF AMERICA
 336-294-8880 • SEAA.net/events



Industrial Steel Construction fabricated 60 steel sections in total at its Gary, Ind., shop, which were then loaded onto barges or trucks to be delivered to the Quad Cities site along the Mississippi River.



The bike and pedestrian path and scenic overlook on the eastbound bridge.



The bridges' opening celebration in late 2021.

two bridges, Lunda looked to two of the tallest free-standing tower cranes (400 ft tall) ever used to build a bridge in the Midwest.

The bridge also spans a heavily used commercial navigation channel and recreational boating area. Maintaining river access to commercial and recreational boats during construction was an essential consideration, so the team erected the steel during brief planned closures. Since the navigation channel could not be closed to allow for supporting structures under the arches as they were assembled, stay cables were used to adjust the angle and geometry of the arch ribs. Iowa DOT developed a quality assurance survey plan to ensure fit-up and closure of the arches as they were assembled. The arches were erected piece by piece, starting from the ends and meeting in the middle. Intelligent teamwork was the key to fitting the crown/keystone piece of each basket-handle arch into place and under tight 3D spatial tolerances.

The structure's longevity was a major priority for both the Iowa and Illinois DOTs. Constructing a bridge designed for a 100-year lifespan required high-quality materials and emerging technology. The arches are made from a combination of ASTM A709 HPS70W and ASTM A709 HPS50W steel coated with a fluoropolymer coating system. The team specified anchor and coupling nuts made of 2507 stainless steel alloy with 116-ksi yield strength to reduce maintenance needs and extend the service life of the arches. Uncoated weathering steel was used in the floor system, and stainless steel was also used for the rebar in the bridge deck.

The new bridge was constructed with state-of-the-art maintenance technology, including a health-monitoring system that will continue to keep Iowa DOT informed of maintenance needs. The system consists of sensors placed throughout the bridge structures that transmit data, such as vibrations, stresses, and concentration

of calcium chloride in the pavement, to the DOT. In addition, a maintenance waterline along the length of the floor system located below the bridge deck was installed to facilitate routine washing. The westbound bridge was designed with winglets arranged along the leading edge to help mitigate undesirable vortex-induced oscillations in strong winds, the first of its kind for an Iowa DOT bridge.

The eastbound bridge includes a 14-ft-wide multiuse bike and pedestrian path that connects to over 60 miles of riverfront trails in the Quad Cities. The path provides an accessible and scenic way to explore the riverfront and downtown areas, including concert venues, local events, shopping districts, and recreational areas. It also includes a scenic overlook with a glass-bottom viewing area, seating, and artistic sculptures, welcoming residents and visitors to stop and appreciate the river views. Structurally, the cantilevered trail acts as a stabilizing element for the eastbound bridge, reducing the impacts of wind and vibration. The asymmetric steel arrangements of the trail created challenges related to constructing deck cross slopes and grades, so a tight tolerance survey was implemented to meet the requirements for these slopes and grades per the design plans.

The new bridge has significantly improved operations, capacity, and safety, and the Quad Cities have embraced the bike/pedestrian path both during the day and at night. Communities on both sides of the bridge are able to take advantage of the color-changing capability of the crossings' aesthetic lighting to celebrate holidays and other events, further elevating the new bridge's status as a structural icon for the area. ■



Ahmad Abu Affeh
(ahmad.affeh@iowadot.us) is a senior engineer with the Iowa Department of Transportation and served as the project manager for the I-74 Mississippi Bridge replacement project.

Owners

Iowa Department of Transportation
Illinois Department of Transportation

General Contractor

Lunda Construction Company

Structural Engineers

Modjeski and Masters, Inc.
(superstructure)
Alfred Benesch and Company
(substructure)

Construction Engineering

HNTB (construction engineering and inspection)
Wood, PLC (general engineering consultant)

Steel Team

Fabricator

Industrial Steel Construction, Inc.
AISC CERTIFIED FABRICATOR Gary, Inc.

Detailer

Tenca Steel Detailing, Inc. AISC DETAILER
Quebec, Canada

ABL-100HS
Angle Line

The only angle & flat bar line holding the title for both toughest build quality and fastest speeds.

Controlled Automation

501.557.5109 | www.controlledautomation.com

Applicable Analysis

BY RAFAEL SCUDELARI DE MACEDO AND LUIZ FRANCISCO SCUDELARI DE MACEDO

Learn about the intersection of connection design and finite element analysis at NASCC: The Steel Conference.

FINITE ELEMENT ANALYSIS (FEA) has advanced tremendously in the last decade, but it is still regarded with skepticism by some in the structural steel industry.

An upcoming NASCC: The Steel Conference presentation will explore the application of FEA techniques for the design of connections in engineering practice, discussing the current state of the art in advanced FEA and why its usage can bring benefits to the connection design in terms of material optimization and costs. To illustrate the cases in which FEA should be used for connection design, real-world examples of connections calculated using FEA will be exhibited and compared to the traditional approach. Finally, practical FEA best practices and pitfalls will be presented and discussed. Here's a rundown:

Situations where FEA is applicable. FEA is advised for connections where highly non-linear effects must be accounted for. These include connections where one or more of the following is present:

- Contact with and without friction, such as clamps and enclosures
- Important plastic deformation and important redistribution of loads after yield
- Requirements for distribution of stresses in bolts and welds

Moreover, FEA is a fantastic tool for deriving the stiffness of connections. The stiffness of the connection may be inserted in the design software as partial fixity (instead of pinned/rigid) to account for more realistic behavior.

Modeling strategies. When it comes to deflection control versus load control, the action on the connection usually comes from the design software used to execute the basic design of the structure. These may either be expressed in terms of stress resultants (forces and moments) on the connected frames or in terms of their relative displacement (translation and rotation). Both options may be used to load the detailed FEA of the connection with the following aspects:

- **Force-controlled.** One frame is fixed, and the other frames have applied loads. The general output is the reaction forces at the fixed frame and the displacements at the loaded frames of the connection. This approach is

usually appropriate for cases where the ultimate capacity is being analyzed.

- **Displacement-controlled.** The displacements and rotations are applied to all frames. The general output is the reaction force at each frame. This approach is usually appropriate for cases where the evaluation of the connection stiffness is required.

Another modeling strategy is to use 3D elements versus plane elements, meshing, and element types. Today's processing power and software development allow the practicing engineer to have detailed tetra and quad meshes using 3D elements with midsize nodes. Using 3D elements simplifies model generation and allows the engineer to quickly capture detailed effects, such as the distribution of forces on bolts.

Non-linearities and how to include them. Material force-displacement curves for different steel classes—e.g., differences between steel grades such as A572Gr50 and F3125—will be discussed, as will strategies for considering contact of plates and bolts—e.g., the definition of the contacts between bolts and parts should be done in such a way so as to simplify capturing the shear and axial forces at each bolt.

Understanding the results and deriving stiffness. The results between the connection's FEA model and the values coming from the design software used to execute the basic design of the structure have discrepancies—mostly due to the fact that the stiffness of the FEA model is much more realistic. Moreover, the FEA model considers complex non-linearities that are normally not included in the frame model. The impact, relevance, and physical meaning of this discrepancy will be discussed, along with ways to derive the stiffness of a connection using the FEA model so that it may be accounted for in the frame model of the structure.

Specific checks for bolts. The capacity of various bolts has been studied and is very empirical. Thus, it is inadvisable to directly use the stress/strain distribution on the bolts through the FEA software to evaluate their capacity. The better strategy is to use the FEA model to calculate the stress resultants (shear and axial forces) on the bolts and to evaluate their capacity using analytical formulae.

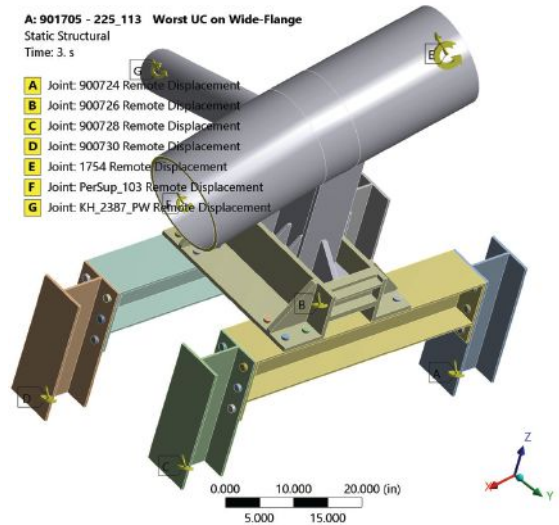
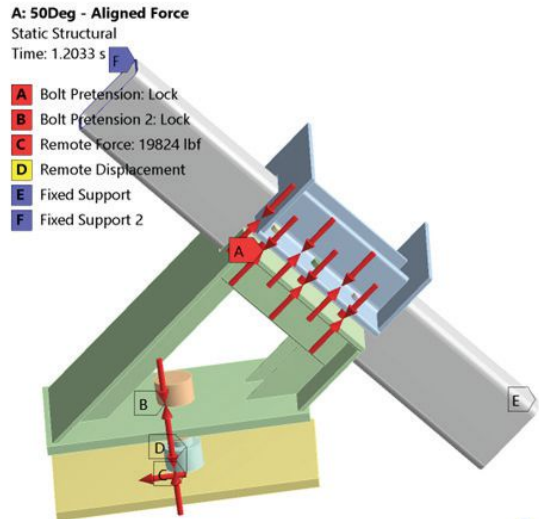
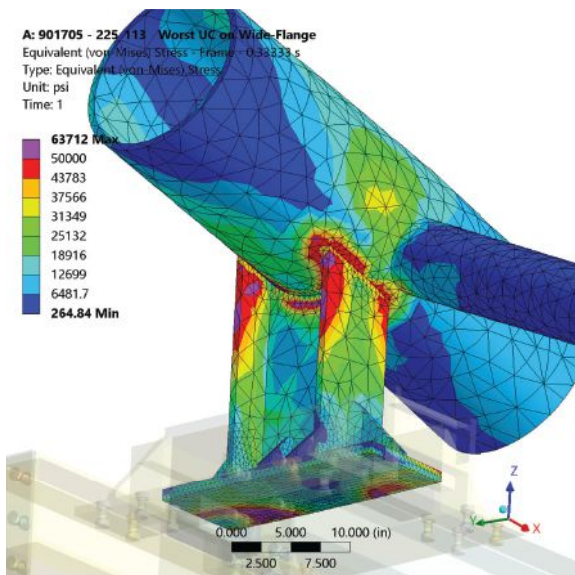
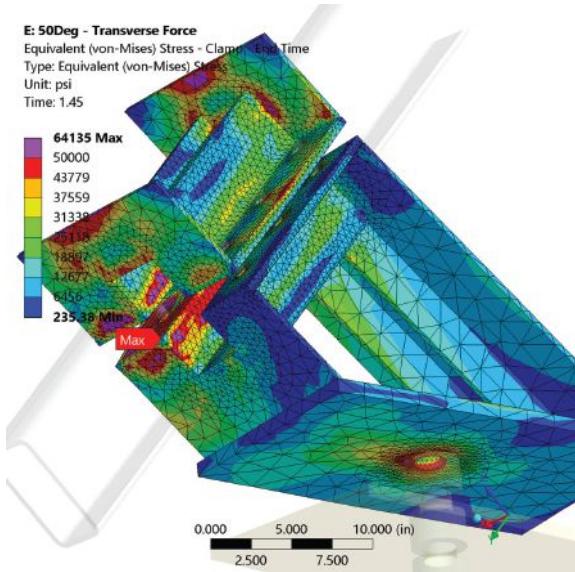

Specific checks for welds. Three design approaches for weld design using FEA will be explained:

1. The “simplified” design approach, where welds are not included in the model but are specified in such a manner that failure would never occur at the welds but rather always at the modeled plates.
2. The “classic” design approach, where the welds are also not included in the model and are designed by separated spreadsheets using the forces captured at the nodal locations of the FEA model.
3. The “projected force” design approach, where the welds are included in the model as perfectly elastic elements and are checked by means of a stress check at the interface plane with the plates.

Comparison to analytical results. Two connections will be analyzed through traditional analytical calculations and through FEA, namely shear tabs and base plates. And the differences between both approaches will be discussed. ■

This article serves as a preview of the 2023 NASCC: The Steel Conference session “Connection Design Using Advanced FEA.” To learn more about this session and others, as well as to register for the conference, visit aisc.org/nascc. The conference takes place April 12–14 in Charlotte, N.C.



Rafael Scudelari de Macedo
(rafael@emasa.eu) is the owner and **Luiz Francisco Scudelari de Macedo**



(luiz@emasa.eu) is a structural and civil engineer, both with Emasa Engineering.



Buying Green

BY MAX PUCHTEL, SE, PE, AND JOHN CROSS, PE

As the prevalence of Buy Clean laws and the demand for environmental product declarations increase, it's important to stay up to date on these and other sustainability-related topics.

THE DESIRE FOR “clean” building materials is on the rise.

A growing number of project owners are requiring or considering requiring the structural steel used on their projects to have embodied carbon impacts less than a mandated threshold, similar to those established by “Buy Clean” provisions.

Buy Clean programs are now in place in California, Colorado, and Oregon, and their requirements for federal projects will be a significant part of the federal government’s efforts to address climate change. Other states such as Washington, Minnesota, and New York are also considering some version of Buy Clean legislation or implementing pilot programs, and Buy Clean-type

requirements are included in LEED V4.1, being considered for inclusion in standards such as the *International Green Construction Code*, and increasingly showing up in the specifications of private sector design firms. All of these programs directly impact which mills structural steel can be purchased from for use in a project covered by the Buy Clean requirements.

So what is Buy Clean? In its most basic form, Buy Clean requires that the embodied carbon, measured in tons of carbon dioxide equivalent per ton of steel, associated with the production of structural steel does not exceed a prescribed threshold set by the jurisdiction or project owner.

So what is embodied carbon? It is *not* the amount of elemental carbon contained in the steel product. Rather, it is the amount of greenhouse gases released into the atmosphere as a result of the production of the product. This includes CO₂, methane, and any other greenhouse gases released in the generation of the electricity used to produce the product or in the production of other products or materials used in the manufacture of the final product. In common use, embodied carbon impacts may also be referred to as CO₂ equivalents (CO₂eq) or global warming potential (GWP) associated with a specified time horizon (typically 100 years) over which their impact on the global warming of the earth is calculated.

Embodied carbon for a product is reported in an environmental product declaration (EPD) published either by a producer as a product-specific EPD or by an industry association as an industry-wide EPD. The domestic structural steel industry leads all other framing material industries in the percentage of products for which EPDs have been published, testifying to the commitment of the industry to environmental transparency and progress in reducing greenhouse gases. Facility-specific EPDs have been published for roughly 95% of U.S. structural steel production, and you can find links to structural steel EPDs at aisc.org/epd.

Why Buy Clean?

The goal of a Buy Clean program is not to determine what material should be used in the design of the project but rather to require that the materials procured for use in the project are from producers with the lowest embodied carbon impacts for those products. In other words, Buy Clean is about procurement, not design.

California was the first state to pass Buy Clean legislation. AISC and the Steel Tube Institute (STI) worked closely with

the Department of General Services to educate staff and provide background information on the embodied carbon of structural steel products. The California program went into full effect on July 1, 2022, with thresholds being established for hot-rolled structural sections, hollow structural sections (HSS), and structural plate used on state-funded construction projects. While some exceptions exist, nearly all State of California projects are subject to the Buy Clean California. In addition, a number of additional jurisdictions in California (including Los Angeles) have adopted the same Buy Clean requirements.

In order to educate the structural steel supply chain, architects, structural engineers, and state agency staff, AISC, STI, the American Iron and Steel Institute (AISI), and the Concrete Reinforcing Steel Institute (CRSI) developed *A Quick Guide to Buy Clean California's Steel Provisions* (available at aisc.org/quickguide_buycleancali2022.pdf), which summarizes the California requirements and provides an interpretation of the prescribed thresholds.

After the enactment of the California legislation, other states and jurisdictions began considering Buy Clean requirements, and it quickly became apparent that there was a lack of consistency in terms of the programs being proposed. Different materials were included, different definitions were being used, different methodologies were proposed, and, most concerning, different thresholds were being considered for the same product in different jurisdictions.

To address this challenge AISC, representing the structural steel industry and in consultation with industry members and embodied carbon professionals, developed *Buy Clean Guidance for Structural Steel Products* for use in the development of Buy Clean programs and specifications. You can download it at aisc.org/buy-clean-guidance.

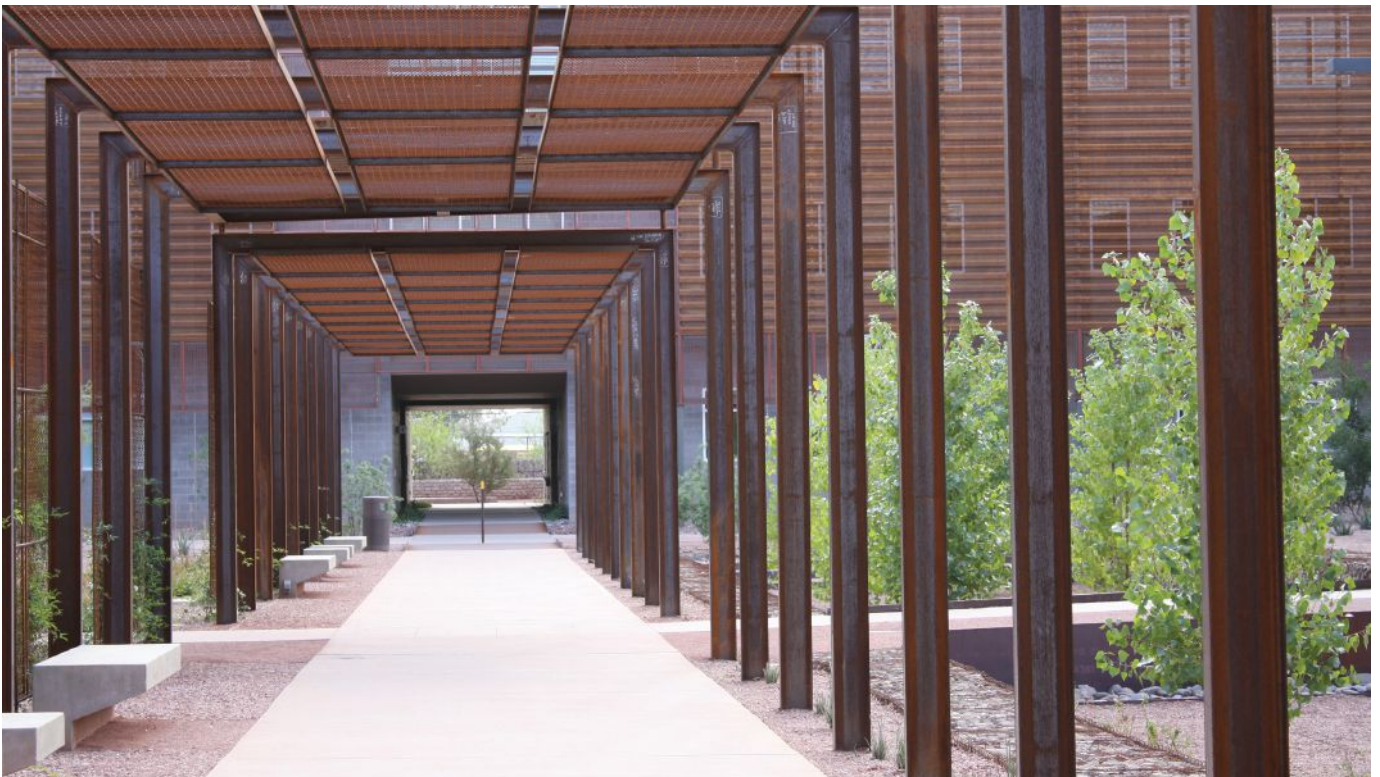



In summary, the suggestions being made by the structural steel industry are:

- **Recognize that many products are made from steel, but only some are structural steel.** Buy Clean programs should specify structural steel, which is defined by the AISC *Code of Standard Practice for Structural Steel Buildings and Bridges* (ANSI/AISC 303-22, [aisc.org/specifications](https://www.aisc.org/specifications)) and, by reference, the *International Building Code*, as specific products (hot-rolled sections, HSS, and structural plate) essential to support the design loads of a structure. Other steel products or applications are not included in Buy Clean requirements. A list of specific structural steel applications appears in Sections 2.1 and 2.2 of the *Code*.
- **Distinguish between the three major product types of structural steel.** Initial Buy Clean legislation lumped all structural steel products together and did not recognize that hot-rolled structural sections, HSS, and structural plate are distinct products with different levels of embodied carbon. A separate embodied carbon threshold must be established for each product.
- **Focus requirements on high-impact areas.** EPDs submitted under LEED requirements must be for the product as delivered to the project site, so published structural steel EPDs typically include fabrication—yet the embodied carbon associated with fabrication is less than 10% of the total embodied carbon of the final fabricated structural steel product. It should also be recognized that the level of embodied carbon contributed by fabrication is not under the direct control of the fabricator but rather is a function of the project type and design specifications. Even if a difference in fabrication operations resulted in a 20% variance in embodied carbon, only a 2% variance would result in the total embodied carbon of the fabricated structural steel product. At the same time, a 20% variance in the embodied carbon of the unfabricated structural steel would result in a much more significant difference of 18% in the final product. Buy Clean programs should either set thresholds based only on mill material, on fabricated mill material based on industry average fabrication impacts, or both.
- **Include all relevant materials.** Buy Clean California includes only four materials: structural steel, reinforcing bar, flat plate glass, and mineral wool board insulation. Missing (the result of much lobbying) are other structural framing materials, including concrete, wood, mass timber, and masonry. Yet the principles behind Buy Clean programs apply equally to all materials used for a similar purpose in the construction of a building. If one structural framing material is included, then *all* structural framing materials should be included. Not including all framing materials is not only discriminatory to those included but also neglects the significant reduction in embodied carbon that could occur if all materials were treated consistently.
- **Enable consistent comparisons.** If any meaningful comparison between a producer's EPD and a Buy Clean threshold is to be made, then the scope of the threshold and the EPD must be identical. The scope for calculating the embodied carbon associated with the product should either be for manufacturing processes up to the time the product leaves the mill (cradle-to-mill gate) or leaves the fabricator (cradle-to-fabricator gate) using the industry-average fabricator impacts. Calculations should be consistent with the methodology specified in Underwriters Laboratories' *Product Category Rule for Steel Construction Products* (www.shopulstandards.com), which was developed through a consensus process with input from representatives of various steel industry entities and is updated every five years.
- **Use verified industry-wide values as the basis of thresholds.** The initial plan in several Buy Clean programs was to collect the available EPDs from various producers of the specified product, stack them up, pull out the one in the middle, and use the embodied carbon value of that product as the specified threshold. The thought was that half of the industry would comply and half would not. But that approach doesn't work. High embodied carbon producers typically don't publish EPDs, and foreign producers do not use the



same methodology for calculating embodied carbon. AISC and other industry organizations publish industry-wide EPDs that report industry average embodied carbon impacts based on production-weighted averages and a methodology consistent with the methodology used by the individual producers in publishing their product-specific EPDs. It is those industry-wide averages that should be used as the basis of the specified thresholds and against which foreign products should be measured when using the same methodology.

- **Increase thresholds above industry-wide values.** An EPD is valid for five years. The calculation of embodied carbon impacts uses a specified methodology, data collection procedures, and background data for energy and materials used in the production process. Market conditions present during the period upon which the analysis is based, such as mill utilization rates, will impact the results. During that five-year period, the methodology, data collection processes, background datasets, and market conditions will change, making the comparison of the embodied carbon results reported in different producer EPDs difficult at best. For that reason, as well as the consideration of imported material not included in domestic industry-wide calculations, thresholds should include an uncertainty factor of 25% to avoid penalizing producers with older EPDs who would fall beneath the threshold if their EPDs had been updated at the same time as the industry-wide average. Regions experiencing a high level of imports may consider using an industry-wide GWP value based on a published global average. However, care must be taken to ensure that any EPD results compared to the global industry average are based on the same scope and product category rule (PCR) methodology as the global average.
- **Recognize renewable energy penetration.** One of the biggest challenges facing steel producers is that current rules regarding the calculation of embodied carbon impacts for their products do not receive credit for purchases of renewable energy (wind, solar, hydro) when that power is delivered through the regional electric grid. Only renewable energy produced on the mill site or brought to the site using

dedicated transmission lines is considered. Mills should be allowed to take credit for their investments in renewable energy and receive credit for them in the calculation of their embodied carbon impacts.

The procurement of structural steel products and other framing materials based on the embodied carbon of a specific producer's product will increasingly become a reality in the marketplace as increasing emphasis is placed on reducing both the operational and embodied carbon of buildings. The structural steel industry is committed to that process and looks forward to other framing materials exhibiting the same level of commitment and transparency to accomplish the goals of Buy Clean programs. ■

This article serves as a preview of the 2023 NASCC: The Steel Conference session "Sustainability and Steel: Buy Clean Laws and EPDs." To learn more about this session and others, as well as to register for the conference, visit aisc.org/nascc. The conference takes place April 12–14 in Charlotte, N.C.



Max Puchtel
(puchtel@aisc.org) is AISC's director of government relations and sustainability, and **John Cross** (crosswind.consult@gmail.com) is principal of Crosswind Consulting, LLC, and AISC's former vice president of market development.



Upward Expansion

BY PAT HASSETT, SE, AND JAMES ACEVEDO

The host building for last year's NASCC: The Steel Conference, the Colorado Convention Center, provides an erection engineering lesson at this year's conference.

EXPANSION PROJECTS OFTEN serve as testaments to the adaptability of structural steel framing systems.

The expansion of the Colorado Convention Center in downtown Denver was designed to be an addition of a new “multi-function” space, an adjoining terrace, and a massive kitchen space above the roof on the northwest corner of the existing structure.

The existing roof framing consisted of a joist and truss girder system with 90-ft-wide bays supported by 36-in.-diameter unfilled pipe columns designed only for code-level snow and live loads. For the expansion, structural engineer of record Martin and Martin specified these columns to be filled with concrete to support the new multi-function roof and floor, which was framed by extending the columns and adding steel trusses above the existing roof. Additionally, new wide-flange framing spanning from column to column over the adjacent precast parking garage created a new terrace space to the north of the new multi-function floor.

The only way to accomplish such a project would require the teamwork and cooperation of Martin and Martin, general contractor Hensel Phelps, AISC member steel fabricator W&W/AFCO

Steel, AISC member erector Derr and Greunewald Construction Company, and erection engineer Hassett Engineering to solve the logistical challenges of erecting the heavy trusses on a large footprint over the existing structure.

The combined extent of the two tower cranes covered about two-thirds of the project. Those tower crane capacities and radii would be sufficient to build the terrace but were not able, and were not intended to be able, to meet the demands required to lift the new trusses in the multi-function and kitchen bays south of the terrace. After multiple iterations and consideration of other rigs, Derr and Greunewald used an LR1300 crawler crane with 272 ft of main boom to erect the floor and roof framing for these spaces. After all the truss redesign iterations to support this crane, the team determined that the maximum pick would be approximately 75 tons, and the maximum radius was 120 ft, which required a counterweight derrick and tray weighing approximately 126 tons. Booming out the 272-ft boom enabled the counterweight tray to be disconnected, lifted, and set aside after setting a heavy truss. The entire weight of this crane configuration was approximately 500 tons.

So how can a 500-ton crane crawl over an existing roof structure? At each bay, the LR1300 crane was used to build the new floor above the existing roof, designed to be capable of supporting the crane itself. After completion of steel erection and slab placement of each successive bay in the crane path, the crane would roll onto the newly constructed bay and continue erecting adjacent bays.

The original concept was to use a pair of 90-ft grillages, one beneath each crawler track, that spanned between column line trusses. But that grillage added significant weight, which would have required heavier trusses to support it. In order to eliminate that additional weight, Hassett Engineering proposed to shift the location and strengthen the design of the infill trusses. The infill trusses would then support the crawler tracks directly. Furthermore, the elimination of the grillages saved valuable time that would have been necessary to “leapfrog” those grillages before and after each crane movement to adjacent bays.

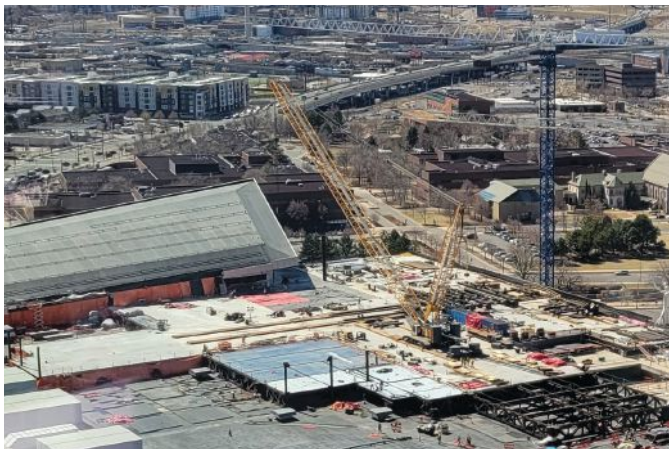



Of course, heavier trusses were required for crane loading. Hassett Engineering’s team continued working on design iterations to support the crane without grillages. Increasing the supporting truss weights resulted in more counterweight needed for the crane, and the iterations produced increasingly heavy trusses. Additionally, the no-grillage scheme increased the demands on the bridging trusses at the one-third points of the spans because they were acting continuously, transferring moments across the bridging truss/infill truss intersections. These trusses were redesigned for the increased demands. Ultimately, this two-way truss action resulted in lighter column line and infill trusses with overall truss weights more balanced.

The tower cranes were used to hoist the truckloads of steel off the street and build the trusses on the terrace. The challenge was transporting the trusses to the crawler crane. Clearly, it was not desirable to crawl the massive LR1300 over multiple bays to reach each truss. Instead, the trusses were built on a frame, which, in turn, rested on Hilman rollers that rolled on wide-flange tracks that were aligned with the crane crawler path. A tugger was then used to pull the trusses south to the crawler crane.

In order to clearly illustrate the process, Hassett created and distributed 3D color-coded erection procedure drawings to communicate the steps and stabilization required for each significant stage of erection. Hassett also produced crane position drawings for each significant pick to convey to the field crews and crane operator the foreseen loading for which the structure was designed. The teamwork and cooperation of all parties enabled the successful erection of the structure.

Want to learn more about this project? Come to NASCC: The Steel Conference! ■

This article serves as a preview of the 2023 NASCC: The Steel Conference session “Challenges Erecting a New Level atop an Existing Convention Center.” To learn more about this session and others, as well as to register for the conference, aisc.org/nascc. The conference takes place April 12–14 in Charlotte, N.C.



Pat Hassett

(pat@hassettengineering.com)

is president and **James Acevedo**

(james@hassettengineering.com) is

a project engineer, both with Hassett Engineering, Inc.

new products

This month's New Products section focuses on software for structural framing and connection design and includes two combination modeling-analysis programs and a package that can save loads of time on connection design.

Dbulal Software RFEM 6

RFEM 6, along with the Steel Design add-on, is a nonlinear finite element analysis (FEA) program that combines steel analysis and design into a single workflow.

Design properties like effective lengths can easily be assigned, with the detection of nodes along the member length. The assigned intermediate restraints are then graphically displayed on the member for clarity, and the same effective-length conditions can be applied to multiple members at once. The detailed output includes all factors, formulas, and references directly from the *AISC Specification for Structural Steel Buildings* (ANSI/AISC 360) used in the calculation, and the results can be efficiently and easily followed for transparency while eliminating the guesswork for users. Additionally, seismic member design according to the *AISC Seismic Provisions for Structural Steel Buildings* (ANSI/AISC 341) will soon be released. Requirement checks include member ductility, stability bracing of beams, and slenderness ratios, along with connection design forces. For more information, visit www.dbulal.com.

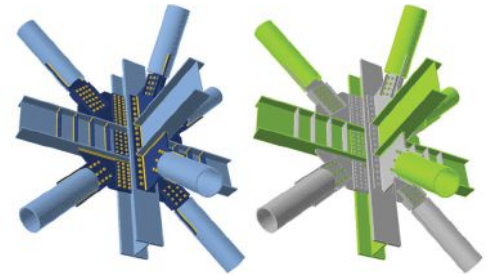
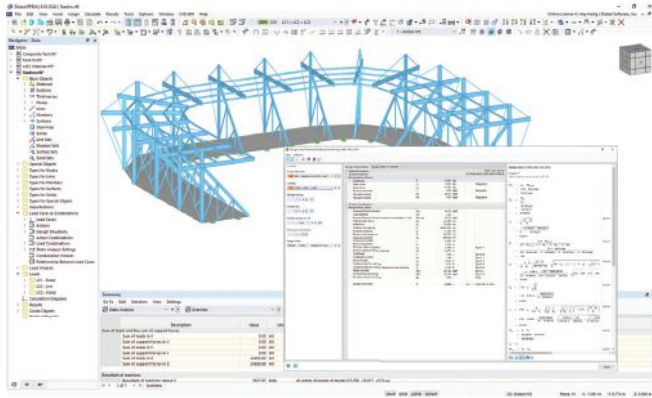

IDEA StatiCa

IDEA StatiCa connection design software provides clear pass/fail checks per the *AISC Code of Standard Practice for Steel Buildings and Bridges* (ANSI/AISC 303) in minutes. It can save up to 80% of your connection design time thanks to its huge database of connection templates (including HSS connections and steel-to-timber); quick modeling and design of any bolted and/or welded connections; AISC checks, including buckling, stiffness analysis, design resistance, and seismic; and fully customizable reports with equations and pictures to document the connection and results. In the last year, the developer has made significant improvements, including a link to RAM Structural System, the addition of a connection browser to save user templates, lateral torsional restraint, and fire design of steel connections. Design any type of steel connection from scratch or import it from your analysis or detailing software and visualize the connection behavior. For more information, visit www.ideastatica.com.



Graitec Advance Design

Graitec Advance Design integrates modeling and analysis into a modern and easy-to-use interface to optimize steel design, meeting the highest

industry standards, increasing user productivity, and creating smoother workflows. Its BIM interoperability and synchronization with Autodesk Advance Steel allow steel designers and detailers to easily export/import their Advance Steel models, helping them apply loads, do code checks, or optimize the steel sections, even at the preliminary stages of the project before engineers get involved. Once optimized and checked, Advance Design structural models can be synchronized back to Advance Steel using the Graitec BIM connect tool. This way, detailers now have all possible structural design changes automatically applied to their model. For more information, visit www.graitec.com.

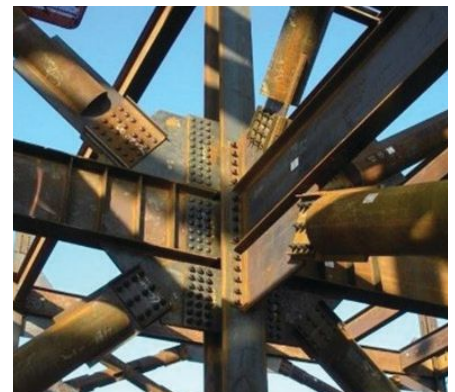

ENGINEERING JOURNAL
 First Quarter 2023 AISC *Engineering Journal*
 Now Available

The first quarter 2023 issue of AISC's *Engineering Journal* is now available. It includes papers on lateral torsional buckling resistance, overstrength of I-shaped shear links, and steel-plate-composite-wall-to-reinforced-concrete-wall mechanical connections. To access this issue and all past issues of *Engineering Journal*, visit aisc.org/ej.

Experimental Evaluation on Lateral Torsional Buckling Resistance of Continuous Steel Stringers

C. Shawn Sun, Daniel G. Linzell, Jay A. Puckett, and Ahmed Rageh

An extensive experimental study evaluated lateral torsional buckling resistance of two-span continuous steel beams in a test assembly that included three beam lines, an interior transverse support (floor beam), and transverse diaphragms at the end supports. Funded by the Louisiana Transportation Research Center (LTRC), this study was conducted to better understand continuous stringer behavior so that simplified analyses would better capture their lateral torsional buckling (LTB) behavior. Current practice produces Louisiana Department of Transportation and Development (LA DOTD) bridge ratings often conservatively controlled by stringer LTB capacity and, in many cases, necessitates posting, thereby imposing significant and often unnecessary operational restrictions. Forty-seven elastic tests were completed. The tests encompassed a variety of unbraced lengths and support conditions with steel diaphragms or timber ties acting as bracing members. The interior beam in the test assembly was loaded orthogonal to its strong axis at the middle of one or both spans using a spreader beam that minimized restraint and prevented the development of follower forces. Tests demonstrated that minimal bracing could significantly increase lateral torsional buckling resistance and justify a higher LTB resistance than what is currently used.

Overstrength of I-Shaped Shear Links for EBF Design

Hyoung-Bo Sim, Xiao-Jun Fang, and Chia-Ming Uang

Past experimental research on EBFs indicated that the link overstrength, particularly for short (i.e., shear) links, could be much higher than that specified in the AISC *Seismic Provisions*, thus potentially leading to the

unsafe design of beams, columns, and gusset connections per the capacity design requirements. This study aims to identify key factors contributing to the high overstrength and to derive an expression to predict the overstrength of short links. Available experimental data were first collected, and the main parameters affecting the overstrength were identified from the database and used for a multivariate regression analysis. It was found that the following two parameters affect the link overstrength the most: (1) the F_u/F_y ratio between the actual tensile strength and yield stress and (2) K_w , a factor that represents the contribution of localized bending of link flanges. The link length, to a lesser extent, also affects the overstrength. A predictive overstrength equation based on these three parameters was proposed for capacity design of EBF with short links.

Steel-Plate Composite Wall to Reinforced Concrete Wall Mechanical Connection—Part 2: In-Plane and Out-of-Plane Shear

Hassan S. Anwar, Jungil Seo, Amit Varma, and Yoonbo Nam

In safety-related nuclear facilities, steel-plate composite (SC) walls are often used in combination with reinforced concrete (RC) walls or foundations. The design demands need to be transferred between the two different structural systems through appropriate connection design. A design procedure was developed by the authors, and it was evaluated by conducting two full-scale tests for SC wall-to-RC wall mechanical connections subjected to out-of-plane flexure. This paper presents a brief description of the design procedure as well as the experimental and numerical investigations conducted to further evaluate the design procedure. The focus was on the performance, strength, and governing failure mode of SC wall-to-RC wall mechanical connection under in-plane and out-of-plane shear. The investigation results include global force-displacement and applied force-strain responses. The paper also presents overall damage progression in terms of concrete cracking patterns. The experimentally observed and numerically predicted results indicate that the proposed connection design procedure is suitable and conservative for SC wall-to-RC wall mechanical connections.

People & Companies

North American industrial steel pipe and tube manufacturer **Zekelman Industries** recently completed its acquisition of **EXLTUBE** from **SPS Companies, Inc.** Headquartered in North Kansas City, Mo., EXLTUBE manufactures hollow structural sections (HSS), mechanical tubing, standard pipe, and specialty products. With three Kansas City-area mills and more than 530,000 sq. ft of manufacturing and warehouse space, EXLTUBE complements and strengthens the products and manufacturing capabilities offered by the Zekelman family of companies. Zekelman is the largest independent manufacturer of HSS and steel pipe in North America, as well as its top producer of electrical conduit and elbows, couplings, and nipples. In addition to EXLTUBE, Zekelman's companies include AISC member **Atlas Tube**, plus **Picoma**, **Sharon Tube**, **Wheatland Tube**, **Western Tube**, and **Z Modular**.

The **American Iron and Steel Institute (AISI)** recently presented Market Development Achievement Awards to **Richard (Rick) Haws, PE**, engineer, **RBH Consulting, LLC**, and **David Stoddard**, senior applications engineer at **SSAB Americas**, and the Market Development Industry Leadership Award to **Dajun Zhou, PhD**, manufacturing specialist, **Stellantis North America**. The awards were presented by **Leon Topalian**, president and CEO of **Nucor** and chairman of AISI, during AISI's General Meeting at the InterContinental Hotel—The Wharf in Washington, D.C. The market development awards were established in 2007 to recognize individuals who have made significant contributions to advancing the competitive use of steel in the marketplace.

NASCC

AISC To Honor 13 Outstanding Designers, Industry Professionals, and Educators



AISC will present some of its most prestigious awards to 13 remarkable people at the 2023 NASCC: The Steel Conference.

“This is a time of extraordinary innovation in design and construction with structural steel,” said AISC President Charles J. Carter, SE, PE, PhD. “It’s always a pleasure to recognize the exceptional people who have driven our industry to where it stands today—and who continue to ensure a bright future.”

Lifetime Achievement Award

AISC’s lifetime achievement awards recognize living individuals who have made a difference in the success of AISC and the structural steel industry.

Terri Meyer Boake

Professor, University of Waterloo
for her significant contributions to AESS (architecturally exposed structural steel) and architectural education, as well as her service to AISC

Terri Meyer Boake, LEED AP, is a full professor at the School of Architecture at the University of Waterloo in Canada. She has been teaching building construction, structures, environmental design, and film since 1986. She works with the Canadian Institute of Steel Construction (CISC), the Association of Collegiate Schools of Architecture, and AISC to develop teaching resources for architectural education, specializing in AESS. She has published several books about various aspects of steel design and won a 2015 Special Achievement Award for *Understanding Steel Design: An Architectural Design Manual*.

Robert J. Connor, PE

Jack and Kay Hockema Professor of Civil Engineering at Purdue University Lyles School of Civil Engineering
for his significant contributions over many

years to the advancement of design in the area of fatigue, fracture, and other performance and durability issues related to steel bridges, as well as his service to AISC and the National Steel Bridge Alliance (NSBA)

Robert J. Connor is the Jack and Kay Hockema Professor of Civil Engineering and is the director of the Steel Bridge Research, Inspection, Training, and Engineering Center at Purdue University. Connor has been working in the area of fatigue, fracture, and other performance and durability issues related to steel bridges for over 25 years. Connor’s research interests include fatigue and fracture of steel structures; field testing and remote monitoring of structures; bridge inspection reliability; and risk-based inspection methods. He won AISC’s 2018 T.R. Higgins Lectureship Award and a 2012 Special Achievement Award.

Connor is a member of the AISC Committee on Research, the NSBA Technical Committee, AISC’s Technical Committee 10 (Materials, Fabrication, and Erection), and several AASHTO/NSBA Collaboration task groups.

Mark V. Holland, PE

Chief Engineer, Paxton and Vierling Steel Co.
for his work as one of the preeminent fabrication engineers in the world, as well as his contributions to AISC and the steel industry through his service on committees, his speaking engagements, and his many articles and papers

Mark Holland is a registered professional engineer in nine states. From 1986 to 2013, he was responsible for connection design, material procurement, detailing, shop scheduling, project management, and change order management. From 2013 to the present, he has been mentoring the next generation of steel fabricators. Holland is a regular speaker at NASCC: The Steel Conference, as

well as several other industry events on subjects related to fabricated structural steel and connection design.

Holland chairs AISC’s Committee on Manuals and Committee on Structural Stainless Steel and serves on several other AISC committees, subcommittees, and technical committees. He also served as a judge for the 2021 IDEAS² Awards.

Larry S. Muir, PE

for his work as one of the preeminent fabrication engineers in the world, as well as his contributions to AISC and the steel industry through his service on committees, his speaking engagements, and his many articles and papers

Larry Muir is a licensed engineer with more than two decades of engineering and structural steel fabrication experience. He served as the director of technical assistance at AISC for five years, where he led the operations of the technical aspects of the AISC Steel Solutions Center. Prior to that, as chief engineer of Cives Steel Company, he oversaw connection design for six steel fabrication plants with a combined annual capacity of over 100,000 tons. Muir has participated in the design of numerous large-scale, high-profile projects, including high-rises, stadiums, and power plants. He co-authored (with Bill Thornton) AISC Design Guide 29: *Vertical Bracing Connections—Analysis and Design*.

Muir sits on AISC’s Committee on Specifications and Technical Committee 1 (Coordination) and chairs AISC’s Technical Committee 6 (Connection Design).

Francesco Russo, PE, PhD

Founder and President, Russo Structural Services
for his work advancing the state-of-the-art in the analysis and design of complex bridge engineering, bridge inspection, forensics, the



inspection/emergency rehabilitation of complex bridge structures, and bridge education—as well as his dedicated service to NSBA

With nearly 30 years of experience in bridge engineering, and having provided engineering services in over 35 states, Frank Russo has wide-ranging experience providing complex project support, including major steel bridge design and rehabilitation. He is a trusted advisor to owners and clients nationwide. His experience includes developing training courses and materials in areas such as steel bridge analysis and design, bridge load rating, engineering for stability during construction, and fatigue and fracture for steel bridges.

Russo is a member of the NSBA Technical Committee, the NSBA Redundancy Task Force, and several AASHTO/NSBA Collaboration task groups. He is vice-chair of AASHTO/NSBA TG 13: Analysis of Steel Bridges. He served as a judge for the 2020 Prize Bridge Awards.

Clifford Schwinger, PE

Senior Structural Engineer,
The Harman Group

for his contributions to the development of the AISC Steel Construction Manual and his work to advance the understanding of high-quality structural steel engineering drawings, delegated connection design, and quality assurance—as well as his dedicated service to AISC

Cliff Schwinger, PE, has more than 40 years of experience in structural design and is a renowned quality assurance expert. He joined The Harman Group, now IMEG, in 1986. He served as the full-time quality assurance manager between 2002 and IMEG's 2022 acquisition of The Harman Group and continues to perform structural engineering quality assurance reviews on many of the firm's projects prior to the completion of design.

He establishes office standards for design and documentation of designs; develops, maintains, and updates a library of more than 1,000 typical details; answers technical questions; and trains new engineers.

He serves on the AISC Committee on Manuals and chairs Subcommittee M1 (Member & System Design Considerations).

Robert J. Wills, PE

Vice President of Construction,
American Iron and Steel Institute
for his long and illustrious career in the steel industry, including his work on codes and standards and construction market activities

Robert J. Wills, PE, is responsible for overseeing AISI's Construction Market programs in commercial buildings, residential construction, and the transportation/infrastructure markets, as well as the AISI Construction Technical Program. He became vice president of construction market development in 2008 following 18 years of service with the AISI Code and Standards program, during which he was responsible for design specifications, test methods, product specifications, and installation standards related to steel in construction. He is widely recognized for his expertise in fire safety engineering; structural fire testing and performance; wind engineering; and geotechnical and foundation engineering. He was very involved in the development of the *International Building Code* and the NFPA 5000 *Building Construction and Safety Code*.

Wills is a member of the NSBA Market Development Committee.

Special Achievement Award

AISC will honor additional two people with Special Achievement Awards, which provide special recognition to individuals (industry members, designers, or educators)

who have demonstrated notable singular or multiple achievements in structural steel design, construction, research, or education:

Patrick M. Hassett, SE

President, Hassett Engineering, Inc.
for advancing the state of the art in erection engineering on projects ranging from the Walt Disney Concert Hall to Micron's Giga Factory

Patrick Hassett, SE, MS, has been involved in steel design and construction engineering since 1985. He founded Hassett Engineering in 1995 and has worked on major projects for some of the largest steel fabricators and erectors in the country, focusing on steel erection engineering, value engineering, connection design, temporary framing, and systems design for constructing special and unusual projects.

Hassett is a member of AISC's Committee on Specifications and Technical Committee 6 (Connection Design).

Ronald J. Janowiak, SE, PE

retired from Exelon
for leading the adoption of the Specification for Safety-Related Steel Structures for Nuclear Facilities (ANSI/AISC N690-18) by the U.S. Nuclear Regulatory Commission

Ron Janowiak currently works as a consultant, having retired recently after 28 years with Constellation Energy (formerly Exelon Nuclear).

He has over 40 years of engineering experience, devoting most of that time to nuclear power plants in the U.S.

Janowiak has served as chair of AISC Technical Committee 11 (Nuclear Design) since 2008 and is a member of AISC's Committee on Specifications and Technical Committee 1 (Coordination).

winner continue >>

NASCC

AISC To Honor 13 Outstanding Designers, Industry Professionals, and Educators

Terry Peshia Early Career Faculty Award

AISC also recognizes those who build a brighter future by supporting tomorrow's leaders. This year, AISC will present two Terry Peshia Early Career Faculty Awards, which recognize individuals who are on a tenure track or have received tenure within the last three years and who demonstrate promise in the areas of structural steel research, teaching, and/or other contributions to the structural steel industry:



Hannah Blum, PhD

Assistant Professor and Alain H. Peyrot Fellow in Structural Engineering, University of Wisconsin-Madison

Hannah Blum's research encompasses a wide range of topics, including the design and analysis of steel and stainless-steel members and systems; steel joists; structural stability; structural reliability; data-driven design approaches in structural engineering; mixed reality in structural steel fabrication; and virtual and augmented realities in structural engineering education. Her research work aims to improve and inform design specifications to produce resilient and efficient infrastructure.

Thomas Gernay, PhD

Assistant Professor, Johns Hopkins University

Thomas Gernay's research focuses on the development of performance-based design and risk assessment methods for enhancing the resilience of structures subjected to fire. His research aims to positively and profoundly impact the industry through new knowledge on the response of steel material and structures at elevated temperatures, new structural fire design methods that are proposed in building codes committees, and developing software to enable simulation of the behavior of steel structures subjected to fire.



Robert P. Stupp Award for Leadership Excellence

AISC will also present its highest industry honor, the Robert P. Stupp Award for Leadership Excellence, to **David Zalesne**, president of Owen Steel Company and a former chair of the AISC Board of Directors.

Zalesne is only the 10th Stupp Award winner since the program's inception in 1998. The award is named for the late Robert P. Stupp, president of Stupp Bros. Bridge and Iron Co. in St. Louis, who won the inaugural prize.

Zalesne has served on the AISC Board for more than a decade. He has also served as chair of its Government Relations Committee and Education Foundation Board, and as a vice chair of the Industry Trade Advisory Committee on Steel (ITAC 11) under the Office of the U.S. Trade Representative and the U.S. Department of Commerce.

He has testified on behalf of the domestic structural steel industry in connection with tariff investigations under sections 232 and 301, a trade case hearing on Fabricated Structural Steel before the International Trade Commission, and the bipartisan Congressional Steel Caucus.

Prior to becoming president of Owen Steel Company in 2004, he practiced law as a partner in the Litigation Department of Klehr, Harrison in Philadelphia and worked as an assistant U.S. attorney in the Eastern District of Pennsylvania.



Geerhard Haaijer Award for Excellence in Education

AISC will also present its highest education honor, the Geerhard Haaijer Award for Excellence in Education, to **Michael Engelhardt, PE, PhD**, of the University of Texas at Austin, in recognition of his profound impact on the structural steel design and construction industries.

Engelhardt boasts a formidable portfolio of groundbreaking research.

The Haaijer Award is AISC's highest honor for educators, and Engelhardt will be just the eighth recipient since the award's establishment in 1999. He also won an AISC Lifetime Achievement Award in 2015.

Engelhardt is perhaps best known for his research into seismic performance and design of steel structures following the Northridge earthquake in 1994. In the five years following the earthquake, he conducted more than 60 large-scale structural tests of connections for seismic force-resisting systems, which ultimately led to the development of the reduced beam section connections used in special moment-resisting frames—one of the first modern moment connections developed after Northridge. That research earned him the 1999 T.R. Higgins Lectureship Award.

He also made substantial contributions to the development and adoption of eccentrically braced frames for use as a seismic force-resisting system—an accomplishment that garnered a 2008 AISC Special Achievement Award.

But his seismic research breakthroughs are only part of the story. Engelhardt's recent research has broadened our understanding of how the properties of structural steel change during a fire, and other projects have driven innovations in the design and construction of skewed and curved steel bridges.

Engelhardt has served as a member of the AISC Committee on Specifications, AISC Task Committee (TC) 9 on Seismic Systems, the AISC Connection Prequalification Review Panel, and AISC TC 8 (Design for Fire Conditions).

All of the award presentations will take place on April 12, 2023, during the opening session of NASCC: The Steel Conference in Charlotte, N.C. Registration for the Steel Conference is now open. Visit aisc.org/nascc for more information and to register.



SMITH-EMERY

Inspection • Testing • Metallurgy

Assuring Structure & Life Safety Since 1904

Non-Destructive Testing

- PAUT
- Visual (CWI, CWB, CSWIP)
- MT
- UT

Owner QA

- Fabrication Oversight
- Specification Review
- Field Inspections
- WPS Reviews

Metallurgical Laboratory
Environmental Laboratory
Firestop Inspection

Supplier Audits

- IAS
- IAPMO
- City of Los Angeles
- Clark County, NV

Contractor QC

- Fabrication Shop NDT, CWI
- Vendor Audits
- QMS Development
- WPS and PQR Testing

Curtain Wall Performance Testing
Concrete Testing
Chemical Laboratory

☎ 1.833.405.0536
 ✉ steel@smithemery.com
 🌐 www.smithemery.com



Structural Engineers

Are you looking for a new and exciting opportunity?

We are a niche recruiter that specializes in matching great structural engineers with unique opportunities that will help you utilize your talents and achieve your goals.

- We are structural engineers by background and enjoy helping other structural engineers find their "Dream Jobs."
- We have over 30 years of experience working with structural engineers.
- We will save you time in your job search and provide additional information and help during the process of finding a new job.
- For Current Openings, please visit our website and select Hot Jobs.
- Please call or email Brian Quinn, PE: 616.546.9420 **Brian.Quinn@FindYourEngineer.com** so we can learn more about your goals and interests. *All inquiries are kept confidential.*

SE Impact by SE Solutions, LLC | www.FindYourEngineer.com

Connect with AISC on
SOCIAL MEDIA

aisc.org/linkedin @AISC

AISCdotORG @AISC

youtube.com/AISCSteelTV

LATE MODEL STRUCTURAL STEEL MACHINES AVAILABLE IMMEDIATELY

- Peddinghaus Peddiwriter PW-1250**, (2) Hypertherm ArcWriter Plasma Torches, 4-Side Marking, Siemens CNC, 2013, #32397
- Controlled Automation DRL-348TC** Drill Line 3-Spd/ With ATC, Hem WF140HM-DC Saw, Conveyor & Transfers, 2009, #32361
- Ficep HP 20 T6** Angle Punch & Shear Line, 8" x 8" x 1", 65' Infeed, 505 Ton Shear, Pegaso CNC, 2018, #32110
- Ficep Gemini HP 25B**, 8' x 20', 15 HP Drill with 8-ATC, HPR260XD Plasma, Ficep Minosse CNC, Downdraft Table, 2014, #32158
- FICEP 1103 DDV Drill**, (3) 22 HP Drill Heads with 6-ATC, 22 HP, 65" Max Length, Ficep Pegaso CNC, Conveyor, 2015, #32160
- Peddinghaus ABCM-1250** Profile Coping Machine, Siemens CNC, 50" Max Beam, (3) Oxy Heads, 2017, #32313
- Peddinghaus** Material Handling, 190' Conveyor, 848 lbs/ft capacity, (5) 40' Quiet Glide Cross Transfers, 2013, #32399
- Controlled Automation Revolution** Beam Coper, 24" x 48" Capacity, 7-Axis Robot, HPR400XD Plasma, 60' Infeed, 2018, #32180



WE ARE ACTIVELY LOOKING FOR USED STRUCTURAL STEEL EQUIPMENT
 CONTACT: Claire@PrestigeEquipment.com

www.PrestigeEquipment.com | (631) 249-5566

To advertise, contact M.J. Mrvica Associates, Inc.: 856.768.9360 | mjmrvica@mrvica.com. Search employment ads online at www.modernsteel.com.

advertiser index

AISC	3 8 67	Peddinghaus	2
Applied Bolting	23	QuickFrames USA	23
Automated Layout Technology	43	SDS2	7
Chicago Metal Rolled Products	insert	SEAA	49
Controlled Automation	51	St. Louis Screw & Bolt	35
IDEA StatiCa	15	Structural Steel Manufacturing	35
Integrated Engineering Software	13	Trimble	11
New Millenium Building Systems	5	Voortman	12
Nucor	back cover		



Photos: Dave Burk © SOM

Out in the Open

THE WEATHER IS RARELY not beautiful in Los Angeles.

And the new Drollinger Family Stage on the Loyola Marymount University campus, located on the city's southwest side, takes full advantage of the near-perpetual warm temperatures and sunny skies.

The versatile 1,600-sq.-ft open-air stage, designed by Skidmore, Owings and Merrill, is fully equipped for theatrical performances, outdoor teaching, film screenings, and myriad other campus and community events. The venue's structural design employs slender steel columns and a roof structure

made of cellular steel beams, and the gently raked steel-clad roof appears as a suspended, dimensionless form, further articulating the minimalist aesthetic of the architecture. Structural steel was provided by AISC member fabricator Plas-Tal Steel Construction.

The cellular beams serve as the gravity system for the stage. Not only does the cellular option result in reduced weight, but it also creates pathways through the beams for the architectural and lighting components. The gravity beams in two directions also work as the diaphragm for the roof system to evenly distribute

the lateral load. The largest roof span is 45 ft with 7.5-ft to 10-ft cantilevers, and the roof system's structural depth is 24 in., including the light grids.

The roof beams' reduced weight also allowed SOM to minimize column sections. These 6-in.-diameter hollow structural sections (HSS)—16 of them—also serve as the stage's lateral load-resisting system. Thanks to the steel-enabled light and open design, the stage is set to take advantage of the warm climate without being obtrusive, highlighting its users and performers that much more. ■

HOW SMART ARE YOUR SPECS?



I want to \$ave green!

No need to choose! Eliminate unnecessary paint and primer on interior steel members to save money and time while reducing your carbon footprint.

I want to go green!

That's right—you don't need to paint or prime steel in structures if it will be in contact with concrete, enclosed in building finishes, or coated with a contact-type fireproofing.

Use both sides of your brain.

Update your specs to save time, money, and the planet.

aisc.org/paint



Smarter. Stronger. Steel.

American Institute of Steel Construction
312.670.2400 | www.aisc.org



AEOS™

SUSTAINABLE HIGH-STRENGTH STRUCTURAL STEEL IDEAL FOR FABRICATORS AND ENGINEERS

When you have a design that features weight challenges or faces a tight schedule, consider the value that Aeos™ can deliver for you and the project.

HIGH-STRENGTH EFFICIENCY

Aeos' high strength-to-weight ratio means reduced tonnage and easier material handling at the fabrication shop and job site, reducing time, weight, and cost. Aeos is available in 50, 65, and 70 ksi.

WELD PREHEAT SAVINGS

Aeos provides substantially reduced preheat requirements, resulting in significant savings in fabrication, field welded connections, and labor and energy costs, compared to ASTM A992.

DOMESTIC & SUSTAINABLE

Aeos is the only domestically produced ASTM A913 structural steel made with more than 90% recycled content, helping the project team meet sustainability goals.



NEW

VIEW THE AEOS WELDING AND
FABRICATION GUIDELINES

nucor.com/aeos-welding

NUCOR®