

# Modern Steel Construction

June 2023



# PEDDIASSEMBLER VS MANUAL

TRIPLE PASS WELD 6.6 TONS OF STEEL



THE  
PEDDIASSEMBLER

**5 HOURS  
59 MINUTES**

- 111 TACKS
- 215 WELDS
- 45 PARTS
- 31 ROTATIONS
- 0 ERRORS



MANUAL FIT & TACK

**13 HOURS  
12 MINUTES**

- 256 TACKS
- 216 WELDS
- 45 PARTS
- 35 ROTATIONS

**WATCH  
HERE**



**Peddinghaus**

**STRONGER** THAN  
STEEL®

www.peddinghaus.com | info@peddinghaus.com | (815) 937-3800

# PARTNERS FROM THE START

The right partners in the building process can make all the difference. Vulcraft custom-fabricated products can help create the specific aesthetic your project needs, whether it's an airplane hangar or a brewery. From steel joists to decking to grating, we're here to work with you to determine the best steel solutions for your next project. That's what good partnerships are all about.

“

The best part of my job is helping customers find the right solution to their unique challenges.

**DREW LAWS**

PROJECT MANAGER ASSISTANT  
Nucor Vulcraft



VULCRAFT.COM

**NUCOR**<sup>®</sup>  
VULCRAFT

# Modern Steel Construction

June 2023

## in every issue

### departments

- 6 EDITOR'S NOTE
- 9 STEEL INTERCHANGE
- 12 STEEL QUIZ
- 62 NEW PRODUCTS
- 63 NEWS & EVENTS
- 66 STRUCTURALLY SOUND

### resources

- 65 ADVERTISER INDEX
- 65 MARKETPLACE & EMPLOYMENT



## features

- 28 First Time's the Charm**  
BY JAMES SAVAGE, SE, PE  
The new Hubbard Center expansion to Omaha's Children's Hospital and Medical Center marks two significant construction firsts for Nebraska while adding much-needed space.
- 36 Building Business**  
BY BLAKE RHOOD, PE, AND JASON SQUITIERE, PE  
West Virginia University's new steel-framed Reynolds Hall is designed to innovate business education in the Mountain State and beyond.
- 44 Southern Exposure**  
BY JUSTIN BARTON, SE, PE  
Exposed steel scores the winning goal as the dominant architectural characteristic at Nashville's Major League Soccer stadium.

## columns

### steelwise

- 16 Thinking Inelastically**  
BY MARK DENAVIT, PE, PhD, AND RON ZIEMIAN, PE, PhD  
Considering inelastic analysis? Here are some recommendations.

### data driven

- 20 Filling the Labor Gap**  
BY BRIAN RAFF  
The shortage of construction trade jobs represents an ongoing struggle that can have a significant negative impact on steel projects, but the solutions are out there—and AISC is making a concerted effort to leverage them.

### field notes

- 22 Living by the Code**  
INTERVIEW BY GEOFF WEISENBERGER  
Extensive work with building codes as they relate to steel construction has been a defining characteristic of Robert Wills' award-winning career.

### business issues

- 24 Mapping Value**  
BY BARRY J. BRUNS  
Value stream mapping has the potential to be a valuable tool for steel fabricators.

- 52 Park Avenue Premiere**  
BY TIM BRADSHAW, PE  
The full-block 425 Park Avenue tower stands tall thanks to a collaborative approach and ASTM A913 Grade 70 steel, a first for the Big Apple.
- 58 Racing to Charlotte**  
BY GEOFF WEISENBERGER, MEGAN ERICKSON, AND KATE DUBY  
This year's NASCC: The Steel Conference was, once again, the biggest ever.

**ON THE COVER:** Omaha's Children's Hospital has a bright future, thanks in part to a stunning light wall on its new addition, p. 28. (Photo: Copyright HDR/Dan Schwalm)

MODERN STEEL CONSTRUCTION (Volume 63, Number 6) ISSN (print) 0026-8445; ISSN (online) 1945-0737. Published monthly by the American Institute of Steel Construction (AISC), 130 E Randolph Street, Suite 2000, Chicago, IL 60601. Single issues \$8.00; 1 year, \$60. Periodicals postage paid at Chicago, IL and at additional mailing offices. Postmaster: Please send address changes to MODERN STEEL CONSTRUCTION, 130 E Randolph Street, Suite 2000, Chicago, IL 60601.

**DISCLAIMER:** AISC does not approve, disapprove, or guarantee the validity or accuracy of any data, claim, or opinion appearing under a byline or obtained or quoted from an acknowledged source. Opinions are those of the writers and AISC is not responsible for any statement made or opinions expressed in MODERN STEEL CONSTRUCTION. All rights reserved. Materials may not be reproduced without written permission, except for noncommercial educational purposes where fewer than 25 photocopies are being reproduced. The AISC and Modern Steel logos are registered trademarks of AISC.



Printed on paper made from a minimum of 10% recycled content.



## FOR YOUR LARGEST PROJECTS, CHOOSE JUMBO HSS.

When it comes to industrial projects like manufacturing facilities, using structural steel with wider spans and high axial load capacities is essential.

Enter Jumbo HSS from Atlas Tube. Our HSS have a high strength-to-weight ratio, which means you can use less steel and lower your embodied carbon. Our products are also the largest domestically made HSS and have frequent rollings, making it even easier to meet your projects' demands.

Go big with Jumbo HSS at [atlastube.com/jumbo](https://atlastube.com/jumbo)

## editor's note



At this point, I think it's fair to say that I've been to a lot of in-person NASCC: The Steel Conferences (15, if I'm counting correctly).

My first one was in 2007. I remember it well. I'd only been at AISC for a few months, I was just beginning to understand how the steel supply chain worked, I was much younger, and it was all just a tad overwhelming.

But it was also fun. And enlightening. And productive. And everyone I encountered—whether they were coworkers, attendees, presenters, or exhibitors—were all friendly and helpful. The fact that I had no prior experience in the industry made many of them that much more eager to teach me what they knew.

At that show, I was tasked with moderating a Friday morning session. I wasn't very knowledgeable about the "big names" in our industry at the time, but the person I introduced was none other than Duane Miller of Lincoln Electric, one of the world's preeminent welding experts (and also a very nice guy). I began to realize that this wasn't just another trade show. Rather, it was and is the conference to attend for anyone touching any part of the American structural steel industry.

I've grown a lot since then. I've also gotten to know who (most of) the big names in our industry are—and I even interviewed around a dozen of them at this year's conference in Charlotte, an experience that was not only incredibly insightful but also lots of fun. Many of them were AISC Lifetime Achievement or Special Achievement Award winners, which means they're not just really good at what they do but actually the *best* at what they do.

The Steel Conference has grown, too—to the tune of 6,000 in-person attendees at this year's show in Charlotte! I've been here long enough to see us hit the 4,000-person threshold, then 5,000, and now 6,000.

(OK, the official tally was 5,972, but I am unofficially rounding that up, especially considering that there were also more than 2,200 online attendees.)

Perhaps the most satisfying and telling sign that I've been here for a long time is that I'm not just recognizing more people, but they're also recognizing me. I've gone from having to introduce myself to everyone I meet to having people stop me in the hall to say hi or thanks for featuring them in an article. It's a good feeling, especially given the company I've been in for the last 16 years or so.

Thanks to everyone who reads and contributes to this magazine and who makes steel construction better in some way! And thanks to everyone who makes the Steel Conference such a success. (Check out a more substantive roundup of this year's conference on page 58.) Let's keep it growing!

Geoff Weisenberger  
Chief Editor

P.S. Speaking of Charlotte, this year's conference dinner took place at the NASCAR Hall of Fame. And yes, that's me in front of Richard Petty's iconic 43/STP stock car. I'm not necessarily a NASCAR enthusiast, but my dad was, and the 43 car was the most recognizable stock car from my youth (I even had an Ertl die-cast version of it), and I went into selfie mode as soon as I saw it.



# Modern Steel Construction

## Editorial Offices

130 E Randolph St, Ste 2000  
Chicago, IL 60601  
312.670.2400

## Editorial Contacts

CHIEF EDITOR  
Geoff Weisenberger  
312.493.7694  
weisenberger@aisc.org

## PUBLISHER

Keith A. Grubb, SE, PE  
312.804.0813  
grubb@aisc.org

## GRAPHIC DESIGN MANAGER

Kristin Hall  
773.636.8543  
hall@aisc.org

## EDITORIAL DIRECTOR

Scott Melnick  
312.804.1535  
melnick@aisc.org

## AISC Officers

### CHAIR

Stephen H. Knitter  
Geiger & Peters, Inc.

### VICE CHAIR

Hugh J. McCaffrey  
Southern New Jersey Steel Co.

### SECRETARY/LEGAL COUNSEL

Edward Seglias, Cohen Seglias  
Pallas Greenhall & Furman, PC

### PRESIDENT

Charles J. Carter, SE, PE, PhD

### SENIOR VICE PRESIDENTS

Scott Melnick  
Mark W. Trimble, PE

### VICE PRESIDENTS

Todd Alwood  
Carly Hurd  
Mike Mospan  
Christopher H. Raebel, SE, PE, PhD  
Brian Raff

## Editorial Advisory Panel

Brandon Chavel, PE, PhD  
Michael Baker International

Nat Killpatrick  
Basden Steel

Christina McCoy, SE  
Oklahoma State University  
School of Architecture

Allison Shenberger, PE  
ruby+associates

Justin Smith, PE  
Dekker Perich Sabatini

## Advertising Sales

M.J. Mrvica Associates, Inc.  
2 W Taunton Avenue  
Berlin, NJ 08009  
856.768.9360  
mjmrvica@mrvica.com

## Address Changes and Subscription Concerns

312.670.2401  
subscriptions@aisc.org

## Reprints

Kristin Hall  
hall@aisc.org



**SDS2**  
BY ALLPLAN

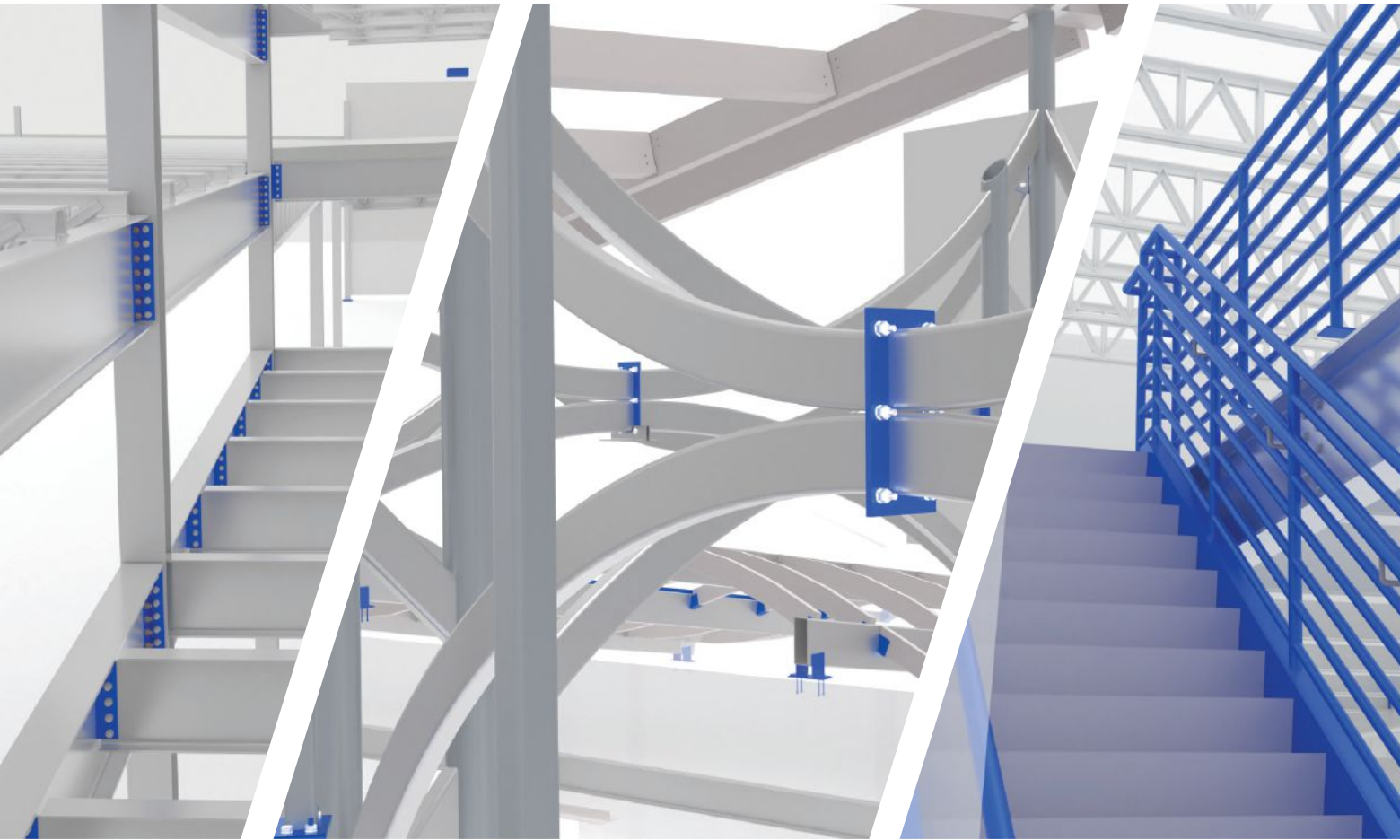

## STEEL DETAILING SOFTWARE DESIGNED TO SAVE YOU TIME

- STRUCTURAL STEEL
- CONNECTION DESIGN
- STAIRS & RAILS
- MISCELLANEOUS STEEL
- MATERIAL HANDLING

REQUEST A  
DEMO TODAY



The images above were created from real customer projects courtesy of Steel Detailing, Inc. (right and left) and Arteras Inc. (center)

# Relax, we've got you covered.

## AISC Continuing Education

Did you know that AISC Continuing Education offers a variety of programs—daytime live webinars, evening courses, virtual conferences, and on-demand content? With all of these options, you're sure to find something to fit your needs. So grab some sunblock and a laptop, and check out what we have to offer!

[aisc.org/continuinged](https://www.aisc.org/continuinged)



**Smarter. Stronger. Steel.**

American Institute of Steel Construction  
312.670.2400 | [www.aisc.org](http://www.aisc.org)



## steel interchange

---

If you've ever asked yourself "Why?" about something related to structural steel design or construction, *Modern Steel's* monthly Steel Interchange is for you!

Send your questions or comments to [solutions@aisc.org](mailto:solutions@aisc.org).

### Oil on Galvanized Nut Threads

**We are supplying galvanized fasteners for an industrial project and have received questions from our client about whether the nuts received the proper lubrication. How can we determine this?**

ASTM A563 states: "Hot-dip and mechanically deposited zinc-coated Grade DH nuts shall be provided with an additional lubricant which shall be clean to the touch." Dye color is often added to make the presence of the lubricant obvious. If the dye is desirable, ASTM A563 Supplementary Requirement S2 can be specified. However, it is common for manufacturers to supply nuts with a contrasting color, most often blue, regardless of whether the supplementary requirement, S2, has been specified.

If the nut is blue, then it has likely been lubricated. If it is not, then you may want to explore the issue further.

Larry Muir, PE

### Stiffener Attachments to Flanges

**I would like to understand why stiffeners on plate girders should not be connected to the tension flange of a girder.**

Historically, there were prohibitions against welding stiffeners to tension flanges. However, these no longer apply.

The 2022 AISC *Specification for Structural Steel Buildings* (ANSI/AISC 360) states, in Section G2.3(b): "Transverse stiffeners are permitted to be stopped short of the tension flange, provided bearing is not needed to transmit a concentrated load or reaction." Note that it says "permitted" and not "required."

Design for Fatigue, Chapter 12, Section 2.4.2.1, of the AISC *Steel Bridge Design Handbook* (a free download at [aisc.org/nsba](http://aisc.org/nsba)) provides additional detail:

"In years past, it was standard practice to cut transverse stiffeners short of the bottom (tension) flange to prohibit welds on the flange transverse to the direction of stress. Experience gained over a number of years has shown that, in fact, the fatigue life of the detail is independent of whether the stiffener terminates in the web or is extended down to the flange. This is reflected in the current AASHTO *LRFD Bridge Design Specifications*. There are also practical reasons for cutting the stiffener short: the stiffener will have to be made to a precise length if it is to extend from flange to flange, although some fabricators prefer fitting or welding the stiffener to the flange to help keep the flange perpendicular to the web. The height of the gap between the end of the stiffener and the girder flange is usually quite small. If lateral movement of the top flange relative to the bottom flange takes place, as might commonly be the

case if these cut-short stiffeners are used to connect cross frames and diaphragms (see Section 2.4.2.3), large strains can occur in the region of the gap between the end of the stiffener and the top of the flange because of the significant change in stiffness between regions of the web. The resulting out-of-plane bending strains in the web can become so large that it may take only a relatively small number of cycles for a crack to propagate. The flange movement could be the consequence of transverse forces in a skewed bridge, but it could even be due to shipping and handling." In addition, see Figure 1, which appears in the *Steel Bridge Design Handbook* and illustrates fatigue cracking from out-of-plane movement.

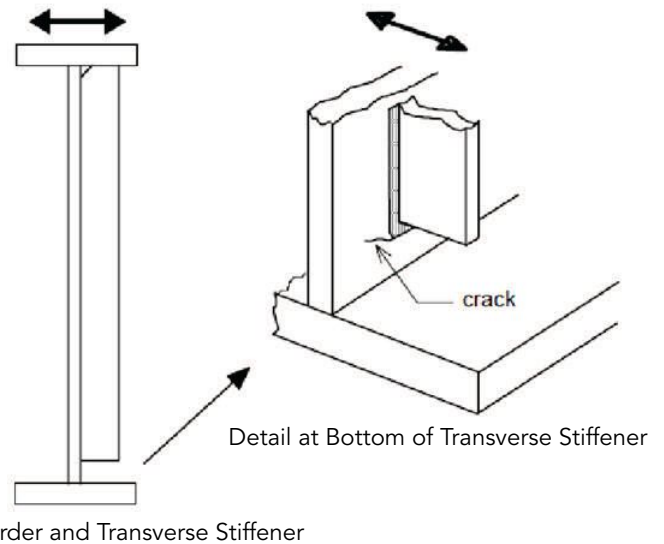

Fig. 1. Fatigue cracking from out-of-plane movement.

Larry Muir, PE

### Who Certifies Steel?

#### Who certifies steel produced in the U.S.?

Most, if not all, steel producers are ISO 9000 certified. ISO 9000 is a set of international standards on quality management and quality assurance developed to help companies effectively document the quality system elements needed to maintain an efficient quality system. ISO 9000 certification requires regular audits and informs customers and partners that the company has a quality management system in place and that processes and deliverables should be consistent. The ISO 9000 certification is very common, and customers may expect or require producers to be ISO 9000

# steel interchange

certified. Producers also typically use accredited A2LA testing labs for testing their product and its conformance to recognized standards, like ASTM.

The AISC *Code of Standard Practice for Steel Buildings and Bridges* (ANSI/AISC 303) sets forth criteria for the trade practices involved in the design and construction of steel buildings, bridges, and other structures and applies to all projects that involve fabricated structural steel. Structural steel is defined in Section 2 of the *Code* and consists of the elements of the structural frame that are shown and sized in the structural design documents, essential to support the design loads, and described in Section 2.1.

Section 5 of the *Code* discusses materials, which can be either mill material (i.e., material ordered directly from the mill by the fabricator, typically for a particular project) or stock material (i.e., material taken from stock by the fabricator).

Section 5.1.1 of the 2022 *Code* covers mill material and states: “Unless otherwise specified by means of special testing requirements in the contract documents, mill testing shall be limited to those tests that are required for the material in the ASTM specifications indicated in the contract documents.”

Section 5.2.1 of the 2022 *Code* covers stock material and states: “If used for structural purposes, materials that are taken from stock by the fabricator shall be of a quality that is at least equal to that required in the ASTM specifications indicated in the contract documents.” Section 5.2.2 states: “Material test reports shall be accepted as a sufficient record of the quality of materials taken from stock by the fabricator.”

There is not one overall governing body that certifies steel, but there are several measures in place that check quality systems both in production and testing.

In addition, AISC certifies steel fabricators and erectors. AISC Certification confirms to owners, the design community, the construction industry, and public officials that certified participants have the personnel, organization, experience, documented procedures, knowledge, equipment, and commitment to quality control and quality assurance. In other words, AISC Certification certifies the process but not the end product. If you are interested in learning more about AISC certification, visit [aisc.org/certification](http://aisc.org/certification).

*Yasmin Chaudhry, PE*

## HSS Branch Wall Slenderness

I had a question about Table K3.2A in the 2022 AISC *Specification*. The limits of applicability indicate that for compression branches of gapped K-, T-, Y-, and cross-connections, the  $B_b/t_b$  and  $H_b/t_b$  cannot exceed

$$1.25 \sqrt{\frac{E}{F_{yb}}} \quad \text{or} \quad 35$$

**I am not sure which of these two limits apply.**

Both limits apply.  $B_b/t_b$  and  $H_b/t_b$  (see an example of a Gapped K connection in Figure 2) must be less than both limits. 35 will only control for branches with lower yield strengths. While this may never be an issue for ASTM A500 or ASTM A1085 HSS, it could be for built-up box members—though even this is probably more of a theoretical concern now that 50-ksi material dominates the industry.

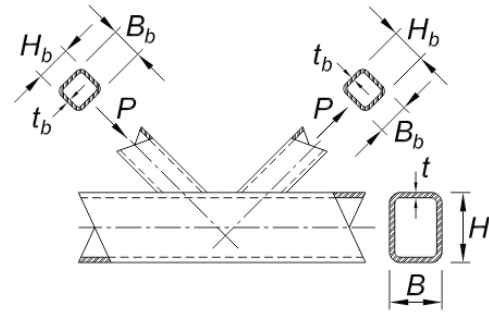

Fig 2. Gapped K connection with one branch in compression

*Larry Muir, PE*

## Flange Plate Buckling Between Intermittent Welds

**I am attaching a flange plate to an existing steel beam flange. I would like to use intermittent welds, but I am concerned about buckling. Can you provide any information on how I could evaluate the new flange plate based on the spacing of the intermittent welds used?**

The flexural strength of beams with flange plate reinforcement attached using intermittent welds (sometimes referred to as stitch welds) is often limited by localized flexural buckling of the plate between the welds (see Figure 3). Methods for evaluating local and flexural buckling of flange plates are provided in the AISC webinar “Design of Reinforcement for Steel Members, Part 2,” available at [youtube.com/watch?v=cINpsHmgaUQ](https://www.youtube.com/watch?v=cINpsHmgaUQ).

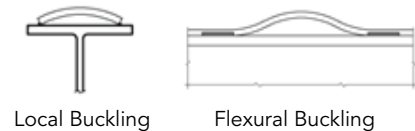

Fig. 3. Local and flexural buckling between intermittent welds.

*Bo Dowswell, PE, PhD*



**Yasmin Chaudhry** ([chaudhry@aisc.org](mailto:chaudhry@aisc.org)) is a staff engineer in AISC’s Steel Solutions Center. **Bo Dowswell**, principal with ARC International, LLC, and **Larry Muir** are consultants to AISC.

Steel Interchange is a forum to exchange useful and practical professional ideas and information on all phases of steel building and bridge construction. Contact Steel Interchange with questions or responses via AISC’s Steel Solutions Center: 866.ASK.AISC | [solutions@aisc.org](mailto:solutions@aisc.org). The complete collection of Steel Interchange questions and answers is available online at [www.modernsteel.com](http://www.modernsteel.com).

The opinions expressed in Steel Interchange do not necessarily represent an official position of the American Institute of Steel Construction and have not been reviewed. It is recognized that the design of structures is within the scope and expertise of a competent licensed structural engineer, architect or other licensed professional for the application of principles to a particular structure.

MAKING CONNECTIONS

# SteelDays 2023

October 17–20

.....  
*One day just isn't enough!*



Start SteelDay with a BANG!  
*The Flash Steel Conference*  
(October 17 to 19)—  
all the compelling,  
must-have info you expect  
from AISC's conferences  
in half-hour-long sessions  
to fit your busy life.

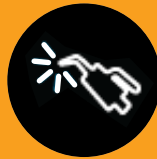

Visits to Iron Worker  
Training Centers to  
try your hand  
at welding.

Shop tours  
that show you  
how steel is  
prepared for  
your project.



A free  
national webinar.



Opportunities  
to network  
with existing  
and potential  
customers.

[aisc.org/steelday](https://aisc.org/steelday)



Smarter.  
Stronger.  
Steel.

## steel quiz ∴

This month's Steel Quiz scratches the surface of uncoated weathering steel. You can find hints (and plenty of useful information) in NSBA's newly published *Uncoated Weathering Steel Reference Guide* ([aisc.org/nsba/design-resources](https://aisc.org/nsba/design-resources)). The questions and answers were developed by Brandon Presley, an AISC intern and student at the Illinois Institute of Technology.

- 1 Which of the following is a benefit of using uncoated weathering steel (UWS)?
  - a. Enhanced aesthetics
  - b. Reduced environmental impact
  - c. Reduced cost
  - d. Reduced fabrication time
  - e. All of the above
- 2 **True or False:** After substantial weathering of a UWS member, it is no longer possible to paint it.
- 3 When a corrosion allowance is warranted, what is the recommended sacrificial thickness for horizontally oriented UWS components for a typical service life?
  - a.  $\frac{1}{16}$  in.
  - b.  $\frac{1}{4}$  in.
  - c.  $\frac{1}{2}$  in.
  - d. There is no recommended corrosion allowance

- 4 **True or False:** Deck overhangs should be cantilevered to the greatest practical extent to provide shelter to the UWS superstructure.
- 5 Which of the following is the most common use of paint on an otherwise uncoated steel member?
  - a. Areas where girders are embedded in concrete
  - b. Beneath joints
  - c. Interiors of closed members
  - d. Outside visible surfaces of fascia girders for aesthetics
- 6 **True or False:** Type 3 weathering steel grades of high-strength bolts and corresponding nuts and washers do not need to be used for connections between two or more coated weathering steel members.
- 7 **True or False:** Proper surface preparation is not required for UWS to develop the protective patina.
- 8 The presence of staining caused by UWS runoff is an indication of which of the following?
  - a. Improper development of the patina
  - b. Poor drainage control
  - c. Deterioration of the structure
  - d. None of the above
- 9 **True or False:** The three metrics to consider for visually assessing UWS surface conditions are adherence, texture, and color.



**ABL-100HS**  
Angle Line

The only angle & flat bar line holding the title for both toughest build quality and fastest speeds.

**Controlled Automation**

501.557.5109 | [www.controlledautomation.com](http://www.controlledautomation.com)

TURN TO PAGE 14 FOR ANSWERS



Sure, **VisualAnalysis** can analyze that!  
You can design just about anything  
with the IES Building Suite.



# easy.iesweb.com

Solve your next problem in minutes. Start getting results today. Quick free trial.

- 1 **e.** All of the above. The primary benefit of using uncoated weathering steel is reduced cost, both in terms of initial fabrication and construction costs as well as long-term maintenance costs (life-cycle costs). Other advantages include reduced fabrication time for structural steel, potentially enhanced aesthetics, and reduced environmental impacts (see Section 1.1 of the *Uncoated Weathering Steel Reference Guide*).
- 2 **False.** UWS can easily be repaired if needed. In the unlikely event that the weathering performance is not as expected, weathering steel can be painted in the field, even if substantial weathering has already occurred (see Section 6.1).
- 3 **a.**  $\frac{1}{16}$  in. Depending on the bridge location, providing a sacrificial thickness as a corrosion allowance to selected horizontally oriented components may be warranted to ensure

sufficient structural capacity. The recommended corrosion allowance is  $\frac{1}{16}$  in. for a typical service life. This is the total increase in thickness and accounts for section loss on both sides of a plate. Providing a sacrificial thickness, as suggested, is typically more economical than future costs associated with maintenance painting (see Section 2.4.3).

- 4 **True.** In order to provide shelter to the UWS superstructure, it is recommended that deck overhangs be cantilevered to the greatest practical extent, consistent with the design parameters for deck design in the AASHTO *LRFD Bridge Design Specifications* ([store.transportation.org](http://store.transportation.org)), and with the consideration for the optimum dead load weight and constructability concerns. Narrow overhangs can result in water ponding on the top side of the bottom flanges due to windblown rain (see Section 2.4.5).

- 5 **b.** Beneath joints. There are situations when painting a limited area of UWS girders can provide substantial benefit. The most common situation of using paint on otherwise uncoated steel is beneath joints. Where possible, joints should be eliminated since leaking joints are a ubiquitous problem in the United States. Other situations include areas where a girder is embedded in concrete (excluding top flanges in decks), interiors of closed members, and the visible outside surfaces of fascia girders for aesthetics (see Section 2.5.3).
- 6 **False.** Type 3 weathering steel grades of high-strength bolts and corresponding nuts and washers should be used in most connections involving UWS and exclusively for connections between two or more weathering steel members, whether uncoated or coated (see Section 2.5.4).
- 7 **False.** Proper surface preparation is key to the development of the protective patina. Minimum requirements are provided in Section 3.1, as are additional best practices for surface preparation that can enhance the appearance.
- 8 **b.** Poor drainage control. Staining caused by UWS runoff is mainly an aesthetic concern for visible concrete surfaces. Attention to drainage control, as well as other techniques, can eliminate the potential for permanent concrete staining. Thus, the presence of staining is an indication of poor drainage control. The maintenance of joints and drainage systems to prevent direct contact between runoff and UWS should be the highest maintenance priority (see Section 3.5).
- 9 **True.** All bridges on public roads, as set forth in 23 CFR, Part 650, Subpart C – National Bridge Inspection Standards (NBIS) of the *Code of Federal Regulations* ([ecfr.gov](http://ecfr.gov)), must be periodically inspected. In general, the inspections required by these regulations are qualitative, visual-based inspections. Best practices for assessment of the visual surface condition of UWS consider the following three metrics: adherence, texture, and color, generally in this order of importance (see Section 4.1.1).

**ROME WASN'T BUILT IN A DAY...**

**BUT WE KIND OF THINK IT COULD HAVE BEEN WITH QUICKFRAMES**

The Leader in Engineered Structural Roof Frames

Manufacturing
  Detailing
  Engineering
  Delivery

[www.quickframes.com](http://www.quickframes.com) | +1(480) 656-1575



# Building success TOGETHER

AESTHETICS | ACOUSTICS | FLEXIBILITY | CONSTRUCTABILITY | SUSTAINABILITY

## Your collaborative partner for steel joists and deck

Experience the difference New Millennium can make for you. As a Steel Dynamics company, we offer you structural steel solutions backed by the strength of leadership, the reach of nationwide facilities and the support of skilled steel specialists. **Let's build success together.**

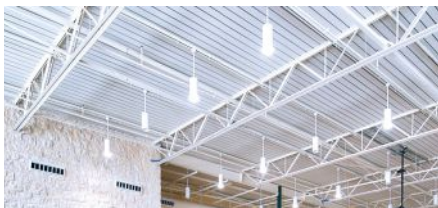

LEARN  
MORE

[newmill.com](http://newmill.com)



**NEW MILLENNIUM**

*A Steel Dynamics Company*

# Thinking Inelastically

BY MARK DENAVIT, PE, PHD, AND RON ZIEMIAN, PE, PHD

Considering inelastic analysis? Here are some recommendations.

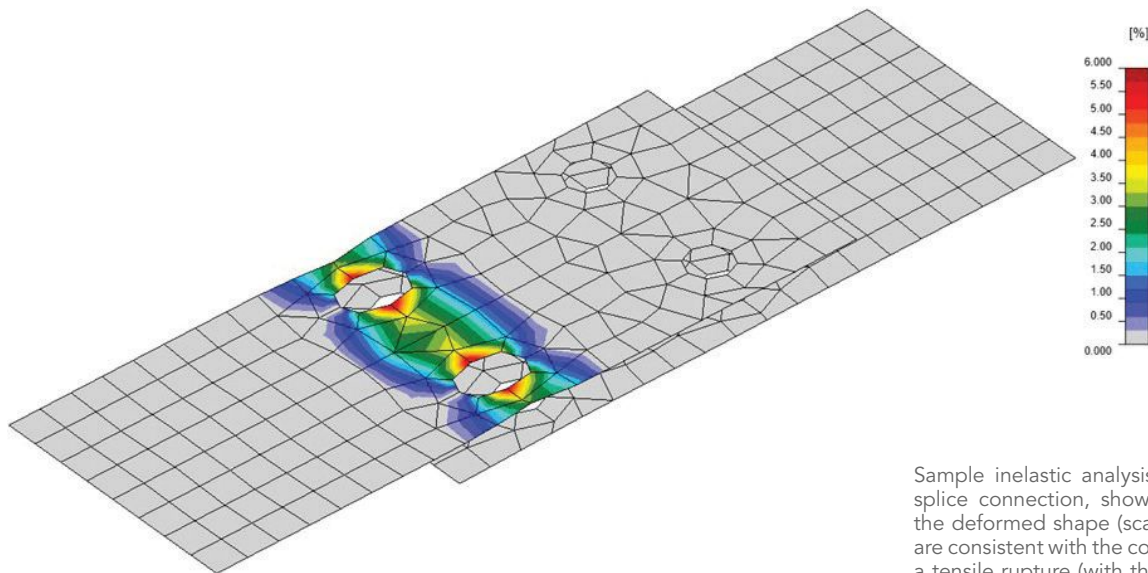

Sample inelastic analysis results of a bolted splice connection, showing plastic strain on the deformed shape (scale factor 10). Results are consistent with the controlling limit state of a tensile rupture (with the top plate removed from view for clarity).

**IMAGINE YOU HAD** nonlinear analysis software that could accurately and efficiently model every aspect of the real-world behavior of steel structures. How would this change the way you design?

Those capabilities are a long way off and may never come, but it is a scenario worth thinking about with the ever-increasing power of computers and software sophistication. The AISC Specification Committee engaged in this thought experiment when developing Appendix 1 for the *Specification for Structural Steel Buildings* (ANSI/AISC 360, [aisc.org/specifications](http://aisc.org/specifications)). The result was a set of practical rules for design by advanced inelastic analysis that empowers engineers to use the best tools available to inform their judgment. Here, we'll briefly cover design by advanced inelastic analysis for those unfamiliar with it and suggest some preparations for those looking to use it in practice.

Apart from a relatively small amount of seismic design, nearly all of today's structures are proportioned using elastic

analysis. Any inelasticity is typically considered indirectly via general stiffness reductions and available strength calculations. However, inelastic analysis in design is now a practical option for many cases.

Of course, AISC has provided the opportunity to employ plastic design for over 60 years—but current analysis software has moved well beyond the potential need to envision all the possible plastic mechanisms and has resolved the difficulties in accounting for second-order effects. Provisions for design by advanced inelastic analysis methods are now provided in Appendix 1 of the *Specification*. One of the key benefits of this most advanced tier of the direct analysis method is that it can eliminate the need to use specification equations to check the available strength for limit states that the analysis can appropriately simulate. In other words, the intent of the *Specification's* provisions is satisfied by using the analysis to realistically simulate and predict limit state behavior. Engineering judgment is essential to producing a safe design when

using any structural analysis package, especially when using sophisticated nonlinear analysis software.

Consider a uniformly loaded beam with both ends restrained against rotation. The magnitude of load that causes the ends of the beam to yield fully—which would be the strength limit state predicted by an elastic analysis—does not necessarily define the ultimate strength of the beam. If the beam is adequately braced and the fixed ends can sustain their plastic moment capacity when subjected to additional rotation—i.e., adequate ductility is provided—then the load on the beam can continue to increase until the middle of the beam fully yields and a plastic mechanism forms. The ultimate load for this strength limit state is one-third greater than the applied load when the first plastic hinges developed. This extra strength was accomplished by the moments being redistributed to the center of the beam as the beam's ends yielded and the system's stiffness dramatically changed. In this case, the use of an inelastic analysis



could lead to a more efficient design—that one-third increase in capacity could result in the use of a much lighter beam. Just as importantly, it would also clearly show the beam’s true strength limit state behavior.

Some of you may be thinking that the above example is nothing more than good old-fashioned plastic design, which is true. As indicated earlier, provisions for plastic design were introduced in the 1961 AISC *Specification*, but they have now evolved significantly into the design by inelastic analysis. The current form of these provisions was introduced in the 2010 AISC *Specification*, in Section 1.3, and mirrors those in Chapter C by first listing general requirements, noting that “any method that uses inelastic analysis to proportion members and connections to satisfy these general requirements is permitted” and then providing details for a specific method. By directly modeling effects known to impact system and member instability, simplifications are granted in computing design resistance. Among the general

requirements is the statement that “strength limit states detected by an inelastic analysis that incorporates all of the above requirements are not subject to the corresponding provisions of the *Specification*...” This makes it possible to account for strength beyond the first plastic hinge in our simple example. But today’s nonlinear analysis capabilities are much more sophisticated and could simulate situations in which the cross section employed was not compact, no lateral bracing was provided along the span of the beam, and/or the member was also required to resist axial force and minor-axis bending. In doing so, we have moved from a classical plastic mechanism analysis that does not require a computer to employing nonlinear finite element analysis software based on sophisticated frame and shell elements that requires a decent computer.

Of course, design by inelastic analysis is not a tool for all situations. (Do you really need a No. 10 scalpel when a pocketknife can do the job?) For most of today’s routine

work, the potential benefits of employing an inelastic analysis, including a much more simplified design process, may be outweighed by the additional computational effort and required preparedness of the engineer (most universities only provide courses in nonlinear analysis at the graduate level, and these are often not linked to design). Still, there are many situations where design by inelastic analysis will be the best solution, such as:

- Structures where optimizing the use of material is paramount. This may be particularly attractive for manufactured products that are repetitive and demand efficiency
- Cases where the *Specification* provides limited guidance
- Complex systems or connections
- Sharpening the pencil to avoid design changes or retrofit

The intended user of Appendix 1 is well-versed not only in the behavior of steel structures but also in the application

**VOORTMAN MSI FULLY AUTOMATED INTEGRATED PRODUCTION LINE**

FULLY AUTOMATED PRODUCTION

BUFFER MANAGEMENT

SMART UNLOADING

DATA DRIVEN APPROACH

HIGH FLEXIBILITY

CONNECTED BY VACAM-SOFTWARE

With a Voortman beam processing line packed with high-quality hardware and intelligent software, a door opens to fully automated production and intra-logistic processes. We call it MSI: Multi System Integration. All machines are seamlessly connected via our VACAM-software, cross transports, roller conveyors, product buffers and material sensors. Thanks to our intelligent buffer management, the system is able to work autonomously for long periods of time with maximum throughput.

**DESIGNING A PERFECT FIT!**  
To get to such an optimal lay-out with maximum efficiency, we use a data-driven approach combining your input and requirements with real data while keeping future expectations into account. Curious what your optimal lay-out with maximum processing efficiency looks like? Then challenge us!

**AUTOMATIC WELDING AND ASSEMBLING**

- Automatic fitting and welding of long and heavy beams;
- Capable of the most common connection types;
- Simultaneous loading and unloading of the machine with an automatic magnetic crane.
- The Fabricator can be integrated with other Voortman machines in a complete production line.

**voortman**

Voortman USA LLC / 26200 S. Whiting Way / Monee, IL 60449 - USA / +1 708 885 4900 / [WWW.VOORTMANCORP.COM](http://WWW.VOORTMANCORP.COM)

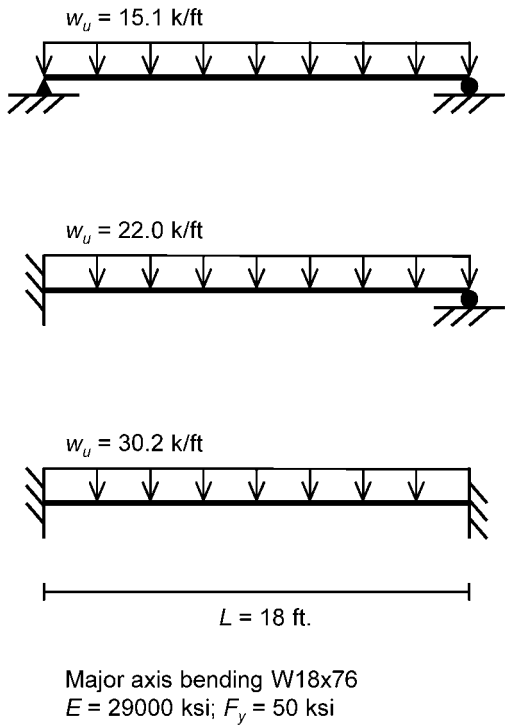

Fig. 1.

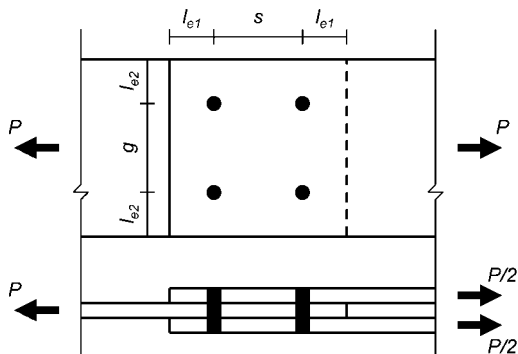

Fig. 2.

of nonlinear analysis. Of course, suitable analysis software is also required. Without the requisite knowledge, however, the designer would be using the software as a black box, which is never a good idea. Performing design by inelastic analysis within a black box can be especially hazardous given how much of the design process is embedded in the analysis and with fewer guardrails in place. As has always been the case, but now with much more emphasis: *Analysis tools are only intended to inform your judgment, not replace it.*

So how do you acquire the necessary analysis knowledge? A textbook is a good place to start for the fundamentals of nonlinear analysis. We recommend *Matrix Structural Analysis* by McGuire et al (available as a free download at [www.mastan2.com](http://www.mastan2.com)) as one option, but there are others. AISC’s Education Archives ([aisc.org/education-archives](http://aisc.org/education-archives)) also provide access to online lectures on this subject, which could prove useful. And then you’ll need software to get started—and again, a visit to [www.mastan2.com](http://www.mastan2.com) might do the trick. In general, users of Appendix 1 should have a basic understanding of how systems of nonlinear equations are formed and solved. It is also important to understand that superposition is not valid in nonlinear analysis and how topics such as solution schemes, step size, and mesh density, which typically have much less impact in linear analysis, can become critically important in nonlinear analysis.

Once you are up to speed, you will need to determine what your analysis software can do and, just as importantly, what it cannot do. No analysis engine captures every aspect of physical behavior. Yielding is probably included in the analysis, but local buckling or rupture may not be. It is okay if some forms of behavior are not included. For example, limit yourself to compact shapes if you cannot model local buckling. If you cannot model fracture, impose a strain limit. Computational modeling of this sort requires making choices based on sound judgment. In other words, you should be aware of the choices you are making

as a user and the choices the software developer made on your behalf. Good software developers will be transparent with those choices and provide technical literature that you can review.

When you grasp the basics well, start small and then build bigger. Try that beam example with fixed ends. Figure 1 shows a specific example with values to target. Recreate examples provided in textbooks and trusted online resources. If you are looking to employ nonlinear analysis to design connections, we suggest you begin by modeling a simple lapped connection with a few bolts. Select cases where a variety of limit states control the strength, like in Figure 2. Does your inelastic analysis give you the results you expect? If it doesn’t, then determine why not. For simple cases like these, if there are any differences between the inelastic analysis and the Specification equations, you should be able to identify the reason. You should not be alone in this; good software developers will provide the help you need to use their software safely and effectively.

After the simple cases, move on to more complicated ones. Try a connection with prying action, long welds, or eccentric loading. As before, you are not just looking for any results. You are looking to compare results to *Specification* provisions and other guidance. Do you want to use inelastic analysis to design moment connections? Try comparing against Example II.B-1 from the AISC Design Examples (v15.1); visit [aisc.org/manual15](http://aisc.org/manual15). If you are looking to design vertical bracing connections, try Example 5.1 from AISC Design Guide 29: *Vertical Bracing Connections—Analysis and Design* ([aisc.org/dg](http://aisc.org/dg)).

You can also venture out on your own. Change the input from one of the examples. Do the results change in the way you expect? This process will not only help you build trust in your model but can also help bolster your understanding of the behavior of steel structures. In a pair of articles for *Structure* magazine (November and December 2008, [www.structuremag.org](http://www.structuremag.org)), Graham Powell described exercises like this as a way to build a feel for structural

behavior. They also help you build a feel for nonlinear analysis. Run a mesh sensitivity study to determine how much the results depend on the number of finite elements you use in your model.

As you develop a feel for structural behavior and analysis, you will also develop a feel for the right time to use inelastic analysis. The optimal balance of prescriptive specification equations versus directly modeling effects impacting strength will vary from project to project. You should not depart from the *Specification* equations lightly. They were developed based on decades of experimental and analytical research and the collective knowledge of experts in the field. They are often more sophisticated than is immediately

obvious—e.g., preventing yielding under service loads in addition to strength failures. They are also sometimes more conservative than necessary.

Design by inelastic analysis is intended to allow more opportunities for better engineering, not to enable automated analysis

and design. If it was possible for a computer to design a structure, then the world would no longer need structural engineers. Fortunately, that is not the case. Structural engineers still can and must provide value with our judgment and our ability to select and use appropriate tools. ■



**Mark Denavit** ([mdenavit@utk.edu](mailto:mdenavit@utk.edu))

is an assistant professor in the Civil and Environmental Engineering Department at the University of Tennessee, Knoxville, and is a member of AISC's Technical Committees 5 and 7. **Ron Ziemian** ([ziemian@bucknell.edu](mailto:ziemian@bucknell.edu)) is a professor in the Department of Civil and Environmental Engineering and Co-Editor-in-Chief of the *Journal of Constructional Steel Research* at Bucknell University and is a member of AISC's Committee on the Code of Standard Practice, Technical Committees 3 (Chair) and 4, and the Partners in Education Committee.



Calculate yesterday's estimates

# HOW WOULD YOU DESIGN THESE CONNECTIONS?

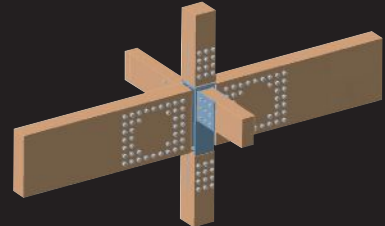
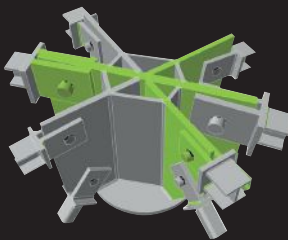
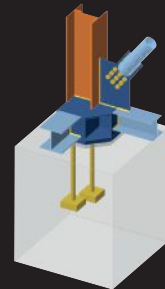
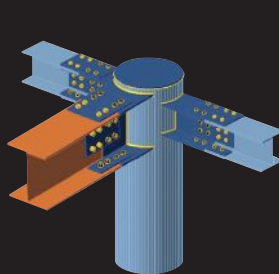

NOW, THERE IS A SOFTWARE THAT CAN.

Request a DEMO on  
[www.ideastatica.com](http://www.ideastatica.com)

# Filling the Labor Gap

BY BRIAN RAFF

The shortage of construction trade jobs represents an ongoing struggle that can have a significant negative impact on steel projects, but the solutions are out there—and AISC is making a concerted effort to leverage them.



**AT AISC, WE RECOGNIZE THAT** unfilled labor demand in the nonresidential steel construction industry is a big problem—and we're all in on ways to solve it.

We now have a robust workforce development effort underway to advocate for the skilled trades, actively challenging the common misconceptions about a skilled trades career path to bring diverse talent to the structural steel industry. If you have thoughts, ideas, or success stories regarding workforce development, contact AISC's new director of workforce development, Jennie Traut-Todaro, at [trauttodaro@aisc.org](mailto:trauttodaro@aisc.org).

We listen to pundits talk about general economic issues that bubble up at kitchen table discussions, like gas and food prices.

But while it's not making national headlines, those of us in the know realize that the nonresidential construction industry is a crucial part of our national economy, providing the essential infrastructure for commercial, industrial, and institutional facilities. It's a dynamic sector with various job opportunities ranging from steel fabricators, welders, and ironworkers to engineers and project managers.

However, the industry is currently facing a significant challenge: unfilled labor demand. This issue poses a significant threat to the industry's growth, and I'd like to highlight a few reasons why.

Unfilled labor demand in the steel construction industry has become a significant challenge. Employers like our own member fabricators have been struggling to find skilled workers to fill various job positions. In fact, the overall construction industry lost 9,000 net jobs in March, according to an Associated Builders and Contractors (ABC) analysis of data released recently by the U.S. Bureau of Labor Statistics. On a year-over-year basis, industry employment has grown by 196,000 jobs, an increase of 2.5%, but nonresidential construction employment fell by 1,800 positions on net. Nonresidential specialty trade lost 6,100 positions, while the number of nonresidential building jobs decreased by 2,800. Heavy and civil engineering added 7,100 net new jobs.

A report by the Associated General Contractors of America (AGC) found that

81% of firms in the nonresidential construction industry were having difficulty filling hourly craft positions, such as carpenters, electricians, and welders. Additionally, 40% of firms reported that it was very difficult to fill salaried positions like project managers and supervisors. These statistics suggest that the nonresidential construction industry has a high level of unfilled labor demand.

The lack of skilled labor has been attributed to various factors. One of the primary reasons is the skills gap, where there is a mismatch between the skills employers are looking for and the skills workers possess. Additionally, there is a shortage of people entering the industry due to a lack of awareness about the opportunities available, as well as negative perceptions about the industry. The industry is also facing competition from other sectors, such as technology and healthcare, that are offering higher wages and better working conditions.

The issue of unfilled labor demand has significant implications for the economy as a whole. The nonresidential steel

data driven

construction industry is a significant contributor to the country's GDP and employs millions of people, and the industry's growth and sustainability are essential for the overall health of the economy. However, if the industry is unable to find the necessary labor to sustain its operations, it could lead to a reduction in its output and a decline in economic growth.

The solution to the unfilled labor demand in the nonresidential steel construction industry requires a multifaceted approach. First, there needs to be a concerted effort to raise awareness about the industry's job opportunities and promote its benefits. This could be achieved through education and training programs in schools and vocational centers. Additionally, industry associations could collaborate with government agencies and community organizations to promote the industry and its opportunities.

Secondly, the industry needs to invest in training and development programs that target the skills gap. This could involve partnering with educational institutions to provide relevant training and certification programs. Employers could also offer apprenticeships and on-the-job training opportunities to help bridge the skills gap. Also, check out "Racing to Charlotte" on page 58 to read about workforce development initiatives at NASCC: The Steel Conference.

Unfilled labor demand in the non-residential steel construction industry is a significant challenge that requires urgent attention, and AISC is going all in on trying to become part of the solution so that our industry remains vibrant, sustainable, and prosperous. ■



**Brian Raff** ([raff@aisc.org](mailto:raff@aisc.org)) is AISC's vice president of market development, marketing communications, and government relations.

See that the bolts are tight!™  
**DuraSquirt® DTIs**

The Best Way to Bolt!™



1 800 552 1999

[appliedbolting.com](http://appliedbolting.com)

Designed, Engineered & Made In USA Since 1994



## SSM Joists & Decks

Fabrication & Supply of:

- Steel Joists & Joist Girders
- Metal Decks
- In compliance with industry standards

## Structural Steel Manufacturing, Inc.

PO Box 602828

Bayamon, PR 00960-2828

Tel: (787) 787-5405

Email: [sales@ssmjoist.com](mailto:sales@ssmjoist.com)

Website: [sswincpr.org](http://sswincpr.org)



AISC  
CERTIFIED  
FABRICATOR  
& ERECTOR

# Living by the Code

INTERVIEW BY GEOFF WEISENBERGER

Extensive work with building codes as they relate to steel construction has been a defining characteristic of Robert Wills' award-winning career.



**ROBERT WILLS** has gotten quite a bit done in his four decades in the construction industry.

Currently vice president of construction for the American Iron and Steel Institute (AISI)—a role he's held for nearly 16 years at an organization where he's worked for more than 33 years—he's responsible for overseeing programs in

commercial buildings, residential construction, and the transportation/infrastructure markets, as well as the AISI Construction Technical Program. He became vice president of construction market development in 2008 following 18 years of service with the AISI Code and Standards program, during which he was responsible for design specifications, test methods, product specifications, and installation standards related to steel in construction.

He is widely recognized for his expertise in fire safety engineering, structural fire testing and performance, wind engineering, and geotechnical and foundation engineering and was heavily involved in the development of the *International Building Code* and the *NFPA 5000 Building Construction and Safety Code*.

With such a long and illustrious career in the steel industry, it shouldn't come as a surprise that Robert was one of this year's AISC Lifetime Achievement Award winners. I sat down with Robert at NASCC: The Steel Conference this past April in Charlotte, where we discussed his career, his work with building codes, his 16 years of commuting between Alabama and Washington, D.C., his impending retirement, and more.

**Congratulations on the award, Robert! So how many Steel Conferences have you been to?**

I wish I could remember. I don't remember ever *not* coming to the conference. It's just the place you go to get information and meet people. It's where I get to connect with people in the steel industry.



Field Notes is *Modern Steel Construction's* **podcast series**, where we interview people from all corners of the structural steel

industry with interesting stories to tell. Listen in at [modernsteel.com/podcasts](https://modernsteel.com/podcasts).

**Speaking of connections, AISI and AISC have had a great, long relationship working together, and you've been a big part of that. Can you comment on that?**

I really appreciate the award from AISC, and it's a wonderful thing, especially considering the people that have come before me. It makes me feel very honored. AISI and AISC have always worked together well and advanced the cause of the steel industry working collaboratively. I have no doubt that both organizations will continue to work in the best interest of the steel industry and continue to move the needle in the future.

**I have no doubt, either. So you've been with AISI for quite some time.**

33 years.

**Wow! And as long as I've known you, I've always thought of you as a go-to person when it comes to building codes. How did you get to that point?**

I guess there are really three parts to my career. I graduated as a structural engineer and did industrial structural design for about six or seven years. And then, I decided I needed a slightly different path, something that allowed me to use some different skills. And I went looking for that opportunity and found it with the *Southern Building Code*, which is one of the predecessors of the *International Building Code*, and I worked on staff there for about three and a half years and really got engrossed in building code work. And that's where AISI found me, and they hired me back in 1990 to start doing building code work on behalf of the steel industry. I did that for about 18 years, representing the industry, and then AISI asked me to move up to become the vice president of construction market development. I've been doing that ever since.

**I got to dabble in the code side of things when I was in the sustainability position at AISC, and it was a fascinating process. When I'd go to some of the code hearings, I'd hear people arguing passionately back and forth to get one little item into or removed from a building code. And that's when I realized that codes aren't written in stone, so to speak, but rather are changed and finessed over time.**

It's kind of like making sausage. It's a process you really don't want to see, but it was fun. I enjoyed it. I thought I was pretty good

at it, representing the steel industry interests, but it did require you to be fairly confrontational at times and take the mike on the floor and argue the steel industry points against concrete or wood or some other competing material. The thing about it a lot of folks don't know is that while I might fight tooth and nail with the concrete industry or the wood industry for days on end at code hearings, some of the people who represented those industries were some of my best friends. And so as soon as the day was over and we finished the work, we'd go out and catch a ballgame together. You couldn't make it personal. You needed to make sure you stayed professional and argued the case with due diligence on behalf of the industry. But you can't lose friends over those things.

**That's very true. Can you elaborate on how AISI found you, so to speak?**

Well, it was pretty straightforward. All the major industries have staff members that do building code work. It was at a point where AISI needed to hire a new structural engineer for the Southeast, so they put out a request for applicants, and being on staff at *Southern Building Code* made it a pretty simple thing for me to look into. I remember very well when I was offered the position with AISI, I went to the *Southern Building Code* CEO and told him that I was considering taking a job with the steel industry. And what he told me was, "You always have a place to come back to here if you want to. But you can't do any better than to go work for the steel industry. They do a high level of work, and if you have an opportunity to go work for them, you better jump on it."

**That's fantastic. That's great advice. He wasn't wrong, right? Did you move straight to D.C. at the time?**

Oh, that was later on. When I was doing code work, I did it out of Alabama. As long as wherever I was going had an airport, I could be where I needed to be. The job required heavy travel back in those days. I was probably doing 200 nights a year in a hotel during the time I was representing steel in the codes world.

When I got asked to take the position of vice president of construction with AISI, they told me, "We want you to do this role, but you have to move to D.C."

I told my wife, and she said, "That's a great opportunity and you need to do it, but

I'm not coming, so figure out a way to make it work." So for 16 years, I had an office in downtown D.C. and commuted every week, flying home to Alabama almost every Friday night and coming back on Sunday night. It was a fun experience. My wife never wanted to be there permanently, but for 16 years, we had a ball. She was up there frequently. She came when she wanted to and went home when she wanted to. But when COVID hit in 2020 and they shut down the office, I told her, "I'm close enough to retirement that I'm going to go back to Alabama, and I'm not going back up to D.C. full-time." My wife just happened to be in D.C. when we closed the office. So we were in the car driving back to Alabama and spent the entire drive home making up a bucket list of all the things in D.C. that we never got done in the 16 years I lived there. And I guess it's probably true of a lot of people, but you tend to put off doing things where you live because you take them for granted.

**Right, because you always think, "Oh, I could do that next week."**

Right, so we came up with our list, and I'm looking forward to hitting all of the items when I retire. ■

*This conversation was excerpted from my conversation with Robert. To hear more from him, including how he got into the engineering world and his plans for retirement—which include plenty of time traveling, refurbishing old cars, and relaxing by a lake in northern Alabama—check out the June 2023 Field Notes podcast at [modernsteel.com/podcasts](https://modernsteel.com/podcasts). In addition to Robert, I interviewed several other AISC award-winner at the Steel Conference in Charlotte, and we'll be featuring them throughout the year. You'll also be able to see short videos of the interviews on AISC's YouTube channel, [youtube.com/@aisc](https://youtube.com/@aisc).*



**Geoff Weisenberger**  
([weisenberger@aisc.org](mailto:weisenberger@aisc.org)) is chief editor of *Modern Steel Construction*.

# Mapping Value

BY BARRY J. BRUNS

Value stream mapping has the potential to be a valuable tool for steel fabricators.



**YOU MAY HAVE HEARD** of value stream mapping (VSM), though perhaps not as it relates to the structural steel industry.

Simply put, it's a management technique that converts process chains into a visual aid.

Here's how it works. Typically, the people involved in a process flow, or value stream, measure each part of the flow, noting the number of people and machines at a workstation, the amount of time they spend processing one piece of their work, and how long that processing takes. They also measure how long each piece waits between processes, how many pieces build up between processes, and how far those pieces move between processes. Each piece of information is indicated on a drawing or map in a specific order. (By

the way, the seminal book on the subject of VSM is *Learning to See* by Mike Rother and John Shook.)

In more formal VSMs, each of these pieces of information has its own graphic representation or icon. The map starts and ends in the upper-right-hand corner, the starting and ending place for the process being evaluated. The processes move down and left, with management in the middle. Production moves across the bottom, process by process, and finished goods appear at the lower right. A VSM might show a complete process, from customer order to payment after delivery—i.e., the complete life cycle. Or it could illustrate some subset of that, perhaps leaving out the financial arrangements, for instance. It can actually

dig down to each process, mapping how the individuals within a specific work center work, though those things normally become apparent as the group works through mapping their process. Having a large wall with a whiteboard is a great place to make a VSM. Everyone in the room sees the same information as it develops.

The map notes both material flow and information flow. In a completely lean manufacturing process, production information flows upstream against the product flow. When a customer buys a product, as the product leaves the shipping area, it generates a production order for the last operation in the process flow. As the replacement item leaves each production area, it generates a message to the previous



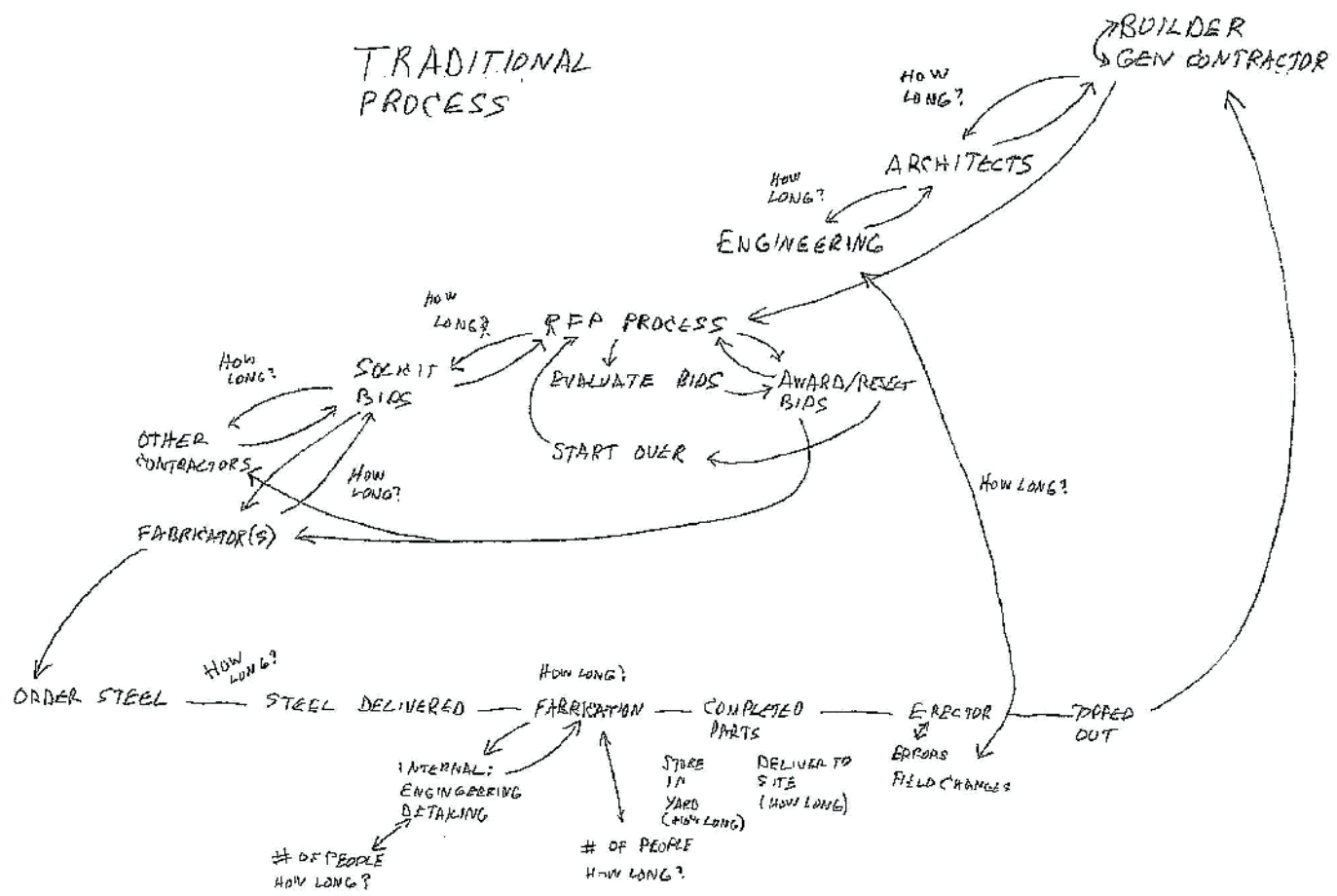

### EARLY INVOLVEMENT

(MAKE LONG TERM RELATIONSHIPS WITH RELIABLE SUPPLIERS)  
(N.B. DEMANDS)

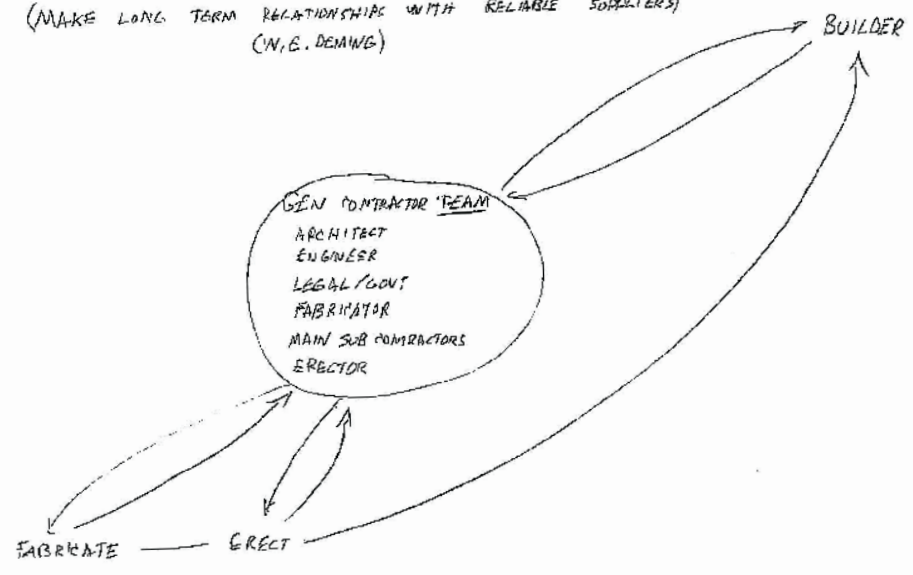

production area to complete and move its replacement. As raw materials move out of their storage area, an order is generated for more, either going to the managing office or directly to the supplier.

Creating these maps is often a dynamic and enlightening process. Each individual in the group has ideas and an understanding of how "their" process works, and those leading the mapping have to be prepared to tone down arguments! It is always amazing how much the understanding of a production process varies. The solution is to send small teams to the production line to measure everything that will be on the map. Measurements of numbers, times, and distances become a snapshot of the process at the time of measurement.

From here, it becomes easy to measure and note how much value-added operation, taking how much time, is required by the life-cycle process on the map. It is also easy to measure and note how much non-value-added time is wasted in the process. If a product is not being processed—e.g., if it is stacked up somewhere awaiting movement to the next process—the time it sits is non-value-added. If the production processes are waiting for information—drawings, work order releases, etc.—this is non-value-added time. Note that value-added and non-value-added times relate to the product, not how busy people are. One of the most difficult things to convince managers, especially accountants, is that employees waiting is not the problem. Products and customers waiting is the problem.

### Trimming the Fat

This is where the fun begins. Once everyone realizes how their current process works and can see the non-value-added time, they can begin to figure out how to eliminate some or most of it. They will be able to see where there are imbalances in the process—too much capacity in one work area, not enough in another that is the bottleneck, how much wasted time is involved in moving material, etc.

Eliminating the non-value-added time is the low-hanging fruit. In one I was involved with, material moved 1,300 ft through a factory, the process required ten people, and the total processing time was two weeks. Because customers typically needed the product on short notice, the factory had to put unfinished products in a holding area so they could be pulled and finished to order. At the end of a two-day VSM project, the factory workers rearranged their work centers and the product flow. Within a week, they had their process down to four people and 120 ft of product movement, and they could ship customers exactly what they needed the next day. The factory also implemented VSM in other product lines, freeing up over 25% of its floor space for new lines, eliminating hundreds of thousands of dollars worth of surplus machinery and material, and increasing the factory production capability enough to make all the managers and leadership teams happy.

### VSM and Steel Fabrication

So how does VSM apply to structural steel framed building fabrication and construction? Simply put, it doesn't—at least not in the typical way it applies to manufacturing operations where production lines may function with little change for long periods of time. In steel fabrication, each project is unique—more like a prototype than a product run. That said, every structural steel project has its own production cycle, its own system of workstations, and its own “products,” whether material or informational.

Let's go back to the earlier description of a VSM. The map starts in the upper-right corner, with the buyer deciding to build a project. If all of the players in the project, especially a large and exciting one like a high-rise office building in a major city, perform their operations one after the other, how long does it take just to get the plan developed enough to send it out for bids? How much of that time would show up as non-value-added time when the engineers are waiting for the architects, the architects are waiting for the buyers to decide what they want the project to look like, the engineers are waiting for the buyers and architects to approve changes when it becomes obvious that the project, as originally visualized, is impossible, dangerous, or just too expensive? Once that process goes through several iterations and bid drawings finally hit the field, how much non-value-added time will result from the bids coming back too high or from not getting enough bids? This typically linear decision and information flow can drag on for months, if not years. On a VSM, it would show up as a very bad ratio of value-added time to non-value-added time. All of this, and the first steel beam isn't even ordered yet.

Once the decision sequence is finally settled, the fabricator has to guess how much the project would really cost because they know the bid drawings will not be close to the detailed production drawings. They will have to go back and reactivate the decision process, maybe clear back to the buyer, or at least the general contractor, possibly several times. As they await the relevant decisions, the non-value-added clock keeps ticking

away. Then, when they can finally crank up their fabrication process and begin delivering the steel, they get a surprise change order. More delay, non-value-added time. If attorneys become involved, the clock slows down even more, but the cost per hour of non-value-added time likely increases dramatically. On such a map, you'll see many wasteful lines circling back to former processes over and over. This isn't what you want your map to look like.

How *could* your map look? In the current state described above, the total cycle time from the buyer buying to paying for the building and moving in will be excessive. It could be a financial mess for many of the contractors, especially if liquidated damages are involved. Most, if not all, of the non-value-added time is due to the linear nature of the process. People in each work center—general contractors, architects, engineers, fabricators, erectors, other trades—do their thing, toss the results over the wall to the next “poor dumb bastards” (to quote George Patton), and everything grinds along slowly.

But what if the process wasn't linear but rather parallel? Computer programs have gotten better due to parallel processing; the days of linear processing are destined for a museum. How does parallel processing work in the construction business? Early involvement! Instead of the iterative process described in the current state, if all the players are involved from the first meeting, then the iterations happen in real time across a table. If the engineer can see that the architect's ideas won't work, they hammer out a different solution right then and there. What would take weeks or months to figure out and settle on before beginning fabrication can take mere days, even hours in some cases. Having the fabricators and erectors involved from day one will also help make the design workable and efficient. All of this should be apparent to at least the general contractor, perhaps even the buyer's representative. And really, anyone who will or could have a say in the construction process should be involved early.

### Parallel Processing in the Shop

Though the greatest potential to speed up a project actually lies outside of the fabricator's shop—so long as the project

## business issues

is not waiting on fabricated steel—there is always a benefit to making the shop more efficient. Creating a map of everything that impacts workflow through the shop will help managers and leaders “see” where they can eliminate some non-value-added time. Unlike the manufacturing example, each project will be different, but each one will still afford the opportunity to be more efficient and perhaps free up enough resources to allow the shop to take on some other projects that can run parallel to whatever the primary project is. Once managers measure operations and map them, it is much easier to “see” where things are out of balance. Are fitters waiting on detailing? Is detailing ahead of fitting? In either case, is there some alternate work the company can do that restores the balance? If cut and drilled beams are stacking up, waiting for the fitters to finish them, the map will show it. It will always be more difficult to balance workflow in structural steel fabrication than it is in more repetitive manufacturing, but it is possible to make it better. If there is often an imbalance between work centers in the shop, perhaps it is time to spend some time and money cross-training the best employees so they can swing to whatever process is lagging on a particular job. A “back-of-the-envelope” map created in a few minutes may be all that is required to sell the change to management.

Just as shop drawings are vastly superior to written instructions for showing how to complete a connection, a VSM can be superior to thousands of words, providing a valuable visual perspective on your shop operations and a project as a whole. ■



**Barry J. Bruns, Col., USAF (Ret.),** formerly a fighter pilot for the United States Air Force, is a Puma Steel board member.



AGTROBOTICS.COM

USA  
819.693.9682

# WELD FASTER FIT SMARTER KEEP IT SIMPLE

ROBOTIC WELDING



**BEAM  
MASTER**

Largest installation  
base in north america

FITTING ASSISTANT



**LAYOUT  
MASTER**

Lose  
the measurint tape!

# THE PROVEN STEEL BRIDGE DESIGN SOLUTION

**FREE  
15-DAY  
TRIAL\***

\*see website  
for details



The leading software package  
for designing and rating curved  
and straight steel girder bridges.

**Used by Many State DOTs and Top Design Firms**

(573) 446-3221 ■ [www.mdxsoftware.com](http://www.mdxsoftware.com) ■ [info@mdxsoftware.com](mailto:info@mdxsoftware.com)

# First Time's the Charm

BY JAMES SAVAGE, SE, PE

The new Hubbard Center expansion to Omaha's Children's Hospital and Medical Center marks two significant construction firsts for Nebraska while adding much-needed space.





The \$450 million, 427,000-sq.-ft addition offers a wide array of new and improved features, including an expanded emergency department with seven new operating rooms, a one-of-a-kind imaging center, a newborn intensive care unit, a pediatric intensive care unit, and a cardiac care center.

**NEBRASKA'S PREMIER** children's hospital has grown up.

Founded in 1948 during the polio epidemic, Children's Hospital and Medical Center is Nebraska's only freestanding children's hospital and has long been on the leading edge of pediatric care, providing more than 30 specialty clinics to the region. Over the last decade, however, the escalating need for expansion peaked as the hospital reached full capacity in its existing facilities.

Designed and built using an integrated project delivery (IPD) process—a first for a Nebraska project—resulting in the addition of the new Hubbard Center for Children. This expansion is now the most visible part of Children's Hospital, fronting Omaha's busiest corridor, integrating architecturally with the existing structures. It also incorporates ASTM A913 Grade 65 steel, another first for the state.

The \$450 million, 427,000-sq.-ft addition offers a wide array of new and improved features, including an expanded emergency department with seven new operating rooms, a one-of-a-kind imaging center, a newborn intensive care unit, a pediatric intensive care unit, and a cardiac care center. The ten-story addition also features a rooftop helipad, an elevator machine level, a 765-vehicle, seven-story parking garage, an ambulance garage, an expansive dining area, chapel and meeting spaces, a patient check-in/out area, outdoor gardens together with a solarium.

### Connecting Old and New

Using state-of-the-art technology, processes, and project delivery, the design team overcame significant challenges and delivered the project on schedule and on budget. The team explored several options for the hospital's structural system, and steel was ultimately selected due to schedule and cost advantages, as well as its ability to efficiently address the building's programming and layout. In addition, the team looked to AISC Design Guide 11: *Vibrations of Steel-Framed Structural Systems Due to Human Activity* ([aisc.org/dg](http://aisc.org/dg)) to validate the steel design for the new operating room area.

The expansion consists of a three-level ancillary base with a six-story bed tower above. The tower features a smaller footprint than the ancillary base, requiring transfer girders at the second level to support the tower columns. Each tower column transfers 1,000 kips to the lower ancillary building columns to create the step back.

The framing system comprises 4½-in.-thick concrete slabs on 3-in.-deep composite metal deck, supported by composite steel

The expansion consists of a three-level ancillary base with a six-story bed tower above. The tower features a smaller footprint than the ancillary base, requiring transfer girders at the second level to support the tower columns.

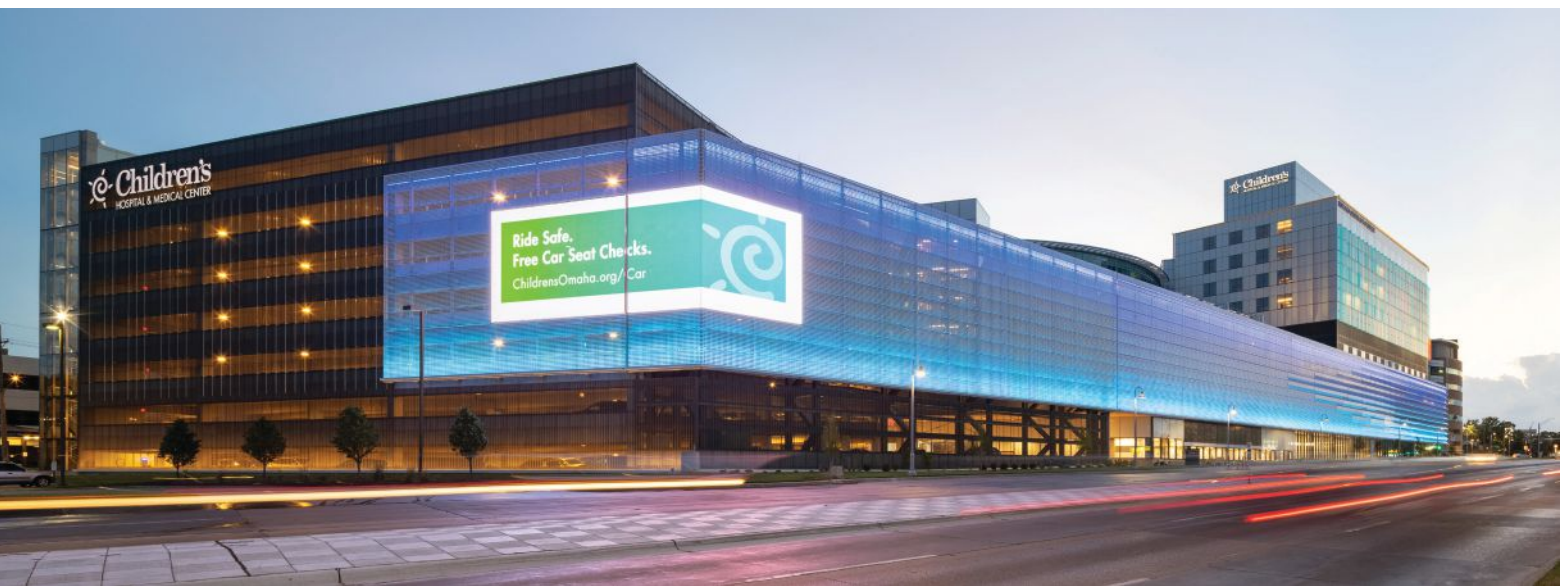
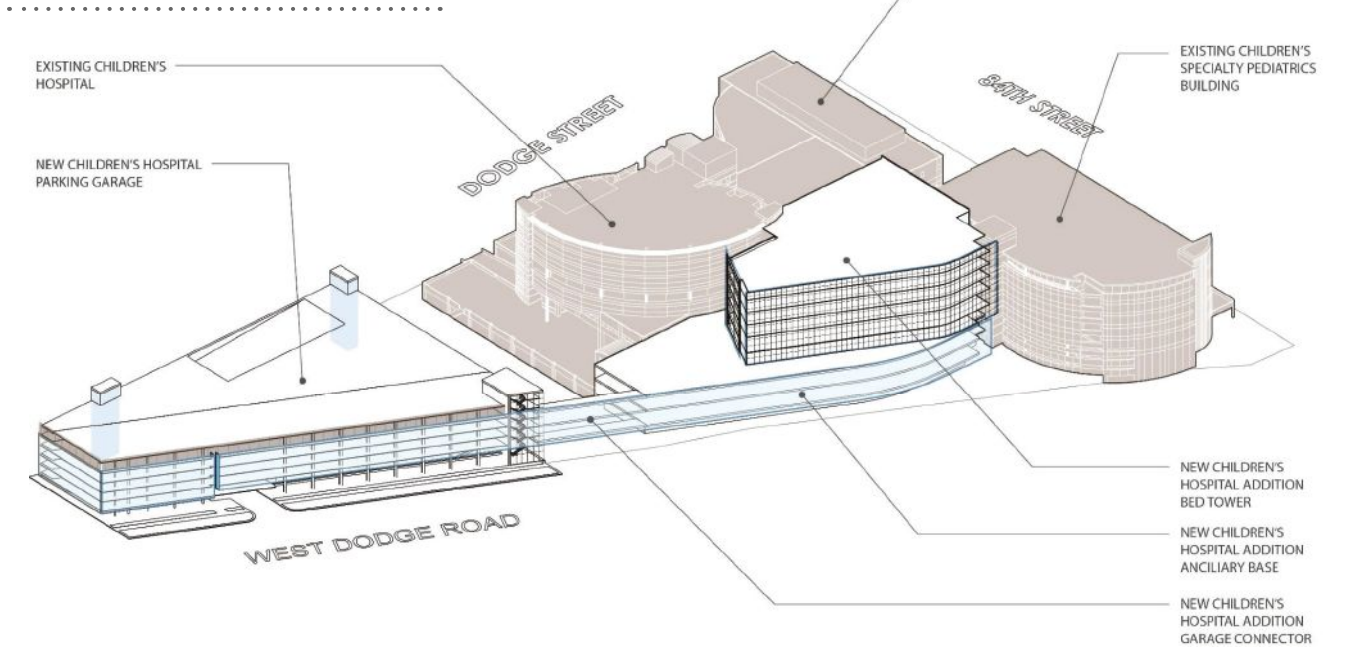

beams and girders. Steel columns support the beams and girders, while steel braced frames resist lateral loads and are located next to the exit stairs and elevators to reduce their impact on floor plans. The project required 78 drilled piers, ranging from 3 ft to 6 ft in diameter, under the braced frames to resist uplift, overturning, and shear from the braced frames. In all, the project incorporated 3,569 tons of steel. Typical bay sizes are 32 ft by 32 ft, and typical columns are W14 sections, with the largest being a W14×730 located at a couple of braced frame locations.

As the hospital's existing loading dock and ambulance garage were located between two buildings, namely the Hubbard Center and parking garage, the structural team developed an 80-ft-span parking deck extension that connects the emergency department to the new parking structure. The quick erection capabilities of steel

allowed the hospital to continue using the loading dock at night and steel to be erected throughout the day. A concrete structure would have required formwork shores during construction, which would have required the loading dock to be temporarily closed. In addition, cambered beams minimized the depth, created slopes for drainage, and minimized the steel sizes required, allowing a smaller crane to lift the long-span W30×116 and W30×108 beams into place, though some of the heavy W36×262 and W36×194 beams were placed with a tower crane earlier in the construction process.

The Hubbard Center connects back to the existing hospital on multiple floors, requiring extensive coordination to allow construction to proceed without disrupting patient care in the existing hospital. Some construction operations were scheduled during specific hours of the day to avoid noise or vibration impacts on the

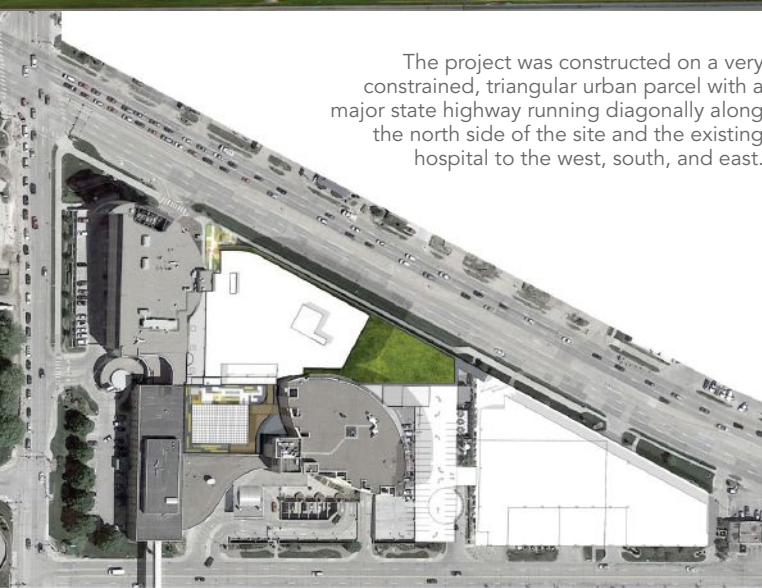

The project was constructed on a very constrained, triangular urban parcel with a major state highway running diagonally along the north side of the site and the existing hospital to the west, south, and east.

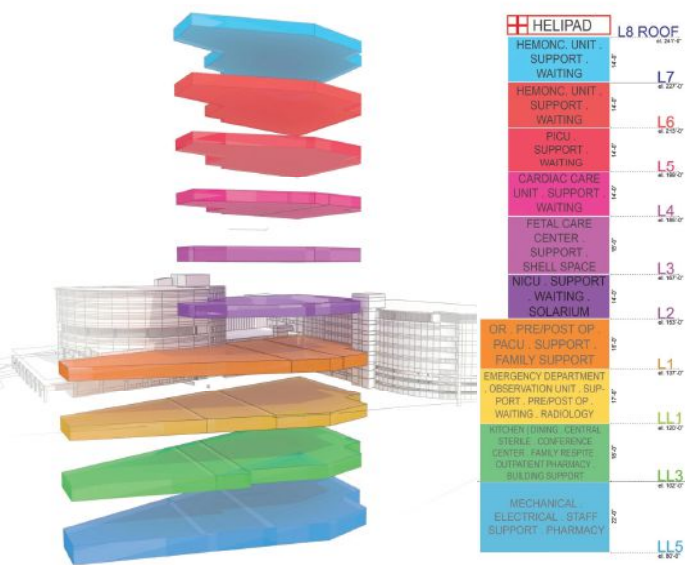

existing hospital. To reduce impacts, the steel floor framing design allowed the existing exterior walls to remain in place until the new hospital tower was enclosed, and then the existing walls between the new and old buildings were removed. Extensive coordination occurred prior to and during steel erection to make sure the floors aligned after the existing exterior wall was removed.

To harmonize the exterior elevation of the tower and the parking garage, the team designed a 65-ft-tall freestanding screen wall that continues the exterior cladding of the hospital past the ambulance garage and in front of the parking garage. The screen wall is built with 10-ft-deep braced frames spaced at 28 ft and tied together with structural steel to brace them out-of-plane.

The project was constructed on a very constrained, triangular-shaped urban site with a major state highway running diagonally

along the north side of the site and the existing hospital to the west, south, and east. This provided very little laydown space, which made it necessary to have accurate, on-time delivery of materials to the site to allow steel erection to continue smoothly. This required steel fabricator Drake-Williams Steel to organize the truckloads of steel well in advance to ensure the steel members necessary for erection on a specific day were delivered in the morning on the day they were needed day or the evening before.

The project is the first building in Nebraska to use ASTM A913 Grade 65 steel, specifically for columns weighing more than 90 lb per ft. Historically, this grade has only been used in high-rise structures, but the Hubbard Center project showed that there can be significant cost savings, even on low-rise buildings, by switching to higher-strength steel. Higher yield strengths can be beneficial for columns,

resulting in smaller, lighter columns—and also more efficient ones. The design team realized that while the 65-ksi material was 30% stronger than 50-ksi material, the cost difference was less than 5%. In the end, using ASTM A913 Grade 65 steel for the heavier column sections saved the project another \$160,000.

### True Integration

The IPD process was crucial to the project's success. This method takes the traditional owner and design and construction teams and fuses the individual aspects into a holistic approach to determine what is best for everyone on the project. Typically, IPD speeds up construction and makes the process more efficient. Not only was the Hubbard Center the first IPD project in Nebraska, but it's also one of the largest in the U.S. and has proven the benefits of the IPD process in terms of both schedule and construction cost.

Through the IPD process, the structural design team at HDR worked alongside Drake-Williams and erector Topping Out to develop the structural system. At the latter companies' suggestion, the HDR team redesigned the beam-to-column web connections to allow the beams to swing into place without tipping out the columns, significantly reducing the steel erection schedule. The combined team also delivered the steel mill order six months earlier than scheduled, thus locking in pricing and mill schedules and saving more than \$500,000 on the steel package.

---

### Not Just Bigger but Also Better

Prior to the Hubbard Center, Children's Hospital was typically near full capacity—about 95% occupancy during the week and 85% on weekends—and the ideal occupancy rate for a hospital like Children's is near 80%. The expansion offers more space and allows the facility to hire more physicians with more complex specialties. It's also home to the most advanced care, introducing technologies that did not previously exist and serving more specialized, complex healthcare needs. In addition to NICU, PICU, Cardiac Care Unit, and imaging center, the facility includes a cancer and blood disorder unit, improving infection control for immunocompromised patients and allowing children out of their rooms as much as possible. Further, more robust programs and services are now possible, including a colorectal center, neuro-oncology, neurosurgery, fetal surgery, expanded pain management, transitional care, and behavioral health.



above and below: The building's signature screen wall is built with 10-ft-deep braced frames spaced at 28 ft and tied together with structural steel to brace them out-of-plane.





The project is the first building in Nebraska to use ASTM A913 Grade 65 steel, specifically for columns weighing more than 90 lb per ft.



Through the IPD process, the structural design team at HDR worked with fabricator Drake-Williams and erector Topping Out to develop the structural system.



Steel columns support the beams and girders, while steel braced frames resist lateral loads and are located next to the exit stairs and elevators to reduce their impact on floor plans.

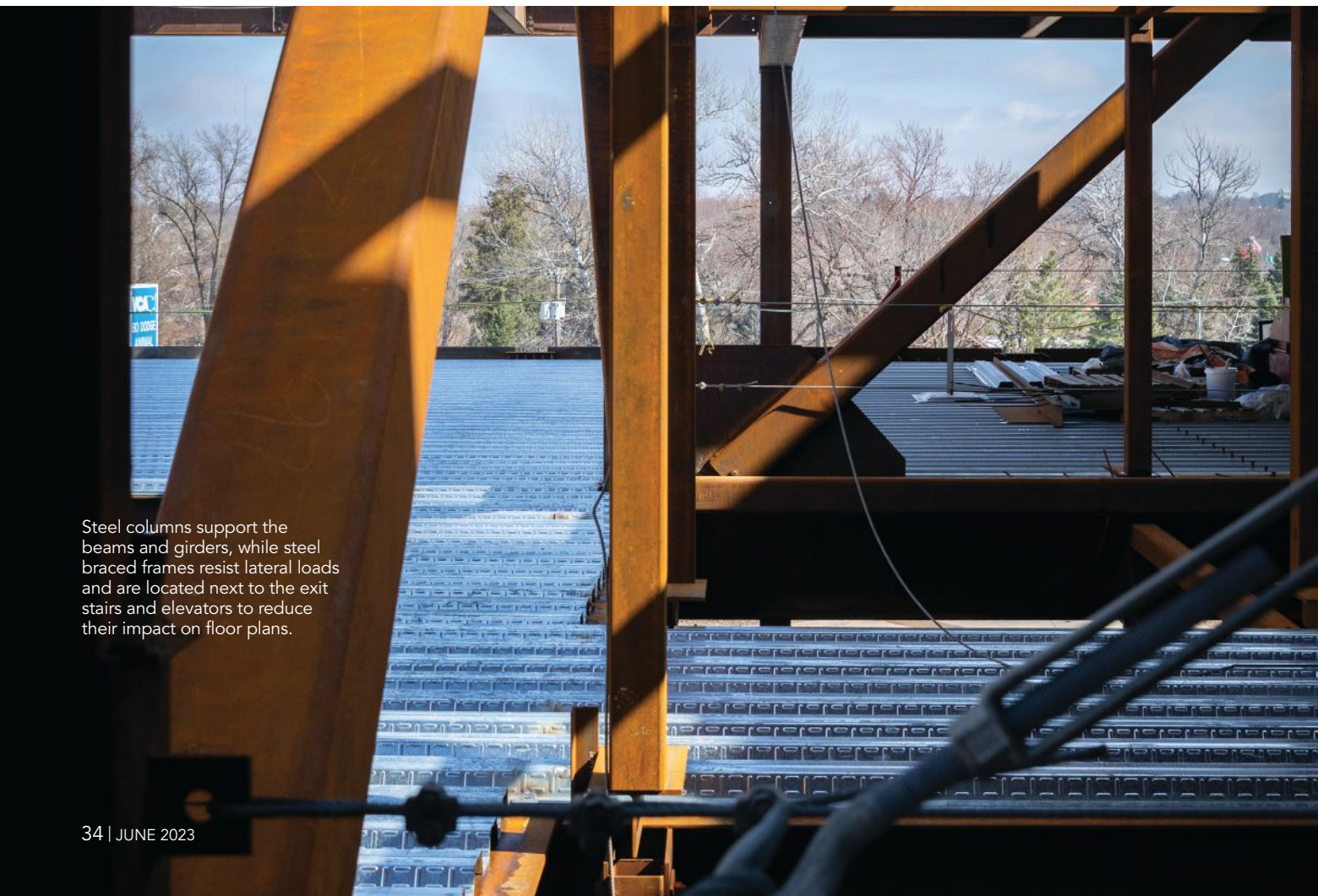

# Curving the Circuit



## 2015 IDEAS2 Merit Award Winner: Circuit of the Americas (COTA)

Landmark 251' tall observation tower providing a 360 degree panorama view of the circuit with capacity for 10,000 spectators. CMRP provided 35 tons of curved steel that included 73 pieces of curved 8" sch 40 pipe that start out at a tight 96" centerline radius and then get a slightly larger 360" radius before opening up to a large 1,349" radius at the bottom of the tower.



**CHICAGO METAL**  
**ROLLED PRODUCTS COMPANY**

Call us at 866-940-5739  
CHICAGO • KANSAS CITY  
[cmrp.com](http://cmrp.com)



**1 Angle Leg Out** We bend ALL sizes up to:  
 10" x 10" x 1" Angle

**2 Angle Leg In**  
 10" x 10" x 1" Angle

**3 Flat Bar The Hard Way**  
 24" x 12" Flat

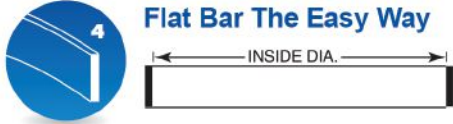
**4 Flat Bar The Easy Way**  
 36" x 12" Flat

**5 Square Bar**  
 18" Square

**6 Beam The Easy Way (Y-Y Axis)**  
 44" x 335#,  
36" x 925#

**7 Beam The Hard Way (X-X Axis)**  
 44" x 285#

**8 Channel Flanges In**  
 All Sizes

**9 Channel Flanges Out**  
 All Sizes

**10 Channel The Hard Way (X-X Axis)**  
 All Sizes

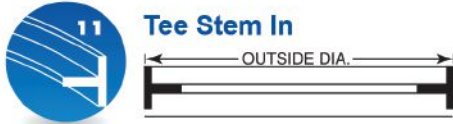
**11 Tee Stem In**  
 22" x 142<sup>1</sup>/<sub>2</sub># Tee

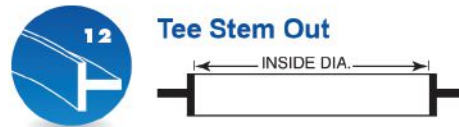
**12 Tee Stem Out** We bend ALL sizes up to:  
 22" x 142<sup>1</sup>/<sub>2</sub># Tee

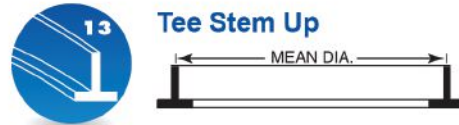
**13 Tee Stem Up**  
 22" x 142<sup>1</sup>/<sub>2</sub># Tee

**14 Angle Heel In**  
 8" x 8" x 1" Angle

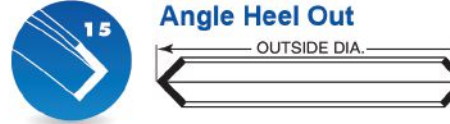
**15 Angle Heel Out**  
 8" x 8" x 1" Angle

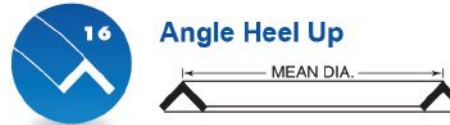
**16 Angle Heel Up**  
 8" x 8"x1" Angle

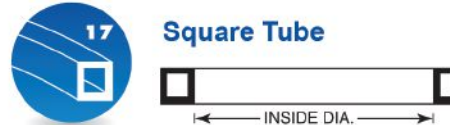
**17 Square Tube**  
 24" x 1<sup>1</sup>/<sub>2</sub>" Tube

**18 Rectangular Tube The Easy Way (Y-Y Axis)**  
 20" x 12" x 5/8" Tube

**19 Rectangular Tube The Hard Way (X-X Axis)**  
 20" x 12" x 5/8" Tube

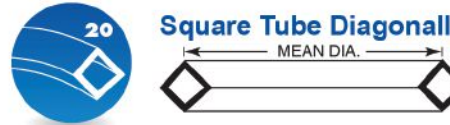
**20 Square Tube Diagonally**  
 12" x 5/8" Square Tube

**21 Round Tube & Pipe**  
 24" Sched. 80 Pipe

**22 Round Bar**  
 All Mill Produced Sizes

We also roll stair stringers, helical hand rails, off-axis bends, formed shapes and extrusions.

Visit [cmrp.com](http://cmrp.com) for more information.



**CHICAGO METAL**  
**ROLLED PRODUCTS COMPANY**

CHICAGO • KANSAS CITY





above and below: In all, the project incorporated 3,569 tons of steel. Typical bay sizes are 32 ft by 32 ft, and typical columns are W14 sections, with the largest being a W14x730 located at a couple of braced frame locations.



HDR and Drake-Williams also collaborated to design the stairs early in the project, resulting in additional time for fabrication. This allowed the stairs to be erected alongside the main frame steel and provided access for construction workers to move about the building during the rest of construction. This approach improved safety and eliminated the need to rent, erect, and constantly inspect scaffolding stairs.

The IPD team was located onsite together during the project, which allowed for real-time discussions between design and construction partners, resulting in less rework. The IPD strategy allowed the team to begin construction prior to submitting its final bid package for interior fit-out and final work. At the heart of IPD is collaboration, and in the case of the Hubbard Center, it made every step of the job more efficient, with less downtime and waste, while optimizing results.

“Everyone has skin in the game, including us as owners,” said Dr. Richard Azizkhan, Children’s Hospital and Medical Center’s former CEO. “What this does is choreograph the whole building process so that there is no rework. It is all planned out very carefully, and it ends up saving about 30% in construction time. Just as importantly, it saves about 20% to 25% on the overall cost of construction. It has really been a wonderful process for us.” ■

#### Owner

Children’s Hospital and Medical Center, Omaha

#### General Contractor

Kiewit Building Group, Omaha

#### Architect and Structural Engineer

HDR, Omaha

#### Steel Team

##### Fabricator

Drake-Williams Steel  Omaha

##### Erector

Topping Out, Inc. (Davis Steel Erection)  Gretna, Neb.



**James Savage** ([james.savage@hdrinc.com](mailto:james.savage@hdrinc.com)) is a professional associate and senior structural engineer with HDR in Omaha.

West Virginia University's new steel-framed Reynolds Hall  
is designed to innovate business education in the state and beyond.

# Building Business

BY BLAKE RHOOD, PE, AND JASON SQUITIERE, PE





**“PROGRESS DEMANDS INNOVATION”** was the thinking when West Virginia University planned Reynolds Hall, the state-of-the-art home to its John Chambers College of Business and Economics.

The building, which opened this past fall, reflects the rapidly changing world of global business, with spaces like a Wall Street-worthy trading room, social media center, cybersecurity center, and data analytics room. It also incorporated rapidly erectable steel framing, including a new steel pedestrian bridge, to make it happen.

Putnam Investments CEO Bob Reynolds, a 1974 finance graduate of WVU, envisioned a program that would be a change agent for students, faculty and staff, the state of West Virginia, and the world beyond. His \$10 million donation started the campaign for a new building that would spark that innovation.

The university chose a location along the Monongahela River, then the site of the WVU Field House, later renamed Stansbury Hall after former WVU Athletic Director Harry Stansbury. Stansbury Hall was the home of WVU Basketball until 1970 and was demolished in 2019 to make way for Reynolds Hall.

At 108,000 sq. ft, Reynolds Hall more than doubles the former John Chambers College of Business and Economics building. It features a 300-seat lecture hall, multiple lounge spaces, a trading room, a hospitality simulation lab, an economic simulation lab, a learning pavilion, an Ideation Hub, a social staircase, two collaborative classrooms, a graduate classroom, 17 study rooms, and 175 offices for faculty and staff. In a nod to the site’s history, part of the Stansbury Hall basketball court is mounted on a wall on the third floor.

.....

West Virginia University’s Reynolds Hall, the state-of-the-art home to the John Chambers College of Business and Economics, was designed to reflect the rapidly changing world of global business.

## From Vision to Reality

West Virginia University selected two architectural firms to create the vision set forth by Bob Reynolds and the stakeholders who would teach and conduct research in the new facility. Global design and architecture firm Gensler was chosen as the design architect in collaboration with Strada, the architect of record. Gensler progressed the vision from schematic design through design development. Strada led the project’s construction documentation phase.

A fast-track schedule was needed to open Reynolds Hall in less than three years. General Contractor PJ Dick was engaged at the first stages of the design to supply invaluable feedback on scheduling, constructability, and estimating. The structural drawings progressed to a bid level by the end of the design development phase, and foundation installation began nearly six months before construction documents were completed. This required early structural coordination with the architecture teams. After design development was completed and the structural documents were issued for bid, PJ Dick brought in steel fabricator Sippel Steel Fab to refine the complex steel detailing on the project.

The building is predominantly clad in red brick and buff stone to reflect the surrounding campus buildings. A one-story, 300-seat auditorium/lecture hall on the north side is clad in varied gray ultra-high-performance concrete (UHPC), a reference to the gray slate roof of the historic Woodburn Hall nearby.

“The sculptural auditorium is shaped by its location at the end of the site, a confluence formed between Beechurst Avenue to the east and a new pedestrian plaza to the west,” said Brian Watson, design director at Gensler. “These two circulation routes carve into the auditorium similar to the weathered rock shelf along the Monongahela River below. The sculpted form shields pedestrians

Reynolds Hall uses 1,470 tons of structural steel framing to support the concrete-on-metal-deck floors and 145 tons of steel for façade support.

.....

from the road while pulling visitors into the new building lobby.”

### Made of Steel

Reynolds Hall uses 1,470 tons of structural steel framing to support the concrete on metal deck floors and 145 tons of steel for façade support. The steel framing’s complexity was highlighted by the lecture hall.

The exterior walls feature an angled profile using UHPC panels that are sloped and angled. Hollow structural section (HSS) girts support the UHPC panels at each boundary condition where the façade changes in angle and/or slope. The steel girts are tied back to steel columns supporting the sloping roof and back to soldier columns required at angular changes in the façade.

The faceted lecture hall enclosure intentionally penetrates the north glass façade side of the six-story building proper, allowing the UHPC exterior panels to seamlessly flow into the lobby and pre-function spaces. The interface created the need for a line of steel with varying elevations to support the roof deck of the lecture hall while also supporting the glass façade above its roof. Next to the lecture hall within the lobby is the Ideation Hub, which appears to float above the lobby and overlook social stairs modeled after the stairs at Googleplex in Silicon Valley.

The Ideation Hub is hung from the steel framing at the floor structure above. In order to create the appearance of floating, this structure was framed using three strategically located hangers and four cantilevered beams. Two of the three hangers are at the mid-span of long-span (48 in.) beams at the third floor. Deeper and stiffer beams were used at the third floor, so the combined deflection of the third- and second-floor beams did not exceed code limits, and PJ Dick sequenced the construction such that the third floor was built before the hung area of the second floor was finished.

Another design challenge came from the building’s location. Reynolds Hall is situated along the Monongahela River, but the beautiful location at the bend in the river puts it within the ASCE 7 definition of wind exposure “D” in two directions.



In order to make the Ideation Hub (framing above, completed below) appear to float, this element was framed using three strategically located hangers and four cantilevered beams.

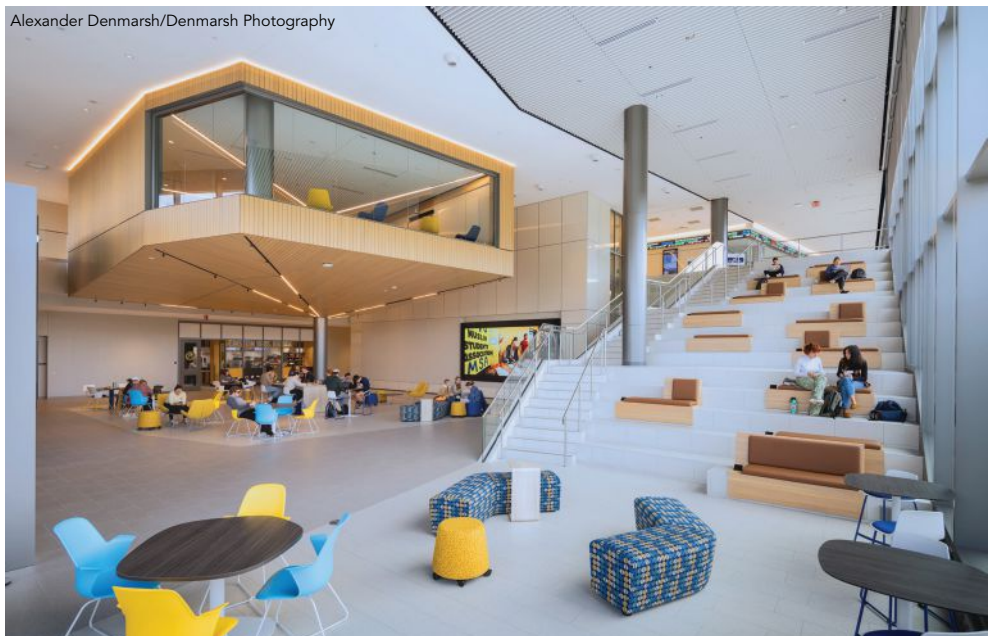





Jennifer Shephard/WVU

above: The building is located along the Monongahela River.

below: The main lobby, which features the social stair and Ideation Hub.

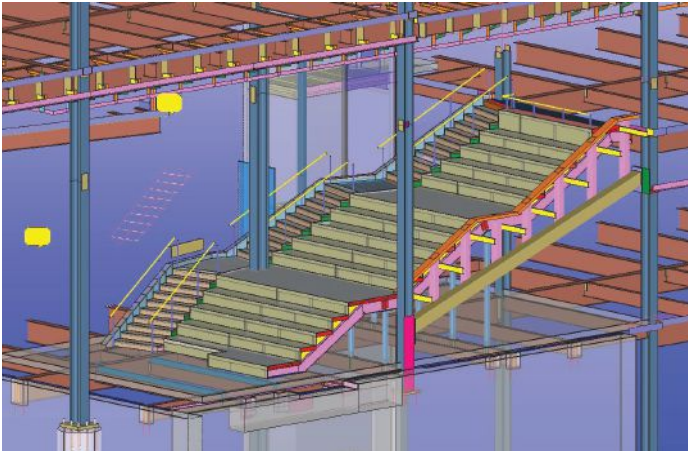

above: A 3D model of the social stair, which was designed to emulate the stairs at Googleplex in Silicon Valley.

below: The team designed a lateral load-resisting system featuring a combination of braced frames and moment frames to resist the increased wind loads on the building.



Brian Peisinger/WVU

Strada Architecture

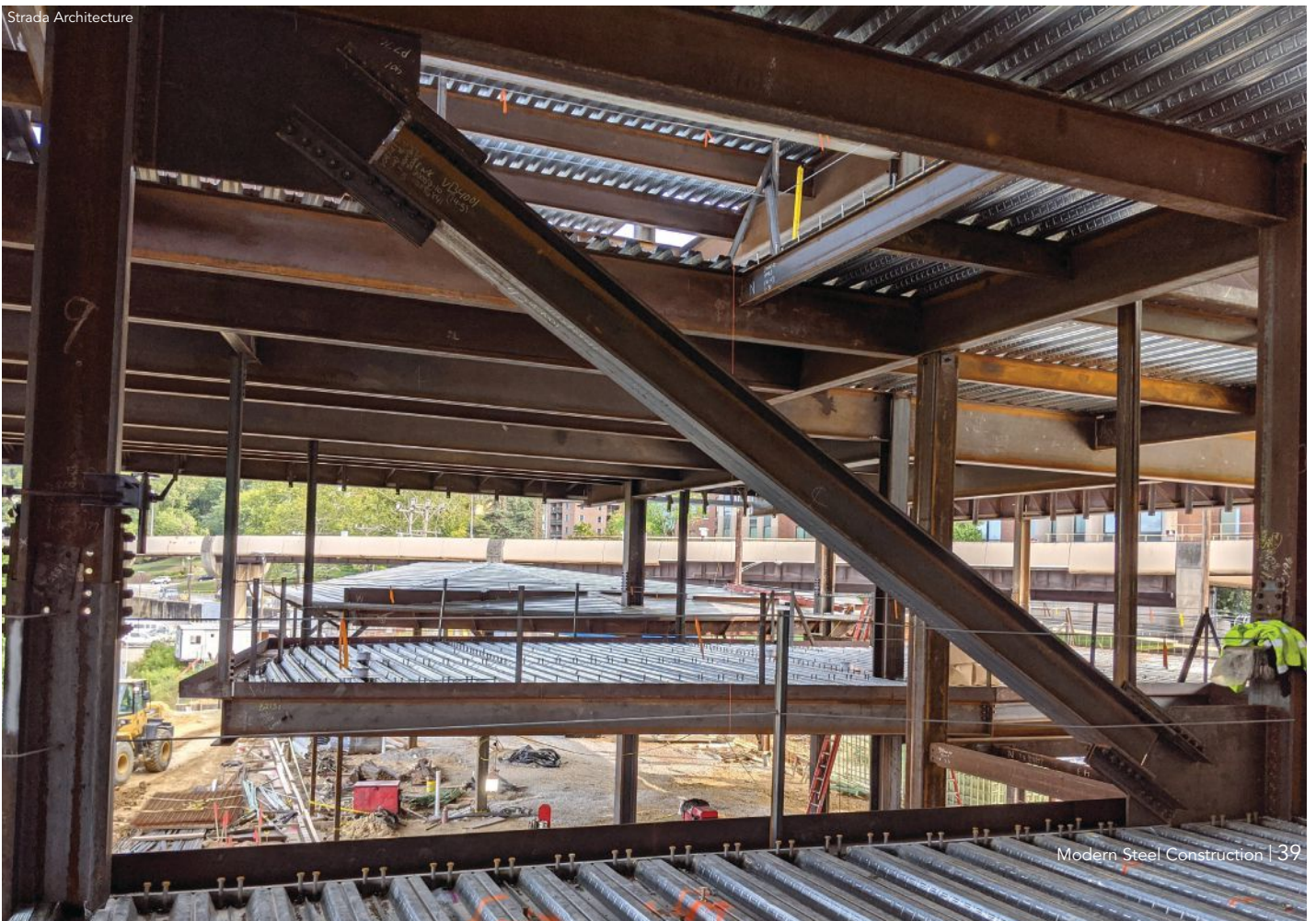

This led to the team designing a more robust lateral load-resisting system featuring a combination of braced frames and moment frames to resist the increased wind loads on the building.

The north side of the building has two moment frames, both built with wide-flange columns and beams. One is at the entry/lobby area, a two-story space where the client didn't want to see braces. This two-story moment frame uses W14x311 columns. The second is located where the lecture hall ties into the façade and near where a stair connects the levels, an area that didn't allow for braces, which would have impacted lobbies and egress areas.

At the first two floors, the typical moment frame column size is W12x210, and the sizes are reduced every two floors. The top floor features W12x87 columns for the moment frames, and typical beams in moment frames are heavy W14 and W16 shapes to limit deflection. Braced frame sizes and configurations are varied to work around architectural and mechanical constraints. Braced frames include single diagonal W12 braces with offsets from the beam/column work points, other single diagonals that alternate corners at alternate floors, and chevrons with working points offset from beam centers. Typical diagonals range from W12x58 to W12x152, and column sizes range from W12x279 to W12x40.

## Bridging the Community

The east side of the building is next to a bustling thoroughfare, Beechurst Avenue (U.S. Highway 19), which separates the building

from campus and the WVU Personal Rapid Transit (PRT) system that students, faculty, and staff use to navigate the campus. Interruption of the arterial traffic flow was not permitted, and an aging pedestrian bridge built in 1972 that spanned over Beechurst Avenue had to be replaced.

The design of the resulting new 31-ton structural steel pedestrian bridge was largely dictated by geometric clearances over Beechurst Avenue. The truss profile follows the slope of the supported bridge slab, so the required AASHTO and West Virginia DOT roadway clearances could be maintained while still fitting below the existing structure of the WVU PRT system above the pedestrian bridge.

The architectural design mandated an "open-to-the-sky" bridge, with no cross-bracing members between the panel points of the truss top chords. In order to achieve this goal, the design engaged the bottom truss chords as torsion beams, forming a U-shape structure at panel points. This "U" was comprised of a bridge floor infill beam, a truss bottom chord HSS member at each side of the bridge, and cantilevered vertical web members. The U-shape structure allows the included truss web members to cantilever vertically upward to the top chord of the truss, supplying the required strength and stiffness to brace the top chord of both trusses.

While the new pedestrian bridge replaced the 1972-era pedestrian overpass superstructure, the original foundations were found to be in good condition and were analyzed for potential reuse. The



above and below: The architectural design of the pedestrian bridge mandated an "open-to-the-sky" approach with no cross-bracing members between the panel points of the truss top chords.



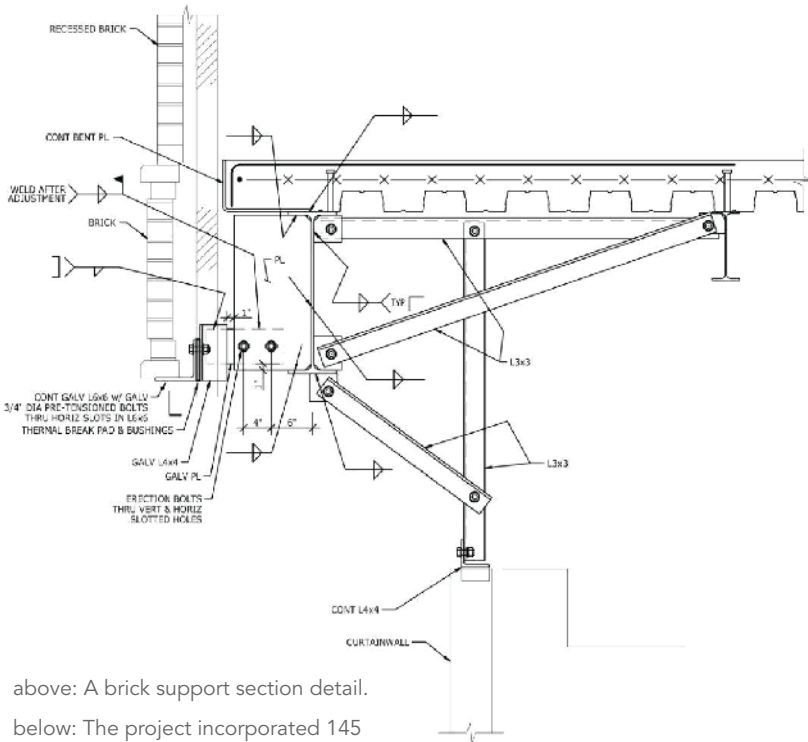

above: A brick support section detail.

below: The project incorporated 145 tons of steel for façade support.

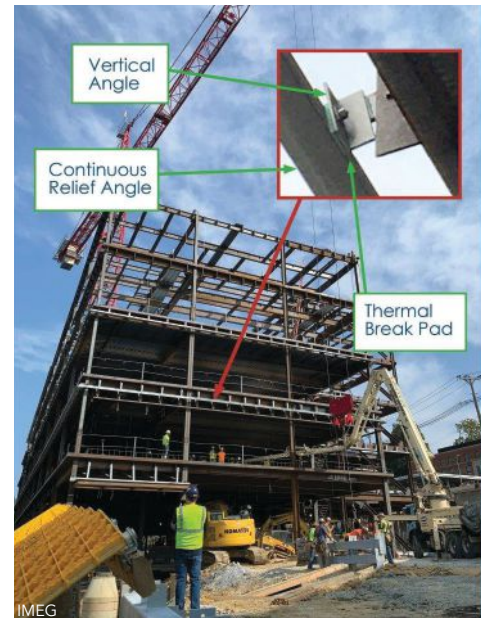

## Making a Break

The façade of the six-story building is predominantly hand-laid brick. The project mandated that the thermally exposed structural steel brick relief angle framing be isolated to limit the effects of thermal bridging. A unique solution was developed using recommendations from both AISC Design Guide 22: *Façade Attachments to Steel Framed Buildings* ([aisc.org/dg](https://www.aisc.org/dg)) and thermal break manufacturer Fabreeka to maintain thermal separation while also maintaining structural support of the prominent brick façade.

The brick is relieved by a continuous steel angle hung from short vertical angles welded to a knife plate and connected back to a stiffener plate on the spandrel beam. The knife plate and gusset plate use slotted holes to provide adjustability. The thermal separation is achieved between the continuous relief angle and the supporting L4x4 verticals via Fabreeka thermal break pads with bushings around the connecting bolts. This detail allowed for the necessary adjustability that a brick façade demands while keeping thermal separation between the exterior steel framing and the building interior.



Alexander Denmark/Denmark Photography

existing west foundation is a pile cap supported by a pair of drilled shaft foundations and was determined to be suitable to support the new bridge. The existing east foundation consisted of a pile cap supported on steel H-piles. Despite the availability of existing structural documents, the information included proved inadequate for analyzing the existing H-piles. Siting of the east foundation was exceptionally tight, flanked by Beechurst Avenue to the west, a deteriorating concrete retaining wall to the east, and the WVU PRT structure just overhead. The tight quarters mandated a micro-pile solution that ultimately supported the east bridge foundation and the existing concrete retaining wall.

The bridge was fabricated in three pieces and field-welded on the side of the road on the north side of the site and then installed by AISC-certified erector Century Steel Erectors. The bridge is a warren truss featuring HSS8×8 web members with HSS20×8 bottom chords and an HSS8×8 top chord. The truss cantilevers off the bridge piers on each end, approximately 20 ft on the east side and 6 ft on the west side. The bridge is sloped on each end to meet the required WVDOT highway road clearance. At the east side, it slopes

## For the fabricator looking to maximize

their production time and profits, the Lightning Rail is a smart decision.

Eliminate the countless manual labor hours involved in laying out handrails, stair stringers, trusses, and more!

- ✓ Cut fabrication time by more than 50%
- ✓ Ensure the highest level of accuracy
- ✓ Boost your profit margins
- ✓ Lay out complex geometry in seconds
- ✓ Designed to replace your existing fabrication table

"The guys love it. They jumped right in on it and have been working to make the most use of it. Great purchase."

**Nat Killpatrick**  
Basden Steel Corporation

"I think it's fair to say that this machine continues to exceed our expectations. We are very happy with it."

**Chief Operating Officer**  
Koenig Iron Works



**SPEED, ACCURACY, &  
HIGHER PROFIT MARGINS**

**603-402-3055**  
AutomatedLayout.com



  
Patent No. US 10,576,588 B2  
Patent No. US 11,426,826 B2

down to meet the lower elevation of the PRT station landing, and at the west side, it slopes down to meet the lower elevation of the building's elevated terrace. The middle part of the bridge is flat.

Limiting the disruption of the heavily trafficked Beechurst Avenue, installation occurred during overnight hours on a Saturday in December 2020. The prefabricated bridge was staged along the shoulder of Beechurst Avenue in preparation for placement onto its final resting position. In a single pick, the bridge was lifted with a 200-ton crawler crane, walked down the street, rotated into place, and dropped onto the piers. In mere hours, erection was complete, and Beechurst Avenue was reopened to Sunday morning traffic.

"It's an honor to take part in this innovative, cutting-edge, advanced space at West Virginia University," said Malcolm Bland, PE, principal and client executive with the Harman Group, now IMEG. "Working alongside a stellar project team, our engineers were able to overcome the challenges of Reynolds Hall being situated on the riverbank and separated from campus by Beechurst Avenue. Knowing we took part

in the design of this amazing building that will help transform entrepreneurship for bright minds of the future is quite rewarding."

**Owner**  
West Virginia University,  
Morgantown, W.V.

**Design Architect**  
Gensler, New York

**Architect**  
Strada, Pittsburgh

**Structural Engineer**  
The Harman Group, now IMEG,  
Philadelphia

**General Contractor**  
PJ Dick, Pittsburgh

**Steel Team**

**Fabricators**

Sippel Steel Fab   
Ambridge, Pa. (building, also  
connection engineer)

Littell Steel Company   
New Brighton, Pa. (pedestrian bridge)

**Detailer**

H&R Steel Detailing LLC   
Liberty, Mo.



**Blake Rhoad** and **Jason Squitiere** are both associates and senior structural engineers with IMEG.

# STEEL CONNECTIONS. SIMPLIFIED.



✓ **ADJUSTABLE** designs

✓ **RAPID** installation

✓ **NO ON-SITE** welding

Strut  
Metal Framing

- Strut channel
- Spring nuts
- Strut fittings
- Pipe Clamps

Expansion Bolts  
for Steel

- Blind connections for Structural Steel and HSS

Girder Clamp  
Connections

- Beam-to-Beam
- HSR clamps
- Permanent OR Temporary connections



 [CustomerService@StrutAndSupply.com](mailto:CustomerService@StrutAndSupply.com)

 [www.StrutAndSupply.com](http://www.StrutAndSupply.com)

## Strut & Supply, Inc.

847.756.4337

Barrington, IL 60010





# Southern Exposure

BY JUSTIN BARTON, SE, PE

Exposed steel scores the winning goal as the dominant architectural characteristic at Nashville's Major League Soccer stadium.

**GEODIS PARK**, home of Major League Soccer's Nashville SC, is the largest purpose-built soccer stadium in the United States—and its design prominently features exposed structural steel in an effort to capture Nashville's industrial roots.

Upon its completion in April 2022—seven weeks ahead of schedule—and officially opening with Nashville SC's first home game on May 1, 2022, the project helped reinvigorate the Nashville Fairgrounds, a historic and underutilized site a couple of miles south of downtown, bringing new life into the area by spurring new revenues and commercial development.

Design for the 30,000-seat stadium began in earnest in July 2019, with a planned opening 33 months later in May 2022. To help the stadium capture the heart of Nashville, raise the

industry standard for speed and accuracy of project delivery, and open before the start of the 2022 MLS season, Walter P Moore incorporated an innovative structural engineering design by developing a new and fully integrated project delivery process called ConnectTID or “transformative integrated design for buildings.”

This design approach limited schedule uncertainty, reduced costs and risks for the owner—Metro Nashville Sports Authority—and provided a better outcome for the project stakeholders. The integrated design process allowed Walter P Moore to maintain design and material quantity control throughout the complex engineering effort and coordinate all areas of design throughout the stadium.

GEODIS Park is the largest purpose-built soccer stadium in the U.S.



© Tom Harris

## Integrated Design Process

Walter P Moore integrated its design phase construction deliverables into a fabrication-ready level of development (LOD) 400 models for the steel procurement (LOD 400 is the construction stage and includes fabrication, assembly, and installation of components). The higher-than-standard fidelity and level of completeness of the steel procurement documents resulted in tighter bids, all of which came in 10% to 20% under budget—approximately \$3 million in savings.

The architect of record and design architect, Populous, and the design architect, Hastings Architecture, worked in concert with Walter P Moore on the exposed steel connections in a 3D modeling environment to create an elegant and consistent look throughout the stadium.

“Engaging in the fully integrated structural engineering design process gave us the opportunity to have much more control of the look and feel of the steel design and detailing,” said Chris Melander, an architect at Hastings. “Normally, the advanced steel detailing will occur in a vacuum without input from the architect. This process allowed us to be nimbler and make the steel connections a feature of GEODIS Park.”

As a result, the fully integrated structural engineering design process, which occurred in real time, allowed for early and productive coordination among the project team.

“Seeing real-time updates made responding to structural changes fast and efficient, and ultimately led to a more visually appealing and easier-to-deliver product,” said Nikki Smolenski, an architect at Populous.

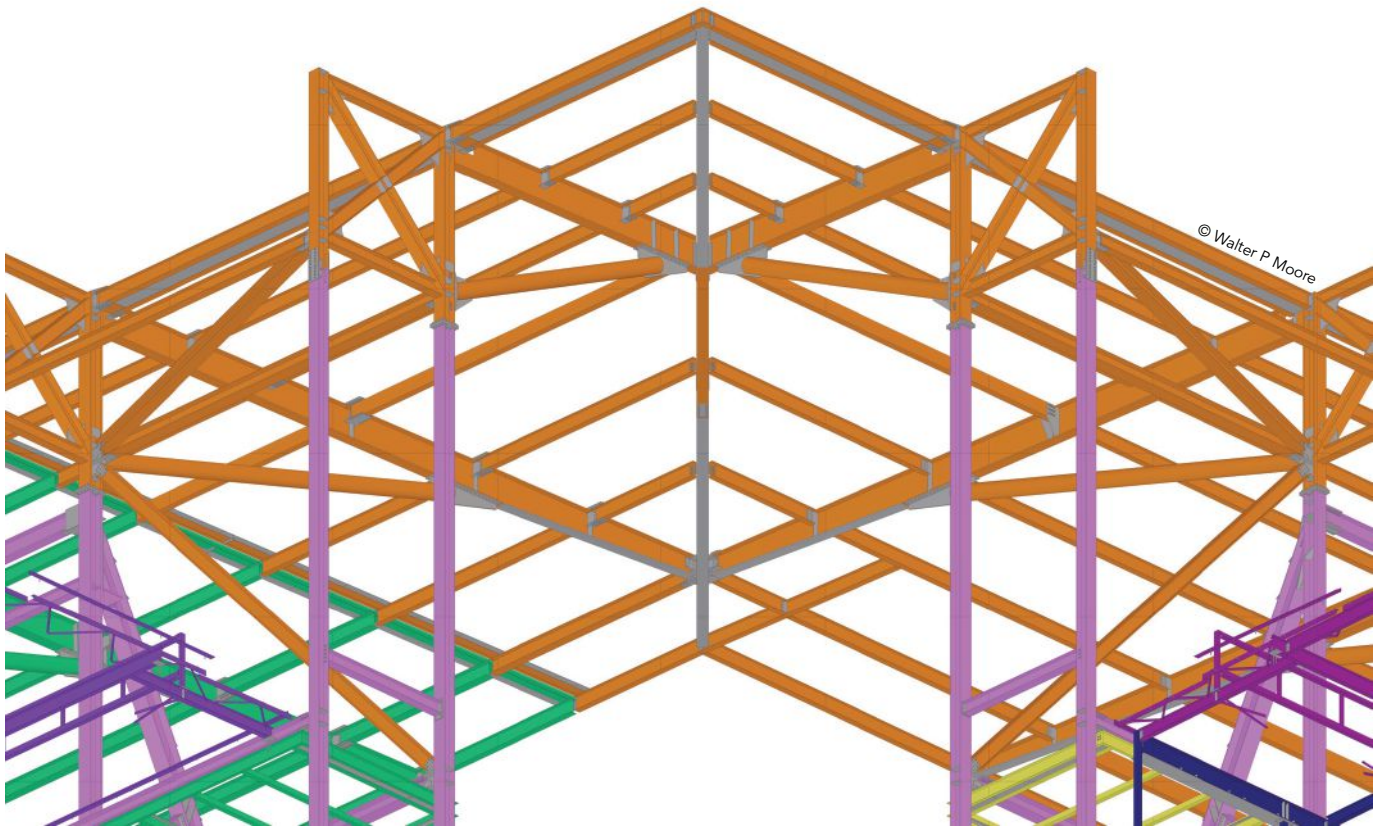

The main canopy enhances the architectural expression of the stadium with hard 90° corners at each entry and a rectangular opening over the pitch.



The process was beneficial to the construction manager Mortenson as well in regard to the steel detailing.

“The fully integrated design process allowed the project team to generate shop drawings earlier than the traditional buy-out method,” said Tom Clark, project executive at Mortenson. “This improved our ability to begin the steel detailing process at the front end of the project.”

Additionally, the early design completion of the connections allowed for early coordination with the bevy of other trades on the project, such as the MEP contractors, which proved to be an effective cost-saving effort. With careful advance coordination, conduit, plumbing, and additional utilities were integrated into the structure while maintaining the structural steel as the main architectural feature (the project incorporates roughly 6,000 tons of structural steel).

“By incorporating the connection design into the scope of the design team, we were able to tailor the connections to the overall design

intent, coordinate pathways for stadium utilities without detracting from the beauty of the structure, and begin steel fabrication much sooner than the traditional delivery method,” Melander noted.

The improved deliverables also resulted in fewer change orders, reduced field problems, and improved coordination allowing steel erection to finish weeks ahead of schedule.

### Detailed Modeling

The extensive detailed modeling produced by the Connect-TID process required more effort than a traditional process, so a specialized Tekla detailing team worked simultaneously with the design team. By performing both the design and fabrication modeling, potential conflicts and issues were resolved in advance virtually rather than in the field, saving time and money.

“The level of detail in the 3D Tekla model allowed our team to review all connections prior to procurement, allowing us to





© Tom Harris

above and below: The stadium's 360° canopy steel cantilever extends 85 ft over the upper bowl

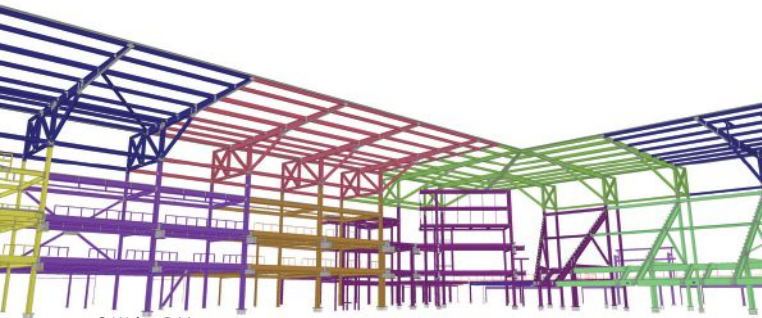

© Walter P Moore

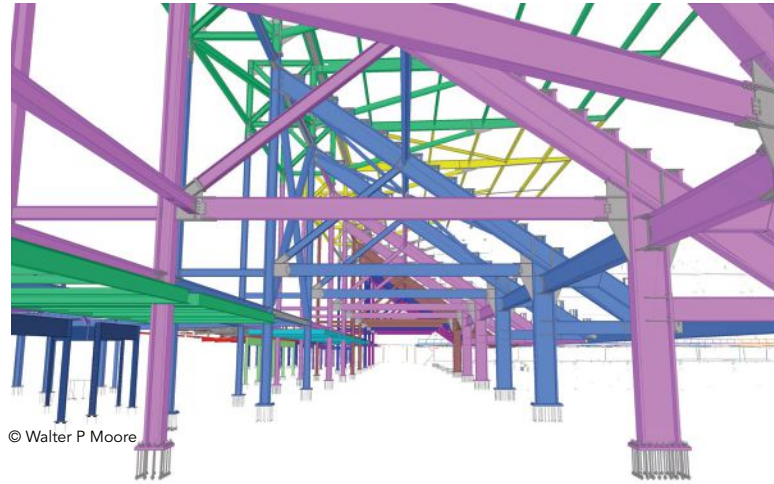

© Walter P Moore

right and below: Steel framing over the 65-ft-wide concourses.

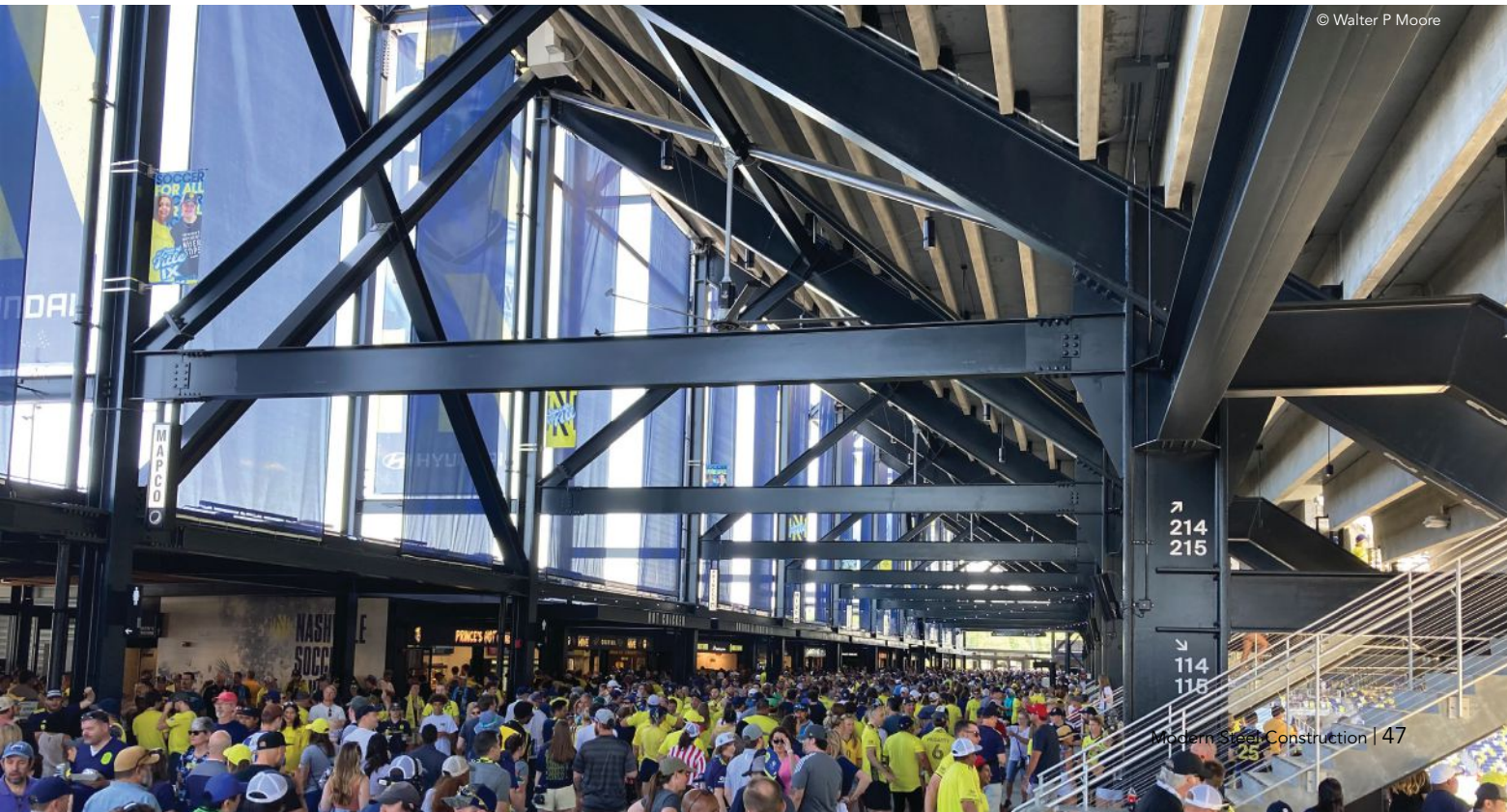

© Walter P Moore

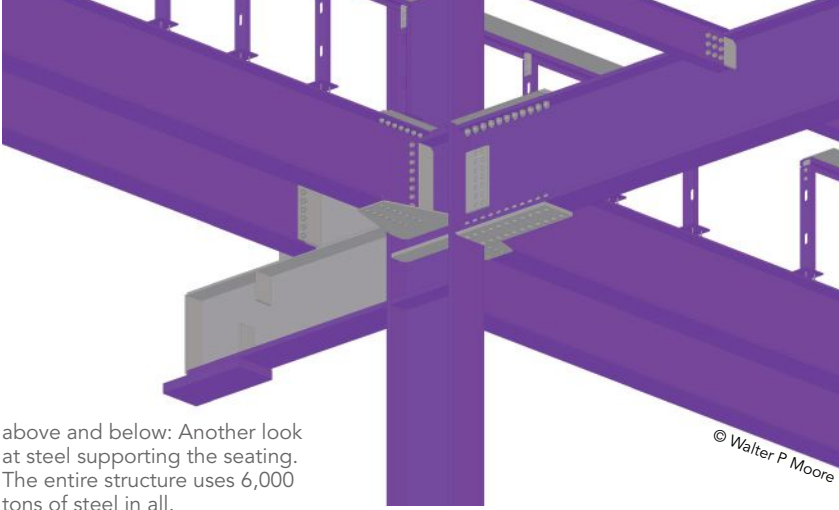

above and below: Another look at steel supporting the seating. The entire structure uses 6,000 tons of steel in all.

© Walter P Moore



© Walter P Moore



GEODIS Park can seat up to 30,000 Nashville SC fans.

© Tom Harris

confirm appearance, coordinate with other disciplines, and avoid surprises in the field,” Smolenski explained.

Because steel played such an important role in the design, it was necessary to have two steel models—one by Hastings for advancing the aesthetic design of the structure and the structural design and analytical model by Walter P Moore.

“As the design phases progressed, both models received more definition as sizes were selected and critical connections were designed to tailor the character of the stadium,” Melander says.

The model was designed in Revit and visualized in Enscape renderings and virtual reality. As the design progressed, the structural model migrated into Tekla for full detailing. Hastings reviewed the Tekla model for conformance with the design intent and reviewed the steel shop drawing submittals through a custom application by DBM Vircon that allowed the design team to make comments on individual steel elements that needed correction prior to fabrication.

The steel modeling was also crucial in resolving conflicts before and during construction. The project team was able to meet and visualize all components using the software so that a positive and cost-effective solution could be achieved.

“The steel structure on GEODIS Park is the architectural feature, and using the model allowed the team to review and ensure the bolted connections were oriented in a manner that best suited the design intent,” said Ron Stodolka, senior project manager at Mortenson. “That same model was used by field crews to visually inspect and verify those connections were maintained as designed and desired.”

## Exposed Structural Steel

As fans enter GEODIS Park, they are greeted by numerous exposed structural features, including:

- A 360° canopy steel cantilever that extends 85 ft over the upper bowl
- A signature steel X-frame, incorporating W14s for the columns and cross-bracing members, at the stadium canopy around the bowl
- A 65-ft-wide concourse with fully exposed connections
- Steel girders (spaced at 27 ft on center) paired with mass timber decking at the entry canopies. Fastener holes for connecting the steel to the timber were pre-drilled in the shop, which then made it easy for the wood installer to make the connections. (For more information on designing steel-wood hybrid framing, take a look at AISC Design Guide 37: *Hybrid Steel Frames with Wood Floors*, available at [aisc.org/dg](http://aisc.org/dg).)

The exposed structural steel is the dominant architectural aesthetic of the stadium. In concert with the mass timber, the exposed steel fulfills the architect's desire to have the new MLS stadium embrace the structure as an opportunity to recall the neighborhood's industrial heritage, as well as evoke a modern aesthetic.

All exterior steel received a two-part high-performance paint system. While the project didn't include a specific AESS designation, it did involve additional requirements, such as grinding welds smooth and having bolts facing the same direction, for the exposed steel.

The 152,600-sq.-ft main canopy, which enhances the architectural expression of the stadium with hard 90° corners at each entry and a rectangular opening over the pitch, created a significant but complex and challenging design when it came to the steel erection.



.....  
All exterior steel received a two-part high-performance paint system.

# INNOVATE FREELY



Baystate Noble Hospital, MA  
Architect: Steffian Bradley Architects  
Structural Engineer: BVH Integrated Services  
Steel Fabricator: Melting Point Welding & Fabrication  
Photography by Michael Worthington

**CREATIVE.  
INTEGRATED.  
TRANSFORMATIVE.**

**CAST CONNEX®** provides custom casting design-build services for projects that benefit from a design composition unachievable by conventional fabrication methods.

**Customizable Solutions**

- Simplifies complex connections
- Ideal for architecturally exposed applications
- Resolves connections subject to very high loading or fatigue
- Economically addresses repetitive details with high-quality and consistency

**CUSTOM CASTING & UNIVERSAL PIN CONNECTOR™**

**CASTCONNEX®**  
innovative components for inspired designs

[www.castconnex.com](http://www.castconnex.com)  
info@castconnex.com | 1-888-681-8786

The main canopy is 152,600 sq. ft and includes a single propped strut creating an open structural system that is supported by an X-frame.

.....

“The canopy framing was demanding in regards to steel erection,” said Chris Cozza, project manager at LPR Construction. “In the four corners, there was a very large cantilever off of the main truss cord. This proved challenging due to the difference in deflection from one corner diagonal truss to a standard truss or square to grid truss.”

The canopy cantilevers 85 ft over the seating bowl to cover 80% of the seats and includes a single propped strut, creating an open structural system that is supported by the X-frame.

“Our crews had the model on their iPads, and this was a huge help in identifying bolt direction,” Cozza explained. “It was very important to the design team that all the bolts faced a certain direction, and having that detail in the model helped achieve this goal.”

The corner entries are the signature aesthetic of the stadium. The main canopy continues 48 ft beyond the last column line and provides a column-free space with a soaring canopy above. The four open corners create a distinctive aesthetic, allowing fans inside the stadium to see the city beyond and fans approaching the stadium to see inside. In order to create the single concourse to accommodate 30,000 fans, steel moment frames were designed with 65 ft of clear spans, while diagonal bracing was strategically placed above the concourse to maximize the use of each square foot for concessions, restrooms, and additional fan amenities.

## Uniquely Nashville

The modified steel procurement and delivery developed for GEODIS Park was a success for all stakeholders. The Metro Nashville Sports Authority received a building that met its goals of a “uniquely Nashville” venue with an exposed steel structure. The contractor, Mortenson/Messer Construction, finished ahead of schedule and below the steel budget with minimal change orders totaling less than 2% of the steel contract, and the architects had full aesthetic and coordination control over the exposed steel frame and connections. These advantages demonstrate the

.....

Upon its completion in April 2022—seven weeks ahead of schedule—the stadium officially opened with Nashville SC’s first home game on May 1, 2022





© Nashville Soccer Club

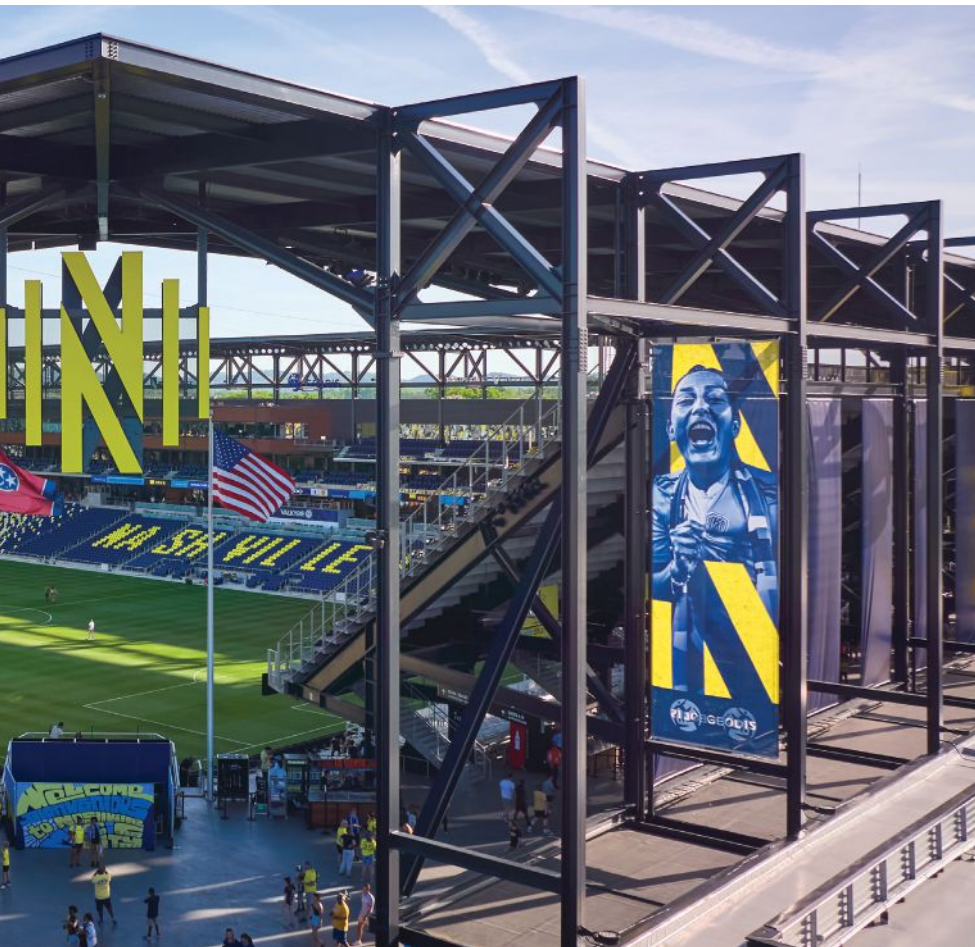

© Nashville Soccer Club

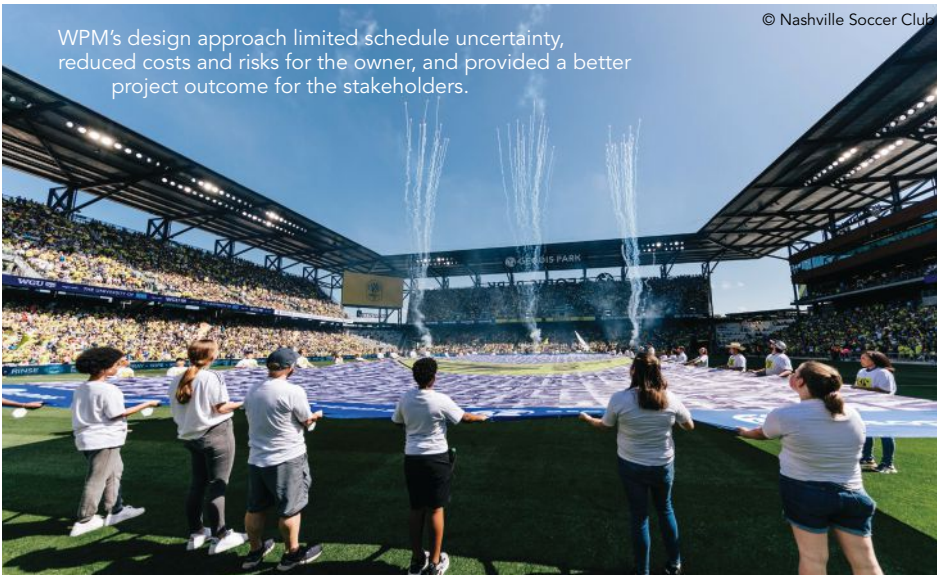

WPM's design approach limited schedule uncertainty, reduced costs and risks for the owner, and provided a better project outcome for the stakeholders.

The stadium's steel framing system is prominently expressed on the exterior as well.

additional value a fully developed LOD 400 model provides by including more information than conventional 2D drawings, specifications, and 3D models.

"The modified steel procurement process allowed the team to turn over a fully coordinated LOD 400 model to our steel fabricator, creating up-front efficiency and schedule benefits," Clark said.

By moving beyond the traditional deliverables into the fully integrated structural design process, the gap between design and construction was seamless. ■

**Owner**

Metro Nashville Sports Authority, Nashville

**Owner's Representative**

CAA ICON, Denver

**General Contractor**

Mortenson/Messer in association with Pinnacle and Business Resource Group

**Architect of Record and Design Architect**

Populous, Kansas City, Mo.

**Design Architect**

Hastings Architecture, Nashville

**Structural Engineers**

Walter P Moore, Houston (also steel detailer)  
Logan Patri Engineering, Nashville

**Steel Team**

**Fabricator**

LeJeune Steel Company   
Minneapolis

**Erector**

LPR Construction   
Loveland, Colo.

**Detailer**

DBM-Vircon , Tempe, Ariz.



**Justin Barton**

([jbarton@walterpmoore.com](mailto:jbarton@walterpmoore.com))

is a principal and senior project manager in Walter P Moore's Structural Group in Kansas City.

An aerial photograph of a modern skyscraper under construction in a dense city. The building features a prominent glass facade and a complex, multi-tiered structure. The surrounding area is filled with other high-rise buildings, streets with traffic, and a clear blue sky with scattered clouds. The overall scene captures the vibrant energy of a major metropolitan area.

# Park Avenue Premiere

BY TIM BRADSHAW, PE

The full-block 425 Park Avenue tower stands tall thanks to a collaborative approach and ASTM A913 Grade 70 steel—a first for the Big Apple.



Michael Young

**425 PARK AVENUE** is the first new full-block office tower built on Manhattan's Park Avenue in decades. And it's also the first in New York to implement ASTM A913 Grade 70 steel.

The original 1957 office tower that called the block home, once the pinnacle of modernity, has been reinvented via a partial demolition and a dramatic restructuring. The plan involved incorporating a minimum of 25% of the original structure into the new office tower, essentially melding the former into the latter.

The 815-ft-tall, 42-floor tower is topped with three steel-framed fins that soar 160 ft above the roof level. At ground level, occupants and visitors enter the building via a 45-ft-tall lobby featuring sky gardens. The design acknowledges both the building's current surroundings and the site's history, incorporating horizontal window bands that reference the Universal Pictures Building to the north, as well as vertical

white mullions as a modern reimaging of the original office building at the site.

In addition, the building was designed to achieve LEED Gold certification and lead the sustainable skyscraper pack as New York's first WELL-certified building. The WELL Building Standard takes a holistic approach to health in the built environment, putting occupants' and visitors' health and wellness at the center of a project's design. Features like bicycle storage, changing rooms, a high-energy performance envelope, and tall ceilings facilitating abundant natural light all contribute to the project's goal of meeting both certifications.

### Structural System

The new tower replaces a 35-story building built in the 1950s while retaining 25% of the existing structure as its base. The existing structure was partially demolished down to the 17th floor, and

opposite page: The 815-ft-tall, 42-floor tower is topped with three steel-framed fins that soar 160 ft above the roof level.

above: The tower's vertical white mullions are a modern reimaging of the original office building at the site.

- 8,000 structural tons
- 83,314 detailed pieces
- T.O. St. elevation: +729 ft 2½ in. (tower)
- T.O. St. elevation: +892 ft 6 in. (fins)
- 126,265 bolts
- Heaviest member: 39.8 tons
- 12 columns touch foundations
- 48 total anchor rods in the foundations
- A913-70 and A992 structural members
- A572-65 and A572-50 plate material

right: A 3D structural model of the steel framing system.

below: The temporary steel elements, some of which were incorporated into the tower's final framing system.

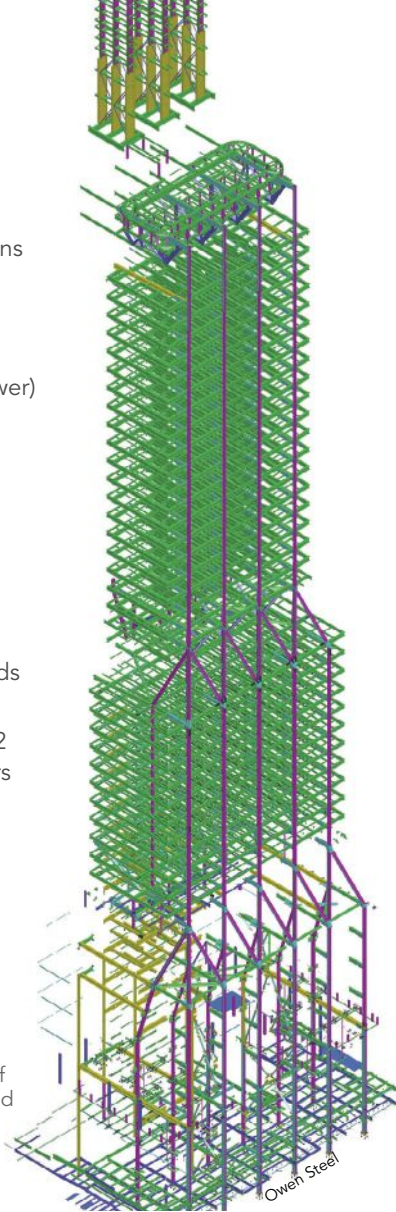

the remaining 17 floors of the existing construction temporarily stayed in place while the new building structure was erected around and inside of it. As a result, by the end of construction, the goal of preserving 25% of the original building was achieved, and this existing space was seamlessly integrated into the new building.

The structural system consists of complex structural steel framing connected to a concrete “spine” shear wall located at the back of the building. W14×873 to W14×283 members were used for the columns, and W14 to heavy W36 members were used for the beams. In addition, the framing also incorporated multiple 30-in.-deep steel plate girders with 4×24 flanges.

In order to achieve the large flexible floor plate and the column-free space in the high-rise portion, steel was the natural choice with its high strength-to-weight ratio and long-span capability. In addition, the construction sequencing required the use of members that could both act in compression during construction and then in tension once the temporary truss system was removed, as floors for the mid-rise portion (with a floor-to-floor height of 44 ft) hang from the truss system located between the 20th and 22nd floors.

Once steel was determined to be the best fit, the design team specified ASTM A913 Grade 70 steel—a first for a New York project—for the larger column elements to further take advantage of steel’s strength-to-weight benefits and to reduce the weight of the structure. This resulted in a roughly 30% savings on the steel package. In addition, the recycled content of the structural steel (the project incorporates approximately 8,000 tons in all) was a contributing factor in the goal of achieving LEED Gold certification.

The decision to locate the core at the rear of the building was a departure from the typical tall building practice of using a central core and a perimeter structure with columns at each corner. The core walls were erected first, and adjacent wings followed close behind. The existing structure was locally demolished down to the grade level to allow unimpeded access when it came to construction equipment and unobstructed placement of the core foundation mat. Temporary steel bracing was introduced to make up for the loss of the existing building’s core.

While the concrete core was being erected, the new building’s foundations were being installed. Temporary transfer structures were created where needed to allow excavation under the existing columns, and foundation work was followed by the erection of new steel columns that would support the office floor plates that were needed through the existing structure. Once those were secured in place, concrete framing of the seven-story base was poured over the existing structure at every other existing floor to form the new building’s gravity system while leveraging the existing structure to eliminate formwork and drastically reduce shoring.

Recessed central and high-rise blocks were framed with long-span steel and concrete composite girders. Each recess was achieved by incorporating a set of exterior sloping columns, all of which were placed at the outside of the office floor plate to maximize available tenant space while creating a prominent feature for the building thanks to the metal cladding wrapped around them. The cladding, including insulation, tolerances, and connections, had to fit into the architectural vision, requiring members and connections to be compact and shaped in a special manner. Solid steel nodes located at the transitions between regular and sloped columns were sculpted to match the shape of the sloping façade (the columns are sloped at 65° and the slope of the diagrid plane is 71°).

Given that the exterior columns are integrated with the cladding system, their footprint was kept to a minimum, again, by incorporating ASTM A913 Grade 70 steel. In addition, the team

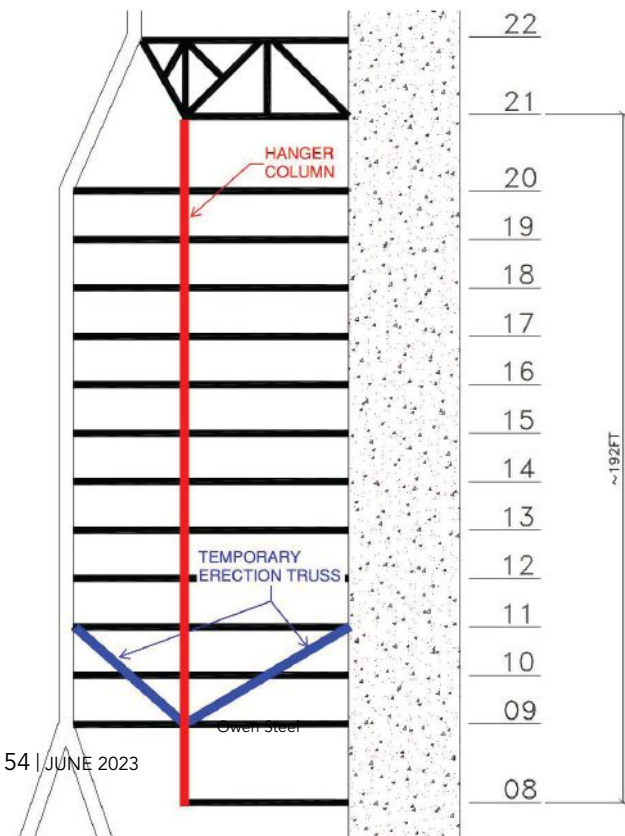





Solid steel nodes located at the transitions between regular and sloped columns were sculpted to match the shape of the sloping façade.

Owen Steel



Fabricating a node in Owen's shop.

Owen Steel



Erecting one of the building's sloped columns.

Michael Young

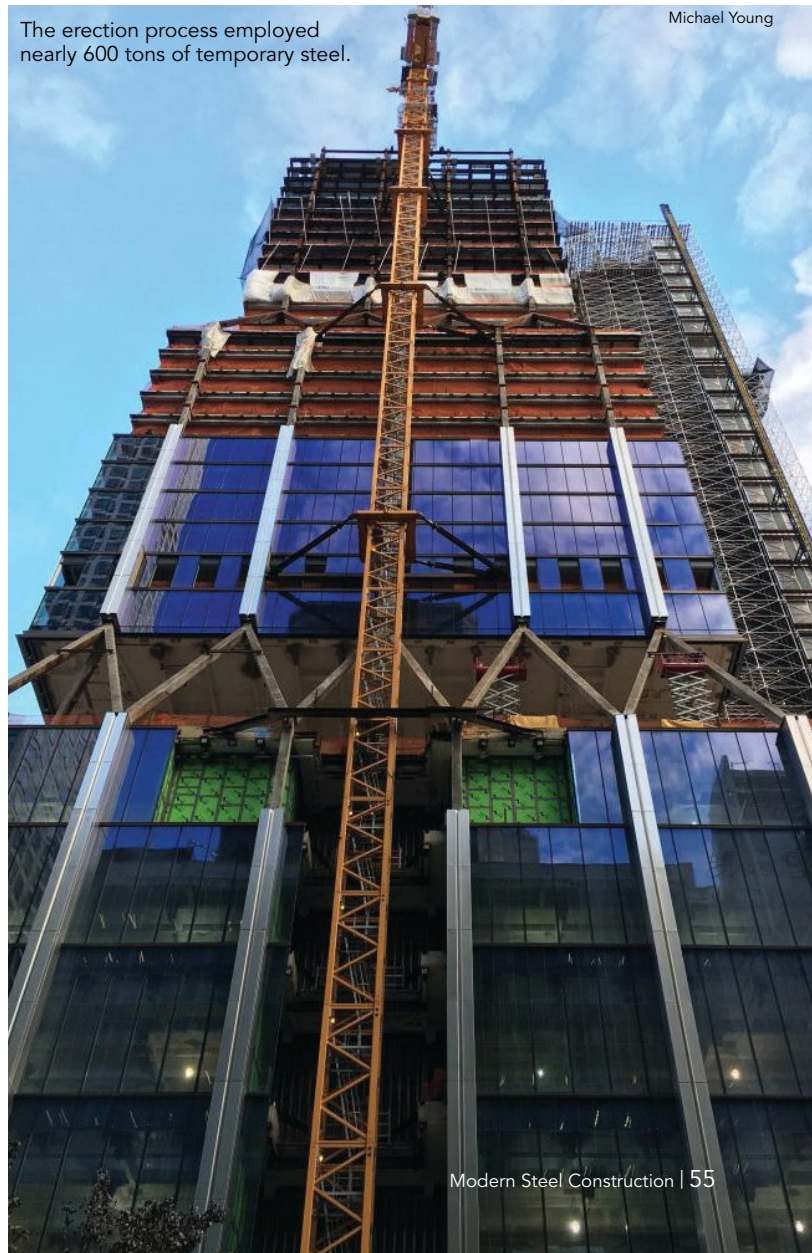

The erection process employed nearly 600 tons of temporary steel.

Michael Young

went with ASTM A572 Grade 65 plate to form large laminated shapes in the exterior columns and the laminated sculpted nodes in the lower tiers. The team turned to Tekla Structures modeling software to achieve a high level of coordination between the structural steel portion and all the other trades.

### Meeting the Vision

The building’s structural elements are primarily shaped around the architect’s vision of a 21st-century column-free office space with abundant natural light. All office floor plates are framed with long-span girders (up to 60 ft) and 16-ft cantilevers to maximize the column-free spaces available to tenants. In fact, all office floor space on the upper tier levels is completely column-free.

The two mechanical floors, located respectively above double- and triple-height amenity floors, are contained within bathtub-like structures and suspended from the building’s 22-ft-tall outrigger trusses—which support suspended mechanical spaces and ten office floors below as well as the 20 floors above them—to maximize the natural light available in those amenity spaces. All existing columns in the base of the original structure were cut back, resulting in existing floors being suspended from the new framing above, leaving only six interior columns within a space originally supported by 28 columns.

The successful design and installation of the welded steel plate nodes located at the transitions between regular and sloped columns were the result of a team effort between structural steel fabricator Owen Steel and structural engineer WSP. Mockups of the building nodes were developed to determine preheat requirements, and alternate acceptance criteria were developed ahead of erection to avoid the potential of unnecessary remediation of any weld defects.

The erection engineer also worked very closely with Owen Steel and WSP to evaluate the load requirements for the various stages of construction. Members that eventually became hangers supporting the floor system were initially used as compression members to temporarily support the floors during erection. Once the erection was complete up to the supporting truss, a progressive jacking system was used to establish a pre-set elevation for the floor framing so that when the temporary supports were removed and the stress in the member reversed from compression to tension, the floor framing would be at the correct elevation.

In addition, in order to install the large plate girders into the existing structure that was retained, steel “runways” with rolling trolleys and overhead rails with hoists were incorporated into the design of the new structure. This system allowed the new plate girders to be slid into the existing structure horizontally and moved laterally into their final installed positions. In all, 590 tons of temporary steel was required to install and stabilize the

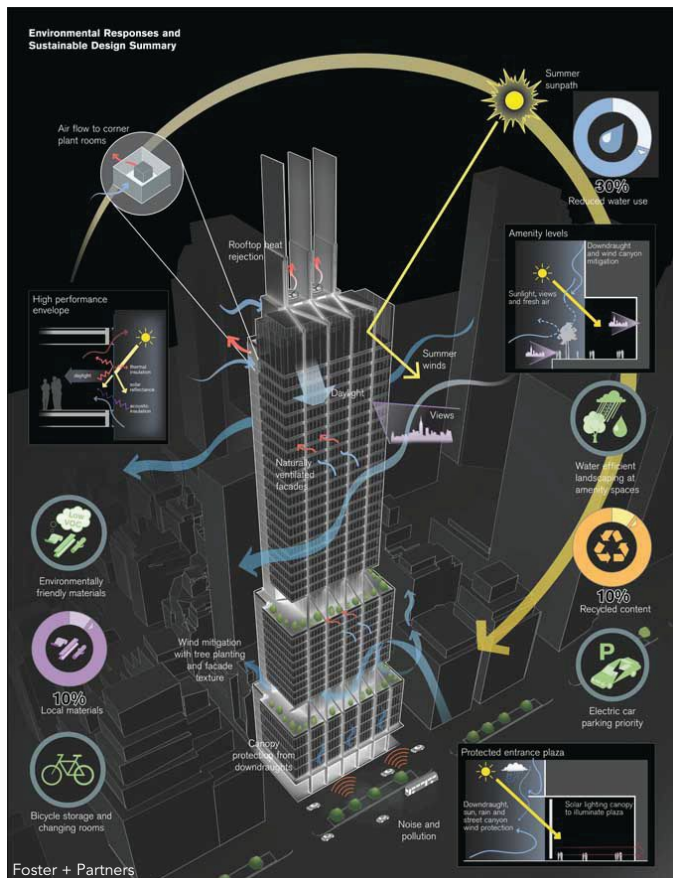

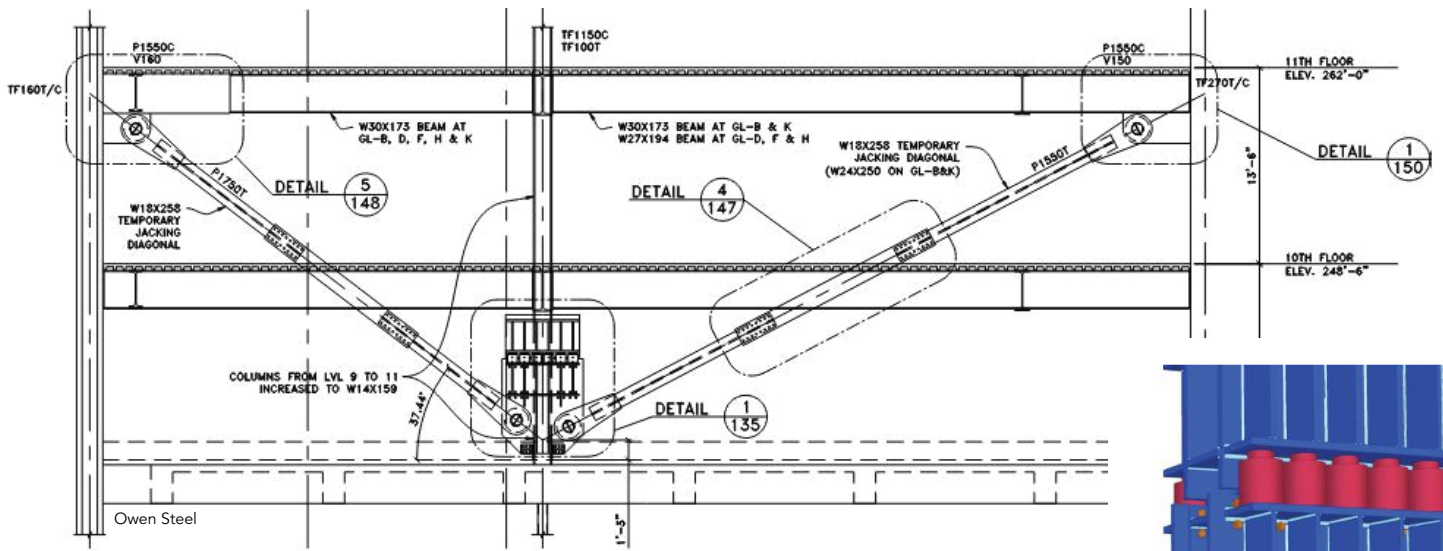

above and below: Temporary jacking for a truss.

right: A jacking node.

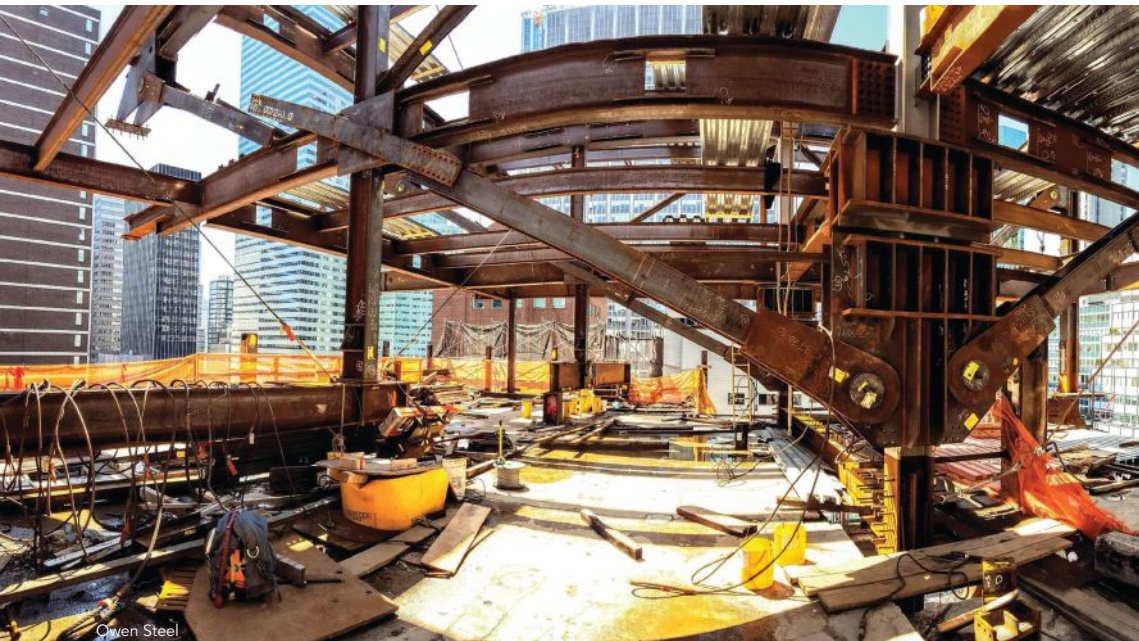
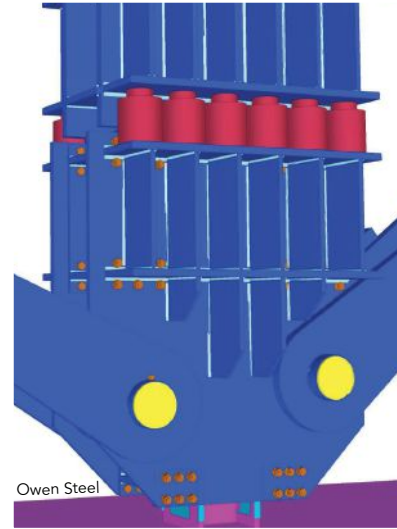

existing and new structures during erection. All of this temporary steel then had to be removed after erection was complete, with much of it being cut into small pieces and removed using the construction elevator.

Given the big aspirations for an iconic new tower, together with the mandate to meld the new structure with the existing old one, the design and construction team did an excellent job meeting its goals—thanks in part to the implementation of ASTM A913 Grade 70 steel. The 425 Park Ave tower is a superb example of design excellence achieved through focused, innovative structural design solutions and determined teamwork. ■

**Owner**

L&L Holding Company, LLC, New York

**General Contractor**

AECOM/Tishman, New York

**Architect**

Foster + Partners, New York

**Structural Engineer**

WSP, New York

**Erection Engineer**

Zieman Engineering, LLC, Stamford, Conn.

**Steel Team**

**Fabricator**

Owen Steel Company, Inc.  Columbia, S.C.

**Erector**

A.J. McNulty and Co., Inc.  Maspeth, N.Y.

**Detailer**

Steel Systems Engineering, Inc.  Sherman Oaks, Calif.



**Tim Bradshaw**

([tim.bradshaw@owensteel.com](mailto:tim.bradshaw@owensteel.com))

is vice president of project delivery with Owen Steel Company.

# Racing to Charlotte

BY GEOFF WEISENBERGER, MEGAN ERICKSON, AND KATE DUBY



**This year's NASCC: The Steel Conference was, once again, the biggest ever.**

**DID YOU KNOW** that in addition to being a mecca for NASCAR fans, Charlotte, N.C., is considered the pimento cheese capital of the world?

I didn't—at least not until I attended NASCC: The Steel Conference in Charlotte this past April.

This might not be the most important piece of knowledge that was gleaned by the 2,300 steel industry professionals that attended the conference's Wednesday keynote address—where Nucor's Tabitha Stine revealed this perhaps-not-so-little-known-secret—but it's the kind of tidbit that none of them are likely to forget.



Chris Jenkins

Nearly 6,000 attendees made the trip to Charlotte for the 2023 NASCC: The Steel Conference.

top photo: This year's AISC award winners at the conference's Wednesday keynote session.

## Seizing the Opportunity

Following Stine was keynote speaker Shailen Bhatt, the administrator of the Federal Highway Administration (FHWA), who shared plenty of his own knowledge and perspective that was perhaps more relevant to the steel industry, if not as tasty. One key point was that America must seize the opportunity presented by new infrastructure funding to build communities, boost the U.S. economy, and demonstrate America's strength in an increasingly fractious world.

As competition with China intensifies and Russia tests the limits of its power in Ukraine, it's crucial to continue the work President Eisenhower started with the Interstate Highway System, Bhatt noted.

“When we invest in the U.S., we are investing in our competitiveness in the world,” he said.

And that's more than just a philosophical matter for Bhatt. His office administers more than \$350 billion in Infrastructure Investment and Jobs Act (IIJA) funding, which he described as a once-in-a-lifetime chance to make a difference. That means more opportunities to revitalize American communities, too. FHWA estimates that every \$1 billion spent on infrastructure could create roughly 30,000 jobs.

“[Humans] have been building bridges for more than 6,000 years, but we have never had a better opportunity to make U.S. bridges the envy of the modern world,” he said. The Bipartisan Infrastructure Law could allow the country to not just tackle the maintenance backlog from years of insufficient funding but to build for the future with an eye toward safety, resilience, and sustainability. Bhatt challenged the Steel Conference audience to use infrastructure projects to tackle larger problems, like climate change and road fatalities.

"I'm not a fan of technology for technology's sake; I'm a fan of technology for an outcome," Bhatt said, emphasizing that conversations around advancements in automation and smart infrastructure should center on making roadways safer and reducing greenhouse gas emissions. In fact, FHWA is already working with the National Steel Bridge Alliance (NSBA) and Georgia Tech to explore new innovations, like whether it's practical to essentially 3D print steel bridge components.

## Half-Century in Steel

More expert knowledge was shared at the Steel Conference by a familiar face in the steel industry, Louis F. Geschwindner, PE, PhD, a professor emeritus in architectural engineering at Penn State University, retired AISC vice president, and senior consultant at Providence Engineering in State College, Pa. After all, you pick up a few things when you're immersed in structural steel design for half a century.

He shared the wisdom of that unique perspective in his Thursday session "Design Steel Your Way," whose goal was to provide engineers with something to think about as they use the information they already have—and what they learn—to design tomorrow's structures.

"All that we accomplish as structural engineers is, in some way, based on what those who came before us have accomplished," he said.

After tracing the history of engineers' understanding of bending, load and load combinations, and safety reliability, Geschwindner reviewed the differences between the 1986 AISC *Specification for Structural Steel Buildings* (ANSI/AISC 360, [aisc.org/specifications](https://www.aisc.org/specifications)), which introduced load and resistance factor design, and the 2005 unified *Specification*, which combined LRFD with the existing allowable stress design approach.

Geschwindner boiled his advice down to some simple points for engineers designing steel their way: Default to LRFD and use the direct analysis method for stability analysis (only use the effective length method for braced frames).

"As structural engineers, the most valuable thing we can bring to our clients is our ability to apply engineering judgment," he said. That judgment is based on previous generations' discoveries, and therefore a basic understanding of history is a vital tool for any structural engineer—a tool with which all attendees at his Thursday session are now equipped.



## Advocating for EDI

Equity, diversity, and inclusion are critical to ensuring vibrant architecture, engineering, and construction (AEC) communities today and tomorrow.

So naturally, EDI had a home at this year's NASCC: The Steel Conference in Charlotte, N.C., from the exhibit hall to the ever-popular Elevate reception.

At the latter, participants celebrated the rise of industry coalitions determined to improve representation in AEC workplaces. The Elevate reception highlighted the work of several EDI-minded organizations, including She Built This City, a Charlotte-based nonprofit that recruits youth, women, and members of marginalized communities into skilled trade professions, connected with other honorees and guests at Elevate. Prior to the reception, conference participants had the opportunity to hear from She Built This City at their session on stocking the skilled trades pipeline through intentional community engagement and skills education.

Bringing more women into fields like construction and manufacturing begins with encouraging young girls to explore creative spaces they may not have been previously exposed to, said the organization's executive director LaToya Faustin.

"Our work focuses on building a skilled-trades pipeline," Faustin said. "It's about changing the narrative—bringing all new exposure and new opportunities to the communities we serve."

In her welcoming remarks, AISC director of workforce development Jennie Traut-Todaro shared how Elevate has evolved to be more inclusive since its 2016 inception, and she announced that the NASCC Planning Committee will establish a new subcommittee devoted to increasing the number of sessions focused on equity, diversity, inclusion, and accessibility across AEC starting at next year's Steel Conference.

"AISC is always looking for new ideas from our members, our event attendees, and our allies," Traut-Todaro said. "We all have our own conscious and unconscious biases and can miss opportunities to do better."

Becky Dolan, international membership chair for AWWMI, said she loved seeing everyone at Elevate come together for a shared purpose.

"We're all in the same storm, even if we're in different boats," Dolan said.

Several of the featured groups, including the Black Contractors Association for the Carolinas, the Association of Women in Metal Industries (AWMI), and Ironworker Management Progressive Action Cooperative Trust (IMPACT), also exhibited booths at the trade show.

At the AWWMI booth, Dolan engaged visitors in the organization's history, mission, and progress while sharing how to get involved. Since its founding 42 years ago, AWWMI has worked to empower women in metal industries by fostering relationships, career growth, educational outreach, and shared knowledge.

"Women needed a support team and there wasn't one, so they said, 'Well, we're going to create our own,'" Dolan shared of AWWMI's founders.

Sharing spaces with successful women who also encourage the success of their peers has been a pillar in Cast Connex Vice President Jennifer Anna Pazdon's career development. Pazdon is a member of PWC, a New York-based national association, in addition to several of the other honored organizations.

"Before I joined, I had never really had female role models in leadership positions," Pazdon said. "Then suddenly I was in the room with presidents, vice presidents, and CEOs—I finally had role models I saw myself reflected in."



## Be Pro Be Proud

With hundreds of thousands of industry jobs remaining unfilled across the U.S. and more than 23% of current skilled professionals at or near retirement age, there is a massive opportunity for young workers to embark on careers in the skilled professions.

At the forefront of the mission to introduce a new generation to America's skilled workforce is Be Pro Be Proud, an initiative to bring the public's perception of technical careers into the 21st century. Participants at NASCC: The Steel Conference in Charlotte had the opportunity to interact with Be Pro Be Proud at its hands-on mobile workshop, housed in a 78-ft, custom-built trailer. Inside, a variety of virtual-reality simulators offer visitors the unique chance to drive a tractor, practice welding, guide an excavator, and much more.

"When we first bring our workshop to people, especially students, they often view it as a fun distraction from academics or work," said Andrew Parker, the executive director of Be Pro Be Proud. "Later, the experiences they had stuck with them and became a reason to achieve more meaningful training and education."

The Be Pro Be Proud initiative targets many audiences, including high school and nontraditional students, current skilled professionals, legislators, parents, teachers, career coaches, and employers. First established in Arkansas in 2016 and later in North Carolina in 2022, the initiative aims to dispel myths that deter people from entering skilled professions.

"For a long time, we've been seeing people label themselves as somewhat of a failure if they don't attend a four-year college or complete their four-year college degree when often they weren't a good match for it in the first place," said Wade Butner, director of external affairs for SPEVCO Special Vehicles Company, which builds Be Pro Be Proud's trailers. "We're changing that perception and encouraging people to make these careers their top choice."

Part of overcoming such myths involves showcasing the vocational pride held by skilled professionals and highlighting the many training and career opportunities available across several fields, including the construction, manufacturing, transportation, and utility industries.

"One of the biggest myths surrounds the financial opportunities gained from entering into the skilled professions. People are surprised at how easy it becomes to earn a six-figure income just five years out of high school," Butner said. "The people we reach are the future owners of companies and will manage 30 to 40 employees themselves later in their careers."

Since North Carolina's Be Pro Be Proud team introduced its two units in October 2022, it has reached more than 20,000 students—and there are more than 300 entries on a waitlist of requests for a trailer visit. With that demand, leaders anticipate that the student tally will top 75,000 by the end of 2023. Given its popularity, it's clear that Be Pro Be Proud is striking a chord with both its young and experienced workshop participants.

"Everywhere we go, adults tell us they wish they had this program when they were young," Parker said. "All of us see ourselves in the audience this reaches."

In the coming years, Be Pro Be Proud has its eyes set on expanding its presence beyond the states it currently serves (Arkansas, North Carolina, South Carolina, Georgia, Tennessee, and New Mexico) and into the rest of the country. Also, its leaders are especially interested in engaging parents, who have been historically challenging to reach, to show them all the benefits of encouraging their children to learn a skilled profession.

Visit Be Pro Be Proud's website at [www.beprobeproud.org](http://www.beprobeproud.org) to find out more about the initiative and how you can get involved.

## It All Adds Up

As enlightening as the keynote sessions were, they were really just the tip of the iceberg at the conference. At the end of the day, it's all about connections. You can watch sessions online. You can visit an exhibitor's website. But there are plenty of encounters that just don't happen organically in the virtual world, as the nearly 6,000 attendees discovered in Charlotte.

"While working the reg desk, I registered a few high school- and college-aged kids so that they could see what their parents do for work and what the industry is like," recalled Emmett Garber, AISC's application support specialist. "But I also had the pleasure of registering an exhibitor's 78-year-old dad so he could see what his son does for work. Kind of like a 'take your dad to work day.'"

While the Steel Conference is largely known to be geared towards structural engineers and others in the steel industry, one architect in attendance pushed for others in his profession to consider it in the future.

"NASCC provides the opportunity for architects to gain a more holistic understanding of the steel industry, including the technical design and delivery process from early sketches through construction," said Craig Davenport, president of architecture firm MZA. "Through AIA-accredited sessions, architects, structural engineers, contractors, steel suppliers, and fabricators are able to share experiences to achieve quality solutions. This is real-world information that can be applied to any project, big or small."

One group that was well represented at the show was college students. Many were there to attend the conference's Students Connecting with Industry Sessions (SCIS). One of these was the two-part Career Insights session, where students had the opportunity to hear career insights from distinguished design professionals and gain unique perspectives on the professional world they will soon enter. In the Direct Connect session, students got the opportunity to connect and interact with leading industry experts from design and construction companies around North America in a relaxed setting. While not all firms at the event were hiring, it was a great chance to meet significant designers and make key contacts at major firms.

"Meeting professionals at SCIS was a game-changer for me," noted Tristan Yount, a University of Kansas student who will be starting a career with Exponent, one of the participating Direct Connect companies.

One hot topic at the conference this year was workforce development, and there were

multiple sessions geared toward recruiting, training, and retaining employees.

At the “Forging Employee Loyalty: Recruiting and Retention” session, a key takeaway was that company culture is more important than ever when it comes to keeping employees engaged and productive.

“Culture eats strategy for breakfast,” noted speaker Peter Drucker

Another session, “A Holistic Approach to Developing a Training Program to Teach the Craft of Layout and Fitting,” was more focused on hands-on work, but speaker Adam MacDonald of McCombs Steel’s message was universal.

“We need to put someone in charge of developing people because it’s not going to happen on its own,” he noted.

### More on the Floor

And, of course, there was the exhibit hall, where more than 300 companies displayed their products and services—a new record for the Steel Conference. In addition to a noticeably large number of robotic equipment—displayed by companies such as Peddinghaus, Vectis Automation, AGT Robotics, Lincoln Electric, Prodevco, Agen, Voortman, and others—there were plenty of other highlights.

At Nucor’s booth, attendees found an interactive rendering of the circular economy of steel. As they picked up different models and placed them on a receiver, a screen walked them through each process of the steel life cycle, illustrating the material’s nearly infinite recyclability.

“We want people to see that the car they’re driving today can be melted down and could end up as part of a building ten years from now,” explained Nucor sustainability specialist Luke Johnson.

Attendees were able to buckle up and enjoy the ride at Lincoln Electric’s motorsports-themed booth. In addition to demos of their large robotic fabrication systems, the team at Lincoln Electric brought iRacing simulators and hosted a NASCAR driver meet-and-greet.

“We had a lot of interactive things people could learn from,” said Lincoln Electric senior product manager Sheena Suvak. “It’s one thing to walk by a booth and talk to people—it’s another to be able to get your hands on what they’re exhibiting.”

You’ve likely heard of—or perhaps even experienced—an ultrasound scan of your body, but the Terracon booth demonstrated how it’s possible (and even advantageous) to use

ultrasonic testing to inspect a weld. The company demonstrated its OmniScan x3 at work. When it’s run along the length of a weld, this device sends ultrasonic radiation into it and creates a digital report of the weld’s quality, making it easy to spot any flaws that may not be obvious with common weld testing methods.

“Because it sends waves into your weld from multiple angles, phased array ultrasonic testing can save you significant amounts of time and give you a better weld inspection overall,” said Terracon senior construction inspector Michael Bobinchuck.

To read about more cool items from the exhibit hall, keep an eye out for the Hot Products section in the July issue. And if you weren’t able to make it to Charlotte or missed a session you wanted to attend, you can view recordings of any session at [learning.aisc.org](http://learning.aisc.org) starting around mid-June. Also, check out the Product Extras section at [www.modernsteel.com](http://www.modernsteel.com) to see photos from the show!

Next year’s show heads to the Lone Star State, taking place in San Antonio, March 20–22. Bring your hat, boots, and an appetite for BBQ and Tex-Mex (I’m sure you can find some pimento cheese as well). Yee-haw! ■



**Geoff Weisenberger** is chief editor of *Modern Steel Construction*, **Megan Erickson** is AISC’s digital communications specialist, and **Kate Duby** is AISC’s communications content specialist.

**STL**

**ST. LOUIS**  
SCREW AND BOLT

*Connecting amazing structures Nationwide!*

Call or email us your inquiry!  
**St. Louis Screw & Bolt**  
[sales@stlouisscrewbolt.com](mailto:sales@stlouisscrewbolt.com)  
**800-237-7059**

PROUDLY MADE IN THE USA

## new products

This month's New Products section focuses on welding, featuring a pair of portable welding solutions and production monitoring technology that gives users the data they need to facilitate and achieve maximum equipment efficiency from anywhere in the world.



### Vectis Rover

Vectis' new Rover deployment method offers a rugged and flexible means of bringing the industry-proven Vectis Cobot Welding Tool to large workpieces. Built on a heavy-duty all-terrain cart, the Rover is designed with portability in mind for fabrication shops. The cobot's compact skid can be undocked from the full cart via forklift or crane and placed onto large parts to perform long weld joints. This deployment option is available to be integrated with a wide array of leading power sources, torch options, and Vectis' existing welding feature toolbox, which includes ArcPilot through-the-arc seam tracking, touch sensing, and multi-pass offset welding. The Rover seeks to unlock new automation possibilities for fabricators. Think of it as a "mag drill for welding," where an operator can bring a tool to a workpiece and have the tool perform time-consuming, dexterous tasks for hours on end. For more information, visit [www.vectisautomation.com](http://www.vectisautomation.com).

### Lincoln Electric Checkpoint

The introduction of the Internet of Things (IoT) among welding operations has been a key driving force to help verify existing welding parameters and improve production. Measuring weld parameters supports compliance when fabrication requires strict code compliance. The application of Lincoln Electric's Checkpoint Production Monitoring Technology changes the way you look at your welding operations. More than just a means of data collection, Checkpoint is a full-production monitoring solution that delivers the precise information you need for maximizing welding productivity and performance. This secure, cloud-based solution allows you to collect data to measure variables—such as operator arc on time, overall equipment effectiveness (OEE) metrics, material consumption, and weld/assembly information—from anywhere in the world, on any device. For more information, visit [www.lincolnelectric.com](http://www.lincolnelectric.com).

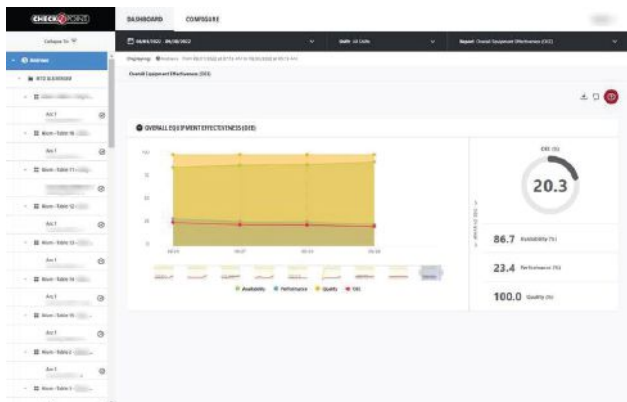

### Kobelco ARCMAN PORTABLE (KI-110)

Kobelco will release its ARCMAN series PORTABLE (KI-110), a fully automated portable CJP (complete joint penetration) robot, in the coming months. The compact unit weighs approximately 19 lb and requires no installation. You can take it anywhere the job calls for, not only in shops but also on sites. Its advanced technology makes it easy to produce any weld. It automatically generates optimal welding conditions, including pass sequence based on groove shape data, measured by touch sensing. Furthermore, it can accommodate a range of plate thicknesses up to 3.93 in., various welding positions (flat, horizontal, and vertical), and various grooves. It can also weld longer lengths by extending the rails. All you have to do is press a button to start welding, allowing one person to operate multiple units. For more information, visit [www.kobelcowelding.com](http://www.kobelcowelding.com).



## FORGE PRIZE EV Charging Infrastructure Concept Wins 2023 AISC Forge Prize

A concept that would use structural steel to reinvent the gas station experience for the EV age has won AISC's 2023 Forge Prize.

LVL (Level) Studio collaborators Jeffrey Lee, Christopher Taurasi, and Lexi White won the \$10,000 grand prize and worked with Schuff Steel (an AISC member) senior vice president Christian Crosby to refine their Electric Oasis vision and make the process of bringing it to life in steel more efficient.

The time it takes to recharge is, the team noted, one of the primary differences between a gas and electric vehicle.

"On average, a gas stop takes around seven minutes to refill a tank," Lee said. "A level-two charging station, which is the most common type, takes upwards of four and a half hours for a full charge. We have an opportunity to reimagine the gas station

typology into something that can revitalize the local economy."

So what to do with that time? In their vision, motorists would relax, work, play, shop, or perhaps even get healthcare while their vehicles charge—all activities that offer new economic opportunities for small communities around highway interchanges.

These charging stations are defined by striking steel canopies that offer shade. In their primary use case, for a site within the average EV range of both Los Angeles and San Francisco, a pathway winds through the canopies, offering vistas and an engaging space in a loop that takes about 15 minutes to explore.

LVL (Level) Studio was one of three finalists in the competition. All three finalists will be featured in the August issue. For more on the Forge Prize, visit [forgeprize.com](http://forgeprize.com).



## MEMBERSHIP AISC Board Announces New Members

The AISC Board of Directors has approved the following companies for AISC membership.



Full

Carolina Fabricators, Inc.,  
West Columbia, S.C.  
Davis Iron Works, Hewitt, Texas  
New Industries, LLC, Morgan City, La.  
Precision Metals Northwest, LLC,  
Salem, Ore.  
Ranburne Steel Fabrication, Inc.,  
Ranburne, Ala.  
Tashjian Towers Corporation,  
Fowler, Calif.  
Valmont Industries, Inc., Omaha, Neb.



Associate

3D Engineering Global, LLC, Houston,  
*Detailer*  
D05 Design and Engineering, LLC,  
Daniel Island, S.C., *Detailer*  
Procadus, LLC, Cedar Rapids, Iowa,  
*Detailer*  
Sockeye Steel Detailing, Sioux Falls, S.D.,  
*Detailer*  
Southern Fabricating Machinery Sales dba  
BendmakUSA, Lithia, Fla.,  
*New Equipment Dealer*  
Tower Inspection, Inc., Muskogee, Okla.  
*Detailer*

## People & Companies

Arkansas-based **Lexicon, Inc.**, an AISC member, announced its promotion of **Ryan Walmsley** as president of the company's Fabrication Group. A member of the Lexicon team since 2019, Walmsley has nearly 20 years of experience in the steel industry. Working out of the company's headquarters in Little Rock, Ryan will lead the Fabrication Group, which includes **Custom Metals, Prospect Steel, and Steel Fabricators of Monroe**. In this role, he will lead the fabrication and erection teams on commercial and industrial projects from conception to completion.



**Magnusson Klemencic Associates (MKA)** announced the recent promotion of nine employees to BIM director, senior associate, and associate positions. BIM Director: **Kevin Carroll, AIA**. Senior associates: **Jennifer Diggs, SE, PE, Jeremy Hasselbauer, SE, PE, Amy Kuo, SE, PE, Alex Lang, SE, PE, and Brad Strandquist, SE, PE**. Associates: **Patrick Burns, SE, PE, Mandy Chen, SE, PE, and Kevin Kuntz, SE, PE**.

Integrated design firm **SmithGroup** has opened its newest office in Cleveland. As the company's 20th office, this new location builds upon a strong legacy of work that the firm has led in Cleveland and its surroundings and strengthens the company's network of expertise in the Great Lakes region, which includes operations in Ann Arbor, Mich., Chicago, Detroit, Madison, Wis., Milwaukee, and Pittsburgh. It also deepens SmithGroup's long-standing connections in Ohio, where it has successfully delivered impactful architecture, landscape architecture, urban planning, coastal engineering, and waterfront projects for several decades.

## EDUCATION

### Cristopher Montalvo Receives Inaugural Reidar Bjorhovde Outstanding Young Professional Award

The AISC Education Foundation has given Cristopher Montalvo the first-ever Reidar Bjorhovde Outstanding Young Professional Award.

Montalvo is a structural engineer for Dekker Perich Sabatini (DPS)—and he’s already well on his way to forging connections to industry and education for his local community in New Mexico!

“Cristopher is just the type of remarkable leader the AISC Education Foundation aims to support through its programs,” said AISC director of foundation programs Maria Mnookin. “We are thrilled to have the opportunity to connect Cristopher to our activities, resources, and networks for future career development and mentorship opportunities.”

The AISC Education Foundation has provided him with a big boost with the Bjorhovde Award. He attended NASCC: The Steel Conference in Charlotte, N.C., in April and will enjoy steel mill and fabrication shop tours over the summer before joining the AISC Committee on Specifications meeting in Chicago in the fall.

“So many of the buildings in New Mexico are steel structures, so this is an excellent opportunity to broaden my knowledge of steel and connect with leaders of the steel industry,” Montalvo said. “I want to thank AISC for the honor of being selected as the inaugural recipient of the Reidar Bjorhovde Outstanding Young Professional Award. I am thoroughly excited to join the AISC Committee on Specifications meeting in Chicago in the fall!”

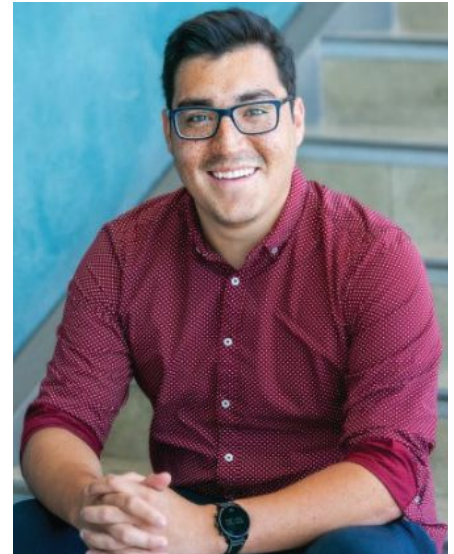

## BRIDGES

### Decade of Research Provides Valuable Insights into Uncoated Weathering Steel Bridge Performance

Bridge experts have long known the benefits of uncoated weathering steel (UWS)—and thanks to research by the University of Delaware’s Jennifer McConnell, PhD, those advantages can now be quantified.

McConnell, the recipient of this year’s T.R. Higgins Lectureship Award, closed out this year’s NASCC: The Steel Conference in Charlotte by presenting findings from more than a decade of research on weathering steel bridges. In 2016, the National Association of Corrosion Engineers (now called the Association for Materials Protection and Performance) estimated that the worldwide economic impact of corrosion across all sectors is \$2.5 trillion annually.

McConnell’s research focuses on weathering steel, an alloy that was first introduced in 1964 and has been used in more than 10,000 bridges. What makes it unique is that it’s intended to be used uncoated to allow its distinctive protective finish to develop. The lack of applied coatings provides cost savings both initially and throughout a structure’s service life as well as environmental benefits. However, it may not be an ideal choice for all environments, and she noted that controlling exposure is the best thing engineers can do to ensure

that a structure reaches its target lifespan.

Humidity is a crucial consideration because the chemical reactions that lead to corrosion can’t start without water. Chlorine—commonly found in the air above salt water and in deicing agents applied to roadways—acts as a catalyst to speed up the process. Water and chlorides often coexist, which creates the most corrosive environment that a typical steel structure can experience, prompting McConnell to examine the impact of humidity and chlorides on UWS bridges over time.

McConnell’s team evaluated UWS bridges that had been in service for at least 20 years (in most cases) and up to 40 years in others in two general environments: coastal conditions and those subjected to deicing. Some bridges in the study were subjected to both.

Her findings suggest that UWS is an ideal choice for environments that are neither extremely humid nor high in chlorides. As either of those environmental elements increase, thoughtful planning could be the key to success. For instance, designers could consider including a sacrificial thickness of steel—i.e., use thicker steel for things like bottom flange plates

(where water and salt tend to collect) to mitigate the effects of highly corrosive environments. Under those conditions, UWS may lose 1/8 in. of thickness after 80 years; simply adding an additional 1/8 in. to the bottom flange plates over heavily salted traffic lanes, for example, would counteract that and allow owners to take advantage of UWS’s cost and sustainability benefits.

Her team reviewed 70 inspection reports from four different agencies and found a striking pattern: A third of the bridges they examined had worse performance below deck joints than in the remainder of the structure. These joints were leaking—a frequent cause of compromised corrosion resistance. Ideally, UWS bridges should have as few joints as possible, and careful detailing can make a big difference, too.

Designers should also consider drainage and the potential for joint leakage. McConnell pointed out that engineers could handle drainage by simply placing expansion joints behind the back wall with a drainpipe to discharge runoff away from the superstructure.

To read more about the Steel Conference, including its other keynote sessions, check out “Racing to Charlotte” on page 58.



**SMITH-EMERY**

Inspection • Testing • Metallurgy

Assuring Structure & Life Safety Since 1904

**Non-Destructive Testing**

- PAUT
- Visual (CWI, CWB, CSWIP)
- MT
- UT

**Owner QA**

- Fabrication Oversight
- Specification Review
- Field Inspections
- WPS Reviews

**Metallurgical Laboratory  
Environmental Laboratory  
Firestop Inspection**

**Supplier Audits**

- IAS
- IAPMO
- City of Los Angeles
- Clark County, NV

**Contractor QC**

- Fabrication Shop NDT, CWI
- Vendor Audits
- QMS Development
- WPS and PQR Testing

**Curtain Wall Performance Testing  
Concrete Testing  
Chemical Laboratory**

1.833.405.0536  
steel@smithemery.com  
www.smithemery.com



**Structural Engineers**

Are you looking for a new and exciting opportunity?

We are a niche recruiter that specializes in matching great structural engineers with unique opportunities that will help you utilize your talents and achieve your goals.

- We are structural engineers by background and enjoy helping other structural engineers find their "Dream Jobs."
- We have over 30 years of experience working with structural engineers.
- We will save you time in your job search and provide additional information and help during the process of finding a new job.
- For Current Openings: visit our website, select Hot Jobs.
- Please call or email Brian Quinn, PE: 616.546.9420  
**Brian.Quinn@FindYourEngineer.com**  
so we can learn more about your goals and interests.  
*All inquiries are kept confidential.*

SE Impact by SE Solutions, LLC | [www.FindYourEngineer.com](http://www.FindYourEngineer.com)

Connect with AISC on  
**SOCIAL MEDIA**

[aisc.org/linkedin](http://aisc.org/linkedin) @AISC  
 AISCdotORG @AISC  
 [youtube.com/AISCSteelTV](http://youtube.com/AISCSteelTV)

**LATE MODEL STRUCTURAL STEEL MACHINES AVAILABLE IMMEDIATELY**

- Peddinghaus Ocean Avenger Plus 1250/1C**, 48" Maximum Profile, 40' Table, 8-ATC, 3000 RPM, Siemens 840D, 2019, #32543
- Peddinghaus AFCPS 623K Anglemaster**, 6" x 6" x 1/2", 250 Ton Shear, New Control, Motors & Drives 2014, Conveyors, Tooling, #32573
- Peddinghaus Peddiwriter PW-1250**, (2) Hypertherm ArcWriter Plasma Torches, 4-Side Marking, Siemens CNC, 2013, #32397
- Peddinghaus ABCM-1250/3B** Beam Coping Line, 50" x 24" Maximum Profile, Fagor 8055, Retrofit 2010, #31655
- Peddinghaus Peddiwriter PW-1250**, (2) Hypertherm ArcWriter Torches, Meba 1250-510 Saw, Conveyor & Transfers, 2015, #32576
- Peddinghaus ABCM-1250** Profile Coping Machine, 50" Max Beam, (3) Oxy Heads Siemens CNC, Conveyor, 2007, #32574
- PythonX** Robotic Plasma System, 3-Side Processing, HPR260XD, 60' In-Feed & 40' Out-Feed Conveyor, 2014, #32507
- Controlled Automation DRL-348TC** Drill Line 3-Spindle with ATC, Hem WF140HM-DC Saw, Conveyor & Transfers, 2009, #32361



**WE ARE ACTIVELY LOOKING FOR USED STRUCTURAL STEEL EQUIPMENT**  
CONTACT: [Claire@PrestigeEquipment.com](mailto:Claire@PrestigeEquipment.com)

[www.PrestigeEquipment.com](http://www.PrestigeEquipment.com) | (631) 249-5566

To advertise, contact M.J. Mrvica Associates, Inc.: 856.768.9360 | [mjmrvica@mrvica.com](mailto:mjmrvica@mrvica.com). Search employment ads online at [www.modernsteel.com](http://www.modernsteel.com).

advertiser index

AGT	27	Nucor	back cover
Applied Bolting	21	Nucor Vulcraft	3
Automated Layout Technology	42	Peddinghaus	2
Cast Connex	49	QuickFrames USA	14
Chicago Metal Rolled Products	insert	SDS2	7
Controlled Automation	12	St. Louis Screw & Bolt	61
IDEA Statica	19	Structural Steel Manufacturing	21
Integrated Engineering Software	13	Strut & Supply	43
MDX	27	Voortman	17
New Millenium Building Systems	15	Zekelman/Atlas Tube	5



Bob Shaw

## Wild, Wild Life

**A NEW BRIDGE** at the San Diego National Wildlife Refuge will allow users to access trails on both sides of Sweetwater River and also provide better access for park service vehicles.

OK, full disclosure, this isn't a real bridge project (though it's not a bad idea). Rather, it's the chosen conceptual design scenario for this year's AISC/ASCE Student Steel Bridge Competition. Throughout the spring, hundreds of college and university student bridge teams competed

in 20 regional events across the country for a chance to represent their school in the national finals, taking place at the University of California San Diego, June 2–3.

One of these events, for the Southeast region (pictured here), took place at the University of North Florida in Jacksonville. Teams from 11 schools worked through the competition's multiple categories—aesthetics, construction speed, stiffness, lightness, economy, cost estimation, and efficiency, with the overall rankings

being based on the combination of these individual categories and expressed as cost—and the University of Florida, Kennesaw State University, and University of Puerto Rico–Mayagüez teams advanced to the national finals.

To learn more about the competition, including all participating teams, this year's rules, regional results, and more, visit [aisc.org/ssbc](https://aisc.org/ssbc). And check out the August issue for full coverage of this year's national finals. ■



2023 IDEAS<sup>2</sup> National Award  
**Federal Reserve Building** Seattle  
Photo: Clarity Northwest Photography

# CALLING ALL INNOVATORS!

If you recently worked on an amazing project that featured structural steel, we want to hear from you. Submit it for a 2024 IDEAS<sup>2</sup> award!

Visit [aisc.org/ideas2](https://aisc.org/ideas2)



2024  
**IDEAS<sup>2</sup>**  
**AWARDS**

Innovative Design in Engineering and  
Architecture with Structural Steel



# AEOS™

ASTM A913

## SUSTAINABLE HIGH-STRENGTH STRUCTURAL STEEL IDEAL FOR FABRICATORS AND ENGINEERS

When you have a design that features weight challenges or faces a tight schedule, consider the value that Aeos™ can deliver for you and the project.

### HIGH-STRENGTH EFFICIENCY

Aeos' high strength-to-weight ratio means reduced tonnage and easier material handling at the fabrication shop and job site, reducing time, weight, and cost. Aeos is available in 50, 65, and 70 ksi.

### WELD PREHEAT SAVINGS

Aeos provides substantially reduced preheat requirements, resulting in significant savings in fabrication, field welded connections, and labor and energy costs, compared to ASTM A992.

### DOMESTIC & SUSTAINABLE

Aeos is the only domestically produced ASTM A913 structural steel made with more than 90% recycled content, helping the project team meet sustainability goals.



VIEW

THE AEOS WELDING AND  
FABRICATION GUIDELINES

[nucor.com/aeos-welding](https://nucor.com/aeos-welding)

**NUCOR®**